

MARKS PUBLISHED FOR OPPOSITION

The following marks are published in compliance with section 12(a) of the Trademark Act of 1946. Applications for the registration of marks in more than one class have been filed as provided in section 30 of said act as amended by Public Law 772, 87th Congress, approved Oct. 9, 1962, 76 Stat. 769. Opposition under section 13 may be filed within thirty days of the date of this publication. See rules 2.101 to 2.105.

A separate fee of two hundred dollars for opposing each mark in each class must accompany the opposition.

SECTION 1.— INTERNATIONAL CLASSIFICATION

The short titles associated below with the international class numbers are terms designed merely for quick identification and are not an official part of the international classification. The full names of international classes are given in section 6.1 of the trademark rules of practice.

The designation "U.S. Cl." appearing in this section refers to the U.S. class in effect prior to Sep. 1, 1973 rather than the international class which applies to applications filed on or after that date. For adoption of international classification see notice in the OFFICIAL GAZETTE of Jun. 26, 1973 (911 O.G. TM 210).

Application in more than one class

SN 75-629,658. BOTTEGA VENETA INTERNATIONAL S.A.R.L., LUXEMBOURG, LUXEMBOURG, FILED 1-28-1999.

BOTTEGA VENETA

OWNER OF U.S. REG. NO. 1,086,395.
NO CLAIM IS MADE TO THE EXCLUSIVE RIGHT TO USE "BOTTEGA", APART FROM THE MARK AS SHOWN. THE ENGLISH TRANSLATION OF "BOTTEGA VENETA" IS "VENETIAN SHOP".
SEC. 2(F).

CLASS 9—ELECTRICAL AND SCIENTIFIC APPARATUS

FOR SUNGLASSES (U.S. CLS. 21, 23, 26, 36 AND 38).
FIRST USE 0-0-1995; IN COMMERCE 0-0-1995.

CLASS 14—JEWELRY

FOR JEWELRY (U.S. CLS. 2, 27, 28 AND 50).
FIRST USE 0-0-1994; IN COMMERCE 0-0-1994.
KATHERINE STOIDES, EXAMINING ATTORNEY

SN 75-809,786. PAUL WURTH S.A., GRAND DUCHY, LUXEMBOURG, FILED 9-28-1999.

PRIMUS

OWNER OF BENELUX REG. NO. 650652, DATED 3-19-1999, EXPIRES 3-19-2009.

CLASS 7—MACHINERY

FOR CRANES AND SPECIAL PURPOSE TRAVELING CRANES FOR STEELWORKS; HYDRAULIC VALVES (U.S. CLS. 13, 19, 21, 23, 31, 34 AND 35).

CLASS 9—ELECTRICAL AND SCIENTIFIC APPARATUS

FOR CONTROL CIRCUITS FOR HYDRAULIC VALVES. (U.S. CLS. 21, 23, 26, 36 AND 38).

CLASS 11—ENVIRONMENTAL CONTROL APPARATUS

FOR ELECTRIC STEEL PLANTS FOR INDUSTRIAL USERS IN THE STEEL INDUSTRY; MULTIPLE HEARTH FURNACES; ELECTRIC FURNACES, NAMELY ELECTRIC ARC FURNACES; COOLING SYSTEMS FOR MULTIPLE HEARTH FURNACES; HEAT RECOVERY APPARATUS FOR USE BY INDUSTRIAL USERS IN THE IRON AND STEEL INDUSTRIES; AND, INCINERATORS AND DUST-EXTRACTORS FOR THE TREATMENT OF EXHAUST GAS FOR USE IN THE IRON AND STEEL INDUSTRIES. (U.S. CLS. 13, 21, 23, 31 AND 34).

CLASS 40—MATERIAL TREATMENT

FOR TREATMENT OF INDUSTRIAL WASTE, SUCH AS SLUDGE AND DUST, WHICH CONTAIN METAL IN ANY FORM, INCLUDING METAL OXIDES, METAL HYDROXIDES AND METAL SALTS (U.S. CLS. 100, 103 AND 106).

CLASS 42—SCIENTIFIC, COMPUTER AND LEGAL SERVICES

FOR CONSULTATION SERVICES IN THE FIELD OF ENGINEERING IN CONNECTION WITH PLANT, EQUIPMENT AND PROCESSES FOR THE IRON AND STEEL INDUSTRY, UP AND RUNNING UNITS IN THE INDUSTRIAL AND CIVIL ENGINEERING FIELDS, CONSTRUCTIONAL STEEL WORK, BOILER WORK AND MECHANICAL ENGINEERING; INTELLECTUAL PROPERTY CONSULTATION; CONSTRUCTION CONSULTATION, NAMELY CONSTRUCTION DRAFTING IN THE FIELD OF STEEL MAKING PLANTS; DESIGN STUDIES RELATING TO IRON AND STEEL PROCESSING; MECHANICAL ENGINEERING RESEARCH; TECHNICAL RESEARCH RELATING TO IRON AND STEEL PROCESSING; ENGINEERING SERVICES IN THE FIELDS OF MECHANICAL ENGINEERING, CIVIL ENGINEERING FLUIDS, ELECTRICITY, AUTOMATION AND PREPARATION OF TECHNICAL REPORTS; DESIGN, DEVELOPMENT AND MAINTENANCE OF COMPUTER SOFTWARE FOR OTHERS; COMPUTER SOFTWARE PROGRAMMING FOR OTHERS; PREPARATION OF TECHNICAL REPORTS RELATING TO IRON AND STEEL PROCESSING FOR OTHERS; METAL AND MATERIAL TESTING SERVICES; PREPARATION OF DESIGN STUDIES FOR THE CONSTRUCTION OF BUILDINGS; AND CONSULTING SERVICES IN THE FIELD ENGINEERING, PARTICULARLY IN THE FIELD OF HYDRAULIC SYSTEMS AND EQUIPMENT. (U.S. CLS. 100 AND 101).

ESTHER A. BORSUK, EXAMINING ATTORNEY

SN 76-028,118. YELL LIMITED, READING, BERKSHIRE
RG1 7PT, ENGLAND, FILED 4-13-2000.

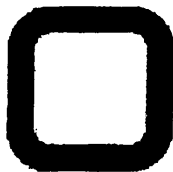

OWNER OF UNITED KINGDOM REG. NO. 2244289C,
DATED 9-1-2000, EXPIRES 9-1-2010.

THE MARK CONSISTS OF A DESIGN OF A SQUARE
DOT WITH ROUNDED CORNERS.

CLASS 9—ELECTRICAL AND SCIENTIFIC APPARATUS

FOR SOFTWARE FOR ACCESSING THE GLOBAL
COMPUTER NETWORK; DATABASE MANAGEMENT
AND ELECTRONIC MESSAGING COMPUTER SOFT-
WARE; MODEMS AND SOFTWARE FOR CONTROL-
LING THE OPERATION OF MODEMS; COMPUTER
DATA TERMINALS; PRERECORDED CD-ROMS ON A
VARIETY OF TOPICS; INTERACTIVE TELEVISIONS
AND KIOSKS; VIDEO GAMES SOFTWARE; PC GAMES
SOFTWARE; COMPUTER NETWORK GAME SOFT-
WARE; PAGERS; SWITCHBOARDS; COMPUTER SOFT-
WARE TO ENABLE SEARCHING OF DATA IN THE
FIELD OF BUSINESS ADVERTISING; COMPUTER PER-
IPHERAL DEVICES, NAMELY MEMORIES, KEY-
BOARDS, ELECTRONIC PENS, MOUSE, MONITORS,
INTERFACES; MAGNETICALLY ENCODED DEBIT
CARDS, CREDIT CARDS, AND PHONE CARDS; WEB
PAGES DOWNLOADED FROM THE INTERNET IN THE
FORM OF PRINTED PAGES, INSTRUCTIONAL AND
TEACHING MATERIALS (U.S. CLS. 21, 23, 26, 36 AND
38).

CLASS 16—PAPER GOODS AND PRINTED MATTER

FOR TELEPHONE AND BUSINESS DIRECTORIES;
PAPER, NAMELY NOTEPADS AND OFFICE STATION-
ERY; POSTERS; MAPS; PRINTED DIRECTORIES,
BOOKS, BOOKLETS, LEAFLETS, BROCHURES, MAN-
UALS AND MAGAZINES CONTAINING INFORMA-
TION ABOUT WEB SITES; PLASTIC MATERIALS FOR
PACKAGING; PHOTOGRAPHS (U.S. CLS. 2, 5, 22, 23, 29,
37, 38 AND 50).

CLASS 35—ADVERTISING AND BUSINESS

FOR TELEPHONE AND BUSINESS DIRECTORY IN-
FORMATION SERVICES ACCESSED VIA THE INTER-
NET; PROVISION OF BUSINESS INFORMATION
SERVICES BY ELECTRONIC MEANS; BUSINESS CON-
SULTING SERVICES; BUSINESS RESEARCH SERVICES;
PREPARING ADVERTISEMENTS FOR OTHERS; SALES
PROMOTION FOR OTHERS; PROVIDING INFORMA-
TION ABOUT IMPORT AND EXPORT AGENCIES AND
INTERNATIONAL TRADE; FOREIGN TRADE INFOR-
MATION AND CONSULTATION; PROVIDING A WEB-
SITE THAT BRINGS BUYERS AND SELLERS
TOGETHER TO FACILITATE THE GROUP PURCHASE
OF GOODS AND SERVICES AS A BUYING CLUB;
PROMOTING THE GOODS AND SERVICES OF OTHERS
THROUGH THE DISTRIBUTION OF COUPONS AND
COMPETITIONS; PROMOTING GOODS AND SERVICES
OF OTHERS THROUGH CONSULTING, CREATING
AND PLACING ADVERTISEMENTS AND LISTINGS BY
MEANS OF A WEB SITE; DISSEMINATION OF ADVER-
TISING OF OTHERS VIA THE INTERNET; ELECTRO-
NIC BILLBOARD ADVERTISING; MARKET RESEARCH
AND ANALYSIS; DATABASE MANAGEMENT SER-
VICES; INFORMATION AND ADVISORY SERVICES
RELATING TO ADVERTISING; CONSULTANCY SER-

VICES IN THE FIELD OF PREPARING, DISSEMINAT-
ING AND CREATING ADVERTISEMENTS FOR
OTHERS; ELECTRONIC RETAILING THROUGH
MEANS OF PROVIDING AN ELECTRONIC SHOPPING
MALL VIA THE INTERNET; ORGANIZATION, OPERA-
TION, MANAGEMENT, AND SUPERVISION OF PRO-
MOTIONAL, INCENTIVE AND LOYALTY PROGRAMS;
TRACKING OF PATHS THAT VISITORS TRAVEL TO
REACH WEB SITES AND PREPARING REPORTS SUM-
MARIZING DATA; PROVIDING A BUSINESS DIREC-
TORY IN THE FIELD OF VEHICLE TOWING AND
BREAKDOWN SERVICES AND GARAGES; PROVIDING
A BUSINESS DIRECTORY IN THE FIELD OF HOME
CONSTRUCTION, REPAIR AND RENOVATION; CAR-
GO TRACKING SERVICES; IMPORT AND EXPORT
AGENCY SERVICES; ONLINE COMPUTER SERVICES,
NAMELY, PROVIDING INFORMATION REGARDING
THE GOODS AND SERVICES OF OTHERS IN THE
NATURE OF A BUYERS' GUIDE, BY MEANS OF THE
INTERNET; MONITORING, ORGANIZING AND ANA-
LYZING TELEPHONE CALLS FOR BUSINESS AND
MARKETING PURPOSES; DIRECT MAIL ADVERTIS-
ING; COMPUTER SERVICES, NAMELY, PROVIDING
ONLINE LINKS TO INFORMATION, WEB SITES, AND
OTHER RESOURCES AVAILABLE VIA THE INTERNET
IN THE FIELD OF SHOPPING (U.S. CLS. 100, 101 AND
102).

CLASS 36—INSURANCE AND FINANCIAL

FOR PROVISION OF FINANCIAL, INSURANCE AND
BANKING INFORMATION VIA THE INTERNET; FI-
NANCIAL VALUATION OF REAL ESTATE; CREDIT
INQUIRY SERVICES; ELECTRONIC BILL PAYMENT
SERVICES; COMPUTER SERVICES, NAMELY, PROVID-
ING ONLINE LINKS TO INFORMATION, WEB SITES,
AND OTHER RESOURCES AVAILABLE VIA THE IN-
TERNET IN THE FIELDS OF REAL ESTATE, PERSONAL
FINANCES AND INSURANCE (U.S. CLS. 100, 101
AND 102).

CLASS 37—CONSTRUCTION AND REPAIR

FOR PROVIDING INFORMATION ON VEHICLE RE-
PAIR AND MAINTENANCE VIA THE INTERNET (U.S.
CLS. 100, 103 AND 106).

CLASS 38—COMMUNICATION

FOR TELECOMMUNICATIONS SERVICES, NAMELY,
THE ELECTRONIC TRANSMISSION OF VOICE, DATA,
VIDEO AND INFORMATION OVER THE INTERNET;
PROVIDING MULTIPLE USER ACCESS TO THE INTER-
NET FOR THE DISSEMINATION OF A WIDE RANGE
OF INFORMATION; TRANSMISSION SERVICES FOR
THE COLLECTION, PROCESSING AND STORAGE OF
MESSAGES AND DATA; REMOTE DATA ACCESS SER-
VICES; PROVIDING WIRELESS CONNECTIONS TO THE
INTERNET FOR ACCESSING DATA; ELECTRONIC
DATA INTERCHANGE SERVICES; ELECTRONIC MAIL
SERVICES; TELEPHONE MESSAGING SERVICES; REN-
TAL OF TELECOMMUNICATIONS EQUIPMENT; CALL
SCREENING SERVICES; CALL DIVERSION AND CALL
RE-ROUTING SERVICES; MULTIPLE MESSAGE SEND-
ING SERVICES; CALL RECORDING SERVICES; FACSI-
MILE TRANSMISSION SERVICES; CALL BARRING
SERVICES; CALL ALERTING SERVICES (U.S. CLS. 100,
101 AND 104).

CLASS 39—TRANSPORTATION AND STORAGE

FOR PROVISION OF TRAVEL INFORMATION SERVICES VIA THE INTERNET; RENTAL CAR RESERVATION SERVICES; TOURIST AGENCY SERVICES; TRANSPORTATION INFORMATION SERVICES; INFORMATION SERVICES RELATING TO THE PACKAGING AND STORAGE OF GOODS; PROVIDING TRAVEL TOUR INFORMATION; TRAVEL ADMINISTRATION SERVICES; PASSENGER TRANSPORT AND AIR CARGO TRANSPORT SERVICES; COURIER SERVICES; VEHICLE HIRE SERVICES; BOOKING OF SEATS FOR TRAVEL; MAKING TICKET RESERVATIONS AND BOOKINGS FOR TRAVEL; TRAVEL BOOKING AND TICKETING SERVICES BY ELECTRONIC AND COMPUTER MEANS; COMPUTER SERVICES, NAMELY, PROVIDING ONLINE LINKS TO INFORMATION, WEB SITES, AND OTHER RESOURCES AVAILABLE VIA THE INTERNET IN THE FIELDS OF TRAVEL AND MOTORING (U.S. CLS. 100 AND 105).

CLASS 41—EDUCATION AND ENTERTAINMENT

FOR ENTERTAINMENT SERVICES, NAMELY, THE PROVISION OF A WEB SITE CONTAINING INFORMATION PERTAINING TO EDUCATION, TRAINING, MUSIC, ART, FILM, LITERATURE, SPORTS, RECREATION, NEWS AND PUBLISHING, BY MEANS OF THE INTERNET; TICKET RESERVATIONS FOR ENTERTAINMENT EVENTS; PUBLISHING SERVICES; ELECTRONIC GAME SERVICES AND COMPETITIONS PROVIDED BY MEANS OF THE INTERNET; MAKING TICKET RESERVATIONS AND BOOKINGS FOR CONCERTS, SHOWS AND OTHER ENTERTAINMENT EVENTS; CONCERT, SHOWS AND OTHER ENTERTAINMENT BOOKING AND TICKETING SERVICES BY ELECTRONIC AND COMPUTER MEANS; COMPUTER SERVICES, NAMELY, PROVIDING ONLINE LINKS TO INFORMATION, WEB SITES, AND OTHER RESOURCES AVAILABLE VIA THE INTERNET IN THE FIELDS OF LEISURE ACTIVITIES, FILM, THEATER, ENTERTAINMENT, NEWS, AND SPORTS (U.S. CLS. 100, 101 AND 107).

CLASS 42—SCIENTIFIC, COMPUTER AND LEGAL SERVICES

FOR COMPUTER SERVICES, NAMELY, CREATING SEARCHABLE INDEXES OF INFORMATION, WEB SITES, AND OTHER RESOURCES AVAILABLE VIA THE INTERNET; COMPUTER SERVICES, NAMELY, PROVIDING ONLINE LINKS TO INFORMATION, WEB SITES, AND OTHER RESOURCES AVAILABLE VIA THE INTERNET IN THE FIELD OF WEATHER; REGISTRATION OF DOMAIN NAMES FOR IDENTIFICATION OF USERS ON A GLOBAL COMPUTER NETWORK; WEB SITE DESIGN, IMPLEMENTATION, MAINTENANCE FOR OTHERS COMPUTER SERVICES IN THE NATURE OF AN ELECTRONIC NEWS AND INFORMATION CLIPPING SERVICE; MAKING HOTEL RESERVATIONS FOR OTHERS; PROVIDING ON-LINE MAGAZINES ON A WIDE VARIETY OF TOPICS, CONSULTANCY SERVICES ON THE MANAGEMENT AND DEVELOPMENT OF WEB SITES FOR OTHERS; WIRELESS APPLICATION SERVICE PROVIDER (ASP) SERVICES, NAMELY, HOSTING COMPUTER SOFTWARE APPLICATIONS OF OTHERS; MAKING RESERVATIONS AND BOOKING FOR HOTELS AND TEMPORARY LODGING; HOTEL AND TEMPORARY LODGING BOOKING AND TICKETING SERVICES BY ELECTRONIC AND COMPUTER MEANS; FINANCIAL INFORMATION DISASTER RECOVERY SERVICES, NAMELY, DISASTER RECOVERY SERVICES FOR ELECTRONIC INFORMATION (U.S. CLS. 100 AND 101).

MARY ROSSMAN, EXAMINING ATTORNEY

SN 76-029,708. YELL LIMITED, READING, BERKSHIRE RG1 7PT, ENGLAND, FILED 4-19-2000.



OWNER OF UNITED KINGDOM REG. NO. 2250465, DATED 1-24-2003, EXPIRES 10-18-2010.

THE MARK CONSISTS OF AN ANIMATED VISUAL SEQUENCE DEPICTING A SQUARE DOT WITH ROUNDED CORNERS AND THE LETTERS Y, E, L, AND L. AFTER THE INITIAL DISPLAY OF THE EMPTY SQUARE DOT WITH ROUNDED CORNERS FOR A FEW SECONDS, THE LETTERS Y, E, L, AND L APPEAR IN QUICK SUCCESSION INSIDE THE SQUARE DOT, SO AS TO SPELL THE WORD YELL. THE LETTERS ARE SEPARATED BY A BRIEF DISPLAY OF THE EMPTY SQUARE DOT. THE DRAWING CONSISTS OF EIGHT STILLs THAT MAKE UP THE SEQUENCE.

CLASS 9—ELECTRICAL AND SCIENTIFIC APPARATUS

FOR SOFTWARE FOR ACCESSING THE GLOBAL COMPUTER NETWORK; DATABASE MANAGEMENT AND ELECTRONIC MESSAGING COMPUTER SOFTWARE; MODEMS AND SOFTWARE FOR CONTROLLING THE OPERATION OF MODEMS; COMPUTER DATA TERMINALS; PRERECORDED CD-ROMS ON A VARIETY OF TOPICS; INTERACTIVE TELEVISIONS AND KIOSKS; VIDEO GAMES SOFTWARE; PC GAMES SOFTWARE; COMPUTER NETWORK GAME SOFTWARE; PAGERS; SWITCHBOARDS; COMPUTER SOFTWARE TO ENABLE SEARCHING OF DATA IN THE FIELD OF BUSINESS ADVERTISING; COMPUTER PERIPHERAL DEVICES, NAMELY MEMORIES, KEYBOARDS, ELECTRONIC PENS, MOUSE, MONITORS, INTERFACES; MAGNETICALLY ENCODED DEBIT CARDS, CREDIT CARDS, AND PHONE CARDS; WEB PAGES DOWNLOADED FROM THE INTERNET IN THE FORM OF PRINTED PAGES, INSTRUCTIONAL AND TEACHING MATERIALS (U.S. CLS. 21, 23, 26, 36 AND 38).

CLASS 16—PAPER GOODS AND PRINTED MATTER

FOR TELEPHONE AND BUSINESS DIRECTORIES; PAPER, NAMELY NOTEPADS AND OFFICE STATIONERY; POSTERS; MAPS; PRINTED DIRECTORIES, BOOKS, BOOKLETS, LEAFLETS, BROCHURES, MANUALS AND MAGAZINES CONTAINING INFORMATION ABOUT WEB SITES; PLASTIC MATERIALS FOR PACKAGING; PHOTOGRAPHS (U.S. CLS. 2, 5, 22, 23, 29, 37, 38 AND 50).

CLASS 35—ADVERTISING AND BUSINESS

FOR TELEPHONE AND BUSINESS DIRECTORY INFORMATION SERVICES ACCESSED VIA THE INTERNET; PROVISION OF BUSINESS INFORMATION SERVICES BY ELECTRONIC MEANS; BUSINESS CONSULTING SERVICES; BUSINESS RESEARCH SERVICES; PREPARING ADVERTISEMENTS FOR OTHERS; SALES PROMOTION FOR OTHERS; PROVIDING INFORMATION ABOUT IMPORT AND EXPORT AGENCIES AND INTERNATIONAL TRADE; FOREIGN TRADE INFORMATION AND CONSULTATION; PROVIDING A WEBSITE THAT BRINGS BUYERS AND SELLERS TOGETHER TO FACILITATE THE GROUP PURCHASE OF GOODS AND SERVICES AS A BUYING CLUB; PROMOTING THE GOODS AND SERVICES OF OTHERS THROUGH THE DISTRIBUTION OF COUPONS AND COMPETITIONS; PROMOTING GOODS AND SERVICES OF OTHERS THROUGH CONSULTING, CREATING AND PLACING ADVERTISEMENTS AND LISTINGS BY MEANS OF A WEB SITE; DISSEMINATION OF ADVERTISING OF OTHERS VIA THE INTERNET; ELECTRONIC BILLBOARD ADVERTISING; MARKET RESEARCH AND ANALYSIS; DATABASE MANAGEMENT SER-

VICES; INFORMATION AND ADVISORY SERVICES RELATING TO ADVERTISING; CONSULTANCY SERVICES IN THE FIELD OF PREPARING, DISSEMINATING AND CREATING ADVERTISEMENTS FOR OTHERS; ELECTRONIC RETAILING THROUGH MEANS OF PROVIDING AN ELECTRONIC SHOPPING MALL VIA THE INTERNET; ORGANIZATION, OPERATION, MANAGEMENT, AND SUPERVISION OF PROMOTIONAL, INCENTIVE AND LOYALTY PROGRAMS; TRACKING OF PATHS THAT VISITORS TRAVEL TO REACH WEB SITES AND PREPARING REPORTS SUMMARIZING DATA; PROVIDING A BUSINESS DIRECTORY IN THE FIELD OF VEHICLE TOWING AND BREAKDOWN SERVICES AND GARAGES; PROVIDING A BUSINESS DIRECTORY IN THE FIELD OF HOME CONSTRUCTION, REPAIR AND RENOVATION; CARGO TRACKING SERVICES; IMPORT AND EXPORT AGENCY SERVICES; ONLINE COMPUTER SERVICES, NAMELY, PROVIDING INFORMATION REGARDING THE GOODS AND SERVICES OF OTHERS IN THE NATURE OF A BUYERS' GUIDE, BY MEANS OF THE INTERNET; MONITORING, ORGANIZING AND ANALYZING TELEPHONE CALLS FOR BUSINESS AND MARKETING PURPOSES; DIRECT MAIL ADVERTISING; COMPUTER SERVICES, NAMELY, PROVIDING ONLINE LINKS TO INFORMATION, WEB SITES, AND OTHER RESOURCES AVAILABLE VIA THE INTERNET IN THE FIELD OF SHOPPING (U.S. CLS. 100, 101 AND 102).

CLASS 36—INSURANCE AND FINANCIAL

FOR PROVISION OF FINANCIAL, INSURANCE AND BANKING INFORMATION VIA THE INTERNET; FINANCIAL VALUATION OF REAL ESTATE; CREDIT INQUIRY SERVICES; COMPUTER SERVICES, NAMELY, PROVIDING ONLINE LINKS TO INFORMATION, WEB SITES, AND OTHER RESOURCES AVAILABLE VIA THE INTERNET IN THE FIELDS OF REAL ESTATE, PERSONAL FINANCES AND INSURANCE (U.S. CLS. 100, 101 AND 102).

CLASS 37—CONSTRUCTION AND REPAIR

FOR PROVIDING INFORMATION ON VEHICLE REPAIR AND MAINTENANCE VIA THE INTERNET (U.S. CLS. 100, 103 AND 106).

CLASS 38—COMMUNICATION

FOR TELECOMMUNICATIONS SERVICES, NAMELY, THE ELECTRONIC TRANSMISSION OF VOICE, DATA, VIDEO AND INFORMATION OVER THE INTERNET; PROVIDING MULTIPLE USER ACCESS TO THE INTERNET FOR THE DISSEMINATION OF A WIDE RANGE OF INFORMATION; TRANSMISSION SERVICES FOR THE COLLECTION, PROCESSING AND STORAGE OF MESSAGES AND DATA; REMOTE DATA ACCESS SERVICES; PROVIDING WIRELESS CONNECTIONS TO THE INTERNET FOR ACCESSING DATA; ELECTRONIC DATA INTERCHANGE SERVICES; ELECTRONIC MAIL SERVICES; TELEPHONE MESSAGING SERVICES; RENTAL OF TELECOMMUNICATIONS EQUIPMENT; CALL SCREENING SERVICES; CALL DIVERSION AND CALL RE-ROUTING SERVICES; MULTIPLE MESSAGE SENDING SERVICES; CALL RECORDING SERVICES; FACSIMILE TRANSMISSION SERVICES; CALL BARRING SERVICES; CALL ALERTING SERVICES (U.S. CLS. 100, 101 AND 104).

CLASS 39—TRANSPORTATION AND STORAGE

FOR PROVISION OF TRAVEL INFORMATION SERVICES VIA THE INTERNET; RENTAL CAR RESERVATION SERVICES; TOURIST AGENCY SERVICES; TRANSPORTATION INFORMATION SERVICES; INFORMATION SERVICES RELATING TO THE PACKAGING AND STORAGE OF GOODS; PROVIDING TRAVEL TOUR INFORMATION; TRAVEL ADMINISTRATION SERVICES; PASSENGER TRANSPORT AND AIR CARGO TRANSPORT SERVICES; COURIER SERVICES; VEHICLE HIRE SERVICES; BOOKING OF SEATS FOR TRAVEL; MAKING TICKET RESERVATIONS AND BOOKINGS FOR TRAVEL; TRAVEL BOOKING AND TICKETING SERVICES BY ELECTRONIC AND COMPUTER MEANS; COMPUTER SERVICES, NAMELY, PROVIDING ONLINE LINKS TO INFORMATION, WEB SITES, AND OTHER RESOURCES AVAILABLE VIA THE INTERNET IN THE FIELDS OF TRAVEL AND MOTORING (U.S. CLS. 100 AND 105).

CLASS 41—EDUCATION AND ENTERTAINMENT

FOR ENTERTAINMENT SERVICES, NAMELY, THE PROVISION OF A WEB SITE CONTAINING INFORMATION PERTAINING TO EDUCATION, TRAINING, MUSIC, ART, FILM, LITERATURE, SPORTS, RECREATION, NEWS AND PUBLISHING, BY MEANS OF THE INTERNET; TICKET RESERVATIONS FOR ENTERTAINMENT EVENTS; PUBLISHING SERVICES; ELECTRONIC GAME SERVICES AND COMPETITIONS PROVIDED BY MEANS OF THE INTERNET; MAKING TICKET RESERVATIONS AND BOOKINGS FOR CONCERTS, SHOWS AND OTHER ENTERTAINMENT EVENTS; CONCERT, SHOWS AND OTHER ENTERTAINMENT BOOKING AND TICKETING SERVICES BY ELECTRONIC AND COMPUTER MEANS; COMPUTER SERVICES, NAMELY, PROVIDING ONLINE LINKS TO INFORMATION, WEB SITES, AND OTHER RESOURCES AVAILABLE VIA THE INTERNET IN THE FIELDS OF LEISURE ACTIVITIES, FILM, THEATER, ENTERTAINMENT, NEWS, AND SPORTS (U.S. CLS. 100, 101 AND 107).

CLASS 42—SCIENTIFIC, COMPUTER AND LEGAL SERVICES

FOR COMPUTER SERVICES, NAMELY, CREATING SEARCHABLE INDEXES OF INFORMATION, WEB SITES, AND OTHER RESOURCES AVAILABLE VIA THE INTERNET; COMPUTER SERVICES, NAMELY, PROVIDING ONLINE LINKS TO INFORMATION, WEB SITES, AND OTHER RESOURCES AVAILABLE VIA THE INTERNET IN THE FIELD OF WEATHER; REGISTRATION OF DOMAIN NAMES FOR IDENTIFICATION OF USERS ON A GLOBAL COMPUTER NETWORK; WEB SITE DESIGN, IMPLEMENTATION, MAINTENANCE FOR OTHERS COMPUTER SERVICES IN THE NATURE OF AN ELECTRONIC NEWS AND INFORMATION CLIPPING SERVICE; MAKING HOTEL RESERVATIONS FOR OTHERS; PROVIDING ON-LINE MAGAZINES ON A WIDE VARIETY OF TOPICS, CONSULTANCY SERVICES ON THE MANAGEMENT AND DEVELOPMENT OF WEB SITES FOR OTHERS; WIRELESS APPLICATION SERVICE PROVIDER (ASP) SERVICES, NAMELY, HOSTING COMPUTER SOFTWARE APPLICATIONS FOR OTHERS; MAKING RESERVATIONS AND BOOKING FOR HOTELS AND TEMPORARY LODGING; HOTEL AND TEMPORARY LODGING BOOKING AND TICKETING SERVICES BY ELECTRONIC AND COMPUTER MEANS; FINANCIAL INFORMATION DISASTER RECOVERY SERVICES, NAMELY, DISASTER RECOVERY SERVICES FOR ELECTRONIC INFORMATION (U.S. CLS. 100 AND 101).

MARY ROSSMAN, EXAMINING ATTORNEY

SN 76-207,867. ORPHAN PHARMACEUTICALS-USA, INC.,
NASHVILLE, TN. FILED 2-9-2001.



NO CLAIM IS MADE TO THE EXCLUSIVE RIGHT TO
USE "ORPHAN", APART FROM THE MARK AS SHOWN.
THE DESIGN IS A GLOBE.

CLASS 5—PHARMACEUTICALS

FOR PHARMACEUTICALS FOR THE TREATMENT
OF RARE DISEASES, NAMELY IN THE FIELD OF
CARDIOLOGY, DISEASES AFFECTING IMMUNOCOM-
PROMISED PATIENTS, GENETIC DISORDERS, HAE-
MATOLOGY, INFECTIOUS DISEASES, METABOLIC
DISORDERS, ONCOLOGY, PALLIATIVE CARE, POISON
CONTROL, RESPIRATORY DISEASES, UROLOGY AND
PSYCHIATRIC DISEASES (U.S. CLS. 6, 18, 44, 46, 51 AND
52).

CLASS 42—SCIENTIFIC, COMPUTER AND LEGAL SERVICES

FOR PRODUCT RESEARCH AND DEVELOPMENT OF
PRESCRIPTION AND OVER-THE-COUNTER DRUGS
(U.S. CLS. 100 AND 101).

BRIAN BROWN, EXAMINING ATTORNEY

SN 76-242,441. SHIN, KYU HO, SONGPA-KU, SEOUL,
REPUBLIC OF KOREA, FILED 4-18-2001.



PRIORITY CLAIMED UNDER SEC. 44(D) ON REPUBLIC
OF KOREA APPLICATION NO. 2000-0049571, FILED 10-23-
2000, REG. NO. 0512331, DATED 2-9-2002, EXPIRES 2-9-2012.

PRIORITY CLAIMED UNDER SEC. 44(D) ON REPUBLIC
OF KOREA APPLICATION NO. 2000-49570, FILED 10-23-
2000, REG. NO. 0507298, DATED 11-24-2001, EXPIRES 11-24-
2011.

PRIORITY CLAIMED UNDER SEC. 44(D) ON REPUBLIC
OF KOREA APPLICATION NO. 2000-50466, FILED 10-28-
2000, REG. NO. 0502797, DATED 9-29-2001, EXPIRES 9-29-
2011.

CLASS 18—LEATHER GOODS

FOR LEATHER GOODS, TRUNKS, BAGS AND UM-
BRELLAS, NAMELY, PORTABLE COSMETIC CASES
NOT FILLED WITH ANY CONTENTS; FUR SKIN,
NAMELY, FUR PELTS; ARTIFICIAL FUR SKIN;
NAMELY IMITATION FUR PELTS, NON-PRECIOUS
MATERIALS PURSES, STUDENT'S BAGS IN THE NATURE
OF BACKPACKS, BEACH PARASOLS, PARASOLS,
STICKS FOR MOUNTAIN-CLIMBING, LEATHER
STRAPS, NAMELY, HAND AND SHOULDER CARRY-
ING STRAPS (U.S. CLS. 1, 2, 3, 22 AND 41).

CLASS 20—FURNITURE AND ARTICLES NOT OTHERWISE CLASSIFIED

FOR LEATHER BOXES (U.S. CLS. 2, 13, 22, 25, 32 AND
50).

CLASS 25—CLOTHING

FOR CLOTHING, SHOES AND HATS, NAMELY, LOW
SHOES, SPORTS ANORAK, HORSE RIDING PANTS,
MEN'S SUITS, JEOGORI, NAMELY KOREAN JACKETS,
SWEATER, HATS, LEATHER BELTS (U.S. CLS. 22 AND
39).

WON TEAK OH, EXAMINING ATTORNEY

SN 76-314,483. ABB AUTOMATION GROUP AG, CH-8050
ZÜRICH, SWITZERLAND, FILED 9-19-2001.

TURBOCHARGE^{IT}

PRIORITY CLAIMED UNDER SEC. 44(D) ON SWITZER-
LAND APPLICATION NO. 02918/2001, FILED 3-22-2001,
REG. NO. 489480, DATED 9-24-2001, EXPIRES 3-22-2011.

CLASS 9—ELECTRICAL AND SCIENTIFIC APPARATUS

FOR SCIENTIFIC, NAUTICAL, ELECTRICAL AND
ELECTRONIC, OPTICAL, WEIGHING, MEASURING,
ANALYSIS, DISPLAY, SIGNALING AND CHECKING,
SUPERVISION APPARATUS AS WELL AS INSTRU-
MENTS AND EQUIPMENT, NAMELY FLOW METERS,
AMMETERS, WATER AND GAS METERS, GAS, LIQUID
AND PHYSICAL PROPERTY ANALYZERS, SPECTRO-
METERS, PHOTOMETERS, LOAD CELLS, SENSORS,
FLOW SENSORS, TEMPERATURE SENSORS, INTEGRO-
ATORS, METAL DETECTORS FOR INDUSTRIAL PUR-
POSES, ACTUATORS, CONTROL VALVES FOR
REGULATING THE FLOW OF GASES AND LIQUIDS,
TRANSMITTERS FOR SIGNALS, ELECTROACOUSTIC
TRANSDUCERS, SCANNERS, ACOUSTIC AND OPTI-
CAL ALARMS, BURGLAR ALARMS, ELECTRONIC
NOTICE BOARDS, ELECTRIC CONTROL PANELS FOR
ELECTRICITY, ELECTRIC CHEMICAL CELLS; DOWN-
LOADABLE ELECTRONIC PUBLICATIONS IN THE
NATURE OF MANUALS, TABLES, SPREADSHEETS,
GRAPHIC PRINTS, FURTHER READINGS, INFORMA-
TION BROCHURES AND ELECTRONIC NEWSLETTER
IN THE FIELD OF PROCESS AND AUTOMATION
INDUSTRIES, UTILITY INDUSTRY, OIL, GAS AND
PETROCHEMICAL INDUSTRIES, MANUFACTURING
AND CONSUMER INDUSTRIES; DATA PROCESSORS
AND DATA PROCESSING COMPUTERS AND COMPU-
TERS; MICROPROCESSORS; COMPUTER SOFTWARE,
APPLICATION SOFTWARE, SOFTWARE TOOLS AND
COMPUTER PROGRAMS FOR PROVIDING INTER-
FACES TO OPERATORS AND SETTING PARAMETERS,
FOR COMPILING, ANALYZING, RECORDING, CON-
TROLLING, RETRIEVING, STORING, CONSOLIDAT-
ING AND MANAGING DATA, SPECIALLY FAULTS
DATA, FAULTS LOCATION DATA, PHYSICAL VALUES
AND CHEMICAL PROPERTIES, SIGNALS AND FOR
CALCULATING, REGULATING, ACTUATING, CREAT-

ING, EDITING, MODIFYING, OPTIMIZING, MONITORING, SUPPORTING, CONFIGURING, TUNING PROCESSES IN THE AUTOMOTIVE, METAL FABRICATION, FOUNDRY, PULP AND PAPER, PLASTICS, CONSUMER GOODS, CHEMICALS, PHARMACEUTICALS, MARINE, CEMENT, MINERALS, MINING, ELECTRIC UTILITIES, POWER GENERATION, WATER, OIL, AND GAS, PETROCHEMICALS AND REFINING INDUSTRIES, IN LOGISTIC SYSTEMS; COMPUTER PROGRAMS FOR PROVIDING INTERFACES TO OPERATORS AND REAL TIME INFORMATION TO BUSINESS SYSTEMS, FOR SETTING PARAMETERS, FOR CONFIGURING MEASURING FUNCTIONS, FOR COORDINATING PROCESSING, TESTING AND STATUS REPORTING TO THE PROCESSORS, ESPECIALLY TO MINIMIZE LOSSES IN THE POWER NETWORK, FOR DEVELOPING, REGULATING, ACTUATING AND SUPPORTING PROGRAMMABLE ELECTRONIC SAFETY SYSTEMS, FOR COMPILING, ANALYZING, RECORDING, CONTROLLING, RETRIEVING; STORING, CONSOLIDATING AND MANAGING DATA, SPECIALLY FAULTS DATA, FAULTS LOCATION DATA, PHYSICAL VALUES AND CHEMICAL PROPERTIES, SIGNAL SAND FOR CALCULATING, REGULATING, ACTUATING, CREATING, EDITING, MODIFYING, OPTIMIZING, MONITORING, SUPPORTING, CONFIGURING, TUNING PROCESSES IN THE AUTOMOTIVE, METAL FABRICATION, FOUNDRY, PULP AND PAPER, PLASTICS, CONSUMER GOODS, CHEMICALS, PHARMACEUTICALS, MARINE, CEMENT, MINERALS, MINING, ELECTRIC UTILITIES, POWER GENERATION, WATER, OIL AND GAS, PETROCHEMICALS AND REFINING INDUSTRIES, IN LOGISTIC SYSTEMS, IN TELECOMMUNICATION SYSTEMS; ELECTRIC CABLES, ELECTRIC WIRES, SEMICONDUCTORS; ELECTRONIC AND ELECTRICAL APPARATUS, EQUIPMENT AND INSTRUMENTS AND PARTS THEREOF FOR POWER GENERATION, DISTRIBUTION AND SUPPLY AS WELL AS FOR GENERATING, DISTRIBUTING AND SUPPLYING ALTERNATIVE ENERGY, NAMELY ELECTRIC DUCTS AND LEADS, SIGNAL CABLES, STARTER CABLES FOR MOTORS, ELECTRIC CONTRACTORS, ELECTRIC AND ELECTRONIC RELAYS, ELECTRIC TRANSFORMERS, ELECTRIC CONVERTERS AND INVERTERS, ELECTRICAL CONNECTIONS, NAMELY, SOCKETS AND PLUGS, RESIDUAL CURRENT DEVICES, ELECTRIC INTERRUPTERS AND VACUUM INTERRUPTERS, ELECTRIC CAPACITORS, ELECTRIC REACTORS, ELECTRICITY LOSS METERS, ELECTRIC DISTRIBUTION CONSOLES, ELECTRICAL DISTRIBUTION BOXES, DISTRIBUTION BOARDS AND JUNCTION BOXES FOR ELECTRICITY, ELECTRONIC INDICATOR BOARDS, ELECTRIC INDUCTORS, ELECTRIC POSITIVE BOOSTER, ELECTRIC ACCUMULATORS, ELECTRIC SWITCHES AND CELL SWITCHES, CIRCUIT BREAKERS, CIRCUIT CLOSERS, FUSES, ELECTRIC TERMINALS, ELECTRIC ANTI-INTERFERENCE DEVICES, SEMICONDUCTOR ELEMENTS; PRERECORDED DISKETTES FEATURING DATA AND TECHNICAL INSTRUCTIONS REGARDING PRODUCTS AND SERVICES SPECIFIC TO PROCESS INDUSTRY, AUTOMATION INDUSTRY, UTILITIES INDUSTRY, OIL, GAS AND PETROCHEMICALS CHEMICALS INDUSTRIES, MANUFACTURING AND CONSUMER INDUSTRIES; PRE-RECORDED MAGNETIC DISKS FEATURING DATA AND TECHNICAL INSTRUCTIONS REGARDING PRODUCTS AND SERVICES SPECIFIC TO PROCESS INDUSTRY, AUTOMATION INDUSTRY, UTILITIES INDUSTRY, OIL, GAS AND PETROCHEMICALS INDUSTRIES, MANUFACTURING AND CONSUMER INDUSTRIES; PRERECORDED OPTICAL DISKS FEATURING DATA AND TECHNICAL INSTRUCTIONS REGARDING PRODUCTS AND SERVICES SPECIFIC TO PROCESS INDUSTRY, AUTOMATION INDUSTRY, UTILITIES INDUSTRY, OIL, GAS AND PETROCHEMICALS INDUSTRIES, MANUFACTURING AND CONSUMER INDUSTRIES; DATA ENCRYPTION SOFTWARE (U.S. CLS. 21, 23, 26, 36 AND 38).

CLASS 42—SCIENTIFIC, COMPUTER AND LEGAL SERVICES

FOR PROVIDING TEMPORARY USE OF ONLINE NON-DOWNLOADABLE SOFTWARE FOR CONSULTING AND LOOKING UP MANUALS AND INFORMATION REGARDING PRODUCTS AND SERVICES SPECIFIC TO PROCESS INDUSTRY, UTILITIES INDUSTRY, OIL, GAS AND PETROCHEMICALS INDUSTRIES, MANUFACTURING AND CONSUMER INDUSTRIES, COMMUNICATION TECHNOLOGY, FOR COMPARING, ANALYZING, CALCULATING AND BREAKING DOWN DATA, VALUES AND PROCESSES IN THE FIELD OF PROCESS INDUSTRY, UTILITIES INDUSTRY, OIL, GAS AND PETROCHEMICALS INDUSTRIES, MANUFACTURING AND CONSUMER INDUSTRIES, COMMUNICATION TECHNOLOGY; TECHNICAL SUPPORT AND INFORMATION REGARDING THE USE OF COMPUTERS, COMPUTER HARDWARE, COMPUTER SOFTWARE AND COMPUTER NETWORKS ONLINE FROM A COMPUTER DATABASE OR VIA COMPUTER NETWORKS; UPDATING COMPUTER SOFTWARE FOR OTHERS; PROFESSIONAL CONSULTANCY IN THE FIELD OF COMPUTER SOFTWARE ENGINEERING, NETWORK ENGINEERING, IMPLEMENTATION OF HARDWARE, SOFTWARE AND NETWORK SYSTEMS, COMPUTER SYSTEMS ANALYSIS, QUALITY CONTROL; DESIGN OF COMPUTER SOFTWARE FOR OTHERS; INDUSTRIAL DESIGN; RENTAL AND LEASING OF PORTABLE SANITATION EQUIPMENT, NAMELY SINKS AND TOILETS; COMPUTER CONSULTATION; RECOVERY OF COMPUTER DATA; MAINTENANCE OF COMPUTER SOFTWARE; COMPUTER SYSTEM ANALYSIS, NAMELY EFFICIENCY ANALYSIS, INTEROPERABILITY ANALYSIS, SCALABILITY ANALYSIS, FAULT ANALYSIS, DRIVES ANALYSIS; RESEARCH AND DEVELOPMENT OF NEW PRODUCTS FOR OTHERS; RESEARCH IN THE FIELD OF ENGINEERING AND MACHINE CONSTRUCTION; PREPARING TECHNICAL EXPERT REPORTS; ENGINEERING; LEASING OF SOFTWARE AND DATA PROCESSING EQUIPMENT; SOFTWARE DEVELOPMENT; NETWORK TECHNOLOGY, NAMELY TECHNICAL SERVICES IN THE SETTING UP AND OPERATION OF COMPUTER NETWORKS, NETWORK ENGINEERING, DEVELOPMENT AND DESIGN ENGINEERING OF NETWORKS (U.S. CLS. 100 AND 101).

SHARI SHEFFIELD, EXAMINING ATTORNEY

SN 76-317,075. YELL LIMITED, BERKSHIRE RG1 7PT, ENGLAND, FILED 9-20-2001.



OWNER OF UNITED KINGDOM REG. NO. 2280288, DATED 9-11-2001, EXPIRES 9-11-2010.

OWNER OF U.S. REG. NOS. 2,676,201, 2,901,024 AND 2,958,904.

THE MARK CONSISTS OF THE WORD "YELL" WITH A SQUARISH BACKGROUND WITH A BLACK BORDER.

CLASS 9—ELECTRICAL AND SCIENTIFIC APPARATUS

FOR SOFTWARE FOR ACCESSING THE GLOBAL COMPUTER NETWORK; DATABASE MANAGEMENT AND ELECTRONIC MESSAGING COMPUTER SOFTWARE; MODEMS AND SOFTWARE FOR CONTROLLING THE OPERATION OF MODEMS; COMPUTER DATA TERMINALS; PRERECORDED CD-ROMS ON A VARIETY OF TOPICS; INTERACTIVE TELEVISIONS AND KIOSKS; VIDEO GAMES SOFTWARE; PC GAMES SOFTWARE; COMPUTER NETWORK GAME SOFTWARE; PAGERS; SWITCHBOARDS; COMPUTER SOFTWARE TO ENABLE SEARCHING OF DATA IN THE FIELD OF BUSINESS ADVERTISING; COMPUTER PERIPHERAL DEVICES, NAMELY MEMORIES, KEYBOARDS, ELECTRONIC PENS, MOUSE, MONITORS, INTERFACES; MAGNETICALLY ENCODED DEBIT CARDS, CREDIT CARDS, AND PHONE CARDS; WEB PAGES DOWNLOADED FROM THE INTERNET IN THE FORM OF PRINTED PAGES, INSTRUCTIONAL AND TEACHING MATERIALS (U.S. CLS. 21, 23, 26, 36 AND 38).

CLASS 16—PAPER GOODS AND PRINTED MATTER

FOR TELEPHONE AND BUSINESS DIRECTORIES; PAPER, NAMELY NOTEPADS AND OFFICE STATIONERY; POSTERS; MAPS; PRINTED DIRECTORIES, BOOKS, BOOKLETS, LEAFLETS, BROCHURES, MANUALS AND MAGAZINES CONTAINING INFORMATION ABOUT WEB SITES; PLASTIC MATERIALS FOR PACKAGING; PHOTOGRAPHS (U.S. CLS. 2, 5, 22, 23, 29, 37, 38 AND 50).

CLASS 35—ADVERTISING AND BUSINESS

FOR TELEPHONE AND BUSINESS DIRECTORY INFORMATION SERVICES ACCESSED VIA THE INTERNET; PROVISION OF BUSINESS INFORMATION SERVICES BY ELECTRONIC MEANS; BUSINESS CONSULTING SERVICES; BUSINESS RESEARCH SERVICES; PREPARING ADVERTISEMENTS FOR OTHERS; SALES PROMOTION FOR OTHERS; PROVIDING INFORMATION ABOUT IMPORT AND EXPORT AGENCIES AND INTERNATIONAL TRADE; FOREIGN TRADE INFORMATION AND CONSULTATION; PROVIDING A WEBSITE THAT BRINGS BUYERS AND SELLERS TOGETHER TO FACILITATE THE GROUP PURCHASE OF GOODS AND SERVICES AS A BUYING CLUB; PROMOTING THE GOODS AND SERVICES OF OTHERS THROUGH THE DISTRIBUTION OF COUPONS AND COMPETITIONS; PROMOTING GOODS AND SERVICES OF OTHERS THROUGH CONSULTING, CREATING AND PLACING ADVERTISEMENTS AND LISTINGS BY MEANS OF A WEB SITE; DISSEMINATION OF ADVERTISING OF OTHERS VIA THE INTERNET; ELECTRONIC BILLBOARD ADVERTISING; MARKET RESEARCH AND ANALYSIS; DATABASE MANAGEMENT SERVICES; INFORMATION AND ADVISORY SERVICES RELATING TO ADVERTISING; CONSULTANCY SERVICES IN THE FIELD OF PREPARING, DISSEMINATING AND CREATING ADVERTISEMENTS FOR OTHERS; ELECTRONIC RETAILING THROUGH MEANS OF PROVIDING AN ELECTRONIC SHOPPING MALL VIA THE INTERNET; ORGANIZATION, OPERATION, MANAGEMENT, AND SUPERVISION OF PROMOTIONAL, INCENTIVE AND LOYALTY PROGRAMS; TRACKING OF PATHS THAT VISITORS TRAVEL TO REACH WEB SITES AND PREPARING REPORTS SUMMARIZING DATA; PROVIDING A BUSINESS DIRECTORY IN THE FIELD OF VEHICLE TOWING AND BREAKDOWN SERVICES AND GARAGES; PROVIDING A BUSINESS DIRECTORY IN THE FIELD OF HOME CONSTRUCTION, REPAIR AND RENOVATION; CARGO TRACKING SERVICES; IMPORT AND EXPORT AGENCY SERVICES; ONLINE COMPUTER SERVICES, NAMELY, PROVIDING INFORMATION REGARDING THE GOODS AND SERVICES OF OTHERS IN THE NATURE OF A BUYERS' GUIDE, BY MEANS OF THE INTERNET; MONITORING, ORGANIZING AND ANALYZING TELEPHONE CALLS FOR BUSINESS AND MARKETING PURPOSES; DIRECT MAIL ADVERTISING; COMPUTER SERVICES, NAMELY, PROVIDING ONLINE LINKS TO INFORMATION, WEB SITES, AND

OTHER RESOURCES AVAILABLE VIA THE INTERNET IN THE FIELD OF SHOPPING (U.S. CLS. 100, 101 AND 102).

CLASS 36—INSURANCE AND FINANCIAL

FOR PROVISION OF FINANCIAL, INSURANCE AND BANKING INFORMATION VIA THE INTERNET; FINANCIAL VALUATION OF REAL ESTATE; CREDIT INQUIRY SERVICES; ELECTRONIC BILL PAYMENT SERVICES; COMPUTER SERVICES, NAMELY, PROVIDING ONLINE LINKS TO INFORMATION, WEB SITES, AND OTHER RESOURCES AVAILABLE VIA THE INTERNET IN THE FIELDS OF REAL ESTATE, PERSONAL FINANCES AND INSURANCE (U.S. CLS. 100, 101 AND 102).

CLASS 37—CONSTRUCTION AND REPAIR

FOR PROVIDING INFORMATION ON VEHICLE REPAIR AND MAINTENANCE VIA THE INTERNET (U.S. CLS. 100, 103 AND 106).

CLASS 38—COMMUNICATION

FOR TELECOMMUNICATIONS SERVICES, NAMELY, THE ELECTRONIC TRANSMISSION OF VOICE, DATA, VIDEO AND INFORMATION OVER THE INTERNET; PROVIDING MULTIPLE USER ACCESS TO THE INTERNET FOR THE DISSEMINATION OF A WIDE RANGE OF INFORMATION; TRANSMISSION SERVICES FOR THE COLLECTION, PROCESSING AND STORAGE OF MESSAGES AND DATA; REMOTE DATA ACCESS SERVICES; PROVIDING WIRELESS CONNECTIONS TO THE INTERNET FOR ACCESSING DATA; ELECTRONIC DATA INTERCHANGE SERVICES; ELECTRONIC MAIL SERVICES; TELEPHONE MESSAGING SERVICES; RENTAL OF TELECOMMUNICATIONS EQUIPMENT; CALL SCREENING SERVICES; CALL DIVERSION AND CALL RE-ROUTING SERVICES; MULTIPLE MESSAGE SENDING SERVICES; CALL RECORDING SERVICES; FACSIMILE TRANSMISSION SERVICES; CALL BARRING SERVICES; CALL ALERTING SERVICES (U.S. CLS. 100, 101 AND 104).

CLASS 39—TRANSPORTATION AND STORAGE

FOR PROVISION OF TRAVEL INFORMATION SERVICES VIA THE INTERNET; RENTAL CAR RESERVATION SERVICES; TOURIST AGENCY SERVICES; TRANSPORTATION INFORMATION SERVICES; INFORMATION SERVICES RELATING TO THE PACKAGING AND STORAGE OF GOODS; PROVIDING TRAVEL TOUR INFORMATION; TRAVEL ADMINISTRATION SERVICES; PASSENGER TRANSPORT AND AIR CARGO TRANSPORT SERVICES; COURIER SERVICES; VEHICLE HIRE SERVICES; BOOKING OF SEATS FOR TRAVEL; MAKING TICKET RESERVATIONS AND BOOKINGS FOR TRAVEL; TRAVEL BOOKING AND TICKETING SERVICES BY ELECTRONIC AND COMPUTER MEANS; COMPUTER SERVICES, NAMELY, PROVIDING ONLINE LINKS TO INFORMATION, WEB SITES, AND OTHER RESOURCES AVAILABLE VIA THE INTERNET IN THE FIELDS OF TRAVEL AND MOTORING (U.S. CLS. 100 AND 105).

CLASS 41—EDUCATION AND ENTERTAINMENT

FOR ENTERTAINMENT SERVICES, NAMELY, THE PROVISION OF A WEB SITE CONTAINING INFORMATION PERTAINING TO EDUCATION, TRAINING, MUSIC, ART, FILM, LITERATURE, SPORTS, RECREATION, NEWS AND PUBLISHING, BY MEANS OF THE INTERNET; TICKET RESERVATIONS FOR ENTERTAINMENT EVENTS; PUBLISHING SERVICES; ELECTRONIC GAME SERVICES AND COMPETITIONS PROVIDED BY MEANS OF THE INTERNET; MAKING TICKET RESERVATIONS AND BOOKINGS FOR CONCERTS, SHOWS AND OTHER ENTERTAINMENT EVENTS; CONCERT, SHOWS AND OTHER ENTERTAINMENT BOOKING AND TICKETING SERVICES BY ELECTRONIC AND COMPUTER MEANS; COMPUTER SERVICES, NAMELY, PROVIDING ONLINE LINKS TO INFORMATION, WEB SITES, AND OTHER RESOURCES AVAILABLE VIA THE INTERNET IN THE FIELDS OF LEISURE ACTIVITIES, FILM, THEATER, ENTERTAINMENT, NEWS, AND SPORTS (U.S. CLS. 100, 101 AND 107).

CLASS 42—SCIENTIFIC, COMPUTER AND LEGAL SERVICES

FOR COMPUTER SERVICES, NAMELY, CREATING SEARCHABLE INDEXES OF INFORMATION, WEB SITES, AND OTHER RESOURCES AVAILABLE VIA THE INTERNET; COMPUTER SERVICES, NAMELY, PROVIDING ONLINE LINKS TO INFORMATION, WEB SITES, AND OTHER RESOURCES AVAILABLE VIA THE INTERNET IN THE FIELD OF WEATHER; REGISTRATION OF DOMAIN NAMES FOR IDENTIFICATION OF USERS ON A GLOBAL COMPUTER NETWORK; WEB SITE DESIGN, IMPLEMENTATION, MAINTENANCE FOR OTHERS; COMPUTER SERVICES IN THE NATURE OF AN ELECTRONIC NEWS AND INFORMATION CLIPPING SERVICE; MAKING HOTEL RESERVATIONS FOR OTHERS; PROVIDING ON-LINE MAGAZINES ON A WIDE VARIETY OF TOPICS, CONSULTANCY SERVICES ON THE MANAGEMENT AND DEVELOPMENT OF WEB SITES FOR OTHERS; WIRELESS APPLICATION SERVICE PROVIDER (ASP) SERVICES, NAMELY, HOSTING COMPUTER SOFTWARE APPLICATIONS FOR OTHERS; MAKING RESERVATIONS AND BOOKING FOR HOTELS AND TEMPORARY LODGING; HOTEL AND TEMPORARY LODGING BOOKING AND TICKETING SERVICES BY ELECTRONIC AND COMPUTER MEANS; FINANCIAL INFORMATION DISASTER RECOVERY SERVICES, NAMELY, DISASTER RECOVERY SERVICES FOR ELECTRONIC INFORMATION (U.S. CLS. 100 AND 101).

MARY ROSSMAN, EXAMINING ATTORNEY

SN 76-358,975. SALEM COMMUNICATIONS HOLDING CORPORATION, CAMARILLO, CA. FILED 1-15-2002.

CELEBRATE FREEDOM**CLASS 9—ELECTRICAL AND SCIENTIFIC APPARATUS**

FOR MUSICAL SOUND RECORDINGS (U.S. CLS. 21, 23, 26, 36 AND 38).

CLASS 16—PAPER GOODS AND PRINTED MATTER

FOR PRINTED MATTER, NAMELY BUMPER STICKERS (U.S. CLS. 2, 5, 22, 23, 29, 37, 38 AND 50).

CLASS 25—CLOTHING

FOR CLOTHING, NAMELY T-SHIRTS (U.S. CLS. 22 AND 39).

CLASS 41—EDUCATION AND ENTERTAINMENT

FOR ENTERTAINMENT SERVICES IN THE NATURE OF A CHRISTIAN MUSIC FESTIVAL (U.S. CLS. 100, 101 AND 107).

RONALD AIKENS, EXAMINING ATTORNEY

SN 76-401,066. TURFTRAX GROUP LIMITED, WILTSHIRE SP1 2A, UNITED KINGDOM, FILED 4-26-2002.

MAGNASCAN

OWNER OF ERPN CMNTY TM OFC REG. NO. 002358158, DATED 2-27-2003, EXPIRES 8-20-2011.

CLASS 9—ELECTRICAL AND SCIENTIFIC APPARATUS

FOR ELECTRONIC SCANNERS FOR THE MEASUREMENT AND DETECTION OF GROUND OR SOIL PROPERTIES OR CONDITIONS; ELECTRONIC SYSTEMS FOR PROVIDING OR OBTAINING GEOGRAPHICAL OR POSITIONAL INFORMATION COMPRISING COMPUTER HARDWARE AND SOFTWARE FOR DETERMINING THE RELATIVE LOCATION OF AN OBJECT; ELECTRONIC INSTRUMENTATION, NAMELY, MONITORS FOR RECORDING GROUND OR SOIL PROPERTY OR CONDITION INFORMATION IN CONJUNCTION WITH GEOGRAPHICAL OR POSITIONAL INFORMATION; DATA PROCESSORS AND COMPUTER SOFTWARE FOR RECORDING AND ANALYZING GROUND OR SOIL PROPERTIES OR CONDITIONS, GROUND OR SOIL MANAGEMENT, GEOGRAPHICAL INFORMATION AND POSITIONAL INFORMATION; ELECTRONIC INSTRUMENTATION, NAMELY ELECTROMAGNETIC INDUCTION SENSORS CONTAINING TRANSMITTERS AND RECEIVER COILS FOR PRODUCING GROUND OR SOIL PROPERTY OR CONDITION MAPS (U.S. CLS. 21, 23, 26, 36 AND 38).

CLASS 42—SCIENTIFIC, COMPUTER AND LEGAL SERVICES

FOR AGRICULTURAL CHEMICAL RESEARCH; MEASUREMENT, EVALUATION, DETECTION AND MANAGEMENT OF GROUND OR SOIL PROPERTIES OR CONDITIONS; BIOLOGICAL AND CHEMICAL RESEARCH AND ANALYSIS; CONSTRUCTION DRAFTING; LAND SURVEYING; GEOLOGICAL RESEARCH AND SURVEYING; DATA ANALYSIS AND CONSULTANCY SERVICES REGARDING GROUND OR SOIL PROPERTIES OR CONDITIONS, SURFACE MANAGEMENT, AGRONOMIC MANAGEMENT AND IRRIGATION OPERATION AND SCHEDULING (U.S. CLS. 100 AND 101).

ANNE MADDEN, EXAMINING ATTORNEY

SN 76-461,533. SUPERFUND UNTERNEHMENS-BETEILIGUNGS-AG, VIENNA, AUSTRIA, FILED 10-23-2002.

SUPERFUND

SEC. 2(F).

CLASS 35—ADVERTISING AND BUSINESS

FOR BUSINESS SERVICES, NAMELY, BUSINESS MANAGEMENT AND CONSULTATIONS (U.S. CLS. 100, 101 AND 102).

FIRST USE 6-16-1987; IN COMMERCE 8-20-1987.

CLASS 36—INSURANCE AND FINANCIAL

FOR FINANCIAL INVESTMENT IN THE FIELD OF FINANCIAL SERVICES IN THE NATURE OF INVESTMENT OF CAPITAL IN PRIMARILY DERIVATIVE INSTRUMENTS, NAMELY, OPTIONS AND FUTURES ON ALL MAJOR INTERNATIONAL STOCK MARKETS, CURRENCIES, COMMODITIES, AND INTEREST RATE PRODUCTS, AS WELL AS SECURITIES; FINANCIAL INVESTMENT CONSULTATION SERVICES, NAMELY, FINANCIAL CONSULTING SERVICES PROVIDED WITH REGARD TO ASSET ALLOCATION, TREND-FOLLOWING, TECHNICAL ANALYSIS, AND MONEY MANAGEMENT (U.S. CLS. 100, 101 AND 102).

FIRST USE 6-16-1987; IN COMMERCE 8-20-1987.

ROBERT C. CLARK JR., EXAMINING ATTORNEY

CLASS 39—TRANSPORTATION AND STORAGE

FOR PROVIDING SERVICES, FOR INDIVIDUALS, COMPANIES, CORPORATIONS, INSURERS, PRIVATE HEALTH CARE PROFESSIONALS OR INSTITUTIONS AND GOVERNMENTAL HEALTHCARE PROFESSIONALS OR INSTITUTIONS, FOR THE ELECTRONIC STORAGE OF A PERSON'S HEALTH CONDITION, VITAL SIGNS, EXERCISE LEVELS AND DIETARY PATTERNS THROUGH THE USE OF SUITABLE MEDICAL DEVICES SUCH AS EMBEDDED MEDICAL DEVICES OFFERING WIRED AND/OR WIRELESS CONNECTIVITY TO TRANSFER AN INDIVIDUAL'S HEALTH DATA TO A DATA STORE THROUGH THE USE OF A GLOBAL COMPUTER NETWORK SITE, TELECOPIER, TELEPHONY, DATA ENABLED TELEPHONY SERVICES, MOBILE TELEPHONY OR MOBILE DATA ENABLED TELEPHONY SERVICES; PROVIDING SERVICES FOR PRIVATE HEALTH CARE PROFESSIONALS OR INSTITUTIONS AND GOVERNMENTAL HEALTHCARE PROFESSIONALS OR INSTITUTIONS TO ASSIST THE USER IN THE ELECTRONIC MANAGEMENT OF THEIR PRACTICE OR INSTITUTION AND ENABLING THE ELECTRONIC STORAGE OF THE PRACTICE'S OR INSTITUTION'S PATIENT DATA THROUGH THE USE OF A GLOBAL COMPUTER NETWORK SITE, TELECOPIER, TELEPHONY, DATA ENABLED TELEPHONY SERVICES, MOBILE TELEPHONY OR MOBILE DATA ENABLED TELEPHONY SERVICES (U.S. CLS. 100 AND 105).

SN 76-466,235. MR4 INFOMED INC., MONTREAL, (QUEBEC), CANADA, FILED 11-12-2002.

EPERSCRIBO

PRIORITY CLAIMED UNDER SEC. 44(D) ON CANADA APPLICATION NO. 1140760, FILED 5-10-2002, REG. NO. 665991, DATED 6-14-2006, EXPIRES 6-15-2021.

CLASS 9—ELECTRICAL AND SCIENTIFIC APPARATUS

FOR COMPUTER SOFTWARE FOR USE BY PRIVATE HEALTH CARE PROFESSIONALS OR INSTITUTIONS AND GOVERNMENTAL HEALTHCARE PROFESSIONALS OR INSTITUTIONS TO ASSIST THE USER IN THE ELECTRONIC MANAGEMENT OF PATIENT DATA, BILLING INFORMATION, APPOINTMENTS, PRESCRIPTIONS, MEDICAL EQUIPMENT AND ACCOUNTING DATA AND ENABLING THE ELECTRONIC STORAGE OF THE AFOREMENTIONED INFORMATION (U.S. CLS. 21, 23, 26, 36 AND 38).

CLASS 38—COMMUNICATION

FOR PROVIDING SERVICES, FOR INDIVIDUALS, COMPANIES, CORPORATIONS, INSURERS, PRIVATE HEALTH CARE PROFESSIONALS OR INSTITUTIONS AND GOVERNMENTAL HEALTHCARE PROFESSIONALS OR INSTITUTIONS, FOR ELECTRONICALLY CAPTURING, RECORDING AND ACCESSING HEALTHCARE DATA OF A PERSON'S HEALTH CONDITION, VITAL SIGNS, EXERCISE LEVELS AND DIETARY PATTERNS THROUGH THE USE OF SUITABLE MEDICAL DEVICES SUCH AS EMBEDDED MEDICAL DEVICES OFFERING WIRED AND/OR WIRELESS CONNECTIVITY TO TRANSFER AN INDIVIDUAL'S HEALTH DATA TO A DATA STORE THROUGH THE USE OF A GLOBAL COMPUTER NETWORK SITE, TELECOPIER, TELEPHONY, DATA ENABLED TELEPHONY SERVICES, MOBILE TELEPHONY OR MOBILE DATA ENABLED TELEPHONY SERVICES (U.S. CLS. 100, 101 AND 104).

CLASS 42—SCIENTIFIC, COMPUTER AND LEGAL SERVICES

FOR PROVIDING SERVICES TO PRIVATE HEALTH CARE PROFESSIONALS OR INSTITUTIONS AND GOVERNMENTAL HEALTHCARE PROFESSIONALS OR INSTITUTIONS, TO ENABLE MEDICATIONS TO BE ELECTRONICALLY PRESCRIBED AND MONITOR THE DISPENSING AND UTILIZATION OF THOSE MEDICATIONS THROUGH THE USE OF A GLOBAL COMPUTER NETWORK SITE, TELECOPIER, TELEPHONY, DATA ENABLED TELEPHONY SERVICES, MOBILE TELEPHONY OR MOBILE DATA ENABLED TELEPHONY SERVICES (U.S. CLS. 100 AND 101).

STEPHANIE DAVIS, EXAMINING ATTORNEY

SN 76-475,997. VISION BIOSYSTEMS LIMITED, MOUNT WAVERLEY, VICTORIA 3149, AUSTRALIA, FILED 12-13-2002.



PRIORITY CLAIMED UNDER SEC. 44(D) ON AUSTRALIA APPLICATION NO. 916,998, FILED 6-19-2002, REG. NO. 916998, DATED 6-19-2002, EXPIRES 6-19-2012.

CLASS 5—PHARMACEUTICALS

FOR PHARMACEUTICAL PREPARATIONS, NAMELY REAGENTS FOR MEDICAL AND DIAGNOSTIC PURPOSES; DIAGNOSTIC PREPARATIONS; DIAGNOSTIC REAGENTS CONTAINING PRIMARY ANTIBODIES; DIAGNOSTIC REAGENTS FOR IMMUNO-HISTOCHEMISTRY DETECTION AND IN-SITU HYBRIDIZATION DETECTION; DIAGNOSTIC PREPARATIONS KNOWN AS IN-SITU HYBRIDIZATION PROBES; DIAGNOSTIC EPITOPE RETRIEVAL SOLUTIONS; ENZYMES AND ENZYME PREPARATIONS FOR MEDICAL AND DIAGNOSTIC PURPOSES; DIAGNOSTIC HISTOLOGICAL DYE AND STAIN SOLUTIONS; DIAGNOSTIC DEWAXING AND WASH BUFFERS USED AS ADDITIVES IN THE AFOREMENTIONED PREPARATIONS (U.S. CLS. 6, 18, 44, 46, 51 AND 52).

CLASS 10—MEDICAL APPARATUS

FOR DIAGNOSTIC MEDICAL APPARATUS AND INSTRUMENTS, NAMELY— DIAGNOSTIC MEDICAL APPARATUS FOR PERFORMING IMMUNO-HISTOCHEMISTRY AND IN-SITU HYBRIDIZATION STAINING REACTIONS, AND HISTOLOGICAL AND PATHOLOGICAL STAINING; DIAGNOSTIC MEDICAL APPARATUS FOR PROMOTING AND CONTROLLING REACTION ON MICROARRAYS OR UNDER SLIDE COVERTILES (U.S. CLS. 26, 39 AND 44).

HOWARD B. LEVINE, EXAMINING ATTORNEY

SN 76-527,971. MIZRACHI Y CIA. DE MEXICO, S.A. DE C.V., MIGUEL HIDALGO C.P. 11230, MEXICO, FILED 7-7-2003.



SN 76-497,367. PETROLEO BRASILEIRO S/A - PETROBRAS, RIO DE JANEIRO, RJ, BRAZIL, FILED 3-12-2003.



OWNER OF ARGENTINA REG. NO. 1967230, DATED 1-15-2004, EXPIRES 1-15-2014.

OWNER OF ARGENTINA REG. NO. 1967229, DATED 1-15-2004, EXPIRES 1-15-2014.

OWNER OF ARGENTINA REG. NO. 1967228, DATED 1-15-2004, EXPIRES 1-15-2014.

NO CLAIM IS MADE TO THE EXCLUSIVE RIGHT TO USE "CENTER", APART FROM THE MARK AS SHOWN.

THE COLOR(S) ROYAL, DARK BLUE, AQUA AND LIGHT BLUE IS/ARE CLAIMED AS A FEATURE OF THE MARK.

THE MARK FEATURES THE COLORS ROYAL OR DARK BLUE, LIGHT OR AQUA BLUE AND WHITE. THE ROYAL OR DARK BLUE COLOR IS REPRESENTED BY THE DARKEST PORTIONS OF THE DESIGN, NAMELY IN THE LEFT TWO-THIRDS OF THE CARRIER AND SMALL SECTIONS OF THE DESIGN IN THE RIGHT SIDE OF THE CARRIER; THE AQUA OR LIGHT BLUE COLOR IS REPRESENTED BY THE SHADING IN THE DESIGN, NAMELY IN THE WORD CENTER AND ABOUT ONE-THIRD OF THE RIGHT SIDE OF THE CARRIER; THE WHITE IN THE DESIGN APPEARS AS WHITE.

CLASS 4—LUBRICANTS AND FUELS

FOR FUEL FOR MOTOR VEHICLES, NAMELY GASOLINE AND DIESEL FUEL; LUBRICANTS IN THE AUTOMOTIVE FIELD (U.S. CLS. 1, 6 AND 15).

CLASS 35—ADVERTISING AND BUSINESS

FOR TWENTY-FOUR HOUR RETAIL CONVENIENCE STORES IN GAS STATIONS (U.S. CLS. 100, 101 AND 102).

CLASS 37—CONSTRUCTION AND REPAIR

FOR REPAIR, MAINTENANCE AND CLEANING SERVICES RELATING TO VEHICLES, ENGINES AND THEIR PARTS (U.S. CLS. 100, 103 AND 106).

TONI HICKEY, EXAMINING ATTORNEY

NO CLAIM IS MADE TO THE EXCLUSIVE RIGHT TO USE "AUDIO", APART FROM THE MARK AS SHOWN.

THE MARK CONSISTS OF TWO "X"'S WITH THE STYLIZED WORDS "X-MAX" ACROSS THE MIDDLE. THE STYLIZED TERM "AUDIO" IS SHOWN IN AN OVAL BENEATH THE TERM "X-MAX".

CLASS 9—ELECTRICAL AND SCIENTIFIC APPARATUS

FOR RADIOS FOR VEHICLES; CABLES AND ACCESSORIES FOR AUDIO INSTALLATION IN AUTOMOBILES, NAMELY, CURRENT DISTRIBUTORS, FUSE HOLDERS, FUSES, ELECTRIC BATTERY TERMINALS, TERMINALS FOR INSTALLATION OF AUTOSOUND AMPLIFIERS, CAPACITORS, CURRENT CONVERTERS AND CONNECTORS; INSTALLATION KITS FOR AUTOSOUND AMPLIFIERS COMPRISED OF VARIOUS CABLES AND CABLE HOLDERS, CONNECTORS, FUSES AND FUSE HOLDERS, AND VARIOUS TYPES OF TERMINALS; BATTERIES; SPEAKER WIRES AND CURRENT WIRES; REMOTE CONTROLS; AMPLIFIERS FOR SOUND EQUIPMENT FOR AUTOMOBILES (U.S. CLS. 21, 23, 26, 36 AND 38).

CLASS 12—VEHICLES

FOR MOUNTED AND UNMOUNTED ELECTRIC HORNS FOR AUTOMOBILES (U.S. CLS. 19, 21, 23, 31, 35 AND 44).

DAVID TAYLOR, EXAMINING ATTORNEY

SN 76-535,012. MIAMI DOLPHINS, LTD., DAVIE, FL. FILED 8-6-2003.



OWNER OF U.S. REG. NOS. 991,673, 1,864,650 AND OTHERS.

NO CLAIM IS MADE TO THE EXCLUSIVE RIGHT TO USE "THE NUMERALS 03 AND THE REPRESENTATION OF THE OUTLINE OF A FOOTBALL JERSEY", APART FROM THE MARK AS SHOWN.

THE COLOR(S) AQUA, ORANGE, NAVY AND WHITE IS/ARE CLAIMED AS A FEATURE OF THE MARK.

THE MARK CONSISTS OF A PATTERNED DESIGN AND COLOR SCHEME OF A FOOTBALL JERSEY WITH AN

AQUA COLORED BACKGROUND SHOWING WHITE NUMBERS OUTLINED IN ORANGE AND SHADOWED IN NAVY THAT APPEAR IN DOTTED LINES ON BOTH THE CHEST AND ON THE INNER SHOULDERS OF THE JERSEY THAT ARE NOT CLAIMED AS A PART OF THE MARK BUT ARE ONLY USED TO SHOW PLACEMENT OF THE NUMBERS, WITH AN AQUA DOLPHIN HAVING A WHITE UNDERSIDE OUTLINED IN NAVY, WEARING A WHITE FOOTBALL HELMET CONTAINING AN ORANGE LETTER M AND THE DOLPHIN IS SUPERIMPOSED ON A WHITE CIRCLE WITH AN ORANGE SCALLOPED BORDER APPEARING ON EACH OUTER SLEEVE OF THE JERSEY, AND WITH A THIN NAVY STRIPE, WHITE STRIPE, THIN AQUA STRIPE, ORANGE STRIPE, NARROW AQUA STRIPE, WHITE STRIPE AND THIN NAVY STRIPE APPEARING IN THAT ORDER FROM THE INSIDE OUTWARDS ON THE OUTER EDGE OF EACH SLEEVE.
SEC. 2(F).

CLASS 25—CLOTHING

FOR MEN'S, WOMEN'S AND CHILDREN'S CLOTHING, NAMELY, JERSEYS (U.S. CLS. 22 AND 39).
FIRST USE 8-0-1997; IN COMMERCE 8-0-1997.

CLASS 41—EDUCATION AND ENTERTAINMENT

FOR EDUCATION AND ENTERTAINMENT SERVICES IN THE NATURE OF PROFESSIONAL FOOTBALL GAMES AND EXHIBITIONS; PROVIDING SPORTS AND ENTERTAINMENT INFORMATION VIA A GLOBAL COMPUTER NETWORK OR A COMMERCIAL ON-LINE SERVICE (U.S. CLS. 100, 101 AND 107).
FIRST USE 8-0-1997; IN COMMERCE 8-0-1997.
TONJA GASKINS, EXAMINING ATTORNEY

SN 76-535,013. MIAMI DOLPHINS, LTD., DAVIE, FL. FILED 8-6-2003.



OWNER OF U.S. REG. NOS. 991,673, 1,864,650 AND OTHERS.

NO CLAIM IS MADE TO THE EXCLUSIVE RIGHT TO USE THE NUMERALS "03" AND THE REPRESENTATION OF THE OUTLINE OF A FOOTBALL JERSEY, APART FROM THE MARK AS SHOWN.

THE COLOR(S) AQUA, ORANGE, NAVY, AND WHITE IS/ARE CLAIMED AS A FEATURE OF THE MARK.

THE MARK CONSISTS OF A PATTERNED DESIGN AND COLOR SCHEME OF A FOOTBALL JERSEY CONSISTING OF A WHITE COLORED BACKGROUND SHOWING AQUA NUMBERS OUTLINED IN ORANGE AND SHADOWED IN NAVY THAT APPEAR IN DOTTED LINES ON BOTH THE CHEST AND ON THE INNER SHOULDERS OF THE JERSEY THAT ARE NOT CLAIMED AS A PART OF THE MARK BUT ARE ONLY USED TO SHOW PLACEMENT OF THE NUMBERS, WITH AN AQUA DOLPHIN WITH A WHITE UNDERSIDE OUTLINED IN NAVY WEARING A WHITE FOOTBALL HELMET CONTAINING AN ORANGE LETTER M AND THE DOLPHIN IS SUPERIMPOSED ON A WHITE CIRCLE WITH AN ORANGE SCALLOPED BORDER APPEARING ON EACH OUTER SLEEVE OF THE JERSEY, AND WITH AN AQUA BAND APPEARING ON THE OUTER EDGE OF EACH SLEEVE AND THE COLLAR.

SEC. 2(F).

CLASS 25—CLOTHING

FOR MEN'S, WOMEN'S AND CHILDREN'S CLOTHING, NAMELY, JERSEYS (U.S. CLS. 22 AND 39).
FIRST USE 8-0-1997; IN COMMERCE 8-0-1997.

CLASS 41—EDUCATION AND ENTERTAINMENT

FOR EDUCATION AND ENTERTAINMENT SERVICES IN THE NATURE OF PROFESSIONAL FOOTBALL GAMES AND EXHIBITIONS; PROVIDING SPORTS AND ENTERTAINMENT INFORMATION VIA A GLOBAL COMPUTER NETWORK OR A COMMERCIAL ON-LINE SERVICE (U.S. CLS. 100, 101 AND 107).
FIRST USE 8-0-1997; IN COMMERCE 8-0-1997.
TONJA GASKINS, EXAMINING ATTORNEY

SN 76-548,243. PERKINELMER LAS, INC., WELLESLEY, MA. FILED 10-1-2003.

SPECTRAL CHIP

OWNER OF U.S. REG. NOS. 2,890,704, 3,110,799 AND 3,110,800.

NO CLAIM IS MADE TO THE EXCLUSIVE RIGHT TO USE "CHIP", APART FROM THE MARK AS SHOWN.

CLASS 1—CHEMICALS

FOR CHEMICAL PRODUCTS FOR SCIENTIFIC AND RESEARCH USE, NAMELY CHEMICALS AND KITS CONTAINING SUCH CHEMICALS, AND NUCLEIC ACID SEQUENCES FOR USE IN ANALYSIS OF BIOPOLYMERS AND BIOLOGICAL SAMPLES, DETECTING DISEASES, DETERMINING PROGRESSION OF DISEASES, AND DETERMINING DRUG RESPONSES (U.S. CLS. 1, 5, 6, 10, 26 AND 46).

CLASS 5—PHARMACEUTICALS

FOR PHARMACEUTICAL PRODUCTS FOR CLINICAL AND MEDICAL USE, NAMELY CHEMICALS, KITS CONTAINING CHEMICALS AND NUCLEIC ACID SEQUENCES FOR USE IN ANALYSIS OF BIOPOLYMERS AND BIOLOGICAL SAMPLES, DETECTING DISEASES, DETERMINING PROGRESSION OF DISEASES, AND DETERMINING DRUG RESPONSES; AND DIAGNOSTIC MEDICAL REAGENTS INCLUDING REAGENTS, PROCESSING CHEMICALS AND SOLID MATRIX MATERIALS FOR USE IN DIAGNOSING INFLAMMATORY, INFECTIOUS, CENTRAL NERVOUS SYSTEM, CARDIOVASCULAR, NEUROLOGICAL, ENDOCRINE, AUTOIMMUNE AND GENETIC DISEASES, DEVELOPMENTAL DISORDERS AND CANCER (U.S. CLS. 6, 18, 44, 46, 51 AND 52).

CLASS 9—ELECTRICAL AND SCIENTIFIC APPARATUS

FOR SCIENTIFIC MEASURING APPARATUS AND INSTRUMENTS, NAMELY SUBSTRATE DNA CHIPS AND GENOMIC ARRAYS OF NUCLEIC ACID SEQUENCES, POLYPEPTIDES, AND PROTEINS USED IN MEASUREMENT OF BIOPOLYMERS AND BIOLOGICAL SAMPLES AND IN GENOMIC ANALYSIS, GENOMIC HYBRIDIZATION, GENOMIC PROFILING, DNA COPY NUMBER ESTIMATION, GENE DUPLICATION AND DELETION DETECTION, AND TRANSCRIPT FACTOR COMPARISONS; COMPUTER HARDWARE AND SOFTWARE FOR ANALYZING IMAGES FOR ANALYSIS OF BIOPOLYMERS AND BIOLOGICAL SAMPLES (U.S. CLS. 21, 23, 26, 36 AND 38).

CLASS 42—SCIENTIFIC, COMPUTER AND LEGAL SERVICES

FOR TESTING AND ANALYSIS OF BIOPOLYMERS AND BIOLOGICAL SAMPLES FOR OTHERS; DESIGNING FOR OTHERS GENOMIC ARRAYS USED IN ANALYSIS OF BIOPOLYMERS AND BIOLOGICAL SAMPLES; DESIGNING CUSTOM ARRAYS FOR OTHERS; PROVIDING TECHNICAL SUPPORT, NAMELY TROUBLESHOOTING CUSTOMER PROBLEMS WITH ANALYSIS OF BIOPOLYMERS AND BIOLOGICAL SAMPLES AND CUSTOMER PROBLEMS WITH HARDWARE AND SOFTWARE FOR ANALYZING IMAGES FOR ANALYSIS OF BIOPOLYMERS AND BIOLOGICAL SAMPLES (U.S. CLS. 100 AND 101).

MICHELE SWAIN, EXAMINING ATTORNEY

SN 76-567,463. CONVERTING, INC., CLINTONVILLE, WI. FILED 12-16-2003.

OPALESSENCE

THE MARK CONSISTS OF STANDARD CHARACTERS WITHOUT CLAIM TO ANY PARTICULAR FONT, STYLE, SIZE, OR COLOR.

CLASS 16—PAPER GOODS AND PRINTED MATTER

FOR LAMINATED TABLE COVERS COMPOSED PRIMARILY OF PAPER TISSUE; PAPER DOILIES (U.S. CLS. 2, 5, 22, 23, 29, 37, 38 AND 50).

FIRST USE 11-17-2003; IN COMMERCE 11-17-2003.

CLASS 24—FABRICS

FOR PARTY FAVORS COMPRISED OF CIRCLES OF TULLE TO WRAP AROUND BIRD SEED FOR WEDDINGS OR OTHER OCCASIONS; PLASTIC TABLE COVERS, PLASTIC TABLE DECORATING ROLLS, PLASTIC ROLL TABLE CLOTHS, PLASTIC TABLE RUNNER AND CLOTH DOILIES (U.S. CLS. 42 AND 50).

FIRST USE 11-17-2003; IN COMMERCE 11-17-2003.

BARNEY CHARLON, EXAMINING ATTORNEY

SN 76-582,935. BELCO FOREST PRODUCTS, INC., TACOMA, WA. FILED 3-18-2004.

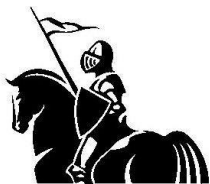

**ARMOR
COAT**

NO CLAIM IS MADE TO THE EXCLUSIVE RIGHT TO USE "COAT", APART FROM THE MARK AS SHOWN.

CLASS 19—NON-METALLIC BUILDING MATERIALS

FOR BUILDING MATERIALS, NAMELY, SEMI-WORKED WOOD FASCIA AND TRIM THAT IS FACTORY PRIMED AND PRE-STAINED (U.S. CLS. 1, 12, 33 AND 50).

FIRST USE 1-4-2004; IN COMMERCE 1-4-2004.

CLASS 35—ADVERTISING AND BUSINESS

FOR DISTRIBUTORSHIP SERVICES IN THE FIELD OF FACTORY PRIMED AND TREATED WOOD FASCIA AND TRIM BUILDING MATERIALS (U.S. CLS. 100, 101 AND 102).

FIRST USE 1-4-2004; IN COMMERCE 1-4-2004.

IRA J. GOODSaid, EXAMINING ATTORNEY

SN 76-587,906. EN VOGUE SCULPTURED NAIL SYSTEMS INC., LANGLEY, B.C. V2Y 1N2, CANADA, FILED 4-20-2004.

en Vogue

PRIORITY CLAIMED UNDER SEC. 44(D) ON ERP CMNTY TM OFC APPLICATION NO. 003445418, FILED 10-24-2003, REG. NO. 003445418, DATED 2-6-2006, EXPIRES 2-6-2016.

"THE FOREIGN WORDING IN THE MARK TRANSLATES INTO ENGLISH AS TO COME OR TO BE IN FASHION."

CLASS 3—COSMETICS AND CLEANING PREPARATIONS

FOR ADHESIVES USED FOR APPLYING ARTIFICIAL FINGERNAILS; NAIL VARNISH, NAIL CARE PRODUCTS, NAMELY, FALSE NAILS; ARTIFICIAL FINGERNAILS; NAIL GROOMING PRODUCTS, NAMELY, TIPS, GLUE, LACQUER, AND GLITTER, TOE AND FINGER SPACERS, NAIL POLISH PENS; TIPS, GLUE AND LACQUERS, ALL FOR NAIL GROOMING; ARTIFICIAL FINGERNAILS AND GLUE IN KIT FORM; EMERY BOARDS, EMERY PAPER, EMERY CLOTH AND EMERY, ALL FOR NAIL GROOMING; NAIL CARE PREPARATIONS, NAIL STRENGTHENING, REPAIR AND CONDITIONING PREPARATIONS, BRUSH-ON GELS AND RESINS FOR NAIL, CURABLE NAIL GELS; NAIL POLISH, NAIL VARNISH, NAIL BASE COATS, NAIL TOP COATS, QUICK DRY NAIL COATS; NAIL COATING REMOVERS; ARTIFICIAL NAILS; NAIL ADHESIVES, ADHESIVE TIP REMOVERS; FALSE NAIL ENAMEL REMOVERS; DEEP MOISTURISING LOTION FOR PEDICURES; NAIL FORMS; CUTICLE CREAM, REMOVERS AND OILS; PREPARATIONS AND SUBSTANCES ALL FOR THE HAIR, NAMELY, PREPARATIONS FOR COLOURING THE HAIR; PREPARATIONS FOR CONDITIONING THE HAIR; COSMETICS; CHEMICALS USED IN INDUSTRY AND PHOTOGRAPHY, IN PARTICULAR LIGHT HARDENING GEL FOR USE WITH GEL NAILS; ADHESIVES FOR ATTACHING ARTIFICIAL FINGERNAILS AND/OR EYELASHES (U.S. CLS. 1, 4, 6, 50, 51 AND 52).

CLASS 11—ENVIRONMENTAL CONTROL APPARATUS

FOR ULTRAVIOLET LAMPS NOT FOR MEDICAL PURPOSES (U.S. CLS. 13, 21, 23, 31 AND 34).

MARIA-VICTORIA SUAREZ, EXAMINING ATTORNEY

SN 76-593,489. PININFARINA EXTRA S.R.L., 10121 TORINO, ITALY, FILED 5-21-2004.

pininfarina

PRIORITY CLAIMED UNDER SEC. 44(D) ON ITALY APPLICATION NO. T02004C00147, FILED 5-14-2004, REG. NO. 1015172, DATED 7-11-2006, EXPIRES 5-14-2014.

OWNER OF U.S. REG. NOS. 1,854,151, 2,739,664 AND OTHERS.

CLASS 6—METAL GOODS

FOR METAL INSECT SCREENS AND STRUCTURAL AND REPLACEMENT PARTS THEREFORE; PARTS FOR TENTS, NAMELY, METAL TENT PEGS AND STAKES (U.S. CLS. 2, 12, 13, 14, 23, 25 AND 50).

CLASS 20—FURNITURE AND ARTICLES NOT OTHERWISE CLASSIFIED

FOR DRAPERY HARDWARE, NAMELY, CURTAIN HOOKS, CURTAIN RAILS, NON-METAL CURTAIN RINGS, CURTAIN RODS, NON-METAL CURTAIN TIEBACKS AND CURTAIN ROLLERS; CURTAIN HOLDERS, NOT OF TEXTILE MATERIAL, BAMBOO CURTAINS, DECORATIVE BEADED CURTAINS (U.S. CLS. 2, 13, 22, 25, 32 AND 50).

CLASS 22—CORDAGE AND FIBERS

FOR TENTS (U.S. CLS. 1, 2, 7, 19, 22, 42 AND 50).

CLASS 24—FABRICS

FOR CURTAINS AND FABRIC NETS FOR USE IN PREVENTING MOSQUITOES AND INSECTS FROM ENTERING A SPECIFIED AREA; CURTAINS AND FABRIC NETS FOR USE IN PREVENTING SUN ENTERING A SPECIFIED AREA; BEDSPREADS; TEXTILE CURTAIN HOLDS AND CURTAIN TIEBACKS (U.S. CLS. 42 AND 50).

CLASS 27—FLOOR COVERINGS

FOR CARPETS, RUGS, MATS AND MATTING FOR COVERING EXISTING FLOORS; WALLPAPER (U.S. CLS. 19, 20, 37, 42 AND 50).

KAREN BRACEY, EXAMINING ATTORNEY

SN 76-602,604. NEONLITE ELECTRONIC & LIGHTING (H.K.) LTD., TSIMSHATSUI, KOWLOON, HONG KONG, FILED 7-16-2004.

Ingenium

THE MARK CONSISTS OF STANDARD CHARACTERS WITHOUT CLAIM TO ANY PARTICULAR FONT, STYLE, SIZE, OR COLOR.

PRIORITY CLAIMED UNDER SEC. 44(D) ON FED REP GERMANY APPLICATION NO. 30402722.7, FILED 1-19-2004, REG. NO. 30402722, DATED 6-1-2004, EXPIRES 1-31-2014.

CLASS 9—ELECTRICAL AND SCIENTIFIC APPARATUS

FOR ELECTRIC, ELECTRONIC AND ELECTRO-TECHNICAL APPARATUS, DEVICES AND INSTRUMENTS, NAMELY, ELECTRIC CABLES AND WIRES, CIRCUIT BREAKERS, ELECTRIC SWITCHES, ELECTRICAL FUSES, ELECTRIC PLUGS AND SOCKETS, REMOTE FOR ELECTRIC CIRCUITS, REMOTE CONTROLS FOR RADIO AND TELEVISION SETS AND STEREO SETS, REMOTE CONTROLS FOR COMPUTER CURSORS, ELECTRIC LIGHT DIMMERS, ELECTRIC DISTRIBUTION BOXES, SWITCH BOXES, TELEPHONE WIRE AND CABLES, MAGNETIC TELEPHONE WIRE, TIMER SWITCHES, SAFETY CONTACT PLUGS, ELECTRICAL SWITCHGEAR, NAMELY, ENERGY SAVING DEVICES FOR LAMPS, FLUORESCENT LAMP BALLASTS FOR ELECTRIC LIGHTS; ELECTRICAL CONVERTERS AND TRANSFORMERS, COMPUTERS, DATA PROCESSING DEVICES AND ACCESSORIES, NAMELY, VIDEO MONITORS, KEYBOARDS FOR COMPUTER INPUT, ELECTRONIC MEMORY PRINTERS, AND MICE; COMPUTER PROGRAMS, NAMELY, BIOS PROGRAMS, DATABASE MANAGEMENT PROGRAMS, SPREADSHEET AND WORD PROCESSING PROGRAMS, COMPUTER GAME PROGRAMS, OPERATING SYSTEM PROGRAMS, PROGRAMS FOR DOCUMENT MANAGEMENT AND DATABASE MANAGEMENT, PROGRAMS FOR EDITING IMAGES, SOUND AND VIDEO, PROGRAMS FOR SEARCHING THE CONTENTS OF COMPUTERS AND COMPUTER NETWORKS BY REMOTE CONTROL, PROGRAMS FOR ACCESS CONTROL, PROGRAMS FOR DESIGNING AND AUTOMATING MANUFACTURING PROCESSES, CAD/CAM PROGRAMS, ELECTRONIC CASH REGISTER PROGRAMS, COMPUTER UTILITY PROGRAMS, PROGRAMS FOR USE IN DOWNLOADING FILMS AND TELEVISION PROGRAMS; COMPUTER SOFTWARE, NAMELY CHILDREN'S EDUCATIONAL PROGRAMS, COMMUNICATIONS SOFTWARE FOR CONNECTING NETWORK USERS, GLOBAL COMPUTER NETWORKS, AND FOR COMMUNICATING WITH USERS OF HANDHELD COMPUTERS; COMPUTER TELEPHONE SOFTWARE; SOFTWARE TO ALLOW CUSTOMERS TO ACCESS BANK ACCOUNT INFORMATION AND TO TRANSACT BANK BUSINESS, PROGRAMS TO ALLOW USERS TO TRANSACT BUSINESS TRANSACTIONS ON THE INTERNET, COMPUTER GRAPHICS SOFTWARE, SCREEN SAVER PROGRAMS, SOFTWARE FOR COMPUTER SEARCH ENGINES, COMPUTER SOFTWARE DEVELOPMENT TOOL PROGRAMS, SOFTWARE FOR USE IN ACCESSING INFORMATION DIRECTORIES ON THE INTERNET AND FOR CREATING SEARCHABLE DATABASES OF INFORMATION, SOFTWARE FOR INTERFACING WITH HAND-HELD COMPUTERS, PROGRAMS FOR PROCESSING OF DIGITAL MUSIC FILES, SOFTWARE FOR THE ADMINISTRATION OF LOCAL AREA NETWORKS, SOFTWARE FOR CONTROLLING AND MANAGING ACCESS SERVER APPLICATIONS, ENCRYPTION AND DECRYPTION SOFTWARE, SOFTWARE FOR PROGRAMMING FACSIMILE MACHINES, SOFTWARE FOR THE CREATION OF DIGITAL ANIMATION AND SPECIAL EFFECTS, SOFTWARE TO ENHANCE AND CONTROL AUDIO-VISUAL CAPABILITIES OF MULTIMEDIA APPLICATIONS AND TO IMPROVE AUDIO EQUIPMENT SOUND QUALITY, DATA COMPRESSION SOFTWARE, DESKTOP PUBLISHING SOFTWARE, SOFTWARE FOR CONTROLLING AND MONITORING THE PERFORMANCE OF ELEVATORS, SOFTWARE TO CONTROL BUILDING ENVIRONMENTAL, ACCESS AND SECURITY SYSTEMS, FACTORY AUTOMATION SOFTWARE TO INTEGRATE MACHINE OPERATIONS, AND TO GENERATE PRODUCTION REPORTS, SOFTWARE FOR INTEGRATING THE OUTPUT FROM A GPS RECEIVER TO THE MICROPHONE INPUT OF A DIGITAL CAMCORDER, INDUSTRIAL PROCESS CONTROL SOFTWARE, SOFTWARE FOR USE IN GENERATING READABLE MARKINGS FOR APPLICATION TO BOARD LUMBER, MUSIC COMPOSITION SOFTWARE, SOFTWARE FOR THE SECURITY OF ELECTRONIC MAIL, LAN OPERATING SOFTWARE, OPTICAL CHARACTER RECOGNITION SOFTWARE, USE OPERATING SOFTWARE, WIDE AREA NETWORK OPERATING SOFTWARE AND WEB SITE DEVELOPMENT SOFTWARE, PHOTOGRAPHIC PROJECTORS, MOTION PICTURE AND SLIDE PROJECTORS, LCD PROJECTORS FOR USE IN DISPLAYING ADVERTIS-

ING, AND MULTIMEDIA PROJECTORS; CONTROLLERS FOR MONITORING ELECTRIC LAMPS AND LAMP GUARDS (U.S. CLS. 21, 23, 26, 36 AND 38).

CLASS 11—ENVIRONMENTAL CONTROL APPARATUS

FOR LIGHTS FOR SHOWCASES, ELECTRIC RADIANT HEATERS, ELECTRIC HEATERS FOR COMMERCIAL USE, COOLING EVAPORATORS, ELECTRIC CLOTHES DRYERS FOR HOUSEHOLD USE, AIR CONDITIONERS; LASER LIGHT PROJECTORS; LAMPS, NAMELY LUMINARIES, ENERGY SAVING LAMPS, TABLE LAMPS, STREET LIGHTS, ARC LAMPS, DISCHARGE LAMPS AND THEIR FITTINGS, FILAMENTS FOR ELECTRIC LAMPS; FLUORESCENT LAMPS AND BULBS THEREFORE, LAMP BASES, LAMP REFLECTORS, OVERHEAD OUTDOOR LAMPS AND SAFETY LAMPS FOR USE UNDERGROUND, ELECTRIC LAMP SOCKETS; WATER STERILIZERS; ELECTRIC LIGHTS FOR PHOTOGRAPHIC USE (U.S. CLS. 13, 21, 23, 31 AND 34).

LESLEY LAMOTHE, EXAMINING ATTORNEY

SN 76-609,348, KABUSHIKI KAISHA SONY COMPUTER ENTERTAINMENT, TA SONY COMPUTER ENTERTAINMENT INC., MINATO-KU, TOKYO 107-0062, JAPAN, AND SONY KABUSHIKI KAISHA, TA SONY CORPORATION, TOKYO, JAPAN, FILED 8-30-2004.

xross media bar

THE MARK CONSISTS OF STANDARD CHARACTERS WITHOUT CLAIM TO ANY PARTICULAR FONT, STYLE, SIZE, OR COLOR.

OWNER OF AUSTRALIA REG. NO. 1010728, DATED 7-14-2004, EXPIRES 7-14-2014.

CLASS 9—ELECTRICAL AND SCIENTIFIC APPARATUS

FOR AUTOMATIC AND COIN-OPERATED SLOT MACHINES OTHER THAN THOSE ADAPTED FOR USE WITH AN EXTERNAL DISPLAY SCREEN OR MONITORS (U.S. CLS. 21, 23, 26, 36 AND 38).

CLASS 28—TOYS AND SPORTING GOODS

FOR PAINTBALLS FOR PAINTBALL GUNS; PAINTBALL GUNS; AMUSEMENT GAME MACHINES; ELECTRONIC EDUCATIONAL GAME MACHINES FOR CHILDREN; HAND HELD UNIT FOR PLAYING ELECTRONIC GAMES; GYMNASIAC APPARATUS; ARCHERY IMPLEMENTS, NAMELY, ARM GUARDS, ARROWS, ARROW FLETCHING DEVICES, BOWS, BOW CASES AND STRINGS, NON-TELESCOPIC BOW SIGHTS, QUIVERS; ARTIFICIAL FISHING BAIT; ARTIFICIAL SNOW FOR CHRISTMAS TREES; BACKGAMMON GAMES; BAGS FOR SKIS AND SURFBOARDS; BASKETBALLS; FOOTBALLS; HANDBALLS; BALLS FOR BASEBALL, BILLIARDS, BOCCIE, BOWLING, CRICKET, GOLF, LACROSSE, RUGBY, SOCCER, SOFTBALL, SQUASH AND TENNIS; SPORTS BALL BLADERS; BASEBALL, CRICKET, SOFTBALL AND TABLE TENNIS BATS; BASEBALL AND BATTING GLOVES; BILLIARD BALLS, CUES, MARKERS, CUSHIONS, TABLES, TALLY BALLS AND TIPS; CHRISTMAS TREE ORNAMENTS, NAMELY, BELLS; BINGO CARDS; FISHING BITE INDICATORS AND SENSORS; BOARD GAMES; BODY BOARDS; EXERCISE MACHINES; BOWLING PIN SETTERS AND PARTS THEREFORE, BALL RETURNS AND DEFLECTORS; BOXING GLOVES; TOY BUILDING BLOCKS; PLAYSET BUILDINGS; TOY BUTTERFLY NETS; CAPS FOR TOY PISTOLS; CHALK FOR BILLIARD CUES; CHECKERBOARDS; CHECKER SETS; CHESS GAMES;

CHESSBOARDS; CHEST EXPANDERS; CHRISTMAS TREE ORNAMENTS AND STANDS; ARTIFICIAL CHRISTMAS TREES; CLAY PIGEONS AND CLAY PIGEON TARGET LAUNCHERS; CLIMBERS' HARNESS; COIN-OPERATED BILLIARD TABLES; CONFETTI; MAGIC TRICKS; FISHING CREELS; BAGS SPECIALLY ADAPTED FOR CRICKET EQUIPMENT; DICE AND DICE CUPS; DARTS; DISCUSES; DIVOT REPAIR TOOLS; DOLLS; DOLLS' ACCESSORIES, CLOTHING, FURNITURE AND HOUSES; DOMINOES; DUMBBELLS; SKI EDGES; ELBOW GUARDS FOR ATHLETIC USE; ELECTRONIC TARGETS FOR GAMES; CHRISTMAS PARTY FAVORS IN THE NATURE OF CRACKERS; AMUSEMENT PARK RIDES; FENCING GAUNTLETS, MASKS, EPEE, FOILS AND SABRES; FISHING HOOKS, TACKLE, FLOATS, REELS, AND RODS; SWIMMING FLIPPERS; FLYING DISCS; BOWLING, BOXING, GOLF, HANDBALL, HOCKEY AND KARATE GLOVES; GOLF BAGS, CLUBS AND GLOVES; HAND-HELD ELECTRONIC GAMES WITH LIQUID CRYSTAL DISPLAYS; HANG GLIDERS; SAILBOARDS; SAILBOARD HARNESSES AND MASTS; SCUBA EQUIPMENT, NAMELY, SPEAR FISHING HARPOON GUNS; HOCKEY STICKS; HORSESHOES FOR RECREATION PURPOSES; HUNTING GAME CALLS; ICE SKATES; IN-LINE AND ROLLER SKATES; JIGSAW PUZZLES; KALEIDOSCOPES; KITE REELS; KITES; KNEE GUARDS FOR ATHLETIC USE; LANDING NETS FOR ANGLERS; FISHING LINES; HUNTING AND FISHING LURES; MAH-JONG GAMES; MARBLES; MARIONETTE PUPPETS; MEN'S ATHLETIC SUPPORTERS; TOY MOBILES; NETS FOR BALL GAMES; BOWLING PINS; PARAGLIDERS; PARLOR GAMES; CAPS FOR TOY PISTOLS; PINATAS; BALLOONS; PLAYGROUND BALLS; PLAYING CARDS; PLUSH TOYS; NOVELTY ITEMS, NAMELY, FAKE POOP AND TEETH; PROTECTIVE PADDINGS FOR PLAYING BASEBALL, BASKETBALL, FOOTBALL, HOCKEY AND SOCCER; PUNCHING BAGS; QUOITS; RACQUETBALL, SQUASH AND TENNIS RACKETS; RADIO CONTROLLED TOY VEHICLES; BABY RATTLES; RING GAMES; ROCKING HORSES; STATIONARY EXERCISE BICYCLES AND ROLLERS THEREFORE; ROSIN USED BY ATHLETES; ROULETTE WHEELS; SCALE MODEL AIRPLANES, BUSES, CARS AND TRUCKS; TOY SCOOTERS; SKI COVERS MADE OF SEAL SKIN; SHIN GUARDS FOR ATHLETIC USE; BADMINTON SHUTTLECOCKS; SKATEBOARDS; ICE SKATES; SKI BINDINGS, COVERS, SCRAPERS AND WAX; SKIS; SKITTLES; PLAYGROUND EQUIPMENT, NAMELY, SLIDES; SLING SHOTS; SNOW GLOBES AND SHOES; BUBBLE MAKING WAND AND SOLUTION SET; SPINNING TOPS; SPRING BOARDS; STARTING BLOCKS; RACKETS AND STRINGS FOR RACKETS; SURF BOARDS LEASHES THEREFORE; SURF SKIS; PLAY SWIMMING POOLS; SWING SETS; GAME TABLES FOR FOOTBALL; TABLE TENNIS NETS AND TABLES; TARGETS; TEDDY BEARS; TENNIS TRAINING APPARATUS USED TO HURL TENNIS BALLS; TENNIS NETS; THEATRICAL FACE MASKS; COSTUME AND TOY MASKS; TOY PISTOLS AND VEHICLES; ELECTRIC AND MECHANICAL ACTION TOYS; PET TOYS; TWIRLING BATONS; WATER SKIS; WEIGHT LIFTING BELTS (U.S. CLS. 22, 23, 38 AND 50).

IRA J. GOODSAD, EXAMINING ATTORNEY

SN 76-610,057, HYDAC ACCESSORIES GMBH, D-66280 SULZBACH/SAAR, FED REP GERMANY, FILED 9-3-2004.

HYBOX

PRIORITY CLAIMED UNDER SEC. 44(D) ON ERPN CMNTY TM OFC APPLICATION NO. 003702181, FILED 3-9-2004, REG. NO. 003702181, DATED 3-8-2005, EXPIRES 3-8-2015.

CLASS 6—METAL GOODS

FOR GOODS OF METALWORK AND IRONMONGERY NAMELY, SCREWS; MOUNTING PARTS AND FITTINGS OF METAL FOR FASTENING STORAGE UNITS, FILTERS, VALVES, AND CONTROL BLOCKS AS WELL AS GAS, LIQUID AND ELECTRIC CONDUITS, CONTROL AND SAFETY FITTINGS FOR GAS OR LIQUID MACHINERY AND FOR GAS OR LIQUID CONDUITS, METAL FASTENERS, NAMELY COLLARS FOR FASTENING PIPES, COLLARS FOR FLEXIBLE TUBING, COLLARS OF METAL FOR CABLES, METAL IN THE NATURE OF BAND-TYPE CARRIER DEVICES, CARRIER CONSOLES, CHANNEL-TYPE PIPE GUIDING COLLARS FOR USE IN HOLDING PROXIMITY SWITCHES AND LIGHT BARRIERS; METAL PIPE COLLARS AND METAL HYDRAULIC FLUID TANKS (U.S. CLS. 2, 12, 13, 14, 23, 25 AND 50).

CLASS 7—MACHINERY

FOR HYDROPNEUMATIC STORAGE UNITS BEING MACHINE PARTS; HYDRAULIC, HYDROPNEUMATIC AND REFLECTIVE SOUND, VIBRATION AND PRESSURE DAMPERS; FILTERS AND MEMBRANE FILTERS BEING MACHINE PARTS FOR FILTERS AND MEMBRANE FILTERS, BEING MACHINE PARTS FOR PRODUCTION AND MINING MACHINING, PULP AND PAPER INDUSTRY, LUBRICATION SYSTEMS, TEST RIGS AND ENERGY INDUSTRY AND FOR FUEL, OIL AND WATER FOR LAND, AIR AND WATER VEHICLES; FILTER APPARATUS, FILTER EQUIPMENT AND FILTER INSTALLATIONS, FILTER ELEMENTS AND MEMBRANE OF ELASTOMERIC POLYMERS FOR INDUSTRIAL TEXTILE APPLICATIONS; FILTERS BEING PARTS OF PRODUCTION MACHINES, MINING MACHINES, PULP AND PAPER MACHINES AND TEST MACHINES, VEHICLES AND MOTORS FOR FILTERING LIQUIDS AND/OR GASES OF DIFFERING VISCOSITY AND COMPOSITION; SHUT-OFF EQUIPMENT, SHUT-OFF APPARATUS, STOP VALVES AND VALVES BEING PARTS OF MACHINES AND VEHICLES, IN PARTICULAR FOR HYDRAULIC AND PNEUMATIC INSTALLATIONS, IN PARTICULAR TRANSITION COILS AND CONTROL BLOCKS; HYDRAULIC AND PNEUMATIC CONTROL UNITS CONSISTING OF AT LEAST ONE OF THE FOLLOWING; DIRECTIONAL CONTROL VALVES, PRESSURE VALVES AND FLOW CONTROL VALVES; HYDRAULIC OR PNEUMATIC OPERATING CYLINDERS BEING PARTS OF MACHINES; HYDRAULIC OR PNEUMATIC DRIVE UNITS FOR LAND, AIR AND WATER VEHICLES AND BEING PARTS OF MACHINES USED FOR MATERIALS PROCESSING FOR GENERAL MACHINE CONSTRUCTION; HYDRAULIC OR PNEUMATIC DRIVE UNITS FOR LAND, AIR AND WATER VEHICLES AND BEING PARTS OF CONSTRUCTION MACHINES, MACHINE TOLLS, MACHINES FOR MANUFACTURING PLASTICS, DRIVES FOR TOOLS, PRESSES, TRANSPORT MACHINERY, NAMELY LOADING CRANES AND FORK LIFT TRUCKS, SEA AND AIR TRAVEL MACHINES, NAMELY BOATS AND AIR PLANES, CHEMICAL PLANTS, REACTOR MACHINES, MINING, IRON AND STEEL WORKS, AND ROLLING MILLS, CONSISTING OF AT LEAST ONE HYDRAULIC PUMP, AT LEAST ONE DRIVE MOTOR AND AT LEAST ONE CONTAINER OF METAL OR PLASTIC FOR LIQUIDS; HYDRAULIC MOTORS, LUBRICATING APPARATUS AND EQUIPMENT, LUBRICATING INSTALLATIONS, AND LUBRICATING SUPPLY APPARATUS, IN PARTICULAR DISTRIBUTORS FOR FUEL AND/OR OIL FOR STATIONARY AND MOBILE APPLICATION; MECHANICALLY OPERATED CLAMPING APPARATUS, CLAMPING MACHINES AND METAL CLAMPS USED FOR HOLDING PIECE PARTS ON MACHINE TOOL TABLES; ADJUSTABLE AND NON-ADJUSTABLE HAND OPERATED OR MOTOR DRIVEN HYDRAULIC PRESSURE AND FEED PUMPS; MECHANICAL INSTRUMENTS, DEVICES AND EQUIPMENT PARTS FOR MANUFACTURING AND ENGINEERING, NAMELY, METAL EXTRUSION PRESSES; HYDRAULIC DRIVE UNITS FOR ELEVATOR AND LIFT OPERATING APPARATUS, IN PARTICULAR

CONSISTING OF A HYDRAULIC PUMP, A DRIVE MOTOR AND A CONTAINER OF METAL OR PLASTIC FOR LIQUIDS; HYDRAULIC AGGREGATES AS MODULAR CONSTRUCTION, IN PARTICULAR CONSISTING OF ONE HYDRAULIC TANK, ONE HYDROPNEUMATIC ACCUMULATOR, AT LEAST ONE FILTER, ONE HYDRAULIC PUMP, ONE DRIVING MOTOR AS WELL AS ONE CONTROL BLOCK FOR RECORDING OF DIRECTIONAL CONTROL VALVES, PRESSURE VALVES AND FLOW CONTROL VALVES (U.S. CLS. 13, 19, 21, 23, 31, 34 AND 35).

CLASS 9—ELECTRICAL AND SCIENTIFIC APPARATUS

FOR CONTROL APPARATUS AND INSTRUMENTS FOR ELEVATOR AND LIFT OPERATING APPARATUS AS WELL AS FOR LIFT STAGES AND LIFTING PLATFORMS; RESONATORS; INDICATOR, MONITOR AND CONTROL APPARATUS FOR LEVEL, PRESSURE, TEMPERATURE AND QUANTITY FOR GASES AND LIQUIDS; MANOMETER AND MANOMETER MONITORING SWITCHES; SWITCHING APPARATUS IN THE NATURE OF PUSH SWITCHES AND TRANSMITTERS, MONITORS AND DIAGNOSTIC APPARATUS FOR TECHNICAL APPLICATIONS, NAMELY PRESSURE, WEIGHT, VOLUME, TEMPERATURE AND ANALYSIS SENSORS, IN PARTICULAR FOR PHYSICAL, ELECTRONIC OR CHEMICO-ELECTRONIC STIMULI; INDIVIDUAL PARTS FOR ELECTRONIC APPARATUS, IN PARTICULAR LOGICAL ELEMENTS, ELECTROTECHNICAL AND ELECTRONIC COMPONENT PARTS AND UNITS CONSISTING THEREOF IN PARTICULAR PRINTED CIRCUITS, SEMI-CONDUCTOR COMPONENT PARTS, INTEGRATED CIRCUITS, ELECTRONIC AND COMPUTER MEMORY COMPONENTS, RESISTORS, AND MICROPROCESSORS; CIRCUIT BOARDS WITH ELECTROTECHNICAL AND ELECTRONIC UNITS AND COMPONENT PARTS OF COMPUTERS AND DATA PROCESSING INSTALLATIONS; ELECTRIC AND ELECTRONIC INSTALLATIONS IN THE NATURE OF ELECTRONIC CIRCUITS FOR MONITORING, TESTING AND CONTROLLING INDUSTRIAL WORKING PROCESSES, APPARATUS AND INSTRUMENTS IN LAND, AIR AND WATER VEHICLES, IN PARTICULAR SEMI-CONDUCTOR BUILDING ELEMENTS; COMPUTER PERIPHERALS FOR THE ACQUISITION, DISPLAY, OUTPUT AND TRANSMISSION OF DATA AND FOR MANUFACTURING AND PROCESS TECHNOLOGY; DATA PROCESSING COMPUTER PROGRAMS FOR THESE COMPUTERS RECORDED ON MACHINE-READABLE DATA CARRIERS, IN PARTICULAR MAGNETIC DISKS, TAPES AND DISKETTES; COMPUTER SOFTWARE FOR EVALUATING PRESSURE, TEMPERATURE AND VISCOSITY OF OIL IN THE INDUSTRIAL FIELD (U.S. CLS. 21, 23, 26, 36 AND 38).

CLASS 11—ENVIRONMENTAL CONTROL APPARATUS

FOR HEAT EXCHANGERS FOR STATIONARY AND MOBILE APPLICATIONS FOR EXCHANGING HEAT BETWEEN LIQUID AND/OR GASEOUS MEDIA; COOLING AND HEATING FACILITIES FOR LIQUID AND/OR GASEOUS MEDIA, NAMELY COOLERS AND HEATERS; HEAT EXCHANGERS BEING PARTS OF MACHINES FOR STATIONARY AND MOBILE APPLICATIONS FOR EXCHANGING HEAT BETWEEN LIQUID AND/OR GASEOUS MEDIA (U.S. CLS. 13, 21, 23, 31 AND 34).

MICHAEL KEATING, EXAMINING ATTORNEY

SN 76-616,831. FERRING B.V., 2132 JX HOOFDDORP, NETHERLANDS, FILED 10-20-2004.

SHARED CONFIDENCE

THE MARK CONSISTS OF STANDARD CHARACTERS WITHOUT CLAIM TO ANY PARTICULAR FONT, STYLE, SIZE, OR COLOR.

CLASS 5—PHARMACEUTICALS

FOR PHARMACEUTICAL PREPARATIONS FOR USE IN THE TREATMENT OF INFERTILITY (U.S. CLS. 6, 18, 44, 46, 51 AND 52).

CLASS 35—ADVERTISING AND BUSINESS

FOR ADMINISTRATION OF A DISCOUNT PROGRAM FOR ENABLING PARTICIPANTS TO OBTAIN DISCOUNTS ON FERTILITY TREATMENTS THROUGH MEMBERSHIP IN THE PROGRAM (U.S. CLS. 100, 101 AND 102).

STEVEN PEREZ, EXAMINING ATTORNEY

SN 76-620,254. PERO PACKING & SALES, INC., DELRAY BEACH, FL. FILED 11-12-2004.

TRAY SEALED FRESH VEGGIES

THE MARK CONSISTS OF STANDARD CHARACTERS WITHOUT CLAIM TO ANY PARTICULAR FONT, STYLE, SIZE, OR COLOR.

NO CLAIM IS MADE TO THE EXCLUSIVE RIGHT TO USE "FRESH VEGGIES", APART FROM THE MARK AS SHOWN.

CLASS 17—RUBBER GOODS

FOR PLASTIC FILM FOR USE AS PACKAGING FOR FRESH PRODUCE (U.S. CLS. 1, 5, 12, 13, 35 AND 50).

CLASS 20—FURNITURE AND ARTICLES NOT OTHERWISE CLASSIFIED

FOR TRAYS NOT OF PRECIOUS METAL FOR PACKAGING FRESH PRODUCE (U.S. CLS. 2, 13, 22, 25, 32 AND 50).

TIMOTHY FINNEGAN, EXAMINING ATTORNEY

SN 76-621,116. LANDAMERICA FINANCIAL GROUP, INC., RICHMOND, VA. FILED 11-17-2004.

LENDERXTRA

THE MARK CONSISTS OF STANDARD CHARACTERS WITHOUT CLAIM TO ANY PARTICULAR FONT, STYLE, SIZE, OR COLOR.

CLASS 35—ADVERTISING AND BUSINESS

FOR EMPLOYEE RELOCATION AND INFORMATION; TAX CONSULTATION CONCERNING LIKE-KIND PROPERTY EXCHANGES; LICENSING OF COMPUTER SOFTWARE; ADVERTISING AND MARKETING; BUSINESS MARKETING AND DIRECT MAIL CONSULTING SERVICES; BUSINESS MARKETING CONSULTING SERVICES; BUSINESS MARKETING SERVICES; DIRECT MARKETING ADVERTISING FOR OTHERS; DIRECT MARKETING SERVICES; ADVERTISING AND ADVERTISEMENT SERVICES; DISSEMINATION OF ADVERTISING MATTER; PROMOTING THE GOODS AND SERVICES OF OTHERS THROUGH THE DISTRIBUTION OF DISCOUNT CARDS; HUMAN RESOURCES MANAGEMENT; HUMAN RESOURCES CONSULTATION; COMPUTERIZED DATABASE MANAGEMENT IN THE REAL ESTATE FIELD; DATABASE MANAGEMENT; PREPARING FORMS FOR OTHERS IN THE FIELD OF REAL ESTATE; DOCUMENT COMPLETION FOR OTHERS (U.S. CLS. 100, 101 AND 102).

FIRST USE 9-6-2004; IN COMMERCE 9-6-2004.

CLASS 36—INSURANCE AND FINANCIAL

FOR REAL ESTATE APPRAISAL MANAGEMENT AND REAL ESTATE APPRAISAL INFORMATION SERVICES; REAL ESTATE APPRAISAL AND BROKERAGE; CREDIT INQUIRY AND CONSULTATION; REAL ESTATE TITLE INSURANCE UNDERWRITING; PROVIDING FINANCIAL INFORMATION IN THE NATURE OF CONSUMER LOAN INFORMATION; TAX PAYMENT PROCESSING SERVICES; PROVIDING PROPERTY TAX PAYMENT INFORMATION; UNDERWRITING ERRORS AND OMISSIONS INSURANCE; REAL ESTATE APPRAISAL AND INVESTMENT SERVICES; REAL ESTATE ESCROW RECONCILIATION SERVICES; MORTGAGE PROCESSING SERVICES; PROVIDING INFORMATION IN THE FIELD OF REAL ESTATE BY MEANS OF LINKING THE WEB SITE TO OTHER WEB SITES FEATURING REAL ESTATE INFORMATION; REAL ESTATE CONSULTATION; REAL ESTATE CONSULTANCY; PROVIDING ON-LINE NEWS IN THE REAL ESTATE FIELD (U.S. CLS. 100, 101 AND 102).

FIRST USE 9-6-2004; IN COMMERCE 9-6-2004.

CLASS 41—EDUCATION AND ENTERTAINMENT

FOR EDUCATIONAL SERVICES, NAMELY, CONDUCTING CLASSES, SEMINARS, CONFERENCES AND WORKSHOPS IN THE FIELD OF REAL ESTATE, MORTGAGE AND INSURANCE; PROVIDING ONLINE EDUCATIONAL SERVICES, NAMELY, CONDUCTING CLASSES, SEMINARS, CONFERENCES AND WORKSHOPS IN THE FIELD OF REAL ESTATE, MORTGAGE AND INSURANCE (U.S. CLS. 100, 101 AND 107).

FIRST USE 9-6-2004; IN COMMERCE 9-6-2004.

CLASS 42—SCIENTIFIC, COMPUTER AND LEGAL SERVICES

FOR INFORMATION TECHNOLOGY CONSULTATION SERVICES; TECHNICAL SUPPORT SERVICES, NAMELY, TROUBLESHOOTING OF COMPUTER HARDWARE AND SOFTWARE PROBLEMS; COMPUTER SOFTWARE DESIGN AND MAINTENANCE FOR OTHERS; EVALUATION OF REAL ESTATE TO DETERMINE IF IT IS LOCATED IN A FLOOD ZONE; REAL ESTATE CLOSING SERVICES; REAL ESTATE SETTLEMENT SERVICES; PROVIDING TEMPORARY USE OF NON-DOWNLOADABLE SOFTWARE IN THE REAL ESTATE FIELD FOR USE IN TITLE INSURANCE, TITLE AND ESCROW PRODUCTION, EMPLOYEE RELOCATION, CREDIT REPORTING, REAL ESTATE FLOOD ZONE DETERMINATION, REAL ESTATE APPRAISAL AND BROKERAGE, REAL ESTATE APPRAISAL MANAGEMENT, REAL ESTATE APPRAISAL INFORMATION, AND LIKE-KIND REAL ESTATE EXCHANGES (U.S. CLS. 100 AND 101).

FIRST USE 9-6-2004; IN COMMERCE 9-6-2004.
MELVIN AXILBUND, EXAMINING ATTORNEY

SN 76-625,270. LASTOVICKA, CHRIS, DBA AHARI PRESS,
PHILMONT, NY. FILED 12-20-2004.



NO CLAIM IS MADE TO THE EXCLUSIVE RIGHT TO
USE "PRESS", APART FROM THE MARK AS SHOWN.

**CLASS 9—ELECTRICAL AND SCIENTIFIC
APPARATUS**

FOR AUDIO AND SOUND RECORDINGS OF MUSIC
(U.S. CLS. 21, 23, 26, 36 AND 38).
FIRST USE 2-11-2005; IN COMMERCE 2-11-2005.

CLASS 35—ADVERTISING AND BUSINESS

FOR DISTRIBUTORSHIP SERVICES FEATURING
MUSICAL SOUND RECORDINGS AND MUSICAL VI-
DEO RECORDINGS; ONLINE DISTRIBUTORSHIP SER-
VICES FEATURING MUSICAL SOUND RECORDINGS
AND MUSICAL VIDEO RECORDINGS (U.S. CLS. 100,
101 AND 102).
FIRST USE 2-11-2005; IN COMMERCE 2-11-2005.
RUDY R. SINGLETON, EXAMINING ATTORNEY

SN 76-625,398. CITYPEEK, LLC, BALTIMORE, MD. FILED
12-23-2004.

CITYPEEK

THE MARK CONSISTS OF STANDARD CHARACTERS
WITHOUT CLAIM TO ANY PARTICULAR FONT, STYLE,
SIZE, OR COLOR.

CLASS 35—ADVERTISING AND BUSINESS

FOR TOURISM SERVICES THROUGHOUT THE UNI-
TED STATES; PROVIDING INFORMATION ABOUT
SHOPPING (U.S. CLS. 100, 101 AND 102).
FIRST USE 6-0-2004; IN COMMERCE 6-0-2004.

**CLASS 39—TRANSPORTATION AND STO-
RAGE**

FOR PROVIDING INFORMATION ABOUT TRANS-
PORTATION; TRAVEL INFORMATION SERVICES (U.S.
CLS. 100 AND 105).
FIRST USE 6-0-2004; IN COMMERCE 6-0-2004.

**CLASS 41—EDUCATION AND ENTERTAIN-
MENT**

FOR PROVIDING INFORMATION ABOUT ENTER-
TAINMENT, NAMELY CURRENT ENTERTAINMENT
EVENTS THROUGHOUT THE UNITED STATES (U.S.
CLS. 100, 101 AND 107).
FIRST USE 6-0-2004; IN COMMERCE 6-0-2004.

**CLASS 43—HOTEL AND RESTAURANT SER-
VICES**

FOR PROVIDING INFORMATION ABOUT DINING
AND LODGING (U.S. CLS. 100 AND 101).
FIRST USE 6-0-2004; IN COMMERCE 6-0-2004.
KIMBERLY PERRY, EXAMINING ATTORNEY

SN 76-626,341. JOB SAFETY BASICS, LLC, RIVERVIEW, MI.
FILED 12-30-2004.

PASSES EDGE

THE MARK CONSISTS OF STANDARD CHARACTERS
WITHOUT CLAIM TO ANY PARTICULAR FONT, STYLE,
SIZE, OR COLOR.

**CLASS 16—PAPER GOODS AND PRINTED
MATTER**

FOR EDUCATIONAL PUBLICATION, NAMELY,
SCIENCE CURRICULUM MANUALS, BOOKS AND
TRAINING MANUALS IN THE FIELD OF OCCUPA-
TIONAL AND WORKPLACE SAFETY FOR SCHOOLS,
HOSPITALS, INDUSTRY AND THE COMMUNITY;
MANUALS AND PRE-RECORDED CD-ROMS SOLD AS
A UNIT, BOTH FEATURING INFORMATION IN THE
FIELD OF OCCUPATIONAL AND WORKPLACE
SAFETY FOR SCHOOLS, HOSPITALS, INDUSTRY AND
THE COMMUNITY (U.S. CLS. 2, 5, 22, 23, 29, 37, 38 AND
50).
FIRST USE 7-22-1996; IN COMMERCE 9-14-1999.

**CLASS 41—EDUCATION AND ENTERTAIN-
MENT**

FOR EDUCATIONAL TRAINING SERVICES,
NAMELY, PROVIDING OCCUPATIONAL AND WORK-
PLACE SAFETY AWARENESS TRAINING AND DISTRI-
BUTING COURSE MATERIALS IN CONNECTION
THEREWITH (U.S. CLS. 100, 101 AND 107).
FIRST USE 7-22-1996; IN COMMERCE 9-14-1999.
CHRISTOPHER OTT, EXAMINING ATTORNEY

SN 76-626,963. PARKEON (SOCIÉTÉ PAR ACTIONS SIMPLI-
FIÉE), 75015 PARIS, FRANCE, FILED 1-5-2005.

NeOPS

THE MARK CONSISTS OF STANDARD CHARACTERS
WITHOUT CLAIM TO ANY PARTICULAR FONT, STYLE,
SIZE, OR COLOR.

CLASS 9—ELECTRICAL AND SCIENTIFIC APPARATUS

FOR COMPUTER TERMINALS FOR PARKING MANAGEMENT INCLUDING ELECTRONIC AND COMPUTERIZED PARKING TERMINALS AS PART OF CONSTRUCTIONS; PAY AND DISPLAY MACHINES, NAMELY, AUTOMATED STAND ALONE VENUE FOR MOTOR VEHICLE PARKING LOT MANAGEMENT, NAMELY, A DEVICE WHICH RECEIVES PAYMENT VIA A CARD OR COIN, ISSUES RECEIPT AND AUTHORIZATION TICKETS AND TRACKS THE ALLOCATION OF PARKING SERVICES WITHIN A DEFINED GEOGRAPHIC AREA; PRINTED ELECTRONIC PARKING TICKETS; ELECTRONIC APPARATUS FOR VEHICLE PARKING MANAGEMENT FOR STREETS AND/OR CLOSED CAR PARKS AND INCLUDING MONEY OPERATED MACHINES, NAMELY, PARKING METERS, PARKING TICKET VENDING MACHINES, MACHINES WHICH ACCEPT MONEY TO ALLOW INGRESS AND EGRESS, ELECTRONIC APPARATUS FOR ACCESS CONTROL FOR CAR PARKS; COMPUTER TERMINALS FOR CAR PARK MANAGEMENT; ELECTRONIC APPARATUS FOR COMMUNICATION BETWEEN PAY AND DISPLAY MACHINES AND A CENTRAL COMPUTER, ELECTRONIC COMMUNICATION APPARATUS THAT IS INSTALLED IN PARKING PAY AND DISPLAY MACHINES FOR WIRELESS COMMUNICATIONS BETWEEN THE PAYOR AND PAYEE (U.S. CLS. 21, 23, 26, 36 AND 38).

CLASS 37—CONSTRUCTION AND REPAIR

FOR MAINTENANCE SERVICES OF THE PARKING TERMINALS, PARKING METERS, TIME STAMPS, ELECTRONIC DEVICES FOR MANAGING CAR PARKING, ELECTRONIC DEVICES FOR SAFE ACCESS TO THE DEVICES FOR MANAGING CAR PARKING, ELECTRONIC DEVICES TO CONTROL ACCESS TO THE CAR PARKS, ELECTRONIC COMMUNICATION DEVICES BETWEEN THE TIME STAMPS AND A CENTRAL COMPUTER, ELECTRONIC COMMUNICATION DEVICES INTENDED TO BE INSTALLED IN THE TIME STAMPS, ELECTRONIC DEVICES FOR DELIVERING PUBLIC TRANSPORT TICKETS, ELECTRONIC READING/WRITING DEVICES FOR MEMORY CARDS USED FOR THE PARKING TERMINALS, THE PARKING METERS, THE TIME STAMPS, THE ELECTRONIC DEVICE FOR DELIVERING PUBLIC TRANSPORT TICKETS (U.S. CLS. 100, 103 AND 106).

CLASS 38—COMMUNICATION

FOR ELECTRONIC DATA TRANSMISSION SERVICES FOR PARKING TERMINALS, PARKING METERS, PAY AND DISPLAY MACHINES, AUTOMATED PAY STATIONS FOR CAR PARKS AND ELECTRONIC APPARATUS FOR ISSUING PUBLIC TRANSPORT DOCUMENTS TO A SERVER CENTER FOR REAL-TIME MANAGEMENT OF CAR PARKS AND SEATS ON PUBLIC TRANSPORT (U.S. CLS. 100, 101 AND 104).

CLASS 39—TRANSPORTATION AND STORAGE

FOR CAR PARKING SERVICES; RESERVATION SERVICES FOR PUBLIC TRANSPORT DOCUMENTS BY MEANS OF AUTOMATIC ELECTRONIC APPARATUS; TRANSPORTATION RESERVATION SERVICES FOR PUBLIC TRANSPORT (U.S. CLS. 100 AND 105).

CLASS 42—SCIENTIFIC, COMPUTER AND LEGAL SERVICES

FOR DESIGN AND DEVELOPMENT OF SOFTWARE AND DATABASES FOR OPERATING OR CONTROLLING APPARATUS FOR VEHICLE PARKING MANAGEMENT, APPARATUS FOR ISSUING PUBLIC TRANSPORT DOCUMENTS, UPDATING SERVICES FOR SUCH SOFTWARE, UPDATING SERVICES FOR SUCH DATABASES CARRIED OUT BY COMPUTER SPECIALISTS; COMPUTER PROGRAMMING SERVICES FOR ELECTRONIC MEMORY CARDS FOR APPARATUS FOR VEHICLE PARKING MANAGEMENT (U.S. CLS. 100 AND 101).

SANJEEV VOHRA, EXAMINING ATTORNEY

SN 76-627,934, NATIONAL QUALITY FORUM, WASHINGTON, DC. FILED 1-14-2005.

NQF-ENDORSED

THE MARK CONSISTS OF STANDARD CHARACTERS WITHOUT CLAIM TO ANY PARTICULAR FONT, STYLE, SIZE, OR COLOR.

CLASS 9—ELECTRICAL AND SCIENTIFIC APPARATUS

FOR DOWNLOADABLE ELECTRONIC PUBLICATIONS IN THE NATURE OF REPORTS IN THE FIELD OF HEALTHCARE QUALITY MEASUREMENT AND REPORTING; AND ELECTRONIC PUBLICATIONS, NAMELY, REPORTS IN THE FIELD OF HEALTHCARE QUALITY MEASUREMENT RECORDED ON COMPUTER MEDIA (U.S. CLS. 21, 23, 26, 36 AND 38).

CLASS 16—PAPER GOODS AND PRINTED MATTER

FOR PRINTED PUBLICATIONS IN THE FIELD OF HEALTHCARE QUALITY MEASUREMENT AND REPORTING, NAMELY NEWSLETTERS, REPORTS, PAMPHLETS, BROCHURES AND POSTERS RELATED TO DEVELOPING AND IMPLEMENTING CONSENSUS-BASED NATIONAL STANDARDS FOR HEALTHCARE PERFORMANCE (U.S. CLS. 2, 5, 22, 23, 29, 37, 38 AND 50).

CLASS 35—ADVERTISING AND BUSINESS

FOR CONDUCTING QUALITY ASSURANCE SURVEYS ON THE USE OF THE STANDARDS AND PRACTICES OF HOSPITALS, NURSING HOMES, PHYSICIAN'S PRACTICES, AND OTHER HEALTHCARE PROVIDERS TO DETERMINE SERVICE QUALITY (U.S. CLS. 100, 101 AND 102).

CLASS 41—EDUCATION AND ENTERTAINMENT

FOR EDUCATIONAL SERVICES IN THE FIELD OF HEALTHCARE QUALITY MEASUREMENT, NAMELY CONDUCTING SEMINARS, CONFERENCES, MEETINGS AND WORKSHOPS TO DEVELOP AND IMPLEMENT CONSENSUS-BASED NATIONAL STANDARDS FOR HEALTHCARE PERFORMANCE AND DISTRIBUTING COURSE MATERIALS IN CONNECTION THEREWITH; PUBLICATION OF PRINTED MATTER, NAMELY, NEWSLETTERS, REPORTS, PAMPHLETS, BROCHURES AND POSTERS RELATED TO DEVELOPING AND IMPLEMENTING CONSENSUS BASED NATIONAL STANDARDS FOR HEALTHCARE PERFORMANCE; ON-LINE PUBLICATION OF NEWSLETTERS AND REPORTS RELATED TO DEVELOPING AND IMPLEMENTING CONSENSUS-BASED NATIONAL STANDARDS FOR HEALTHCARE PERFORMANCE; AND PROVIDING NEWSLETTERS AND EXECUTIVE SUMMARIES IN THE FIELD OF HEALTHCARE QUALITY MEASUREMENT AND REPORTING VIA E-MAIL (U.S. CLS. 100, 101 AND 107).

CLASS 42—SCIENTIFIC, COMPUTER AND LEGAL SERVICES

FOR PROVIDING QUALITY ASSURANCE SERVICES IN THE FIELD OF HEALTHCARE, NAMELY, REVIEWING STANDARDS AND PRACTICES IN THE FIELD OF HEALTHCARE TO DEVELOP AND IMPLEMENT NATIONAL VOLUNTARY CONSENSUS-BASED STANDARDS FOR HEALTHCARE QUALITY MEASUREMENT; ACCREDITATION SERVICES, NAMELY, REVIEWING, ANALYZING AND EVALUATING STANDARDS AND PRACTICES IN THE FIELD OF HEALTHCARE FOR THE PURPOSE OF CERTIFICATION; AND PROVIDING ONLINE INFORMATION ABOUT HEALTHCARE QUALITY ASSURANCE AND PERFORMANCE MEASUREMENT AND STANDARDS BY MEANS OF A GLOBAL COMPUTER NETWORK (U.S. CLS. 100 AND 101).

TASNEEM HUSSAIN, EXAMINING ATTORNEY

CLASS 14—JEWELRY

FOR WRIST WATCHES, WALL CLOCKS, TABLE CLOCKS, ALARM CLOCKS, WATCH CHAINS, WATCH BANDS AND STRAPS; CLOCKS, WATCHES, PARTS FOR CLOCKS, PARTS FOR WATCHES; TIE CLIPS, TIE PINS, CUFF LINKS, EARRINGS, NECKLACES, RINGS BEING JEWELRY, RINGS BEING JEWELRY OF PRECIOUS METAL, RINGS BEING JEWELRY OF NON PRECIOUS METAL, BRACELETS, BROOCHES, ANKLETS BEING JEWELRY OF PRECIOUS METAL, ANKLETS BEING JEWELRY OF NON PRECIOUS METAL (U.S. CLS. 2, 27, 28 AND 50).

CLASS 18—LEATHER GOODS

FOR ALL-PURPOSE CARRYING BAGS, LEATHER BAGS, TEXTILE SHOPPING BAGS, BEACH BAGS, STRING BAGS FOR SHOPPING, UMBRELLAS, PARASOLS, SUITCASES, PURSES, WALLET, DRAWSTRING POUCHES (U.S. CLS. 1, 2, 3, 22 AND 41).

SKYE YOUNG, EXAMINING ATTORNEY

SN 76-633,981. ARBITRATION FORUMS, INC., TAMPA, FL.
FILED 3-21-2005.



SN 76-630,978. EDWIN COMPANY LTD., ARAKAWA-KU,
TOKYO, JAPAN, FILED 2-14-2005.



OWNER OF U.S. REG. NOS. 1,201,629 AND 1,225,114.

CLASS 3—COSMETICS AND CLEANING PREPARATIONS

FOR COSMETICS, AROMA THERAPY OILS, PERFUMES, EAU DE COLOGNE, FALSE NAILS, FALSE EYELASHES, MASCARA, LIPSTICKS, SKIN SOAPS, MAKE-UP PRODUCTS FOR THE FACE AND BODY (U.S. CLS. 1, 4, 6, 50, 51 AND 52).

OWNER OF U.S. REG. NO. 2,149,050.

NO CLAIM IS MADE TO THE EXCLUSIVE RIGHT TO USE "HUB" AND "ARBITRATION FORUMS, INC.", APART FROM THE MARK AS SHOWN.

CLASS 9—ELECTRICAL AND SCIENTIFIC APPARATUS

FOR ELECTRONIC DATA EXCHANGE SYSTEM FEATURING COMMUNICATION HUBS TO FACILITATE SENDING AND RECEIVING ELECTRONIC SUBROGATION DEMANDS BETWEEN INSURANCE AND/OR SELF-INSURED COMPANIES (U.S. CLS. 21, 23, 26, 36 AND 38).

CLASS 35—ADVERTISING AND BUSINESS

FOR FACILITATING THE EXCHANGE OF NEEDED INFORMATION FOR FINANCIAL COMPENSATION VIA THE INTERNET (U.S. CLS. 100, 101 AND 102).

CLASS 38—COMMUNICATION

FOR ELECTRONIC EXCHANGE OF DATA STORED IN DATABASES ACCESSIBLE VIA TELECOMMUNICATION NETWORKS (U.S. CLS. 100, 101 AND 104).

ANN E. SAPPENFIELD, EXAMINING ATTORNEY

SN 76-637,931. HAMPTON GOLF, INC., JACKSONVILLE, FL. FILED 5-5-2005.

SN 76-638,912. AUTOMATED SYSTEMS WORKERS, SOUTH-FIELD, MI. FILED 5-18-2005.

HAMPTON GOLF CLUBS



NO CLAIM IS MADE TO THE EXCLUSIVE RIGHT TO USE "AUTOMATED SYSTEMS WORKERS" CLASS 35 ONLY, APART FROM THE MARK AS SHOWN.

THE STIPPLING REPRESENTS SHADING ONLY.

THE MARK CONSISTS OF THE WORDS "AUTOMATED SYSTEMS WORKERS" AND "TOMORROW'S TECHNOLOGY TODAY" LOCATED INSIDE A CIRCULAR BORDER. INSIDE THE BORDER IS A PICTURE OF AN ASSEMBLY ROBOT AND THE LETTERS "ASW" WITH AN UNDER-LING PROJECTING OUTWARD FROM THE CIRCLE.

CLASS 25—CLOTHING

FOR CLOTHING, NAMELY HATS, T-SHIRTS, SPORTS SHIRTS, JACKETS, SWEATPANTS (U.S. CLS. 22 AND 39).

FIRST USE 1-0-2005; IN COMMERCE 4-0-2005.

THE MARK CONSISTS OF STANDARD CHARACTERS WITHOUT CLAIM TO ANY PARTICULAR FONT, STYLE, SIZE, OR COLOR.

NO CLAIM IS MADE TO THE EXCLUSIVE RIGHT TO USE "GOLF CLUBS", APART FROM THE MARK AS SHOWN.

CLASS 35—ADVERTISING AND BUSINESS

FOR OPERATION AND MANAGEMENT OF GOLF COURSES AND GOLF CLUBS FOR OTHERS; GOLF PRO-SHOP RETAIL STORE SERVICES FEATURING GOLF EQUIPMENT AND GOLF CLOTHING (U.S. CLS. 100, 101 AND 102).

FIRST USE 10-30-2002; IN COMMERCE 10-30-2002.

CLASS 41—EDUCATION AND ENTERTAINMENT

FOR RECREATIONAL SERVICES IN THE NATURE OF PROVIDING GOLF FACILITIES, NAMELY, GOLF CLUBHOUSES AND GOLF COURSES; GOLF CLUB SERVICES, NAMELY, GOLF LESSONS, INSTRUCTIONAL CLINICS, AND GOLF CLUB OPERATIONS; PROVIDING FACILITIES FOR RECREATION ACTIVITIES, NAMELY, FITNESS ACTIVITIES, AEROBICS, BIKING, GOLF, TENNIS, AND SWIMMING; PROVIDING INFORMATION VIA THE GLOBAL COMPUTER NETWORK IN THE FIELD OF GOLF COURSES, GOLF CLUB SERVICES, AND GOLF INSTRUCTION (U.S. CLS. 100, 101 AND 107).

FIRST USE 10-30-2002; IN COMMERCE 10-30-2002.

CLASS 43—HOTEL AND RESTAURANT SERVICES

FOR RESTAURANT SERVICES PROVIDED IN THE DINING ROOM OF A GOLF CLUB (U.S. CLS. 100 AND 101).

FIRST USE 10-30-2002; IN COMMERCE 10-30-2002. MICHAEL GAAFAR, EXAMINING ATTORNEY

CLASS 35—ADVERTISING AND BUSINESS

FOR LABOR UNION SERVICES (U.S. CLS. 100, 101 AND 102).

FIRST USE 1-0-2005; IN COMMERCE 4-0-2005.

JENNIFER MCROBBIE, EXAMINING ATTORNEY

SN 76-639,849. CERVITECH, INC., ROCKAWAY, NJ. FILED 6-1-2005.

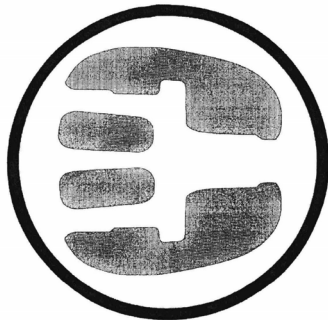

OWNER OF ERPN CMNTY TM OFC REG. NO. 003461746, DATED 10-28-2003, EXPIRES 10-28-2013.

THE COLOR(S) GRAY, BLACK AND TRANSPARENT IS/ ARE CLAIMED AS A FEATURE OF THE MARK.

THE COLOR GRAY APPEARS IN THE STYLIZED C. THE COLOR BLACK APPEARS IN THE CIRCLE AROUND THE STYLIZED C. THE COLOR TRANSPARENT APPEARS IN THE BACKGROUND OF THE MARK.

CLASS 9—ELECTRICAL AND SCIENTIFIC APPARATUS

FOR COMPUTER PROGRAMS FOR THE CONTROL OF COMPUTER BASED APPARATUS FOR SURGICAL OPERATIONS (U.S. CLS. 21, 23, 26, 36 AND 38).

CLASS 10—MEDICAL APPARATUS

FOR SURGICAL, MEDICAL, DENTAL AND VETERINARY APPARATUS AND INSTRUMENTS, NAMELY, SURGICAL INSTRUMENTS FOR USE IN THE IMPLEMENTATION OF ARTIFICIAL LIMBS, EYES, AND TEETH; ARTIFICIAL LIMBS, EYES, AND TEETH; SURGICAL IMPLANTS COMPOSED OF ARTIFICIAL MATERIAL; ARTIFICIAL ENDOPROSTHESES; SURGICAL SUTURES; ORTHOPEDIC ARTICLES, SPECIFICALLY ORTHOPEDIC SUPPORT BANDAGES AND SPLINTS; EYE PROTECTORS FOR POST-SURGERY EYE PROTECTION, NAMELY, EYE PATCHES; COMPUTER-CONTROLLED SURGICAL AND MEDICAL APPARATUS FOR CARRYING OUT SURGICAL OPERATIONS, NAMELY, ELECTROMAGNETIC MEDICAL DIAGNOSTIC IMAGING APPARATUS, ULTRASOUND DIAGNOSTIC APPARATUS, MRI DIAGNOSTIC APPARATUS (U.S. CLS. 26, 39 AND 44).

CLASS 16—PAPER GOODS AND PRINTED MATTER

FOR BROCHURES AND PERIODICALS IN THE FIELD OF MEDICAL TECHNOLOGY (U.S. CLS. 2, 5, 22, 23, 29, 37, 38 AND 50).

CLASS 42—SCIENTIFIC, COMPUTER AND LEGAL SERVICES

FOR CUSTOM DESIGN OF INDIVIDUAL MEDICAL, SURGICAL, DENTAL, AND VETERINARY IMPLANTS FOR OTHERS; PROVIDING ONLINE NON-DOWNLOADABLE SOFTWARE CONTAINING DATA FOR THE CONTROL OF COMPUTER BASED APPARATUS FOR THE PRODUCTION OF INDIVIDUAL MEDICAL, SURGICAL, DENTAL, AND VETERINARY IMPLANTS AND FOR SURGICAL OPERATIONS (U.S. CLS. 100 AND 101).

CLASS 44—MEDICAL, BEAUTY AND AGRICULTURAL SERVICES

FOR PROVIDING OF MEDICAL INFORMATION OVER THE INTERNET (U.S. CLS. 100 AND 101).
JAY BESCH, EXAMINING ATTORNEY

SN 76-640,018. PARASUN TECHNOLOGIES, INC., NEW WESTMINSTER, BRITISH COLUMBIA, CANADA, FILED 6-2-2005.

GridNet
| broadband 

NO CLAIM IS MADE TO THE EXCLUSIVE RIGHT TO USE BROADBAND, APART FROM THE MARK AS SHOWN.

CLASS 9—ELECTRICAL AND SCIENTIFIC APPARATUS

FOR TELECOMMUNICATIONS AND DATA NETWORKING HARDWARE, NAMELY, DEVICES FOR TRANSPORTING AND AGGREGATING VOICE, DATA AND VIDEO COMMUNICATIONS ACROSS MULTIPLE NETWORK INFRASTRUCTURES AND COMMUNICATIONS PROTOCOLS, TELECOMMUNICATIONS AND DATA NETWORKING SOFTWARE, NAMELY, SOFTWARE FOR TRANSPORTING AND AGGREGATING VOICE, DATA AND VIDEO COMMUNICATIONS ACROSS MULTIPLE NETWORK INFRASTRUCTURES AND COMMUNICATIONS PROTOCOLS (U.S. CLS. 21, 23, 26, 36 AND 38).

CLASS 38—COMMUNICATION

FOR PROVIDING ACCESS TO TELECOMMUNICATIONS DATA NETWORKS FOR TRANSPORTING AND AGGREGATING VOICE, DATA AND VIDEO COMMUNICATIONS ACROSS MULTIPLE NETWORK INFRASTRUCTURES AND COMMUNICATIONS PROTOCOLS; TELECOMMUNICATIONS CONSULTATION FOR TRANSPORTING AND AGGREGATING VOICE, DATA AND VIDEO COMMUNICATIONS ACROSS MULTIPLE NETWORK INFRASTRUCTURES AND COMMUNICATIONS PROTOCOLS, TRANSFER OF DATA BY TELECOMMUNICATIONS, NAMELY, TRANSPORTING AND AGGREGATING VOICE, DATA AND VIDEO COMMUNICATIONS VIA TELECOMMUNICATION NETWORKS (U.S. CLS. 100, 101 AND 104).

STEPHANIE DAVIS, EXAMINING ATTORNEY

SN 76-641,227. IFA FOUNDRY CORP., CARLSBAD, CA. FILED 6-21-2005.



IFA AND DESIGN, COMPRISES IFA AND A MISCELLANEOUS DESIGN WHICH COMPRISES A GLOBE BEING PLACED TILTEDLY ON A STAND.

CLASS 35—ADVERTISING AND BUSINESS

FOR IMPORT AND EXPORT AGENCIES; WHOLESALE DISTRIBUTORSHIPS FEATURING CASTING PRODUCTS FOR AUTOMOTIVE, TRUCK AND RAIL VEHICLES, FORGING PRODUCTS FOR AUTOMOTIVE VEHICLES; HYDRAULIC FITTINGS AND ADAPTORS, INDUSTRIAL STAMPING AND METAL FABRICATION PRODUCTS, TITANIUM FORMING GOLF PRODUCTS TO INCLUDE METAL WOODS, TITANIUM STEEL METAL WOODS (U.S. CLS. 100, 101 AND 102).
FIRST USE 12-0-1996; IN COMMERCE 12-0-1996.

CLASS 40—MATERIAL TREATMENT

FOR CUSTOM MANUFACTURING OF CASTING PRODUCTS FOR AUTOMOTIVE, TRUCK AND RAIL VEHICLES, FORGING PRODUCTS FOR AUTOMOTIVE VEHICLES, HYDRAULIC FITTINGS AND ADAPTORS, INDUSTRIAL STAMPING AND METAL FABRICATION PRODUCTS, TITANIUM FORMING GOLF PRODUCTS TO INCLUDE METAL WOODS TITANIUM STEEL METAL WOODS (U.S. CLS. 100, 103 AND 106).
FIRST USE 12-0-1996; IN COMMERCE 12-0-1996.
MARK SPARACINO, EXAMINING ATTORNEY

SN 76-642,735. KOMATSU SEIREN KABUSHIKI KAISHA (KOMATSU SEIREN CO., LTD.), NOMI-SHI, ISHIKAWA, JAPAN, FILED 7-12-2005.

HOKUTO

THE MARK CONSISTS OF STANDARD CHARACTERS WITHOUT CLAIM TO ANY PARTICULAR FONT, STYLE, SIZE, OR COLOR.

OWNER OF JAPAN REG. NO. 2005-037406, DATED 10-21-2005, EXPIRES 10-21-2015.

OWNER OF JAPAN REG. NO. 4904237, DATED 10-28-2005, EXPIRES 10-28-2015.

OWNER OF JAPAN REG. NO. 4902964, DATED 10-21-2005, EXPIRES 10-21-2015.

CLASS 18—LEATHER GOODS

FOR (BASED ON 44(E)) AND (BASED ON INTENT TO USE) ANIMAL SKINS; BAGS OF LEATHER FOR PACKAGING; LEATHER CASES; UMBRELLA COVERS; LEATHER ENVELOPES FOR PACKAGING; FUR; LEATHER STRAPS; LEATHER THONGS; PARASOLS; UMBRELLAS; IMITATION LEATHER SOLD IN BULK; SPORTS BAGS FOR CAMPING AND CLIMBING; ANIMAL SKINS AND HIDES; INFANT CARRIERS WORN ON THE BODY; LUGGAGE, NAMELY TRUNKS; VANITY CASES SOLD EMPTY; UNWORKED OR SEMI-WORKED LEATHER; AND BUSINESS CARD CASES (U.S. CLS. 1, 2, 3, 22 AND 41).

CLASS 20—FURNITURE AND ARTICLES NOT OTHERWISE CLASSIFIED

FOR (BASED ON INTENT TO USE) ARMCHAIRS; SLEEPING BAGS FOR CAMPING; BEDS; BEDS FOR HOUSEHOLD PETS; HOSPITAL BEDS; WORK BENCHES; BINS NOT OF METAL; MEDICINE CABINETS; CHESTS FOR TOYS; NONMETAL CHESTS; CHESTS OF DRAWERS; CRADLES; CURTAIN TIE-BACKS; CUSHIONS; PET CUSHIONS; DECK CHAIRS; DESKS; DISPLAY STANDS; DIVANS; DOG KENNELS; DOORS FOR FURNITURE; DRESSING TABLES; EASY CHAIRS; FURNITURE; OFFICE FURNITURE; HAIRDRESSERS' CHAIRS; HIGH CHAIRS FOR BABIES; INFANT WALKERS; KENNELS FOR HOUSEHOLD PETS; LIBRARY SHELVES; MAGAZINE RACKS; MATTRESSES; SPRING MATTRESSES; PACKAGING CONTAINERS OF PLASTIC; PILLOWS; PLANT RACKS; SCHOOL FURNITURE; SETTEES; SHELVES FOR STORAGE; SOFAS; TABLES; TEACARTS; TEA TROLLEYS; TYPING DESKS; WRITING DESKS; BABY BOLSTERS; DISPLAY RACKS FOR BOTTLES; WINE RACKS; FILING CABINETS; CHAIRS; WOOD CHOPPING BLOCK TABLES; COSTUME DISPLAY STANDS; FURNITURE PARTS, NAMELY COUNTERTOPS; FIRE SCREENS FOR DOMESTIC USE; DOMESTIC SCREENS, NAMELY FIREGUARDS; BOOK RESTS; CAGES FOR PETS; BIRD CAGES FOR DOMESTIC BIRDS; PLANT STANDS; INDOOR WINDOW BLINDS FOR SHADE; JEWELRY CASES NOT OF PRECIOUS METAL; LOVE SEATS; FURNITURE SEATS; SERVING TROLLEYS; DISPLAY CASES; AND SLEEPING BAGS (U.S. CLS. 2, 13, 22, 25, 32 AND 50).

CLASS 24—FABRICS

FOR (BASED ON 44(E)) AND (BASED ON INTENT TO USE) BED LINEN; BOLTING CLOTH; PRINTED CALICO CLOTH; CHEESE CLOTH; CHENILLE FABRIC; COTTON FABRICS; TRACED CLOTH FOR EMBROIDERY; ESPARTO FABRIC; FABRIC FOR BOOTS AND SHOES; FABRIC OF IMITATION ANIMAL SKINS; FACE TOWELS OF TEXTILE; FELT; FIBERGLASS FABRICS FOR TEXTILE USE; HANDKERCHIEFS OF TEXTILES; HEMP CLOTH; JUTE FABRIC; KNITTED FABRIC; MATTRESS COVERS; MOSQUITO NETS; NON-WOVEN TEXTILE FABRICS; PILLOWCASES; QUILTS, RAMIE FABRIC; RAYON FABRIC; PILLOW SHAMS; TOWELS OF TEXTILE; TULLE; UPHOLSTERY FABRICS; VELVET; CHEMICAL FIBER FABRICS; COTTON BASE MIXED FABRICS; ELASTIC YARN MIXED FABRICS; FLAX FABRICS; HAND SPUN SILK FABRICS; HAND-TOWELS MADE OF TEXTILE FABRICS; HEMP BASE MIXED FABRICS; HEMP YARN FABRICS; HEMP-COTTON MIXED FABRICS; HEMP WOOL MIXED FABRICS; HEMP SILK MIXED FABRICS; INORGANIC FIBER MIXED FABRICS; KNITTED FABRICS OF SILK YARN; KNITTED FABRICS OF WOOL YARN; MESH-WOVEN FABRICS; MIXED FIBER FABRICS; NYLON FABRIC; POLYESTER FABRIC; NARROW WOVEN FABRICS; REGENERATED FIBER YARN FABRICS; SEMI-FINISHED PLASTIC PRODUCTS, NAMELY WOVEN ARAMID FABRICS FOR USE IN THE MANUFACTURE OF PROTECTIVE CLOTHING AND HELMETS AND IN HARD ARMOR; SEMI-SYNTHETIC FIBER FABRICS; SILK BASE MIXED FABRICS; SILK-COTTON MIXED FABRICS; SILK WOOL MIXED FABRICS; SPUN SILK FABRICS; SYNTHETIC FIBER FABRICS; TRUE HEMP FABRICS; WASTE COTTON FABRICS; WOOL BASE MIXED FABRICS; WOOL YARN FABRICS; WOOL-COTTON MIXED FABRICS; WORSTED FABRICS; CLOTH BUNTING; CREPE CLOTH; FELT CLOTH; GUMMED WATERPROOF CLOTH; OIL CLOTH; RUBBERIZED CLOTH; SILK CLOTH; BED CLOTH, NAMELY BLANKETS; EIDERDOWN COVERS; FRIEZE; GAUZE FABRIC; FLANNEL; TEXTILE USED AS LINING FOR CLOTHING; LINEN FABRIC; MATTRESS COVERS; COVERED RUBBER YARN FABRICS FOR TEXTILE USE; FOULARD FABRIC; FABRIC JERSEY MATERIAL (U.S. CLS. 42 AND 50).

CLASS 25—CLOTHING

FOR (BASED ON 44(E)) AND (BASED ON INTENT TO USE) BABIES' PANTS; BATH ROBES; BATH SANDALS; BATH SLIPPERS; BATHING SUITS; BATHING TRUNKS; BEACH SHOES; BOOTS; BOOTS FOR SPORTS; HEEL PIECES FOR BOOTS; SKI BOOTS; BRASSIERES; CAMISOLES; SHOWER CAPS; COATS; TOP COATS; FISHING VESTS; FOOTBALL BOOTS; FOOTBALL SHOES; FOOTWEAR; GIRDLES; GYMNAS TIC SHOES; HALF-BOOTS; HATS; INNER SOLES; LACE BOOTS; LIVERIES; OVERALLS; OVERCOATS; PAJAMAS; PANTS; PARKAS; PETTICOATS; PULLOVERS; SANDALS; SARIS; DRESS SHIELDS; SHIRTS; SHOES; HEEL PIECES FOR SHOES; SKIRTS; SLIPPERS; SOLES FOR FOOTWEAR; SPORTS SHOES; SUITS; SUN VISORS; SWEATERS; SWIMSUITS; TEE-SHIRTS; TIPS FOR FOOTWEAR; TOGAS; TOP HATS; TROUSERS; TURBANS; UNDERCLOTHING; ANTI-SWEAT UNDERCLOTHING; UNDERPANTS; UNDERWEAR; ANTI-SWEAT UNDERWEAR; UNIFORMS; VESTS; WAISTCOATS; CLOTHING, NAMELY FOLK COSTUMES; GUSSETS FOR BATHING SUITS; GUSSETS FOR UNDERWEAR, LINGERIE AND UNDERGARMENTS, NAMELY BODICES, SLIPS, LAYETTES, SWEAT ABSORBENT UNDERCLOTHING, CORSETS, AND UNDERWEAR; FOOTWEAR UPPERS; CLOTHING OF IMITATION LEATHER, NAMELY SHOES AND JACKETS; LEATHER CLOTHING, NAMELY SHOES AND JACKETS; FUR CLOTHING, NAMELY COATS; HEADGEAR FOR WEAR, NAMELY HATS, HOODS, AND HEADBANDS; STUFF JACKETS; JERSEYS; JUMPERS; SHIRT-FRONT; KNITWEAR, NAMELY SHIRTS AND UNDERWEAR; SKI JACKETS; SKI PANTS; RAINCOATS (U.S. CLS. 22 AND 39).

AMEETA JORDAN, EXAMINING ATTORNEY

SN 76-642,971. THE SINGH COMPANY, MARATHON, FL.
FILED 7-15-2005.

SN 76-644,048. COREBRIDGE SOCIETE NOUVELLE S.A.S.
75008 PARIS, FRANCE. FILED 8-1-2005.

PARROT KEY RESORT

THE MARK CONSISTS OF STANDARD CHARACTERS WITHOUT CLAIM TO ANY PARTICULAR FONT, STYLE, SIZE, OR COLOR.

NO CLAIM IS MADE TO THE EXCLUSIVE RIGHT TO USE "RESORT", APART FROM THE MARK AS SHOWN.

CLASS 35—ADVERTISING AND BUSINESS

FOR (BASED ON INTENT TO USE) REAL ESTATE MARKETING SERVICES, NAMELY, ON-LINE MARKETING SERVICES, FEATURING TOURS OF RESIDENTIAL AND COMMERCIAL REAL ESTATE, REAL ESTATE ADVERTISING SERVICES (U.S. CLS. 100, 101 AND 102).

CLASS 36—INSURANCE AND FINANCIAL

FOR (BASED ON USE IN COMMERCE) REAL ESTATE BROKERAGE SERVICES, NAMELY, RENTAL AND SALE OF CONDOMINIUM UNITS (U.S. CLS. 100, 101 AND 102).

FIRST USE 3-21-2005; IN COMMERCE 6-17-2005.

CLASS 43—HOTEL AND RESTAURANT SERVICES

FOR (BASED ON INTENT TO USE) PROVIDING CONFERENCE, CONVENTION AND GROUP MEETING FACILITIES; REAL ESTATE, CONDOMINIUM AND HOTEL MANAGEMENT SERVICES; HOTEL AND RESORT SERVICES; RESTAURANT SERVICES; BAR SERVICES (U.S. CLS. 100 AND 101).

CAROLYN GRAY, EXAMINING ATTORNEY

SN 76-644,033. HARTZ HOTEL SERVICES, INC., SECAUCUS, NJ. FILED 8-1-2005.

GRAND LIFE

THE MARK CONSISTS OF STANDARD CHARACTERS WITHOUT CLAIM TO ANY PARTICULAR FONT, STYLE, SIZE, OR COLOR.

CLASS 34—SMOKERS' ARTICLES

FOR MATCHES (U.S. CLS. 2, 8, 9 AND 17).

CLASS 35—ADVERTISING AND BUSINESS

FOR ON-LINE RETAIL STORE SERVICES FEATURING CDS, BEDDING, CLOTHING, CANDLES AND THE LIKE, NAMELY, A WIDE VARIETY OF CONSUMER GOODS OF OTHERS; PROMOTING GALLERY SHOWS OF OTHERS (U.S. CLS. 100, 101 AND 102).

MARLENE BELL, EXAMINING ATTORNEY

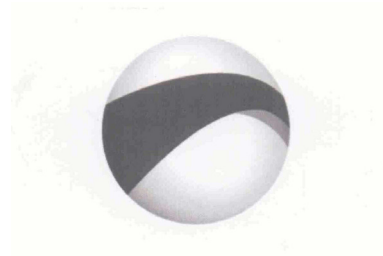

THE COLOR GRAY IS INTENDED TO INDICATE SHADING OR CONTRAST ONLY. THE MARK IS NOT IN COLOR.

CLASS 9—ELECTRICAL AND SCIENTIFIC APPARATUS

FOR COMPUTER SOFTWARE FOR USE IN TELECOMMUNICATIONS, NAMELY, TRANSMISSION OF VOICE, DATA, IMAGES, SIGNALS, AND MESSAGES, AND INSTRUCTIONAL MANUALS SOLD AS A UNIT; SOFTWARE PACKAGES FOR USE IN TELECOMMUNICATIONS, NAMELY, CONNECTING COMPUTER NETWORK USERS, AND INSTRUCTIONAL MANUALS SOLD AS A UNIT; RECORDED COMPUTER PROGRAMS FOR USE IN TELECOMMUNICATIONS, NAMELY, TO ENABLE USERS TO PERFORM TELEPHONE ACTIVITIES THROUGH A COMPUTER, AND INSTRUCTIONAL MANUALS SOLD AS A UNIT; MICROPROCESSORS; COMPUTERS AND INSTRUCTIONAL MANUALS SOLD AS A UNIT; COMPUTER PERIPHERALS AND INSTRUCTIONAL MANUALS SOLD AS A UNIT; PRE-RECORDED CD-ROMS, VIDEO TAPES, AND AUDIO TAPES FEATURING TELECOMMUNICATIONS, NAMELY, INTEGRATING, CONTROLLING, ENHANCING, SECURING, AND MANAGING VIDEO, VOICE, AND DATA COMMUNICATIONS; BLANK COMPUTER DISCS, BLANK CD-ROMS, BLANK VIDEO TAPES, BLANK AUDIO TAPES, AND BLANK DIGITAL AUDIO TAPES; OPTICAL DATA MEDIA, NAMELY, BLANK OPTICAL DISCS AND PRE-RECORDED OPTICAL DISCS CONTAINING INFORMATION ON COMMUNICATIONS TECHNOLOGY; AND TELECOMMUNICATION APPARATUS, NAMELY, TELEPHONES, TELEPHONE ANSWERING MACHINES, AND FACSIMILE MACHINES (U.S. CLS. 21, 23, 26, 36 AND 38).

FIRST USE 3-0-2004; IN COMMERCE 3-0-2004.

CLASS 38—COMMUNICATION

FOR TELECOMMUNICATION SERVICES, NAMELY, TRANSMISSION OF INFORMATION BY TELEPHONE AND VIA THE INTERNET, NAMELY, ELECTRONIC, ELECTRIC, AND DIGITAL TRANSMISSION OF DATA, VOICE, IMAGES, SIGNALS, AND MESSAGES; ELECTRONIC MAIL SERVICES; ELECTRONIC TRANSMISSION OF COMMERCIAL DATA AND ADVERTISING DATA VIA THE INTERNET; PROVIDING MULTIPLE USERS ACCESS TO A GLOBAL COMPUTER INFORMATION NETWORK (U.S. CLS. 100, 101 AND 104).

FIRST USE 3-0-2004; IN COMMERCE 3-0-2004.

CLASS 42—SCIENTIFIC, COMPUTER AND LEGAL SERVICES

FOR COMPUTER PROGRAMMING FOR OTHERS; MAINTENANCE OF COMPUTER SOFTWARE FOR OTHERS; CONSULTING SERVICES IN THE FIELD OF COMPUTER HARDWARE (U.S. CLS. 100 AND 101).

FIRST USE 3-0-2004; IN COMMERCE 3-0-2004.

MARLENE BELL, EXAMINING ATTORNEY

SN 76-644,057. RAINBOW INTERNATIONAL CARPET DYEING & CLEANING CO., WACO, TX. FILED 8-2-2005.

SN 76-644,159. STRENGTH 123, INC., NEW YORK, NY. FILED 8-1-2005.

RAINBOW INTERNATIONAL RESTORATION & CLEANING

THE MARK CONSISTS OF STANDARD CHARACTERS WITHOUT CLAIM TO ANY PARTICULAR FONT, STYLE, SIZE, OR COLOR.

OWNER OF U.S. REG. NOS. 1,481,898, 2,850,175 AND OTHERS.

NO CLAIM IS MADE TO THE EXCLUSIVE RIGHT TO USE "INTERNATIONAL RESTORATION & CLEANING", APART FROM THE MARK AS SHOWN.

CLASS 37—CONSTRUCTION AND REPAIR

FOR CARPET, UPHOLSTERY AND DRAPERY CLEANING, AND SPOT, STAIN AND ODOR REMOVAL SERVICES; AIR-DUCT CLEANING SERVICES; DISASTER RESTORATION SERVICES, NAMELY, RESTORING BUILDING INTERIORS, CARPET AND FURNISHINGS DAMAGES BY FIRE, WATER, SMOKE AND OTHER DISASTERS; CARPET REPAIR SERVICES; COMMERCIAL AND RESIDENTIAL BUILDING CLEANING SERVICES (U.S. CLS. 100, 103 AND 106).

FIRST USE 9-0-2003; IN COMMERCE 9-0-2003.

CLASS 40—MATERIAL TREATMENT

FOR MOLD INHIBITION SERVICES CONCERNING BUILDINGS AND THEIR CONTENTS (U.S. CLS. 100, 103 AND 106).

FIRST USE 9-0-2003; IN COMMERCE 9-0-2003.

BRENDAN REGAN, EXAMINING ATTORNEY

SN 76-644,070. SUPPORT OUR TROOPS, INC., ORMOND BEACH, FL. FILED 8-2-2005.

HEROES FUND

NO CLAIM IS MADE TO THE EXCLUSIVE RIGHT TO USE "FUND", APART FROM THE MARK AS SHOWN.

CLASS 36—INSURANCE AND FINANCIAL

FOR CHARITABLE FUND RAISING; ACCEPTING AND ADMINISTERING MONETARY CHARITABLE CONTRIBUTIONS (U.S. CLS. 100, 101 AND 102).

FIRST USE 7-28-2005; IN COMMERCE 7-28-2005.

CLASS 41—EDUCATION AND ENTERTAINMENT

FOR PROVIDING TOYS TO NEEDY CHILDREN; ACADEMIC MENTORING OF SCHOOL AGE CHILDREN; PROVIDING BOOKS TO THE NEEDY; AND PROVIDING SPORTING GOODS TO UNDERPRIVILEGED CHILDREN (U.S. CLS. 100, 101 AND 107).

FIRST USE 7-28-2005; IN COMMERCE 7-28-2005.

RONALD AIKENS, EXAMINING ATTORNEY

MENTAL DETOX

THE MARK CONSISTS OF STANDARD CHARACTERS WITHOUT CLAIM TO ANY PARTICULAR FONT, STYLE, SIZE, OR COLOR.

CLASS 41—EDUCATION AND ENTERTAINMENT

FOR EXERCISE SERVICES, NAMELY, PERSONAL TRAINER SERVICES, PHYSICAL FITNESS CONSULTATION, PHYSICAL FITNESS INSTRUCTION, PHYSICAL FITNESS TRAINING AND EXERCISE TRAINING SERVICES (U.S. CLS. 100, 101 AND 107).

FIRST USE 6-29-2005; IN COMMERCE 6-29-2005.

CLASS 44—MEDICAL, BEAUTY AND AGRICULTURAL SERVICES

FOR FOOD NUTRITION CONSULTATION AND COUNSELING IN THE FIELD OF HEALTH CARE (U.S. CLS. 100 AND 101).

FIRST USE 6-29-2005; IN COMMERCE 6-29-2005.

MARLENE BELL, EXAMINING ATTORNEY

SN 76-644,206. MAXYIELD COOPERATIVE, WEST BEND, IA. FILED 8-5-2005.

MAXTERRA

THE MARK CONSISTS OF STANDARD CHARACTERS WITHOUT CLAIM TO ANY PARTICULAR FONT, STYLE, SIZE, OR COLOR.

CLASS 42—SCIENTIFIC, COMPUTER AND LEGAL SERVICES

FOR MAPPING SERVICES FOR GOLF COURSES, CORPORATE GREEN SPACES AND SPORT FACILITY GROUNDS (U.S. CLS. 100 AND 101).

FIRST USE 1-1-2005; IN COMMERCE 1-1-2005.

CLASS 44—MEDICAL, BEAUTY AND AGRICULTURAL SERVICES

FOR PROVIDING SITE SPECIFIC SOIL NUTRIENT APPLICATION RECOMMENDATIONS FOR GOLF COURSES, CORPORATE GREEN SPACES AND SPORT FACILITY GROUNDS, NAMELY, ADVISORY SERVICES IN THE FIELD OF APPLICATION OF FERTILIZERS AND OTHER AGRICULTURAL CHEMICALS; VARIABLE RATE FERTILIZER APPLICATION FOR GOLF COURSES, CORPORATE GREEN SPACES AND SPORT FACILITY GROUNDS, NAMELY, SPREADING OF FERTILIZERS AND OTHER AGRICULTURAL CHEMICALS (U.S. CLS. 100 AND 101).

FIRST USE 1-1-2005; IN COMMERCE 1-1-2005.

JOHN DWYER, EXAMINING ATTORNEY

SN 76-644,332. AMERICAN MEDICAL ASSOCIATION, CHICAGO, IL. FILED 8-8-2005.



OWNER OF U.S. REG. NOS. 1,789,742, 2,838,323 AND 2,937,404.

NO CLAIM IS MADE TO THE EXCLUSIVE RIGHT TO USE "MEDICAL ASSOCIATION", APART FROM THE MARK AS SHOWN.

THE MARK CONSISTS OF A STYLIZED SERPENT ON A STAFF.

SEC. 2(F) AS TO AMERICAN.

CLASS 16—PAPER GOODS AND PRINTED MATTER

FOR PRINTED PUBLICATIONS, NAMELY, BOOKS, BROCHURES, PROFESSIONAL JOURNALS, BOOKLETS, NEWSLETTERS, PAMPHLETS AND MONOGRAPHS RELATED TO VARIOUS ASPECTS OF MEDICAL SCIENCE (U.S. CLS. 2, 5, 22, 23, 29, 37, 38 AND 50).

FIRST USE 6-18-2005; IN COMMERCE 6-18-2005.

CLASS 35—ADVERTISING AND BUSINESS

FOR ASSOCIATION SERVICES, NAMELY, PROMOTING THE INTERESTS, GOALS AND OBJECTIVES OF THE MEDICAL COMMUNITY THROUGH PROGRAMS, PUBLICATIONS, AND COMMUNICATIONS IN THE FIELD OF SCIENCE AND MEDICINE (U.S. CLS. 100, 101 AND 102).

FIRST USE 6-18-2005; IN COMMERCE 6-18-2005.
REBECCA HAN, EXAMINING ATTORNEY

SN 76-644,706. KABUSHIKI KAISHA LUMIELINA, KANAGAWA, JAPAN, FILED 8-11-2005.

RIHADA
理肌

THE NON-LATIN CHARACTERS IN THE MARK TRANSLITERATE TO RIHADA.

CLASS 3—COSMETICS AND CLEANING PREPARATIONS

FOR SOAPS, NAMELY, SOAPS FOR BATHS, SOAPS FOR BEAUTY CARE, LIQUID SOAPS, AND TOILET SOAPS; HAIR CARE PRODUCTS, NAMELY, SKIN CARE PRODUCTS, NAMELY, MASSAGE GELS, CLEANING, MOISTURIZING AND FACE MILK LOTIONS, SKIN LOTIONS, BODY LOTIONS, SHAVING LOTIONS, VANISHING CREAMS, CLEANSING CREAMS, TOILET OILS, MASSAGE OILS, BATH OILS, SUNTAN OILS, BABY OILS, SKIN FRESHENERS, SUN MILKS, SUNTAN CREAMS, SUNTAN LOTIONS, SUN SCREEN LOTIONS, SUN SCREEN CREAMS, HAND CREAMS, TALCUM POWDERS, BATH POWDERS AND BABY POWDERS; COSMETICS, NAMELY, BODY CONDITIONERS AND LIP CONDITIONERS; FRAGRANCES, NAMELY, EAU DE COLOGNES, PERFUMES, LAVENDER OILS, AND CLOVE OILS; NON-MEDICATED BATH SALTS, BEAUTY MASKS FOR THE FACE AND BODY; BATH ESSENCES AND BATH EXTRACTS, NAMELY, NON-MEDICATED BATH AGENTS THAT ENHANCE RELAXATION AND PROMOTE SKIN AND BODY CARE (U.S. CLS. 1, 4, 6, 50, 51 AND 52).

CLASS 44—MEDICAL, BEAUTY AND AGRICULTURAL SERVICES

FOR BEAUTY CULTURE SERVICES, NAMELY BEAUTY TREATMENT SERVICES, NAMELY HAIRDRESSING SERVICES, MANICURING, COSMETOLOGY, MASSAGE, AND BEAUTY SALON SERVICES; CONSULTATION SERVICES RELATING TO BEAUTY CULTURE AND PROVIDING INFORMATION ON BEAUTY (U.S. CLS. 100 AND 101).

TRICIA SONNEBORN, EXAMINING ATTORNEY

SN 76-644,768. HOTALING, ROBERT, MANCHESTER, CT. FILED 8-12-2005.

PLAYAS & HATERS

THE MARK CONSISTS OF STANDARD CHARACTERS WITHOUT CLAIM TO ANY PARTICULAR FONT, STYLE, SIZE, OR COLOR.

CLASS 9—ELECTRICAL AND SCIENTIFIC APPARATUS

FOR SOFTWARE AND ELECTRONIC GAMES, NAMELY SOFTWARE GAMES RECORDED ON CD-ROM AND DIGITAL VIDEO DISCS FOR COMPUTERS; SOFTWARE GAMES RECORDED ON CD-ROMS, DIGITAL VIDEO DISCS, AND CARTRIDGES FOR CONSOLE AND INDIVIDUAL, PORTABLE GAMING SYSTEMS; SOFTWARE GAMES THAT ARE DOWNLOADABLE FROM A REMOTE COMPUTER SITE; AND SOFTWARE GAMES FOR MOBILE PHONES, PERSONAL DIGITAL ASSISTANTS, AND HANDHELD COMPUTERS (U.S. CLS. 21, 23, 26, 36 AND 38).

CLASS 38—COMMUNICATION

FOR ELECTRONIC, ELECTRIC, AND DIGITAL TRANSMISSION OF VOICE, DATA, INFORMATION, IMAGES, SIGNALS AND MESSAGES FOR COMPUTERS, MOBILE PHONES, PERSONAL DIGITAL ASSISTANTS AND HANDHELD COMPUTERS (U.S. CLS. 100, 101 AND 104).

TRICIA SONNEBORN, EXAMINING ATTORNEY

SN 76-644,802. BLACKHAWK MARKETING LLC, PLEASANTON, CA. FILED 8-15-2005.



THE COLORS GREEN, SILVER AND BLUE ARE CLAIMED AS A FEATURE OF THE MARK.

THE COLOR GREEN APPEARS IN THE LETTERS "C", "I", AND "N"; THE COLOR SILVER APPEARS IN THE LETTER "O" WHICH IS DEPICTED AS A COIN; AND THE COLOR BLUE APPEARS IN THE WORD MASTER.

CLASS 9—ELECTRICAL AND SCIENTIFIC APPARATUS

FOR SELF-SERVICE KIOSKS FOR COIN REDEMPTION (U.S. CLS. 21, 23, 26, 36 AND 38).

CLASS 36—INSURANCE AND FINANCIAL

FOR COIN REDEMPTION SERVICES (U.S. CLS. 100, 101 AND 102).
KEVON CHISOLM, EXAMINING ATTORNEY

SN 76-644,805. BLACKHAWK MARKETING LLC, PLEASANTON, CA. FILED 8-15-2005.



NO CLAIM IS MADE TO THE EXCLUSIVE RIGHT TO USE "COIN", APART FROM THE MARK AS SHOWN.

THE COLORS GREEN, SILVER AND BLUE ARE CLAIMED AS A FEATURE OF THE MARK.

THE COLOR GREEN APPEARS IN THE LETTERS "C", "I", AND "N"; THE COLOR SILVER APPEARS IN THE LETTER "O" WHICH IS DEPICTED AS A COIN; AND THE COLOR BLUE APPEARS IN THE WORD MASTER.

CLASS 9—ELECTRICAL AND SCIENTIFIC APPARATUS

FOR SELF-SERVICE KIOSKS FOR COIN REDEMPTION (U.S. CLS. 21, 23, 26, 36 AND 38).

CLASS 36—INSURANCE AND FINANCIAL

FOR COIN REDEMPTION SERVICES (U.S. CLS. 100, 101 AND 102).
KEVON CHISOLM, EXAMINING ATTORNEY

SN 76-645,143. ART WILSON CO., CARSON CITY, NV. FILED 8-18-2005.



CLASS 1—CHEMICALS

FOR CHEMICAL FERTILIZER, SOIL CONDITIONER AND SOIL AMENDMENTS (U.S. CLS. 1, 5, 6, 10, 26 AND 46).

FIRST USE 0-0-1978; IN COMMERCE 6-0-1981.

CLASS 37—CONSTRUCTION AND REPAIR

FOR EXCAVATION SERVICES (U.S. CLS. 100, 103 AND 106).

FIRST USE 0-0-1978; IN COMMERCE 6-0-1981.

CLASS 39—TRANSPORTATION AND STORAGE

FOR TRANSPORTATION OF MINED MATERIALS FOR OTHERS (U.S. CLS. 100 AND 105).

FIRST USE 0-0-1978; IN COMMERCE 6-0-1981.

CLASS 40—MATERIAL TREATMENT

FOR MINERAL REFINING AND MILLWORKING SERVICES (U.S. CLS. 100, 103 AND 106).

FIRST USE 0-0-1978; IN COMMERCE 6-0-1981.

CLASS 42—SCIENTIFIC, COMPUTER AND LEGAL SERVICES

FOR MINING AND MINERAL EXPLORATION AND GENERAL ENGINEERING SERVICES, INCLUDING ENGINEERING SERVICES IN THE FIELD OF EXCAVATING (U.S. CLS. 100 AND 101).

FIRST USE 0-0-1978; IN COMMERCE 6-0-1981.

MARIA-VICTORIA SUAREZ, EXAMINING ATTORNEY

SN 76-646,996. HOPE FOR THE HEART, INC., DALLAS, TX. FILED 9-19-2005.

BIBLICAL COUNSELING KEYS

THE MARK CONSISTS OF STANDARD CHARACTERS WITHOUT CLAIM TO ANY PARTICULAR FONT, STYLE, SIZE, OR COLOR.

NO CLAIM IS MADE TO THE EXCLUSIVE RIGHT TO USE BIBLICAL COUNSELING, APART FROM THE MARK AS SHOWN.

CLASS 16—PAPER GOODS AND PRINTED MATTER

FOR BOOKS, WORKBOOKS, MANUALS AND PRINTED INSTRUCTIONAL, EDUCATIONAL, AND TEACHING MATERIALS IN THE AREA OF RELIGIOUS COUNSELING (U.S. CLS. 2, 5, 22, 23, 29, 37, 38 AND 50).

FIRST USE 1-0-1996; IN COMMERCE 1-0-1996.

CLASS 41—EDUCATION AND ENTERTAINMENT

FOR PROVIDING TRAINING COURSES, SEMINARS, AND WORKSHOPS IN THE FIELD OF RELIGIOUS COUNSELING (U.S. CLS. 100, 101 AND 107).

FIRST USE 1-0-1996; IN COMMERCE 1-0-1996.
AMY GEARIN, EXAMINING ATTORNEY

CLASS 41—EDUCATION AND ENTERTAINMENT

FOR PROVIDING ON-LINE NON-DOWNLOADABLE MAGAZINES IN THE FIELDS OF MEAT, POULTRY AND SEAFOOD PROCESSING AND DISTRIBUTION (U.S. CLS. 100, 101 AND 107).

FIRST USE 11-17-2005; IN COMMERCE 11-17-2005.
TRACY WHITAKER-BOWN, EXAMINING ATTORNEY

SN 76-647,045. MYRIAD SYSTEMS, INC., OKLAHOMA CITY, OK. FILED 9-16-2005.

**CLASS 35—ADVERTISING AND BUSINESS**

FOR INFORMATION MANAGEMENT SERVICES, NAMELY, SHIPMENT PROCESSING, PREPARING SHIPPING DOCUMENTS AND INVOICES, TRACKING DOCUMENTS, PACKAGES AND FREIGHT OVER COMPUTER NETWORKS, INTRANETS AND INTERNETS (U.S. CLS. 100, 101 AND 102).

FIRST USE 3-0-2005; IN COMMERCE 3-0-2005.

CLASS 39—TRANSPORTATION AND STORAGE

FOR STORAGE SERVICES FOR ARCHIVING DATABASES, IMAGES AND OTHER ELECTRONIC DATA (U.S. CLS. 100 AND 105).

FIRST USE 3-0-2005; IN COMMERCE 3-0-2005.

CLASS 42—SCIENTIFIC, COMPUTER AND LEGAL SERVICES

FOR DESIGN AND DEVELOPMENT OF ONLINE COMPUTER SOFTWARE INTERNET/INTRANET SYSTEMS (U.S. CLS. 100 AND 101).

FIRST USE 3-0-2005; IN COMMERCE 3-0-2005.
ANGELA M. MICHELI, EXAMINING ATTORNEY

SN 76-647,970. WATT PUBLISHING COMPANY, MOUNT MORRIS, IL. FILED 10-3-2005.

MEAT PROCESSING GLOBAL

THE MARK CONSISTS OF STANDARD CHARACTERS WITHOUT CLAIM TO ANY PARTICULAR FONT, STYLE, SIZE, OR COLOR.

OWNER OF U.S. REG. NOS. 1,914,833, 3,102,766 AND OTHERS.
SEC. 2(F).

CLASS 16—PAPER GOODS AND PRINTED MATTER

FOR PRINTED PUBLICATIONS, NAMELY, MAGAZINES IN THE FIELDS OF MEAT, POULTRY AND SEAFOOD PROCESSING AND DISTRIBUTION (U.S. CLS. 2, 5, 22, 23, 29, 37, 38 AND 50).

FIRST USE 1-18-2005; IN COMMERCE 1-18-2005.

SN 76-648,286. RUSSIAN CLASS DANCE SHOES, INC., CHICAGO, IL. FILED 10-6-2005.

RUSSIAN POINTE

THE MARK CONSISTS OF STANDARD CHARACTERS WITHOUT CLAIM TO ANY PARTICULAR FONT, STYLE, SIZE, OR COLOR.

OWNER OF U.S. REG. NO. 2,363,451.

SEC. 2(F) THE MARK, AS USED IN CONNECTION WITH BALLET SHOES, BALLET SLIPPERS AND DANCE SHOES HAS BECOME DISTINCTIVE OF THE GOODS THROUGH THE APPLICANT'S SUBSTANTIALLY EXCLUSIVE AND CONTINUOUS USE IN COMMERCE FOR AT LEAST THE FIVE YEARS IMMEDIATELY BEFORE THE DATE OF THIS STATEMENT..

CLASS 25—CLOTHING

FOR FOOTWEAR, NAMELY BALLET SHOES, BALLET SLIPPERS, DANCE SHOES, SHOE ACCESSORIES, NAMELY RIBBONS AND ELASTIC, AND DANCE COSTUMES (U.S. CLS. 22 AND 39).

FIRST USE 6-10-1999; IN COMMERCE 6-10-1999.

CLASS 41—EDUCATION AND ENTERTAINMENT

FOR ORGANIZING OF DANCE COMPETITIONS (U.S. CLS. 100, 101 AND 107).

FIRST USE 7-0-1999; IN COMMERCE 7-0-1999.
JOHN DALIER, EXAMINING ATTORNEY

SN 76-648,426. NAKITA & HOPSURE FINANCIAL SERVICES, LTD., ROAD TOWN, TORTOLA, BR.VIRGIN ISLANDS, FILED 10-13-2005.

REVO

THE MARK CONSISTS OF STANDARD CHARACTERS WITHOUT CLAIM TO ANY PARTICULAR FONT, STYLE, SIZE, OR COLOR.

CLASS 10—MEDICAL APPARATUS

FOR ORTHOTICS FOR THE FEET, NAMELY, ORTHOTIC FOOTWEAR; ORTHOTIC INSERTS FOR FOOTWEAR; ORTHOPEDIC FOOTWEAR; CORRECTIVE FOOTWEAR IN THE NATURE OF ORTHOPEDIC FOOTWEAR; FOOTWEAR FOR USE IN PREVENTING DEEP VEIN THROMBOSIS; AND, FOOTWEAR FOR USE IN PREVENTING AND TREATING VARICOSE VEINS (U.S. CLS. 26, 39 AND 44).

CLASS 25—CLOTHING

FOR FOOTWEAR INSOLES (U.S. CLS. 22 AND 39).
ELISSA GARBER KON, EXAMINING ATTORNEY

SN 76-652,341. BOARD OF REGENTS OF THE UNIVERSITY SYSTEM OF GEORGIA, ATLANTA, GA. FILED 12-22-2005.

SN 76-649,353. DAVISON, CLIFTON O., FORT COLLINS, CO. FILED 10-28-2005.

TORO DE TEJAS

THE MARK CONSISTS OF STANDARD CHARACTERS WITHOUT CLAIM TO ANY PARTICULAR FONT, STYLE, SIZE, OR COLOR.

NO CLAIM IS MADE TO THE EXCLUSIVE RIGHT TO USE "TEJAS", APART FROM THE MARK AS SHOWN.

THE FOREIGN WORDING IN THE MARK TRANSLATES INTO ENGLISH AS BULL FROM TEXAS.

CLASS 14—JEWELRY

FOR GOLD, SILVER AND PLATINUM JEWELRY, NAMELY RINGS, NECKLACES, BROACHES, PENDANTS, AND BELT BUCKLES; STATUES MADE OF PRECIOUS METALS (U.S. CLS. 2, 27, 28 AND 50).

CLASS 25—CLOTHING

FOR CLOTHING, NAMELY BELTS, HATS, CAPS, TOPS, PANTS, AND JACKETS (U.S. CLS. 22 AND 39).
SUSAN BILLHEIMER, EXAMINING ATTORNEY



CLASS 35—ADVERTISING AND BUSINESS

FOR PROVIDING COMMUNITY BASED CAREGIVER SUPPORT BY PROMOTING PUBLIC AWARENESS OF CAREGIVER ISSUES AND BY PROMOTING THE INTERESTS OF CAREGIVERS IN THE FIELDS OF PUBLIC POLICY LEGISLATION AND REGULATION (U.S. CLS. 100, 101 AND 102).
FIRST USE 1-1-2001; IN COMMERCE 1-1-2001.

CLASS 41—EDUCATION AND ENTERTAINMENT

FOR EDUCATIONAL SERVICES, NAMELY CONDUCTING COURSES OF STUDY ON ORGANIZING AND PROVIDING COMMUNITY BASED CAREGIVER SERVICES AND SUPPORT (U.S. CLS. 100, 101 AND 107).
FIRST USE 1-1-2001; IN COMMERCE 1-1-2001.
AMEETA JORDAN, EXAMINING ATTORNEY

SN 76-649,354. DAVISON, CLIFTON O., FORT COLLINS, CO. FILED 10-28-2005.

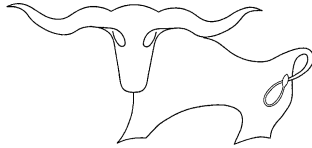

CLASS 14—JEWELRY

FOR GOLD, SILVER AND PLATINUM JEWELRY, NAMELY RINGS, NECKLACES, BROACHES, PENDANTS, AND BELT BUCKLES; STATUES MADE OF PRECIOUS METALS (U.S. CLS. 2, 27, 28 AND 50).

CLASS 25—CLOTHING

FOR CLOTHING, NAMELY BELTS, HATS, CAPS, TOPS, PANTS, AND JACKETS (U.S. CLS. 22 AND 39).
SUSAN BILLHEIMER, EXAMINING ATTORNEY

SN 76-653,105. GENERAL GROWTH PROPERTIES, INC., CHICAGO, IL. FILED 1-9-2006.

A STARK CONTRAST TO THE ORDINARY

THE MARK CONSISTS OF STANDARD CHARACTERS WITHOUT CLAIM TO ANY PARTICULAR FONT, STYLE, SIZE, OR COLOR.

CLASS 35—ADVERTISING AND BUSINESS

FOR PROMOTIONAL AND ADVERTISING SERVICES FOR LESSEES OF SHOPPING CENTERS (U.S. CLS. 100, 101 AND 102).
FIRST USE 6-1-2001; IN COMMERCE 6-1-2001.

CLASS 36—INSURANCE AND FINANCIAL

FOR LEASING AND MANAGEMENT OF REAL ESTATE, NAMELY SHOPPING CENTERS (U.S. CLS. 100, 101 AND 102).
FIRST USE 6-1-2001; IN COMMERCE 6-1-2001.
RONALD MCMORROW, EXAMINING ATTORNEY

SN 76-653,246. DICKSONS, INC., SEYMOUR, IN. FILED 1-11-2006.

SN 76-654,260. SAVINGS OIL COMPANY, TUPELO, MS. FILED 1-30-2006.

F.R.O.G. FULLY RELY ON GOD

THE MARK CONSISTS OF STANDARD CHARACTERS WITHOUT CLAIM TO ANY PARTICULAR FONT, STYLE, SIZE, OR COLOR.

OWNER OF U.S. REG. NOS. 2,307,232, 2,307,233 AND 2,325,566.

CLASS 14—JEWELRY

FOR BRACELETS (U.S. CLS. 2, 27, 28 AND 50).
FIRST USE 1-0-1998; IN COMMERCE 1-0-1998.

CLASS 20—FURNITURE AND ARTICLES NOT OTHERWISE CLASSIFIED

FOR NON-METAL KEYCHAINS (U.S. CLS. 2, 13, 22, 25, 32 AND 50).
FIRST USE 5-0-2000; IN COMMERCE 5-0-2000.

CLASS 22—CORDAGE AND FIBERS

FOR CANVAS BAGS FOR STORAGE OF BIBLES (U.S. CLS. 1, 2, 7, 19, 22, 42 AND 50).
FIRST USE 1-0-1999; IN COMMERCE 1-0-1999.
MARIAM MAHMOUDI, EXAMINING ATTORNEY

SN 76-653,664. GUAVA TECHNOLOGIES, INC., HAYWARD, CA. FILED 8-8-2005.

GUAVA TECHNOLOGIES

THE MARK CONSISTS OF STANDARD CHARACTERS WITHOUT CLAIM TO ANY PARTICULAR FONT, STYLE, SIZE, OR COLOR.

OWNER OF U.S. REG. NOS. 2,570,425, 2,737,829 AND OTHERS.

NO CLAIM IS MADE TO THE EXCLUSIVE RIGHT TO USE "TECHNOLOGIES", APART FROM THE MARK AS SHOWN.

CLASS 1—CHEMICALS

FOR REAGENTS FOR USE IN CELL BIOLOGY FOR SCIENTIFIC AND MEDICAL RESEARCH (U.S. CLS. 1, 5, 6, 10, 26 AND 46).
FIRST USE 4-1-2005; IN COMMERCE 4-1-2005.

CLASS 9—ELECTRICAL AND SCIENTIFIC APPARATUS

FOR COMPUTER SOFTWARE FOR USE IN CELL ANALYZER IN SCIENTIFIC AND MEDICAL RESEARCH; AND LABORATORY EQUIPMENT, NAMELY CELL OR PARTICLE ANALYZERS FOR USE IN CELL ANALYSIS IN SCIENTIFIC AND MEDICAL RESEARCH (U.S. CLS. 21, 23, 26, 36 AND 38).

FIRST USE 8-31-2004; IN COMMERCE 8-31-2004.
TASNEEM HUSSAIN, EXAMINING ATTORNEY

\$AVING\$

OWNER OF U.S. REG. NO. 626,076.

CLASS 35—ADVERTISING AND BUSINESS

FOR RETAIL CONVENIENCE STORE SERVICES (U.S. CLS. 100, 101 AND 102).
FIRST USE 10-0-1963; IN COMMERCE 10-0-1963.

CLASS 37—CONSTRUCTION AND REPAIR

FOR AUTOMOBILE SERVICE STATION SERVICES (U.S. CLS. 100, 103 AND 106).
FIRST USE 10-0-1963; IN COMMERCE 10-0-1963.
AISHA CLARKE, EXAMINING ATTORNEY

SN 76-655,955. THE CURVY CHICK, INC., ROSWELL, GA. FILED 3-2-2006.

CURVY CHICK

THE MARK CONSISTS OF STANDARD CHARACTERS WITHOUT CLAIM TO ANY PARTICULAR FONT, STYLE, SIZE, OR COLOR.

OWNER OF U.S. REG. NO. 2,882,877.

CLASS 38—COMMUNICATION

FOR PROVIDING ONLINE CHAT ROOMS FOR TRANSMISSION OF MESSAGES AMONG COMPUTER USERS CONCERNING WOMEN'S PLUS-SIZE ISSUES (U.S. CLS. 100, 101 AND 104).

FIRST USE 2-0-2002; IN COMMERCE 2-0-2002.

CLASS 41—EDUCATION AND ENTERTAINMENT

FOR PROVIDING INFORMATION VIA AN ON-LINE MAGAZINE AND NEWSLETTER ON THE INTERNET DEVOTED TO WOMEN'S PLUS-SIZE ISSUES, NAMELY EDUCATIONAL, ENTERTAINMENT AND POPULAR CULTURE INFORMATION; ENTERTAINMENT IN THE NATURE OF FASHION EXHIBITIONS AND FASHION SHOWS, AND PROVIDING INFORMATION RELATED THERETO; CONDUCTING CLASSES, CONFERENCES AND SEMINARS WITH REGARD TO PLUS-SIZE ISSUES, AND PROVIDING INFORMATION RELATED THERETO; ENTERTAINMENT SERVICES, NAMELY CONDUCTING MODEL SEARCH CONTESTS FOR PLUS-SIZE MODELS, AND PROVIDING INFORMATION RELATED THERETO (U.S. CLS. 100, 101 AND 107).

FIRST USE 2-0-2002; IN COMMERCE 2-0-2002.
ROBERT LAVACHE, EXAMINING ATTORNEY

SN 76-658,456. WIZARD LIZARD, LLC, ORANGE, CA.
FILED 4-14-2006.

WIZARD LIZARD

THE MARK CONSISTS OF STANDARD CHARACTERS WITHOUT CLAIM TO ANY PARTICULAR FONT, STYLE, SIZE, OR COLOR.

NO CLAIM IS MADE TO THE EXCLUSIVE RIGHT TO USE "WIZARD", APART FROM THE MARK AS SHOWN.

CLASS 9—ELECTRICAL AND SCIENTIFIC APPARATUS

FOR COMPUTER SOFTWARE FOR USE IN PROVIDING INFORMATION AND DISCLOSURES ABOUT GOODS OR SERVICES OFFERED BY OTHERS; COMPUTER SOFTWARE FOR USE IN FACILITATING BUSINESS TO BUSINESS TRANSACTIONS WITH ELECTRONIC SIGNATURES (U.S. CLS. 21, 23, 26, 36 AND 38).

CLASS 42—SCIENTIFIC, COMPUTER AND LEGAL SERVICES

FOR COMPUTER SOFTWARE CONSULTATION; COMPUTER SOFTWARE DESIGN FOR OTHERS; COMPUTER SOFTWARE DEVELOPMENT; DESIGN OF HOMEPAGES AND WEBSITES (U.S. CLS. 100 AND 101).
WARREN L. OLANDRIA, EXAMINING ATTORNEY

SN 76-658,717. AIRERX HEALTHCARE, LLC, NASHVILLE, TN. FILED 4-19-2006.

AIRERX

THE MARK CONSISTS OF STANDARD CHARACTERS WITHOUT CLAIM TO ANY PARTICULAR FONT, STYLE, SIZE, OR COLOR.

CLASS 12—VEHICLES

FOR AIR-CUSHION VEHICLES AND WHEELCHAIR CUSHIONS (U.S. CLS. 19, 21, 23, 31, 35 AND 44).

CLASS 20—FURNITURE AND ARTICLES NOT OTHERWISE CLASSIFIED

FOR CHAIR CUSHIONS; MATTRESS CUSHIONS; AND SEAT CUSHIONS (U.S. CLS. 2, 13, 22, 25, 32 AND 50).
CHRISTINE COOPER, EXAMINING ATTORNEY

SN 76-659,278. F&F EDUCATIONAL SERVICES, LLC, MIAMI, FL. FILED 4-26-2006.



THE MARK CONSISTS OF THE STYLIZED WORD LITTLE ABOVE THE STYLIZED WORD TALENTUM WITH A CIRCLE OF DOTS OVER THE LETTER I.

WHEN TRANSLATED FROM LATIN INTO ENGLISH THE WORD "TALENTUM" MEANS "TALENT".

CLASS 16—PAPER GOODS AND PRINTED MATTER

FOR EDUCATIONAL BOOKS FEATURING CHILDREN'S STORIES, EDUCATIONAL BOOKS FEATURING EARLY CHILDHOOD EDUCATION; GUIDE BOOKS FOR PARENTS AND TEACHERS FEATURING GUIDELINES ABOUT THE USE OF EDUCATIONAL CHILDREN'S BOOKS (U.S. CLS. 2, 5, 22, 23, 29, 37, 38 AND 50).

CLASS 41—EDUCATION AND ENTERTAINMENT

FOR CONSULTING SERVICES IN THE FIELD OF CHILDREN'S EDUCATION (U.S. CLS. 100, 101 AND 107).
PATRICIA EVANKO, EXAMINING ATTORNEY

SN 76-662,054. MURAD, HOWARD, EL SEGUNDO, CA. FILED 6-23-2006.

CULTURAL STRESS

THE MARK CONSISTS OF STANDARD CHARACTERS WITHOUT CLAIM TO ANY PARTICULAR FONT, STYLE, SIZE, OR COLOR.

CLASS 3—COSMETICS AND CLEANING PREPARATIONS

FOR SKIN CARE PRODUCTS, NAMELY EXFOLIATING CREAMS, SKIN CLEANSER, FACIAL SCRUB, NON-MEDICATED SKIN ASTRINGENT FOR COSMETIC PURPOSES, SKIN MOISTURIZER AND NIGHT CREAM; HAND AND BODY MOISTURIZER, BATH AND SHOWER GEL, HAIR SHAMPOO AND HAIR CONDITIONER, SUN BLOCK PREPARATIONS, BATH OIL, ANTI-WRINKLE CREAM, MOISTURE CREAM AND UNDER EYE COVER (U.S. CLS. 1, 4, 6, 50, 51 AND 52).

CLASS 5—PHARMACEUTICALS

FOR VITAMINS AND DIETARY FOOD SUPPLEMENTS (U.S. CLS. 6, 18, 44, 46, 51 AND 52).
DEZMONA MIZELLE, EXAMINING ATTORNEY

SN 76-662,307. MURAD, HOWARD, EL SEGUNDO, CA.
FILED 6-29-2006.

INCLUSIVE HEALTH

THE MARK CONSISTS OF STANDARD CHARACTERS WITHOUT CLAIM TO ANY PARTICULAR FONT, STYLE, SIZE, OR COLOR.

NO CLAIM IS MADE TO THE EXCLUSIVE RIGHT TO USE "HEALTH", APART FROM THE MARK AS SHOWN.

CLASS 3—COSMETICS AND CLEANING PREPARATIONS

FOR SKIN CARE PRODUCTS, NAMELY EXFOLIATING CREAMS, SKIN CLEANSER, FACIAL SCRUB, NON-MEDICATED SKIN ASTRINGENT FOR COSMETIC PURPOSES, SKIN MOISTURIZER AND NIGHT CREAM; HAND AND BODY MOISTURIZER, BATH AND SHOWER GEL, HAIR SHAMPOO AND HAIR CONDITIONER, SUN BLOCK PREPARATIONS, BATH OIL, ANTI-WRINKLE CREAM, MOISTURE CREAM AND UNDER EYE COVER (U.S. CLS. 1, 4, 6, 50, 51 AND 52).

FIRST USE 6-0-2003; IN COMMERCE 6-0-2003.

CLASS 5—PHARMACEUTICALS

FOR VITAMINS AND DIETARY FOOD SUPPLEMENTS (U.S. CLS. 6, 18, 44, 46, 51 AND 52).

FIRST USE 6-0-2003; IN COMMERCE 6-0-2003.

DEZMONA MIZELLE, EXAMINING ATTORNEY

SN 76-664,855. VERDE REALTY OPERATING PARTNERSHIP L.P., EL PASO, TX. FILED 8-21-2006.



SANTA
TERESA

THE TERM "SANTA" TRANSLATES INTO ENGLISH AS "SAINT".

CLASS 36—INSURANCE AND FINANCIAL

FOR REAL ESTATE MANAGEMENT SERVICES; REAL ESTATE INVESTMENT OF COMMERCIAL PROPERTIES; MORTGAGE BANKING AND MORTGAGE PROCUREMENT FOR OTHERS; CONSTRUCTION FINANCING FOR HOMEBUILDERS; INSURANCE UNDERWRITING FOR HOMEBUYERS IN THE FIELDS OF HOME AND AUTO INSURANCE; TITLE INSURANCE UNDERWRITING IN THE FIELD OF REAL ESTATE; FINANCIAL SERVICES, NAMELY, PROVIDING CONSTRUCTION LOAN FINANCING FOR HOMEBUILDERS (U.S. CLS. 100, 101 AND 102).

CLASS 37—CONSTRUCTION AND REPAIR

FOR LAND DEVELOPMENT SERVICES, NAMELY, PLANNING AND LAYING OUT OF RESIDENTIAL AND/OR COMMERCIAL COMMUNITIES, RETAIL, INDUSTRIAL AND DISTRIBUTION SPACE, AND APARTMENTS; COMMERCIAL REAL ESTATE PROPERTY DEVELOPMENT (U.S. CLS. 100, 103 AND 106).

PAUL F. GAST, EXAMINING ATTORNEY

SN 76-664,866. VERDE REALTY OPERATING PARTNERSHIP L.P., EL PASO, TX. FILED 8-21-2006.



SANTA TERESA

THE TERM "SANTA" TRANSLATES INTO ENGLISH AS "SAINT".

CLASS 36—INSURANCE AND FINANCIAL

FOR REAL ESTATE MANAGEMENT SERVICES; REAL ESTATE INVESTMENT OF COMMERCIAL PROPERTIES; MORTGAGE BANKING AND MORTGAGE PROCUREMENT FOR OTHERS; CONSTRUCTION FINANCING FOR HOMEBUILDERS; INSURANCE UNDERWRITING FOR HOMEBUYERS IN THE FIELDS OF HOME AND AUTO INSURANCE; TITLE INSURANCE UNDERWRITING IN THE FIELD OF REAL ESTATE; FINANCIAL SERVICES, NAMELY, PROVIDING CONSTRUCTION LOAN FINANCING FOR HOMEBUILDERS (U.S. CLS. 100, 101 AND 102).

CLASS 37—CONSTRUCTION AND REPAIR

FOR LAND DEVELOPMENT SERVICES, NAMELY, PLANNING AND LAYING OUT OF RESIDENTIAL AND/OR COMMERCIAL COMMUNITIES, RETAIL, INDUSTRIAL AND DISTRIBUTION SPACE, AND APARTMENTS; COMMERCIAL REAL ESTATE PROPERTY DEVELOPMENT (U.S. CLS. 100, 103 AND 106).

PAUL F. GAST, EXAMINING ATTORNEY

SN 76-665,184. VERDE REALTY OPERATING PARTNERSHIP L.P., EL PASO, TX. FILED 8-28-2006.



PLAZA DE ORO

THE WORDING "DE ORO" TRANSLATES INTO ENGLISH AS "OF GOLD".

CLASS 36—INSURANCE AND FINANCIAL

FOR REAL ESTATE MANAGEMENT SERVICES; REAL ESTATE INVESTMENT OF COMMERCIAL PROPERTIES; MORTGAGE BANKING AND MORTGAGE PROCUREMENT FOR OTHERS; CONSTRUCTION FINANCING FOR HOMEBUILDERS; INSURANCE UNDERWRITING FOR HOMEBUYERS IN THE FIELDS OF HOME AND AUTO INSURANCE; TITLE INSURANCE UNDERWRITING IN THE FIELD OF REAL ESTATE; FINANCIAL SERVICES, NAMELY, PROVIDING CONSTRUCTION LOAN FINANCING FOR HOMEBUILDERS (U.S. CLS. 100, 101 AND 102).

CLASS 37—CONSTRUCTION AND REPAIR

FOR LAND DEVELOPMENT SERVICES, NAMELY, PLANNING AND LAYING OUT OF RESIDENTIAL AND/OR COMMERCIAL COMMUNITIES, RETAIL, INDUSTRIAL AND DISTRIBUTION SPACE, AND APARTMENTS; COMMERCIAL REAL ESTATE PROPERTY DEVELOPMENT (U.S. CLS. 100, 103 AND 106).
PAUL F. GAST, EXAMINING ATTORNEY

CLASS 42—SCIENTIFIC, COMPUTER AND LEGAL SERVICES

FOR PROVIDING TEMPORARY USE OF NON-DOWNLOADABLE COMPUTER SOFTWARE FOR UPLOADING DATA OVER THE INTERNET AND THE WORLD WIDE WEB TO A PARTICULAR LOCATION ON THE INTERNET AND WORLD WIDE WEB, FOR AUTOMATICALLY BUILDING WITHIN A HOST WEB SITE A FIXED FORMAT SUB-WEB SITE CONTAINING SUCH UPLOADING DATA, MAKING SUCH FIXED FORMAT SUB WEB SITE AVAILABLE AUTOMATICALLY FOR VIEWING OVER THE INTERNET AND THE WORLD WIDE WEB DIRECTLY AND/OR THROUGH THE HOST WEB SITE, FOR UPLOADING DATA TO AND DOWNLOADING DATA FROM SUCH FIXED FORMAT SUBWEBSITE OVER THE INTERNET AND THE WORLD WIDE WEB FOR MAKING REVISIONS TO THE FIXED FORMAT SUB-WEB SITE AVAILABLE AUTOMATICALLY FOR VIEWING OVER THE INTERNET AND THE WORLD WIDE WEB DIRECTLY AND/OR THROUGH THE HOST WEB SITE FOR AUTOMATICALLY ASSIGNING A UNIQUE URL TO EACH FIXED FORMAT SUB-WEB SITE, FOR AUTOMATICALLY ASSIGNING A UNIQUE NUMBER TO EACH ITEM LISTED FOR SALE ON A FIXED FORMAT SUB-WEB SITE, AND FOR ENABLING THE FIXED FORMAT SUB-WEB SITE PAGE ON WHICH AN ITEM APPEARS TO BE VIEWED OVER THE INTERNET AND WORLD WIDE WEB BY ENTRY OF THAT ITEM'S UNIQUE IDENTIFYING NUMBER INTO A SPECIFIC FIELD THEREFOR CONTAINED IN THE HOST WEB SITE (U.S. CLS. 100 AND 101).

CHERYL CLAYTON, EXAMINING ATTORNEY

SN 76-665,188. VERDE REALTY OPERATING PARTNERSHIP L.P., EL PASO, TX. FILED 8-28-2006.



THE WORDING "DE ORO" TRANSLATES INTO ENGLISH AS "OF GOLD".

CLASS 36—INSURANCE AND FINANCIAL

FOR REAL ESTATE MANAGEMENT SERVICES; REAL ESTATE INVESTMENT OF COMMERCIAL PROPERTIES; MORTGAGE BANKING AND MORTGAGE PROCUREMENT FOR OTHERS; CONSTRUCTION FINANCING FOR HOMEBUILDERS; INSURANCE UNDERWRITING FOR HOMEBUYERS IN THE FIELDS OF HOME AND AUTO INSURANCE; TITLE INSURANCE UNDERWRITING IN THE FIELD OF REAL ESTATE; FINANCIAL SERVICES, NAMELY, PROVIDING CONSTRUCTION LOAN FINANCING FOR HOMEBUILDERS (U.S. CLS. 100, 101 AND 102).

SN 78-224,367. THE GIA CARANGI FOUNDATION, INC., NEW YORK, NY. FILED 3-11-2003.



THE MARK CONSISTS OF A RED RIBBON WRAPPED AROUND A YELLOW ROSE WITH WHITE HIGHLIGHTS AND A LIGHT GREEN STEM.

CLASS 37—CONSTRUCTION AND REPAIR

FOR LAND DEVELOPMENT SERVICES, NAMELY, PLANNING AND LAYING OUT OF RESIDENTIAL AND/OR COMMERCIAL COMMUNITIES, RETAIL, INDUSTRIAL AND DISTRIBUTION SPACE, AND APARTMENTS; COMMERCIAL REAL ESTATE PROPERTY DEVELOPMENT (U.S. CLS. 100, 103 AND 106).
PAUL F. GAST, EXAMINING ATTORNEY

SN 78-154,904. BOATSTOCK.COM, LLC, TOMS RIVER, NJ. FILED 8-16-2002.



CLASS 41—EDUCATION AND ENTERTAINMENT

CLASS 35—ADVERTISING AND BUSINESS

FOR DISSEMINATION OF ADVERTISING FOR OTHERS BY MEANS OF THE INTERNET, THE WORLD WIDE WEB, AND DISTRIBUTION OF HARD COPY MARKETING MATERIALS AND PUBLICATIONS. (U.S. CLS. 100, 101 AND 102).

FOR EDUCATIONAL SERVICES, NAMELY CONDUCTING LECTURES IN ELEMENTARY AND HIGH SCHOOLS IN THE FIELDS OF AIDS PREVENTION AND DRUG ABUSE AND DISTRIBUTING EDUCATIONAL PRINTED MATERIALS IN CONNECTION THEREWITH (U.S. CLS. 100, 101 AND 107).
FIRST USE 11-10-2002; IN COMMERCE 11-10-2002.

CLASS 44—MEDICAL, BEAUTY AND AGRICULTURAL SERVICES

FOR PROVIDING AN ONLINE WEBSITE FEATURING INFORMATION FOR ELEMENTARY SCHOOL STUDENTS AND HIGH SCHOOL STUDENTS IN THE FIELDS OF AIDS PREVENTION AND DRUG ABUSE (U.S. CLS. 100 AND 101).

FIRST USE 11-10-2002; IN COMMERCE 11-10-2002.
JOHN LINCOSKI, EXAMINING ATTORNEY

SN 78-243,705. BOTROS, DAVID, ALHAMBRA, CA. FILED 4-30-2003.

THE CHIMP**CLASS 16—PAPER GOODS AND PRINTED MATTER**

FOR NEWSPAPERS DEALING WITH COMEDY, ENTERTAINMENT AND GENERAL INTEREST TOPICS; MAGAZINES DEALING WITH COMEDY AND ENTERTAINMENT; BOOKS DEALING WITH COMEDY AND ENTERTAINMENT; SYNDICATED COLUMNS DEALING WITH COMEDY AND ENTERTAINMENT; SYNDICATED MAGAZINE SECTIONS DEALING WITH COMEDY AND ENTERTAINMENT; SYNDICATED NEWSPAPER COLUMNS DEALING WITH COMEDY, ENTERTAINMENT AND GENERAL INTEREST; AND COMIC STRIPS, ART PRINTS, POSTERS, CALENDARS, GREETING CARDS, POSTCARDS AND STICKERS (U.S. CLS. 2, 5, 22, 23, 29, 37, 38 AND 50).

FIRST USE 11-0-1993; IN COMMERCE 11-0-1993.

CLASS 25—CLOTHING

FOR CLOTHING, NAMELY, SHIRTS, T-SHIRTS, TOPS, SHORTS, SWIM WEAR, HEADWEAR, HATS, BEANIES, CAPS, SWEATERS, SWEAT SHIRTS, PANTS, SWEAT PANTS, BOXER SHORTS, SLEEPWEAR, SOCKS, NECKWEAR, TIES, JACKETS, FOOTWEAR, ALL DEPICTING APPLICANT'S PROPRIETARY CARTOON AND ANIMATED CHARACTER AND SOLD EXCLUSIVELY TO TEENAGERS AND ADULTS (U.S. CLS. 22 AND 39).

FIRST USE 4-0-1994; IN COMMERCE 4-0-1994.
CATHERINE FAINT, EXAMINING ATTORNEY

SN 78-264,320. ARBESKO AB, ÖREBRO, SWEDEN, FILED 6-19-2003.

DYPROFLEX

PRIORITY CLAIMED UNDER SEC. 44(D) ON ERPN CMNTY TM OFC APPLICATION NO. 3172236, FILED 5-19-2003, REG. NO. 003172236, DATED 3-24-2006, EXPIRES 3-24-2016.

CLASS 9—ELECTRICAL AND SCIENTIFIC APPARATUS

FOR (INTENT TO USE, 44(D)) CLOTHING AND SHOES FOR PROTECTION AGAINST INJURIES (U.S. CLS. 21, 23, 26, 36 AND 38).

CLASS 24—FABRICS

FOR (INTENT TO USE) TEXTILE FABRICS FOR USE IN THE MANUFACTURE OF CLOTHING AND OF SHOES (U.S. CLS. 42 AND 50).

CLASS 25—CLOTHING

FOR (INTENT TO USE) CLOTHING, NAMELY, SHIRTS, VESTS, JACKETS AND PANTS; FOOTWEAR; HATS AND CAPS (U.S. CLS. 22 AND 39).

NANCY CLARKE, EXAMINING ATTORNEY

SN 78-274,104. KLOETZLY, BOBBY, SANTA ANA, CA. FILED 7-14-2003.

LUCKY 13

OWNER OF U.S. REG. NOS. 2,970,316 AND 2,974,104.

CLASS 25—CLOTHING

FOR CLOTHING AND FOOTWEAR FOR MEN AND WOMEN NAMELY ATHLETIC SHOES, ATHLETIC SPORTS SUITS, BELTS, BLOUSES, BODY SUITS, CARDIGANS, COATS, DRESSES, GOWNS, GLOVES, GYM SUITS, HATS, JACKETS, JEANS, JOGGING SUITS, OVERALLS; PANTS, NAMELY CAPRI PANTS, CHINO PANTS, WORK PANTS; ROBES, SANDALS, SHIRTS NAMELY, POLO SHIRTS, JERSEY SHIRTS, DINER SHIRTS, BOWLING SHIRTS, FLANNEL SHIRTS, SPORT SHIRTS; SHOES, BOOTS, SHORTS, NAMELY BOARD SHORTS, CHINO SHORTS, WALKING SHORTS, HIKING SHORTS; SKIRTS, SLEEPWEAR, SLIPPERS, SNEAKERS, SUSPENDERS, SWEATERS, SWEATSHIRTS, SWIMWEAR, TOPS, T-SHIRTS, UNDERWEAR, WARM-UP SUITS, BEACH CLOTHES AND SURF WEAR NAMELY BATHING SUITS, BOARD SHORTS, CAMI-SOLE TOPS, MIDRIFF TOPS, PANTS, SKIRTS, SWEATSHIRTS, SWEAT PANTS, TANK TOPS, TIE TOPS; VESTS, SWEATERS, SANDALS, HEAD WEAR, NAMELY SUN VISORS, CAPS, HATS (U.S. CLS. 22 AND 39).

FIRST USE 5-7-1992; IN COMMERCE 5-7-1992.

CLASS 35—ADVERTISING AND BUSINESS

FOR RETAIL STORE SERVICES AND ON-LINE RETAIL SERVICES AVAILABLE VIA THE INTERNET IN THE FIELD OF ELECTRICAL GOODS, LAMPS, OPTICAL GOODS AND SUNGLASSES, AUDIO TAPES, CDS, RECORDS AND VIDEO TAPES, TELEPHONES AND MOBILE PHONES, JEWELRY, HOROLOGICAL AND CHRONOMETRIC GOODS, STATIONERY, PRINTED PUBLICATIONS AND PRINTED MATTER, CARDS, GIFT WRAP, FURNITURE, FURNISHINGS AND DECORATIONS, BED AND TABLE LINEN, COMFORTERS, TOWELS, CLOTHING, FOOTWEAR, HEADGEAR, TOYS, GAMES, PLAYTHINGS SPORTING GOODS AND ACCESSORIES NAMELY BELT BUCKLES, CANDLES, CLOCKS, COASTER SETS, GEAR BAGS, LIGHTERS, POSTERS (U.S. CLS. 100, 101 AND 102).

FIRST USE 5-7-1999; IN COMMERCE 9-1-1999.
KATHLEEN M. VANSTON, EXAMINING ATTORNEY

SN 78-283,408. TERRESCA IMPORTS LTD., PLANO, TX. FILED 8-5-2003.

EARTH GROWN GOODNESS

NO CLAIM IS MADE TO THE EXCLUSIVE RIGHT TO USE "EARTH GROWN", APART FROM THE MARK AS SHOWN.

CLASS 29—MEATS AND PROCESSED FOODS

FOR PROCESSED FRUITS AND VEGETABLES, JELLIES, JAMS, CHEESE, OLIVE OIL (U.S. CL. 46).

CLASS 30—STAPLE FOODS

FOR VINEGAR, SAUCES, SPICES, SALAD DRESSINGS (U.S. CL. 46).
KATHLEEN M. VANSTON, EXAMINING ATTORNEY

SN 78-285,568. METALSMITHS MASTER ARCHITECTS OF JEWELRY INC., EDMONTON, ALBERTA, CANADA, FILED 8-11-2003.

Metalsmiths

MASTER ARCHITECTS OF JEWELRY

PRIORITY CLAIMED UNDER SEC. 44(D) ON CANADA APPLICATION NO. 1,183,657, FILED 7-8-2003, REG. NO. TMA615160, DATED 7-19-2004, EXPIRES 7-19-2019.

OWNER OF U.S. REG. NO. 2,794,547.

NO CLAIM IS MADE TO THE EXCLUSIVE RIGHT TO USE "METALSMITHS" AND "JEWELRY", APART FROM THE MARK AS SHOWN.

CLASS 14—JEWELRY

FOR JEWELRY; COSTUME JEWELRY, PRECIOUS METAL AND NON-PRECIOUS METAL JEWELRY, JEWELRY WITH AND WITHOUT PRECIOUS GEMSTONES, PRECIOUS GEMSTONES, SEMI-PRECIOUS GEMSTONES, JEWELRY NAMELY RINGS, EARRINGS, BRACELETS, BANGLES, WRIST BANDS, NECKLACES, PENDANTS, ORNAMENTAL PINS, BROOCHES AND BODY JEWELRY, JEWELRY NAMELY STERLING SILVER JEWELRY, JEWELRY INCORPORATING PRECIOUS OR SEMI-PRECIOUS STONES, WATCHES, BEADS FOR USE IN THE MANUFACTURE OF JEWELRY, PEARLS (U.S. CLS. 2, 27, 28 AND 50).

CLASS 35—ADVERTISING AND BUSINESS

FOR RETAIL SHOPS, MAIL ORDER SERVICES, TELEPHONE SHOP AT HOME AND ON-LINE RETAIL STORE SERVICES FEATURING JEWELRY, RETAIL SHOP AT HOME PARTY SERVICES FEATURING JEWELRY, AND RETAIL JEWELRY STORES (U.S. CLS. 100, 101 AND 102).

TONJA GASKINS, EXAMINING ATTORNEY

SN 78-293,983. RIEMANN TRADING APS, HILLEROD, DENMARK, FILED 8-29-2003.

PRIORITY CLAIMED UNDER SEC. 44(D) ON DENMARK APPLICATION NO. VA200301160, FILED 3-21-2003, REG. NO. VR200302319, DATED 7-3-2003, EXPIRES 7-3-2013.
OWNER OF U.S. REG. NO. 2,413,047.

CLASS 3—COSMETICS AND CLEANING PREPARATIONS

FOR SUN SCREEN PREPARATIONS (U.S. CLS. 1, 4, 6, 50, 51 AND 52).

CLASS 5—PHARMACEUTICALS

FOR MEDICATED SUN SCREEN PREPARATIONS (U.S. CLS. 6, 18, 44, 46, 51 AND 52).
KATHERINE STOIDES, EXAMINING ATTORNEY

SN 78-317,782. MARS, INCORPORATED, MC LEAN, VA, FILED 10-23-2003.

V.O.L.T. VISUALIZER

PRIORITY CLAIMED UNDER SEC. 44(D) ON ERPNCMNTY TM OFC APPLICATION NO. 003143633, FILED 4-24-2003, REG. NO. 003143633, DATED 11-19-2004, EXPIRES 4-24-2013.

NO CLAIM IS MADE TO THE EXCLUSIVE RIGHT TO USE VISUALIZER, APART FROM THE MARK AS SHOWN.

CLASS 9—ELECTRICAL AND SCIENTIFIC APPARATUS

FOR SOFTWARE FOR OPTIMIZING PRODUCT ARRANGEMENT WITHIN A VENDING MACHINE AND DISPLAYING THE OPTIMIZED PRODUCT ARRANGEMENT (U.S. CLS. 21, 23, 26, 36 AND 38).

CLASS 35—ADVERTISING AND BUSINESS

FOR ADVICE IN THE FIELD OF BUSINESS MANAGEMENT AND MARKETING; ADVICE ON THE ANALYSIS OF CONSUMER BUYING HABITS AND NEEDS PROVIDED WITH THE HELP OF SENSORY, QUALITY AND QUANTITY-RELATED DATA; ADVICE RELATING TO THE MANAGEMENT OF BUSINESS; ADVISORY SERVICES RELATING TO BUSINESS MANAGEMENT AND BUSINESS OPERATIONS; BUSINESS CONSULTING SERVICES RELATING TO OPERATIONS MANAGEMENT SERVICES, LOGISTICS, REVERSE LOGISTICS, SUPPLY CHAIN, AND PRODUCTION SYSTEMS AND DISTRIBUTION SOLUTIONS; BUSINESS INTERMEDIARY AND ADVISORY SERVICES IN THE FIELD OF SELLING PRODUCTS AND RENDERING SERVICES; BUSINESS PLANNING; INFORMATION AND DATA COMPILING AND ANALYZING RELATING TO BUSINESS MANAGEMENT; VENDING MACHINE SERVICES ALL RELATING TO VENDING AND DISPENSING MACHINES AND TO SOFTWARE, PARTS AND FITTINGS THEREFORE, AND TO PRODUCTS SOLD OR DISPENSED THROUGH SUCH MACHINES (U.S. CLS. 100, 101 AND 102).

DAVID TAYLOR, EXAMINING ATTORNEY

SN 78-324,797. INTELLIAS INC., SAINT LOUIS, MO. FILED 11-7-2003.

SN 78-325,585. AUSTRALIAN BODYCARE CONTINENTAL A/S, VISSENBJERG, DENMARK, FILED 11-10-2003.

INTELLIAS

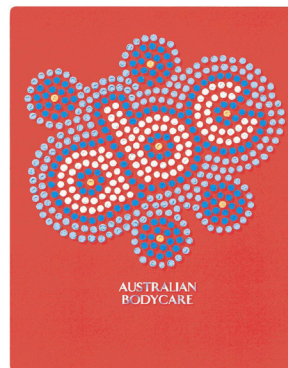

THE MARK CONSISTS OF STANDARD CHARACTERS WITHOUT CLAIM TO ANY PARTICULAR FONT, STYLE, SIZE, OR COLOR.

CLASS 9—ELECTRICAL AND SCIENTIFIC APPARATUS

FOR SOFTWARE DOWNLOADABLE FROM THE INTERNET IN THE FIELD OF EMPLOYEE HUMAN RESOURCES, PAYROLL AND FINANCIAL SERVICES, FOR PERFORMING THE FUNCTIONS OF BACK OFFICE MANAGEMENT, EMPLOYEE BENEFITS ADMINISTRATION AND PROCESSING, PAYROLL ADMINISTRATION AND PROCESSING, FINANCIAL ACCOUNTING ADMINISTRATION AND PROCESSING, AND DATABASE MANAGEMENT (U.S. CLS. 21, 23, 26, 36 AND 38).

FIRST USE 1-1-2003; IN COMMERCE 1-1-2003.

CLASS 42—SCIENTIFIC, COMPUTER AND LEGAL SERVICES

FOR SOFTWARE DEVELOPMENT SERVICES IN THE FIELD OF EMPLOYEE HUMAN RESOURCES, PAYROLL AND FINANCIAL SERVICES (U.S. CLS. 100 AND 101).

FIRST USE 1-1-2003; IN COMMERCE 1-1-2003.

ELIZABETH HUGHITT, EXAMINING ATTORNEY

PRIORITY CLAIMED UNDER SEC. 44(D) ON ERPN CMNTY TM OFC APPLICATION NO. 3205655, FILED 5-15-2003, REG. NO. 003205655, DATED 1-3-2005, EXPIRES 5-15-2013.

THE COLOR(S) TERRACOTTA (PANTONE NOS 173C AND 174C), BLUE (PANTONE NO. 3005C), BLUE (PANTONE 306C), POWDER BLUE (PANTONE 317C), YELLOW (PANTONE NO. 114C) AND SILVER IS/ARE CLAIMED AS A FEATURE OF THE MARK.

THE MARK CONSISTS OF THE LETTERS ABC IN SILVER DOTS OUTLINED WITH BLUE AND POWDER BLUE DOTS ACCENTED WITH YELLOW ON A TERRACOTTA BACKGROUND.

CLASS 3—COSMETICS AND CLEANING PREPARATIONS

FOR PERFUMERY; ESSENTIAL OILS FOR PERSONAL USE AND USE IN PERFUMERY; COSMETICS AND HAIR LOTIONS; HAIR SHAMPOOS AND CONDITIONERS; SOAPS; AFTERSHAVE LOTIONS; ANTIPERSPIRANTS; ASTRINGENT FOR COSMETIC PURPOSES; BATH SALTS, NOT FOR MEDICAL PURPOSES; BEAUTY MASKS; COSMETIC KITS COMPRISED OF EYELINERS, EYE SHADOWS, BLUSHERS, LIPSTICKS, ROUGES, FOUNDATIONS, MASCARAS; COSMETIC BODY CREAMS; DEODORANTS FOR PERSONAL USE; ESSENTIAL OILS FOR BEVERAGE FLAVOURINGS; HAIR COLORANTS AND DYES; HAIRSPRAYS; HAIR-WAVING PREPARATIONS; INCENSE; LIPSTICKS; MAKE-UP; MAKE-UP REMOVING PREPARATIONS; MEDICATED SOAP; MOUTHWASH, NOT FOR MEDICAL PURPOSES; NAIL CARE PREPARATIONS; SCENTED WATER; NON-MEDICATED, NON-VETERINARY GROOMING SHAMPOO FOR PETS; SHAVING PREPARATIONS AND SOAPS; SUNSCREEN PRODUCTS AND SUN-TANNING PREPARATIONS; TOILETRIES, NAMELY PERFUMES AND TOILET WATER, TOOTH-PASTES, MOISTURIZERS, ANTI-AGING CREME, ANTI-WRINKLE CREME, EXFOLIATING PREPARATIONS; BLEACHING PREPARATIONS AND OTHER SUBSTANCES, NAMELY LAUNDRY DETERGENT, FLOOR STRIPPING/CLEANING PREPARATIONS; GENERAL PURPOSE CLEANING, POLISHING, SCOURING AND ABRASIVE PREPARATIONS; BOOT AND SHOE CREAMS AND POLISHES; STAIN REMOVERS; DENTIFRICES (U.S. CLS. 1, 4, 6, 50, 51 AND 52).

CLASS 5—PHARMACEUTICALS

FOR PHARMACEUTICAL, VETERINARY AND SANITARY PREPARATIONS FOR THE TREATMENT OR ERIDATION OF BACTERIA, FUNGI AND VIRUS ON THE SKIN AND MUCOUS MEMBRANES; MEDICATED SKIN WASHES, LOTIONS, CREAMS, OINTMENTS AND GELS, ALL FOR USE IN THE TREATMENT OF HERPES INFECTIONS; NATURAL MEDICINAL PREPARATIONS, NAMELY HERBAL SUPPLEMENTS; DIETETIC SUBSTANCES ADAPTED FOR MEDICAL USES NAMELY DIET PILLS; FOOD FOR BABIES; DIETARY SUPPLEMENTS AND DIETARY DRINK MIX FOR USE AS A FULL OR PARTIAL MEAL REPLACEMENT; WOUND, BURN AND SURGICAL DRESSINGS; MEDICAL PLASTER AND BANDAGES FOR SKIN WOUNDS; SURGICAL AND WOUND DRESSINGS; MATERIAL FOR STOPPING TEETH, DENTAL WAX; DISINFECTANTS; ALL PURPOSE DISINFECTANTS, ALL PURPOSE ANTIBACTERIAL, ANTIFUNGAL AND ANTIVIRAL PREPARATIONS; PREPARATIONS FOR DESTROYING VERMIN; FUNGICIDES FOR DOMESTIC AND/OR AGRICULTURAL USES, MITICIDES FOR DOMESTIC AND/OR AGRICULTURAL USES, INSECTICIDES AND HERBICIDES FOR DOMESTIC AND AGRICULTURAL USE; MEDICATED MOUTHWASHES; ANTISEPTICS; BALMS FOR MEDICAL PURPOSES; BATH PREPARATIONS AND SALTS FOR MEDICAL PURPOSES; MEDICATED CONFECTIONERY, NAMELY LOZENGES; INSECT REPELLANT IN THE NATURE OF INCENSE; LINIMENTS; LOZENGES AND PASTILLES FOR PHARMACEUTICAL PURPOSES; MEDICINAL HERBS, HERB INFUSIONS, OILS, ROOTS AND TEAS FOR MEDICINAL PURPOSES; MENTHOL VAPOR BATH PREPARATIONS FOR BABIES; HERBAL MUD PACKS FOR THERAPEUTIC PURPOSES; ROYAL JELLY FOR MEDICAL PURPOSES; MEDICATED SALTS FOR MINERAL WATER BATHS; MEDICATED SUNBURN OINTMENTS; VITAMIN SUPPLEMENTS (U.S. CLS. 6, 18, 44, 46, 51 AND 52).

CLASS 44—MEDICAL, BEAUTY AND AGRICULTURAL SERVICES

FOR HEALTH, HYGIENE AND BEAUTY CARE SERVICES, NAMELY PROVIDING FITNESS CENTER SERVICES; HEALTH SPAS, NAMELY COSMETIC BODY CARE SERVICES; ACUPUNCTURE; AROMATHERAPY; BEAUTY SALONS; HAIRDRESSING SALONS; CHIROPRACTICS; CHIROPODY; MANICURING; MASSAGE; PHYSICAL THERAPY; PHYSIOTHERAPY; REFLEXOLOGY; PUBLIC BATHS FOR HYGIENE PURPOSES; CONVALESCENT HOMES; REST HOMES; REHABILITATION FOR SUBSTANCE ABUSE PATIENTS; HOSPICES; AGRICULTURAL AND FORESTRY ADVICE SERVICES; HORTICULTURAL SERVICES; ORGANIC FARM SEEDING BY AIR; VETERINARY ASSISTANCE; AND CONSULTING SERVICES RELATING TO ALL AFORESAID SERVICES (U.S. CLS. 100 AND 101).

JOSETTE BEVERLY, EXAMINING ATTORNEY

SN 78-328,777. PITNEY BOWES INC., STAMFORD, CT. FILED 11-17-2003.



OWNER OF U.S. REG. NO. 2,817,069.

CLASS 9—ELECTRICAL AND SCIENTIFIC APPARATUS

FOR INK JET PRINTERS, NAMELY, PRINTERS THAT ADDRESS AND PROCESS MAIL PIECES USING BAR-CODE TECHNOLOGY (U.S. CLS. 21, 23, 26, 36 AND 38). FIRST USE 9-30-2002; IN COMMERCE 9-30-2002.

CLASS 16—PAPER GOODS AND PRINTED MATTER

FOR INSERTING SYSTEM, NAMELY AN INSERTER COMPRISING A COLLATOR, FEEDER, SORTER AND FOLDING APPARATUS FOR INSERTION OF DOCUMENTS WITHIN CORRESPONDING ENVELOPES TO PRODUCE FINISHED MAIL PIECES; AUTOMATIC LABEL AFFIXING MACHINES FOR ENVELOPES, POSTCARDS, NEWSLETTERS, BOOKLETS OR ANY OTHER TYPE OF MEDIA PIECES FOR COMMERCIAL USE (U.S. CLS. 2, 5, 22, 23, 29, 37, 38 AND 50).

FIRST USE 7-31-2002; IN COMMERCE 9-30-2003. BRIDGETT SMITH, EXAMINING ATTORNEY

SN 78-366,042. FIRSTREEF, LLC, SNELLVILLE, GA. FILED 2-11-2004.

FIRSTREEF

THE MARK CONSISTS OF STANDARD CHARACTERS WITHOUT CLAIM TO ANY PARTICULAR FONT, STYLE, SIZE, OR COLOR.

CLASS 9—ELECTRICAL AND SCIENTIFIC APPARATUS

FOR COMPUTER SOFTWARE FOR USE IN STORING, MANAGING, TRACKING, ANALYZING AND REPORTING DATA IN THE FIELD OF MARKETING, PROMOTION, SALES, CUSTOMER INFORMATION, CUSTOMER RELATIONSHIP MANAGEMENT, SALES SUPPORT AND EMPLOYEE EFFICIENCY; COMPUTER SOFTWARE FOR USE IN CREATING STATISTICAL AND MANAGEMENT REPORTS ON MARKETING, PROMOTION, SALES, CUSTOMER RELATIONSHIP MANAGEMENT, CUSTOMER SUPPORT SERVICES AND EMPLOYEE EFFICIENCY; COMPUTER SOFTWARE FOR USE IN FACILITATING COMMUNICATING AMONG PEER PROFESSIONALS IN THE ADVERTISING, MARKETING AND BUSINESS SERVICES FIELDS; COMPUTER SOFTWARE FOR USE IN MOBILE COMMUNICATION DEVICES; COMPUTER SOFTWARE DEVELOPMENT TOOLS; COMPUTER SOFTWARE FOR USE IN APPLICATION AND DATABASE INTEGRATION; COMPUTER SOFTWARE FOR USE IN COLLECTING, ORGANIZING, MODIFYING, TRANSMITTING, STORING, AND SHARING OF DATA AND INFORMATION; GRAPHICAL USER INTERFACE SOFTWARE (U.S. CLS. 21, 23, 26, 36 AND 38).

FIRST USE 4-15-2005; IN COMMERCE 4-15-2005.

CLASS 42—SCIENTIFIC, COMPUTER AND LEGAL SERVICES

FOR COMPUTER SOFTWARE CONSULTATION SERVICES (U.S. CLS. 100 AND 101).
FIRST USE 5-4-2005; IN COMMERCE 5-4-2005.
DAWN HAN, EXAMINING ATTORNEY

SN 78-422,294. THE OPRAH WINFREY FOUNDATION, CHICAGO, IL. FILED 5-20-2004.

OPRAH'S 21ST CENTURY SCHOOLS

THE MARK CONSISTS OF STANDARD CHARACTERS WITHOUT CLAIM TO ANY PARTICULAR FONT, STYLE, SIZE, OR COLOR.

NO CLAIM IS MADE TO THE EXCLUSIVE RIGHT TO USE "SCHOOLS", APART FROM THE MARK AS SHOWN. THE NAME OPRAH IDENTIFIES A LIVING INDIVIDUAL WHOSE CONSENT IS OF RECORD.

SN 78-377,956. REMAS.GOV, LLC, ENGLEWOOD, CO. FILED 3-3-2004.

REMAS**CLASS 36—INSURANCE AND FINANCIAL**

FOR PROVIDING EDUCATIONAL SCHOLARSHIPS; CHARITABLE FUNDRAISING SERVICES, NAMELY, ENCOURAGING DONATIONS FOR EDUCATIONAL AND HEALTH PURPOSES (U.S. CLS. 100, 101 AND 102).

CLASS 41—EDUCATION AND ENTERTAINMENT

FOR OPERATING SCHOOLS AND OTHER LEARNING CENTERS FEATURING PRIMARY AND SECONDARY GRADE LEVELS; EDUCATIONAL SERVICES, NAMELY, DEVELOPMENT OF CURRICULA FOR SCHOOLS AND LEARNING CENTERS; PROVIDING EDUCATIONAL SERVICES, NAMELY PROVIDING COURSES OF INSTRUCTION AT THE PRIMARY AND SECONDARY GRADE LEVEL VIA SCHOOLS AND OTHER LEARNING CENTERS; PROVIDING EDUCATIONAL SERVICES, NAMELY, CONDUCTING CLASSES IN THE FIELD OF HEALTH EDUCATION VIA SCHOOLS AND OTHER LEARNING CENTERS (U.S. CLS. 100, 101 AND 107).

CLASS 44—MEDICAL, BEAUTY AND AGRICULTURAL SERVICES

FOR HEALTH SERVICES, NAMELY, ARRANGING FOR HEALTHCARE SERVICES FOR CHILDREN (U.S. CLS. 100 AND 101).

ALLISON HOLTZ, EXAMINING ATTORNEY

THE MARK CONSISTS OF STANDARD CHARACTERS WITHOUT CLAIM TO ANY PARTICULAR FONT, STYLE, SIZE, OR COLOR.

CLASS 42—SCIENTIFIC, COMPUTER AND LEGAL SERVICES

FOR MONITORING THE COMPUTER SYSTEMS OF OTHERS FOR TECHNICAL PURPOSES AND PROVIDING BACK-UP COMPUTER PROGRAMS AND FACILITIES, NAMELY, ELECTRONIC AND NETWORK MONITORING OF EQUIPMENT USED FOR THE PURPOSE OF DATA COLLECTION, DATA ACQUISITION IN THE NATURE OF EQUIPMENT STATUS, MEASURED VALUES, MODULATION FOR TRANSMISSION, REAGGREGATION OF DATA INCLUDING DATABASE AND USER INTERFACES (U.S. CLS. 100 AND 101).

FIRST USE 4-1-2003; IN COMMERCE 4-1-2003.

SN 78-427,977. CHANDRASEKARAN, VENKATESWARAN, AUSTIN, TX. AND RENGASAMY, ANJAPPAR, CHENNAI, INDIA, AND KANDASAMY, ANJAPPAR, CHENNAI, INDIA, AND MARUDHUPANDIAN, ANJAPPAR, CHENNAI, INDIA, FILED 6-1-2004.

**CLASS 45—PERSONAL SERVICES**

FOR MONITORING OF COMPUTER SYSTEMS FOR SECURITY PURPOSES, NAMELY, ANNUNCIATION SERVICES IN THE NATURE OF ALARM NOTIFICATION, PROVIDED BY MEANS OF COMMUNICATIONS NETWORKS, IN THE FIELD OF GOVERNMENT, MILITARY AND ENERGY (U.S. CLS. 100 AND 101).

FIRST USE 4-1-2003; IN COMMERCE 4-1-2003.

JOHN SCHUYLER YARD, EXAMINING ATTORNEY

NO CLAIM IS MADE TO THE EXCLUSIVE RIGHT TO USE "CHETTINAD RESTAURANT", APART FROM THE MARK AS SHOWN.

THE COLOR(S) RED, BLUE AND GREEN IS/ARE CLAIMED AS A FEATURE OF THE MARK.

THE MARK CONSISTS OF RED CHICKEN, BLUE FISH, GREEN DISH, BLUE WORD ANJAPPAR, RED WORDS CHETTINAD RESTAURANT, RED, BLUE AND GREEN LINES.

SEC. 2(F).

CLASS 29—MEATS AND PROCESSED FOODS

FOR ENTREES MADE FROM CHICKEN, MUTTON AND FISH, INCLUDING ANJAPPAR FRIED CHICKEN, TANDOORI PARATTHA, CHETTINAD FISH MASSALA, MUTTON SUKKA VARUVAL AND OTHERS (U.S. CL. 46).

CLASS 43—HOTEL AND RESTAURANT SERVICES

FOR RESTAURANT (FOOD SERVICE) SERVICES (U.S. CLS. 100 AND 101).
KIMBERLY FRYE, EXAMINING ATTORNEY

CLASS 41—EDUCATION AND ENTERTAINMENT

FOR PUBLICATION OF PRINTED PROGRAMS ABOUT CINEMATOGRAPHIC FILMS; PRODUCTION OF VIDEOS CONTAINING CINEMATOGRAPHIC FILMS NAMELY HOME VIDEOS; DISTRIBUTION AND EXHIBITION OF CINEMATOGRAPHIC FILMS (U.S. CLS. 100, 101 AND 107).

HOWARD B. LEVINE, EXAMINING ATTORNEY

SN 78-442,216. BECTON, DICKINSON AND COMPANY, FRANKLIN LAKES, NJ. FILED 6-28-2004.

SN 78-430,118. CARNABY PRODUCTIONS PLC, LONDON, UNITED KINGDOM, FILED 6-4-2004.

Campy Pouch

SPIVS

THE MARK CONSISTS OF STANDARD CHARACTERS WITHOUT CLAIM TO ANY PARTICULAR FONT, STYLE, SIZE, OR COLOR.

PRIORITY CLAIMED UNDER SEC. 44(D) ON ERPN CMNTY TM OFC APPLICATION NO. 003578358, FILED 1-13-2004, REG. NO. 003578358, DATED 5-7-2005, EXPIRES 5-7-2015.

CLASS 9—ELECTRICAL AND SCIENTIFIC APPARATUS

FOR PRE-RECORDED COMPACT DISCS, VIDEO-TAPES, CD-ROMS, AUDIOTAPES, LASER DISKS AND DVDS FEATURING CINEMATOGRAPHIC FILMS; COMPUTER SOFTWARE FOR USE IN PRODUCING CINEMATOGRAPHIC FILMS; DOWNLOADABLE ELECTRONIC PUBLICATIONS, NAMELY, MAGAZINES AND NEWSLETTERS, PERTAINING TO CINEMATOGRAPHIC FILMS (U.S. CLS. 21, 23, 26, 36 AND 38).

CLASS 16—PAPER GOODS AND PRINTED MATTER

FOR PRINTED MATTER, NAMELY, BOOKS, MAGAZINES, POSTERS, PROGRAMS, POST CARDS, STATIONERY, STICKERS AND ALBUMS RELATING TO CINEMATOGRAPHIC FILMS (U.S. CLS. 2, 5, 22, 23, 29, 37, 38 AND 50).

CLASS 25—CLOTHING

FOR ARTICLES OF CLOTHING, NAMELY, T-SHIRTS, SHIRTS, TOPS, VESTS, TROUSERS, PANTS, SKIRTS, COATS, JUMPERS, JACKETS, SWEATERS, LINGERIE; HEADGEAR, NAMELY, HATS, CAPS AND SCARVES (U.S. CLS. 22 AND 39).

THE MARK CONSISTS OF STANDARD CHARACTERS WITHOUT CLAIM TO ANY PARTICULAR FONT, STYLE, SIZE, OR COLOR.

NO CLAIM IS MADE TO THE EXCLUSIVE RIGHT TO USE POUCH, APART FROM THE MARK AS SHOWN.

CLASS 1—CHEMICALS

FOR DISPOSABLE MEDICAL POUCHES USED FOR CREATING CULTURE GROWTH ENVIRONMENT FOR RESEARCH AND SCIENTIFIC PURPOSES (U.S. CLS. 1, 5, 6, 10, 26 AND 46).

FIRST USE 12-31-1985; IN COMMERCE 12-31-1985.

CLASS 10—MEDICAL APPARATUS

FOR DISPOSABLE MEDICAL POUCHES USED FOR CREATING CULTURE GROWTH ENVIRONMENT FOR MEDICAL USE (U.S. CLS. 26, 39 AND 44).

FIRST USE 12-31-1985; IN COMMERCE 12-31-1985.
STEPHANIE DAVIS, EXAMINING ATTORNEY

SN 78-442,594. LENDERS WHO CARE, SANTA ANA, CA. FILED 6-28-2004.

LENDERS WHO CARE

THE MARK CONSISTS OF STANDARD CHARACTERS WITHOUT CLAIM TO ANY PARTICULAR FONT, STYLE, SIZE, OR COLOR.

OWNER OF U.S. REG. NO. 3,078,923.

CLASS 35—ADVERTISING AND BUSINESS

FOR PROVIDING AN ONLINE DIRECTORY OF MEMBER LENDERS TO FACILITATE THE EDUCATION OF CONSUMERS AND LENDERS IN THE FIELD OF AFFORDABLE HOUSING LOAN PROGRAMS (U.S. CLS. 100, 101 AND 102).

FIRST USE 9-30-2003; IN COMMERCE 9-30-2003.

CLASS 36—INSURANCE AND FINANCIAL

FOR PROVIDING IN PERSON AND COMPUTERIZED ON-LINE INFORMATION TO CONSUMERS AND LENDER IN THE FIELD OF AFFORDABLE HOUSING LOAN PROGRAMS (U.S. CLS. 100, 101 AND 102).

FIRST USE 9-30-2003; IN COMMERCE 9-30-2003.

CLASS 41—EDUCATION AND ENTERTAINMENT

FOR EDUCATIONAL SERVICES, NAMELY, CONDUCTING CLASSES, CONFERENCES, SEMINARS, AND WORKSHOPS FOR CONSUMERS AND LENDERS IN THE FIELD OF AFFORDABLE HOUSING LOAN PROGRAMS; PROVIDING AN ON-LINE COMPUTER DATABASE IN THE FIELD OF TRAINING LENDERS WITH RESPECT TO AFFORDABLE HOUSING LOAN PROGRAMS (U.S. CLS. 100, 101 AND 107).

FIRST USE 9-30-2003; IN COMMERCE 9-30-2003.
BARNEY CHARLON, EXAMINING ATTORNEY

SN 78-447,036. ELBA S.P.A., TREVISO, ITALY, FILED 7-7-2004.

ELBA

THE MARK CONSISTS OF STANDARD CHARACTERS WITHOUT CLAIM TO ANY PARTICULAR FONT, STYLE, SIZE, OR COLOR.

PRIORITY CLAIMED UNDER SEC. 44(D) ON ITALY APPLICATION NO. MI2004C00648, FILED 6-24-2004, REG. NO. 951258, DATED 1-5-2005, EXPIRES 6-24-2014.

CLASS 7—MACHINERY

FOR WASHING APPARATUS FOR DOMESTIC USE, NAMELY, WASHING MACHINES, DISHWASHERS (U.S. CLS. 13, 19, 21, 23, 31, 34 AND 35).

CLASS 11—ENVIRONMENTAL CONTROL APPARATUS

FOR COOKING APPARATUS FOR DOMESTIC USE, NAMELY, STOVES, COOKING HOBBS, OVENS; EXHAUST AND FILTER APPARATUS FOR DOMESTIC USE, NAMELY RANGE HOODS; REFRIGERATING APPARATUS FOR DOMESTIC USE, NAMELY, REFRIGERATORS, FREEZERS (U.S. CLS. 13, 21, 23, 31 AND 34).
LINDA ESTRADA, EXAMINING ATTORNEY

SN 78-463,716. ARION HUMAN CAPITAL LIMITED, LONDON, UNITED KINGDOM, FILED 8-6-2004.

POINT OF INCOME

THE MARK CONSISTS OF STANDARD CHARACTERS WITHOUT CLAIM TO ANY PARTICULAR FONT, STYLE, SIZE, OR COLOR.

CLASS 9—ELECTRICAL AND SCIENTIFIC APPARATUS

FOR APPARATUS FOR RECORDING, TRANSMISSION OR REPRODUCTION OF SOUND, DATA OR IMAGES, NAMELY, RECORDABLE AUDIO TAPES, RECORDABLE VISUAL TAPES; COMPACT DISCS, FLOPPY DISKS, HARD DISKS, MEMORY STICKS, HARD DRIVES, COMPUTER SOFTWARE FOR THE RECORDING, TRANSMISSION OR REPRODUCTION OF SOUND, DATA OR IMAGES, COMPUTER HARDWARE FOR THE RECORDING, TRANSMISSION OR REPRODUCTION OF SOUND, DATA OR IMAGES; BLANK MAGNETIC DATA CARRIERS, BLANK RECORDING DISCS, BLANK OPTICAL DATA CARRIERS AND RECORDING DISCS, BLANK COMPACT DISCS; CALCULATION MACHINES; DATA PROCESSING EQUIPMENT AND COMPUTERS; COMPUTER KEYBOARDS; COMPUTER MEMORIES; COMPUTER PROGRAMS AND SOFTWARE FOR USE IN DATABASE COMPILATION, BUSINESS MANAGEMENT, DATA PROCESSING, COMPLIANCE MONITORING, CORPORATE GOVERNANCE, ECONOMIC FORECASTING, EFFICIENCY MONITORING AND INFORMATION IN THE FIELD OF TELEMETRICS AND PAYROLL PREPARATION SERVICES, RENTAL OF ADVERTISING SPACE AND MEDIA, PUBLIC RELATIONS AND PUBLICITY, PERSONNEL MANAGEMENT AND CONSULTANCY, AND RECRUITMENT SERVICES; COMPUTER HARDWARE FOR USE WITH BUILDING NETWORKS; COMPUTER HARDWARE FOR USE WITH INTERNET CONNECTIONS, NAMELY, ADAPTERS, HUBS, ROUTERS, SWITCHES AND ROUTERS; COMPUTER PERIPHERAL DEVICES INCLUDING PRINTERS FOR USE WITH COMPUTERS; OPTICAL CHARACTER READERS FOR DATA PROCESSING; ENCODED ELECTRONIC AND MAGNETICALLY ENCODED IDENTIFICATION CARDS AND APPARATUS FOR USE IN READING SUCH CARDS; BAR CODE AND OPTICAL READERS; ELECTRONIC IDENTITY RECOGNITION DEVICES AND APPARATUS, NAMELY ELECTRONIC IDENTIFICATION CARD READERS AND CARDS, MOBILE RADIOS, MOBILE TELEPHONES, PAGERS; ELECTRONIC PROXIMITY READER AND RECORDERS (U.S. CLS. 21, 23, 26, 36 AND 38).

CLASS 16—PAPER GOODS AND PRINTED MATTER

FOR COPY PAPER; DRAWING PAPER; COMPUTER PRINTER PAPER; PAPER INCORPORATING SECURITY FEATURES; PAYSLEIPS; PAPER CARDS; DATA ENTRY CARDS; ADVERTISING CARDS; CARDBOARD PAPER; PRINTED MATTER, NAMELY, MAGAZINES, NEWSLETTERS, PAMPHLETS, INSTRUCTION MANUALS, CUSTOMER RESPONSE MATERIALS ALL RELATED TO RECRUITMENT SERVICES AND THE RECRUITMENT INDUSTRY, ADVERTISING AND THE ADVERTISING INDUSTRY, BUSINESS EFFICIENCY AND PERFORMANCE, EMPLOYEE PERSONNEL ADMINISTRATION, SECURITY AND CORPORATE GOVERNANCE; STATIONERY; ENVELOPES; BLANK FORMS; PRINTED FORMS, BUSINESS FORMS; ACCOUNTING FORMS; PAPER LABELS; PRE-PRINTED LABELS; SELF-ADHESIVE LABELS; PRE-PRINTED REPLY STATIONERY AND CARDS (U.S. CLS. 2, 5, 22, 23, 29, 37, 38 AND 50).

CLASS 35—ADVERTISING AND BUSINESS

FOR BUSINESS MANAGEMENT; BUSINESS ADMINISTRATION CONSULTATION; BUSINESS APPRAISALS; BUSINESS CONSULTANCY AND INFORMATION; COMPILATION OF INFORMATION INTO DATABASES; DATA PROCESSING; ADVERTISING ANALYSIS; DATA PROCESSING FROM COMPUTER FILES; DIRECT MAIL ADVERTISING; DOCUMENT REPRODUCTION, AND FILE MANAGEMENT; EFFICIENCY EXPERTISE AND INFORMATION; EMPLOYMENT SERVICES, NAMELY, RECRUITMENT AND PAYROLL SERVICES; MARKET RESEARCH AND MARKETING STUDIES IN THE FIELD OF STATISTICAL DATABASE COMPILATION, PAYROLL SERVICES, EMPLOYMENT SERVICES, EFFICIENCY EXPERTISE AND INFORMATION, PERSONNEL MANAGEMENT AND CONSULTANCY; PAYROLL PREPARATION; PERSONNEL MANAGEMENT CONSULTANCY; PUBLIC RELATIONS AND PUBLICITY; RENTAL OF ADVERTISING SPACE AND MEDIA; COMPLIANCE SYSTEMS, NAMELY ELECTRONIC TRACKING AND MONITORING INSURANCE AND REGULATORY COMPLIANCE; PROVIDING CONSULTATION AND INFORMATION IN THE FIELD OF CORPORATE GOVERNANCE (U.S. CLS. 100, 101 AND 102).

CLASS 42—SCIENTIFIC, COMPUTER AND LEGAL SERVICES

FOR DESIGN AND DEVELOPMENT OF COMPUTER SOFTWARE AND HARDWARE; COMPUTER RENTAL; COMPUTER SOFTWARE INSTALLATION AND MAINTENANCE; DATA CONVERSION OF COMPUTER DATA OR INFORMATION; DEVELOPMENT OF DATA PROCESSING PROGRAMS BY ORDER OF THIRD PARTIES; PROVIDING SEARCH ENGINES FOR OBTAINING DATA FROM COMPUTER FILES (U.S. CLS. 100 AND 101).

RUDY R. SINGLETON, EXAMINING ATTORNEY

CLASS 7—MACHINERY

FOR MACHINE AND MACHINE TOOLS FOR WORKING METAL, WOOD, CERAMICS, AND PLASTICS, NAMELY, FILES, GRINDING PINS, GRINDING WHEELS, SAW WHEELS, POLISHING MACHINES, COUNTERSINKS AND GRINDING STRIPS; CUSTOM DESIGNED AND MANUFACTURED MACHINE AND MACHINE TOOLS FOR WORKING METAL, WOOD, CERAMICS, AND PLASTICS, NAMELY, FILES, GRINDING PINS, GRINDING WHEELS, SAW WHEELS, POLISHING MACHINES, COUNTERSINKS, AND GRINDING STRIPS; MACHINE AND MACHINE TOOLS WITH DIAMONDS FOR WORKING METAL, WOOD, CERAMICS, AND PLASTICS, NAMELY, FILES; POWER-OPERATED ELECTRO PLATED DIAMOND TOOLS FOR WORKING METAL, WOOD, CERAMICS, AND PLASTICS, NAMELY, FILES; POWER-OPERATED CUBIC BORON NITRIDE TOOLS, NAMELY, FILES; POWER-OPERATED VACUUM BRAZED DIAMOND TOOLS, NAMELY, FILES; POWER-OPERATED ABRASIVE TOOLS, NAMELY, FILES (U.S. CLS. 13, 19, 21, 23, 31, 34 AND 35).

FIRST USE 12-1-1975; IN COMMERCE 7-1-1982.

CLASS 10—MEDICAL APPARATUS

FOR DENTAL INSTRUMENTS AND TOOLS, NAMELY, BURS; CUSTOM DESIGNED AND MANUFACTURED DENTAL INSTRUMENTS AND TOOLS, NAMELY, BURS; DENTAL INSTRUMENTS AND TOOLS WITH DIAMONDS, NAMELY, BURS; DIAMOND TRIMMERS FOR DENTAL USE; HAND PIECE BURS FOR DENTAL LABORATORIES; FG DENTAL DIAMOND BURS; RA AND HP DENTAL DIAMOND BURS (U.S. CLS. 26, 39 AND 44).

FIRST USE 12-1-1975; IN COMMERCE 7-1-1982.
JASON LOTT, EXAMINING ATTORNEY

SN 78-482,300. STRAUSS & CO. - INDUSTRIAL DIAMONDS LTD, RA'ANANA, ISRAEL, FILED 9-13-2004.

SN 78-482,307. STRAUSS & CO. - INDUSTRIAL DIAMONDS LTD, RA'ANANA, ISRAEL, FILED 9-13-2004.

STRAUSS



THE MARK CONSISTS OF STANDARD CHARACTERS WITHOUT CLAIM TO ANY PARTICULAR FONT, STYLE, SIZE, OR COLOR.

OWNER OF ISRAEL REG. NO. 171456, DATED 4-14-2004, EXPIRES 4-14-2014.

OWNER OF ISRAEL REG. NO. 171455, DATED 4-14-2004, EXPIRES 4-14-2014.

SEC. 2(F).

OWNER OF ISRAEL REG. NO. 171460, DATED 4-14-2004, EXPIRES 4-14-2014.

OWNER OF ISRAEL REG. NO. 171459, DATED 4-14-2004, EXPIRES 4-14-2014.

THE LINING IS A FEATURE OF THE MARK.

CLASS 7—MACHINERY

FOR MACHINE AND MACHINE TOOLS FOR WORKING METAL, WOOD, CERAMICS, AND PLASTICS, NAMELY, FILES, GRINDING PINS, GRINDING WHEELS, SAW WHEELS, POLISHING MACHINES, COUNTERSINKS AND GRINDING STRIPS; CUSTOM DESIGNED AND MANUFACTURED MACHINE AND MACHINE TOOLS FOR WORKING METAL, WOOD, CERAMICS, AND PLASTICS, NAMELY, FILES, GRINDING PINS, GRINDING WHEELS, SAW WHEELS, POLISHING MACHINES, COUNTERSINKS, AND GRINDING STRIPS; MACHINE AND MACHINE TOOLS WITH DIAMONDS FOR WORKING METAL, WOOD, CERAMICS, AND PLASTICS, NAMELY, FILES; POWER-OPERATED ELECTRO PLATED DIAMOND TOOLS FOR WORKING METAL, WOOD, CERAMICS, AND PLASTICS, NAMELY, FILES; POWER-OPERATED CUBIC BORON NITRIDE TOOLS, NAMELY, FILES; POWER-OPERATED VACUUM BRAZED DIAMOND TOOLS, NAMELY, FILES; POWER-OPERATED ABRASIVE TOOLS, NAMELY, FILES (U.S. CLS. 13, 19, 21, 23, 31, 34 AND 35).

FIRST USE 12-1-1975; IN COMMERCE 7-1-1982.

CLASS 10—MEDICAL APPARATUS

FOR DENTAL INSTRUMENTS AND TOOLS, NAMELY, BURS; CUSTOM DESIGNED AND MANUFACTURED DENTAL INSTRUMENTS AND TOOLS, NAMELY, BURS; DENTAL INSTRUMENTS AND TOOLS WITH DIAMONDS, NAMELY, BURS; DIAMOND TRIMMERS FOR DENTAL USE; HAND PIECE BURS FOR DENTAL LABORATORIES; FG DENTAL DIAMOND BURS; RA AND HP DENTAL DIAMOND BURS (U.S. CLS. 26, 39 AND 44).

FIRST USE 12-1-1975; IN COMMERCE 7-1-1982.

JASON LOTT, EXAMINING ATTORNEY

SN 78-485,381, STILLWATER DESIGN INC., HEAD OF ST. MARGARET'S BAY, NOVA SCOTIA, CANADA, FILED 9-17-2004.

STILLWATER

THE MARK CONSISTS OF STANDARD CHARACTERS WITHOUT CLAIM TO ANY PARTICULAR FONT, STYLE, SIZE, OR COLOR.

CLASS 14—JEWELRY

FOR AMULETS, BANGLES, BRACELETS, BROOCHES, CHAINS, CHARMS, CHOKERS, CHRONOGRAPHS FOR USE AS WATCHES, TIE CLIPS, CLOCKS, CLOISONNE JEWELRY, COLLECTIBLE, NON-MONETARY COINS, CROSSES, CUFF LINKS, EARRINGS, FINDINGS, JEWELRY, COSTUME JEWELRY, IDENTIFICATION BRACELETS, KEY RINGS OF PRECIOUS METAL, LOCKETS, MEDALLIONS, MEDALS, NECKLACES, ORNAMENTAL PINS, JEWELRY ORNAMENTS, PENDANTS, NECK CHAINS, PINS, TIE PINS, RINGS, SEMI-PRECIOUS STONES, TRINKETS; NON-ELECTRIC CANDELABRAS OF PRECIOUS METAL (U.S. CLS. 2, 27, 28 AND 50).

CLASS 21—HOUSEWARES AND GLASS

FOR BASINS, WICKER BASKETS, STRAW BASKETS, STRAW BREAD BASKETS, WASTE BASKETS, WASTE-PAPER BASKETS, PICNIC BASKETS AND FITTED PICNIC BASKETS, ALL FOR DOMESTIC USE - NOT OF PRECIOUS METAL, BASTING SPOONS FOR KITCHEN USE, BEER MUGS, BOTTLES, SOLD EMPTY, SOAP BOXES, GLASS BOXES, BREAD BOARDS, BUTTER DISHES, BUTTER-DISH COVERS, NON-ELECTRIC CANDELABRAS - NOT OF PRECIOUS METAL, CANDELTICKS - NOT OF PRECIOUS METAL, CANDLE EXTINGUISHERS - NOT OF PRECIOUS METAL, CANDLE RINGS - NOT OF PRECIOUS METAL, CANDY BOXES - NOT OF PRECIOUS METAL, CHEESE-DISH COVERS, COASTERS - NOT OF PAPER AND OTHER THAN TABLE LINEN, COCKTAIL STIRRERS, COFFEE GRINDERS - HAND-OPERATED, COFFEE SERVICES - NOT OF PRECIOUS METAL, COMBS, HAIR COMBS, LARGE-TOOTHED COMBS FOR THE HAIR, COMB CASES, CONTAINERS FOR HOUSEHOLD OR KITCHEN USE - NOT OF PRECIOUS METAL, COOKIE AND BISCUIT CUTTERS, COOKIE JARS, NON-ELECTRIC COOKING UTENSILS, NAMELY, GRILLS AND GRID-DLE CLEANING PADS, GRILL SCREENS FOR SEPARATING FOOD AND CHARCOAL, GRILL SCREEN HOLDERS, GRILL CLEANING SCRAPERS, CLEANING BRUSHES, DOUGH SCRAPERS, DOUGH CUTTERS, SANDWICH SPREADERS FOR SPREADING BUTTER, MAYONNAISE AND OTHER SPREADABLE ITEMS, WOOD AND PLASTIC DOUGH EXTRUDERS, GRADERS, SIEVES, SPATULAS, STRAINERS, TURNERS, ROLLING PINS, POT AND PAN SCRAPERS AND SKIMMERS, CORKSCREWS, BOTTLE OPENERS, PORTABLE COOLERS, ICE PAILS, COVERS FOR DISHES, CROCKERY, CRUET STANDS FOR OIL AND VINEGAR - NOT OF PRECIOUS METAL, CRUETS - NOT OF PRECIOUS METAL, CRUMB TRAYS, EGG CUPS, FRUIT CUPS - NOT OF PRECIOUS METAL, CUTTING BOARDS FOR THE KITCHEN, DISHES - NOT OF PRECIOUS METAL, SOAP DISPENSERS, DRINKING GLASSES, NAMELY, TUMBLERS, FLASKS - NOT OF PRECIOUS METAL, FLOWER POTS, HOLDERS FOR FLOWERS AND PLANTS, GOBLETS - NOT OF PRECIOUS METAL, JUGS - NOT OF PRECIOUS METAL, NON-ELECTRIC KITCHEN CONTAINERS - NOT OF PRECIOUS METAL, SERVING PLATTERS NOT OF PRECIOUS METAL, BEVERAGE GLASSWARE, INSULATED THERMAL DINNERWARE, NAMELY MUGS, BOWLS AND FOOD CONTAINERS WITH LIDS, WINE BOTTLE CRADLES, BOTTLE STANDS, PORTABLE BEVERAGE COOLERS, PORTABLE BEVERAGE DISPENSERS, CANDLE HOLDERS - NOT OF PRECIOUS METAL, MILK CANS, GARBAGE CANS, TOWEL HOLDERS, HOLDERS FOR TOILET PAPER, TEA KETTLES, KNIFE BLOCKS, PEPPER MILLS, VACUUM BOTTLES, FRYING PANS, STEW POTS, SAUCE PANS, PANCAKE GRIDDLES, COOKING POTS, SAUCE PAN LIDS, STEW PANS, LIQUEUR SETS, NAMELY, CONSISTING OF TRAYS, GLASSES, DECANTERS, SHAKERS AND STIRRERS, MIXING SPOONS, MUGS - NOT OF PRECIOUS METAL, NAPKIN HOLDERS - NOT OF PRECIOUS METAL, NAPKIN RINGS - NOT OF PRECIOUS METAL, PASTRY CUTTERS, PERFUME SPRAYERS, PERFUME VAPORIZERS, PIE SERVERS, PIPETTES FOR WINE-TASTERS, PITCHERS - NOT OF PRECIOUS METAL, POTS - NOT OF PRECIOUS METAL, POWDER COMPACTS - NOT OF PRECIOUS METAL, SACRED VESSELS - NOT OF PRECIOUS METAL, NAMELY, DRINKING VESSELS, SALAD BOWLS - NOT OF PRECIOUS METAL, SCOOPS, TABLEWARE SERVICES - NOT OF PRECIOUS METAL, NAMELY, PLATES, SAUCERS, CUPS, CASSEROLES, SUGAR BOWLS AND CREAMERS - NOT OF PRECIOUS METAL, SPOON RESTS, COVERED PLATES, GLASS STORAGE JARS, TEAPOTS, SALT AND PEPPER SHAKERS - NOT OF PRECIOUS METAL, CERAMIC PLATES, BOWLS, CUPS AND SAUCERS, SERVING TRAYS NOT OF PRECIOUS METAL, DRINKING VESSELS OF GLASS AND PLASTIC, MUGS OF CERAMICS, WHISKS, NON-ELECTRIC, FOR HOUSEHOLD PURPOSES, SOUP BOWLS - NOT OF PRECIOUS METAL, SPICE RACKS, TABLE PLATES - NOT OF PRECIOUS METAL, TANKARDS - NOT OF PRECIOUS METAL, TEA SETS - NOT OF PRECIOUS METAL, TOOTHPICK HOLDERS - NOT OF PRECIOUS METAL, TRAYS FOR DOMESTIC PURPOSES - NOT OF PRECIOUS METAL, TRIVETS, URNS - NOT OF PRECIOUS METAL, BEVERAGE WARE, SOAP AND SPONGE HOLDERS, ALL PURPOSE PORTABLE CONTAINERS, SOAP DISHES, DINNERWARE, PAPER

TOWEL HOLDERS, BATH ACCESSORIES, NAMELY CUP HOLDERS, TOILET TISSUE HOLDERS, TOOTHBRUSH HOLDERS, TOWEL BARS, TOILET PAPER HOLDERS, TOWEL RINGS, LUNCH BOXES, BREAD BOXES, BUCKETS, WINE BUCKETS, CHAMPAGNE BUCKETS, VASES - NOT OF PRECIOUS METAL, VEGETABLE DISHES, WATERING CANS, CREAMER PITCHERS, CAKE STANDS, FOOTED PLATES AND MULTITIERED FOOD AND FOOD PRESENTATION STANDS, DECORATIVE CENTERPIECES MADE OF GLASS, PORCELAIN OR EARTHENWARE FOR TABLE TOP USE, GRAVY BOATS, CARVING BOARDS, CORN COB HOLDERS, AND CAKE TINS (U.S. CLS. 2, 13, 23, 29, 30, 33, 40 AND 50).

CLASS 35—ADVERTISING AND BUSINESS

FOR RETAIL STORE SERVICES IN THE FIELD OF GIFTWARE PRODUCTS, NAMELY, PEWTER GIFTWARE AND JEWELRY (U.S. CLS. 100, 101 AND 102).
ANDREA EVANS, EXAMINING ATTORNEY

SN 78-487,134. JUMP APPAREL CO., INC., NEW YORK, NY.
FILED 9-21-2004.

JUMP

THE MARK CONSISTS OF STANDARD CHARACTERS WITHOUT CLAIM TO ANY PARTICULAR FONT, STYLE, SIZE, OR COLOR.
OWNER OF U.S. REG. NO. 1,977,605.

CLASS 9—ELECTRICAL AND SCIENTIFIC APPARATUS

FOR EYEWEAR (U.S. CLS. 21, 23, 26, 36 AND 38).

CLASS 14—JEWELRY

FOR JEWELRY; WATCHES, CLOCKS AND OTHER HOROLOGICAL INSTRUMENTS (U.S. CLS. 2, 27, 28 AND 50).

CLASS 25—CLOTHING

FOR MEN'S, WOMEN'S AND CHILDREN'S CLOTHING AND APPAREL, NAMELY, SHIRTS, BLOUSES, JUMPSUITS, SWEATERS, SHORTS, DRESSES, JEANS, T-SHIRTS, SWEATSHIRTS, SWEATPANTS, HEAD BANDS, SWEAT BANDS, UNDERGARMENTS, TIGHTS, BICYCLE SHORTS, SCARVES, TIES, AND SWIM SUITS (U.S. CLS. 22 AND 39).

LA TONIA FISHER, EXAMINING ATTORNEY

SN 78-488,839. STREAMCAST NETWORKS, INC., WOODLAND HILLS, CA. FILED 9-23-2004.

MORPHEUS

THE MARK CONSISTS OF STANDARD CHARACTERS WITHOUT CLAIM TO ANY PARTICULAR FONT, STYLE, SIZE, OR COLOR.

CLASS 9—ELECTRICAL AND SCIENTIFIC APPARATUS

FOR SOFTWARE AND DOWNLOADABLE SOFTWARE TO ENABLE PEER-TO-PEER NETWORKING AND FILE SHARING OF INFORMATION FOR EDUCATIONAL, COMMUNICATION, AND ENTERTAINMENT PURPOSES (U.S. CLS. 21, 23, 26, 36 AND 38).

CLASS 42—SCIENTIFIC, COMPUTER AND LEGAL SERVICES

FOR PROVIDING TEMPORARY USE OF NON-DOWNLOADABLE SOFTWARE FOR PEER-TO-PEER NETWORKING AND FILE SHARING OF INFORMATION FOR EDUCATIONAL, COMMUNICATION, AND ENTERTAINMENT PURPOSES VIA LOCAL AND GLOBAL COMMUNICATIONS NETWORKS (U.S. CLS. 100 AND 101).

REBECCA SMITH, EXAMINING ATTORNEY

SN 78-490,600. G.H. IMPORTED MERCHANDISE & SALES LIMITED, SCARBOROUGH, CANADA, FILED 9-28-2004.



PRIORITY CLAIMED UNDER SEC. 44(D) ON CANADA APPLICATION NO. 1226695, FILED 8-11-2004, REG. NO. TMA672434, DATED 9-12-2006, EXPIRES 9-12-2021.

CLASS 18—LEATHER GOODS

FOR BAGS, NAMELY, GARMENT BAGS FOR TRAVEL, TRAVEL BAGS, WALLETS, SHOULDER BAGS, SPORTS BAGS, BACKPACKS, FANNY PACKS, CARRYING CASES, CARRYING CASES FOR COMPUTERS, BRIEFCASES, BRIEFCASE-TYPE PORTFOLIOS (U.S. CLS. 1, 2, 3, 22 AND 41).

FIRST USE 1-31-2000; IN COMMERCE 1-31-2000.

CLASS 25—CLOTHING

FOR CLOTHING, NAMELY, OUTERWEAR, NAMELY, JACKETS, PANTS AND WINDSHIRTS; FLEECE JACKETS, SWEATERS, PULLOVERS, FLEECE PULLOVERS, KNIT TOPS, T-SHIRTS, PANTS, SHORTS, SPORT SHIRTS, TANK TOPS, TWIN SETS, TURTLE NECKS, VESTS, CARDIGANS, SWEAT SHIRTS, SWEAT TOPS, SWEAT PANTS, SWEAT BOTTOMS, LEGGINGS, JOGGING SUITS; CARDIGAN SETS, NAMELY, SHORT-SLEEVED OR SLEEVELESS, KNIT OR WOVEN TOPS WITH SWEATERS SOLD AS A PAIR; KNIT AND WOVEN KNIT AND TOPS, SHIRTS OR SWEATERS SOLD AS A PAIR; HATS, CAPS, SCARVES, GLOVES (U.S. CLS. 22 AND 39).

FIRST USE 1-31-2000; IN COMMERCE 1-31-2000.
JOHN WILKE, EXAMINING ATTORNEY

SN 78-492,022. EXPO COMMUNICATIONS, INC., NEW YORK, NY. FILED 9-30-2004.



THE COLORS BLUE, ORANGE AND WHITE ARE CLAIMED AS A FEATURE OF THE MARK.

THE COLOR BLUE APPEARS IN THE ARROW SHAPE SURROUNDING THE LETTERS "E" AND "X", THE COLOR ORANGE APPEARS IN THE CIRCLE SURROUNDING THE LETTERS "P" AND "O" AND THE COLOR WHITE APPEARS IN ALL THE LETTERS OF THE MARK.

CLASS 35—ADVERTISING AND BUSINESS

FOR ADVERTISING SERVICES, NAMELY, DISTRIBUTION OF AUDIO AND VIDEO INFOMERCIALS AND PROGRAMMING FEATURING DIRECT-TO-CONSUMER MARKETING OF THE PRODUCTS AND SERVICES OF OTHERS; PROVIDING TELEVISION ADVERTISING FOR OTHERS; DISSEMINATION OF ADVERTISING FOR OTHERS VIA THE INTERNET; ADVERTISING SERVICES, NAMELY, PROMOTING THE PRODUCTS AND SERVICES OF OTHERS VIA THE INTERNET; PROVIDING INFORMATION ABOUT THE BACKGROUND, DIFFERENCES, AND QUALITY OF CONSUMER GOODS AND SERVICES VIA TELEVISION AND THE INTERNET; PROVIDING RETAIL STORE SERVICES FEATURING GENERAL MERCHANDISE IN THE FIELDS OF CONSUMER ELECTRONICS, COMPUTERS, AUTOS, BEAUTY, BABY GEAR, MEDICINE, TRAVEL, REAL ESTATE, HEALTH AND FITNESS, FOOD, EDUCATION, TELECOMMUNICATIONS, AND FINANCE, ALL VIA TELEVISION AND THE INTERNET AND NOT INCLUDING HOME IMPROVEMENT SERVICES; LICENSING SERVICES, NAMELY, PROVIDING CABLE, SATELLITE AND BROADCAST TELEVISION BROADCASTERS A LICENSE TO SHOW TELEVISION PROGRAMS; DISSEMINATION OF INFORMATION ABOUT THE BACKGROUND, DIFFERENCES, AND QUALITY OF CONSUMER PRODUCTS AND SERVICES VIA MULTIPLE-USER GLOBAL COMPUTER NETWORK; RETAIL STORE SERVICES AVAILABLE THROUGH COMPUTER COMMUNICATIONS AND INTERACTIVE TELEVISION, FEATURING GENERAL MERCHANDISE IN THE FIELDS OF CONSUMER ELECTRONICS, COMPUTERS, AUTOS, BEAUTY, BABY GEAR, MEDICINE, TRAVEL, REAL ESTATE, HEALTH AND FITNESS, FOOD, EDUCATION, TELECOMMUNICATIONS, AND FINANCE AND NOT INCLUDING HOME IMPROVEMENT SERVICES (U.S. CLS. 100, 101 AND 102).

FIRST USE 8-3-2004; IN COMMERCE 8-3-2004.

CLASS 38—COMMUNICATION

FOR TELEVISION BROADCASTING SERVICES; CABLE TELEVISION, SATELLITE TELEVISION, AND VIDEO ON DEMAND TRANSMISSION AND BROADCASTING SERVICES (U.S. CLS. 100, 101 AND 104).

FIRST USE 8-3-2004; IN COMMERCE 8-3-2004.

CLASS 41—EDUCATION AND ENTERTAINMENT

FOR ENTERTAINMENT AND EDUCATIONAL SERVICES, NAMELY, PRODUCTION OF TELEVISION PROGRAMS OF INTEREST TO CONSUMERS; DISTRIBUTION OF TELEVISION PROGRAMMING TO CABLE TELEVISION SYSTEMS; PRODUCTION OF CABLE TELEVISION PROGRAMS (U.S. CLS. 100, 101 AND 107).

FIRST USE 8-3-2004; IN COMMERCE 8-3-2004.
EVELYN BRADLEY, EXAMINING ATTORNEY

SN 78-495,526. JAMES A. RHODES STATE COLLEGE, LIMA, OH. FILED 10-6-2004.

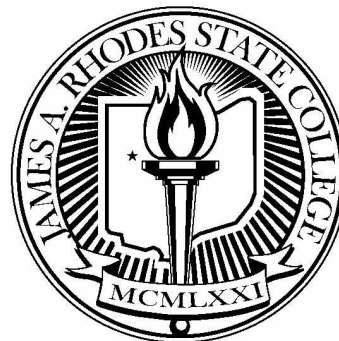

NO CLAIM IS MADE TO THE EXCLUSIVE RIGHT TO USE "STATE COLLEGE" OR "MCMLXXI", APART FROM THE MARK AS SHOWN.

THE NAME(S), PORTRAIT(S), AND/OR SIGNATURE(S) SHOWN IN THE MARK DOES NOT IDENTIFY A PARTICULAR LIVING INDIVIDUAL.

CLASS 16—PAPER GOODS AND PRINTED MATTER

FOR PRINTED MATERIAL, NAMELY, DIPLOMAS AND CERTIFICATES (U.S. CLS. 2, 5, 22, 23, 29, 37, 38 AND 50).

FIRST USE 7-1-2004; IN COMMERCE 7-1-2004.

CLASS 41—EDUCATION AND ENTERTAINMENT

FOR EDUCATIONAL SERVICES IN THE NATURE OF COURSES AT THE UNIVERSITY LEVEL, NAMELY, ASSOCIATE DEGREES AND TECHNICAL TRAINING (U.S. CLS. 100, 101 AND 107).

FIRST USE 7-1-2004; IN COMMERCE 7-1-2004.
HEATHER THOMPSON, EXAMINING ATTORNEY

SN 78-498,702. 1-800 CONTACTS, INC., DRAPER, UT. FILED 10-12-2004.

CLEARDAY

THE MARK CONSISTS OF STANDARD CHARACTERS WITHOUT CLAIM TO ANY PARTICULAR FONT, STYLE, SIZE, OR COLOR.

CLASS 5—PHARMACEUTICALS

FOR CONTACT LENS CARE PREPARATIONS IN SOLUTION AND TABLET FORM FOR DISINFECTING, CLEANING, WETTING, CUSHIONING, SOAKING, OR RINSING CONTACT LENSES; LIQUID SOLUTIONS WHICH REWET, LUBRICATE, REHYDRATE OR RELIEVE DRYNESS IN THE EYES OR CONTACT LENSES; ARTIFICIAL TEARS; OCULAR DECONGESTANTS; AND OCULAR OINTMENTS WHICH RELIEVE IRRITATIONS, RELIEVE REDNESS, RELIEVE DISCOMFORT OR SOOTHE (U.S. CLS. 6, 18, 44, 46, 51 AND 52).

CLASS 9—ELECTRICAL AND SCIENTIFIC APPARATUS

FOR CONTACT LENSES (U.S. CLS. 21, 23, 26, 36 AND 38).

NANCY CLARKE, EXAMINING ATTORNEY

SN 78-499,947. COMMUNITY REINVESTMENT FUND, INC., MINNEAPOLIS, MN. FILED 10-14-2004.

CAPITAL FOR
COMMUNITIES -
OPPORTUNITIES FOR
PEOPLE

THE MARK CONSISTS OF STANDARD CHARACTERS WITHOUT CLAIM TO ANY PARTICULAR FONT, STYLE, SIZE, OR COLOR.

CLASS 35—ADVERTISING AND BUSINESS

FOR BUSINESS CONSULTING SERVICES TO LENDERS IN THE FIELDS OF COMMUNITY AND ECONOMIC DEVELOPMENT LENDING AND SPONSORING OF NEW MARKET TAX CREDIT INCENTIVES (U.S. CLS. 100, 101 AND 102).

CLASS 36—INSURANCE AND FINANCIAL

FOR FINANCIAL SERVICES, NAMELY, PROVIDING CAPITAL THROUGH THE OPERATION OF A SECONDARY MARKET FOR LOANS, INCLUDING COMMUNITY AND ECONOMIC DEVELOPMENT LOANS; FINANCIAL SERVICES, NAMELY PROVIDING INVESTORS WITH ASSET-BACKED SECURITIES (U.S. CLS. 100, 101 AND 102).

CLASS 41—EDUCATION AND ENTERTAINMENT

FOR PROVIDING TRAINING TO LENDERS IN THE FIELDS OF COMMUNITY AND ECONOMIC DEVELOPMENT LENDING AND SPONSORING OF NEW MARKET TAX CREDIT INCENTIVES (U.S. CLS. 100, 101 AND 107).

SANI KHOURI, EXAMINING ATTORNEY

SN 78-507,212. STRATA G, LLC, KNOXVILLE, TN. FILED 10-28-2004.



The logo for Strata G features the word "Strata" in a bold, italicized sans-serif font, followed by a five-pointed star, and then a large, bold "G".

CLASS 35—ADVERTISING AND BUSINESS

FOR BUSINESS AND INDUSTRIAL MANAGEMENT OF WASTE TREATMENT PLANTS, TRANSPORTATION BUSINESS AND NUCLEAR PLANTS FOR OTHERS (U.S. CLS. 100, 101 AND 102).

FIRST USE 4-1-2001; IN COMMERCE 4-1-2001.

CLASS 42—SCIENTIFIC, COMPUTER AND LEGAL SERVICES

FOR ENGINEERING SERVICES; CONSULTATION SERVICES IN REGARD TO ENVIRONMENTAL, SAFETY AND HEALTH REGULATION COMPLIANCE (U.S. CLS. 100 AND 101).

FIRST USE 4-1-2001; IN COMMERCE 4-1-2001.

KELLEY WELLS, EXAMINING ATTORNEY

SN 78-508,280. BALUMA NETWORKS, S.L., MADRID, SPAIN, FILED 10-29-2004.

SN 78-510,330. ARTIFICIAL LIFE INC, WANCHAI, HONG KONG, FILED 11-3-2004.

V-girl

BALUMA

THE MARK CONSISTS OF STANDARD CHARACTERS WITHOUT CLAIM TO ANY PARTICULAR FONT, STYLE, SIZE, OR COLOR.

CLASS 38—COMMUNICATION

FOR WIRELESS COMMUNICATIONS SERVICES, NAMELY, TRANSMISSION OF GRAPHICS TO MOBILE TELEPHONES (U.S. CLS. 100, 101 AND 104).
FIRST USE 11-3-2004; IN COMMERCE 11-3-2004.

CLASS 41—EDUCATION AND ENTERTAINMENT

FOR ENTERTAINMENT SERVICES, NAMELY, PROVIDING AN ON-LINE COMPUTER GAME VIA MOBILE (U.S. CLS. 100, 101 AND 107).
FIRST USE 11-3-2004; IN COMMERCE 11-3-2004.
MARK T. MULLEN, EXAMINING ATTORNEY

THE MARK CONSISTS OF STANDARD CHARACTERS WITHOUT CLAIM TO ANY PARTICULAR FONT, STYLE, SIZE, OR COLOR.

OWNER OF SPAIN REG. NO. 2.340.616, DATED 6-20-2001, EXPIRES 6-20-2011.

OWNER OF SPAIN REG. NO. 2.340.617, DATED 6-20-2001, EXPIRES 6-20-2011.

OWNER OF SPAIN REG. NO. 2.581.836, DATED 7-8-2004, EXPIRES 7-8-2014.

CLASS 9—ELECTRICAL AND SCIENTIFIC APPARATUS

FOR COMPUTERS; DATA PROCESSORS; COMPUTER OPERATING PROGRAMS; APPARATUS FOR RECORDING, TRANSMISSION OR REPRODUCTION OF SOUND AND IMAGES (U.S. CLS. 21, 23, 26, 36 AND 38).

CLASS 35—ADVERTISING AND BUSINESS

FOR BUSINESS MANAGEMENT; BUSINESS ADMINISTRATION; OFFICE FUNCTIONS (U.S. CLS. 100, 101 AND 102).

CLASS 38—COMMUNICATION

FOR COMMUNICATIONS SERVICES, NAMELY, TRANSMISSION OF INFORMATION AND AUDIO-VISUAL ENTERTAINMENT RECORDINGS VIA THE INTERNET (U.S. CLS. 100, 101 AND 104).
YONG KIM, EXAMINING ATTORNEY

SN 78-516,180. GLOBECAST FRANCE, 75015 PARIS, FRANCE, FILED 11-12-2004.



OWNER OF U.S. REG. NOS. 2,508,924 AND 2,679,270.

CLASS 9—ELECTRICAL AND SCIENTIFIC APPARATUS

FOR PHONOGRAPH RECORD AND COMPACT DISC PLAYERS, AUDIO AND VIDEO TAPE RECORDERS; BLANK AUDIO AND VIDEO TAPES AND COMPACT DISCS; STEREO RECEIVERS, AMPLIFIERS, AND TUNERS; BLANK MAGNETIC DATA CARRIERS, AUTOMATIC VENDING MACHINES; CASH REGISTERS, CALCULATORS; DATA PROCESSORS AND COMPUTERS; COMPUTER HARDWARE, NAMELY, PROCESS COMPUTERS, COMPUTERS FOR DATA AND WORD PROCESSING, COMPUTER TERMINALS, COMPUTER PRINTERS, COMPUTER MONITORS, COMPUTER SCREENS, MODEMS, FAX MACHINES, MEMORY CARDS, COMPUTER INTERFACE BOARDS, BLANK MAGNETIC COMPUTER TAPES, FIBER OPTIC CABLES, COMPUTER AND ELECTRIC CABLES, OPTICAL CHARACTER RECOGNITION APPARATUS, OPTICAL DISCS, OPTICAL SCANNERS, MAGNETIC CODED CARDS; SATELLITES, VIDEODISKS FEATURING MOTION PICTURES, DIGITAL OPTICAL DISKS, LASER PRINTERS, LASERS NOT FOR MEDICAL USE, LASERS FOR MEASURING PURPOSES, COMPUTER KEYBOARDS, PAPER COPYING MACHINES, PRINTED CIRCUITS, TELECOMMUNICATION EMITTERS, TELEPHONES AND TELEPHONE ANSWERING MACHINES, TELEPHONE EQUIPMENT, NAMELY, TELEPHONES, TELEPHONE RECEIVERS, TELEPHONE TRANSMITTERS, TELEPHONE WIRES; INTEGRATED CIRCUITS AND COMPONENTS, NAMELY COMPUTER CHIPS; PRINTED CIRCUIT BOARDS, COMPUTER INTERFACE BOARDS FOR IDENTIFICATION, COMPACT DISCS FEATURING COMPUTER GAMES, ELECTRONIC CIRCUIT BOARDS, ELECTRONIC NOTICE BOARDS, BLANK INTEGRATED CIRCUIT CARDS (U.S. CLS. 21, 23, 26, 36 AND 38).

CLASS 38—COMMUNICATION

FOR TELECOMMUNICATION SERVICES, NAMELY, PERSONAL COMMUNICATION SERVICES; TELE-MATIC SERVICES, NAMELY, TRANSMISSION OF MESSAGES AND CODED IMAGES VIA TERMINALS ON GLOBAL COMPUTER NETWORKS, TELEPHONES, TELEVISIONS, RADIOS AND TELEPRINTERS; ELECTRONIC TRANSMISSION OF MESSAGE AND DATA; WIRELESS DIGITAL MESSAGING SERVICES, ELECTRONIC STORE-AND-FORWARD MESSAGING, ELECTRONIC TRANSMISSION OF DATA AND DOCUMENTS VIA COMPUTER TERMINALS, COMPUTER TELECOMMUNICATIONS, NAMELY TRANSMISSION OF MESSAGES AND DATA VIA COMPUTER TERMINALS, FACSIMILE TRANSMISSION, ELECTRONIC MAIL SERVICES, TELEPHONE COMMUNICATION SERVICES, RENTAL OF TELECOMMUNICATIONS EQUIPMENT, NAMELY TELEPHONE RECEIVERS, TELECOMMUNICATION CONSULTING SERVICES, CORRESPONDENCE EXCHANGE SERVICES, NAMELY EXCHANGE OF COMPUTERIZED DOCUMENTS (U.S. CLS. 100, 101 AND 104).

CLASS 42—SCIENTIFIC, COMPUTER AND LEGAL SERVICES

FOR RENTAL OF COMPUTERS AND SOFTWARE; ELECTRONIC PROGRAMS AND SOFTWARE ENGINEERING, SOFTWARE APPLICATION TRANSPOSITION SERVICES, NAMELY MAINTENANCE OF COMPUTER SOFTWARE; PATENT AGENCY AND INDUSTRIAL PROPERTY CONSULTATION, LICENSING OF INTELLECTUAL PROPERTY; COMPUTER SOFTWARE DESIGN OF WORD AND DATA PROCESSING FOR OTHERS, DUPLICATION OF COMPUTER PROGRAMS; TECHNICAL CONSULTATION AND RESEARCH IN TELECOMMUNICATIONS FIELD, ENGINEER SERVICES; COMPUTER SOFTWARE INSTALLATIONS, NAMELY INSTALLATION OF COMPUTER PROGRAMS ON COMPUTER SUPPORTS AND USING TELECOMMUNICATION; DESIGN OF COMPUTER NETWORK SYSTEMS AND TELECOMMUNICATIONS SYSTEMS FOR OTHERS; COMPUTER SYSTEMS ANALYSIS AND COMPUTER CONSULTATION; TECHNICAL CONSULTATION AND RESEARCH IN THE FIELD OF OPERATION AND MAINTENANCE OF COMPUTER AND TELECOMMUNICATIONS EQUIPMENT; COMPUTER PROGRAMMING FOR OTHERS;

MONITORING THE COMPUTER NETWORK SYSTEMS OF OTHERS AND PROVIDING BACK-UP COMPUTER PROGRAMS AND FACILITIES; COMPUTER CONSULTING SERVICES; COMPUTER CONSULTING CONCERNING THE OPERATION OF COMPUTER FACILITIES AND AUTOMATION FACILITIES; COMPUTER SOFTWARE DESIGN FOR OTHERS IN THE FIELDS OF WORD AND DATA PROCESSING; SUPERVISORY ENGINEERING DESIGN SERVICES FOR OTHERS IN THE FIELD OF COMPUTER SYSTEMS AND TELECOMMUNICATION SYSTEMS; COMPUTER AND TELECOMMUNICATION CONSULTING AND RESEARCH IN THE FIELDS OF COMPUTER AND TELECOMMUNICATION ANALYSIS, COMPUTER AND TELECOMMUNICATIONS SOFTWARE PROGRAMMING FOR OTHERS, HOSTING THE WEB SITES OF OTHERS ON A COMPUTER SERVER FOR A GLOBAL COMPUTER NETWORK; COMPUTER SERVICES, NAMELY, CREATING AND MAINTAINING WEB SITES FOR OTHERS; COMPUTER SERVICES, NAMELY, DESIGNING AND IMPLEMENTING NETWORK WEB PAGE FOR OTHERS (U.S. CLS. 100 AND 101).

BRENDAN MCCAULEY, EXAMINING ATTORNEY

SN 78-518,862. STREAMCAST NETWORKS, INC., WOODLAND HILLS, CA. FILED 11-17-2004.

MORPHEUS ULTRA

THE MARK CONSISTS OF STANDARD CHARACTERS WITHOUT CLAIM TO ANY PARTICULAR FONT, STYLE, SIZE, OR COLOR.

CLASS 9—ELECTRICAL AND SCIENTIFIC APPARATUS

FOR SOFTWARE AND DOWNLOADABLE SOFTWARE TO ENABLE PEER-TO-PEER NETWORKING AND FILE SHARING OF INFORMATION FOR EDUCATIONAL, COMMUNICATION, AND ENTERTAINMENT PURPOSES (U.S. CLS. 21, 23, 26, 36 AND 38).

CLASS 42—SCIENTIFIC, COMPUTER AND LEGAL SERVICES

FOR PROVIDING TEMPORARY USE OF NON-DOWNLOADABLE SOFTWARE FOR PEER-TO-PEER NETWORKING AND FILE SHARING OF INFORMATION FOR EDUCATIONAL, COMMUNICATION, AND ENTERTAINMENT PURPOSES VIA LOCAL AND GLOBAL COMMUNICATIONS NETWORKS (U.S. CLS. 100 AND 101).

REBECCA SMITH, EXAMINING ATTORNEY

SN 78-524,685. E-NET CORPORATION, SAUSALITO, CA.
FILED 11-30-2004.

OCEAN

THE MARK CONSISTS OF STANDARD CHARACTERS WITHOUT CLAIM TO ANY PARTICULAR FONT, STYLE, SIZE, OR COLOR.

CLASS 9—ELECTRICAL AND SCIENTIFIC APPARATUS

FOR COMPUTER SOFTWARE FOR PREVENTING THE LOSS OF ELECTRONIC INFORMATION, USED IN THE EVENT OF A COMPUTER CENTER DISASTER OR ACCIDENT; COMPUTER SOFTWARE FOR DATA WAREHOUSING; AND USER MANUALS THEREFOR SOLD AS A UNIT (U.S. CLS. 21, 23, 26, 36 AND 38).
FIRST USE 5-0-2004; IN COMMERCE 5-0-2004.

CLASS 42—SCIENTIFIC, COMPUTER AND LEGAL SERVICES

FOR COMPUTER CONSULTING SERVICES, IN THE FIELD OF COMPUTER DISASTER PREVENTION AND RECOVERY PLANNING; INSTALLATION OF COMPUTER SOFTWARE USED TO PREVENT THE LOSS OF ELECTRONIC INFORMATION AND TO PROVIDE DATA WAREHOUSE CAPABILITIES (U.S. CLS. 100 AND 101).
FIRST USE 5-0-2004; IN COMMERCE 5-0-2004.
ANDREW RHIM, EXAMINING ATTORNEY

SN 78-525,231. GRIN REAPER LIMITED, WILTSHIRE, UNITED KINGDOM, FILED 12-1-2004.



PRIORITY CLAIMED UNDER SEC. 44(D) ON UNITED KINGDOM APPLICATION NO. 2364899, FILED 6-3-2004, REG. NO. 2364899, DATED 11-26-2004, EXPIRES 6-3-2014.

THE MARK CONSISTS OF THE CHARACTER IMAGE OF THE BUST OF A HOODED SKELETON HOLDING A SCYTHE WITH THE WORDS GRIN REAPER IMPRINTED ON THE BLADE.

CLASS 14—JEWELRY

FOR PRECIOUS METAL ALLOYS; JEWELRY; HOROLOGICAL AND CHRONOMETRIC INSTRUMENTS; WATCHES; CLOCKS; BADGES OF PRECIOUS METAL; CUFFLINKS; TIE-PINS; TROPHIES OF PRECIOUS METAL; BRACELETS AND JEWELRY CHAINS; COLLECTIBLE COINS; MEDALS; MEDALLIONS; KEY-RINGS OF PRECIOUS METAL; TIE CLIPS (U.S. CLS. 2, 27, 28 AND 50).

CLASS 18—LEATHER GOODS

FOR LEATHER SOLD IN BULK; BOOK BAGS; TRUNKS; TRAVELING BAGS; UMBRELLAS; UMBRELLA COVERS; SPORTS BAGS; RUCKSACKS; BACKPACKS; WALLETS AND PURSES; BRIEFCASES; ATTACHE CASES; SUITCASES; TOILETRY CASES SOLD EMPTY; COIN PURSES; KEY CASES; WALKING STICKS; WHIPS; HARNESS; SADDLERY; VANITY CASES SOLD EMPTY; PARASOLS; HAVERSACKS; SATCHELS; WAIST BAGS AND POUCHES; BEACH BAGS; THONGS; TOTE BAGS; LEATHER STRAPS; FANNY PACKS; DUFFEL BAGS; LEATHER KEY CHAINS (U.S. CLS. 1, 2, 3, 22 AND 41).

CLASS 25—CLOTHING

FOR CLOTHING, NAMELY, PANTS, SHORTS, SWEATERS, SHIRTS, BLOUSES, T-SHIRTS, SKIRTS, JACKETS, COATS, BLAZERS, FOOTWEAR, UNDERWEAR, NECKWEAR, BELTS, CAPS, VISORS, HATS; HOSIERY NAMELY SOCKS AND STOCKINGS (U.S. CLS. 22 AND 39).

DORITT L. CARROLL, EXAMINING ATTORNEY

SN 78-525,492. ATRONIC INTERNATIONAL GMBH, LÜBBECKE, FED REP GERMANY, FILED 12-1-2004.

GRANNY'S TRUCKING CO.

THE MARK CONSISTS OF STANDARD CHARACTERS WITHOUT CLAIM TO ANY PARTICULAR FONT, STYLE, SIZE, OR COLOR.

PRIORITY CLAIMED UNDER SEC. 44(D) ON ERPNCMNTY TM OFC APPLICATION NO. 4123543, FILED 11-18-2004, REG. NO. 004123543, DATED 1-25-2006, EXPIRES 1-25-2016.

OWNER OF U.S. REG. NO. 2,895,308 AND OTHERS.
NO CLAIM IS MADE TO THE EXCLUSIVE RIGHT TO USE "CO.", APART FROM THE MARK AS SHOWN.

CLASS 9—ELECTRICAL AND SCIENTIFIC APPARATUS

FOR ELECTRIC AND ELECTRONIC INSTRUMENTS AND MACHINES FOR GAMBLING AND GAMING, NAMELY, AUTOMATED DISPENSING MACHINES DISPENSING AND ACCEPTING, COINS, PAPER MONEY, TOKENS, MAGNETIC STRIP CARDS, MICRO-PROCESSOR CARDS AND CHITS; COIN OPERATED MACHINES AND MACHINES OPERABLE WITH PAPER MONEY, TOKENS, MAGNETIC STRIP CARDS, MICRO-PROCESSOR CARDS AND CHITS, NAMELY, GAMBLING AND GAMING MACHINES, WITH ALL OF THE AFOREMENTIONED MACHINES AND INSTRUMENTS ALSO FOR NETWORKED USE; ELECTRIC AND ELECTRONIC INSTRUMENTS AND MACHINES FOR CASINO GAMBLING AND GAMING, NAMELY, SLOT MACHINES, GAMING MACHINES, BETTING MACHINES, VIDEO SLOT MACHINES, CASINO GAMBLING MACHINES, WITH ALL OF THE AFOREMENTIONED MACHINES AND APPARATUSES ALSO FOR NETWORKED USE; STRUCTURAL PARTS FOR COIN-OPERATED MACHINES AND COIN CONTROLLED MACHINES, NAMELY, MOUNTING PARTS FOR AND SOLD AS A COMPONENT OF VENDING MACHINES, MONEY CHANGE MACHINES, GAMING AND GAMBLING MACHINES, OPERABLE WITH COINS, PAPER MONEY, TOKENS, MAGNETIC STRIP CARDS, ELECTRONIC TOKENS, MEMORY CARDS, MICRO-PROCESSOR CARDS, OPTICAL MEMORY CARDS, CHITS, EMBOSSED CARDS, READ/WRITE TICKETS; CALCULATORS FOR CALCULATING TRANSACTIONS PERFORMED ON MACHINES OPERATED WITH CURRENCY AND CURRENCY SURROGATE CARRIERS; DATA PRINTERS, NAMELY, COMPUTER PRINTERS, DAISY WHEEL PRINTERS, DOT MATRIX PRINTERS, IMPACT PRINTERS, INK-JET COLOR PRINTERS, LASER PRINTERS, THERMO PRINTERS; PRINTED CIRCUIT BOARDS; VENDING MACHINES PROVIDING CHITS, COUPONS, AND GAME CARDS; MACHINE-READABLE DATA CARRIERS PROGRAMMED FOR ALL THE AFOREMENTIONED MACHINES AND INSTRUMENTS; DATA STORAGE CASSETTES AND STORAGE CARDS FOR ELECTRONIC POCKET GAMES; GAMING SOFTWARE FOR CASINO GAMBLING AND GAMING MACHINES; VIDEO GAME MACHINES, NAMELY, SLOT MACHINES PROVIDED WITH A TV MONITOR, A TFT MONITOR OR A SIMILAR DISPLAY MONITOR (U.S. CLS. 21, 23, 26, 36 AND 38).

CLASS 28—TOYS AND SPORTING GOODS

FOR STAND-ALONE COIN-OPERATED COMPACT SPORTS VIDEO GAME MACHINES; STAND-ALONE COIN-OPERATED COMPACT SPORTS GAME MACHINES FEATURING DARTS, TABLE SOCCER, POOL-BILLIARD, SNOOKER, SHOOTING GALLERIES; HAND CONSOLES FOR PLAYING ELECTRONIC POCKET GAMES; TOYS, NAMELY, STUFFED TOY ANIMALS, TOY FIGURES, TOY VEHICLES; STAND ALONE VIDEO GAME MACHINES FEATURING AMUSEMENT, ENTERTAINMENT AND SPORTS THEMES (U.S. CLS. 22, 23, 38 AND 50).

ODESSA BIBBINS, EXAMINING ATTORNEY

SN 78-525,639. GROVE CITY COLLEGE, GROVE CITY, PA.
FILED 12-2-2004.

VISION & VALUES

THE MARK CONSISTS OF STANDARD CHARACTERS WITHOUT CLAIM TO ANY PARTICULAR FONT, STYLE, SIZE, OR COLOR.

CLASS 16—PAPER GOODS AND PRINTED MATTER

FOR PRINTED PUBLICATIONS, NAMELY, NEWSLETTERS FEATURING TOPICS FOSTERING CHRISTIAN VALUES (U.S. CLS. 2, 5, 22, 23, 29, 37, 38 AND 50).
FIRST USE 3-30-1993; IN COMMERCE 3-30-1993.

CLASS 41—EDUCATION AND ENTERTAINMENT

FOR EDUCATIONAL SERVICES, NAMELY, DEVELOPING AND CONDUCTING CLASSES, SEMINARS, RESEARCH AND COMMENTARY IN THE FIELDS OF RELIGION, THE SOCIAL SCIENCES, AND THE NATURAL SCIENCES, AND DISTRIBUTING COURSE MATERIALS IN CONNECTION THEREWITH (U.S. CLS. 100, 101 AND 107).

FIRST USE 3-30-1993; IN COMMERCE 3-30-1993.
ATTIYA MALIK, EXAMINING ATTORNEY

SN 78-526,919. ACE STYLE INTIMATE APPAREL LIMITED,
KWAI CHUNG, NEW TERRITORIES, HONG KONG,
FILED 12-3-2004.



NO CLAIM IS MADE TO THE EXCLUSIVE RIGHT TO USE "GROUP", APART FROM THE MARK AS SHOWN.

CLASS 16—PAPER GOODS AND PRINTED MATTER

FOR MAGAZINES FEATURING TEXTILE, CLOTHING, CLOTHING ACCESSORIES, FOOTWEAR, HEADGEAR, INTIMATE APPAREL, AND LINGERIE; PERIODICALS IN THE FIELD OF TEXTILE, CLOTHING, CLOTHING ACCESSORIES, FOOTWEAR, HEADGEAR, INTIMATE APPAREL, AND LINGERIE; NEWSPAPERS; WRITING PAPER; BOOKS IN THE FIELD OF TEXTILE, CLOTHING, CLOTHING ACCESSORIES, FOOTWEAR, HEADGEAR, INTIMATE APPAREL, AND LINGERIE; FORMS, NAMELY, ORDER FORMS, BUSINESS FORMS, BLANK FORMS; CALENDARS; POSTERS; BAGS MADE OF PAPER AND PLASTIC FOR PACKAGING AND MERCHANDISE PACKAGING; TOILET PAPER; NOTEPADS; ANNOUNCEMENT CARDS; CARDS, NAMELY, GREETING CARDS, NOTE CARDS AND GIFT CARDS; WRITING AND DRAWING INSTRUMENTS AND REFILLS THEREOF; DRAWING MATERIALS, NAMELY, PAINTERS' ARTICLES, BRUSHES, COMPASSES, INSTRUMENTS, PADS, PAPER, PENCILS, MARKERS AND PENS; INKS, NAMELY, PEN INK AND WRITING INK; INKING RIBBONS; INKING PADS; BLACKBOARDS; ENGRAVINGS; TAILORS' CHALK; PAPER, NAMELY ADVERTISING SIGNS OF PAPER, BANNERS OF PAPER AND WRITING PAPER; CARDBOARD AND GOODS MADE FROM THESE MATERIALS, NAMELY CARDBOARD BOXES; PRINTED MATTER, NAMELY, SIGNS; BOOKBINDING MATERIAL, NAMELY, BOOKBINDING TAPE AND BOOKBINDING WIRE; PHOTOGRAPHS; STATIONERY; ADHESIVES FOR STATIONERY OR

HOUSEHOLD PURPOSES; ARTISTS' MATERIALS NAMELY PAINTING SETS FOR ARTISTS; PAINT BRUSHES; TYPEWRITERS AND OFFICE REQUISITES, NAMELY, FINGER-STALLS, ENVELOPE SEALING MACHINES, PAPER EMBOSSERS, PUNCHES AND RUBBER BANDS; STAPLERS; PRINTED INSTRUCTIONAL AND TEACHING MATERIAL IN THE FIELD OF TEXTILE, CLOTHING, CLOTHING ACCESSORIES, FOOTWEAR, HEADGEAR, INTIMATE APPAREL, AND LINGERIE; PRINTED PUBLICATIONS, NAMELY, BOOKS, MAGAZINES, PERIODICALS IN THE FIELD OF TEXTILE, CLOTHING, CLOTHING ACCESSORIES, FOOTWEAR, HEADGEAR, INTIMATE APPAREL, LINGERIE; PRINTED RESEARCH PUBLICATIONS, NAMELY, REPORTS FEATURING TEXTILE, CLOTHING, CLOTHING ACCESSORIES, FOOTWEAR, HEADGEAR, INTIMATE APPAREL, AND LINGERIE AND OTHER PRINTED MATTER, NAMELY, TEXT BOOKS AND MAGAZINES FEATURING TEXTILE, CLOTHING, CLOTHING ACCESSORIES, FOOTWEAR, HEADGEAR, INTIMATE APPAREL AND LINGERIE; LETTER WRITING SETS COMPRISING, STATIONERY AND PENS; MEMO PADS; DIARIES; YEARBOOKS; PRINTED TIMETABLES; POST-CARDS; RINGBINDERS; BINDERS; SOUVENIR BOOKLETS; MARKER PENS; PENS; PENCILS; PENCIL CASES; FOLDERS; ENVELOPES; ADHESIVE TAPES AND BANDS FOR STATIONERY OR HOUSEHOLD PURPOSES; PLASTIC MATERIALS FOR PACKAGING, NAMELY PLASTIC BAGS; PRINTERS' TYPE; PRINTING BLOCKS; PERSONAL ORGANIZERS; BOXES, NAMELY, PAPER BOXES; PEN BOXES MADE OF PLASTIC; STATIONERY BOXES MADE OF PLASTIC; PACKAGING MATERIALS OF PAPER OR CARDBOARD, NAMELY, BOXES AND BAGS; WRAPPING OR PACKING MATERIALS, NAMELY, GIFT WRAPPING PAPER, PLASTIC BUBBLE PACKS, GIFT WRAPPING RIBBONS; BOXES OF CARDBOARD OR PAPER; PACKAGING CONTAINERS OF PAPER; ERASERS; LABELS, NAMELY, PAPER LABELS, SHIPPING LABELS; PRINTED ANALYSIS PUBLICATIONS AND REPORTS IN THE FIELD OF TEXTILE, CLOTHING, CLOTHING ACCESSORIES, FOOTWEAR, HEADGEAR, INTIMATE APPAREL, AND LINGERIE; CATALOGUES IN THE FIELD OF TEXTILE, CLOTHING, CLOTHING ACCESSORIES, FOOTWEAR, HEADGEAR, INTIMATE APPAREL AND LINGERIE; PRINTED MANUALS AND PAMPHLETS IN THE FIELD OF INSTRUCTIONAL MATH; DOCUMENT FILES; GRAPHIC PRINTS; CHARTS IN THE FIELD OF TEXTILE, CLOTHING, CLOTHING ACCESSORIES, FOOTWEAR, HEADGEAR, INTIMATE APPAREL, AND LINGERIE; PRINTED CHARTS; HANDBOOKS IN THE FIELD OF TEXTILE, CLOTHING, CLOTHING ACCESSORIES, FOOTWEAR, HEADGEAR, INTIMATE APPAREL, AND LINGERIE; GUMMED PAPER AND GUMMED TAPE FOR STATIONERY AND HOUSEHOLD PURPOSES; PAPER SHEETS FOR NOTE TAKING, DRAWING; PICTURES; LITHOGRAPHS; ADVERTISEMENT BOARDS OF PAPER OR CARDBOARD; MANIFOLD STATIONERY; SIGNBOARDS OF PAPER OR CARDBOARD (U.S. CLS. 2, 5, 22, 23, 29, 37, 38 AND 50).

CLASS 35—ADVERTISING AND BUSINESS

FOR ADVERTISING SERVICES THROUGH ALL FORMS OF MEDIA, NAMELY, MOBILE PHONES, FIXED LINE PHONES, ONLINE, TELEVISION, RADIO, DIRECT MAIL OR PRINT ADVERTISEMENTS; ADVERTISING AGENCIES; DEMONSTRATION OF GOODS FOR ADVERTISING PURPOSES; ADVERTISING BY MAIL ORDER, NAMELY, DIRECT MAIL ADVERTISING, SERVICES AND CATALOG SERVICES FEATURING TEXTILE, CLOTHING, CLOTHING ACCESSORIES, FOOTWEAR, HEADGEAR, INTIMATE APPAREL, AND LINGERIE; DISSEMINATION OF ADVERTISING MATTER; RENTAL OF ADVERTISING SPACE; COSTS PRICE ANALYSIS; BILL-POSTING; DISTRIBUTION OF SAMPLES; OPINION POLLING; ORGANIZATION OF EXHIBITIONS FOR COMMERCIAL OR ADVERTISING PURPOSES; MARKETING RESEARCH; MARKETING STUDIES; MODELING FOR ADVERTISING OR SALES PROMOTION; NEWS CLIPPING SERVICES; ON-LINE ADVERTISING ON A COMPUTER NETWORK; PROVIDING TELEVISION ADVERTISING AND COMMERCIALS FOR OTHERS; PROVIDING RADIO ADVERTISING AND COMMERCIALS FOR OTHERS; PREPARING AND PLACING OUTDOOR ADVERTISING FOR OTHERS; PUBLIC RELATIONS; PUBLICATION OF PUBLICITY

TEXTS; PUBLICITY CONSULTATION; PUBLICITY AGENCIES; PUBLICITY MATERIAL RENTAL; THE BRINGING TOGETHER, FOR THE BENEFIT OF OTHERS, OF A VARIETY OF GOODS AND SERVICES, ENABLING CUSTOMERS TO CONVENIENTLY VIEW, PURCHASE OR ORDER THOSE GOODS AND SERVICES FROM A GENERAL MERCHANDISING INTERNET WEB SITE; THE BRINGING TOGETHER, FOR THE BENEFIT OF OTHERS, OF A VARIETY OF GOODS, ENABLING CUSTOMERS TO CONVENIENTLY VIEW AND PURCHASE THOSE GOODS IN A DEPARTMENT STORE, SUPERMARKET AND/OR CONVENIENCE STORE; WINDOW DRESSING AND DISPLAY ARRANGEMENT SERVICES; PUBLICITY AND SALES PROMOTION FOR OTHERS; BUSINESS MANAGEMENT; BUSINESS CONSULTANCY; BUSINESS INFORMATION AND INQUIRIES; BUSINESS INVESTIGATIONS; BUSINESS MANAGEMENT ASSISTANCE; BUSINESS RESEARCH; RELOCATION SERVICES FOR BUSINESS; COMMERCIAL INFORMATION AGENCIES; COMMERCIAL OR INDUSTRIAL MANAGEMENT ASSISTANCE; DOCUMENT REPRODUCTION; ECONOMIC FORECASTING; EMPLOYMENT AGENCIES; COMPUTERIZED FILE MANAGEMENT; IMPORT-EXPORT AGENCIES; PERSONNEL MANAGEMENT CONSULTANCY; PERSONNEL RECRUITMENT; PROCUREMENT SERVICES FOR OTHERS, NAMELY, PURCHASING GOODS AND SERVICES FOR OTHERS; PSYCHOLOGICAL TESTING FOR THE SELECTION OF PERSONNEL; COMPILATION OF DIRECTORIES FEATURING TRADE AND BUSINESS PRICE AND STATISTICAL INFORMATION FOR PUBLISHING; PROVIDING STATISTICAL INFORMATION FOR BUSINESS OR COMMERCIAL PURPOSES; BUSINESS ADMINISTRATION; BOOKKEEPING; BUSINESS APPRAISALS; DATA SEARCH IN COMPUTER FILES FOR OTHERS; PAYROLL PREPARATION; SECRETARIAL SERVICES; PROVIDING OFFICE FUNCTIONS; TYPING; TRANSCRIPTION; TAX PREPARATION; ACCOUNTING SERVICES, NAMELY, DRAWING UP OF STATEMENT OF ACCOUNTS; AUCTIONEERING; AUDITING, NAMELY, BUSINESS AUDITING, ACCOUNT AUDITING; RENTAL OF OFFICE MACHINES AND EQUIPMENT; RENTAL OF VENDING MACHINES; TELEPHONE ANSWERING SERVICES FOR UNAVAILABLE SUBSCRIBERS; WHOLESALE AND RETAIL STORE SERVICES FEATURING TEXTILE, CLOTHING, CLOTHING ACCESSORIES, FOOTWEAR, HEADGEAR, INTIMATE APPAREL, AND LINGERIE; THE BRINGING TOGETHER, FOR THE BENEFIT OF OTHERS, OF A VARIETY OF GOODS THROUGH INTERNET SHOPPING CHANNELS ENABLING CUSTOMERS TO CONVENIENTLY VIEW AND PURCHASE THOSE GOODS BY MEANS OF TELECOMMUNICATIONS; COMPUTERIZED ORDERING SERVICES IN THE FIELD OF TEXTILE, CLOTHING, CLOTHING ACCESSORIES, FOOTWEAR, HEADGEAR, INTIMATE APPAREL, AND LINGERIE; ON-LINE WHOLESALE AND RETAIL STORE FEATURING TEXTILE, CLOTHING, CLOTHING ACCESSORIES, FOOTWEAR, HEADGEAR, INTIMATE APPAREL, AND LINGERIE; PROVIDING A WEB SITE WHICH FEATURES ADVERTISEMENTS FOR THE GOODS AND SERVICES OF OTHERS ON A GLOBAL COMPUTER NETWORK; PROVIDING INFORMATION ABOUT COMMERCIAL BUSINESS AND COMMERCIAL INFORMATION VIA THE GLOBAL COMPUTER NETWORK (U.S. CLS. 100, 101 AND 102).

RICHARD WHITE, EXAMINING ATTORNEY

SN 78-531,596. VOLVO TRADEMARK HOLDING AB, GÖTEBORG, SWEDEN, FILED 12-13-2004.

VOLVO

THE MARK CONSISTS OF STANDARD CHARACTERS WITHOUT CLAIM TO ANY PARTICULAR FONT, STYLE, SIZE, OR COLOR.

OWNER OF SWEDEN REG. NO. 135541, DATED 6-18-1971, EXPIRES 6-18-2011.

OWNER OF U.S. REG. NOS. 636,129, 967,983 AND OTHERS.

THE FOREIGN WORDING IN THE MARK TRANSLATES INTO ENGLISH AS I AM ROLLING.

CLASS 1—CHEMICALS

FOR CHEMICALS USED IN INDUSTRY, IN PARTICULAR FOR USE IN THE OPERATION, REPAIR, SERVICING AND MAINTENANCE OF VEHICLES, ENGINES/MOTORS AND MACHINES, INCLUDING DRIVE UNITS AND CONSTRUCTION MACHINES, NAMELY BRAKE FLUIDS, FLUIDS FOR HYDRAULIC SYSTEMS, ANTIFREEZE COMPOSITIONS, DEFROSTING COMPOSITIONS, RUBBER AND PLASTIC CONTACT CEMENTS, PLASTICS IN THE NATURE OF PLASTIC MOLDING COMPOUNDS FOR USE IN THE MANUFACTURE OF MOLDED PLASTIC ARTICLES, ADHESIVES IN THE NATURE OF ADHESIVES FOR THE MOTOR VEHICLE INDUSTRY AND FOR GENERAL INDUSTRIAL USE; COMPOSITIONS FOR REPAIRING SURFACES IN THE NATURE OF RUBBER CEMENT FOR REPAIRING PNEUMATIC TIRES; SEALING COMPOSITIONS IN THE NATURE OF INDUSTRIAL ADHESIVES FOR USE IN COATING AND SEALING; WATERPROOFING CHEMICAL COMPOSITIONS; SPOT-REPELLENT CHEMICAL AGENTS FOR COATING OF TEXTILES, FURS AND LEATHER, NON-WOVENS AND FABRICS; IMPREGNATION CHEMICAL AGENTS FOR EMPREGNATING TEXTILES, FURS AND LEATHER, NON-WOVENS AND FABRICS; UNPROCESSED ARTIFICIAL RESINS FOR THE MOTOR VEHICLE INDUSTRY, UNPROCESSED PLASTICS; FERTILIZERS; FIRE EXTINGUISHING COMPOSITIONS; TEMPERING CHEMICALS FOR USE IN METALWORKING OR SOLDERING; CHEMICAL SUBSTANCES FOR PRESERVING FOODSTUFFS; TANNING SUBSTANCES IN THE NATURE OF TANNING AGENTS FOR USE IN THE MANUFACTURE OF LEATHER AND TEXTILES; ADHESIVES USED IN INDUSTRY IN THE NATURE OF INDUSTRIAL ADHESIVES FOR USE IN COATING AND SEALING; WETTING AGENTS (U.S. CLS. 1, 5, 6, 10, 26 AND 46).

CLASS 2—PAINTS

FOR RUST PRESERVATIVES IN THE NATURE OF A SPRAY COATING FOR VEHICLES, ENGINES/MOTORS AND MACHINES INCLUDING DRIVE UNITS AND CONSTRUCTION MACHINES; INDUSTRIAL OILS AND GREASES, NAMELY ANTI-RUST OILS (U.S. CLS. 6, 11 AND 16).

CLASS 3—COSMETICS AND CLEANING PREPARATIONS

FOR LAUNDRY BLEACH; OTHER SUBSTANCES FOR LAUNDRY IN THE NATURE OF LAUNDRY SOAP; CLEANING, CARE, POLISHING, SCOURING AND ABRASIVE AGENTS FOR VEHICLES, ENGINES/MOTORS AND MACHINES INCLUDING DRIVE UNITS AND CONSTRUCTION MACHINES, NAMELY DETERGENTS, WINDSCREEN/WINDSHIELD WASHER FLUIDS, AUTOMOBILE, BUS AND TRUCK WAX COMPOSITIONS, GENERAL PURPOSE CLEANING SPRAYS, AUTO SHAMPOOS, INTERIOR CLEANING AGENTS IN THE NATURE OF ALL PURPOSE CLEANING PREPARATIONS, MOTOR CLEANING PREPARATIONS, LIGHT METAL OR METAL ALLOY WHEEL RIM CARE AGENTS IN THE NATURE OF TREATMENT PREPARATIONS FOR USE ON VEHICLE WHEEL COVERS AND VEHICLE RIMS; SOAPS FOR VEHICLES; SOAPS FOR PERSONAL USE; PERFUMERY, ESSENTIAL OILS FOR PERSONAL USE AND FOR USE IN VEHICLES, COSMETICS, HAIR LOTIONS, TOILET WATER, TALCUM POWDER, SHAVING PREPARATIONS; AFTER-SHAVE PREPARATIONS IN THE NATURE OF LOTION, GEL AND PERFUMERY, NON-MEDICATED OILS, CREAMS AND LOTIONS FOR THE SKIN; DENTIFRICES (U.S. CLS. 1, 4, 6, 50, 51 AND 52).

CLASS 4—LUBRICANTS AND FUELS

FOR INDUSTRIAL OILS AND GREASES, NAMELY, LUBRICATING OILS AND HYDRAULIC OILS; LUBRICANTS, NAMELY VEHICLE LOCK LUBRICANTS; PETROLEUM BASED DUST ABSORBING COMPOSITIONS FOR USE IN ROAD BUILDING, SWEEP, DUST-LAYING; DUST BINDING COMPOSITIONS; FUELS, NAMELY MOTOR SPIRIT; SOLID, LIQUID AND GASEOUS FUELS; CANDLES, LAMP WICKS (U.S. CLS. 1, 6 AND 15).

CLASS 5—PHARMACEUTICALS

FOR DIETETIC FOODS ADAPTED FOR MEDICAL USE, FOOD FOR BABIES; MEDICAL PLASTERS, GAUZE FOR DRESSINGS; FIRST-AID KITS; MATERIAL FOR STOPPING TEETH, DENTAL WAX; ALL PURPOSE DISINFECTANTS; PREPARATIONS FOR DESTROYING VERMIN; FUNGICIDES, HERBICIDES (U.S. CLS. 6, 18, 44, 46, 51 AND 52).

CLASS 6—METAL GOODS

FOR COMMON METALS AND THEIR ALLOYS IN THE NATURE OF METAL BARS AND METAL ALLOYS FOR FURTHER MANUFACTURING; METAL BUILDING MATERIALS, NAMELY LINING OF METAL FOR BUILDING PURPOSES; TRANSPORTABLE BUILDINGS OF METAL; MATERIALS OF METAL FOR RAILWAY TRACKS; NON-ELECTRICAL WIRES AND CABLES OF COMMON METAL; IRONMONGERY AND SMALL ITEMS OF METAL HARDWARE AND GOODS OF COMMON METAL, NAMELY, LOCKS, LATCHES, METALLIC TUBES, AND METALLIC HOSES FOR LAND, AIR OR WATER VEHICLES, ENGINES FOR LAND, AIR OR WATER VEHICLES, DIESEL ENGINES FOR MACHINES AND MACHINES, NAMELY EXCAVATORS, LOADERS, DUMPER BODIES, WOOD WORKING MACHINES, AGRICULTURAL AND FORESTRY MACHINES, PACKING AND LABELING MACHINES, EARTH MOVING MACHINES, NAMELY WHEELED EXCAVATORS, COMPACT WHEEL LOADERS, CRAWLER EXCAVATORS, COMPACT EXCAVATORS, WHEEL LOADERS, EARTH MOVING MACHINES, NAMELY MOTOR GRADERS, BACKHOE LOADERS AND DRIVE UNITS; GOODS OF COMMON METAL, NAMELY, MANUALLY OPERATED METALLIC VALVES FOR PIPES, PIPES, PIPE CONNECTORS, SCREWS, BOLTS, NUTS, RIVETS, LOCK WASHERS, SPRING WASHERS, FLAT WASHERS, CHAINS NOT INCLUDING DRIVE CHAINS FOR VEHICLES, PLUGS, SPLIT PINS, SHIMS, SPACER RINGS, BUSHINGS, CLAMPS AND CLIPS FOR LAND, AIR OR WATER VEHICLES, ENGINES FOR LAND, AIR OR WATER VEHICLES, DIESEL ENGINES FOR MACHINES AND MACHINES, NAMELY EXCAVATORS, LOADERS, DUMPER BODIES, WOOD WORKING MACHINES, AGRICULTURAL AND FORESTRY MA-

CHINES, PACKING AND LABELING MACHINES, EARTH MOVING MACHINES, NAMELY WHEELED EXCAVATORS, COMPACT WHEEL LOADERS, CRAWLER EXCAVATORS, COMPACT EXCAVATORS, WHEEL LOADERS, EARTH MOVING MACHINES, NAMELY MOTOR GRADERS, BACKHOE LOADERS AND DRIVE UNITS; GOODS OF COMMON METAL, NAMELY, WOODRUFF KEYS FOR LAND, AIR OR WATER VEHICLES, ENGINES FOR LAND, AIR OR WATER VEHICLES, DIESEL ENGINES FOR MACHINES AND MACHINES, NAMELY EXCAVATORS, LOADERS, DUMPER BODIES, WOOD WORKING MACHINES, AGRICULTURAL AND FORESTRY MACHINES, PACKING AND LABELING MACHINES, EARTH MOVING MACHINES, NAMELY WHEELED EXCAVATORS, COMPACT WHEEL LOADERS, CRAWLER EXCAVATORS, COMPACT EXCAVATORS, WHEEL LOADERS, EARTH MOVING MACHINES, NAMELY MOTOR GRADERS, BACKHOE LOADERS AND DRIVE UNITS; GOODS OF COMMON METAL, NAMELY, SCREW UNIONS FOR LAND, AIR OR WATER VEHICLES, ENGINES FOR LAND, AIR OR WATER VEHICLES, DIESEL ENGINES FOR MACHINES AND MACHINES, NAMELY EXCAVATORS, LOADERS, DUMPER BODIES, WOOD WORKING MACHINES, AGRICULTURAL AND FORESTRY MACHINES, PACKING AND LABELING MACHINES, EARTH MOVING MACHINES, NAMELY WHEELED EXCAVATORS, COMPACT WHEEL LOADERS, CRAWLER EXCAVATORS, COMPACT EXCAVATORS, WHEEL LOADERS, EARTH MOVING MACHINES, NAMELY MOTOR GRADERS, BACKHOE LOADERS AND DRIVE UNITS; GOODS OF COMMON METAL, NAMELY, SPRING BOLTS AND SHACKLES FOR LAND, AIR OR WATER VEHICLES, ENGINES FOR LAND, AIR OR WATER VEHICLES, DIESEL ENGINES FOR MACHINES AND MACHINES, NAMELY EXCAVATORS, LOADERS, DUMPER BODIES, WOOD WORKING MACHINES, AGRICULTURAL AND FORESTRY MACHINES, PACKING AND LABELING MACHINES, EARTH MOVING MACHINES, NAMELY WHEELED EXCAVATORS, COMPACT WHEEL LOADERS, CRAWLER EXCAVATORS, COMPACT EXCAVATORS, WHEEL LOADERS, EARTH MOVING MACHINES, NAMELY MOTOR GRADERS, BACKHOE LOADERS AND DRIVE UNITS; GOODS OF COMMON METAL, NAMELY, HINGES, BRACKETS FOR LAND, AIR OR WATER VEHICLES, ENGINES FOR LAND, AIR OR WATER VEHICLES, DIESEL ENGINES FOR MACHINES AND MACHINES, NAMELY EXCAVATORS, LOADERS, DUMPER BODIES, WOOD WORKING MACHINES, AGRICULTURAL AND FORESTRY MACHINES, PACKING AND LABELING MACHINES, EARTH MOVING MACHINES, NAMELY WHEELED EXCAVATORS, COMPACT WHEEL LOADERS, CRAWLER EXCAVATORS, COMPACT EXCAVATORS, WHEEL LOADERS, EARTH MOVING MACHINES, NAMELY MOTOR GRADERS, BACKHOE LOADERS AND DRIVE UNITS; METAL STORAGE TANKS FOR LIQUIDS FOR ENGINES FOR LAND, AIR OR WATER VEHICLES, DIESEL ENGINES FOR MACHINES AND MACHINES, NAMELY EXCAVATORS, LOADERS, DUMPER BODIES, WOOD WORKING MACHINES, AGRICULTURAL AND FORESTRY MACHINES, PACKING AND LABELING MACHINES, EARTH MOVING MACHINES, NAMELY WHEELED EXCAVATORS, COMPACT WHEEL LOADERS, CRAWLER EXCAVATORS, COMPACT EXCAVATORS, WHEEL LOADERS, EARTH MOVING MACHINES, NAMELY MOTOR GRADERS, BACKHOE LOADERS AND DRIVE UNITS; GOODS OF COMMON METAL, NAMELY, GREASE NIPPLES, FUEL CANS, LADDERS, HANDLES FOR DOORS, FUEL CANS AND TANKS FOR LIQUIDS, NON-LUMINOUS AND NON-MECHANICAL METALLIC SIGNS, WIRE BASKETS, METAL WIRES, BADGES FOR VEHICLES NAMELY NAME BADGES, LICENSE PLATES, ARTICLE NUMBER BADGES AND MODEL NUMBER BADGES, TOW ROPES OF METAL, KEYS FOR LOCKS, KEY BLANKS, KEY FOBS, KEY RINGS, VEHICLE REGISTRATION PLATES, MONEY CLIPS, BOXES, LUGGAGE LABELS, HOLIDAY ORNAMENTS NOT INCLUDING CHRISTMAS TREE ORNAMENTS, AND SAFES (U.S. CLS. 2, 12, 13, 14, 23, 25 AND 50).

CLASS 7—MACHINERY

FOR MOTORS AND ENGINES NOT FOR LAND VEHICLES, NAMELY, BOAT ENGINES, AIRCRAFT ENGINES, ENGINES FOR INDUSTRIAL, AGRICULTURAL AND FORESTRY MACHINES, STATIONARY COMBUSTION ENGINES FOR MACHINES AND FOR THE GENERATION OF ELECTRICITY, TURBINES, ELECTRIC MOTORS FOR MACHINES; ELECTRIC GENERATORS AND STARTER ALTERNATORS; HIGH-FREQUENCY GENERATORS FOR MACHINES; AIR FILTERS FOR ENGINES AND ANTI-POLLUTION DEVICES FOR MOTORS AND ENGINES IN THE NATURE OF CATALYZERS FOR CATALYTIC EMISSION CONTROL; CARBURETORS, CATALYTIC CONVERTERS FOR LIQUID FUELS, FUEL INJECTORS, INJECTION PUMPS FOR MOTORS AND ENGINES, FUEL PUMPS; PARTS FOR MACHINES, ENGINES AND MOTORS NOT FOR LAND VEHICLES, NAMELY, SPEED GOVERNORS, FUEL INJECTION NOZZLES AND NOZZLE HOLDERS, MACHINE VALVES, VAPORIZERS, STARTERS, IGNITION SYSTEMS COMPRISING IGNITION COILS AND CONTROL ELECTRONICS AND STRUCTURAL COMPONENTS THEREOF, IGNITION COILS, GLOW PLUGS, SPARK PLUGS, SPARK PLUG CONNECTORS, LAMBDA PROBES, MAGNETOS, SILENCERS/MUFFLERS AND SPARK ARRESTERS FOR COMBUSTION ENGINES; FUEL FILTERS, OIL FILTERS, AIR FILTERS FOR VEHICLE MOTORS AND ENGINES; PARTS FOR ENGINE COOLING RADIATORS, NAMELY ROLLING BEARINGS, PLAIN BEARINGS, SHAFTS, SHAFT SEALS, GEARWHEELS, DRIVE WHEELS, SPEED CHANGE GEAR, PULLEYS, DRIVE CHAINS AND BELTS, SPRINGS, FILTERS, PUMPS, REGULATORS, RELIEF VALVES, CONTROLS, FANS, AND FAN BELTS, PARTS FOR MACHINES, ENGINES AND MOTORS NOT FOR LAND VEHICLES, NAMELY, COOLING FANS, COOLING RADIATORS, STARTERS, FUEL FEED APPARATUS, OIL COOLING APPARATUS, BRAKES, CAPS FOR COOLING RADIATORS, ACCELERATORS, HYDRAULIC PUMPS, HYDRAULIC CYLINDERS, HYDRAULIC RESERVOIRS, HYDRAULIC FILTERS, HYDRAULIC MOTORS, HYDRAULIC PIPES, HYDRAULIC VALVES AND BOOST UNITS FOR HYDRAULIC TRANSMISSION; MACHINE COUPLING AND TRANSMISSION COMPONENTS NOT FOR LAND VEHICLES, NAMELY, POWER TRANSMISSIONS, GEARBOXES/TRANSMISSIONS, REVERSE GEARS, REDUCTION GEARS, GEARBOX CONTROLLERS, SHAFT CONNECTIONS, COUPLINGS AND CLUTCHES, EXHAUSTS, COUPLINGS AND TRANSMISSION BELTS; POWER TRANSMISSION TAKE-OFF UNITS FOR MOTOR VEHICLE ENGINES, NOT FOR LAND VEHICLES, FOR USE AS PRIME MOVERS; INBOARD/OUTBOARD DRIVE UNITS AND SAILING BOAT DRIVE UNITS FOR INBOARD ENGINES, NOT FOR LAND VEHICLES; HYDRAULIC PUMPS AND MOTORS AND COMPONENTS THEREOF, AIR PUMPS AS VEHICLE ACCESSORIES, NOT FOR LAND VEHICLES; MACHINE PARTS NAMELY, BUSHES AND BEARINGS; PARTS FOR MACHINES, ENGINES AND MOTORS NOT FOR LAND VEHICLES, NAMELY, PNEUMATIC VALVES, CONTROL VALVES, BRAKING VALVES; EXHAUST-GAS TURBO-CHARGERS; COMPRESSORS, COMPRESSED AIR BRAKES, COMPRESSED AIR RESERVOIRS, COMPRESSED AIR CYLINDERS AND COMPRESSED AIR MOTORS, BILGE PUMPS; METAL AND PLASTICS WORKING MACHINES; INCUBATORS FOR EGGS; POWER OPERATED AGRICULTURAL IMPLEMENTS, NAMELY, CULTIVATORS, HARVESTERS, DISK HARROWS, SEEDERS; CONSTRUCTION MACHINES, NAMELY, EXCAVATORS, LOADERS, DUMPER BODIES; WOOD WORKING MACHINES, PACKING AND LABELING MACHINES, EARTH MOVING MACHINES, NAMELY, WHEELED EXCAVATORS, COMPACT WHEEL LOADERS, CRAWLER EXCAVATORS, COMPACT EXCAVATORS, WHEEL LOADERS, EARTH MOVING MACHINES, NAMELY MOTOR GRADERS, BACKHOE LOADERS AND DRIVE UNITS; MACHINE TOOLS AND POWER TOOLS THEREFORE FOR USE IN RELATION TO THE MANUFACTURE, SERVICE AND REPAIR OF LAND, AIR OR WATER VEHICLES, ENGINES FOR LAND, AIR OR WATER VEHICLES, DIESEL ENGINES FOR MACHINES AND MACHINES, NAMELY EXCAVATORS, LOADERS, DUMPER BODIES, WOOD WORKING MACHINES, AGRICULTURAL AND FORESTRY MACHINES, PACKING AND LABELING MACHINES, EARTH MOVING MACHINES, NAMELY, WHEELED EXCAVATORS, COMPACT WHEEL LOADERS, CRAWLER EXCAVATORS, COMPACT EXCAVATORS, WHEEL LOADERS, EARTH MOVING MACHINES, NAMELY MOTOR GRADERS, BACKHOE LOADERS AND DRIVE UNITS; MACHINE TOOLS AND POWER TOOLS THEREFORE FOR USE IN RELATION TO THE MANUFACTURE, SERVICE AND REPAIR OF LAND, AIR OR WATER VEHICLES, ENGINES FOR LAND, AIR OR WATER VEHICLES, DIESEL ENGINES FOR MACHINES AND MACHINES, NAMELY EXCAVATORS, LOADERS, DUMPER BODIES, WOOD WORKING MACHINES, AGRICULTURAL AND FORESTRY MACHINES, PACKING AND LABELING MACHINES, EARTH MOVING MACHINES, NAMELY, WHEELED EXCAVATORS, COMPACT WHEEL LOADERS, CRAWLER EXCAVA-

TORS, COMPACT EXCAVATORS, WHEEL LOADERS, EARTH MOVING MACHINES, NAMELY MOTOR GRADERS, BACKHOE LOADERS AND DRIVE UNITS; MACHINE TOOLS FOR THE CUTTING AND FORMING OF MATERIALS; MACHINES TOOLS FOR REMOVING WASTE MATERIAL; ELECTRIC POWER TOOLS NAMELY, DRILLS, ROUTERS, CIRCULAR SAWS AND THEIR PLUG-IN TOOLS; ELECTRIC CAN OPENERS; HYDRAULIC LIFT JACKS, BODY AND FRAME ALIGNERS FOR THE MANUFACTURE OF VEHICLES, ENGINES AND MACHINES; PACKING AND INDUSTRIAL LABELING MACHINES, CONVEYORS, CONVEYOR BELTS; LOADING AND HANDLING MACHINES FOR PRESSING PLANTS AND FOUNDRIES AND MACHINES FOR THE TOOLING OF BLANKS; EARTH MOVING MACHINES NAMELY, LOADERS, DUMPER BODIES, AND EXCAVATORS AS WELL AS PARTS, INCLUDING COMPONENTS, AND ACCESSORIES TO SUCH PRODUCTS; HYDRAULIC LIFTING APPARATUS IN THE NATURE OF CRANES AND WINCHES; BUCKET, GRAPPLE AND FORK TYPE IMPLEMENTS FOR MACHINES FOR MOVING, EXCAVATING AND LOADING; WOOD WORKING MACHINES, NAMELY, DE-LIMBING, SLASHING-, AND DEBARKING MACHINES; TEETH AND CUTTING EDGES FOR WOODWORKING MACHINES; CAR VACUUM CLEANERS; CAR WASHING INSTALLATIONS; METAL BUSHING, PARTS, FITTINGS AND ACCESSORIES FOR ENGINES/MOTORS AND MACHINES INCLUDING DRIVE UNITS AND CONSTRUCTION MACHINES IN THE NATURE OF EXCAVATORS, LOADERS, DUMPER BODIES, WOOD WORKING MACHINES, AGRICULTURAL AND FORESTRY MACHINES, PACKING AND LABELING MACHINES, EARTH MOVING MACHINES, NAMELY WHEELED EXCAVATORS, COMPACT WHEEL LOADERS, CRAWLER EXCAVATORS, COMPACT EXCAVATORS, WHEEL LOADERS, EARTH MOVING MACHINES, NAMELY MOTOR GRADERS, BACKHOE LOADERS, NOT FOR LAND VEHICLES; RADIATORS AND RADIATOR CAPS FOR VEHICLES; MUFFLERS FOR VEHICLES; SPARK PLUGS; EXHAUST PIPES FOR LAND VEHICLES; COUPLINGS FOR MACHINES; FANS AND FAN BELTS FOR ENGINES; LEVEL REGULATORS BEING PARTS OF MACHINES, ENGINE NOISE SHIELDS IN THE NATURE OF MUFFLERS AND SILENCERS; VEHICLE ENGINE PARTS, NAMELY, OIL TANK CAPS; PARTS, INCLUDING COMPONENTS, AND ACCESSORIES FOR LAND VEHICLES, NAMELY, STARTER MOTORS AND STARTING DEVICES FOR INTERNAL COMBUSTION ENGINES; NON-METAL GASKETS FOR VEHICLES, ENGINES/MOTORS AND MACHINES; GROMMETS MADE OF RUBBER OR OF PLASTICS MATERIAL FOR USE WITH ENGINES/MOTORS AND MACHINES (U.S. CLS. 13, 19, 21, 23, 31, 34 AND 35).

CLASS 8—HAND TOOLS

FOR HAND OPERATED TOOLS AND IMPLEMENTS NAMELY, MANUALLY HANDLED LIFTING JACKS, HAND TOOLS SETS COMPRISING AUTOMOBILE SHEET METAL DENT REPAIR TOOL, SHOVELS, HAMMERS, WRENCHES, SOCKET WRENCHES, WIRE STRIPPERS, WIRE CUTTERS, BOLT CUTTERS, NUT DRIVERS, NIPPERS, TONGS, SCREWDRIVERS, FOUR-WAY RIM WRENCH AND SCRAPERS, ICE SCRAPERS AND CAN OPENERS; PARTS OF ALL AFOREMENTIONED GOODS; CUTLERY, NAMELY, KNIVES, POCKET KNIVES; SIDE ARMS, NOT INCLUDING FIREARMS, NAMELY HUNTING KNIVES; SCISSORS, MANICURE SETS AND MANICURE TOOLS, NAMELY, NAIL FILES, NAIL CLIPPERS, CUTICLE PUSHERS, TWEEZERS, NAIL AND CUTICLE SCISSORS; RAZORS AND TRAVEL RAZORS; TOOL KITS, NAMELY, KITS CONTAINING HAND-HELD TOOLS IN THE NATURE OF SCREWDRIVERS, SCRAPERS, TONGS, WRENCHES, SHOVELS, HAMMERS, WIRE CUTTERS, WIRE STRIPPERS AND FOUR-WAY RIM WRENCHES (U.S. CLS. 23, 28 AND 44).

CLASS 9—ELECTRICAL AND SCIENTIFIC APPARATUS

FOR VEHICLE ACCESSORIES, NAMELY, ANTENNAS, LOUDSPEAKERS, RADIO EQUIPMENT IN THE NATURE OF RADIOS, RADIO SETS, RADIO APPARATUS AND TWO WAY RADIOS; TIRE PRESSURE GAUGES AND TEMPERATURE GAUGES; ELECTRICAL AND ELECTRONIC CABLE TERMINALS FOR VEHICLES, ENGINES/MOTORS AND MACHINES INCLUDING DRIVE UNITS AND CONSTRUCTION MACHINES; SPEEDOMETER CABLES OF COMMON METAL; COMMERCIAL SAFETY NETS; TAPE MEASURE, WARNING TRIANGLES; JUMPER CABLES, EMERGENCY WARNING LIGHTS; EMERGENCY AUTO KITS COMPRISED OF A HAND HELD SPOTLIGHT AND BATTERY CHARGER; MOBILE TELEPHONE MOUNTING EQUIPMENT; SAFETY NETS FOR VEHICLES (U.S. CLS. 21, 23, 26, 36 AND 38).

CLASS 11—ENVIRONMENTAL CONTROL APPARATUS

FOR LIGHTING APPARATUS AND INSTALLATIONS FOR VEHICLES, NAMELY, HEADLIGHTS/HEADLAMPS, LAMP ASSEMBLIES IN THE NATURE OF SETS OF LAMPS FOR VEHICLES AND MACHINES; ELECTRIC LANTERNS, LIGHT BULBS, INCANDESCENT LAMP FITTINGS, FLASHLIGHTS, READING LIGHTS; ANTI-DAZZLE DEVICES, NAMELY VEHICLE REFLECTORS; AIR FILTERS FOR INDUSTRIAL MACHINES; AIR CONDITIONERS FOR VEHICLES AND MACHINES; VENTILATORS FOR VEHICLES, ENGINES/MOTORS AND MACHINES, REFRIGERATORS; VEHICLE HEATING SYSTEM COMPRISING ELECTRIC AND NON-ELECTRIC RADIATORS NOT FOR ENGINES, VENTILATORS, FANS, METALLIC VALVES FOR PIPES, PARTS FOR THE AFOREMENTIONED GOODS; STEAM GENERATORS; ELECTRIC COOKING OVENS; DRYERS IN THE NATURE OF ELECTRIC HOT AIR HAND DRYERS, WATER COOLERS; OZONE SANITIZERS FOR AIR AND WATER (U.S. CLS. 13, 21, 23, 31 AND 34).

CLASS 12—VEHICLES

FOR VEHICLES, NAMELY, CARS, VANS, SPORT-UTILITY VEHICLES, NAMELY MOTORIZED GOLF CARTS, BUSES, TRUCKS, TRACTORS, PRIME MOVERS IN THE NATURE OF TRUCK TRACTORS ON AND OFF ROAD ALL TERRAIN VEHICLES, DUMP TRUCKS; PARTS, INCLUDING COMPONENTS, AND ACCESSORIES FOR LAND VEHICLES, NAMELY, VEHICLE CHASSIS, VEHICLE BODIES, BRAKING SYSTEMS, BRAKE CALIPERS, BUMPER BARS, CLUTCHES, ENGINES, ELECTRIC ENGINES, MOTORS, ELECTRIC MOTORS, TURBINES, COMBUSTION ENGINES, HYDRAULIC CYLINDERS AND MOTORS, POWER TRANSMISSIONS, GEARBOXES/TRANSMISSIONS, TRANSMISSION SHAFTS, DIFFERENTIAL GEARS, DRIVE GEARS, DRIVE SHAFTS, GEAR CHANGE SELECTORS, AXLES TRAILER COUPLINGS, TRANSMISSION MECHANISM, MANUAL AND POWER STEERING APPARATUS, POWER STEERING UNITS AND COMPONENT PARTS, HYDRAULIC STEERING UNITS AND COMPONENT PARTS, COMPRESSED AIR RESERVOIRS, COMPRESSED AIR CYLINDERS AND COMPRESSED AIR MOTORS, OIL, AIR AND GAS ANTI-POLLUTION FILTERS, AIR PUMPS, ANTI-THEFT DEVICES AND ALARMS FOR VEHICLES, TRAILER HITCHES, POWER TAKE-OFFS IN THE NATURE OF A MECHANISM FOR TRANSMISSION OF THE POWER OF AN ENGINE OR VEHICLE TO OPERATE SOME OTHER MECHANISM, SUSPENSION SPRINGS, SHOCK ABSORBERS, WHEELS, WHEEL BEARINGS, WHEEL TRIMS, BALANCE WEIGHTS FOR WHEELS, ENGINE MOUNTINGS, GAS TANKS AND FUEL TANKS, FITTED AND SEMI-FITTED PROTECTIVE COVERS FOR VEHICLES, FRONT GRILLS, DIRECTION INDICATORS, HATCHES, UPHOLSTERY, HANDLES FOR DOORS, HOODS, HORNS, HUBS FOR VEHICLE WHEELS, HUB CAPS, HYDRAULIC CIRCUITS, TIRES, NON-SKID DEVICES FOR TIRES IN THE NATURE OF CHAINS, MUD FLAPS, BRAKES, SERVO-BRAKES AND COMPRESSED-AIR BRAKES, ANTILOCK BRAKE SYSTEMS FEATURING WHEEL SPEED SENSORS, ELECTRONIC CONTROL UNIT AND HYDRAULIC VALVE UNIT BRAKE PADS AND BRAKE LININGS, BUMPER, MUDGUARDS,

FENDERS, CABS, CAB TILT MECHANISMS, REVERSING ALARMS FOR VEHICLES, HEAD RESTS FOR SEATS, ARM RESTS, DOORS, SEATS, SAFETY-SEATS, PERSONAL SAFETY RESTRAINTS SEATS, SAFETY SEATS FOR CHILDREN, TABLES FOR SEATS, SEAT COVERS, HEADREST COVERS, SEAT BELTS, DEVICES FOR COLLISION PROTECTION IN THE NATURE OF AIR BAGS, AIR CURTAINS AND ROLL OVER PROTECTION BARS; SLIDING ROOFS, SUN ROOFS, VEHICLE STEERING COLUMNS, STEERING WHEELS, STEERING LINKAGES, STABILIZER BARS, SUSPENSIONS IN THE NATURE OF SUSPENSION STRUTS, LEAF SPRINGS, COIL SPRINGS, TORSION/SWAY BARS AND AIR SPRINGS FOR VEHICLE SUSPENSION COMPONENTS FOR CUSHIONING DRIVER'S SEATS AND CABS, SUSPENSION LOWERING SPRINGS, TORSION BARS, TOW BARS, WINDOWS, WINDOW WINDING MECHANISMS, POWER WINDOWS, WINDSCREENS, WINDSHIELDS INCLUDING SAFETY GLASS, WIPERS FOR WINDSCREENS, WINDSHIELDS AND HEADLIGHTS, WIPER BLADES, VEHICLE WINDOW BLINDS, DRIVING MIRRORS, MIRRORS GAS TANK CAPS, COVER CAPS FOR EXTRA HEADLIGHTS, LUGGAGE RACKS FOR VEHICLES, LUGGAGE NETS, LUGGAGE CARRIERS, WHEEL CARRIERS, BICYCLE CARRIERS, SURFBOARD CARRIERS, BOAT CARRIERS, MUD-GUARDS, SNOW CHAINS, PET SCREENS, STONE SCREENS FOR LAMPS, STORAGE SCREENS, ROOF RACKS AND SKI RACKS, STOWAGE BOXES, DEPOSIT BOXES, STOWAGE COMPARTMENTS, TRIM PANELS, SPOILERS, SIDE AND REAR SKIRTS, SAFETY CUSHIONS, AIR BAGS, HOLDERS FOR MIRRORS, SUN SHADES, RESTRAINING SYSTEMS FOR INSTALLATION IN MOTOR VEHICLES, NAMELY BELT TENSIONERS, AIRBAGS AND SENSORS; TIRES, PNEUMATIC TIRES; ADHESIVE RUBBER PATCHES FOR REPAIRING INNER TUBES; BABY CARRIAGES, WHEELED CHAIRS FOR INVALIDS; BICYCLES; RUDDERS, VEHICLE PROPELLERS, TRIMMING VANES IN THE NATURE OF TRIM TABS FOR VEHICLES, STEERAGE UNITS FOR VEHICLES, VEHICLES PARTS, NAMELY, STEERING WHEELS AND FITTINGS FOR BOATS AS WELL AS COMPONENT PARTS OF THESE ITEMS; AUTOMOBILE SPARE WHEEL HOLDERS; WINTER VEHICLE SEAT COVERS; POWER STEERING UNITS FOR VEHICLES, SPARE WHEEL COVERS; GAS TANK CAPS FOR MOTOR VEHICLES; BALL JOINTS FOR LAND, AIR OR WATER VEHICLES; RUBBER SUPPORTS FOR MOTORS/ENGINES FOR LAND, AIR OR WATER VEHICLES, ENGINES FOR LAND, AIR OR WATER VEHICLES, DIESEL ENGINES FOR MACHINES AND MACHINES, NAMELY EXCAVATORS, LOADERS, DUMPER BODIES, WOOD WORKING MACHINES, AGRICULTURAL AND FORESTRY MACHINES, PACKING AND LABELING MACHINES, EARTH MOVING MACHINES, NAMELY WHEELED EXCAVATORS, COMPACT WHEEL LOADERS, CRAWLER EXCAVATORS, COMPACT EXCAVATORS, WHEEL LOADERS, EARTH MOVING MACHINES, NAMELY MOTOR GRADERS, BACKHOE LOADERS AND DRIVE UNITS; GROMMETS MADE OF RUBBER OR OF PLASTICS MATERIAL FOR USE WITH VEHICLES (U.S. CLS. 19, 21, 23, 31, 35 AND 44).

CLASS 14—JEWELRY

FOR JEWELRY AND PRECIOUS STONES; SMOKERS' ARTICLES IN THE NATURE OF CIGARETTE LIGHTERS OF PRECIOUS METAL, CIGARETTE CASES MADE OF PRECIOUS METAL AND ASHTRAYS OF PRECIOUS METAL, CUFF-LINKS, TIE CLIPS, COLLECTIBLE COINS, MEDALS, LAPEL PINS, RINGS, OTHER DECORATIVE GOODS IN THE NATURE OF BADGES OF PRECIOUS METAL; BONNET PINS OF PRECIOUS METAL; HOROLOGICAL AND CHRONOMETRIC INSTRUMENTS, NAMELY, CLOCKS AND WATCHES AND TRAVEL ALARM CLOCKS; METAL KEY RING PENDANTS AND PINS; MODEL VEHICLES OF PRECIOUS METAL (U.S. CLS. 2, 27, 28 AND 50).

CLASS 16—PAPER GOODS AND PRINTED MATTER

FOR PAPER, CARDBOARD; GOODS MADE FROM THESE MATERIALS, NAMELY, PAPER CUBES PADS AND NOTE PAPER; PRINTED MATTER, NAMELY, BOOKS IN THE FIELDS OF VEHICLES, ENGINES/MOTORS AND MACHINES, MOTOR SPORTS, SAILING, GOLF, INSTRUCTION BOOKS IN THE FIELDS OF VEHICLES, ENGINES/MOTORS AND MACHINES, COMPUTER/COMPUTER SOFTWARE MANUALS, PERIODICALS IN THE NATURE OF MONTHLY MAGAZINES AND NEWSLETTERS IN THE FIELD OF VEHICLES, ENGINES/MOTORS AND MACHINES, MAGAZINES IN THE FIELD OF VEHICLES, ENGINES/MOTORS AND MACHINES, NEWSPAPERS, CALENDARS, POSTERS, STICKERS, BANNERS AND PENNANTS OF PAPER, COUNTRY AND ROAD MAPS, SPARE PARTS LISTS IN THE FIELD OF VEHICLES, ENGINES/MOTORS AND MACHINES, MAINTENANCE MANUALS FOR VEHICLES, ENGINES/MOTORS AND MACHINES; BOOK-BINDING MATERIAL IN THE NATURE OF BOOKBINDING; ADHESIVES FOR STATIONERY OR HOUSEHOLD PURPOSES; ARTISTS' MATERIALS, NAMELY, PAINT BRUSHES; PHOTOGRAPHS; STATIONERY, PENS AND PENCILS; TYPEWRITERS; OFFICE REQUISITES, NAMELY, PEN STANDS, DISPENSERS FOR ADHESIVE TAPE, LETTER HOLDERS, CARDBOARD STORAGE BOXES FOR RECORDING MEDIA AND PAPER KNIVES; PRINTED INSTRUCTIONAL AND TEACHING MATERIAL IN THE FIELD OF VEHICLES, ENGINES/MOTORS AND MACHINES; PLASTIC MATERIALS FOR PACKAGING IN THE NATURE OF PLASTIC PACKAGING BAGS, PLASTIC CARRIER BAGS; PRINTERS' TYPE; PRINTING BLOCKS (U.S. CLS. 2, 5, 22, 23, 29, 37, 38 AND 50).

CLASS 17—RUBBER GOODS

FOR RAW RUBBER, GUTTA-PERCHA FOR USE IN THE MANUFACTURE OF VEHICLES, ENGINES/MOTORS AND MACHINES, RUBBER GUM FOR USE IN THE MANUFACTURE VEHICLES, ENGINES/MOTORS AND MACHINES, MICA; EXTRUDED PLASTICS IN THE FORM OF BARS, BLOCKS, PELLETS, RODS, SHEETS AND TUBES FOR USE IN MANUFACTURE; REFLECTIVE TAPE FOR USE IN VEHICLES, ENGINES/MOTORS AND MACHINES, INSULATING FELT RINGS FOR VEHICLES, ENGINES/MOTORS AND MACHINES, SEALING COMPOUND IN THE NATURE OF SILICON, PLASTIC AND RUBBER FOR USE WITH VEHICLES, ENGINES/MOTORS AND MACHINES, NON-METALLIC TUBES OF RUBBER AND PLASTIC FOR USE WITH VEHICLES, ENGINES/MOTORS AND MACHINES; PIPE CONNECTION PARTS FOR RADIATOR SYSTEMS IN THE NATURE OF RINGS OF RUBBER FOR USE AS PIPE CONNECTION SEALS, RADIATOR SEALING COMPOUNDS IN THE NATURE OF SEALING PLUGS MADE PRIMARILY FROM RUBBER, FASTENERS AND CONNECTORS, ALL MADE OF PLASTIC MATERIALS, FOR PIPES AND CABLES; MOUNTINGS MADE OF RUBBER OR OF PLASTICS FOR ENGINES, TRANSMISSION ASSEMBLIES AND FOR EXHAUSTS; FLEXIBLE COVERS MADE OF RUBBER OR OF PLASTIC MATERIALS FOR PROTECTING MECHANICAL COMPONENTS; EXTRUDED PLASTIC IN THE FORM OF SHEETS FOR USE IN THE MANUFACTURE OF ROOF COVERINGS FOR VEHICLES; CLUTCH LININGS; WASHERS MADE OF RUBBER, PLASTICS OR OF VULCANIZED FIBER; NON-METALLIC HOSES FOR USE IN THE MOTOR VEHICLE AND ENGINE/MOTOR AND MACHINE INDUSTRY; STRIPS MADE OF RUBBER OR OF PLASTICS MATERIALS FOR SEALING JOINTS; PACKING AND STOPPING MATERIALS FOR FORMING SEALS, SEALING, LOCKING AND CAULKING COMPOUNDS AND FLUIDS IN THE NATURE OF JOINTINGS OR PACKINGS; RUBBER OR PLASTIC STUFFINGS FOR ENGINES/MOTORS AND MACHINES; INSULATING MATERIALS, NAMELY POLYURETHANE FOAM AND POLYETHYLENE FOAM; FLEXIBLE PIPES NOT OF METAL (U.S. CLS. 1, 5, 12, 13, 35 AND 50).

CLASS 18—LEATHER GOODS

FOR LEATHER, IMITATION LEATHER SOLD IN BULK, GOODS MADE OF THESE MATERIALS IN THE NATURE OF ANIMAL SKINS, HIDES, LUGGAGE, TRUNKS, TRAVEL BAGS, HANDBAGS, SPORTS BAGS, CONFERENCE FOLDERS IN THE NATURE OF BRIEF-CASE-TYPE PORTFOLIOS, UMBRELLAS, POCKET WALLETS, PURSES, BACK-PACKS, DOCUMENT CASES, BRIEFCASES, BUSINESS CARD CASES, COSMETIC CASES SOLD EMPTY, SUITCASES, KEY CASES, WALKING STICKS, PARASOLS, LUGGAGE RUCK-SACKS AND KNAPSACKS; WHIPS, ANIMAL HARNESSSES AND SADDLERY, METAL LUGGAGE TAGS (U.S. CLS. 1, 2, 3, 22 AND 41).

CLASS 20—FURNITURE AND ARTICLES NOT OTHERWISE CLASSIFIED

FOR NON-METAL LOCKS FOR VEHICLES; MIRRORS; AIR CUSHIONS, NOT FOR MEDICAL PURPOSES; INFLATABLE PLASTIC SIGNS; NON-METAL VEHICLE REGISTRATION PLATES; PLASTIC STORAGE CONTAINERS, LETTER BOXES NOT OF METAL; NON-METAL BOXES; SEAT CUSHIONS, PILLOWS; NON-METAL CLAMPS; PLASTIC PENNANTS; ALL AFORESAID GOODS ALSO AS PARTS AND FITTINGS OF VEHICLES; FURNITURE; MIRRORS; PICTURE FRAMES; INDOOR WINDOW BLINDS; METAL INTERNAL VENETIAN BLINDS; ACCESSORY BOXES OF ARTIFICIAL LEATHER; WINDOW SHADES; PAPER WINDOW BLINDS; PLASTIC FASTENERS AND CONNECTORS FOR PIPES AND CABLES FOR VEHICLES, ENGINES/MOTORS AND MACHINES (U.S. CLS. 2, 13, 22, 25, 32 AND 50).

CLASS 21—HOUSEWARES AND GLASS

FOR ARTICLES FOR CLEANING PURPOSES, NAMELY, CLEANING UTENSILS FOR VEHICLES, IN THE NATURE OF SPONGES, CAR WASH POLISHING LEATHER, CLEANING CLOTHS AND HAND OPERATED CLEANING DEVICES IN THE NATURE OF BRUSHES; STEEL WOOL FOR CLEANING; UNWORKED AND SEMI-WORKED GLASS IN THE NATURE OF GLASS AND SAFETY GLASS FOR VEHICLE WINDOWS; HOUSEHOLD OR KITCHEN UTENSILS AND VESSELS/CONTAINERS, NAMELY, MUGS, CUPS, DRINKING BOTTLES SOLD EMPTY, BOTTLE OPENERS AND TRAYS; COMBS AND CLEANING SPONGES; WASHING BRUSHES; BRUSH-MAKING MATERIALS; BEVERAGE GLASSWARE, PORCELAIN WARE IN THE NATURE OF MUGS AND CUPS, PERFUME ATOMIZERS, SOLD EMPTY; CANISTER SETS (U.S. CLS. 2, 13, 23, 29, 30, 33, 40 AND 50).

CLASS 22—CORDAGE AND FIBERS

FOR ROPES, TOWROPE FOR AUTOMOBILES; STRING; NETS IN THE NATURE OF FABRIC AND POLYESTER MESH NETS USED FOR HOUSEHOLD ITEMS; TENTS, AWNINGS, TARPAULINS, SAILS, SACKS AND BAGS FOR THE TRANSPORTATION OR STORAGE OF MATERIALS IN BULK; PADDING AND STUFFING MATERIALS NOT OF RUBBER OR PLASTIC; RAW FIBROUS TEXTILE MATERIALS (U.S. CLS. 1, 2, 7, 19, 22, 42 AND 50).

CLASS 24—FABRICS

FOR BED BLANKETS; PLAIDS IN THE NATURE OF VEHICLE AND PICNIC BLANKETS; WINTER COVERS FOR SEAT CUSHIONS, TOWELS, CLOTH PENNANTS, CLOTH FLAGS; BED SPREADS; TABLE CLOTHS NOT OF PAPER; WINDOW CURTAINS (U.S. CLS. 42 AND 50).

CLASS 25—CLOTHING

FOR CLOTHING, NAMELY, BELTS, JACKETS, COATS, PULLOVERS, SHAWL, SHIRTS, WAISTCOATS, SOCKS, SCARVES, TIES, SWEATERS, T-SHIRTS, OVERALLS, COVERALLS, RAINWEAR IN THE NATURE OF RAINCOATS, RAIN BOOTS, RAIN TROUSERS AND RAIN CAPES; TROUSERS, SLEEPWEAR IN THE NATURE OF PAJAMAS; HEADGEAR, NAMELY, CAPS AND HATS; FOOTWEAR (U.S. CLS. 22 AND 39).

CLASS 26—FANCY GOODS

FOR LACE AND EMBROIDERY; RIBBONS; AND BRAID; BUTTONS FOR CLOTHING; HOOKS AND EYES; MARKING PINS; NEEDLES; SEWING KIT COMPRISING NEEDLES, THIMBLES AND THREAD ARTIFICIAL FLOWERS (U.S. CLS. 37, 39, 40, 42 AND 50).

CLASS 27—FLOOR COVERINGS

FOR CARPETS, RUGS, MATS AND MATTING, LINOLEUM FOR COVERING EXISTING FLOORS, IN PARTICULAR FOR VEHICLES; DOOR MATS; NON-TEXTILE WALL HANGINGS; PLAIDS IN THE NATURE OF VEHICLE AND PICNIC RUGS (U.S. CLS. 19, 20, 37, 42 AND 50).

CLASS 28—TOYS AND SPORTING GOODS

FOR GAMES, PLAYTHINGS AND TOYS, NAMELY, TOY MODEL HOBBY-CRAFT KITS, SCALE MODEL VEHICLES, PLUSH ANIMALS, GAMES EQUIPMENT FOR BOARD GAMES, BALLOONS, AND BEACH BALLS; DECORATION FOR CHRISTMAS TREES; GYMNAS TIC AND SPORTING ARTICLES, NAMELY, GOLF CLUBS, BASEBALL GLOVES, GOLF BAGS, GOLF BALLS, SPORTS RACQUETS, AND FISHING TACKLE; PLAYING CARDS (U.S. CLS. 22, 23, 38 AND 50).

CLASS 33—WINES AND SPIRITS

FOR ALCOHOLIC BEVERAGES IN THE NATURE OF WINES, DISTILLED SPIRITS AND LIQUEURS (U.S. CLS. 47 AND 49).

CLASS 34—SMOKERS' ARTICLES

FOR TOBACCO; SMOKERS' ARTICLES NOT OF PRECIOUS METAL, NAMELY, SMOKERS' LIGHTERS, TOBACCO POUCHES, CIGAR CUTTERS, TOBACCO PIPE CLEANERS, CIGAR AND CIGARETTE CASES, ASH TRAYS, CIGARETTE BOXES; MATCHES (U.S. CLS. 2, 8, 9 AND 17).

CLASS 35—ADVERTISING AND BUSINESS

FOR RETAIL AND WHOLESALE SERVICES IN THE NATURE OF STORE SERVICES AND DEALERSHIPS FEATURING VEHICLES, ENGINES/MOTORS AND MACHINES INCLUDING DRIVE UNITS AND CONSTRUCTION MACHINES, AS WELL AS OF PARTS, FITTINGS AND ACCESSORIES FOR THE AFORESAID GOODS, AND OF TOOLS AND WORKSHOP EQUIPMENT, AND OF MERCHANDISE PRODUCTS IN THE NATURE OF CLOTHING, HEADGEAR AND FOOTWEAR, SCALE MODEL VEHICLES, BAGS, UMBRELLAS, GOLF BALLS AND TOYS; ADVERTISING AND ORGANIZATION OF PROMOTIONAL PROGRAMS FOR OTHERS, PROVIDING OFFICE FUNCTIONS, BUSINESS ADMINISTRATION AND INCLUDING BOOKKEEPING; BUSINESS MANAGEMENT AND BUSINESS MANAGEMENT ADVISORY SERVICES RELATING TO THE DESIGN, DEVELOPMENT, MANUFACTURE, SALE, DISTRIBUTION, REPAIR OR MAINTENANCE OF VEHICLES, ENGINES/MOTORS AND MACHINES INCLUDING DRIVE UNITS AND CONSTRUCTION MACHINES, AND OF PARTS, FITTINGS AND ACCESSORIES FOR THE AFORESAID; COLLECTION, PREPARATION, COMPOSITION, STORAGE, PROCESSING, ACQUISITION AND PROVISION

OF BUSINESS STATISTICS RELATING TO THE DESIGN, DEVELOPMENT, MANUFACTURE, SALE, DISTRIBUTION, REPAIR OF MAINTENANCE OF VEHICLES, ENGINES/MOTORS AND MACHINES INCLUDING DRIVE UNITS AND CONSTRUCTION MACHINES, AND OF PARTS, FITTINGS AND ACCESSORIES FOR THE AFORESAID; LOGISTICS MANAGEMENT IN THE FIELD OF TRANSPORTATION; LOGISTIC SERVICES, NAMELY, ARRANGING THE TRANSPORTATION OF GOODS FOR OTHERS; DATA PROCESSING; OPERATION OF DATA PROCESSING CENTERS (U.S. CLS. 100, 101 AND 102).

CLASS 36—INSURANCE AND FINANCIAL

FOR REAL ESTATE AFFAIRS IN THE NATURE OF REAL ESTATE INVESTMENT; MONETARY AND FINANCIAL AFFAIRS, NAMELY, CREDIT CARD SERVICES; INSURANCE SERVICES IN THE NATURE OF INSURANCE UNDERWRITING RELATING TO VEHICLES, ENGINES/MOTORS AND MACHINES AND TO PARTS, FITTINGS AND ACCESSORIES FOR THE AFORESAID; WARRANTY UNDERWRITING IN THE FIELD OF VEHICLES, ENGINES/MOTORS AND MACHINES AND OF PARTS, FITTINGS AND ACCESSORIES FOR THE AFORESAID, UNDERWRITING; FINANCING SERVICES IN THE NATURE OF FINANCING RELATING TO VEHICLES, ENGINES/MOTORS AND MACHINES AND OF PARTS, FITTINGS AND ACCESSORIES FOR THE AFORESAID; LEASE PURCHASE FINANCING SERVICES; BROKERAGE FOR HIRE PURCHASE (U.S. CLS. 100, 101 AND 102).

CLASS 37—CONSTRUCTION AND REPAIR

FOR BUILDING CONSTRUCTION; INSTALLATION SERVICES IN THE AREA OF VEHICLES, ENGINES/MOTORS AND MACHINES AND TO PARTS, FITTINGS AND ACCESSORIES FOR THE AFORESAID, INSTALLATION OF ELECTRICAL SYSTEMS, APPLIANCES, WINDOWS AND THEFT PREVENTION DEVICES IN VEHICLES; SERVICE, REPAIR, INSPECTION, RESTORATION, MAINTENANCE, RECONDITIONING, DIAGNOSTIC TUNING IN THE NATURE OF ENGINE TUNING, CLEANING, PAINTING, POLISHING AND PRESERVATION IN RELATION TO VEHICLES, ENGINES/MOTORS AND MACHINES INCLUDING DRIVE UNITS AND CONSTRUCTION, AGRICULTURAL AND FORESTRY MACHINES, POWER HAND TOOLS, WORKSHOP APPLIANCES AND DEVICES, OR PARTS, FITTINGS AND ACCESSORIES INCLUDING TELECOMMUNICATION EQUIPMENT FOR THE AFORESAID; EMERGENCY ROAD SIDE ASSISTANCE; MAINTENANCE AND REPAIR OF MOTOR VEHICLES IN MOTOR-SPORT EVENTS; RENTAL AND LEASING OF MACHINERY FOR BUILDING AND CONSTRUCTION; RENTAL AND LEASING FOR MACHINERY FOR AUTOMOTIVE REPAIR AND CONSTRUCTION; RENTAL AND LEASING OF TOOLS AND WORKSHOP EQUIPMENT FOR VEHICLES, ENGINES/MOTORS AND MACHINES; PROVIDING ONLINE TECHNICAL INFORMATION REGARDING VEHICLE REPAIR; TECHNICAL SERVICE FOR MOTOR VEHICLES DURING MOTOR-SPORTS EVENTS IN THE NATURE OF REPAIR (U.S. CLS. 100, 103 AND 106).

CLASS 38—COMMUNICATION

FOR INTERNET, TELECOMMUNICATION AND SATELLITE COMMUNICATION SERVICES, NAMELY, MOBILE VEHICLE RADIO TELEPHONE SERVICES, PAGING SERVICES, TELEMATIC SERVICES IN THE NATURE OF TRANSMISSION OF INFORMATION VIA COMPUTERS CONNECTED TO THE SAME TELEMATIC NETWORK OR VIA THE INTERNET; UNIDIRECTIONAL OR BI-DIRECTIONAL TRANSMISSION VIA SATELLITE OR THE INTERNET OF TEXT, VOICE AND ALARM MESSAGES AND OF SIGNAL, MEASURING, SOUND, IMAGE, VIDEO, POSITION, MOVEMENT, STATE AND WORKING HOUR DATA BETWEEN LAND VEHICLES, AIR VEHICLES, WATERCRAFT AND LOCOMOTION SYSTEMS, THE LOAD THEREOF AS WELL AS BETWEEN ENGINES/MOTORS AND MACHINES INCLUDING DRIVE UNITS AND CONSTRUCTION MACHINES AND A WIDE VARIETY OF SERVICE POINTS IN THE INTERNET, FOR EMERGENCY SERVICES, BREAKDOWN SERVICES AND TRAFFIC IN-

FORMATION AS WELL AS FOR THE REMOTE CHECKING AND REMOTE CONTROL/ REMOTE AUTOMATIC CONTROL OF LAND VEHICLES, AIR VEHICLES, WATERCRAFT AND LOCOMOTION SYSTEMS, THE LOAD THEREOF AS WELL AS OF ENGINES/MOTORS AND MACHINES INCLUDING DRIVE UNITS AND CONSTRUCTION MACHINES; COMMUNICATIONS SERVICES, NAMELY, TRANSMITTING STREAMED SOUND AND AUDIO-VISUAL RECORDINGS VIA THE INTERNET; COMMUNICATIONS BY COMPUTER TERMINALS; COMPUTER AIDED TRANSMISSION OF MESSAGES AND IMAGES; TELEVISION BROADCASTING OF A TELE-SHOPPING CHANNEL; PROVIDING ON-LINE CHAT ROOMS FOR TRANSMISSION OF MESSAGES AMONG COMPUTER USERS CONCERNING VEHICLES, ENGINES/MOTORS AND MACHINES; TELECOMMUNICATIONS CONSULTATION IN THE FIELD OF MOBILE TELEMATICS APPLICATIONS; TELEMATIC SENDING OF INFORMATION VIA A SERVICE AND ALARM CENTER FOR TRANSPORT AND TRAFFIC FOR CHECKING POSITIONING AND REMOTE CONTROL/AUTOMATIC CONTROL OF LAND VEHICLES, AIR VEHICLES, WATERCRAFT AND LOCOMOTION SYSTEMS, AND THE LOAD THEREOF, AS WELL AS OF ENGINES/MOTORS AND MACHINES INCLUDING DRIVE UNITS AND TRANSPORT MACHINES (U.S. CLS. 100, 101 AND 104).

CLASS 39—TRANSPORTATION AND STORAGE

FOR TRANSPORT BY AIR, FERRY, BOAT, RAIL, CAR, BUS OR TRUCK OF PERSONS AND FREIGHT; SALVAGING OF CARS, BUSES, TRUCKS AND ENGINES/MOTORS AND MACHINES; PROVIDING EMERGENCY TRANSPORTATION OF PASSENGERS AND/OR GOODS BY AIR, BOAT, RAIL, BUS, CAR OR TRUCK; EMERGENCY WAREHOUSING SERVICES; RESCUE SERVICES; PACKAGING ARTICLES FOR TRANSPORTATION; WAREHOUSING SERVICES, NAMELY STORAGE, DISTRIBUTION, PICK-UP, AND PACKAGING FOR SHIPMENT OF DOCUMENTS, PACKAGES, RAW MATERIALS, AND OTHER FREIGHT FOR OTHERS; RENTAL OF VEHICLES, AND VEHICLE PARTS AND ENGINES/MOTORS AND DRIVE UNITS; CONSULTATION IN THE FIELD OF TRAFFIC AND TRANSPORT; VEHICLE FLEET MANAGEMENT AND CONTROL, NAMELY, VEHICLE ROUTING BY COMPUTER ON DATA NETWORKS; TRAFFIC INFORMATION SERVICES; ROUTE GUIDANCE SERVICES IN THE NATURE OF PROVIDING ROAD AND TRAFFIC INFORMATION; TRAVEL ORGANIZATION AND TOURIST TRAVEL INFORMATION SERVICES; RENTAL AND LEASING OF VEHICLES AND VEHICLE PARTS; PROVIDING ROAD AND TRAFFIC INFORMATION (U.S. CLS. 100 AND 105).

CLASS 40—MATERIAL TREATMENT

FOR TREATMENT OF MATERIALS, NAMELY, ENGRAVING, SURFACE TREATMENT IN THE NATURE OF ANTI-CORROSIVE TREATMENT, LACQUERING, LACQUER SEALING AND IMPREGNATION AND FINISHING IN THE NATURE OF WAX POLISHING OF METALS, PLASTICS, TEXTILES, GLASS, WOOD, LEATHER, RUBBER AND OF CERAMICS FOR USE FOR VEHICLES, ENGINES/MOTORS AND MACHINES INCLUDING DRIVE UNITS AND CONSTRUCTION MACHINES, AND FOR PARTS, FITTINGS AND ACCESSORIES THEREOF; RECYCLING, INCINERATION AND DESTRUCTION OF VEHICLES, ENGINES/MOTORS AND MACHINES INCLUDING DRIVE UNITS AND CONSTRUCTION MACHINES, AND OF PARTS AND ACCESSORIES THEREOF; SORTING OF WASTE AND RECYCLABLE MATERIAL FROM VEHICLES, ENGINES/MOTORS AND MACHINES INCLUDING DRIVE UNITS AND CONSTRUCTION MACHINES, AND OF PARTS AND ACCESSORIES THEREOF; TECHNICAL CONSULTATION IN THE FIELD OF RECYCLING (U.S. CLS. 100, 103 AND 106).

CLASS 41—EDUCATION AND ENTERTAINMENT

FOR EDUCATION AND TRAINING SERVICES, NAMELY, CONDUCTING SEMINARS, CLASSES, LESSONS AND COURSES IN THE FIELD OF VEHICLES, ENGINES/MOTORS AND MACHINES; ORGANIZATION OF EDUCATIONAL EXHIBITIONS IN THE FIELD OF VEHICLES, ENGINES/MOTORS AND MACHINES; ENTERTAINMENT, NAMELY, ORGANIZATION OF CONCERTS AND LIVE PERFORMANCES; ORGANIZATION OF SPORT COMPETITIONS AND SPORT EVENTS, ARRANGEMENT OF PRIZE COMPETITIONS IN THE FIELD OF AUTOMOBILE, TRUCK AND YACHT RACING, BICYCLING, GOLF AND SAILING; SPORTING AND CULTURAL ACTIVITIES AND EVENTS SERVICES IN THE NATURE OF ORGANIZING, AND CONDUCTING SPORTS, RECREATIONAL AND ENTERTAINMENT COMPETITIONS IN THE FIELD OF AUTOMOBILE, TRUCK AND YACHT RACES, SAILING, BICYCLING AND GOLF AND FUNCTIONS IN THE NATURE OF LIVE MUSICAL CONCERTS, OPERA AND THEATER; PROVISION OF SPORTS FACILITIES AND SPORTS CAMPS; MUSEUM SERVICES; RENTAL OF SPORTS EQUIPMENT EXCEPT VEHICLES; PROVIDING ONLINE SPORTS AND ENTERTAINMENT INFORMATION (U.S. CLS. 100, 101 AND 107).

CLASS 42—SCIENTIFIC, COMPUTER AND LEGAL SERVICES

FOR SCIENTIFIC RESEARCH; DEVELOPMENT OF NEW TECHNOLOGY FOR OTHERS IN THE FIELD OF ENGINEERING AND TECHNOLOGY RELATING TO AIR, LAND AND WATER VEHICLES, ENGINES/MOTORS AND MACHINES AND TRANSPORTATION AND LOGISTICS; DESIGN FOR OTHERS IN THE FIELD OF ENGINEERING, AIR, LAND AND WATER VEHICLES, ENGINES/MOTORS AND MACHINES; TECHNICAL CONSULTATION IN THE FIELD OF ENGINEERING, AIR, LAND AND WATER VEHICLES, ENGINES/MOTORS AND MACHINES AND TRANSPORTATION AND LOGISTICS; PREPARATION OF TECHNICAL EXPERT OPINIONS IN THE FIELD OF ENGINEERING, AIR, LAND AND WATER VEHICLES, ENGINES/MOTORS AND MACHINES AND TRANSPORTATION AND LOGISTICS; ENGINEERING SERVICES; RESEARCH DEVELOPMENT AND TESTING OF NEW PRODUCTS FOR OTHERS; COMPUTER PROGRAMMING FOR OTHERS, INSTALLATION AND MAINTENANCE OF COMPUTER PROGRAMS IN THE FIELD OF TECHNICAL ENGINEERING, LOGISTICS AND TRAFFIC AND TRANSPORT TELEMATIC; INFORMATION TECHNOLOGY SERVICES IN THE NATURE OF DESIGN AND DEVELOPMENT OF INFORMATION AND DATA BASES; DESIGN AND DEVELOPMENT OF COMPUTER HARDWARE AND SOFTWARE; TECHNICAL CONSULTATION IN THE FIELD OF ENVIRONMENTAL PROTECTION; SCIENTIFIC RESEARCH RELATING TO THE OCEAN; METEOROLOGICAL FORECASTING; INDUSTRIAL DESIGN; LEGAL SERVICES, AUTOMOTIVE INSPECTIONS, AUTOMOTIVE DIAGNOSTIC SERVICES FEATURING COMPUTER SOFTWARE FOR USE BY INDEPENDENT AUTOMOTIVE REPAIR PERSONNEL (U.S. CLS. 100 AND 101).

CLASS 43—HOTEL AND RESTAURANT SERVICES

FOR HOTEL SERVICES; RESTAURANTS; CATERING; TEMPORARY ACCOMMODATIONS; SERVING FOOD AND DRINKS (U.S. CLS. 100 AND 101).

CLASS 44—MEDICAL, BEAUTY AND AGRICULTURAL SERVICES

FOR RENTAL AND LEASING OF AGRICULTURAL AND FORESTRY EQUIPMENT; MEDICAL SERVICES; HEALTH CARE; BEAUTY SALONS (U.S. CLS. 100 AND 101).

CLASS 45—PERSONAL SERVICES

FOR SECURITY GUARD SERVICES; MONITORING BURGLAR AND SECURITY ALARMS FOR AMBULANCE, POLICE, FIRE AND RESCUE BRIGADE; THEFT NOTIFICATION IN THE NATURE OF MONITORING TELEPHONE CALLS FROM SUBSCRIBERS AND NOTIFYING EMERGENCY FACILITIES; STOLEN VEHICLE TRACKING; ALARM MONITORING CENTERS FOR TRANSPORT AND TRAFFIC FOR THE DETECTION, CHECKING, EVALUATION AND PROCESSING OF ALARM MESSAGES, AND SIGNAL, MEASURING, SOUND, IMAGE, VIDEO, POSITION, MOVEMENT, STATE AND WORKING HOUR DATA AND REMOTE CONTROL/AUTOMATIC CONTROL OF LAND VEHICLES, AIR VEHICLES AND AIRCRAFT, LOCOMOTION SYSTEMS, THE LOAD THEREOF, AS WELL AS OF ENGINES/MOTORS AND MACHINES INCLUDING DRIVE UNITS AND CONSTRUCTION MACHINES (U.S. CLS. 100 AND 101).

ANN E. SAPPENFIELD, EXAMINING ATTORNEY

SN 78-533,362. SIMPLICITY HEALTHCARE SYSTEMS, LLC, FRISCO, TX. FILED 12-15-2004.

SimpliciTy Healthcare Systems

THE MARK CONSISTS OF STANDARD CHARACTERS WITHOUT CLAIM TO ANY PARTICULAR FONT, STYLE, SIZE, OR COLOR.

NO CLAIM IS MADE TO THE EXCLUSIVE RIGHT TO USE HEALTHCARE SYSTEMS, APART FROM THE MARK AS SHOWN.

CLASS 35—ADVERTISING AND BUSINESS

FOR BUSINESS PROCESS RE-ENGINEERING SERVICES FEATURING THE DEVELOPMENT OF SYSTEMATIC PROCESSES FOR THE ANALYSIS, DESIGN, SELECTION, IMPLEMENTATION, INTEGRATION AND SUPPORT OF HEALTHCARE INFORMATION SYSTEMS INCLUDING NECESSARY SOFTWARE, HARDWARE, NETWORKS (U.S. CLS. 100, 101 AND 102).

CLASS 42—SCIENTIFIC, COMPUTER AND LEGAL SERVICES

FOR APPLICATION SERVICE PROVIDER (ASP), NAMELY, HOSTING COMPUTER SOFTWARE APPLICATIONS OF OTHERS; COMPUTER SERVICE, NAMELY, ACTING AS AN APPLICATION SERVICE PROVIDER IN THE FIELD OF KNOWLEDGE MANAGEMENT TO HOST COMPUTER APPLICATION SOFTWARE FOR THE COLLECTION, EDITING, ORGANIZING, MODIFYING, BOOK MARKING, TRANSMISSION, STORAGE AND SHARING OF DATA AND INFORMATION IN THE MEDICAL FIELD (U.S. CLS. 100 AND 101).

JOHN DALIER, EXAMINING ATTORNEY

SN 78-534.437. CLEGG INDUSTRIES, INC., TORRANCE, CA. FILED 12-17-2004.



CLASS 9—ELECTRICAL AND SCIENTIFIC APPARATUS

FOR ELECTRONIC NOVELTY ITEMS, NAMELY, MAGNETS AND DECORATIVE MAGNETS, CONTAINING A CHIP THAT EMITS LIGHT AND/OR SOUND WHEN ACTIVATED; MOUSE PADS CONTAINING A CHIP THAT EMITS LIGHT AND/OR SOUND WHEN ACTIVATED; ELECTRIC AND LUMINOUS DOOR SIGNS CONTAINING A CHIP THAT EMITS LIGHT AND/OR SOUND WHEN ACTIVATED (U.S. CLS. 21, 23, 26, 36 AND 38).

CLASS 40—MATERIAL TREATMENT

FOR CUSTOM MANUFACTURE OF ELECTRONIC NOVELTY ITEMS, NAMELY MAGNETS AND DECORATIVE MAGNETS, CONTAINING A CHIP THAT EMITS LIGHT AND/OR SOUND WHEN ACTIVATED; MOUSE PADS CONTAINING A CHIP THAT EMITS LIGHT AND/OR SOUND WHEN ACTIVATED; ELECTRIC AND LUMINOUS DOOR SIGNS CONTAINING A CHIP THAT EMITS LIGHT AND/OR SOUND WHEN ACTIVATED; FIGURINES, KEY CHAINS, PENS, CARDS, BUTTONS, ALL CONTAINING A CHIP THAT EMITS LIGHT AND/OR SOUND WHEN ACTIVATED (U.S. CLS. 100, 103 AND 106).

SUNG IN, EXAMINING ATTORNEY

CLASS 24—FABRICS

FOR FABRICS, NAMELY, COTTON FABRICS AND COTTON BASE MIXED FABRICS; HOUSEHOLD LINEN MADE WITH COTTON; COMFORTERS MADE OF COTTON; CURTAINS MADE OF COTTON; UNFITTED COTTON COVERS FOR SOFAS; MATTRESS COVERS MADE OF COTTON; COTTON COVERS FOR CUSHIONS (U.S. CLS. 42 AND 50).

CLASS 25—CLOTHING

FOR CLOTHING CONTAINING COTTON, NAMELY, FLUFFY ROBES, SHIRTS, T-SHIRTS, SOCKS, STOCKINGS, UNDERPANTS, LINGERIE, SWEATPANTS, AND SWEATSHIRTS (U.S. CLS. 22 AND 39).

CLASS 35—ADVERTISING AND BUSINESS

FOR IMPORT AND EXPORT AGENCY SERVICES (U.S. CLS. 100, 101 AND 102).
WOODROW HARTZOG, EXAMINING ATTORNEY

SN 78-536.724. COMPANHIA DE TECIDOS NORTE DE MINAS - COTEMINAS, MONTES CLAROS, BRAZIL, FILED 12-22-2004.



NO CLAIM IS MADE TO THE EXCLUSIVE RIGHT TO USE "PURE BRAZIL COTTON", APART FROM THE MARK AS SHOWN.

THE MARK CONSISTS OF THE WORDS PURE BRAZIL COTTON WITH A DISTINCTIVE, STYLIZED "COTTON" DESIGN.

CLASS 23—YARNS AND THREADS

FOR COTTON THREADS FOR TEXTILE USE (U.S. CL. 43).

CLASS 24—FABRICS

FOR FABRICS, NAMELY, COTTON FABRICS AND COTTON BASE MIXED FABRICS; HOUSEHOLD LINEN MADE WITH COTTON; COMFORTERS MADE OF COTTON; CURTAINS MADE OF COTTON; UNFITTED COTTON COVERS FOR SOFAS; MATTRESS COVERS MADE OF COTTON; COTTON COVERS FOR CUSHIONS (U.S. CLS. 42 AND 50).

CLASS 25—CLOTHING

FOR CLOTHING CONTAINING COTTON, NAMELY, FLUFFY ROBES, SHIRTS, T-SHIRTS, SOCKS, STOCKINGS, UNDERPANTS, LINGERIE, SWEATPANTS, AND SWEATSHIRTS (U.S. CLS. 22 AND 39).

CLASS 35—ADVERTISING AND BUSINESS

FOR IMPORT AND EXPORT AGENCY SERVICES (U.S. CLS. 100, 101 AND 102).
WOODROW HARTZOG, EXAMINING ATTORNEY

SN 78-536.723. COMPANHIA DE TECIDOS NORTE DE MINAS - COTEMINAS, MONTES CLAROS, BRAZIL, FILED 12-21-2004.



NO CLAIM IS MADE TO THE EXCLUSIVE RIGHT TO USE "PURE BRAZIL COTTON", APART FROM THE MARK AS SHOWN.

THE MARK CONSISTS OF THE WORDS PURE BRAZIL COTTON WITH A DISTINCTIVE, STYLIZED "COTTON" DESIGN.

CLASS 23—YARNS AND THREADS

FOR COTTON THREADS FOR TEXTILE USE (U.S. CL. 43).

SN 78-537,243. MEGA MEDIA HOLDINGS, INC., COCONUT GROVE, FL. FILED 12-22-2004.



NO CLAIM IS MADE TO THE EXCLUSIVE RIGHT TO USE "TV", APART FROM THE MARK AS SHOWN.

CLASS 35—ADVERTISING AND BUSINESS

FOR PRODUCTION OF TELEVISION COMMERCIALS AND PROVIDING TELEVISION ADVERTISING FOR OTHERS (U.S. CLS. 100, 101 AND 102).

CLASS 38—COMMUNICATION

FOR SPANISH LANGUAGE TELEVISION BROADCASTING, SPANISH LANGUAGE CABLE TELEVISION TRANSMISSION, AND SPANISH LANGUAGE SATELLITE TELEVISION TRANSMISSION (U.S. CLS. 100, 101 AND 104).

CLASS 41—EDUCATION AND ENTERTAINMENT

FOR SPANISH LANGUAGE ENTERTAINMENT SERVICES, NAMELY PRODUCTION OF SPANISH LANGUAGE TELEVISION PROGRAMS; SPANISH LANGUAGE TELEVISION PROGRAMMING AND SPANISH LANGUAGE TELEVISION PROGRAM SYNDICATION; TELEVISION SCHEDULING SERVICES (U.S. CLS. 100, 101 AND 107).

JASON LOTT, EXAMINING ATTORNEY

SN 78-538,655. TELEROB GESELLSCHAFT FUER FERNHANTIERUNGSTECHNIK MBH, KIEL, FED REP GERMANY, FILED 12-27-2004.

PRIORITY CLAIMED UNDER SEC. 44(D) ON FED REP GERMANY APPLICATION NO. 30436583, FILED 6-28-2004, REG. NO. 30436583, DATED 9-3-2004, EXPIRES 6-30-2014.

THE COLORS GRAY AND BLACK ARE FEATURES OF THE MARK.

THE COLOR GRAY OCCURS IN THE LETTERS EOD AND THE COLOR BLACK IN THE OTHER LETTERS.

CLASS 7—MACHINERY

FOR INDUSTRIAL ROBOTS, INCLUDING ROBOTS FOR EXPLOSIVE ORDINANCE DETECTION AND DISPOSAL (U.S. CLS. 13, 19, 21, 23, 31, 34 AND 35).

CLASS 9—ELECTRICAL AND SCIENTIFIC APPARATUS

FOR DETECTORS FOR THE DETECTION AND REMOVAL OF EXPLOSIVES, MINES AND AMMUNITION; ROBOTIC CONTROLLERS AND PROGRAMMABLE CALCULATORS FOR EXPLOSIVE ORDINANCE DETECTION AND DISPOSAL; METAL DETECTORS; NON-MEDICAL X-RAY DEVICES FOR EXPLOSIVE ORDINANCE DETECTION (U.S. CLS. 21, 23, 26, 36 AND 38).

CLASS 12—VEHICLES

FOR REMOTE-CONTROLLED VEHICLES FOR EXPLOSIVE ORDINANCE DETECTION AND DISPOSAL (U.S. CLS. 19, 21, 23, 31, 35 AND 44).

CLASS 42—SCIENTIFIC, COMPUTER AND LEGAL SERVICES

FOR DEVELOPMENT AND TECHNICAL PROJECT PLANNING OF SECURITY-TECHNOLOGICAL DEVICES AND SYSTEMS FOR OTHERS, TECHNICAL CONSULTING FOR THE APPLICATION OF SECURITY-TECHNOLOGICAL DEVICES AND SYSTEMS (U.S. CLS. 100 AND 101).

MELVIN AXILBUND, EXAMINING ATTORNEY

SN 78-539,199. WELCH, WILFORD H., SAUSALITO, CA. FILED 12-28-2004.

QUEST FOR GLOBAL HEALING

THE MARK CONSISTS OF STANDARD CHARACTERS WITHOUT CLAIM TO ANY PARTICULAR FONT, STYLE, SIZE, OR COLOR.

CLASS 35—ADVERTISING AND BUSINESS

FOR PROVIDING A WEBSITE FEATURING INFORMATION AND RESOURCES IN THE FIELD OF PROMOTING GLOBAL PEACE (U.S. CLS. 100, 101 AND 102). FIRST USE 4-0-2004; IN COMMERCE 4-0-2004.

CLASS 41—EDUCATION AND ENTERTAINMENT

FOR CONFERENCES AND SEMINARS IN THE FIELD OF PROMOTING GLOBAL PEACE (U.S. CLS. 100, 101 AND 107).

FIRST USE 4-0-2004; IN COMMERCE 4-0-2004.

ALICE SUE CARRUTHERS, EXAMINING ATTORNEY

SN 78-542,498. OCÉ-TECHNOLOGIES B.V., NL-5900 MA VENIO, NETHERLANDS, FILED 1-5-2005.

OCÉ QUICK CHANGE COLOR SYSTEM

THE MARK CONSISTS OF STANDARD CHARACTERS WITHOUT CLAIM TO ANY PARTICULAR FONT, STYLE, SIZE, OR COLOR.

PRIORITY CLAIMED UNDER SEC. 44(D) ON FED REP GERMANY APPLICATION NO. 30438815.7, FILED 7-7-2004, REG. NO. 30438815, DATED 9-7-2004, EXPIRES 7-31-2014.

NO CLAIM IS MADE TO THE EXCLUSIVE RIGHT TO USE "QUICK CHANGE COLOR SYSTEM", APART FROM THE MARK AS SHOWN.

CLASS 7—MACHINERY

FOR PRINTING AND COPYING DEVICES AND RELATED ACCESSORIES, NAMELY, PRINTING PRESSES AND PLATES, WINDING AND UNWINDING MACHINE, CUTTERS, INSERTERS AND FINISHING MACHINE; DEVICES FOR PROCESSING AND FINISHING PRINTED MATERIAL AND DOCUMENTS, NAMELY, WINDERS AND UNWINDERS FOR HOLDING, CUTTERS, AND INSERTERS, AND COMPUTER OPERATING SOFTWARE THEREFOR, SOLD AS A UNIT (U.S. CLS. 13, 19, 21, 23, 31, 34 AND 35).

CLASS 9—ELECTRICAL AND SCIENTIFIC APPARATUS

FOR DATA PROCESSING APPARATUS, NAMELY, COMPUTERS AND PRINTERS, COMPUTER OPERATING SOFTWARE THEREFOR; PRINTERS, SCANNERS AND PHOTOCOPIERS; ELECTRICAL AND OPTICAL APPARATUS, NAMELY, COMPUTERS, PRINTERS, SCANNERS, CAMERAS AND PHOTOCOPIERS (U.S. CLS. 21, 23, 26, 36 AND 38).

JOHN LINCOSKI, EXAMINING ATTORNEY

CLASS 16—PAPER GOODS AND PRINTED MATTER

FOR DISPOSABLE AND REUSABLE WIPES NOT IMPREGNATED WITH CHEMICALS OR COMPOUNDS (U.S. CLS. 2, 5, 22, 23, 29, 37, 38 AND 50).

CLASS 17—RUBBER GOODS

FOR MASKING AND ADHESIVE CLEAN ROOM TAPE FOR IDENTIFICATION, BUNDLING AND PACKAGING PRODUCTS, MATERIALS AND SURFACES (U.S. CLS. 1, 5, 12, 13, 35 AND 50).

CLASS 21—HOUSEWARES AND GLASS

FOR CLEANING HARDWARE, NAMELY, MOPS, MOP HEADS, MOP COVERS, MOP HANDLES AND ADAPTOR HEADS FOR MOPS AND OTHER CLEANING HARDWARE; DISPOSABLE AND REUSABLE CLEANING MATERIALS, NAMELY, SPONGES, AND SWABS; FABRIC CLEAN ROOM WIPES; WRINGERS FOR MOPS AND OTHER CLEANING HARDWARE (U.S. CLS. 2, 13, 23, 29, 30, 33, 40 AND 50).

GISELLE AGOSTO, EXAMINING ATTORNEY

SN 78-542,728. MICRONOVA MANUFACTURING INC., TORRANCE, CA. FILED 1-5-2005.

M-ZONE

SN 78-544,389. BIGELOW MERCHANDISING, LLC, COLUMBUS, OH. FILED 1-8-2005.

THE MARK CONSISTS OF STANDARD CHARACTERS WITHOUT CLAIM TO ANY PARTICULAR FONT, STYLE, SIZE, OR COLOR.

CLASS 3—COSMETICS AND CLEANING PREPARATIONS

FOR CLEANING MATERIALS AND PREPARATIONS, NAMELY CLEANING FLUIDS, DETERGENTS, SOAPS, SOLVENTS, CLEANERS AND DISPOSABLE AND REUSABLE WIPES IMPREGNATED WITH CHEMICALS OR COMPOUNDS TO SANITIZE, STERILIZE, DISINFECT, DEGREASE AND DECONTAMINATE EQUIPMENT AND SURFACES, NAMELY WALLS, FLOORS, CEILINGS, COUNTERS, FURNITURE, COVERINGS, GLASS AND GLASSWARE AND EQUIPMENT; CLEAN ROOM CLEANING FLUIDS, CLEAN ROOM DETERGENTS, CLEAN ROOM SOAPS, CLEAN ROOM SOLVENTS AND CLEANERS, AND SKIN CLEANSERS FOR USE BY CLEAN ROOM PERSONNEL; LOW-IONIC DETERGENTS, LOW-IONIC SOAPS, LOW-IONIC SOLVENTS, AND LOW-IONIC CLEANER SOLUTIONS FOR WALLS, FLOORS, CEILINGS, COUNTERS, FURNITURE, COVERINGS, GLASS AND GLASSWARE AND EQUIPMENT (U.S. CLS. 1, 4, 6, 50, 51 AND 52).

CLASS 5—PHARMACEUTICALS

FOR SANITIZING WIPES (U.S. CLS. 6, 18, 44, 46, 51 AND 52).

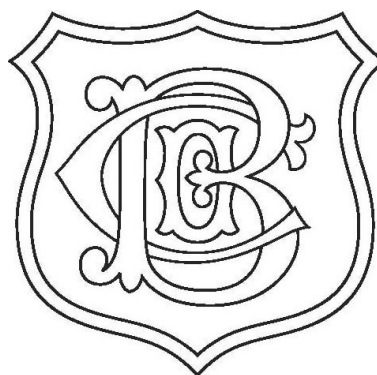

OWNER OF U.S. REG. NOS. 2,365,803, 2,915,656 AND OTHERS.

THE MARK CONSISTS OF THE LETTERS C AND O AND B INSIDE A SHIELD.

CLASS 3—COSMETICS AND CLEANING PREPARATIONS

FOR PERSONAL CARE PRODUCTS, NAMELY AFTER SHAVE, AFTER SHAVE BALM, AFTER SHAVE LOTION, ALUM BLOCK FOR USE AFTER SHAVING, ANTIPERSPIRANT, ASTRINGENT FOR THE FACE, COSMETIC ASTRINGENT FOR THE FACE AND SKIN, BATH ADDITIVE, BATH GEL, BATH OIL, NON-MEDICATED BATH SOAKS, BLUSH, FACIAL AND SKIN CLEANSERS, BODY CREAM, BODY LOTION, SKIN MOISTURIZER, BODY AND BEAUTY CARE PREPARATIONS, NAMELY NON-MEDICATED BODY OINTMENTS AND SALVE, BODY SCRUB, BODY WASH, CLEANSING CREAM, COLD CREAM, COLOGNE, COSMETICS, DENTIFRICE, DEODORANTS FOR PERSONAL USE, DEPICTORIES, DUSTING POWDER, ESSENTIAL OILS FOR PERSONAL USE, EYE CREAM, EYE GEL, EYELINER, EYE SHADOW, FACE CLEANSER, FACE CREAM, FACE GEL, FACE LOTION, FACE MASK, FACE MIST, FACE MOISTURIZER, FACE POWDER, FACE SCRUB, NON-MEDICATED FACE SERUM, FACE TONER, FACE WASH, FOOT CREAM, NON-MEDICATED FOOT POWDER, FOOT SALVE, FRAGRANCES FOR PERSONAL USE, HAIR BLEACHES, HAIR CONDITIONER, HAIR DETANGLER, HAIR POMADE, HAIR SHAMPOO, HAIR STYLING PREPARATIONS, HAIR WAXES, HAND CLEANSER, HAND CREAM, HAND LOTION, LIP BALM, LIP BUFFER, LIP EXFOLIATOR, NON-MEDICATED LIP CARE PREPARATIONS, LIP SHINE, LIP STICK, LIQUID CLEANSERS FOR THE FACE AND SKIN, MAKE UP REMOVER, MASCARA, MASSAGE CREAM, MASSAGE OIL, NON-MEDICATED MOUTHWASH, NAIL CREAM, NAIL POLISH, NAIL SALVE, NON-MEDICATED NOSE BALM, PERFUME, POST SUN TANNING CREAM, POST SUN TANNING LOTION, PUMICE STONE FOR PERSONAL USE, SCENTED ROOM SPRAY, NON-MEDICATED BODY SALVE, NAMELY ROSE SALVE, TOILET WATER, NAMELY ROSE WATER, SHAVING BALM, SHAVING CREAM, SHAVING GEL, SHAVE LATHER, SHOWER GEL, SKIN CREAM, SKIN LOTION, SKIN TONIC, SOAP, NON-MEDICATED SUN CARE PREPARATIONS, TALCUM POWDER, MEDICATED SOAP (U.S. CLS. 1, 4, 6, 50, 51 AND 52).

CLASS 5—PHARMACEUTICALS

FOR ACNE TREATMENT PREPARATIONS, ALOE-VERA GEL, ANTI-ITCH LOTION, ANTI-ITCH CREAM, ANTI-ITCH OINTMENT, ANTISEPTIC GEL, ASPIRIN, MEDICATED PADS TO TREAT SKIN BLEMISHES, MEDICATED BLEMISH TREATMENTS FOR SKIN AND BODY, MEDICATED BODY LOTION, MEDICATED CHEST BALM, MEDICATED COLD SORE TREATMENT PREPARATIONS, COUGH AND COLD TREATMENT PREPARATIONS, DANDRUFF SHAMPOO, MEDICINAL ELIXIRS AND INGESTIBLES FOR THE TREATMENT OF COUGH, COLD, FLU AND INDIGESTION, MEDICATED FOOT POWDER, INSECT REPELLANT, LINIMENT OIL SPRAY, LINIMENTS, MEDICATED LIP SALVE, MEDICATED THROAT AND COUGH LOZENGES, MENTHOLATED BODY LOTION, MEDICATED MOUTHWASH, NUTRITIONAL SUPPLEMENTS, NUTRITIONALLY FORTIFIED BEVERAGES, STYPTIC PENCIL, VITAMINS (U.S. CLS. 6, 18, 44, 46, 51 AND 52).

CLASS 35—ADVERTISING AND BUSINESS

FOR RETAIL STORE SERVICES, MAIL ORDER SERVICES, AND ONLINE RETAIL STORE SERVICES ALL FEATURING COSMETICS, TOILETRIES, SPA, SKIN AND BEAUTY CARE PRODUCTS AND PHARMACEUTICALS (U.S. CLS. 100, 101 AND 102).
DEZMONA MIZELLE, EXAMINING ATTORNEY

SN 78-545,775. EAST COAST LIGHTING & PRODUCTION SERVICES, INC., WARWICK, RI. FILED 1-11-2005.

**EAST COAST
LIGHTING &
PRODUCTION
SERVICES, INC.**

THE MARK CONSISTS OF STANDARD CHARACTERS WITHOUT CLAIM TO ANY PARTICULAR FONT, STYLE, SIZE, OR COLOR.

NO CLAIM IS MADE TO THE EXCLUSIVE RIGHT TO USE "LIGHTING & PRODUCTION SERVICES, INC.", APART FROM THE MARK AS SHOWN.
SEC. 2(F).

CLASS 35—ADVERTISING AND BUSINESS

FOR RETAIL STORE SERVICES AND WHOLESALE DISTRIBUTORSHIPS FEATURING A WIDE RANGE OF PROFESSIONAL EVENT PRODUCTION EQUIPMENT, NAMELY, AUDIO, VIDEO, RECORDING, LIGHTING, STAGING, AND OTHER EVENT PRODUCTION EQUIPMENT (U.S. CLS. 100, 101 AND 102).

FIRST USE 1-0-1999; IN COMMERCE 1-0-1999.

CLASS 37—CONSTRUCTION AND REPAIR

FOR INSTALLATION AND REPAIR OF AUDIO VISUAL EQUIPMENT, VIDEO EQUIPMENT, RECORDING EQUIPMENT, STAGING, AND THEATRICAL LIGHTING EQUIPMENT (U.S. CLS. 100, 103 AND 106).

FIRST USE 1-0-1999; IN COMMERCE 1-0-1999.

CLASS 41—EDUCATION AND ENTERTAINMENT

FOR ENTERTAINMENT, NAMELY, LIGHTING PRODUCTION SERVICES; AUDIOVISUAL PRODUCTION SERVICES IN THE NATURE OF OPERATION OF VIDEO EQUIPMENT AND AUDIO EQUIPMENT FOR PRODUCTION OF LIVE STAGED EVENTS; AUDIO RECORDING PRODUCTION SERVICES; ENTERTAINMENT, NAMELY, STAGING PRODUCTION SERVICES FOR ALL TYPES OF EVENTS, INCLUDING CONCERTS, CORPORATE EVENTS AND OTHER SPECIAL EVENTS; RENTAL OF THEATRICAL LIGHTING EQUIPMENT (U.S. CLS. 100, 101 AND 107).

FIRST USE 1-0-1999; IN COMMERCE 1-0-1999.
JOHN GARTNER, EXAMINING ATTORNEY

SN 78-546,162. HEAVY WATER INTERNATIONAL A/S, OSLO, NORWAY, FILED 1-12-2005.



CLASS 3—COSMETICS AND CLEANING PREPARATIONS

FOR COSMETICS, NAMELY, PERFUME, EAU DE TOILETTE, COLOGNE AND AFTER-SHAVE LOTION (U.S. CLS. 1, 4, 6, 50, 51 AND 52).

CLASS 25—CLOTHING

FOR CLOTHING, NAMELY, MEN'S, WOMEN'S AND CHILDREN'S T-SHIRTS, SWEATSHIRTS, BUTTON DOWN SHIRTS, POLO SHIRTS, BLOUSES, PANTS, SHORTS, SKIRTS, PYJAMAS, NIGHT SHIRTS, COATS, JACKETS, HATS, SOCKS AND FOOTWEAR; MEN'S AND WOMEN'S SPORTSWEAR, NAMELY, ATHLETIC JACKETS, SHIRTS, PANTS, SHORTS, TOPS AND FLEECE, WATERPROOF JACKETS AND PANTS, CAPS, VISORS, SWIMSUITS AND SWIM BRIEFS (U.S. CLS. 22 AND 39).

CLASS 32—LIGHT BEVERAGES

FOR BEER (U.S. CLS. 45, 46 AND 48).

CLASS 33—WINES AND SPIRITS

FOR ALCOHOLIC BEVERAGES, NAMELY, TEQUILA, COGNAC, LIQUEURS, FLAVORED SPIRITS, FLAVORED VODKAS AND BEVERAGE BITTERS (U.S. CLS. 47 AND 49).
THEODORE MCBRIDE, EXAMINING ATTORNEY

SN 78-547,580. SIX STAR US TRADEMARK LTD., MISSISSAUGA, ONTARIO, CANADA, FILED 1-14-2005.

ADRENALIZE

THE MARK CONSISTS OF STANDARD CHARACTERS WITHOUT CLAIM TO ANY PARTICULAR FONT, STYLE, SIZE, OR COLOR.

CLASS 5—PHARMACEUTICALS

FOR FOOD SUPPLEMENTS FOR BODY BUILDING; FOOD AND SPORT NUTRITIONAL SUPPLEMENTS FOR STRENGTH AND PERFORMANCE ENHANCEMENT; POWDERED NUTRITIONAL SUPPLEMENT DRINK MIX; MEAL REPLACEMENT SHAKES; DIETARY INGREDIENT BLEND CONTAINING CAFFEINE IN NUTRITIONAL SUPPLEMENTS (U.S. CLS. 6, 18, 44, 46, 51 AND 52).

CLASS 29—MEATS AND PROCESSED FOODS

FOR PROTEIN BASED, NUTRIENT-DENSE SNACK BARS (U.S. CL. 46).
STEVEN JACKSON, EXAMINING ATTORNEY

SN 78-550,128. PENNWELL CORPORATION, TULSA, OK. FILED 1-19-2005.



OWNER OF U.S. REG. NOS. 508,769, 2,197,086 AND 2,795,202.

NO CLAIM IS MADE TO THE EXCLUSIVE RIGHT TO USE "JOURNAL" FOR INTERNATIONAL CLASS 16, APART FROM THE MARK AS SHOWN.
SEC. 2(F) AS TO "OIL&GAS JOURNAL".

CLASS 9—ELECTRICAL AND SCIENTIFIC APPARATUS

FOR CD-ROMS CONTAINING INFORMATION RELATING TO THE OIL, PETROLEUM, NATURAL GAS AND ENERGY FIELDS (U.S. CLS. 21, 23, 26, 36 AND 38).

CLASS 16—PAPER GOODS AND PRINTED MATTER

FOR PRINTED PUBLICATIONS, NAMELY, REPORTS RELATING TO THE OIL, PETROLEUM, NATURAL GAS AND ENERGY FIELDS (U.S. CLS. 2, 5, 22, 23, 29, 37, 38 AND 50).
ANNE FARRELL, EXAMINING ATTORNEY

SN 78-551,972. TERREMARK TRADEMARK HOLDINGS, INC., MIAMI, FL. FILED 1-21-2005.

NXSIP

THE MARK CONSISTS OF STANDARD CHARACTERS WITHOUT CLAIM TO ANY PARTICULAR FONT, STYLE, SIZE, OR COLOR.

OWNER OF U.S. REG. NO. 2,619,960.

CLASS 35—ADVERTISING AND BUSINESS

FOR BUSINESS MANAGEMENT SERVICES; BUSINESS INFORMATION MANAGEMENT SERVICES (U.S. CLS. 100, 101 AND 102).

CLASS 38—COMMUNICATION

FOR NETWORK ACCESS POINT SERVICES, NAMELY, PROVIDING ACCESS TO TELECOMMUNICATIONS NETWORKS; DATA CENTER SERVICES, NAMELY, ELECTRONIC TRANSMISSION OF DATA; TELECOMMUNICATION SERVICES, NAMELY, ELECTRONIC STORE AND FORWARD MESSAGING AND WIRELESS DIGITAL MESSAGING SERVICES; ELECTRONIC MAIL, TELEPHONE VOICE MESSAGING, FACSIMILE TRANSMISSION SERVICES, LONG-DISTANCE TELEPHONE COMMUNICATION SERVICES, AND PROVIDING MULTIPLE-USER ACCESS TO A GLOBAL COMPUTER NETWORK; PROVIDING TELECOMMUNICATIONS CONNECTIONS TO A GLOBAL COMPUTER NETWORK FOR TELECOM HOTELING (U.S. CLS. 100, 101 AND 104).

CLASS 39—TRANSPORTATION AND STORAGE

FOR ELECTRONIC STORAGE AND ARCHIVING OF DATA FOR OTHERS; AND STORAGE OF COMPUTER AND TELECOMMUNICATIONS EQUIPMENT FOR OTHERS (U.S. CLS. 100 AND 105).

CLASS 42—SCIENTIFIC, COMPUTER AND LEGAL SERVICES

FOR COMPUTER CONSULTATION SERVICES, NAMELY, PROVIDING CO-LOCATION SERVICES FOR OTHERS FOR VOICE, VIDEO AND DATA COMMUNICATIONS APPLICATIONS OF INTERNAL, EXTRANET, AND GLOBAL COMPUTER NETWORK SERVERS; TECHNICAL SUPPORT, NAMELY, MONITORING INTERNAL, EXTRANET AND GLOBAL COMPUTER NETWORKS FOR OTHERS; DESIGNING, DEVELOPING, IMPLEMENTING AND MONITORING COMPUTER SYSTEMS FOR OTHERS; VALUE-ADDED AND/OR MANAGED SERVICES, NAMELY, HOSTING THE WEB SITES OF OTHERS ON A GLOBAL COMPUTER NETWORK; COMPUTER MONITORING SERVICES, NAMELY, PERFORMANCE REPORTING, LOAD BALANCING, AND COMPUTER NETWORK SECURITY SERVICES (U.S. CLS. 100 AND 101).

NICHOLAS ALTREE, EXAMINING ATTORNEY

CLASS 16—PAPER GOODS AND PRINTED MATTER

FOR PAPER, CARDBOARD AND ARTICLES MADE FROM THESE MATERIALS, NAMELY GIFT WRAP, GIFT BAGS, TISSUE PAPER TO BE USED AS GIFT WRAPPING CARDS AND PACKAGING DECORATIONS; PAPER NAPKINS; PAPER PARTY BAGS; PAPER PARTY FAVORS; PAPER PARTY DECORATIONS; PAPER TREAT BAGS; PAPER PLACE MATS; PAPER BIBS; STATIONERY; PADS; PRINTED MATTER, NAMELY, STORY BOOKS, PICTURE BOOKS AND CHILDREN'S SOUND BOOKS; GREETING CARDS; POSTCARDS; DIARIES; BATH BOOKS; COLORING BOOKS; POSTERS; PAPER ROOM DECOR; PAPER DOOR COVERS; BOOK MARKS; STICKERS; BLANK WRITING JOURNALS; PHOTO ALBUMS; DECALS; PAPER, IRON-ON, OR PLASTIC TRANSFERS; APPLIQUES IN THE FORM OF DECALS; WRITING INSTRUMENTS, PENS, PENCILS; COLORING PENCILS, CRAYONS; PENCIL BOXES; PENCIL CASES; ERASERS; COMICS; MODELING MATERIALS; MODELING COMPOUNDS; ADHESIVE BANDS, TAPES AND GLUES FOR STATIONERY, HOUSEHOLD OR ART PURPOSES; SELF-ADHESIVE TAPES IN ASSORTED SIZES, SHAPES AND COLORS FOR STATIONARY OR HOUSEHOLD USE (U.S. CLS. 2, 5, 22, 23, 29, 37, 38 AND 50).

SN 78-552,732. HESS, MILO L., NYC, NY. FILED 1-24-2005.

Santa Claus World Tour

THE MARK CONSISTS OF STANDARD CHARACTERS WITHOUT CLAIM TO ANY PARTICULAR FONT, STYLE, SIZE, OR COLOR.

NO CLAIM IS MADE TO THE EXCLUSIVE RIGHT TO USE "SANTA CLAUS", APART FROM THE MARK AS SHOWN.

CLASS 25—CLOTHING

FOR ARTICLES OF CLOTHING, HEADWEAR AND FOOTWEAR NAMELY TOPS, EMBELLISHED TOPS, SCREEN PRINTED TOPS; SHIRTS; T-SHIRTS; SWEATSHIRTS; OVERALLS; COVERALLS; JOG SETS; VESTS; SWEATERS; HOODED SWEATSHIRTS; FLEECEWEAR, NAMELY FLEECE JACKETS AND FLEECE PANTS; OUTERWEAR NAMELY, JACKETS, COATS; ANORAKS; RAINCOATS, RAIN SLICKERS, PONCHOS; SNOWSUITS; SKI SETS; WINDSUITS; TROUSERS; PANTS; DRESSES; SKIRTS; ROMPERS; JUMPERS; GLOVES, MITTENS, SCARVES; UNDERWEAR; SOCKS; SLIPPER SOCKS, TIGHTS; HATS; CAPS; VISORS; HEADBANDS; SKI HEADBANDS; RAIN HATS; BANDANNAS; SHOES, ATHLETIC SHOES, HIKING BOOTS, SNOW SHOES, CANVAS SHOES, CASUAL SHOES, BOOT, WINTER BOOTS, RAIN BOOTS, WORK BOOTS, WELLIES, FLIP FLOPS, WATERPROOF SHOES, SLIPPERS; SLEEPWEAR, ONE OR TWO PIECE SLEEPWEAR, PAJAMAS, NIGHTIES, DRESSING GOWNS; ROBES; BLANKET SLEEPERS; APRONS (U.S. CLS. 22 AND 39).

ROBIN CHOSID, EXAMINING ATTORNEY

SN 78-553,634. DANSK VARMBLOD, SKEJBY, 8200 ARHUS N, DENMARK, FILED 1-25-2005.

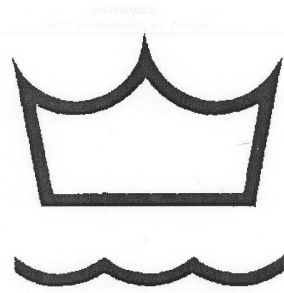

CLASS 35—ADVERTISING AND BUSINESS

FOR ASSOCIATION SERVICES, NAMELY, PROMOTING THE INTERESTS OF HORSE BREEDERS AND HORSE BREEDING; MAINTAINING A REGISTRY OF A PARTICULAR BREED OF HORSES THAT INCLUDES PROVIDING AND MAINTAINING A DATABASE OF HORSES IN THE PARTICULAR BREED AND STUDBOOK, THE RECORDING OF TRANSFERS OF OWNERSHIP OF HORSES AMONG BREEDERS, ESTABLISHING HORSE BREED GOALS AND RULES, COLLECTING, MAINTAINING AND DISTRIBUTING REGISTRY INFORMATION ON HORSES, HORSE PERFORMANCE RECORDS, AND HORSE OWNERS DATA AND ADMINISTRATIVE FUNCTIONS RELATED TO THESE REGISTRY SERVICES (U.S. CLS. 100, 101 AND 102).

CLASS 42—SCIENTIFIC, COMPUTER AND LEGAL SERVICES

FOR EVALUATING AND INSPECTING HORSE BREEDING STOCK (U.S. CLS. 100 AND 101).

CLASS 44—MEDICAL, BEAUTY AND AGRICULTURAL SERVICES

FOR ANIMAL HUSBANDRY SERVICES IN THE NATURE OF BRANDING OF FOALS (U.S. CLS. 100 AND 101).

AMY HELLA, EXAMINING ATTORNEY

SN 78-553,870. SCYLD COMPUTING CORPORATION, SAN FRANCISCO, CA. FILED 1-25-2005.

SCYLD SOFTWARE

THE MARK CONSISTS OF STANDARD CHARACTERS WITHOUT CLAIM TO ANY PARTICULAR FONT, STYLE, SIZE, OR COLOR.

OWNER OF U.S. REG. NOS. 2,535,665, 2,555,217 AND OTHERS.

NO CLAIM IS MADE TO THE EXCLUSIVE RIGHT TO USE SOFTWARE, APART FROM THE MARK AS SHOWN.

CLASS 9—ELECTRICAL AND SCIENTIFIC APPARATUS

FOR COMPUTER OPERATING SYSTEMS, COMPUTER SOFTWARE PLATFORMS FOR USE WITH COMPUTING SERVERS AND CLUSTERS, AND RELATED SOFTWARE UTILITIES AND TOOLS FOR ADMINISTRATION OF COMPUTER SYSTEMS AND COMPUTER COMMUNICATIONS; AND INSTRUCTIONAL MATERIALS PROVIDED THEREWITH (U.S. CLS. 21, 23, 26, 36 AND 38).

FIRST USE 1-1-2004; IN COMMERCE 1-1-2004.

CLASS 42—SCIENTIFIC, COMPUTER AND LEGAL SERVICES

FOR COMPUTER SERVICES, NAMELY, SYSTEMS ADMINISTRATION AND ADMINISTRATION OF COMPUTER CLUSTER COMMUNICATIONS FOR OTHERS (U.S. CLS. 100 AND 101).

FIRST USE 1-1-2004; IN COMMERCE 1-1-2004.

ANDREA SAUNDERS, EXAMINING ATTORNEY

SN 78-553,874. SCYLD COMPUTING CORPORATION, SAN FRANCISCO, CA. FILED 1-25-2005.



OWNER OF U.S. REG. NOS. 2,535,665, 2,555,217 AND OTHERS.

NO CLAIM IS MADE TO THE EXCLUSIVE RIGHT TO USE SOFTWARE, APART FROM THE MARK AS SHOWN.

CLASS 9—ELECTRICAL AND SCIENTIFIC APPARATUS

FOR COMPUTER OPERATING SYSTEMS, COMPUTER SOFTWARE PLATFORMS FOR USE WITH COMPUTING SERVERS AND CLUSTERS, AND RELATED SOFTWARE UTILITIES AND TOOLS FOR ADMINISTRATION OF COMPUTER SYSTEMS AND COMPUTER COMMUNICATIONS; AND INSTRUCTIONAL MATERIALS PROVIDED THEREWITH (U.S. CLS. 21, 23, 26, 36 AND 38).

FIRST USE 1-1-2004; IN COMMERCE 1-1-2004.

CLASS 42—SCIENTIFIC, COMPUTER AND LEGAL SERVICES

FOR COMPUTER SERVICES, NAMELY, SYSTEMS ADMINISTRATION AND ADMINISTRATION OF COMPUTER CLUSTER COMMUNICATIONS FOR OTHERS (U.S. CLS. 100 AND 101).

FIRST USE 1-1-2004; IN COMMERCE 1-1-2004.

ANDREA SAUNDERS, EXAMINING ATTORNEY

SN 78-554,555. BARRETT ENTERPRISES GROUP, CARSON CITY, NV. FILED 1-26-2005.

SN 78-554,929. ATRONIC INTERNATIONAL GMBH, 32312 LÜBBECKE, FED REP GERMANY, FILED 1-27-2005.

THAT 50'S GAME

Bunny Ranch

THE MARK CONSISTS OF STANDARD CHARACTERS WITHOUT CLAIM TO ANY PARTICULAR FONT, STYLE, SIZE, OR COLOR.

CLASS 16—PAPER GOODS AND PRINTED MATTER

FOR SOUVENIR PRINTED MENUS (U.S. CLS. 2, 5, 22, 23, 29, 37, 38 AND 50).
FIRST USE 12-4-1992; IN COMMERCE 12-4-1992.

CLASS 21—HOUSEWARES AND GLASS

FOR BEVERAGE GLASSWARE (U.S. CLS. 2, 13, 23, 29, 30, 33, 40 AND 50).
FIRST USE 12-4-1992; IN COMMERCE 12-4-1992.

CLASS 25—CLOTHING

FOR CLOTHING, NAMELY T-SHIRTS, SHIRTS, PANTS, TOPS, UNDERWEAR (U.S. CLS. 22 AND 39).
FIRST USE 12-4-1992; IN COMMERCE 12-4-1992.

CLASS 35—ADVERTISING AND BUSINESS

FOR ON-LINE RETAIL STORE SERVICES FEATURING A VARIETY OF NOVELTIES (U.S. CLS. 100, 101 AND 102).
FIRST USE 12-4-1992; IN COMMERCE 12-4-1992.

CLASS 45—PERSONAL SERVICES

FOR ESCORT SERVICES (U.S. CLS. 100 AND 101).
FIRST USE 12-4-1992; IN COMMERCE 12-4-1992.
TEJBIR SINGH, EXAMINING ATTORNEY

THE MARK CONSISTS OF STANDARD CHARACTERS WITHOUT CLAIM TO ANY PARTICULAR FONT, STYLE, SIZE, OR COLOR.

PRIORITY CLAIMED UNDER SEC. 44(D) ON FED REP GERMANY APPLICATION NO. 004200093, FILED 1-26-2005, REG. NO. 004200093, DATED 2-27-2006, EXPIRES 2-27-2016.

NO CLAIM IS MADE TO THE EXCLUSIVE RIGHT TO USE "GAME", APART FROM THE MARK AS SHOWN.

CLASS 9—ELECTRICAL AND SCIENTIFIC APPARATUS

FOR ELECTRIC AND ELECTRONIC APPARATUS, INSTRUMENTS, DEVICES AND MACHINES NAMELY, COIN OPERATED GAMING AND GAMBLING MACHINES AND GAMING AND GAMBLING MACHINES OPERABLE WITH MAGNETIC CARDS, MICRO-PROCESSORS AND COMPUTER CHIPS; MECHANISMS FOR COIN OPERATED AND NON-COIN OPERATED MACHINES, NAMELY HOPPERS; COIN CHANGERS; COMPUTER SOFTWARE FOR USE IN DATA BASE MANAGEMENT FOR GENERATING BILLS IN CONNECTION WITH COIN AND NON COIN OPERATED GAMING MACHINES; AUTOMATED DATA STORAGE MACHINES IN THE NATURE OF COMPUTERS, COMPUTER DATA PRINTERS FOR DISPLAYING TOTAL WINNINGS IN FRONT OF GAMING MACHINES; ELECTRONIC PRINTED CIRCUIT BOARDS; COIN COUNTING AND SORTING MACHINES; VENDING MACHINES WHICH PROVIDE TOKENS, COUPONS AND GAME CARDS; ELECTRIC AND ELECTRONIC MACHINES AND APPARATUSES FOR GAMES, AMUSEMENT, ENTERTAINMENT AND GAMING, NAMELY, SLOT MACHINES, GAMING EQUIPMENT, NAMELY GAMING MACHINES; VIDEO SLOT MACHINES; CASINO GAMBLING DEVICES, NAMELY SLOT MACHINE SAND STRUCTURAL PARTS THEREFOR, GAME SYMBOL CYLINDERS FOR SLOT MACHINES; DROP-DOWN CAROUSELS FOR SLOT MACHINES AND GAMING MACHINES; TV MONITORS AND LCD-DISPLAY MONITORS FOR GAMBLING MACHINES; ELECTRONIC CASINO GAME MACHINES; ELECTRIC AND ELECTRONIC GAMING AND GAMBLING MACHINES; GAMING MACHINES FOR BETTING ON EVENTS; COMPUTER GAME CASSETTES AND CARTRIDGES FOR ELECTRONIC POCKET GAMES VIDEO GAME MACHINES FOR USE WITH TELEVISION; PRE-RECORDED DATA CARRIERS FEATURING PROGRAMS FOR ELECTRONIC VIDEO AND AUDIO DISPLAY FOR PLAYING ELECTRONIC GAMES (U.S. CLS. 21, 23, 26, 36 AND 38).

CLASS 28—TOYS AND SPORTING GOODS

FOR ELECTRIC AND ELECTRONIC STAND ALONE VIDEO MACHINES FEATURING GAMES-, AMUSEMENT AND SPORTS-AND ENTERTAINMENT ALL FOR USE INDIVIDUALLY OR AS A NETWORK, COIN-OPERATED STANDALONE COMPACT VIDEO GAME SPORTS MACHINES; HANDHELD UNIT FOR PLAYING ELECTRONIC GAMES NAMELY COMPACT SPORTS MACHINES FOR PLAYING IN SMALL AREAS, NAMELY, DARTS, TABLE SOCCER, POOL-BILLIARD, SNOOKER, SHOOTING GALLERIES, PINBALL GAMES; HAND HELD CONSOLES FOR ELECTRONIC GAMES, ELECTRONIC PARLOR GAMES, VIDEO GAMES AND INSTRUMENTS, NAMELY HAND-HELD UNIT FOR PLAYING VIDEO GAMES, STAND ALONE VIDEO GAME MACHINES; ELECTRIC AND ELECTRONIC STAND ALONE VIDEO MACHINES FEATURING GAMES-, AMUSEMENT AND SPORTS-AND ENTERTAINMENT ALL FOR USE INDIVIDUALLY OR AS A NETWORK, COIN-OPERATED STANDALONE COMPACT VIDEO GAME SPORTS MACHINES; HANDHELD UNIT FOR PLAYING ELECTRONIC GAMES FEATURING, DARTS, TABLE SOCCER, POOL-BILLIARD, SNOOKER, SHOOTING GALLERIES, PINBALL GAMES; HAND HELD OPERATOR PANELS FOR PLAYING ELECTRONIC GAMES; ELECTRONIC PARLOR GAMES, VIDEO GAMES AND INSTRUMENTS, NAMELY HAND-HELD UNIT FOR PLAYING VIDEO GAMES, STAND ALONE VIDEO GAME MACHINES (U.S. CLS. 22, 23, 38 AND 50).

ELI HELLMAN, EXAMINING ATTORNEY

SN 78-555,889, WORLDGATE SERVICE, INC., TREVOSE, PA.
FILED 1-28-2005.



THE COLOR(S) ORANGE AND WHITE IS/ARE CLAIMED AS A FEATURE OF THE MARK.

THE MARK CONSISTS OF THE LITERAL TERM OJO CONFIGURED SO THAT THE LETTERS FORM HUMAN EYES AND A NOSE. THE FIRST "O" HAS THREE LINES, FORMING EYELASHES, PROTRUDING FROM IT. THE "J" REPRESENTS A NOSE AND THE SECOND "O" ANOTHER EYE. THE TERM/DESIGN APPEARS IN WHITE ON AN ORANGE RECTANGLE WITH ROUNDED EDGES.

THE FOREIGN WORDING IN THE MARK TRANSLATES INTO ENGLISH AS EYE.

CLASS 9—ELECTRICAL AND SCIENTIFIC APPARATUS

FOR TELEPHONES AND VIDEOPHONES (U.S. CLS. 21, 23, 26, 36 AND 38).

FIRST USE 6-30-2003; IN COMMERCE 6-30-2003.

CLASS 38—COMMUNICATION

FOR COMMUNICATION SERVICES, NAMELY, ELECTRONIC TRANSMISSION OF DATA AND INFORMATION AMONG USERS OF TELEPHONES AND VIDEOPHONES; VIDEO TELECONFERENCING SERVICES; TELECOMMUNICATIONS SERVICES, NAMELY, PERSONAL COMMUNICATION SERVICES; TELEPHONE COMMUNICATION SERVICES; DATA COMMUNICATION SERVICES, NAMELY, ELECTRONIC DATA TRANSMISSION (U.S. CLS. 100, 101 AND 104).

FIRST USE 6-30-2003; IN COMMERCE 6-30-2003.

MATTHEW MCDOWELL, EXAMINING ATTORNEY

SN 78-555,932, WORLDGATE SERVICE, INC., TREVOSE, PA.
FILED 1-28-2005.

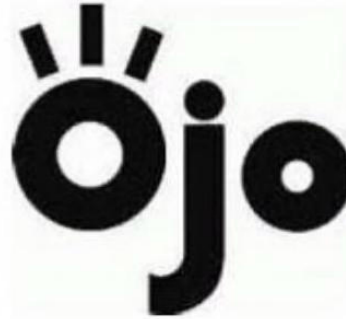

THE MARK CONSISTS OF THE LITERAL TERM "OJO" CONFIGURED SO THAT THE LETTERS FORM HUMAN EYES AND NOSE. THE FIRST "O" HAS THREE LINES, FORMING EYELASHES, PROTRUDING FROM IT. THE "J" REPRESENTS A NOSE AND THE SECOND "O" ANOTHER EYE.

THE FOREIGN WORDING IN THE MARK TRANSLATES INTO ENGLISH AS EYE.

CLASS 9—ELECTRICAL AND SCIENTIFIC APPARATUS

FOR TELEPHONES AND VIDEOPHONES (U.S. CLS. 21, 23, 26, 36 AND 38).

FIRST USE 6-30-2003; IN COMMERCE 6-30-2003.

CLASS 38—COMMUNICATION

FOR COMMUNICATION SERVICES, NAMELY, ELECTRONIC TRANSMISSION OF DATA AND INFORMATION AMONG USERS OF TELEPHONES AND VIDEOPHONES; VIDEO TELECONFERENCING SERVICES; TELECOMMUNICATIONS SERVICES, NAMELY, PERSONAL COMMUNICATION SERVICES; TELEPHONE COMMUNICATION SERVICES; DATA COMMUNICATION SERVICES, NAMELY, ELECTRONIC DATA TRANSMISSION (U.S. CLS. 100, 101 AND 104).

FIRST USE 6-30-2003; IN COMMERCE 6-30-2003.

MATTHEW MCDOWELL, EXAMINING ATTORNEY

SN 78-556,231. DIGITAL LIVING NETWORK ALLIANCE, BEAVERTON, OR. FILED 1-28-2005.



CLASS 9—ELECTRICAL AND SCIENTIFIC APPARATUS

FOR COMPUTER HARDWARE; PERSONAL DIGITAL ASSISTANTS (PDAS); COMPUTERS; LAPTOP COMPUTERS; NOTEBOOK PERSONAL COMPUTERS (PCS); PRINTERS; PHOTOGRAPH PRINTERS; FACSIMILE MACHINES; SCANNERS; PC GAMING MACHINES; CD, DVD, VCR, AND MP3 PLAYERS AND RECORDERS; TELEVISION MONITORS; SATELLITE TELEVISION SYSTEMS COMPRISING ONE OR MORE OF TELEVISIONS, COMPUTERS, CABLES, SATELLITE DISHES, SATELLITE SIGNAL RECEIVERS; SATELLITE RADIOS; STEREO; CAMERAS; DIGITAL CAMERAS; CELLULAR PHONES; MULTIMEDIA MOBILE PHONES; HOME THEATER SYSTEMS COMPRISING ONE OR MORE OF LIQUID CRYSTAL DISPLAYS, TELEVISIONS, COMPUTERS, CABLES, SPEAKERS, AUDIO AND VIDEO CONTROLLERS, AUDIO AMPLIFIERS, AUDIO AND VIDEO PLAYERS AND RECEIVERS, HOME THEATER RECEIVERS AND AMPLIFIERS; VIDEO GAME EQUIPMENT COMPRISING ONE OR MORE OF JOYSTICKS, VIDEO GAME CONTROLLERS, VIDEO GAME MACHINES, VIDEO GAME CONSOLES; DIGITAL VIDEO RECORDERS; AUDIO TAPE RECORDERS; AUDIO-VIDEO RECEIVERS; CABLE TV CONVERTERS; CALCULATORS; GPS VEHICLE NAVIGATION SYSTEMS; HOME SECURITY ALARMS; HOME WEATHER STATIONS COMPRISING ONE OR MORE OF WIRED OR WIRELESS AIR TEMPERATURE, HUMIDITY AND AIR PRESSURE SENSORS, HOME RECEIVERS, WEATHER FREEZE ALARMS, PRECIPITATION SENSORS, LCD ALARM CLOCKS, WEATHER DATA STORAGE UNITS, NAMELY, MEMORY CHIPS, MICROPROCESSORS, AND COMPUTERS SPECIFICALLY DESIGNED FOR STORING WEATHER DATA, AND THERMOMETERS; DIGITAL NETWORKING EQUIPMENT COMPRISING ONE OR MORE OF COMPUTERS, SERVERS, COMPUTER HARDWARE, ROUTERS, NETWORK STORAGE UNITS, NAMELY, MEMORY CHIPS, MICROPROCESSORS, AND COMPUTERS SPECIFICALLY DESIGNED FOR STORING DATA AND INFORMATION FOR RETRIEVAL THROUGH A COMPUTER NETWORK, SIGNAL RECEIVERS, SIGNAL TRANSMITTERS, AND AMPLIFIERS; ELECTRONIC DATABASES, IN THE FIELD OF ENTERTAINMENT, ARTS, BUSINESS, FINANCE, GENERAL NEWS, SPORTS, WEATHER, POLITICS, INTERNATIONAL AFFAIRS, SCIENCE, TECHNOLOGY, ENGINEERING, AGRICULTURE, TRAVEL, EDUCATION, HEALTH, AND PERSONAL INFORMATION, RECORDED ON COMPUTER MEDIA; DIGITAL FILES AND MEDIA COMPRISED OF ONE OR MORE OF VIDEO, AUDIO, STILL IMAGES AND TEXT INFORMATION IN THE FIELD OF ENTERTAINMENT, ARTS, BUSINESS, FINANCE, GENERAL NEWS, SPORTS, WEATHER, POLITICS, INTERNATIONAL AFFAIRS, SCIENCE, TECHNOLOGY, ENGINEERING, AGRICULTURE, TRAVEL, EDUCATION, HEALTH, AND PERSONAL INFORMATION, RECORDED ON COMPUTER MEDIA; COMPUTER SOFTWARE FOR OPERATING, CONTROLLING, TRANSMITTING AND RECEIVING DATA, SIGNALS AND INFORMATION BETWEEN OR AMONG TWO OR MORE OF THE FORE-

GOING ITEMS, AND ALL THE FOREGOING ITEMS FOR USE BY CONSUMERS IN A HOME ENVIRONMENT (U.S. CLS. 21, 23, 26, 36 AND 38).

CLASS 35—ADVERTISING AND BUSINESS

FOR ASSOCIATION SERVICES, NAMELY, PROMOTING THE INTERESTS OF THE CONSUMER ELECTRONICS INDUSTRY AND STANDARDS FOR NETWORKED DIGITAL CONSUMER ELECTRONICS PRODUCTS AND SERVICES (U.S. CLS. 100, 101 AND 102).

CHERYL CLAYTON, EXAMINING ATTORNEY

SN 78-557,102. ATRONIC INTERNATIONAL GMBH, LÜBBECKE, FED REP GERMANY, FILED 1-31-2005.

SIAMESE DREAM

THE MARK CONSISTS OF STANDARD CHARACTERS WITHOUT CLAIM TO ANY PARTICULAR FONT, STYLE, SIZE, OR COLOR.

PRIORITY CLAIMED UNDER SEC. 44(D) ON ERPNTY TM OFC APPLICATION NO. 004200143, FILED 1-26-2005, REG. NO. 004200143, DATED 2-27-2006, EXPIRES 1-26-2015.

CLASS 9—ELECTRICAL AND SCIENTIFIC APPARATUS

FOR VIDEO GAME MACHINES, NAMELY, SLOT MACHINES PROVIDED WITH A TV MONITOR, A TFT MONITOR OR A SIMILAR DISPLAY MONITOR; ELECTRIC AND ELECTRONIC APPARATUS, DEVICES AND INSTRUMENTS AND FOR GAMBLING AND GAMING, NAMELY, AUTOMATED DISPENSING MACHINES DISPENSING AND ACCEPTING COINS, PAPER MONEY, TOKENS, MAGNETIC STRIP CARDS, ELECTRONIC TOKENS, MEMORY CARDS, MICRO-PROCESSOR CARDS, CONTACTLESS CHIP CARDS, OPTICAL MEMORY CARDS, CHITS, EMBOSSED CARDS, AND READ/WRITE TICKETS; COIN OPERATED MACHINES AND MACHINES OPERABLE WITH PAPER MONEY, TOKENS, MAGNETIC CARDS, MICRO-PROCESSOR DEVICES AND CHITS; ELECTRIC AND ELECTRONIC MACHINES AND APPARATUSES FOR GAMBLING, GAMING, ENTERTAINMENT AND SPORTS GAMES, NAMELY, SLOT MACHINES, GAMING AND ENTERTAINMENT MACHINES, BETTING MACHINES, VIDEO SLOT MACHINES, CASINO GAMBLING DEVICES; GAMING AND ENTERTAINMENT MACHINES; BETTING MACHINES; ALL OF THE AFORE-MENTIONED MACHINES AND APPARATUSES ALSO FOR NETWORKED USE; MECHANISMS FOR COIN-OPERATED MACHINES AND COIN CONTROLLED MACHINES, NAMELY, MOUNTING PARTS FOR AND SOLD AS A COMPONENT OF VENDING MACHINES, MONEY CHANGE MACHINES, ENTERTAINMENT, GAMING AND GAMBLING MACHINES, OPERABLE WITH COINS, PAPER MONEY, TOKENS, MAGNETIC STRIP CARDS, ELECTRONIC TOKENS, MEMORY CARDS, MICRO-PROCESSOR CARDS, OPTICAL MEMORY CARDS, CHITS, EMBOSSED CARDS, READ/WRITE TICKETS; CALCULATORS FOR CALCULATING TRANSACTIONS PERFORMED ON MACHINES OPERATED WITH CURRENCY AND CURRENCY SURROGATE CARRIERS; DATA PRINTERS; PRINTED CIRCUIT BOARDS; CHANGE MACHINES, VENDING MACHINES PROVIDING CHITS, COUPONS, AND GAME CARDS; MACHINE-READABLE DATA CARRIERS PROGRAMMED FOR THE AFORE-MENTIONED MACHINES AND APPARATUSES; STORAGE CAS-

SETTES AND STORAGE CARDS FOR ELECTRONIC POCKET GAMES; GAMES, NAMELY, GAMING SOFTWARE FOR CASINO GAMBLING, GAMING, ENTERTAINMENT, AMUSEMENT, AND SPORTS GAMING MACHINES (U.S. CLS. 21, 23, 26, 36 AND 38).

SN 78-567,575. UNIVERSITY OF KENTUCKY, LEXINGTON, KY. FILED 2-15-2005.

CLASS 28—TOYS AND SPORTING GOODS

FOR STAND-ALONE COIN-OPERATED COMPACT SPORTS GAME MACHINES, STAND-ALONE COIN-OPERATED COMPACT SPORTS VIDEO GAME MACHINES FEATURING DARTS, TABLE SOCCER, POOL-BILIARD, SNOOKER, SHOOTING GALLERIES; HAND CONSOLES FOR PLAYING ELECTRONIC GAMES; TOYS, NAMELY, STUFFED TOY ANIMALS, TOY FIGURES, TOY VEHICLES; STAND ALONE VIDEO GAME MACHINES FEATURING AMUSEMENT, ENTERTAINMENT AND SPORTS THEMES (U.S. CLS. 22, 23, 38 AND 50).

RAMONA ORTIGA, EXAMINING ATTORNEY

BIG BLUE MADNESS

SN 78-557,560. TREMCO BARRIER SOLUTIONS, INC., REYNOLDSBURG, OH. FILED 2-1-2005.

HORIZON

THE MARK CONSISTS OF STANDARD CHARACTERS WITHOUT CLAIM TO ANY PARTICULAR FONT, STYLE, SIZE, OR COLOR.

CLASS 2—PAINTS

FOR COATINGS FOR USE IN BUILDING FOUNDATION SEALING AND WATERPROOFING AND SOLD TO COMMERCIAL, GOVERNMENTAL AND RESIDENTIAL CONSUMERS THROUGH BUILDING CONSTRUCTION AND WATERPROOFING CONTRACTORS (U.S. CLS. 6, 11 AND 16).

CLASS 17—RUBBER GOODS

FOR INSULATION PANELS FOR RESIDENTIAL AND COMMERCIAL BUILDINGS; WATERPROOF MEMBRANE FOR INSTALLATION ON THE EXTERIOR OF A RESIDENTIAL AND COMMERCIAL BUILDING FOUNDATION (U.S. CLS. 1, 5, 12, 13, 35 AND 50).
PAMELA HIRSCHMAN, EXAMINING ATTORNEY

THE MARK CONSISTS OF STANDARD CHARACTERS WITHOUT CLAIM TO ANY PARTICULAR FONT, STYLE, SIZE, OR COLOR.

OWNER OF U.S. REG. NOS. 2,035,116, 2,689,947 AND 2,843,173.

CLASS 16—PAPER GOODS AND PRINTED MATTER

FOR PRINTED MATTER RELATED TO ENTERTAINMENT, NAMELY, POSTERS, SOUVENIR PROGRAMS, SOUVENIR MAGAZINES, MEDIA GUIDES AND EXHIBITION SCHEDULES FEATURING MUSICAL BANDS, ATHLETIC TEAMS, CHEERLEADER TEAMS AND INDIVIDUAL SPORTS CELEBRITY PERFORMERS (U.S. CLS. 2, 5, 22, 23, 29, 37, 38 AND 50).

FIRST USE 10-1-1996; IN COMMERCE 10-1-1996.

CLASS 25—CLOTHING

FOR ARTICLES OF OUTER CLOTHING, NAMELY T-SHIRTS, SHIRTS, SWEATSHIRTS, JACKETS, SWEATERS, ATHLETIC UNIFORMS, WARM-UP SUITS, HATS, CAPS, SUNVISORS, WRIST BANDS AND HEAD BANDS (U.S. CLS. 22 AND 39).

FIRST USE 10-1-1996; IN COMMERCE 10-1-1996.

CLASS 41—EDUCATION AND ENTERTAINMENT

FOR ORGANIZING AND ARRANGING SPORTS EXHIBITIONS; ARRANGING AND CONDUCTING ATHLETIC COMPETITIONS; PRESENTATION OF ONGOING LIVE PERFORMANCES BY MUSICAL BANDS, INDIVIDUAL MUSICAL PERFORMERS, SPORT CELEBRITY PERFORMERS AND CHEERLEADER TEAMS; PROVIDING AN ON-LINE COMPUTER DATABASE IN THE FIELD OF GENERAL INTEREST NEWS IN RELATION TO ATHLETICS ENTERTAINMENT AND EDUCATIONAL INFORMATION VIA A GLOBAL COMPUTER NETWORK (U.S. CLS. 100, 101 AND 107).

FIRST USE 10-1-1996; IN COMMERCE 10-1-1996.
LA TONIA FISHER, EXAMINING ATTORNEY

SN 78-569,816. SUPERIOR INTERNATIONAL INDUSTRIES, INC., CARROLLTON, GA. FILED 2-17-2005.

PLAYLAND

THE MARK CONSISTS OF STANDARD CHARACTERS WITHOUT CLAIM TO ANY PARTICULAR FONT, STYLE, SIZE, OR COLOR.
SEC. 2(F).

CLASS 20—FURNITURE AND ARTICLES NOT OTHERWISE CLASSIFIED

FOR BENCHES AND PICNIC TABLES (U.S. CLS. 2, 13, 22, 25, 32 AND 50).
FIRST USE 12-31-1983; IN COMMERCE 12-31-1983.

CLASS 21—HOUSEWARES AND GLASS

FOR TRASH RECEPTACLES (U.S. CLS. 2, 13, 23, 29, 30, 33, 40 AND 50).
FIRST USE 12-31-1983; IN COMMERCE 12-31-1983.

CLASS 28—TOYS AND SPORTING GOODS

FOR PLAYGROUND EQUIPMENT, COMPRISED OF CLIMBING UNITS, SLIDES, OVERHEAD LADDERS, SWINGS, ACTIVITY PANELS, DECKS, STAIRS, RAMPS, BRIDGES, TUNNELS, BARRIERS, ROOFS, TABLES, RIDE-ON TOYS, PAINT STATIONS, BALANCE BEAMS; SPORTING EQUIPMENT, NAMELY SOCCER GOALS, BACKBOARDS FOR BASKETBALL, TETHER BALLS (U.S. CLS. 22, 23, 38 AND 50).
FIRST USE 12-31-1983; IN COMMERCE 12-31-1983.
TASNEEM HUSSAIN, EXAMINING ATTORNEY

SN 78-570,562. HARRY'S NEW YORK BAR, PARIS, FRANCE, FILED 2-18-2005.

STRAW VOTE

THE MARK CONSISTS OF STANDARD CHARACTERS WITHOUT CLAIM TO ANY PARTICULAR FONT, STYLE, SIZE, OR COLOR.
OWNER OF ERPN CMNTY TM OFC REG. NO. 004021853, DATED 1-3-2006, EXPIRES 1-3-2016.

CLASS 41—EDUCATION AND ENTERTAINMENT

FOR ARRANGING AND CONDUCTING OF COLLOQUIUMS, CONFERENCES AND CONGRESSES IN THE FIELD OF POLITICS; ORGANIZATION OF NON-BUSINESS EVENTS NAMELY ENTERTAINMENT IN THE NATURE OF MEETINGS IN THE FIELD OF POLITICS; PRODUCTION OF TELEVISION SHOWS, MOTION PICTURES, AND LIVE SHOWS FEATURING MUSIC, INFORMATION AND DRAMA; ORGANIZATION OF EXHIBITIONS FOR CULTURAL AND EDUCATIONAL PURPOSES, NAMELY ENTERTAINMENT IN THE NATURE OF MEETINGS IN THE FIELD OF POLITICS (U.S. CLS. 100, 101 AND 107).

CLASS 43—HOTEL AND RESTAURANT SERVICES

FOR CAFES, CAFETERIAS, BAR SERVICES, RESTAURANTS; SELF-SERVICE RESTAURANTS, FAST-FOOD SNACK-BARS (U.S. CLS. 100 AND 101).
INGRID C. EULIN, EXAMINING ATTORNEY

SN 78-573,983. REGULATORY & CLINICAL RESEARCH INSTITUTE, INC., MINNEAPOLIS, MN. FILED 2-24-2005.

FROM CONCEPT TO MARKET

THE MARK CONSISTS OF STANDARD CHARACTERS WITHOUT CLAIM TO ANY PARTICULAR FONT, STYLE, SIZE, OR COLOR.

CLASS 35—ADVERTISING AND BUSINESS

FOR IDENTIFICATION OF REGULATORY STRATEGIES FOR PRODUCT MARKET APPLICATIONS AND REIMBURSEMENT; PREPARATION AND SUBMISSION OF PRODUCT APPLICATIONS TO THE FDA AND OTHER REGULATORY AGENCIES; PREPARING BUSINESS REPORTS FOR GOVERNMENTAL AGENCIES AND MEDICAL JOURNALS RESULTING FROM CLINICAL STUDIES; PROVIDING REIMBURSEMENT AND HEALTH ECONOMIC SERVICES, NAMELY, RESEARCHING AND ANALYZING CURRENT REIMBURSEMENT POLICIES, PRODUCT AND PROCEDURE CODES AND PRICING; PROVIDING DUE DILIGENCE SERVICES, NAMELY, EVALUATING REGULATORY STRATEGIES, CLINICAL STRATEGIES, PRODUCT REIMBURSEMENT STRATEGIES AND QUALITY SYSTEMS ON BEHALF OF VENTURE CAPITALISTS (U.S. CLS. 100, 101 AND 102).
FIRST USE 9-30-2003; IN COMMERCE 9-30-2003.

CLASS 42—SCIENTIFIC, COMPUTER AND LEGAL SERVICES

FOR CONTRACT REGULATORY AND CLINICAL SERVICES, NAMELY, STRATEGY DEVELOPMENT IN THE NATURE OF CONSULTING SERVICES REGARDING SCIENTIFIC AND TECHNICAL ASPECTS OF CLINICAL TRIALS AND SUBMISSIONS TO THE FDA AND OTHER REGULATORY AGENCIES; DESIGNING, IMPLEMENTING AND MANAGING CLINICAL TRIALS FOR PRODUCT TESTING AND DEVELOPMENT PURPOSES; DEVELOPING AND MANAGING CLINICAL STUDIES, CLINICAL PROTOCOL, DATA MANAGEMENT AND ANALYSIS FOR CLINICAL TRIALS; PREPARING SCIENTIFIC REPORTS RESULTING FROM CLINICAL STUDIES; DEVELOPING AND MANAGING REGULATORY QUALITY SYSTEMS AND COMPLIANCE MATTERS FOR MEDICAL PRODUCT MANUFACTURERS; DESIGNING AND IMPLEMENTING PRECLINICAL RESEARCH SERVICES, NAMELY, SCIENTIFIC ANIMAL RESEARCH; PREPARING SCIENTIFIC REPORTS AS TO RESULTS OF STUDIES FOR GOVERNMENTAL AGENCIES AND MEDICAL JOURNALS RESULTING FROM CLINICAL STUDIES; DESIGNING ANIMAL MEDICAL EXPERIMENTS; DESIGNING, IMPLEMENTING AND ANALYZING HUMAN CLINICAL STUDIES, NAMELY, PROTOCOL DEVELOPMENT, SITE INITIATION, DATABASE DEVELOPMENT AND MANAGEMENT AND DATA ANALYSIS (U.S. CLS. 100 AND 101).

FIRST USE 9-30-2003; IN COMMERCE 9-30-2003.
LEIGH CAROLINE CASE, EXAMINING ATTORNEY

SN 78-578,663. SARICA FOODS, INC., SCHILLER PARK, IL. FILED 3-2-2005.

SARICA

THE MARK CONSISTS OF STANDARD CHARACTERS WITHOUT CLAIM TO ANY PARTICULAR FONT, STYLE, SIZE, OR COLOR.

OWNER OF U.S. REG. NO. 2,948,230.

CLASS 21—HOUSEWARES AND GLASS

FOR DINNERWARE AND BEVERAGE GLASSWARE (U.S. CLS. 2, 13, 23, 29, 30, 33, 40 AND 50).
FIRST USE 3-0-2004; IN COMMERCE 3-0-2004.

CLASS 29—MEATS AND PROCESSED FOODS

FOR PROCESSED OLIVES; OLIVE OIL; EDIBLE OIL; VEGETABLE OIL; COOKING OIL; PROCESSED GARLIC USED AS A VEGETABLE; PICKLES; AND CANNED VEGETABLES (U.S. CL. 46).

FIRST USE 1-1-1999; IN COMMERCE 1-1-1999.

CLASS 30—STAPLE FOODS

FOR COFFEE (U.S. CL. 46).
FIRST USE 0-0-2002; IN COMMERCE 0-0-2002.
GIANCARLO CASTRO, EXAMINING ATTORNEY

SN 78-578,807. LEVIN, ROSS, EDINA, MN. FILED 3-2-2005.

Quantum Planning

THE MARK CONSISTS OF STANDARD CHARACTERS WITHOUT CLAIM TO ANY PARTICULAR FONT, STYLE, SIZE, OR COLOR.

NO CLAIM IS MADE TO THE EXCLUSIVE RIGHT TO USE "PLANNING", APART FROM THE MARK AS SHOWN.

CLASS 35—ADVERTISING AND BUSINESS

FOR INCOME TAX CONSULTATION AND INCOME TAX PLANNING (U.S. CLS. 100, 101 AND 102).

CLASS 36—INSURANCE AND FINANCIAL

FOR FINANCIAL PLANNING SERVICES; NAMELY, INVESTMENT MANAGEMENT AND INVESTMENT PLANNING, INSURANCE PLANNING, RETIREMENT PLANNING, ESTATE PLANNING AND EMPLOYEE BENEFITS PLANNING (U.S. CLS. 100, 101 AND 102).
PAM WILLIS, EXAMINING ATTORNEY

SN 78-581,344. POLYSTRAND, INC., MONTROSE, CO. FILED 3-7-2005.

THERMOBALLISTIC

THE MARK CONSISTS OF STANDARD CHARACTERS WITHOUT CLAIM TO ANY PARTICULAR FONT, STYLE, SIZE, OR COLOR.

CLASS 12—VEHICLES

FOR VEHICLE AND STRUCTURAL ARMOR SYSTEM, NAMELY FIBER REINFORCED COMPOSITE MATERIAL PANELS FOR USE AS ARMOR, WALL AND DOOR PANELS, FOR USE ON ALL-TERRAIN VEHICLES, TRUCKS, VANS, CARS, MOTORCYCLES, AMPHIBIOUS VEHICLES, AIRCRAFT, BOATS, AND TRAINS. (U.S. CLS. 19, 21, 23, 31, 35 AND 44).

CLASS 17—RUBBER GOODS

FOR NON-METAL FIBER REINFORCED COMPOSITE MATERIAL PANELS FOR USE AS ARMOR ON BUILDINGS. (U.S. CLS. 1, 5, 12, 13, 35 AND 50).
ANNE MADDEN, EXAMINING ATTORNEY

SN 78-582,855. DEPAUW UNIVERSITY, GREENCASTLE, IN.
FILED 3-8-2005.

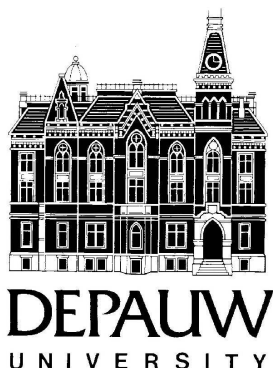

NO CLAIM IS MADE TO THE EXCLUSIVE RIGHT TO USE "UNIVERSITY", APART FROM THE MARK AS SHOWN.

CLASS 16—PAPER GOODS AND PRINTED MATTER

FOR PRINTED MATTER, NAMELY, NEWSPAPERS AND INFORMATIONAL BROCHURES ABOUT UNIVERSITY AND ALUMNI AFFAIRS ISSUES (U.S. CLS. 2, 5, 22, 23, 29, 37, 38 AND 50).
FIRST USE 1-1-1981; IN COMMERCE 1-1-1981.

CLASS 25—CLOTHING

FOR CLOTHING, NAMELY, SHIRTS, SHORTS, SWEATSHIRTS, SWEATPANTS, PANTS, JACKETS, COATS, CAPS AND HATS (U.S. CLS. 22 AND 39).
FIRST USE 1-1-1981; IN COMMERCE 1-1-1981.

CLASS 41—EDUCATION AND ENTERTAINMENT

FOR EDUCATIONAL SERVICES, NAMELY, CONDUCTING PUBLIC LECTURES, COURSES, WORKSHOPS, SEMINARS, SYMPOSIA, AND CONFERENCES AT A UNIVERSITY UNDERGRADUATE LEVEL (U.S. CLS. 100, 101 AND 107).
FIRST USE 1-1-1981; IN COMMERCE 1-1-1981.
ELI HELLMAN, EXAMINING ATTORNEY

SN 78-586,794. CHAMBERLAIN HART ENTERPRISES,
FAIRFIELD, IA. FILED 3-14-2005.

CHAMBERLAIN HART ENTERPRISES

THE MARK CONSISTS OF STANDARD CHARACTERS WITHOUT CLAIM TO ANY PARTICULAR FONT, STYLE, SIZE, OR COLOR.

NO CLAIM IS MADE TO THE EXCLUSIVE RIGHT TO USE "ENTERPRISES", APART FROM THE MARK AS SHOWN.

"CHAMBERLAIN HART" DOES NOT IDENTIFY A LIVING INDIVIDUAL.

CLASS 16—PAPER GOODS AND PRINTED MATTER

FOR PRINTED PUBLICATIONS, NAMELY BOOKLETS AND MANUALS, IN THE FIELD OF STARTING A BUSINESS, CREATING BUSINESS PLANS, BUSINESS OPERATIONS AND BUSINESS GROWTH STRATEGIES (U.S. CLS. 2, 5, 22, 23, 29, 37, 38 AND 50).
FIRST USE 2-9-2004; IN COMMERCE 2-9-2004.

CLASS 41—EDUCATION AND ENTERTAINMENT

FOR TRAINING IN THE FIELD OF STARTING A BUSINESS, CREATING BUSINESS PLANS, BUSINESS OPERATIONS AND BUSINESS GROWTH STRATEGIES (U.S. CLS. 100, 101 AND 107).
FIRST USE 2-9-2004; IN COMMERCE 2-9-2004.

TARAH HARDY, EXAMINING ATTORNEY

SN 78-590,611. DAIMLERCHRYSLER AG, STUTTGART,
FED REP GERMANY, FILED 3-18-2005.



PRIORITY CLAIMED UNDER SEC. 44(D) ON FED REP GERMANY APPLICATION NO. 30456486.9, FILED 9-30-2004, REG. NO. 30456486, DATED 1-28-2005, EXPIRES 9-30-2014.

THE NAME(S), PORTRAIT(S), AND/OR SIGNATURE(S) SHOWN IN THE MARK DOES NOT IDENTIFY A PARTICULAR LIVING INDIVIDUAL.

CLASS 9—ELECTRICAL AND SCIENTIFIC APPARATUS

FOR BLANK MAGNETIC DATA CARRIERS; PRERECORDED MAGNETIC DATA CARRIERS FEATURING INFORMATION ON AUTOMOBILES, THE AUTOMOTIVE INDUSTRY, CREDIT CARD SERVICES AND TRANSPORTATION AND TRAVEL; ENCODED CHIP CARDS FOR USE IN CONNECTION WITH CREDIT CARDS, DEBIT CARDS AND OTHER PAYMENT CARDS (U.S. CLS. 21, 23, 26, 36 AND 38).

CLASS 36—INSURANCE AND FINANCIAL

FOR FINANCIAL SERVICES, NAMELY, BANKING AND BILL PAYMENT SERVICES, CREDIT CARD SERVICES, DEBIT CARD SERVICES, ELECTRONIC CASH TRANSACTIONS, ELECTRONIC PAYMENT PROCESSING SERVICES, PROVIDING FINANCIAL INFORMATION, NAMELY, CREDIT AND DEBIT CARD DATA AND REPORTS, CREDIT MANAGEMENT SERVICES, FINANCING SERVICES AND FINANCIAL CONSULTATION; INSURANCE ADMINISTRATION, INSURANCE CONSULTATION, AND INSURANCE BROKERAGE (U.S. CLS. 100, 101 AND 102).

LAURA HAMMEL, EXAMINING ATTORNEY

SN 78-592,434. UGS CORP., PLANO, TX. FILED 3-22-2005.

SN 78-592,974. DEC TECHNOLOGIES, INC., PINEY FLATS, TN. FILED 3-23-2005.

TRANSFORMING THE
PROCESS OF
INNOVATION



THE MARK CONSISTS OF STANDARD CHARACTERS WITHOUT CLAIM TO ANY PARTICULAR FONT, STYLE, SIZE, OR COLOR.

CLASS 9—ELECTRICAL AND SCIENTIFIC APPARATUS

FOR COMPUTER SOFTWARE FOR COMPUTER-AIDED DESIGN, COMPUTER-AIDED MANUFACTURING, COMPUTER-AIDED ENGINEERING AND COLLABORATIVE PRODUCT DEVELOPMENT; COMPUTER SOFTWARE FOR PRODUCT LIFECYCLE MANAGEMENT, COMPUTER-AIDED INDUSTRIAL DESIGN, KNOWLEDGE-BASED ENGINEERING, PRODUCT DATA MANAGEMENT, MANUFACTURING DATA MANAGEMENT, COLLABORATIVE PRODUCT DEVELOPMENT MANAGEMENT (U.S. CLS. 21, 23, 26, 36 AND 38).

CLASS 35—ADVERTISING AND BUSINESS

FOR BUSINESS CONSULTING SERVICES IN THE FIELDS OF PRODUCT LIFECYCLE MANAGEMENT, COMPUTER-AIDED DESIGN, COMPUTER-AIDED INDUSTRIAL DESIGN, COMPUTER-AIDED ENGINEERING, COMPUTER-AIDED MANUFACTURING, KNOWLEDGE-BASED ENGINEERING, PRODUCT DATA MANAGEMENT, MANUFACTURING DATA MANAGEMENT, COLLABORATIVE PRODUCT DEVELOPMENT MANAGEMENT AND COLLABORATIVE PROCESS DEVELOPMENT (U.S. CLS. 100, 101 AND 102).

CLASS 41—EDUCATION AND ENTERTAINMENT

FOR EDUCATIONAL SERVICES, NAMELY, CONDUCTING CLASSES AND WORKSHOPS IN THE FIELDS OF PRODUCT LIFECYCLE MANAGEMENT, COMPUTER-AIDED DESIGN, COMPUTER-AIDED INDUSTRIAL DESIGN, COMPUTER-AIDED ENGINEERING, COMPUTER-AIDED MANUFACTURING, KNOWLEDGE-BASED ENGINEERING, PRODUCT DATA MANAGEMENT, MANUFACTURING DATA MANAGEMENT, COLLABORATIVE PRODUCT DEVELOPMENT MANAGEMENT AND COLLABORATIVE PROCESS DEVELOPMENT (U.S. CLS. 100, 101 AND 107).

CLASS 42—SCIENTIFIC, COMPUTER AND LEGAL SERVICES

FOR DESIGN AND DEVELOPMENT OF COMPUTER SOFTWARE; COMPUTER SOFTWARE INTEGRATION AND COMPUTER PROGRAMMING FOR OTHERS IN THE FIELDS OF PRODUCT LIFECYCLE MANAGEMENT, COMPUTER-AIDED DESIGN, COMPUTER-AIDED INDUSTRIAL DESIGN, COMPUTER-AIDED ENGINEERING, COMPUTER-AIDED MANUFACTURING, KNOWLEDGE-BASED ENGINEERING, PRODUCT DATA MANAGEMENT, MANUFACTURING DATA MANAGEMENT, COLLABORATIVE PRODUCT DEVELOPMENT MANAGEMENT AND COLLABORATIVE PROCESS DEVELOPMENT (U.S. CLS. 100 AND 101).
EUGENIA MARTIN, EXAMINING ATTORNEY

NO CLAIM IS MADE TO THE EXCLUSIVE RIGHT TO USE "TECHNOLOGIES, INC.", APART FROM THE MARK AS SHOWN.

THE MARK CONSISTS OF THE STYLIZED WORDS "DEC TECHNOLOGIES, INC." PRECEDED BY AN INCOMPLETE CIRCLE WITH AN ARROW-LIKE DESIGN RUNNING THROUGH THE NEARLY-COMPLETE CIRCLE.

CLASS 7—MACHINERY

FOR AIRCRAFT MOTORS, ENGINES, TRANSMISSIONS, ELECTRONIC IGNITIONS, AND PARTS AND COMPONENTS THEREOF; AIRCRAFT EXHAUST SYSTEMS COMPRISED OF LINERS, TUBING, PIPES, ELBOWS, CLAMPS, FLANGES, BALL SCREWS, THRUST REVERSERS AND PARTS AND COMPONENTS THEREOF; ENGINE PARTS AND COMPONENTS USED IN THE OPERATION AND CONTROL OF AIRCRAFT, NAMELY PNEUMATIC CONTROLS COMPRISED OF STARTERS, GEARS, PUMPS, PISTONS, RINGS, AND SEALS, AND LUBRICANT SYSTEMS COMPRISED OF PUMPS, GEARS, SHAFTS, BUSHINGS AND SEALS; AIRCRAFT LIQUID AND AIR COOLANT SYSTEMS COMPRISED OF HOUSINGS, INTAKE AND BLEED VALVES, FINS, CAMS, GEAR SHAFTS, RODS, ARMS, SPRINGS, AND PARTS AND COMPONENTS THEREOF; MECHANICAL FUEL CONTROLS COMPRISED OF GEARS, SHAFTS, LEVERS, SEALS, BUSHINGS, RODS, ARMS, SPRINGS, CLAMPS, FLANGES, SENSORS, AND THERMOCOUPLES (U.S. CLS. 13, 19, 21, 23, 31, 34 AND 35).
FIRST USE 1-31-2002; IN COMMERCE 1-31-2002.

CLASS 9—ELECTRICAL AND SCIENTIFIC APPARATUS

FOR AUXILIARY POWER SYSTEMS NAMELY, AUXILIARY POWER UNITS COMPRISED OF BRACKETS, GEARS, BUSHINGS, SHAFTS, MOTORS AND PARTS AND COMPONENTS THEREFOR; NAVIGATION LIGHT SYSTEMS COMPRISED OF CAPACITORS, WIRING, ASSEMBLIES, AND PARTS AND COMPONENTS THEREFORE (U.S. CLS. 21, 23, 26, 36 AND 38).
FIRST USE 1-31-2002; IN COMMERCE 1-31-2002.

CLASS 11—ENVIRONMENTAL CONTROL APPARATUS

FOR INTERIOR AND EXTERIOR LIGHTING FIXTURES FOR USE IN THE AIRCRAFT AND AEROSPACE INDUSTRY AND AIR CONDITIONERS FOR USE IN THE AIRCRAFT AND AEROSPACE INDUSTRY; REPLACEMENT BULBS FOR AIRCRAFT NAVIGATION SYSTEMS, LANDING SYSTEMS, ANTI-COLLISION SYSTEMS AND CABIN LIGHTING SYSTEMS (U.S. CLS. 13, 21, 23, 31 AND 34).
FIRST USE 1-31-2002; IN COMMERCE 1-31-2002.

CLASS 12—VEHICLES

FOR AIRCRAFT STRUCTURAL PARTS AND ACCESSORIES FOR USE IN THE AEROSPACE INDUSTRY, NAMELY, ICE AND RAIN PROTECTION SYSTEMS, NAMELY DE-ICING VALVES COMPRISED OF SHAFTS, GEARS, BUSHINGS, BLEED VALVES, MOTORS, AND PARTS AND COMPONENTS THEREFORE, ELECTRICAL POWER SYSTEMS, NAMELY LANDING LIGHT SYSTEMS COMPRISED OF BRACKETS, GEARS, BUSHINGS, SHAFTS, ASSEMBLIES, AND PARTS AND COMPONENTS THEREFORE; ANTI-COLLISION LIGHT SYSTEMS COMPRISED OF BRACKETS, GEARS, BUSHINGS, SHAFTS, ASSEMBLIES AND PARTS AND COMPONENTS THEREFORE; AIRCRAFT LANDING GEAR AND CONTROLS THEREFORE; COMPONENTS USED IN THE OPERATION AND CONTROL OF AIRCRAFT, NAMELY HYDRAULIC SYSTEMS COMPRISED OF BRAKES, BRAKE PADS, ACTUATORS, SHAFTS, SEALS, PISTONS, HOUSINGS, FLAPS AND TAIL STABILIZERS, AND PNEUMATIC SYSTEMS COMPRISED OF GEARS, PUMPS, PISTONS, RINGS, AND SEALS (U.S. CLS. 19, 21, 23, 31, 35 AND 44).

FIRST USE 1-31-2002; IN COMMERCE 1-31-2002.

CLASS 42—SCIENTIFIC, COMPUTER AND LEGAL SERVICES

FOR ENGINEERING AND DESIGN SERVICES RELATIVE TO THE DEVELOPMENT OF AFTERMARKET PRODUCTS FOR THE AIRCRAFT AND AEROSPACE INDUSTRY (U.S. CLS. 100 AND 101).

FIRST USE 1-31-2002; IN COMMERCE 1-31-2002.

KIMBERLY PERRY, EXAMINING ATTORNEY

SN 78-594,600. BOWTIE, INC., IRVINE, CA. FILED 3-24-2005.

FRESHWATER AND MARINE AQUARIUM

THE MARK CONSISTS OF STANDARD CHARACTERS WITHOUT CLAIM TO ANY PARTICULAR FONT, STYLE, SIZE, OR COLOR.
SEC. 2(F).

CLASS 16—PAPER GOODS AND PRINTED MATTER

FOR PRINTED PUBLICATIONS, NAMELY, MAGAZINES IN THE FIELD OF AQUATIC SPECIES AND THEIR ENVIRONMENTS AND GENERAL INTEREST (U.S. CLS. 2, 5, 22, 23, 29, 37, 38 AND 50).

FIRST USE 1-0-1978; IN COMMERCE 1-0-1978.

CLASS 44—MEDICAL, BEAUTY AND AGRICULTURAL SERVICES

FOR COMPUTER SERVICES, NAMELY, PROVIDING ONLINE INFORMATION IN THE FIELD OF AQUATIC SPECIES AND THEIR ENVIRONMENTS, AND FEATURES OF GENERAL INTEREST TO OWNERS OF AQUATIC SPECIES (U.S. CLS. 100 AND 101).

FIRST USE 5-0-2001; IN COMMERCE 5-0-2001.

WARREN L. OLANDRIA, EXAMINING ATTORNEY

SN 78-595,420. KIDS FUN, INC., MINNETONKA, MN. FILED 3-25-2005.

TESSA

THE MARK CONSISTS OF STANDARD CHARACTERS WITHOUT CLAIM TO ANY PARTICULAR FONT, STYLE, SIZE, OR COLOR.

THE NAME TESSA IDENTIFIES A LIVING INDIVIDUAL WHOSE CONSENT IS OF RECORD.

CLASS 9—ELECTRICAL AND SCIENTIFIC APPARATUS

FOR PRE-RECORDED SERIES OF COMPACT DISCS FEATURING MUSIC; PRE-RECORDED DVDS FEATURING MUSIC, DANCE, AND FITNESS ACTIVITIES (U.S. CLS. 21, 23, 26, 36 AND 38).

FIRST USE 4-3-2004; IN COMMERCE 5-15-2004.

CLASS 41—EDUCATION AND ENTERTAINMENT

FOR ENTERTAINMENT SERVICES IN THE NATURE OF LIVE PERFORMANCES BY AN INDIVIDUAL SINGER, DANCER, AND FITNESS INSTRUCTOR (U.S. CLS. 100, 101 AND 107).

FIRST USE 3-24-2005; IN COMMERCE 3-24-2005.

KATHRYN COWARD, EXAMINING ATTORNEY

SN 78-597,886. NEXT VENTURE, LLC, ATLANTA, GA. FILED 3-30-2005.

MONKEY JOE'S

THE MARK CONSISTS OF STANDARD CHARACTERS WITHOUT CLAIM TO ANY PARTICULAR FONT, STYLE, SIZE, OR COLOR.

CLASS 25—CLOTHING

FOR CLOTHING, NAMELY, T-SHIRTS AND POLO SHIRTS (U.S. CLS. 22 AND 39).

CLASS 41—EDUCATION AND ENTERTAINMENT

FOR ENTERTAINMENT SERVICES, NAMELY INDOOR GYMNASIUMS FOR FAMILY AMUSEMENTS (U.S. CLS. 100, 101 AND 107).

CAROLINE WEIMER, EXAMINING ATTORNEY

SN 78-606,526. ENTERCOM COMMUNICATIONS CORP., BALA CYNWYD, PA. FILED 4-11-2005.

MIKE FM

SN 78-599,299. NEOCONIX, INC., SUNNYVALE, CA. FILED 3-31-2005.

**CLASS 9—ELECTRICAL AND SCIENTIFIC APPARATUS**

FOR ELECTRICAL INTERCONNECTORS, ASSEMBLY AND TEST SOCKETS, AND LAND GRID ARRAY INTERPOSERS FOR ELECTRICALLY CONNECTING ELECTRICAL DEVICES (U.S. CLS. 21, 23, 26, 36 AND 38).
FIRST USE 12-6-2004; IN COMMERCE 12-6-2004.

CLASS 42—SCIENTIFIC, COMPUTER AND LEGAL SERVICES

FOR DESIGN AND DEVELOPMENT OF ELECTRICAL INTERCONNECTORS FOR OTHERS; ENGINEERING SERVICES IN THE NATURE OF INTEGRATION OF ELECTRICAL INTERCONNECTORS FOR OTHERS; AND TECHNICAL SUPPORT, NAMELY, TROUBLESHOOTING ELECTRICAL INTERCONNECTORS FOR OTHERS (U.S. CLS. 100 AND 101).

FIRST USE 12-6-2004; IN COMMERCE 12-6-2004.
COLLEEN DOMBROW, EXAMINING ATTORNEY

THE MARK CONSISTS OF STANDARD CHARACTERS WITHOUT CLAIM TO ANY PARTICULAR FONT, STYLE, SIZE, OR COLOR.

NO CLAIM IS MADE TO THE EXCLUSIVE RIGHT TO USE "FM", APART FROM THE MARK AS SHOWN.

THE NAME MIKE FM DOES NOT IDENTIFY A LIVING INDIVIDUAL.

CLASS 38—COMMUNICATION

FOR RADIO BROADCASTING SERVICES (U.S. CLS. 100, 101 AND 104).

FIRST USE 4-14-2005; IN COMMERCE 4-14-2005.

CLASS 41—EDUCATION AND ENTERTAINMENT

FOR ENTERTAINMENT SERVICES, NAMELY PRODUCTION OF RADIO PROGRAMS, RADIO PROGRAMMING; RADIO ENTERTAINMENT SERVICES, NAMELY RADIO PROGRAMS IN THE FIELDS OF ENTERTAINMENT AND MUSIC (U.S. CLS. 100, 101 AND 107).

FIRST USE 4-14-2005; IN COMMERCE 4-14-2005.

KELLEY WELLS, EXAMINING ATTORNEY

SN 78-605,145. CALLIO TECHNOLOGIES INC., QUEBEC, CANADA, FILED 4-8-2005.

**CLASS 9—ELECTRICAL AND SCIENTIFIC APPARATUS**

FOR COMPUTER SOFTWARE FOR THE IMPLEMENTATION OF INFORMATION SECURITY MANAGEMENT STANDARDS, METHODOLOGIES AND LEGISLATION (U.S. CLS. 21, 23, 26, 36 AND 38).

CLASS 42—SCIENTIFIC, COMPUTER AND LEGAL SERVICES

FOR TRAINING SERVICES IN THE FIELD OF INFORMATION MANAGEMENT; COMPUTER PROGRAMMING SERVICES; DEVELOPMENT OF COMPUTER SOFTWARE FOR THE IMPLEMENTATION OF INFORMATION SECURITY MANAGEMENT STANDARDS, METHODOLOGIES AND LEGISLATION; COMPUTER CONSULTATION SERVICES (U.S. CLS. 100 AND 101).

JOHN DALIER, EXAMINING ATTORNEY

SN 78-610,092. DUKE UNIVERSITY, DURHAM, NC. FILED 4-15-2005.

MAW3

THE MARK CONSISTS OF STANDARD CHARACTERS WITHOUT CLAIM TO ANY PARTICULAR FONT, STYLE, SIZE, OR COLOR.

CLASS 9—ELECTRICAL AND SCIENTIFIC APPARATUS

FOR MEDICAL INFORMATION SYSTEMS, NAMELY, COMPUTER HARDWARE, COMPUTER PERIPHERALS AND RELATED MEDICAL INFORMATION SOFTWARE (U.S. CLS. 21, 23, 26, 36 AND 38).

CLASS 35—ADVERTISING AND BUSINESS

FOR MANAGEMENT OF ELECTRONIC FILES AND RECORDS RELATED TO HEALTH CARE DATA (U.S. CLS. 100, 101 AND 102).

CLASS 44—MEDICAL, BEAUTY AND AGRICULTURAL SERVICES

FOR MAINTAINING ELECTRONIC FILES AND RECORDS RELATED TO HEALTH CARE DATA (U.S. CLS. 100 AND 101).

SEAN CROWLEY, EXAMINING ATTORNEY

SN 78-610,785. PARADIGM SPINE, LLC, NEW YORK, NY.
FILED 4-18-2005.

SN 78-618,060. GIBNEY, JOEL, MICHAEL, OCEANSIDE, CA.
FILED 4-27-2005.

THE MOVEMENT IN SPINE CARE

THE MARK CONSISTS OF STANDARD CHARACTERS WITHOUT CLAIM TO ANY PARTICULAR FONT, STYLE, SIZE, OR COLOR.

CLASS 5—PHARMACEUTICALS

FOR MEDICAL DIAGNOSTIC ASSAYS FOR TESTING OF BODY FLUIDS (U.S. CLS. 6, 18, 44, 46, 51 AND 52).

CLASS 10—MEDICAL APPARATUS

FOR MEDICAL PRODUCTS AND INSTRUMENTS TO TREAT SPINAL DISEASE OR SPINAL INSTABILITY, NAMELY, SURGICALLY IMPLANTABLE SPINAL STABILIZATION DEVICES AND SURGICAL INSTRUMENTS FOR IMPLANTING SUCH DEVICES; MEDICAL DIAGNOSTIC TESTS INSTRUMENTS FOR DETECTING AND MONITORING SPINAL DISEASES OR SPINAL INSTABILITY (U.S. CLS. 26, 39 AND 44).
CHERYL CLAYTON, EXAMINING ATTORNEY

SN 78-616,807. INKLITE DIGITAL PUBLISHING LLC, PLACENTIA, CA. FILED 4-26-2005.

DOCDEZ

THE MARK CONSISTS OF STANDARD CHARACTERS WITHOUT CLAIM TO ANY PARTICULAR FONT, STYLE, SIZE, OR COLOR.

CLASS 9—ELECTRICAL AND SCIENTIFIC APPARATUS

FOR DESKTOP PUBLISHING SOFTWARE THAT PUBLISHES DIGITAL DOCUMENTS (U.S. CLS. 21, 23, 26, 36 AND 38).

CLASS 42—SCIENTIFIC, COMPUTER AND LEGAL SERVICES

FOR PROVIDING TEMPORARY USE OF ONLINE, NON-DOWNLOADABLE SOFTWARE FOR USE IN PUBLISHING DIGITAL DOCUMENTS (U.S. CLS. 100 AND 101).
ALLISON HOLTZ, EXAMINING ATTORNEY

Tiger Paw

THE MARK CONSISTS OF STANDARD CHARACTERS WITHOUT CLAIM TO ANY PARTICULAR FONT, STYLE, SIZE, OR COLOR.

CLASS 9—ELECTRICAL AND SCIENTIFIC APPARATUS

FOR COMPUTER PRODUCTS, NAMELY, SOFTWARE FOR SCREENSAVERS, MOUSE PADS, COMPUTER WRIST RESTS, AND DESKTOP PERSONAL COMPUTERS (U.S. CLS. 21, 23, 26, 36 AND 38).
FIRST USE 9-1-1997; IN COMMERCE 10-18-1999.

CLASS 28—TOYS AND SPORTING GOODS

FOR HAND EXERCISER, NAMELY A MANUAL HAND EXERCISER THAT EXERCISES THE MUSCLES OF THE UPPER EXTREMITY, CONCENTRATING ON THE OPENING MUSCLES AND THE EXTENSOR MUSCLES OF THE HAND AND ARM (U.S. CLS. 22, 23, 38 AND 50).
FIRST USE 9-1-1997; IN COMMERCE 10-18-1999.
JENNIFER KRISP, EXAMINING ATTORNEY

SN 78-619,615. FIELDSTONE CENTER, INC., CONYERS, GA.
FILED 4-29-2005.

EVERYTHING IN BUILDING WITH STONE

THE MARK CONSISTS OF STANDARD CHARACTERS WITHOUT CLAIM TO ANY PARTICULAR FONT, STYLE, SIZE, OR COLOR.

CLASS 19—NON-METALLIC BUILDING MATERIALS

FOR STONE, BUILDING STONE, SLATE TILE, COBBLESTONE, FLAGSTONE, LANDSCAPING STONE, LIMESTONE, STONE USED FOR STACKING IN BUILDING AND CONSTRUCTION, PAVING STONE (U.S. CLS. 1, 12, 33 AND 50).
FIRST USE 6-1-1994; IN COMMERCE 6-1-1994.

CLASS 35—ADVERTISING AND BUSINESS

FOR WHOLESALE AND RETAIL STORES FEATURING STONE, BUILDING STONE, SLATE TILE, COBBLESTONE, FLAGSTONE, LANDSCAPING STONE, LIMESTONE, STONE USED FOR STACKING IN BUILDING AND CONSTRUCTION, PAVING STONE (U.S. CLS. 100, 101 AND 102).
FIRST USE 6-1-1994; IN COMMERCE 6-1-1994.
LINDA ESTRADA, EXAMINING ATTORNEY

SN 78-619,745. LBD INTERNATIONAL INC., CLEVELAND, OH. FILED 4-29-2005.

SN 78-620,386. AMERICAN TACK & HARDWARE CO., INC., MONSEY, NY. FILED 4-29-2005.



NO CLAIM IS MADE TO THE EXCLUSIVE RIGHT TO USE BONDAGE, APART FROM THE MARK AS SHOWN.

THE MARK CONSISTS OF A SHIELD DESIGN WITH HALF OF A DEVIL'S FACE ON THE RIGHT SIDE AND THE WORD DANTE RUNNING UP AND DOWN ON THE LEFT SIDE, THE WORD BONDAGE AT THE TOP OF THE SHIELD, THE WORD DEPT AT THE BOTTOM OF THE SHIELD AND DESIGNS OF NUMEROUS CROSSED WHIPS SCATTERED THROUGHOUT THE BODY OF THE SHIELD.

CLASS 18—LEATHER GOODS

FOR LEATHER AND IMITATION LEATHER WHIPS, HARNESSSES, RESTRAINTS AND PADDLES, ALL FOR BONDAGE USE (U.S. CLS. 1, 2, 3, 22 AND 41).
FIRST USE 9-1-2004; IN COMMERCE 9-1-2004.

CLASS 25—CLOTHING

FOR COLLARS AND BRACELETS IN THE NATURE OF CUFFS FOR BONDAGE USE (U.S. CLS. 22 AND 39).
FIRST USE 9-1-2004; IN COMMERCE 9-1-2004.
KELLEY WELLS, EXAMINING ATTORNEY

SN 78-619,921. TT TECHNOLOGIES, INC., MAUMEE, OH. FILED 4-29-2005.

TRU-LOGISTICS

THE MARK CONSISTS OF STANDARD CHARACTERS WITHOUT CLAIM TO ANY PARTICULAR FONT, STYLE, SIZE, OR COLOR.

CLASS 37—CONSTRUCTION AND REPAIR

FOR INSTALLATION, REPLACEMENT, PRE-HANGING, AND REPAIR OF DOORS, DOOR HARDWARE, MOLDING AND GLASS (U.S. CLS. 100, 103 AND 106).

CLASS 40—MATERIAL TREATMENT

FOR CUSTOM ASSEMBLY, FINISHING, AND MACHINING OF DOORS, DOOR HARDWARE, MOLDING, AND GLASS (U.S. CLS. 100, 103 AND 106).
SEAN CROWLEY, EXAMINING ATTORNEY

HOLDALL

THE MARK CONSISTS OF STANDARD CHARACTERS WITHOUT CLAIM TO ANY PARTICULAR FONT, STYLE, SIZE, OR COLOR.

OWNER OF U.S. REG. NOS. 1,893,920 AND 2,117,945.

CLASS 6—METAL GOODS

FOR METAL PLANT BRACKETS FOR HANGING HOUSEHOLD PLANTS; METAL HOOKS AND CHAINS FOR HANGING PLANTS (U.S. CLS. 2, 12, 13, 14, 23, 25 AND 50).
FIRST USE 5-16-1995; IN COMMERCE 5-16-1995.

CLASS 20—FURNITURE AND ARTICLES NOT OTHERWISE CLASSIFIED

FOR METAL AND WOOD PLANT DOLLIES, NAMELY, ROLLING METAL AND WOOD PLANT STANDS; METAL AND WOOD PLANT TRIVETS (U.S. CLS. 2, 13, 22, 25, 32 AND 50).
FIRST USE 5-16-1995; IN COMMERCE 5-16-1995.

CLASS 21—HOUSEWARES AND GLASS

FOR METAL AND PLASTIC WATERING CANS; METAL HANGING PLANT BASKETS; METAL OVER-THE-RAIL HOLDERS FOR PLANT BOXES AND PLANT POTS; FITTED NATURAL AND SYNTHETIC FIBER COCO LINERS FOR PLANT BOXES, PLANT POTS, AND PLANT BASKETS (U.S. CLS. 2, 13, 23, 29, 30, 33, 40 AND 50).
FIRST USE 5-16-1995; IN COMMERCE 5-16-1995.
RENEE MCCRAY, EXAMINING ATTORNEY

SN 78-622,189. NORTHROP GRUMMAN SHIP SYSTEMS, INC., PASCAGOULA, MS. FILED 5-4-2005.

BUILDING FREEDOM...ONE GREAT SHIP AT A TIME

THE MARK CONSISTS OF STANDARD CHARACTERS WITHOUT CLAIM TO ANY PARTICULAR FONT, STYLE, SIZE, OR COLOR.

CLASS 37—CONSTRUCTION AND REPAIR

FOR NAVAL SHIPBUILDING; MAINTENANCE AND REPAIR OF MARINE VEHICLES (U.S. CLS. 100, 103 AND 106).
FIRST USE 1-0-1999; IN COMMERCE 1-0-1999.

CLASS 42—SCIENTIFIC, COMPUTER AND LEGAL SERVICES

FOR PRODUCT RESEARCH AND DEVELOPMENT IN THE FIELD OF COMMERCIAL AND MILITARY MARINE VEHICLES; ENGINEERING RELATING TO COMMERCIAL AND MILITARY MARINE VEHICLES; TECHNICAL CONSULTANCY IN RELATION TO THE PRODUCTION OF COMMERCIAL AND MILITARY MARINE VEHICLES; DESIGN OF COMMERCIAL AND MILITARY MARINE VEHICLES (U.S. CLS. 100 AND 101).

FIRST USE 1-0-1999; IN COMMERCE 1-0-1999.
IRA J. GOODSaid, EXAMINING ATTORNEY

SN 78-625,479. FONTERRA TM LIMITED, AUCKLAND, NEW ZEALAND, FILED 5-9-2005.

FONTERRA

THE MARK CONSISTS OF STANDARD CHARACTERS WITHOUT CLAIM TO ANY PARTICULAR FONT, STYLE, SIZE, OR COLOR.

OWNER OF NEW ZEALAND REG. NO. 668443, DATED 2-9-2004, EXPIRES 11-14-2009.

OWNER OF NEW ZEALAND REG. NO. 658119, DATED 3-31-2003, EXPIRES 5-31-2007.

OWNER OF NEW ZEALAND REG. NO. 658118, DATED 3-31-2003, EXPIRES 5-31-2009.

OWNER OF NEW ZEALAND REG. NO. 658117, DATED 12-6-2002, EXPIRES 5-31-2009.

OWNER OF NEW ZEALAND REG. NO. 632732, DATED 4-4-2002, EXPIRES 2-21-2008.

OWNER OF NEW ZEALAND REG. NO. 658115, DATED 12-6-2002, EXPIRES 5-31-2007.

SN 78-624,874. DEPARTMENT OF DEFENSE, ALENANDRIA, VA. FILED 5-6-2005.

PENTAGON CHANNEL

THE MARK CONSISTS OF STANDARD CHARACTERS WITHOUT CLAIM TO ANY PARTICULAR FONT, STYLE, SIZE, OR COLOR.

NO CLAIM IS MADE TO THE EXCLUSIVE RIGHT TO USE "CHANNEL", APART FROM THE MARK AS SHOWN. SEC. 2(F).

CLASS 38—COMMUNICATION

FOR TELEVISION AND RADIO PROGRAM BROADCASTING VIA CABLE; BROADCAST OF CABLE TELEVISION AND RADIO PROGRAMS (U.S. CLS. 100, 101 AND 104).

FIRST USE 1-1-2004; IN COMMERCE 1-1-2004.

CLASS 41—EDUCATION AND ENTERTAINMENT

FOR PRODUCTION OF CABLE RADIO AND TELEVISION PROGRAMS; DISTRIBUTION OF RADIO AND TELEVISION PROGRAMS FOR OTHERS; ENTERTAINMENT SERVICES IN THE NATURE OF ON-GOING RADIO AND TELEVISION PROGRAMS IN THE FIELD OF NEWS AND COMMENTARY; PROVIDING INFORMATION AND COMMENTARY IN THE FIELDS OF NEWS AND PUBLIC AFFAIRS VIA THE INTERNET (U.S. CLS. 100, 101 AND 107).

FIRST USE 1-1-2004; IN COMMERCE 1-1-2004.
TASNEEM HUSSAIN, EXAMINING ATTORNEY

CLASS 5—PHARMACEUTICALS

FOR FOOD AND NUTRITIONAL SUPPLEMENTS; BABY AND INFANT FOODS; INVALIDS' FOODS, NAMELY, FOOD FOR MEDICALLY RESTRICTED DIETS; DIETETIC FOODS AND BEVERAGES ADAPTED FOR MEDICAL USE; VACCINES; MINERAL SUPPLEMENTS FOR FOOD FORTIFICATION; NUTRITIONAL ADDITIVES FOR FOOD FOR HUMAN CONSUMPTION; VITAMIN AND MINERAL PREPARATIONS FOR USE AS INGREDIENTS IN THE FOOD AND PHARMACEUTICAL INDUSTRY; AND MEDICATED ANIMAL FEED (U.S. CLS. 6, 18, 44, 46, 51 AND 52).

CLASS 29—MEATS AND PROCESSED FOODS

FOR MILK; MILK PRODUCTS, NAMELY, FLAVORED MILK AND FORTIFIED MILK; BUTTER, CHEESE, COTTAGE AND CREAM CHEESE, SOUR CREAM, CREAM FRAICHE, YOGHURT, DRINKING YOGHURT; MILK POWDER FOR NUTRITIONAL PURPOSES; EDIBLE OILS AND FATS; MARGARINE AND FOOD SPREADS, NAMELY, BLENDS OF MARGARINE, BUTTER AND OTHER EDIBLE OILS AND FATS; PROTEIN FOR USE AS A FOOD ADDITIVE FEATURING POTASSIUM PROTEINATE, MILK PROTEIN CONCENTRATE, MILK PROTEIN ISOLATE, WHEY PROTEIN CONCENTRATE AND WHEY PROTEIN ISOLATE LACTALBUMIN; AND CASEIN FOR FOOD (U.S. CL. 46).

CLASS 35—ADVERTISING AND BUSINESS

FOR ADVERTISING, BUSINESS MANAGEMENT, BUSINESS ADMINISTRATION SERVICES RELATING TO THE DAIRY AND FARMING INDUSTRY; CONDUCTING BUSINESS SURVEYS; BUSINESS MARKETING SERVICES RELATING TO THE DAIRY, FARMING, AGRICULTURAL, AND HORTICULTURAL INDUSTRIES; DISSEMINATION OF ADVERTISING FOR OTHERS VIA THE INTERNET; BUSINESS MANAGEMENT ASSISTANCE TO INDUSTRIAL OR COMMERCIAL COMPANIES; BUSINESS APPRAISALS, ADVISORY SERVICES RELATING TO BUSINESS MANAGEMENT; MARKET RESEARCH; MARKETING STUDIES; CONDUCTING BUSINESS RESEARCH; ADVISORY AND CONSULTANCY SERVICES WITH REGARD TO BUSINESS PLANNING, BUSINESS ANALYSIS, BUSINESS MANAGEMENT AND BUSINESS ORGANISATION IN THE FIELD OF THE FARMING, DAIRY, INFORMATION AND SCIENCE TECHNOLOGY, AGRICULTURAL, AND HORTICULTURAL INDUSTRIES; MANAGEMENT AND COMPILATION OF COMPUTERIZED DATABASES; BUSINESS ADVISORY SERVICES TO MANUFACTURING AND MARKETING BUSINESSES (U.S. CLS. 100, 101 AND 102).

CLASS 41—EDUCATION AND ENTERTAINMENT

FOR EDUCATION SERVICES, NAMELY, PROVIDING CLASSES, SEMINARS AND WORKSHOPS IN THE FIELD OF THE DAIRY, FARMING AND AGRICULTURAL AND HORTICULTURAL INDUSTRIES; TRAINING SERVICES IN THE FIELD OF THE DAIRY, FARMING AND AGRICULTURAL AND HORTICULTURAL INDUSTRIES; LIBRARIES; ORGANIZATION OF EXHIBITIONS AND SEMINARS FOR EDUCATIONAL OR ENTERTAINMENT PURPOSES, IN THE FIELD OF THE DAIRY, FARMING AND AGRICULTURAL AND HORTICULTURAL INDUSTRIES (U.S. CLS. 100, 101 AND 107).

CLASS 42—SCIENTIFIC, COMPUTER AND LEGAL SERVICES

FOR SCIENTIFIC RESEARCH; TECHNICAL SUPPORT SERVICES, NAMELY, TROUBLESHOOTING OF COMPUTER HARDWARE AND SOFTWARE PROBLEMS; SOFTWARE DESIGN SERVICES FOR OTHERS; SCIENTIFIC, INDUSTRIAL AND TECHNOLOGICAL RESEARCH AND ANALYSIS SERVICES RELATING TO FARMING, FARM PRODUCE, FOODSTUFFS, BEVERAGES, PHARMACEUTICALS, VETERINARY PRODUCTS AND PERFORMANCE; INTERNET SERVICES, NAMELY, WEBSITE CREATION FOR OTHERS, PROVIDING INFORMATION IN THE FIELD OF LAND USE; FARM AND LAND PRODUCT DEVELOPMENT SERVICES FOR OTHERS (U.S. CLS. 100 AND 101).

CLASS 44—MEDICAL, BEAUTY AND AGRICULTURAL SERVICES

FOR FARM OPERATION ADVISORY SERVICES; ANIMAL BREEDING; FARM INFORMATION SERVICES; AERIAL AND SURFACE SPREADING OF FERTILIZERS AND OTHER AGRICULTURAL CHEMICALS (U.S. CLS. 100 AND 101).

ANDREA EVANS, EXAMINING ATTORNEY

SN 78-629,931. ZX TECHNOLOGIES, INC., SOUTHLAKE, TX. FILED 5-13-2005.

ZXTECH

THE MARK CONSISTS OF STANDARD CHARACTERS WITHOUT CLAIM TO ANY PARTICULAR FONT, STYLE, SIZE, OR COLOR.

CLASS 9—ELECTRICAL AND SCIENTIFIC APPARATUS

FOR EMBEDDABLE COMPUTER HARDWARE; AND OPERATING SYSTEM SOFTWARE FOR USE WITH SUCH COMPUTER HARDWARE (U.S. CLS. 21, 23, 26, 36 AND 38).

CLASS 42—SCIENTIFIC, COMPUTER AND LEGAL SERVICES

FOR DESIGN AND DEVELOPMENT OF COMPUTER SOFTWARE AND HARDWARE FOR OTHERS (U.S. CLS. 100 AND 101).

KRISTIN DAHLING, EXAMINING ATTORNEY

SN 78-631,044. CRITICAL PATH, INC., SAN FRANCISCO, CA. FILED 5-16-2005.

messages that *Matter*

NO CLAIM IS MADE TO THE EXCLUSIVE RIGHT TO USE "MESSAGES", APART FROM THE MARK AS SHOWN.

CLASS 9—ELECTRICAL AND SCIENTIFIC APPARATUS

FOR COMPUTER SOFTWARE FOR ELECTRONIC MAIL, MOBILE MESSAGING AND MULTIMEDIA MESSAGING; PERSONAL INFORMATION MANAGEMENT SOFTWARE FOR MAINTAINING CALENDARS, ADDRESS BOOKS, AND FILE SHARING; ANTI-SPAM AND ANTI-VIRUS SOFTWARE; COMPUTER SOFTWARE FOR STORAGE, BACKUP, PROTECTION AND SYNCHRONIZATION OF VOICE, DATA, IMAGES, AUDIO, VIDEO, SIGNALS AND MESSAGES, AND MANUALS AND DATASHEETS SOLD THEREWITH (U.S. CLS. 21, 23, 26, 36 AND 38).

FIRST USE 2-14-2005; IN COMMERCE 2-14-2005.

CLASS 38—COMMUNICATION

FOR ELECTRONIC MESSAGING SYSTEMS, NAMELY, ELECTRONIC QUEUING SERVICES AND ELECTRONIC RECEIVING, AND STORE-AND-FORWARD MESSAGING; TELECOMMUNICATION SERVICES, NAMELY, ELECTRONIC MULTIMEDIA MESSAGE TRANSMISSION SERVICES; HOSTED AND MANAGED ELECTRONIC QUEUING SERVICES, ELECTRONIC RECEIVING AND STORE-AND-FORWARD MESSAGING, INSTANT MESSAGING SERVICES, TEXT AND NUMERIC WIRELESS DIGITAL MESSAGING SERVICES (U.S. CLS. 100, 101 AND 104).

FIRST USE 2-14-2005; IN COMMERCE 2-14-2005.

TOBY BULLOFF, EXAMINING ATTORNEY

SN 78-633,710. KILLGERM GROUP LIMITED, WEST YORKSHIRE, UNITED KINGDOM, FILED 5-20-2005.

BIO-GEL

THE MARK CONSISTS OF STANDARD CHARACTERS WITHOUT CLAIM TO ANY PARTICULAR FONT, STYLE, SIZE, OR COLOR.

CLASS 1—CHEMICALS

FOR ORGANIC DEBRIS REMOVER, AND BIO-REMEDIATION PRODUCTS, NAMELY, MICROBIAL COMPOSITIONS THAT CONSUME AND DIGEST HYDROCARBONS, BIO-DEGRADABLE BIOCHEMICAL PREPARATIONS, AND BIO-DEGRADABLE WATER TREATMENT CHEMICAL CONCENTRATE FOR BREAKING DOWN AND REDUCING ORGANIC DEBRIS, FOR USE IN COMMERCIAL, INDUSTRIAL, MEDICAL AND RESIDENTIAL BUILDINGS, TRASH AND REFUSE CONTAINERS, DRAIN LINES, OUTSIDE DRAINS, STATUARIES, COMPACTORS, OVERFLOW LINES, GREASE TRAPS, SEPTIC SYSTEMS, LOADING DOCKS, RENDERING VATS, ELEVATOR PITS, LIFT STATIONS, TROUGH DRAINS, VAULT TOILETS, SHOWERS, CERAMIC TILE FLOORS AND OTHER AREAS HAVING ORGANIC BUILD-UP (U.S. CLS. 1, 5, 6, 10, 26 AND 46).

FIRST USE 8-19-2002; IN COMMERCE 8-19-2002.

CLASS 3—COSMETICS AND CLEANING PREPARATIONS

FOR DRAIN CLEANERS (U.S. CLS. 1, 4, 6, 50, 51 AND 52).

FIRST USE 8-19-2002; IN COMMERCE 8-19-2002.
ESTHER BELENKER, EXAMINING ATTORNEY

SN 78-635,956. GILARDI MANAGEMENT SERVICES, L.L.C., COLUMBUS, OH. FILED 5-24-2005.

LIL' BITES

THE MARK CONSISTS OF STANDARD CHARACTERS WITHOUT CLAIM TO ANY PARTICULAR FONT, STYLE, SIZE, OR COLOR.

NO CLAIM IS MADE TO THE EXCLUSIVE RIGHT TO USE "BITES", APART FROM THE MARK AS SHOWN.

CLASS 29—MEATS AND PROCESSED FOODS

FOR FRUIT BASED SNACK BARS (U.S. CL. 46).

CLASS 30—STAPLE FOODS

FOR BAKERY GOODS, PIES, CAKES, CHEESECAKES, BROWNIES, COOKIES, FRUIT COBBLERS, PASTRIES (U.S. CL. 46).

SEAN CROWLEY, EXAMINING ATTORNEY

SN 78-639,271. BROOKS BUFORD INDUSTRIES, INC., NEW YORK, NY. FILED 5-27-2005.

BROOKS BUFORD

THE MARK CONSISTS OF STANDARD CHARACTERS WITHOUT CLAIM TO ANY PARTICULAR FONT, STYLE, SIZE, OR COLOR.

THE NAME(S), PORTRAIT(S), AND/OR SIGNATURE(S) SHOWN IN THE MARK IDENTIFIES JASON BROOKS, WHOSE CONSENT(S) TO REGISTER IS SUBMITTED.

CLASS 9—ELECTRICAL AND SCIENTIFIC APPARATUS

FOR PRE-RECORDED CDS, AUDIO TAPES AND DVDS FEATURING MUSIC AND MUSIC ENTERTAINMENT; DOWNLOADABLE RINGTONES, GRAPHICS AND MUSIC VIA GLOBAL COMPUTER NETWORK AND WIRELESS DEVICES (U.S. CLS. 21, 23, 26, 36 AND 38).

CLASS 16—PAPER GOODS AND PRINTED MATTER

FOR BOOKS AND MAGAZINES IN THE FIELD OF MUSIC ENTERTAINMENT; POSTERS; STICKERS; CONCERT TOUR PROGRAMS; AND CALENDARS (U.S. CLS. 2, 5, 22, 23, 29, 37, 38 AND 50).

CLASS 25—CLOTHING

FOR CLOTHING, NAMELY, TEE SHIRTS, TANK TOPS, POLO SHIRTS, DRESS SHIRTS, SUIT JACKETS, JACKETS, COATS, PANTS, WIND RESISTANT COATS, SHORT PANTS, SWEAT SUITS, SWEAT PANTS, SKIRTS, BLOUSES, UNDERGARMENTS, BELTS, WRISTBANDS, SHIRTS, CAPS, HATS, BANDANAS AND VISORS (U.S. CLS. 22 AND 39).

MARTHA FROMM, EXAMINING ATTORNEY

SN 78-639,974. THE JOHN ZIDIAN CO., INC., YOUNGSTOWN, OH. FILED 5-31-2005.

RESTAURANT COLLECTION

THE MARK CONSISTS OF STANDARD CHARACTERS WITHOUT CLAIM TO ANY PARTICULAR FONT, STYLE, SIZE, OR COLOR.

CLASS 29—MEATS AND PROCESSED FOODS

FOR OLIVE OIL; PEPPER OIL; SOUPS; CRANBERRY SAUCE; APPLESAUCE; CHEESE SPREADS; FRUIT-BASED SPREADS; GARLIC-BASED SPREADS; HAZEL-NUT SPREADS; MEAT-BASED SPREADS; VEGETABLE-BASED SPREADS; PROCESSED PIMENTO; FROZEN ENTREES CONSISTING PRIMARILY OF MEAT, FISH, POULTRY, OR VEGETABLES; CONDIMENTS, NAMELY, PROCESSED ONIONS, PROCESSED VEGETABLES, OLIVE OIL INFUSED WITH AND CONTAINING SPICES, PICKLED VEGETABLES, FRUIT-BASED SPREADS, VEGETABLE-BASED SPREADS, JELLY, VEGETABLE DIP, OLIVE PATE, ROASTED PEPPERS, PICKLED MEATS, PICKLED VEGETABLES, CHEESE POWDER, AND VEGETABLE PASTES (U.S. CL. 46).

CLASS 30—STAPLE FOODS

FOR PASTA; PASTA SAUCE; MARINADES; VINEGAR; SALAD DRESSING; SALSA; BARBEQUE SAUCE; STEAK SAUCE; FROZEN ENTREES CONSISTING PRIMARILY OF PASTA OR RICE; BRUSCHETTA; CONDIMENTS, NAMELY, SALT, PEPPER, KETCHUP, MUSTARDS, GARLIC SAUCES, PICKLE RELISH, SEASONINGS, DIPPING SAUCES, STEAK SAUCE, SPICES, HAM GLAZES, MEAT GLAZES, PASTRY GLAZES, HORSERADISH SAUCE, CHEESE SAUCES, MINCED GARLIC, SALAD DRESSINGS, PREPARED WASABI, WASABI POWDER, CHILI POWDER, CURRY POWDER, CINNAMON POWDER, HOT PEPPER POWDER, MUSTARD POWDER, BARBEQUE SAUCES, HOT SAUCE, HOLLANDAISE SAUCE, BERNAISE SAUCE, MAYONNAISE, GOURMET SAUCES, MARINADES, FRUIT SAUCES EXCLUDING CRANBERRY SAUCE AND APPLESAUCE, SOY SAUCE, TARTAR SAUCE, CHILI SAUCE, GARLIC SAUCE, TERIYAKI SAUCE, HOT SAUCE, SPREADS CONTAINING CHOCOLATE AND NUTS, PEANUT SAUCE, SEAFOOD COCKTAIL SAUCE, CAPERS, HONEY, AND SAUCES USED AS CONDIMENTS (U.S. CL. 46).

ELIZABETH HUGHITT, EXAMINING ATTORNEY

SN 78-642,204. AXEUS, INC., CARLSBAD, CA. FILED 6-2-2005.

SENTINEL

THE MARK CONSISTS OF STANDARD CHARACTERS WITHOUT CLAIM TO ANY PARTICULAR FONT, STYLE, SIZE, OR COLOR.

CLASS 9—ELECTRICAL AND SCIENTIFIC APPARATUS

FOR ELECTRONIC APPARATUS FOR THE DESTRUCTION OF DATA STORAGE DEVICES, NAMELY, CD ROMS AND COMPUTER DISKS (U.S. CLS. 21, 23, 26, 36 AND 38).

CLASS 16—PAPER GOODS AND PRINTED MATTER

FOR PAPER SHREDDERS. (U.S. CLS. 2, 5, 22, 23, 29, 37, 38 AND 50).

ANTHONY RINKER, EXAMINING ATTORNEY

SN 78-643,569. GUARDIAN FINANCIAL CORPORATION, OLATHE, KS. FILED 6-3-2005.



NO CLAIM IS MADE TO THE EXCLUSIVE RIGHT TO USE "REVENUE MANAGEMENT PARTNERS", APART FROM THE MARK AS SHOWN.

CLASS 35—ADVERTISING AND BUSINESS

FOR BUSINESS SERVICES; NAMELY, REVENUE MANAGEMENT, ACCOUNTS RECEIVABLE AND BILLING MANAGEMENT SERVICES (U.S. CLS. 100, 101 AND 102).

FIRST USE 2-15-2005; IN COMMERCE 2-15-2005.

CLASS 36—INSURANCE AND FINANCIAL

FOR DEBT RECOVERY AND COLLECTION SERVICES FOR BUSINESSES (U.S. CLS. 100, 101 AND 102).

FIRST USE 2-15-2005; IN COMMERCE 2-15-2005.

SUNG IN, EXAMINING ATTORNEY

SN 78-646,337. OWEN JONES & PARTNERS, LLC, PORTLAND, OR. FILED 6-8-2005.

SHOW, DON'T TELL

THE MARK CONSISTS OF STANDARD CHARACTERS WITHOUT CLAIM TO ANY PARTICULAR FONT, STYLE, SIZE, OR COLOR.

CLASS 35—ADVERTISING AND BUSINESS

FOR ADVERTISING AND PUBLICITY SERVICES, NAMELY, PROMOTING THE GOODS AND SERVICES OF OTHERS THROUGH PRINT, AUDIO AND VIDEO BROADCASTING, AND ONLINE MEDIA; IDENTITY DEVELOPMENT FOR OTHERS, NAMELY, ESTABLISHING NAME RECOGNITION, CORPORATE BRANDING, AND DEVELOPING DISTINCT AND IDENTIFIABLE CORPORATE LOGOS, LETTERHEAD AND TEMPLATES FOR OTHERS; CREATING AND UPDATING ADVERTISING MATERIALS, NAMELY, SALES MATERIALS, CATALOGS AND BROCHURES; DEVELOPING PROMOTIONAL CAMPAIGNS FOR OTHERS USING PRINT AND E-MAIL DISTRIBUTION CHANNELS (U.S. CLS. 100, 101 AND 102).

FIRST USE 5-3-2002; IN COMMERCE 5-3-2002.

CLASS 42—SCIENTIFIC, COMPUTER AND LEGAL SERVICES

FOR WEBSITE DEVELOPMENT FOR OTHERS TO ADVERTISE AND PROMOTE THEIR GOODS AND SERVICES AND DEVELOP THEIR IDENTITY TO ESTABLISH NAME RECOGNITION AND CORPORATE BRANDING (U.S. CLS. 100 AND 101).

FIRST USE 5-3-2002; IN COMMERCE 5-3-2002.

ANDREA SAUNDERS, EXAMINING ATTORNEY

SN 78-646,646. FERNBANK, INC., ATLANTA, GA. FILED 6-8-2005.

FERNBANK

THE MARK CONSISTS OF STANDARD CHARACTERS WITHOUT CLAIM TO ANY PARTICULAR FONT, STYLE, SIZE, OR COLOR.

CLASS 9—ELECTRICAL AND SCIENTIFIC APPARATUS

FOR DVDS AND MOTION PICTURE FILMS FEATURING ENTERTAINMENT, EDUCATIONAL AND DOCUMENTARY CONTENT RELATED TO SCIENCE, NATURE, AND NATURAL HISTORY; CDS AND AUDIO RECORDINGS FEATURING ENTERTAINMENT, EDUCATIONAL, AND DOCUMENTARY CONTENT RELATED TO SCIENCE, NATURE, AND NATURAL HISTORY; GRADUATED RULERS; DECORATIVE MAGNETS; MOUSEPADS (U.S. CLS. 21, 23, 26, 36 AND 38).
FIRST USE 10-0-1992; IN COMMERCE 10-0-1992.

CLASS 14—JEWELRY

FOR JEWELRY (U.S. CLS. 2, 27, 28 AND 50).
FIRST USE 10-0-1992; IN COMMERCE 10-0-1992.

CLASS 16—PAPER GOODS AND PRINTED MATTER

FOR BOOKS RELATED TO SCIENCE, NATURE, AND NATURAL HISTORY; STICKERS; BUMPER STICKERS; NEWSLETTERS, EVENT PROGRAMS, BROCHURES, PAMPHLETS, AND BOOKLETS RELATED TO SCIENCE, NATURE, NATURAL HISTORY, OR OTHERWISE FEATURING MUSEUM SERVICES, EVENTS, AND ACTIVITIES; PENS AND PENCILS; POSTCARDS; POSTERS; NOTE PADS; FABRIC GIFT BAGS (U.S. CLS. 2, 5, 22, 23, 29, 37, 38 AND 50).
FIRST USE 10-0-1992; IN COMMERCE 10-0-1992.

CLASS 18—LEATHER GOODS

FOR UMBRELLAS; TOTE BAGS (U.S. CLS. 1, 2, 3, 22 AND 41).
FIRST USE 11-0-1992; IN COMMERCE 11-0-1992.

CLASS 19—NON-METALLIC BUILDING MATERIALS

FOR DECORATIVE SOUVENIR STONES (U.S. CLS. 1, 12, 33 AND 50).
FIRST USE 1-0-2005; IN COMMERCE 1-0-2005.

CLASS 20—FURNITURE AND ARTICLES NOT OTHERWISE CLASSIFIED

FOR PLASTIC KEY CHAINS; PLASTIC PACKING CONTAINERS (U.S. CLS. 2, 13, 22, 25, 32 AND 50).
FIRST USE 10-0-1999; IN COMMERCE 10-0-1999.

CLASS 21—HOUSEWARES AND GLASS

FOR COFFEE MUGS; PLASTIC WATER BOTTLES SOLD EMPTY; COASTERS NOT OF PAPER AND NOT BEING TABLE LINEN (U.S. CLS. 2, 13, 23, 29, 30, 33, 40 AND 50).
FIRST USE 10-0-1992; IN COMMERCE 10-0-1992.

CLASS 25—CLOTHING

FOR CLOTHING, NAMELY SHIRTS, CAPS, JACKETS, SWEATSHIRTS (U.S. CLS. 22 AND 39).
FIRST USE 10-0-2002; IN COMMERCE 10-0-2002.

CLASS 26—FANCY GOODS

FOR EMBROIDERED PATCHES FOR CLOTHING (U.S. CLS. 37, 39, 40, 42 AND 50).
FIRST USE 12-0-2001; IN COMMERCE 12-0-2001.

CLASS 28—TOYS AND SPORTING GOODS

FOR PLAYING CARDS; STUFFED TOYS; CHRISTMAS TREE ORNAMENTS (U.S. CLS. 22, 23, 38 AND 50).
FIRST USE 5-0-2000; IN COMMERCE 5-0-2000.

CLASS 30—STAPLE FOODS

FOR CANDY (U.S. CL. 46).
FIRST USE 6-0-2004; IN COMMERCE 6-0-2004.

CLASS 35—ADVERTISING AND BUSINESS

FOR RETAIL AND ON-LINE GIFT SHOP SERVICES; PROVIDING INFORMATION REGARDING FOREST CONSERVATION AND CONSERVATION OF NATURAL RESOURCES (U.S. CLS. 100, 101 AND 102).
FIRST USE 11-0-1939; IN COMMERCE 11-0-1939.

CLASS 36—INSURANCE AND FINANCIAL

FOR CHARITABLE FUNDRAISING SERVICES (U.S. CLS. 100, 101 AND 102).
FIRST USE 11-0-1939; IN COMMERCE 11-0-1939.

CLASS 39—TRANSPORTATION AND STORAGE

FOR ARRANGING AND CONDUCTING EDUCATIONAL EXCURSIONS TO A VARIETY OF DESTINATIONS (U.S. CLS. 100 AND 105).
FIRST USE 5-0-1991; IN COMMERCE 5-0-1991.

CLASS 41—EDUCATION AND ENTERTAINMENT

FOR MUSEUM SERVICES; EDUCATIONAL SERVICES, NAMELY, CONDUCTING EXHIBITIONS, SEMINARS, LECTURES, DEMONSTRATIONS, CLASSES, WORKSHOPS AND COURSES IN THE FIELDS OF SCIENCE, NATURE, AND NATURAL HISTORY; SUMMER CAMP PROGRAMS WITH A WIDE RANGE OF EDUCATIONAL AND ENTERTAINMENT ACTIVITIES; ENTERTAINMENT SERVICES, NAMELY, EXHIBITION OF MOVIES, CONDUCTING PARTIES, ORGANIZING EXHIBITIONS FOR ENTERTAINMENT PURPOSES; PROVIDING FACILITIES FOR EDUCATIONAL, ENTERTAINMENT, AND RECREATIONAL ACTIVITIES; RENTAL OF MUSEUM AND ENTERTAINMENT FACILITIES (U.S. CLS. 100, 101 AND 107).
FIRST USE 12-0-1941; IN COMMERCE 12-0-1941.

CLASS 43—HOTEL AND RESTAURANT SERVICES

FOR PROVISION OF CONFERENCE AND MEETING FACILITIES; RESTAURANT SERVICES; PROVIDING OF FOOD AND DRINK FOR PATRONS AND GUESTS; PROVIDING FACILITIES FOR MEETINGS (U.S. CLS. 100 AND 101).
FIRST USE 10-0-1992; IN COMMERCE 10-0-1992.
YONG KIM, EXAMINING ATTORNEY

SN 78-647,267. SODALICIOUS SKATEBOARDING COMPANY, ST. PAUL, MN. FILED 6-9-2005.

SODALICIOUS SKATEBOARDING
COMPANY

THE MARK CONSISTS OF STANDARD CHARACTERS WITHOUT CLAIM TO ANY PARTICULAR FONT, STYLE, SIZE, OR COLOR.

NO CLAIM IS MADE TO THE EXCLUSIVE RIGHT TO USE "SKATEBOARDING COMPANY", APART FROM THE MARK AS SHOWN.

CLASS 25—CLOTHING

FOR CLOTHING, NAMELY, HATS, JACKETS, T-SHIRTS, SHIRTS, SHORTS, PANTS AND SHOES (U.S. CLS. 22 AND 39).

FIRST USE 7-1-1998; IN COMMERCE 3-1-2000.

CLASS 28—TOYS AND SPORTING GOODS

FOR SKATEBOARDS (U.S. CLS. 22, 23, 38 AND 50).

FIRST USE 7-1-1998; IN COMMERCE 3-1-2000.

STEPHANIE DAVIS, EXAMINING ATTORNEY

SN 78-647,268. JENNIFER LIPPMAN DESIGN, LLC, NEW YORK, NY. FILED 6-9-2005.

KNOWKNITS

THE MARK CONSISTS OF STANDARD CHARACTERS WITHOUT CLAIM TO ANY PARTICULAR FONT, STYLE, SIZE, OR COLOR.

CLASS 16—PAPER GOODS AND PRINTED MATTER

FOR KNITTING PATTERNS (U.S. CLS. 2, 5, 22, 23, 29, 37, 38 AND 50).

FIRST USE 6-0-2005; IN COMMERCE 6-0-2005.

CLASS 23—YARNS AND THREADS

FOR KNITTING POUCHES, NAMELY, FUNCTIONAL SACKS FOR HOLDING YARN DURING KNITTING (U.S. CL. 43).

FIRST USE 6-0-2005; IN COMMERCE 6-0-2005.

STEPHANIE DAVIS, EXAMINING ATTORNEY

SN 78-647,543. FERNBANK, INC., ATLANTA, GA. FILED 6-9-2005.

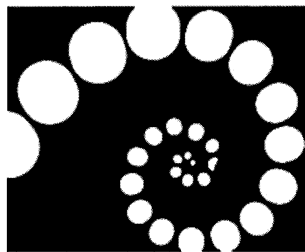
**CLASS 9—ELECTRICAL AND SCIENTIFIC APPARATUS**

FOR DVDS AND MOTION PICTURE FILMS FEATURING ENTERTAINMENT, EDUCATIONAL AND DOCUMENTARY CONTENT RELATED TO SCIENCE, NATURE, AND NATURAL HISTORY; CDS AND AUDIO RECORDINGS FEATURING ENTERTAINMENT, EDUCATIONAL, AND DOCUMENTARY CONTENT RELATED TO SCIENCE, NATURE, AND NATURAL HISTORY; GRADUATED RULERS; DECORATIVE MAGNETS; MOUSEPADS (U.S. CLS. 21, 23, 26, 36 AND 38).

FIRST USE 10-0-1992; IN COMMERCE 10-0-1992.

CLASS 14—JEWELRY

FOR JEWELRY (U.S. CLS. 2, 27, 28 AND 50).

FIRST USE 10-0-1992; IN COMMERCE 10-0-1992.

CLASS 16—PAPER GOODS AND PRINTED MATTER

FOR BOOKS RELATED TO SCIENCE, NATURE, AND NATURAL HISTORY; STICKERS; BUMPER STICKERS; NEWSLETTERS, EVENT PROGRAMS, BROCHURES, PAMPHLETS, AND BOOKLETS RELATED TO SCIENCE, NATURE, NATURAL HISTORY, OR OTHERWISE FEATURING MUSEUM SERVICES, EVENTS, AND ACTIVITIES; PENS AND PENCILS; POSTCARDS; POSTERS; NOTE PADS; FABRIC GIFT BAGS (U.S. CLS. 2, 5, 22, 23, 29, 37, 38 AND 50).

FIRST USE 10-0-1992; IN COMMERCE 10-0-1992.

CLASS 18—LEATHER GOODS

FOR UMBRELLAS; TOTE BAGS (U.S. CLS. 1, 2, 3, 22 AND 41).

FIRST USE 11-0-1992; IN COMMERCE 11-0-1992.

CLASS 19—NON-METALLIC BUILDING MATERIALS

FOR DECORATIVE SOUVENIR STONES (U.S. CLS. 1, 12, 33 AND 50).

FIRST USE 1-0-2005; IN COMMERCE 1-0-2005.

CLASS 20—FURNITURE AND ARTICLES NOT OTHERWISE CLASSIFIED

FOR PLASTIC KEY CHAINS; PLASTIC PACKING CONTAINERS (U.S. CLS. 2, 13, 22, 25, 32 AND 50).

FIRST USE 10-0-1999; IN COMMERCE 10-0-1999.

CLASS 21—HOUSEWARES AND GLASS

FOR COFFEE MUGS; PLASTIC WATER BOTTLES SOLD EMPTY; COASTERS NOT OF PAPER AND NOT BEING TABLE LINEN (U.S. CLS. 2, 13, 23, 29, 30, 33, 40 AND 50).

FIRST USE 10-0-1992; IN COMMERCE 10-0-1992.

CLASS 25—CLOTHING

FOR CLOTHING, NAMELY SHIRTS, CAPS, JACKETS (U.S. CLS. 22 AND 39).

FIRST USE 10-0-2002; IN COMMERCE 10-0-2002.

CLASS 28—TOYS AND SPORTING GOODS

FOR PLAYING CARDS; CHRISTMAS TREE ORNAMENTS (U.S. CLS. 22, 23, 38 AND 50).

FIRST USE 5-0-2000; IN COMMERCE 5-0-2000.

CLASS 30—STAPLE FOODS

FOR CANDY (U.S. CL. 46).

FIRST USE 6-0-2004; IN COMMERCE 6-0-2004.

CLASS 35—ADVERTISING AND BUSINESS

FOR RETAIL AND ON-LINE GIFT SHOP SERVICES; PROVIDING INFORMATION REGARDING FOREST CONSERVATION AND CONSERVATION OF NATURAL RESOURCES (U.S. CLS. 100, 101 AND 102).

FIRST USE 5-0-1991; IN COMMERCE 5-0-1991.

CLASS 36—INSURANCE AND FINANCIAL

FOR CHARITABLE FUNDRAISING SERVICES (U.S. CLS. 100, 101 AND 102).

FIRST USE 5-0-1991; IN COMMERCE 5-0-1991.

CLASS 39—TRANSPORTATION AND STORAGE

SN 78-647,821. CARTESIS, PARIS, FRANCE, FILED 6-10-2005.

FOR ARRANGING AND CONDUCTING EDUCATIONAL EXCURSIONS TO A VARIETY OF DESTINATIONS (U.S. CLS. 100 AND 105).

FIRST USE 5-0-1991; IN COMMERCE 5-0-1991.

CLASS 41—EDUCATION AND ENTERTAINMENT

FOR MUSEUM SERVICES; EDUCATIONAL SERVICES, NAMELY, CONDUCTING EXHIBITIONS, SEMINARS, LECTURES, DEMONSTRATIONS, CLASSES, WORKSHOPS AND COURSES IN THE FIELDS OF SCIENCE, NATURE, AND NATURAL HISTORY; SUMMER CAMP PROGRAMS WITH A WIDE RANGE OF EDUCATIONAL AND ENTERTAINMENT ACTIVITIES; ENTERTAINMENT SERVICES, NAMELY, EXHIBITION OF MOVIES, CONDUCTING PARTIES, ORGANIZING EXHIBITIONS FOR ENTERTAINMENT PURPOSES; PROVIDING FACILITIES FOR EDUCATIONAL, ENTERTAINMENT, AND RECREATIONAL ACTIVITIES; RENTAL OF MUSEUM AND ENTERTAINMENT FACILITIES (U.S. CLS. 100, 101 AND 107).

FIRST USE 10-0-1992; IN COMMERCE 10-0-1992.

CLASS 43—HOTEL AND RESTAURANT SERVICES

FOR PROVISION OF CONFERENCE AND MEETING FACILITIES; RESTAURANT SERVICES; PROVIDING OF FOOD AND DRINK FOR PATRONS AND GUESTS; PROVIDING FACILITIES FOR MEETINGS (U.S. CLS. 100 AND 101).

FIRST USE 10-0-1992; IN COMMERCE 10-0-1992.
YONG KIM, EXAMINING ATTORNEY

SN 78-647,810. THE DAYTONA PIG STAND, INC., MAITLAND, FL. FILED 6-10-2005.

HOME OF THE PORK CHOPPER

THE MARK CONSISTS OF STANDARD CHARACTERS WITHOUT CLAIM TO ANY PARTICULAR FONT, STYLE, SIZE, OR COLOR.

CLASS 25—CLOTHING

FOR CLOTHING, NAMELY, T-SHIRTS, SWEATSHIRTS, SWEATPANTS, JACKETS, HATS, SCARVES, AND BANDANNAS (U.S. CLS. 22 AND 39).

CLASS 43—HOTEL AND RESTAURANT SERVICES

FOR RESTAURANT SERVICES; TAKE-OUT FOOD SERVICES (U.S. CLS. 100 AND 101).
RONALD AIKENS, EXAMINING ATTORNEY

CARTESIS GREAT
PERFORMANCES START WITH
CONFIDENCE

THE MARK CONSISTS OF STANDARD CHARACTERS WITHOUT CLAIM TO ANY PARTICULAR FONT, STYLE, SIZE, OR COLOR.

OWNER OF U.S. REG. NOS. 2,504,886, 2,665,351 AND 2,785,671.

CLASS 9—ELECTRICAL AND SCIENTIFIC APPARATUS

FOR COMPUTER SOFTWARE PROGRAMS, NAMELY COMPUTER SOFTWARE PROGRAMS FOR USE IN INTERFACING WITH OTHER COMPUTER PROGRAMS AND PLATFORMS TO ACCESS AND INTEGRATE DATA, AND FOR USE IN RETRIEVING, REPORTING, SUMMARIZING AND CONSOLIDATING DATA, BUSINESS MANAGEMENT, GOVERNMENT REGULATORY COMPLIANCE REPORTING, BUDGETING, ANALYZING MARKETS AND MARKET TRENDS, FORECASTING, PLANNING, AND PERFORMANCE ANALYSIS (U.S. CLS. 21, 23, 26, 36 AND 38).

FIRST USE 1-31-2005; IN COMMERCE 1-31-2005.

CLASS 35—ADVERTISING AND BUSINESS

FOR BUSINESS MANAGEMENT CONSULTING; COMPUTER FILE MANAGEMENT, NAMELY COMPUTERIZED DATABASE MANAGEMENT SERVICES; COMPUTER SYSTEM SUPPORT SERVICES TO FACILITATE THE ASSESSING OF PERFORMANCE, GOVERNMENTAL REPORTING, FORECASTING, BUDGETING, RESOURCE ALLOCATION, AND THE RETRIEVAL, SUMMARIZING, CONSOLIDATION AND REPORTING OF DATA (U.S. CLS. 100, 101 AND 102).

FIRST USE 1-31-2005; IN COMMERCE 1-31-2005.

CLASS 38—COMMUNICATION

FOR TELECOMMUNICATIONS SERVICES, NAMELY PROVIDING ACCESS TO A GLOBAL COMPUTER NETWORK TO FACILITATE THE TRANSMISSION OF DATA, MESSAGES, DOCUMENTS AND IMAGES (U.S. CLS. 100, 101 AND 104).

FIRST USE 1-31-2005; IN COMMERCE 1-31-2005.

CLASS 42—SCIENTIFIC, COMPUTER AND LEGAL SERVICES

FOR COMPUTER HARDWARE AND SOFTWARE DESIGN AND DEVELOPMENT FOR OTHERS; LEGAL SERVICES; ANALYSES OF COMPUTER HARDWARE AND COMPUTER SOFTWARE; COMPUTER SYSTEMS DESIGN FOR OTHERS; COMPUTER CODE CONVERSION AND DATA RETRIEVAL FOR OTHERS; COMPUTER PROGRAMMING FOR OTHERS; TECHNICAL RESEARCH IN THE FIELDS OF COMPUTERS, BUDGETING, FORECASTING MARKET TRENDS, PLANNING, AND ORGANIZATIONAL PERFORMANCE; SOFTWARE INSTALLATION; LEGAL RESEARCH; RENTAL OF COMPUTER SOFTWARE; MAINTENANCE OF COMPUTER SOFTWARE; DATABASE RECONSTRUCTION SERVICES, NAMELY THE RETRIEVAL OF LOST OR INACCESSIBLE DATA THROUGH RESEARCH, COMPUTER HARDWARE CONFIGURATION AND COMPUTER SOFTWARE PROGRAMMING (U.S. CLS. 100 AND 101).

FIRST USE 1-31-2005; IN COMMERCE 1-31-2005.
RONALD AIKENS, EXAMINING ATTORNEY

SN 78-647,955. BERGER BROS. CO., FEASTERVILLE, PA.
FILED 6-10-2005.

SN 78-649,667. FERNBANK, INC., ATLANTA, GA. FILED 6-13-2005.

BERGER

FERNBANK MUSEUM OF NATURAL
HISTORY

THE MARK CONSISTS OF STANDARD CHARACTERS WITHOUT CLAIM TO ANY PARTICULAR FONT, STYLE, SIZE, OR COLOR.
SEC. 2(F).

CLASS 6—METAL GOODS

FOR METAL BUILDING MATERIALS, NAMELY, SNOW RETENTION APPARATUS CONSISTING OF SNOWBARS, SNOW FENCES AND SNOW RAILS FOR ROOFS; SOFFITS, TRIM, FLASHING, VENTILATION PANELS, VENTS, DRAINS, ROOF DRAINAGE PIPES AND TUBES, ROOF SUPPORTS, ROOF ANCHORS (U.S. CLS. 2, 12, 13, 14, 23, 25 AND 50).

FIRST USE 12-31-2004; IN COMMERCE 12-31-2004.

CLASS 19—NON-METALLIC BUILDING MATERIALS

FOR NON-METAL ROOF COVERINGS IN THE NATURE OF ROOF UNDERLAYMENT AND NON-METAL BUILDING MATERIALS, NAMELY, SNOW RETENTION APPARATUS CONSISTING OF SNOW BARS, SNOW FENCES AND SNOW RAILS FOR ROOFS; SOFFITS, TRIM, FLASHING, VENTILATION PANELS, VENTS, DRAINS, ROOF DRAINAGE TUBES AND PIPES, ROOF SUPPORTS, AND ROOF ANCHORS (U.S. CLS. 1, 12, 33 AND 50).

FIRST USE 12-31-2004; IN COMMERCE 12-31-2004.
BARBARA BROWN, EXAMINING ATTORNEY

SN 78-648,419. DWA RISK MANAGEMENT SOLUTIONS, LLC, LEXINGTON, MA. FILED 6-10-2005.



CLASS 35—ADVERTISING AND BUSINESS

FOR BUSINESS ADVISORY SERVICES, NAMELY, INFORMATION, ADVISORY AND CONSULTANCY SERVICES RELATING TO MODEL ADMINISTRATION AND BUSINESS MANAGEMENT POLICIES AND RESOURCES FOR NONPROFIT ORGANIZATIONS, ALL OF THE FOREGOING SERVICES ALSO PROVIDED VIA THE INTERNET (U.S. CLS. 100, 101 AND 102).

CLASS 36—INSURANCE AND FINANCIAL

FOR RISK MANAGEMENT INFORMATION, ADVISORY AND CONSULTANCY SERVICES FOR NONPROFIT ORGANIZATIONS PROVIDED VIA THE INTERNET (U.S. CLS. 100, 101 AND 102).

TASNEEM HUSSAIN, EXAMINING ATTORNEY

THE MARK CONSISTS OF STANDARD CHARACTERS WITHOUT CLAIM TO ANY PARTICULAR FONT, STYLE, SIZE, OR COLOR.

NO CLAIM IS MADE TO THE EXCLUSIVE RIGHT TO USE MUSEUM OF NATURAL HISTORY AS TO THE SERVICES IN CLASS 41 AND NATURAL HISTORY AS TO THOSE GOODS AND SERVICES IN CLASSES 9, 16, 35, 36, AND 39 AS SHOWN., APART FROM THE MARK AS SHOWN.

CLASS 9—ELECTRICAL AND SCIENTIFIC APPARATUS

FOR DVDS AND MOTION PICTURE FILMS FEATURING ENTERTAINMENT, EDUCATIONAL AND DOCUMENTARY CONTENT RELATED TO SCIENCE, NATURE, AND NATURAL HISTORY; CDS AND AUDIO RECORDINGS FEATURING ENTERTAINMENT, EDUCATIONAL, AND DOCUMENTARY CONTENT RELATED TO SCIENCE, NATURE, AND NATURAL HISTORY; GRADUATED RULERS; DECORATIVE MAGNETS; MOUSEPADS (U.S. CLS. 21, 23, 26, 36 AND 38).

FIRST USE 10-0-1992; IN COMMERCE 10-0-1992.

CLASS 16—PAPER GOODS AND PRINTED MATTER

FOR BOOKS RELATED TO SCIENCE, NATURE, AND NATURAL HISTORY; STICKERS; BUMPER STICKERS; NEWSLETTERS, EVENT PROGRAMS, BROCHURES, PAMPHLETS, AND BOOKLETS RELATED TO SCIENCE, NATURE, NATURAL HISTORY, OR OTHERWISE FEATURING MUSEUM SERVICES, EVENTS, AND ACTIVITIES; PENS AND PENCILS; POSTCARDS; POSTERS; NOTE PADS; FABRIC GIFT BAGS (U.S. CLS. 2, 5, 22, 23, 29, 37, 38 AND 50).

FIRST USE 10-0-1992; IN COMMERCE 10-0-1992.

CLASS 18—LEATHER GOODS

FOR UMBRELLAS; TOTE BAGS (U.S. CLS. 1, 2, 3, 22 AND 41).

FIRST USE 11-0-1992; IN COMMERCE 11-0-1992.

CLASS 20—FURNITURE AND ARTICLES NOT OTHERWISE CLASSIFIED

FOR PLASTIC KEY CHAINS; PLASTIC PACKING CONTAINERS (U.S. CLS. 2, 13, 22, 25, 32 AND 50).

FIRST USE 10-0-1999; IN COMMERCE 10-0-1999.

CLASS 21—HOUSEWARES AND GLASS

FOR COFFEE MUGS; PLASTIC WATER BOTTLES SOLD EMPTY; COASTERS NOT OF PAPER AND NOT BEING TABLE LINEN (U.S. CLS. 2, 13, 23, 29, 30, 33, 40 AND 50).

FIRST USE 10-0-1992; IN COMMERCE 10-0-1992.

CLASS 25—CLOTHING

FOR CLOTHING, NAMELY, SHIRTS AND CAPS (U.S. CLS. 22 AND 39).

FIRST USE 10-0-2002; IN COMMERCE 10-0-2002.

CLASS 28—TOYS AND SPORTING GOODS

FOR PLAYING CARDS; CHRISTMAS TREE ORNAMENTS (U.S. CLS. 22, 23, 38 AND 50).
FIRST USE 5-0-2000; IN COMMERCE 5-0-2000.

SN 78-650,387. ULTRASCALE AIRCRAFT, INC., YONKERS, NY. FILED 6-14-2005.

CLASS 30—STAPLE FOODS

FOR CANDY (U.S. CL. 46).
FIRST USE 6-0-2004; IN COMMERCE 6-0-2004.

CLASS 35—ADVERTISING AND BUSINESS

FOR RETAIL AND ON-LINE GIFT SHOP SERVICES; PROVIDING INFORMATION REGARDING FOREST CONSERVATION AND CONSERVATION OF NATURAL RESOURCES (U.S. CLS. 100, 101 AND 102).
FIRST USE 5-0-1991; IN COMMERCE 5-0-1991.



NO CLAIM IS MADE TO THE EXCLUSIVE RIGHT TO USE "SCALE AIRCRAFT, INC.", APART FROM THE MARK AS SHOWN.

THE MARK CONSISTS OF A HIGHLY STYLIZED AND FANCIFUL REPRESENTATION OF AN AIRPLANE AND THE WORDS ULTRA SCALE AIRCRAFT, INC.

CLASS 36—INSURANCE AND FINANCIAL

FOR CHARITABLE FUNDRAISING SERVICES (U.S. CLS. 100, 101 AND 102).
FIRST USE 12-0-1985; IN COMMERCE 12-0-1985.

CLASS 9—ELECTRICAL AND SCIENTIFIC APPARATUS

FOR PRERECORDED AUDIO CASSETTE TAPES, VIDEO TAPES, CD'S AND DVD'S FEATURING INFORMATION IN THE FIELD OF HISTORICALLY ACCURATE SCALE MODELS OF MILITARY AIRCRAFT, LAND VEHICLES, FIGURES AND WEAPONS; DOWNLOADABLE ELECTRONIC PUBLICATIONS, NAMELY, MAGAZINES AND NEWSLETTERS IN THE FIELD OF HISTORICALLY ACCURATE SCALE MODELS OF MILITARY AIRCRAFT, LAND VEHICLES, FIGURES AND WEAPONS; ELECTRONIC PUBLICATIONS, NAMELY, MAGAZINES AND NEWSLETTERS IN THE FIELD OF HISTORICALLY ACCURATE SCALE MODELS OF MILITARY AIRCRAFT, LAND VEHICLES, FIGURES AND WEAPONS RECORDED ON COMPUTER MEDIA (U.S. CLS. 21, 23, 26, 36 AND 38).

CLASS 39—TRANSPORTATION AND STORAGE

FOR ARRANGING AND CONDUCTING EDUCATIONAL EXCURSIONS TO A VARIETY OF DESTINATIONS (U.S. CLS. 100 AND 105).
FIRST USE 5-0-1991; IN COMMERCE 5-0-1991.

CLASS 16—PAPER GOODS AND PRINTED MATTER

FOR BOOKS IN THE FIELD OF HISTORICALLY ACCURATE SCALE MODELS OF MILITARY AIRCRAFT, LAND VEHICLES, FIGURES AND WEAPONS; PRINTED PUBLICATIONS, NAMELY, MAGAZINES AND NEWSLETTERS IN THE FIELD OF HISTORICALLY ACCURATE SCALE MODELS OF MILITARY AIRCRAFT, LAND VEHICLES, FIGURES AND WEAPONS (U.S. CLS. 2, 5, 22, 23, 29, 37, 38 AND 50).

CLASS 41—EDUCATION AND ENTERTAINMENT

FOR MUSEUM SERVICES; EDUCATIONAL SERVICES, NAMELY, CONDUCTING EXHIBITIONS, SEMINARS, LECTURES, DEMONSTRATIONS, CLASSES, WORKSHOPS AND COURSES IN THE FIELD OF SCIENCE, NATURE, AND NATURAL HISTORY; SUMMER CAMP PROGRAMS WITH A WIDE RANGE OF EDUCATIONAL AND ENTERTAINMENT ACTIVITIES; ENTERTAINMENT SERVICES, NAMELY, EXHIBITION OF MOVIES, CONDUCTING PARTIES, ORGANIZING EXHIBITIONS FOR ENTERTAINMENT PURPOSES; PROVIDING FACILITIES FOR RECREATIONAL ACTIVITIES; RENTAL OF MUSEUM AND ENTERTAINMENT FACILITIES (U.S. CLS. 100, 101 AND 107).
FIRST USE 10-0-1992; IN COMMERCE 10-0-1992.

CLASS 28—TOYS AND SPORTING GOODS

FOR HISTORICALLY ACCURATE SCALE MODELS OF MILITARY AIRCRAFT, LAND VEHICLES, FIGURES, WEAPONS AND RELATED ACCESSORIES PROVIDED TOGETHER THEREWITH AS A UNIT (U.S. CLS. 22, 23, 38 AND 50).

CLASS 43—HOTEL AND RESTAURANT SERVICES

FOR RESTAURANT SERVICES; PROVIDING OF FOOD AND DRINK FOR PATRONS AND GUESTS (U.S. CLS. 100 AND 101).
FIRST USE 10-0-1992; IN COMMERCE 10-0-1992.
YONG KIM, EXAMINING ATTORNEY

CLASS 41—EDUCATION AND ENTERTAINMENT

FOR PROVIDING ONLINE NONDOWNLOADABLE MAGAZINES AND NEWSLETTERS IN THE FIELD OF HISTORICALLY ACCURATE SCALE MODELS OF MILITARY AIRCRAFT, LAND VEHICLES, FIGURES AND WEAPONS (U.S. CLS. 100, 101 AND 107).
JOHN DWYER, EXAMINING ATTORNEY

SN 78-651,270. BRODSKY SOUTH, LP, WICHITA FALLS, TX.
FILED 6-15-2005.

WICHITA FALLS WILDCATS

THE MARK CONSISTS OF STANDARD CHARACTERS WITHOUT CLAIM TO ANY PARTICULAR FONT, STYLE, SIZE, OR COLOR.

NO CLAIM IS MADE TO THE EXCLUSIVE RIGHT TO USE WICHITA FALLS, APART FROM THE MARK AS SHOWN.

CLASS 25—CLOTHING

FOR CLOTHING, NAMELY, COATS, PAJAMAS, JACKETS, SWEATPANTS, ROBES, TANK TOPS, SOCKS, UNDERWEAR, TIES, BELTS, SCARVES; SHIRTS, T-SHIRTS, SWEATSHIRTS, GOLF SHIRTS, SWEATERS; HEADGEAR, NAMELY, CAPS AND HATS (U.S. CLS. 22 AND 39).

FIRST USE 9-1-1995; IN COMMERCE 9-1-1995.

CLASS 28—TOYS AND SPORTING GOODS

FOR TOY NOISE MAKERS, NAMELY, HAND CLAPPERS; SPORTS EQUIPMENT, NAMELY, BAGS SPECIALLY ADAPTED TO SPORTS EQUIPMENT; GOLF BALLS; TEES; DIVOT REPAIR TOOLS; HOCKEY PUCKS; SOUVENIRS, NAMELY, PUCKS AND MINISIZED HOCKEY STICKS AND HOCKEY GOALS (U.S. CLS. 22, 23, 38 AND 50).

FIRST USE 9-1-1995; IN COMMERCE 9-1-1995.

CLASS 41—EDUCATION AND ENTERTAINMENT

FOR PROVIDING ENTERTAINMENT AND AMUSEMENT THROUGH THE MEDIUM OF HOCKEY GAMES; HOCKEY CLUB SERVICES; ORGANIZING COMMUNITY SPORTS EVENTS; CONDUCTING SPORTS EXHIBITIONS (U.S. CLS. 100, 101 AND 107).

FIRST USE 9-1-1995; IN COMMERCE 9-1-1995.

CYNTHIA SLOAN, EXAMINING ATTORNEY

SN 78-652,267. NETCLUB INC., LONGUEUIL, QUEBEC, CANADA, FILED 6-16-2005.

UNYK

THE MARK CONSISTS OF STANDARD CHARACTERS WITHOUT CLAIM TO ANY PARTICULAR FONT, STYLE, SIZE, OR COLOR.

PRIORITY CLAIMED UNDER SEC. 44(D) ON CANADA APPLICATION NO. 1260769, FILED 6-10-2005, REG. NO. TMA668243, DATED 7-19-2006, EXPIRES 7-19-2021.

CLASS 35—ADVERTISING AND BUSINESS

FOR MANAGEMENT AND COMPILATION OF COMPUTER DATABASES; ADVERTISING, ADVERTISEMENT SERVICES, PUBLICITY SERVICES, ADVERTISING AND COMMERCIAL INFORMATION SERVICES VIA THE INTERNET, ADVERTISING VIA ELECTRONIC MEDIA AND SPECIFICALLY THE INTERNET, PROVISION OF ADVERTISING SPACE BY ELECTRONIC MEANS AND GLOBAL INFORMATION NETWORKS, RENTAL OF ADVERTISING SPACE AND DISSEMINATION OF ADVERTISING FOR OTHERS VIA THE INTERNET; PUBLIC RELATIONS (U.S. CLS. 100, 101 AND 102).

CLASS 38—COMMUNICATION

FOR COMMUNICATIONS BY COMPUTER TERMINALS AND VIA FIBRE OPTICAL NETWORKS; AUDIO AND VIDEO TELECONFERENCING SERVICES; ELECTRONIC MESSAGING SERVICES (U.S. CLS. 100, 101 AND 104).

CLASS 42—SCIENTIFIC, COMPUTER AND LEGAL SERVICES

FOR COMPUTER SOFTWARE DESIGN, COMPUTER PROGRAMMING AND MAINTENANCE OF COMPUTER SOFTWARE FOR OTHERS; INSTALLATION OF COMPUTER SOFTWARE; DEVELOPMENT, UPDATING AND MAINTENANCE OF SOFTWARE AND DATABASES, LEASING OF COMPUTER SOFTWARE; COMPUTER SERVICES, NAMELY, ACTING AS AN APPLICATION SERVICE PROVIDER IN THE FIELD OF KNOWLEDGE MANAGEMENT TO HOST COMPUTER APPLICATION SOFTWARE FOR SEARCHING AND RETRIEVING INFORMATION FROM DATABASES AND COMPUTER NETWORKS (U.S. CLS. 100 AND 101).

MATTHEW MCDOWELL, EXAMINING ATTORNEY

SN 78-652,317. NETCLUB INC., LONGUEUIL, QUEBEC, CANADA, FILED 6-16-2005.



PRIORITY CLAIMED UNDER SEC. 44(D) ON CANADA APPLICATION NO. 1260770, FILED 6-10-2005, REG. NO. TMA668245, DATED 7-19-2006, EXPIRES 7-19-2021.

THE MARK CONSISTS OF THE LETTERS "UNYK" WHERE THE "Y" IS FORMED BY A STYLIZED HUMAN SILHOUETTE.

CLASS 35—ADVERTISING AND BUSINESS

FOR MANAGEMENT AND COMPILATION OF COMPUTER DATABASES; ADVERTISING, ADVERTISEMENT SERVICES, PUBLICITY SERVICES, ADVERTISING AND COMMERCIAL INFORMATION SERVICES VIA THE INTERNET, ADVERTISING VIA ELECTRONIC MEDIA AND SPECIFICALLY THE INTERNET, PROVISION OF ADVERTISING SPACE BY ELECTRONIC MEANS AND GLOBAL INFORMATION NETWORKS, RENTAL OF ADVERTISING SPACE AND DISSEMINATION OF ADVERTISING FOR OTHERS VIA THE INTERNET; PUBLIC RELATIONS (U.S. CLS. 100, 101 AND 102).

CLASS 38—COMMUNICATION

FOR COMMUNICATIONS BY COMPUTER TERMINALS AND VIA FIBRE OPTICAL NETWORKS; AUDIO AND VIDEO TELECONFERENCING SERVICES; ELECTRONIC MESSAGING SERVICES (U.S. CLS. 100, 101 AND 104).

CLASS 42—SCIENTIFIC, COMPUTER AND LEGAL SERVICES

FOR COMPUTER SOFTWARE DESIGN, COMPUTER PROGRAMMING AND MAINTENANCE OF COMPUTER SOFTWARE FOR OTHERS; INSTALLATION OF COMPUTER SOFTWARE; DEVELOPMENT, UPDATING AND MAINTENANCE OF SOFTWARE AND DATABASES, LEASING OF COMPUTER SOFTWARE; COMPUTER SERVICES, NAMELY, ACTING AS AN APPLICATION SERVICE PROVIDER IN THE FIELD OF KNOWLEDGE MANAGEMENT TO HOST COMPUTER APPLICATION SOFTWARE FOR SEARCHING AND RETRIEVING INFORMATION FROM DATABASES AND COMPUTER NETWORKS (U.S. CLS. 100 AND 101).

MATTHEW MCDOWELL, EXAMINING ATTORNEY

SN 78-653,912. WASHINGTONPOST.NEWSWEEK INTERACTIVE COMPANY, LLC, ARLINGTON, VA. FILED 6-20-2005.

GOT PLANS?

THE MARK CONSISTS OF STANDARD CHARACTERS WITHOUT CLAIM TO ANY PARTICULAR FONT, STYLE, SIZE, OR COLOR.

CLASS 38—COMMUNICATION

FOR PROVIDING AN ONLINE ELECTRONIC BULLETIN/MESSAGE BOARD FOR TRANSMISSION OF MESSAGES AMONG COMPUTER USERS IN THE FIELDS OF ENTERTAINMENT, RECREATION, AND LEISURE; PROVIDING ONLINE FORUMS FOR TRANSMISSION OF MESSAGES AMONG COMPUTER USERS IN THE FIELDS OF ENTERTAINMENT, RECREATION, AND LEISURE (U.S. CLS. 100, 101 AND 104).

FIRST USE 2-8-2001; IN COMMERCE 2-8-2001.

CLASS 41—EDUCATION AND ENTERTAINMENT

FOR PROVIDING INFORMATION IN THE FIELD OF ENTERTAINMENT, RECREATION, AND LEISURE; PROVIDING ON-LINE WEBSITES FEATURING INFORMATION IN THE FIELD OF ENTERTAINMENT, RECREATION, AND LEISURE (U.S. CLS. 100, 101 AND 107).

FIRST USE 2-8-2001; IN COMMERCE 2-8-2001.
MELISSA VALLILLO, EXAMINING ATTORNEY

SN 78-656,638. FRANK BRUNCKHORST CO., L.L.C., BROOKLYN, NY. FILED 6-23-2005.

WILD BOAR

THE MARK CONSISTS OF STANDARD CHARACTERS WITHOUT CLAIM TO ANY PARTICULAR FONT, STYLE, SIZE, OR COLOR.

OWNER OF U.S. REG. NOS. 1,789,549, 3,030,744 AND OTHERS.

CLASS 29—MEATS AND PROCESSED FOODS

FOR PROCESSED MEATS NOT MADE IN WHOLE OR IN PART FROM BOAR OR WILD BOAR; CHEESES; CONDIMENTS, NAMELY, PICKLES, SAUERKRAUT, AND PROCESSED ONIONS (U.S. CL. 46).

CLASS 30—STAPLE FOODS

FOR PREPARED FOODS, NAMELY, SANDWICHES NOT MADE IN WHOLE OR IN PART FROM BOAR OR WILD BOAR; KETCHUP; MUSTARD; SAUCES (U.S. CL. 46).

JENNIFER KRISP, EXAMINING ATTORNEY

SN 78-657,286. THE MAVEN GROUP, BETHESDA, MD. FILED 6-23-2005.

THE MAVEN GROUP

THE MARK CONSISTS OF STANDARD CHARACTERS WITHOUT CLAIM TO ANY PARTICULAR FONT, STYLE, SIZE, OR COLOR.

NO CLAIM IS MADE TO THE EXCLUSIVE RIGHT TO USE "GROUP", APART FROM THE MARK AS SHOWN.

CLASS 36—INSURANCE AND FINANCIAL

FOR FINANCIAL INVESTMENT IN THE FIELD OF REAL ESTATE (U.S. CLS. 100, 101 AND 102).

FIRST USE 6-23-2005; IN COMMERCE 6-23-2005.

CLASS 37—CONSTRUCTION AND REPAIR

FOR REAL ESTATE DEVELOPMENT (U.S. CLS. 100, 103 AND 106).

FIRST USE 6-23-2005; IN COMMERCE 6-23-2005.

MATTHEW MCDOWELL, EXAMINING ATTORNEY

SN 78-658,629. ASIA PACIFIC LIMITED, SHEUNG WAN, HONG KONG, FILED 6-27-2005.



THE GRAY STIPPLING/SHADING IS NOT A FEATURE OF THE MARK.

THE MARK CONSISTS OF AN OVAL WITH THE WORD MEGZ.

CLASS 18—LEATHER GOODS

FOR BAGS AND HOLDALLS FOR SPORTS CLOTHING; HAVERSACKS; RUCKSACKS; LUGGAGE; WALLET; PURSES; BRIEFCASES; UMBRELLAS; ALL PURPOSE SPORTS BAGS; SPORTS BAGS (U.S. CLS. 1, 2, 3, 22 AND 41).

CLASS 25—CLOTHING

FOR ARTICLES OF CLOTHING, NAMELY, FOOTWEAR; HEADWEAR; ADULT AND CHILDREN'S SPORTS CLOTHING, NAMELY, T-SHIRTS, SPORTS SHIRTS, SHORTS, SOCKS; SWEAT PANTS, YOGA PANTS, SWEAT SHIRTS, HEAD BANDS, ATHLETIC SHOES, TENNIS SHOES, RUNNING SHOES, AND WATER SHOES; ADULT AND CHILDREN'S LEISURE WEAR, NAMELY, SHIRTS, PANTS, SHORTS, TOPS, SOCKS, AND UNDERWEAR; ADULT AND CHILDREN'S CASUAL CLOTHING, NAMELY, SHIRTS, SHORTS, PANTS, SKIRTS, SOCKS, DRESSES, AND UNDERWEAR; ADULT AND CHILDREN'S NIGHT WEAR, NAMELY, NIGHT GOWNS, NIGHT SHIRTS AND PAJAMAS; ADULT AND CHILDREN'S OUTDOOR WEAR, NAMELY, SHORTS, SHIRTS, PANTS, AND SOCKS; ADULT WORK CLOTHING, NAMELY, SUITS, DRESSES, SKIRTS, BLOUSES, SHIRTS, SLACKS, SOCKS, AND PANTS; ADULT AND CHILDREN'S HATS; SPORTS BAGS SHAPED TO CONTAIN FOOTWEAR USED IN ATHLETICS, NAMELY, SKI BOOT BAGS AND HUNTING BOOT BAGS (U.S. CLS. 22 AND 39).

CLASS 28—TOYS AND SPORTING GOODS

FOR GAMES AND PLAYTHINGS, NAMELY, BOARD GAMES, PLUSH ANIMALS, AND PUZZLES; SPORTING AND GYMNASTICS ARTICLES, NAMELY, EXERCISE AND GYMNASTIC BANNERS, GLOVES, GYMNASTIC APPARATUS, AND GYMNASTIC TRAINING STOOLS; GLOVES FOR GAMES AND SPORTS, NAMELY, BASEBALL GLOVES, BATTING GLOVES, LACROSSE GLOVES, BOXING GLOVES, GOLF GLOVES; BAGS FOR CRICKET BATS AND BALLS; ATHLETIC PROTECTIVE PADS IN THE NATURE OF FOOTBALL SHOULDER PADS, SOCCER KNEE PADS, KARATE KICK PADS; SPORTS TRAINING APPLIANCES, NAMELY, WEIGHT LIFTING MACHINES, ROWING MACHINES, STATIONARY EXERCISE BICYCLES, GYMNASTIC PARALLEL BARS; POMMEL HORSE; VAULTING BARS, AND HORIZONTAL BARS; FOOTBALLS; RUGBY BALLS; SOCCER BALLS; SPORTS BALLS; RACQUETS FOR TENNIS, SQUASH, RACQUETBALL; AND REPLACEMENT PARTS FOR THE AFORESAID GOODS (U.S. CLS. 22, 23, 38 AND 50).

KAREN BRACEY, EXAMINING ATTORNEY

CLASS 37—CONSTRUCTION AND REPAIR

FOR INSTALLATION OF WORK STATIONS, CABINETS, SPECIALTY SEATING, PARTITIONS, CREDENZAS, DESKS, AND RECEPTION COUNTERS PROVIDED TO RESEARCH FACILITIES, LABORATORIES, EDUCATIONAL INSTITUTIONS, HEALTH CARE INSTITUTIONS, BUSINESSES, GOVERNMENTAL INSTITUTIONS, PUBLIC INSTITUTIONS, COURTHOUSES, AND CHURCHES (U.S. CLS. 100, 103 AND 106).

FIRST USE 2-0-2004; IN COMMERCE 2-0-2004.

CLASS 40—MATERIAL TREATMENT

FOR CUSTOM WOODWORKING OF WORK STATIONS, CABINETS, SPECIALTY SEATING, PARTITIONS, CREDENZAS, DESKS, AND RECEPTION COUNTERS PROVIDED TO RESEARCH FACILITIES, LABORATORIES, EDUCATIONAL INSTITUTIONS, HEALTH CARE INSTITUTIONS, BUSINESSES, GOVERNMENTAL INSTITUTIONS, PUBLIC INSTITUTIONS, COURTHOUSES, AND CHURCHES (U.S. CLS. 100, 103 AND 106).

FIRST USE 2-0-2004; IN COMMERCE 2-0-2004.

CLASS 42—SCIENTIFIC, COMPUTER AND LEGAL SERVICES

FOR ARCHITECTURAL FURNITURE DESIGN OF WORK STATIONS, CABINETS, SPECIALTY SEATING, PARTITIONS, CREDENZAS, DESKS, AND RECEPTION COUNTERS PROVIDED TO RESEARCH FACILITIES, LABORATORIES, EDUCATIONAL INSTITUTIONS, HEALTH CARE INSTITUTIONS, BUSINESSES, GOVERNMENTAL INSTITUTIONS, PUBLIC INSTITUTIONS, COURTHOUSES, AND CHURCHES (U.S. CLS. 100 AND 101).

FIRST USE 2-0-2004; IN COMMERCE 2-0-2004.
DAVID TAYLOR, EXAMINING ATTORNEY

SN 78-660,902. MIDNIGHT TRAIN PRODUCTIONS, LLC,
SAN DIEGO, CA. FILED 6-29-2005.

SWEET SPOT

SN 78-659,234. VALLEY CITY MANUFACTURING COMPANY LIMITED, DUNDAS, ONTARIO, CANADA, FILED 6-27-2005.



OWNER OF U.S. REG. NO. 2,042,622.
NO CLAIM IS MADE TO THE EXCLUSIVE RIGHT TO USE "ARCHITECTURAL FURNITURE", APART FROM THE MARK AS SHOWN.

THE MARK CONSISTS OF STANDARD CHARACTERS WITHOUT CLAIM TO ANY PARTICULAR FONT, STYLE, SIZE, OR COLOR.

CLASS 9—ELECTRICAL AND SCIENTIFIC APPARATUS

FOR COMPUTER CARRYING CASES; CASES FOR MOBILE PHONES; AND SCALES (U.S. CLS. 21, 23, 26, 36 AND 38).

CLASS 18—LEATHER GOODS

FOR NON-MOTORIZED COLLAPSIBLE LUGGAGE CARTS; LUGGAGE STRAPS; FOOTLOCKERS AND TRUNKS (U.S. CLS. 1, 2, 3, 22 AND 41).

TRAVIS WHEATLEY, EXAMINING ATTORNEY

SN 78-661,915. BOUSHIE, KRISTOPHER, JERICHO, VT.
FILED 6-30-2005.

SN 78-665,482. CONEMATIC HEATING SYSTEMS INC.,
CALGARY, CANADA, FILED 7-7-2005.

Forensis Research & Analysis

THE MARK CONSISTS OF STANDARD CHARACTERS WITHOUT CLAIM TO ANY PARTICULAR FONT, STYLE, SIZE, OR COLOR.

NO CLAIM IS MADE TO THE EXCLUSIVE RIGHT TO USE "RESEARCH & ANALYSIS", APART FROM THE MARK AS SHOWN.

CLASS 35—ADVERTISING AND BUSINESS

FOR BUSINESS CONSULTATION AND INFORMATION SERVICES (U.S. CLS. 100, 101 AND 102).

CLASS 42—SCIENTIFIC, COMPUTER AND LEGAL SERVICES

FOR LITIGATION CONSULTANCY SERVICES (U.S. CLS. 100 AND 101).
KAREN K. BUSH, EXAMINING ATTORNEY

SN 78-664,444. CALIFORNIA CHAMBER OF COMMERCE,
SACRAMENTO, CA. FILED 7-6-2005.

CAL CHAMBER

THE MARK CONSISTS OF STANDARD CHARACTERS WITHOUT CLAIM TO ANY PARTICULAR FONT, STYLE, SIZE, OR COLOR.

NO CLAIM IS MADE TO THE EXCLUSIVE RIGHT TO USE "CAL", APART FROM THE MARK AS SHOWN.

CLASS 9—ELECTRICAL AND SCIENTIFIC APPARATUS

FOR COMPACT DISKS ON THE SUBJECT OF COMPLIANCE WITH GOVERNMENT RULES AND REGULATIONS; COMPUTER SOFTWARE FOR USE BY BUSINESSES IN CONNECTION WITH COMPLIANCE WITH GOVERNMENT RULES AND REGULATIONS FOR BUSINESSES (U.S. CLS. 21, 23, 26, 36 AND 38).

CLASS 16—PAPER GOODS AND PRINTED MATTER

FOR PRINTED PUBLICATIONS, NAMELY, BOOKLETS, BOOKS AND MANUALS, ON THE SUBJECT OF COMPLIANCE WITH GOVERNMENT RULES AND REGULATIONS (U.S. CLS. 2, 5, 22, 23, 29, 37, 38 AND 50).

CLASS 41—EDUCATION AND ENTERTAINMENT

FOR EDUCATIONAL SERVICES, NAMELY, CONDUCTING CLASSES, SEMINARS, CONFERENCES AND WORKSHOPS ON ECONOMICS, BUSINESS, WORKFORCE DEVELOPMENT AND DISTRIBUTION OF COURSE MATERIAL IN CONNECTION THEREWITH (U.S. CLS. 100, 101 AND 107).

MICHAEL LEWIS, EXAMINING ATTORNEY

CONEMATIC

THE MARK CONSISTS OF STANDARD CHARACTERS WITHOUT CLAIM TO ANY PARTICULAR FONT, STYLE, SIZE, OR COLOR.

PRIORITY CLAIMED UNDER SEC. 44(D) ON CANADA APPLICATION NO. 1243575, FILED 1-13-2005, REG. NO. TMA666012, DATED 6-14-2006, EXPIRES 6-14-2021.

CLASS 11—ENVIRONMENTAL CONTROL APPARATUS

FOR HYDRONIC AND RADIANT HEATING SYSTEMS, AND RELATED PARTS AND ACCESSORIES, NAMELY PROPANE, NATURAL GAS OR OIL FIRED BOILERS WITH EXPANSION TANKS, PUMPS, TEMPERATURE SENSORS AND INJECTION MIXING CONTROLS; WATER HEATERS; PROPANE, NATURAL GAS AND OIL FIRED BOILERS AND RELATED PARTS AND ACCESSORIES NAMELY, EXPANSION TANKS, PRIMARY PUMPS, SECONDARY PUMPS, TEMPERATURE SENSORS AND INJECTION MIXING CONTROLS; BOILERS WHICH SUPPLY RESIDENTIAL OR COMMERCIAL HOT WATER; HEATING APPLIANCES NAMELY, NATURAL GAS, PROPANE AND OIL FIRED BOILERS CONNECTED TO AN UNDER-SLAB OR UNDER FLOOR DISTRIBUTION SYSTEM OR OTHER RADIANT OR SPACE HEATING SYSTEMS (U.S. CLS. 13, 21, 23, 31 AND 34).

CLASS 40—MATERIAL TREATMENT

FOR MANUFACTURE OF HEATING SYSTEMS AND PARTS AND COMPONENTS THEREOF; MANUFACTURE OF WATER HEATERS AND HEATING APPLIANCES AND PARTS AND COMPONENTS THEREOF (U.S. CLS. 100, 103 AND 106).

CLASS 42—SCIENTIFIC, COMPUTER AND LEGAL SERVICES

FOR DESIGN OF RESIDENTIAL AND COMMERCIAL HEATING SYSTEMS (U.S. CLS. 100 AND 101).
NAAKWAMA ANKRAH, EXAMINING ATTORNEY

SN 78-665,583. KOHLER CO., KOHLER, WI. FILED 7-7-2005.

VIR STIL

THE MARK CONSISTS OF STANDARD CHARACTERS WITHOUT CLAIM TO ANY PARTICULAR FONT, STYLE, SIZE, OR COLOR.

CLASS 6—METAL GOODS

FOR METAL ROBE HOOKS; METAL KNOBS; METAL HINGES; METAL DRAWER PULLS; METAL DOOR HANDLES; METAL LEVERS; AND PARTS THEREFOR (U.S. CLS. 2, 12, 13, 14, 23, 25 AND 50).

FIRST USE 5-5-2005; IN COMMERCE 5-5-2005.

CLASS 11—ENVIRONMENTAL CONTROL APPARATUS

FOR SHOWER HEADS; SHOWER HEAD SPRAYERS; BRACKETS FOR SHOWER HEAD SPRAYERS; LAVATORIES; WATER DIVERTERS; BATHTUB VALVES; WATER CONTROL VALVES; VALVE TRIM; THERMOSTATIC VALVE TRIM; PRESSURE BALANCE VALVE TRIM; LEVER HANDLES; BATH SPOUTS; LAVATORY FAUCETS; FAUCET HANDLES; KITCHEN FAUCETS; KITCHEN FAUCET SPRAYERS; ELECTRIC LIGHTING FIXTURES, NAMELY SCONCES; AND PARTS THEREFOR (U.S. CLS. 13, 21, 23, 31 AND 34).

FIRST USE 5-5-2005; IN COMMERCE 5-5-2005.

CLASS 20—FURNITURE AND ARTICLES NOT OTHERWISE CLASSIFIED

FOR MIRRORS; MIRRORS WITH FRAMES OF NON-PRECIOUS METAL; BATHROOM VANITY UNITS; COUNTERTOPS; BATHROOM VANITY TOPS; CONSOLE LEGS; BATH CARTS; AND PARTS THEREFOR (U.S. CLS. 2, 13, 22, 25, 32 AND 50).

FIRST USE 5-5-2005; IN COMMERCE 5-5-2005.

CLASS 21—HOUSEWARES AND GLASS

FOR TOWEL BARS; TOWEL RINGS; SOAP DISPENSERS; TOILET TISSUE HOLDERS; AND PARTS THEREFOR (U.S. CLS. 2, 13, 23, 29, 30, 33, 40 AND 50).

FIRST USE 5-5-2005; IN COMMERCE 5-5-2005.
MICHAEL ENGEL, EXAMINING ATTORNEY

SN 78-667,411. VIACOM INTERNATIONAL INC., NEW YORK, NY. FILED 7-11-2005.

URGE

THE MARK CONSISTS OF STANDARD CHARACTERS WITHOUT CLAIM TO ANY PARTICULAR FONT, STYLE, SIZE, OR COLOR.

CLASS 38—COMMUNICATION

FOR TRANSMISSION, DOWNLOADING AND STREAMING OF DIGITAL AUDIO, VIDEO, GRAPHICS, TEXT AND DATA VIA COMPUTER NETWORKS AND IN CONNECTION WITH A VIRTUAL ON-LINE COMMUNITY; TRANSMISSION OF NEWS; NETWORK CONFERENCING SERVICES; PROVIDING ONLINE CHAT ROOMS AND BULLETIN BOARDS FOR TRANSMISSION OF MESSAGES AMONG USERS IN THE FIELDS OF MUSIC, ENTERTAINMENT AND GENERAL INTEREST; PROVIDING ON-LINE COMMUNITY FORUMS AND CHAT ROOMS ALLOWING USERS TO TRANSMIT MESSAGES OVER COMMUNICATIONS NETWORKS; TRANSMISSION OF PEER TO PEER NETWORKING INFORMATION AND FILE SHARING INFORMATION VIA COMMUNICATIONS NETWORKS; PROVIDING PEER TO PEER AND MULTI-USER ACCESS TO GLOBAL AND PRIVATE COMPUTER NETWORKS AND DATABASES; WEB CASTING SERVICES WHICH ENABLE PEER TO PEER INTERNET COMMUNICATIONS FOR STATIC AND STREAMING IMAGES AND GRAPHICS, AUDIO, VIDEO, TEXT, DATA, VIDEO CONFERENCING AND CHATTING (U.S. CLS. 100, 101 AND 104).

CLASS 41—EDUCATION AND ENTERTAINMENT

FOR PROVIDING AN ON-LINE COMPUTER DATABASE IN THE FIELD OF MUSIC AND ENTERTAINMENT; PROVIDING NEWS AND INFORMATION IN THE NATURE OF CURRENT EVENT REPORTING; PROVIDING NEWS REPORTING SERVICES; ENTERTAINMENT SERVICES, NAMELY, PROVIDING ON-LINE COMMUNITY BASED INTERACTIVE MUSIC AND ENTERTAINMENT DATABASES AND WEB SITES (U.S. CLS. 100, 101 AND 107).

DAVID TAYLOR, EXAMINING ATTORNEY

SN 78-667,739. SKINPROFILE, INC., NEW YORK, NY. FILED 7-11-2005.

SKINPROFILE

THE MARK CONSISTS OF STANDARD CHARACTERS WITHOUT CLAIM TO ANY PARTICULAR FONT, STYLE, SIZE, OR COLOR.

CLASS 3—COSMETICS AND CLEANING PREPARATIONS

FOR COSMETICS (U.S. CLS. 1, 4, 6, 50, 51 AND 52).

CLASS 40—MATERIAL TREATMENT

FOR MANUFACTURE OF COSMETICS AND SKIN CARE PRODUCTS TO ORDER AND/OR SPECIFICATION OF OTHERS (U.S. CLS. 100, 103 AND 106).

YONG KIM, EXAMINING ATTORNEY

SN 78-667,960. DRYMAX SPORTS, LLC, HICKORY, NC. FILED 7-11-2005.

DRYMAX

THE MARK CONSISTS OF STANDARD CHARACTERS WITHOUT CLAIM TO ANY PARTICULAR FONT, STYLE, SIZE, OR COLOR.

OWNER OF U.S. REG. NO. 1,456,633.

CLASS 22—CORDAGE AND FIBERS

FOR COTTON FIBERS, POLYESTER FIBERS, SILK FIBERS, SYNTHETIC FIBERS AND TEXTILE FIBERS USED FOR THE MANUFACTURE OF CLOTHING (U.S. CLS. 1, 2, 7, 19, 22, 42 AND 50).

FIRST USE 3-5-1987; IN COMMERCE 5-25-2000.

CLASS 24—FABRICS

FOR TEXTILE FABRICS USED IN THE MANUFACTURE OF CLOTHING (U.S. CLS. 42 AND 50).

FIRST USE 3-5-1987; IN COMMERCE 5-25-2000.
LAURA HAMMEL, EXAMINING ATTORNEY

SN 78-668,641. FLEXSMART INC, MISSISSAUGA, ONTARIO, CANADA, FILED 7-12-2005.

FLEXSMART

THE MARK CONSISTS OF STANDARD CHARACTERS WITHOUT CLAIM TO ANY PARTICULAR FONT, STYLE, SIZE, OR COLOR.

CLASS 20—FURNITURE AND ARTICLES NOT OTHERWISE CLASSIFIED

FOR FURNITURE AND ACCESSORIES FOR HEALTH & EDUCATIONAL INSTITUTIONS, AUDITORIUMS AND CONFERENCE CENTERS NAMELY, OFFICE FURNITURE; CASE GOODS, NAMELY, DESKS, TABLES, FILING CABINETS, CREDENZAS, STORAGE UNITS NAMELY, NON-METAL, GENERAL PURPOSE STORAGE UNITS, AND BOOK SHELVES; WORK STATION SYSTEMS FURNITURE, NAMELY, PANELS, PARTITIONS, WORK SURFACES, STORAGE COMPARTMENTS AND PARTS AND FITTINGS THEREFORE; SEATING, NAMELY, CHAIRS, BENCHES, STOOLS, SOFAS AND MODULAR SEATING UNITS; TABLES, NAMELY, BOARDROOM TABLES, SIDE TABLES, COFFEE TABLES, RECEPTION TABLES, MEETING TABLES, NIGHT TABLES; BEDS AND BED FRAMES; ARMOIRES, WARDROBES, CONSOLES AND TV STANDS; COMPUTER WORKSTATIONS COMPRISING COMPUTER TRAYS, KEYBOARD TRAYS, FOOT STOOLS, FURNITURE PARTS NAMELY, ARM RESTS (U.S. CLS. 2, 13, 22, 25, 32 AND 50).

FIRST USE 1-16-2005; IN COMMERCE 1-16-2005.

CLASS 35—ADVERTISING AND BUSINESS

FOR ONLINE WHOLESALE AND RETAIL STORE SERVICES FEATURING OFFICE AND INSTITUTIONAL FURNITURE OFFERED VIA THE INTERNET (U.S. CLS. 100, 101 AND 102).

FIRST USE 1-16-2005; IN COMMERCE 1-16-2005.
RICHARD WHITE, EXAMINING ATTORNEY

SN 78-670,533. DAILYCOLORS NUTRITION CORPORATION, BRENTWOOD, CA. FILED 7-14-2005.

DAILYCOLORS

THE MARK CONSISTS OF STANDARD CHARACTERS WITHOUT CLAIM TO ANY PARTICULAR FONT, STYLE, SIZE, OR COLOR.

CLASS 5—PHARMACEUTICALS

FOR NUTRITIONAL PRODUCTS, NAMELY NUTRACEUTICALS FOR USE AS DIETARY SUPPLEMENTS; NUTRITIONALLY FORTIFIED FOODS AND BEVERAGES FOR MEDICAL DIETETIC PURPOSES; NUTRITIONAL DRINK MIXES FOR USE AS MEAL REPLACEMENTS; MEAL REPLACEMENT BARS; DIETARY FIBER ADDITIVES FOR FOOD PRODUCTS; FOOD FOR MEDICALLY RESTRICTED DIETS; PROCESSED FOOD ADAPTED FOR MEDICAL PURPOSES; APPETITE SUPPRESSANTS; HERBAL TEAS FOR MEDICINAL PURPOSES; MEDICATED SKIN CARE PRODUCTS, NAMELY MEDICATED SKIN CLEANSERS, MEDICATED SKIN CREAMS, MEDICATED SKIN, SUNBURN AND BODY LOTIONS AND MEDICATED SUN BLOCKS (U.S. CLS. 6, 18, 44, 46, 51 AND 52).

CLASS 16—PAPER GOODS AND PRINTED MATTER

FOR PRINTED MATERIALS, NAMELY DIET BOOKS, COOKBOOKS, NEWSLETTERS, AND CALENDARS IN THE FIELD OF HEALTH AND NUTRITION (U.S. CLS. 2, 5, 22, 23, 29, 37, 38 AND 50).

CLASS 44—MEDICAL, BEAUTY AND AGRICULTURAL SERVICES

FOR PROVIDING INFORMATION AND COUNSELING RELATING TO DIETARY GUIDANCE AND NUTRITION VIA ELECTRONIC COMMUNICATION NETWORKS (U.S. CLS. 100 AND 101).

ANDREA K. NADELMAN, EXAMINING ATTORNEY

SN 78-671,893. SHUTOWICK, JONNA, PARKLAND, FL. FILED 7-16-2005.

ROSEY SHADES

THE MARK CONSISTS OF STANDARD CHARACTERS WITHOUT CLAIM TO ANY PARTICULAR FONT, STYLE, SIZE, OR COLOR.

THE NAME(S), PORTRAIT(S), AND/OR SIGNATURE(S) SHOWN IN THE MARK DOES NOT IDENTIFY A PARTICULAR LIVING INDIVIDUAL.

CLASS 16—PAPER GOODS AND PRINTED MATTER

FOR PRINTED MATTER AND PAPER GOODS, NAMELY, BOOKS AND MAGAZINES IN THE FIELDS OF PERSONAL, PROFESSIONAL, AND SPIRITUAL INSPIRATION, ACHIEVEMENT, AND GROWTH, AND MOTIVATIONAL AND INNER PERSONAL DEVELOPMENT, COMIC BOOKS, CHILDREN'S BOOKS, COLORING BOOKS, CHILDREN'S AND ADULTS' ACTIVITY BOOKS, SCRAPBOOKS; STATIONERY, WRITING PAPER, ENVELOPES, SPIRAL AND BOUND NOTEBOOKS, NOTE PADS, DIARIES, BLANK WRITING JOURNALS AND JOURNALS CONCERNING PERSONAL, PROFESSIONAL, AND SPIRITUAL INSPIRATION, ACHIEVEMENT, AND GROWTH, AND MOTIVATIONAL AND INNER PERSONAL DEVELOPMENT, NOTE CARDS, POSTCARDS, GREETING CARDS, TRADING CARDS; LITHOGRAPHS; PENS, PENCILS, CASES THEREFOR, ERASERS, CRAYONS, MARKERS, COLORED PENCILS, PAINTING SETS, CHALK AND CHALKBOARDS FOR SCHOOL AND HOME USE; DECALS, HEAT TRANSFER PAPER; RUBBER STAMPS, STAMP PAD INKS, STAMP PADS; POSTERS; MOUNTED AND/OR UNMOUNTED PHOTOGRAPHS; BOOK COVERS, BOOK MARKS; CALENDARS; GIFT WRAPPING PAPER; PAPER PARTY FAVORS AND PAPER PARTY DECORATIONS, NAMELY, PAPER NAPKINS, PAPER DOILIES, PAPER PLACE MATS, CREPE PAPER, PAPER PARTY HATS, PRINTED INVITATIONS AND INVITATION CARDS, PAPER TABLE CLOTHS, PAPER CAKE DECORATIONS; PRINTED TRANSFERS FOR EMBROIDERY OR FABRIC APPLIQUES; PRINTED PATTERNS FOR COSTUMES, PAJAMAS, SWEATSHIRTS AND T-SHIRTS (U.S. CLS. 2, 5, 22, 23, 29, 37, 38 AND 50).

CLASS 25—CLOTHING

FOR CLOTHING, NAMELY PANTS, JEANS, SLACKS, OVERALLS, SHORTS, DRESSES, SKIRTS, JOGGING SUITS, JACKETS, COATS, RAINCOATS, SHIRTS, BLOUSES, T-SHIRTS, TANK TOPS, SWEATERS, VESTS, UNDERCLOTHES, UNDERWEAR, LINGERIE, SOCKS, ROBES, TIES, BELTS, SUSPENDERS, SCARVES, GLOVES, MITTENS, SUNVISORS, SLIPPERS, SINGLET, CLOTH BIBS, RAINWEAR, SWIMWEAR, SLEEPWEAR, FOOTWEAR, AND HEADWEAR (U.S. CLS. 22 AND 39).
LAURA HAMMEL, EXAMINING ATTORNEY

SN 78-673,667. BROADWEAVE NETWORKS, INC., LEHI, UT.
FILED 7-19-2005.

YOU'RE NOT REALLY LIVING,
IF YOU'RE NOT CONNECTED

THE MARK CONSISTS OF STANDARD CHARACTERS WITHOUT CLAIM TO ANY PARTICULAR FONT, STYLE, SIZE, OR COLOR.

CLASS 38—COMMUNICATION

FOR TRANSMISSION OF TELEPHONE AND TELEVISION OVER THE INTERNET; ELECTRONIC TRANSMISSION OF DATA OVER ANY INTERNET PROTOCOL MEDIUM, NAMELY, FIBER, COPPER, WIRELESS (U.S. CLS. 100, 101 AND 104).
FIRST USE 6-1-2003; IN COMMERCE 6-1-2003.

CLASS 42—SCIENTIFIC, COMPUTER AND LEGAL SERVICES

FOR FIBER OPTIC ENGINEERING AND DESIGN (U.S. CLS. 100 AND 101).
FIRST USE 6-1-2003; IN COMMERCE 6-1-2003.
CHRIS WELLS, EXAMINING ATTORNEY

SN 78-675,493. MOTHWING CAMO TECHNOLOGIES, INC., HELENWOOD, TN. FILED 7-21-2005.

TREE-DIMENSIONAL

THE MARK CONSISTS OF STANDARD CHARACTERS WITHOUT CLAIM TO ANY PARTICULAR FONT, STYLE, SIZE, OR COLOR.

CLASS 16—PAPER GOODS AND PRINTED MATTER

FOR (BASED ON INTENT TO USE) SELF-ADHESIVE PRINTED CAMOUFLAGE PATTERNS FOR ATTACHMENT TO SURFACES (U.S. CLS. 2, 5, 22, 23, 29, 37, 38 AND 50).

CLASS 24—FABRICS

FOR (BASED ON USE IN COMMERCE) TEXTILE AND SYNTHETIC FABRICS FEATURING CAMOUFLAGE PATTERNS FOR USE ON A WIDE VARIETY OF GOODS OF THE TYPE HAVING TEXTILE OR SYNTHETIC FABRIC (U.S. CLS. 42 AND 50).

FIRST USE 10-15-2004; IN COMMERCE 5-1-2005.
ELLEN PERKINS, EXAMINING ATTORNEY

SN 78-676,428. THE NEW ZEALAND MERINO COMPANY LIMITED, CHRISTCHURCH, NEW ZEALAND, FILED 7-22-2005.



PRIORITY CLAIMED UNDER SEC. 44(D) ON NEW ZEALAND APPLICATION NO. 732780, FILED 7-19-2005, REG. NO. 732780, DATED 7-19-2005, EXPIRES 7-19-2015.

CLASS 22—CORDAGE AND FIBERS

FOR RAW FIBROUS TEXTILE MATERIALS; ANIMAL FIBERS AND SHEEP FIBERS, NAMELY, FLEECE WOOL AND RAW WOOL; WOOL FLOCKS, WOOL PACKS; WOOL TOPS, SHORN WOOL; AND RAW, TREATED, AND COMBED OR CARDED WOOL (U.S. CLS. 1, 2, 7, 19, 22, 42 AND 50).

CLASS 23—YARNS AND THREADS

FOR YARNS AND THREADS FOR TEXTILES (U.S. CL. 43).

CLASS 24—FABRICS

FOR TEXTILES AND TEXTILE GOODS NOT INCLUDED IN OTHER CLASSES, NAMELY, BED SPREADS, CURTAINS, BED COVERS AND TABLE COVERS; WOVEN FABRICS; BED BLANKETS; AND BEDCLOTHES, NAMELY, BLANKETS, SPREADS, THROWS, DUVET COVERS AND COMFORTERS (U.S. CLS. 42 AND 50).

CLASS 25—CLOTHING

FOR UNDERWEAR, SHIRTS, JUMPERS, PANTS, MEN'S AND WOMEN'S SUITS, TROUSERS, SWEAT-SHIRTS, TEE SHIRTS, SHORTS, JACKETS, DRESSES, SKIRTS, SHOES, SLIPPERS, HATS, CAPS, SCARVES AND GLOVES (U.S. CLS. 22 AND 39).

MARLENE BELL, EXAMINING ATTORNEY

SN 78-677,851. MOTOROLA, INC., SCHAUMBURG, IL.
FILED 7-25-2005.

 The logo for MOTOQ features the word "MOTO" in a bold, sans-serif font with a slight shadow effect, followed by a large, stylized "Q" that has a thick, rounded top and a vertical stem.
CLASS 9—ELECTRICAL AND SCIENTIFIC APPARATUS

FOR TELEPHONES, CELLULAR TELEPHONES, RADIO TELEPHONES, PAGERS, TWO-WAY RADIOS, RADIO TRANSMITTERS, RADIO RECEIVERS, RADIO TRANSCEIVERS, ELECTRONIC ORGANIZERS, AND RELATED ACCESSORIES FOR THE FOREGOING GOODS, NAMELY, HEADSETS, MICROPHONES, SPEAKERS, CARRYING CASES, AND BELT CLIPS; COMPUTER SOFTWARE AND PROGRAMS USED FOR TRANSMISSION OR REPRODUCING OR RECEIVING OF SOUND, IMAGES, VIDEO OR DATA OVER A TELECOMMUNICATIONS NETWORK OR SYSTEM BETWEEN TERMINALS AND FOR ENHANCING AND FACILITATING USE AND ACCESS TO COMPUTER NETWORKS AND TELEPHONE NETWORKS; COMPUTER SOFTWARE FOR USE IN GENERAL PURPOSE DATABASE MANAGEMENT; COMPUTER E COMMERCE SOFTWARE TO ALLOW USER TO SAFELY PLACE ORDERS AND MAKE PAYMENTS IN THE FIELD OF ELECTRONIC BUSINESS TRANSACTIONS VIA A GLOBAL COMPUTER NETWORK OR TELECOMMUNICATIONS NETWORK; COMPUTER GAME SOFTWARE FOR MOBILE HANDSETS; COMPUTER SOFTWARE AND PROGRAMS FEATURING MUSIC, MOVIES, AND ANIMATION; COMPUTER SOFTWARE FOR THE DISTRIBUTION OF INFORMATION AND INTERACTIVE MULTIMEDIA CONTENT CONTAINING TEXT, IMAGES, VIDEO AND SOUND TO USERS IN THE FIELD OF COMMUNICATIONS; COMPUTER SOFTWARE AND PROGRAMS FOR MANAGEMENT AND OPERATION OF WIRELESS TELECOMMUNICATIONS DEVICES; COMPUTER SOFTWARE FOR ACCESSING, SEARCHING, INDEXING AND RETRIEVING INFORMATION AND DATA FROM GLOBAL COMPUTER NETWORKS AND GLOBAL COMMUNICATION NETWORKS, AND FOR BROWSING AND NAVIGATING THROUGH WEB SITES ON SAID NETWORKS; COMPUTER SOFTWARE FOR SENDING AND RECEIVING SHORT MESSAGES AND ELECTRONIC MAIL AND FOR FILTERING NON-TEXT INFORMATION FROM THE DATA; ANALOG AND DIGITAL RADIO TRANSCEIVERS OR RECEIVERS FOR DATA, VOICE, IMAGE AND VIDEO COMMUNICATION; ELECTRONIC GAME SOFTWARE FOR MOBILE HANDSETS; CAMERAS, NAMELY PHOTOGRAPHIC CAMERAS, DIGITAL CAMERAS, MOTION PICTURE CAMERAS, VIDEO CAMERAS; CALCULATORS; CARDS FOR COMMUNICATIONS PURPOSES, NAMELY, COMPUTER MODEM CARDS AND FAX MODEM CARDS FOR COMMUNICATION PURPOSES, ALL FOR USE WITH COMMUNICATIONS APPARATUS; MODEMS, GLOBAL POSITIONING UNITS, BATTERIES, BATTERY CHARGERS, POWER ADAPTERS, AND ANTENNAS (U.S. CLS. 21, 23, 26, 36 AND 38).

SN 78-677,747. EMPLOYMENT PRACTICES SOLUTIONS, INC., SOUTHLAKE, TX. FILED 7-25-2005.

EPS

THE MARK CONSISTS OF STANDARD CHARACTERS WITHOUT CLAIM TO ANY PARTICULAR FONT, STYLE, SIZE, OR COLOR.

CLASS 35—ADVERTISING AND BUSINESS

FOR BUSINESS CONSULTING SERVICES IN THE FIELD OF EMPLOYMENT PRACTICES (U.S. CLS. 100, 101 AND 102).

FIRST USE 9-14-1998; IN COMMERCE 9-14-1998.

CLASS 41—EDUCATION AND ENTERTAINMENT

FOR EDUCATIONAL SERVICES, NAMELY, PROVIDING CUSTOMIZED TRAINING COURSES REGARDING EMPLOYEE RELATIONS, EMPLOYMENT, HUMAN RESOURCES, LABOR ISSUES, AND INVESTIGATION OF EMPLOYEE COMPLAINTS (U.S. CLS. 100, 101 AND 107).

FIRST USE 9-14-1998; IN COMMERCE 9-14-1998.
GRETNA YAO, EXAMINING ATTORNEY

CLASS 38—COMMUNICATION

FOR WIRELESS TELEPHONE COMMUNICATION SERVICES AND ELECTRONIC TRANSMISSION OF DATA AND DOCUMENTS VIA COMPUTER TERMINALS (U.S. CLS. 100, 101 AND 104).

DARRYL SPRUILL, EXAMINING ATTORNEY

SN 78-678,665. T.A. MUSIC, GEORGE TOWN, GRAND CAYMAN, CAYMAN ISLANDS, FILED 7-26-2005.

DANGEROUS AND MOVING

THE MARK CONSISTS OF STANDARD CHARACTERS WITHOUT CLAIM TO ANY PARTICULAR FONT, STYLE, SIZE, OR COLOR.

CLASS 9—ELECTRICAL AND SCIENTIFIC APPARATUS

FOR AUDIO RECORDINGS FEATURING MUSIC; AND AUDIOVISUAL RECORDINGS FEATURING MUSIC, DRAMA, COMEDY, MUSIC VIDEOS, AND ENTERTAINMENT (U.S. CLS. 21, 23, 26, 36 AND 38).

CLASS 16—PAPER GOODS AND PRINTED MATTER

FOR PRINTED PUBLICATIONS, NAMELY, NEWSLETTERS, POSTERS, PHOTOGRAPHS, PRINTED EVENT PROGRAMS DIRECTED TO MUSIC, MUSIC PERFORMANCES, MUSIC CONCERTS, AND OTHER ENTERTAINMENT-RELATED CONTENT (U.S. CLS. 2, 5, 22, 23, 29, 37, 38 AND 50).

CLASS 25—CLOTHING

FOR CLOTHING, NAMELY, HATS, CAPS, HEADWEAR, T-SHIRTS AND SWEATSHIRTS (U.S. CLS. 22 AND 39).

CLASS 41—EDUCATION AND ENTERTAINMENT

FOR ENTERTAINMENT SERVICES, NAMELY, PRESENTATION OF RECORDED AND LIVE MUSICAL PERFORMANCES, MUSICAL CONCERTS, MUSIC VIDEOS, AND TELEVISION SHOWS; AND PRODUCTION OF ENTERTAINMENT CONTENT, SPECIFICALLY, MUSICAL PERFORMANCES, MUSICAL CONCERTS, MUSIC VIDEOS, AND TELEVISION SHOWS (U.S. CLS. 100, 101 AND 107).

RONALD AIKENS, EXAMINING ATTORNEY

SN 78-678,941. SALACUSE, FRANK, AVENTURA, FL. FILED 7-26-2005.

WALK-OFF KING

THE MARK CONSISTS OF STANDARD CHARACTERS WITHOUT CLAIM TO ANY PARTICULAR FONT, STYLE, SIZE, OR COLOR.

CLASS 3—COSMETICS AND CLEANING PREPARATIONS

FOR NON-MEDICATED TOILETRIES; DEODORANTS AND ANTI-PERSPIRANTS FOR PERSONAL USE; PERSONAL CARE PRODUCTS, NAMELY, LOTIONS AND CREAMS, SHAMPOO, COLOGNE AND COLOGNE WATER, HAIR GEL, AFTER SHAVE BALMS, AFTER SHAVE CREAMS, BEAUTY CREAMS, LIPSTICK; SUNSCREEN PRODUCTS, NAMELY, SUNTAN LOTION; SUNSCREEN LOTION AND AFTER SUN CREAMS (U.S. CLS. 1, 4, 6, 50, 51 AND 52).

CLASS 9—ELECTRICAL AND SCIENTIFIC APPARATUS

FOR SPORTS HELMETS; PROTECTIVE SHOES (U.S. CLS. 21, 23, 26, 36 AND 38).

CLASS 25—CLOTHING

FOR CLOTHING, NAMELY, SHIRTS, PANTS, TIES, SWEATER, BLOUSE, JACKETS, SKIRTS, UNDERWEAR; FOOTWEAR, NAMELY, SPORTS SHOES AND SHOES FOR MEN AND WOMEN; HATS AND CAPS; WRISTBANDS; EXERCISE CLOTHING, NAMELY, GYM SUITS, SURF WEAR, SWEAT BANDS, SWEAT PANTS, SWEAT SHIRTS, SWEAT SUIT, TANK TOPS, MUSCLE TOPS, LEOTARDS, SHORTS, TOPS, LEGGINGS; HEADBANDS; SNEAKERS; SANDALS; BELTS; BATHING SUITS; UNDERCLOTHING; SPORTS UNIFORMS (U.S. CLS. 22 AND 39).

CLASS 28—TOYS AND SPORTING GOODS

FOR PROTECTIVE PADDING FOR PLAYING SPORTS; FOOTBALL EQUIPMENT, NAMELY, BALLS; SOFTBALL EQUIPMENT, NAMELY, SOFTBALLS AND BATS; BASEBALL EQUIPMENT, NAMELY, BASEBALL BATS, BALLS, BASEBALL GLOVES; BASKETBALL EQUIPMENT, NAMELY, BASKETS, BASKETBALLS, BASKETBALL GOAL SETS; HOCKEY EQUIPMENT, NAMELY, PUCKS, STICKS; SKATES; SOCCER EQUIPMENT, NAMELY, BALLS; PADDLEBALL EQUIPMENT, NAMELY, BALLS AND PADDLES; LACROSSE EQUIPMENT, NAMELY, STICKS, BALLS, NETS; BADMINTON SETS; PLASTIC BALLS, PLASTIC BATS AND PLASTIC BALL SETS; TOYS, NAMELY, STAND ALONE VIDEO GAME MACHINES, PLAYING CARDS, ACTION SKILL GAMES, ACTION TOYS; ADULT AND CHILDREN PARTY GAMES; ARCADE GAMES; PARLOR GAMES; BOARD GAMES; COIN-OPERATED VIDEO GAMES; COLLECTIBLE TOY FIGURES (U.S. CLS. 22, 23, 38 AND 50).

CLASS 29—MEATS AND PROCESSED FOODS

FOR PROCESSED MEATS; HAMBURGER MEATS; HOT DOG MEATS; PROTEIN BASED NUTRIENT DENSE ENERGY BARS; POTATO BASED SNACK FOODS; DAIRY BASED BEVERAGES; PACKAGED MEATS; SAUSAGES; PROCESSED NUTS AND PROCESSED PEANUTS (U.S. CL. 46).

CLASS 30—STAPLE FOODS

FOR ICE CREAM; FLAVORED ICES; SORBETS; CANDY; BREAKFAST CEREALS; CHEWING GUMS; PRETZELS; CORN BASED SNACK FOODS; BREADS; ROLLS; HAMBURGER BUNS; HOT DOGS BUNS (U.S. CL. 46).

CLASS 32—LIGHT BEVERAGES

FOR BEVERAGES, NAMELY, FRUIT AND JUICE DRINKS; NON-ALCOHOLIC BEVERAGES CONTAINING FRUIT JUICES (U.S. CLS. 45, 46 AND 48).

CLASS 33—WINES AND SPIRITS

FOR ALCOHOLIC BEVERAGES, NAMELY, BEER, WINE AND SPIRITS; ALCOHOLIC COCKTAILS CONTAINING MILK (U.S. CLS. 47 AND 49).

CLASS 43—HOTEL AND RESTAURANT SERVICES

FOR SERVICES FOR PROVIDING FOOD AND DRINK, NAMELY, RESTAURANT SERVICES (U.S. CLS. 100 AND 101).

JENNIFER KRISP, EXAMINING ATTORNEY

CLASS 41—EDUCATION AND ENTERTAINMENT

FOR PROVIDING INFORMATION ABOUT CERTIFICATION AND RECERTIFICATION PROGRAMS IN ACUPUNCTURE, CHINESE HERBOLOGY, ASIAN BODYWORK THERAPY, AND ORIENTAL MEDICINE; TESTING AND CERTIFICATION SERVICES, NAMELY, DEVELOPING, ADMINISTERING, AND SCORING STANDARDIZED COMPETENCY TESTS FOR CERTIFYING PRACTITIONERS OF ACUPUNCTURE, CHINESE HERBOLOGY, ASIAN BODYWORK THERAPY, AND ORIENTAL MEDICINE (U.S. CLS. 100, 101 AND 107).

CLASS 42—SCIENTIFIC, COMPUTER AND LEGAL SERVICES

FOR ESTABLISHING, DISSEMINATING, AND MONITORING EDUCATIONAL, COMPETENCY, AND ETHICAL STANDARDS IN ACUPUNCTURE, CHINESE HERBOLOGY, ASIAN BODYWORK THERAPY, AND ORIENTAL MEDICINE FOR THE PURPOSE OF ACCREDITATION (U.S. CLS. 100 AND 101).

YONG KIM, EXAMINING ATTORNEY

SN 78-679,185. NATIONAL CERTIFICATION COMMISSION FOR ACUPUNCTURE AND ORIENTAL MEDICINE, ALEXANDRIA, VA. FILED 7-27-2005.

SN 78-680,072. PRIVATE HEALTH INFORMATION SYSTEMS, JERICHO, NY. FILED 7-27-2005.

NCCAOM

THE MARK CONSISTS OF STANDARD CHARACTERS WITHOUT CLAIM TO ANY PARTICULAR FONT, STYLE, SIZE, OR COLOR.

OWNER OF U.S. REG. NO. 2,565,411.

CLASS 16—PAPER GOODS AND PRINTED MATTER

FOR PRINTED MATERIALS, NAMELY, NEWSLETTERS, PRESS RELEASES, STATIONERY, PAPER LABELS, HANDBOOKS, APPLICATION FORMS, TEST REGISTRATION FORMS, EXAMINATIONS, ANSWER SHEETS, AND BROCHURES RELATING TO THE CERTIFICATION AND RECERTIFICATION OF INDIVIDUALS IN ACUPUNCTURE, CHINESE HERBOLOGY, ASIAN BODYWORK THERAPY, AND ORIENTAL MEDICINE; AND OFFICE SUPPLIES, NAMELY, PENS, LETTERHEAD PAPER, BUSINESS FORMS, BUSINESS CARDS, DAILY PLANNERS, HIGHLIGHTERS, NOTE PADS, ENVELOPES, AND FOLDERS (U.S. CLS. 2, 5, 22, 23, 29, 37, 38 AND 50).

CLASS 25—CLOTHING

FOR CLOTHING, NAMELY, SHIRTS AND SWEATERS (U.S. CLS. 22 AND 39).

CLASS 35—ADVERTISING AND BUSINESS

FOR DEVELOPING AND DISTRIBUTING DIRECTORIES OF CERTIFIED PRACTITIONERS IN ACUPUNCTURE, CHINESE HERBOLOGY, ASIAN BODYWORK THERAPY, AND ORIENTAL MEDICINE; PROMOTING PUBLIC AWARENESS OF THE NEED FOR NATIONAL CERTIFICATION OF PRACTITIONERS OF ACUPUNCTURE, CHINESE HERBOLOGY, ASIAN BODYWORK THERAPY, AND ORIENTAL MEDICINE; REVIEWING THE QUALIFICATIONS OF INDIVIDUALS SEEKING CERTIFICATION AND RECERTIFICATION IN ACUPUNCTURE, CHINESE HERBOLOGY, ASIAN BODYWORK THERAPY, AND ORIENTAL MEDICINE FOR OTHERS (U.S. CLS. 100, 101 AND 102).

PHIS

THE MARK CONSISTS OF STANDARD CHARACTERS WITHOUT CLAIM TO ANY PARTICULAR FONT, STYLE, SIZE, OR COLOR.

CLASS 9—ELECTRICAL AND SCIENTIFIC APPARATUS

FOR PORTABLE MEMORY STORAGE MEDIA FEATURING PERSONAL ELECTRONIC MEDICAL RECORDS, NAMELY COMPUTER DISCS, OPTICAL DISCS, DVDS, CDS, FLASH MEMORY CARDS, PDAS, COMPUTER MEMORY DEVICES AND HARD DRIVES; COMPUTER SOFTWARE FOR CREATING AND ACCESSING PERSONAL PORTABLE ELECTRONIC MEDICAL RECORDS (U.S. CLS. 21, 23, 26, 36 AND 38).

FIRST USE 10-1-2004; IN COMMERCE 3-1-2005.

CLASS 39—TRANSPORTATION AND STORAGE

FOR STORAGE OF PERSONAL ELECTRONIC MEDICAL RECORDS ON PORTABLE MEMORY STORAGE MEDIA, NAMELY COMPUTER DISCS, OPTICAL DISCS, DVDS, CDS, FLASH MEMORY CARDS, PDAS, COMPUTER MEMORY DEVICES AND HARD DRIVES (U.S. CLS. 100 AND 105).

FIRST USE 10-1-2004; IN COMMERCE 3-1-2005.

CLASS 44—MEDICAL, BEAUTY AND AGRICULTURAL SERVICES

FOR MAINTAINING AND UPDATING FILES AND RECORDS CONCERNING THE MEDICAL CONDITION OF INDIVIDUALS AND THE STORAGE MEDIA CONTAINING SUCH FILES AND RECORDS (U.S. CLS. 100 AND 101).

FIRST USE 10-1-2004; IN COMMERCE 3-1-2005.

STEVEN R. FINE, EXAMINING ATTORNEY

SN 78-680,196. NATIONAL CERTIFICATION COMMISSION FOR ACUPUNCTURE AND ORIENTAL MEDICINE, ALEXANDRIA, VA. FILED 7-28-2005.



OWNER OF U.S. REG. NO. 2,565,411.
"THE COLOR(S) BLUE, LIGHT BLUE, AND WHITE IS/ ARE CLAIMED AS A FEATURE OF THE MARK."
THE MARK CONSISTS OF THE LETTERS 'NCCAOM,' A DIAMOND DESIGN ELEMENT, AND DESIGNS OF THE EARTH'S CONTINENTS. THE COLOR BLUE APPEARS IN THE DIAMOND DESIGN ELEMENT AND THE COLOR WHITE APPEARS IN THE LETTERS 'NCCAOM.' THE CONTINENT DESIGN ELEMENTS IN THE MARK ARE DEPICTED IN THE COLOR LIGHT BLUE.

CLASS 16—PAPER GOODS AND PRINTED MATTER

FOR PRINTED MATERIALS, NAMELY, NEWSLETTERS, PRESS RELEASES, STATIONERY, PAPER LABELS, HANDBOOKS, APPLICATION FORMS, TEST REGISTRATION FORMS, EXAMINATIONS, ANSWER SHEETS, AND BROCHURES RELATING TO THE CERTIFICATION AND RECERTIFICATION OF INDIVIDUALS IN ACUPUNCTURE, CHINESE HERBOLOGY, ASIAN BODYWORK THERAPY, AND ORIENTAL MEDICINE; AND OFFICE SUPPLIES, NAMELY, PENS, LETTERHEAD PAPER, BUSINESS FORMS, BUSINESS CARDS, DAILY PLANNERS, HIGHLIGHTERS, NOTE PADS, ENVELOPES, AND FOLDERS (U.S. CLS. 2, 5, 22, 23, 29, 37, 38 AND 50).

CLASS 25—CLOTHING

FOR CLOTHING, NAMELY, SHIRTS AND SWEATERS (U.S. CLS. 22 AND 39).

CLASS 35—ADVERTISING AND BUSINESS

FOR DEVELOPING AND DISTRIBUTING DIRECTORIES OF CERTIFIED PRACTITIONERS IN ACUPUNCTURE, CHINESE HERBOLOGY, ASIAN BODYWORK THERAPY, AND ORIENTAL MEDICINE; PROMOTING PUBLIC AWARENESS OF THE NEED FOR NATIONAL CERTIFICATION OF PRACTITIONERS OF ACUPUNCTURE, CHINESE HERBOLOGY, ASIAN BODYWORK THERAPY, AND ORIENTAL MEDICINE; REVIEWING THE QUALIFICATIONS OF INDIVIDUALS SEEKING CERTIFICATION AND RECERTIFICATION IN ACUPUNCTURE, CHINESE HERBOLOGY, ASIAN BODYWORK THERAPY, AND ORIENTAL MEDICINE FOR OTHERS (U.S. CLS. 100, 101 AND 102).

CLASS 41—EDUCATION AND ENTERTAINMENT

FOR PROVIDING INFORMATION ABOUT CERTIFICATION AND RECERTIFICATION PROGRAMS IN ACUPUNCTURE, CHINESE HERBOLOGY, ASIAN BODYWORK THERAPY, AND ORIENTAL MEDICINE; TESTING AND CERTIFICATION SERVICES, NAMELY, DEVELOPING, ADMINISTERING, AND SCORING STANDARDIZED COMPETENCY TESTS FOR CERTIFYING PRACTITIONERS OF ACUPUNCTURE, CHINESE HERBOLOGY, ASIAN BODYWORK THERAPY, AND ORIENTAL MEDICINE (U.S. CLS. 100, 101 AND 107).

CLASS 42—SCIENTIFIC, COMPUTER AND LEGAL SERVICES

FOR ESTABLISHING, DISSEMINATING, AND MONITORING EDUCATIONAL, COMPETENCY, AND ETHICAL STANDARDS IN ACUPUNCTURE, CHINESE HERBOLOGY, ASIAN BODYWORK THERAPY, AND ORIENTAL MEDICINE FOR THE PURPOSE OF ACCREDITATION (U.S. CLS. 100 AND 101).
YONG KIM, EXAMINING ATTORNEY

SN 78-680,202. NATIONAL CERTIFICATION COMMISSION FOR ACUPUNCTURE AND ORIENTAL MEDICINE, ALEXANDRIA, VA. FILED 7-28-2005.

PUBLIC PROTECTION THROUGH QUALITY CREDENTIALS

THE MARK CONSISTS OF STANDARD CHARACTERS WITHOUT CLAIM TO ANY PARTICULAR FONT, STYLE, SIZE, OR COLOR.

CLASS 16—PAPER GOODS AND PRINTED MATTER

FOR PRINTED MATERIALS, NAMELY, NEWSLETTERS, PRESS RELEASES, STATIONERY, PAPER LABELS, HANDBOOKS, APPLICATION FORMS, TEST REGISTRATION FORMS, EXAMINATIONS, ANSWER SHEETS, AND BROCHURES RELATING TO THE CERTIFICATION AND RECERTIFICATION OF INDIVIDUALS IN ACUPUNCTURE, CHINESE HERBOLOGY, ASIAN BODYWORK THERAPY, AND ORIENTAL MEDICINE; AND OFFICE SUPPLIES, NAMELY, PENS, LETTERHEAD PAPER, BUSINESS FORMS, BUSINESS CARDS, DAILY PLANNERS, HIGHLIGHTERS, NOTE PADS, ENVELOPES, AND FOLDERS (U.S. CLS. 2, 5, 22, 23, 29, 37, 38 AND 50).

CLASS 25—CLOTHING

FOR CLOTHING, NAMELY, SHIRTS AND SWEATERS (U.S. CLS. 22 AND 39).

CLASS 35—ADVERTISING AND BUSINESS

FOR DEVELOPING AND DISTRIBUTING DIRECTORIES OF CERTIFIED PRACTITIONERS IN ACUPUNCTURE, CHINESE HERBOLOGY, ASIAN BODYWORK THERAPY, AND ORIENTAL MEDICINE; PROMOTING PUBLIC AWARENESS OF THE NEED FOR NATIONAL CERTIFICATION OF PRACTITIONERS OF ACUPUNCTURE, CHINESE HERBOLOGY, ASIAN BODYWORK THERAPY, AND ORIENTAL MEDICINE; REVIEWING THE QUALIFICATIONS OF INDIVIDUALS SEEKING CERTIFICATION AND RECERTIFICATION IN ACUPUNCTURE, CHINESE HERBOLOGY, ASIAN BODYWORK THERAPY, AND ORIENTAL MEDICINE FOR OTHERS (U.S. CLS. 100, 101 AND 102).

CLASS 41—EDUCATION AND ENTERTAINMENT

FOR PROVIDING INFORMATION ABOUT CERTIFICATION AND RECERTIFICATION PROGRAMS IN ACUPUNCTURE, CHINESE HERBOLOGY, ASIAN BODYWORK THERAPY, AND ORIENTAL MEDICINE; TESTING AND CERTIFICATION SERVICES, NAMELY, DEVELOPING, ADMINISTERING, AND SCORING STANDARDIZED COMPETENCY TESTS FOR CERTIFYING PRACTITIONERS OF ACUPUNCTURE, CHINESE HERBOLOGY, ASIAN BODYWORK THERAPY, AND ORIENTAL MEDICINE (U.S. CLS. 100, 101 AND 107).

CLASS 42—SCIENTIFIC, COMPUTER AND LEGAL SERVICES

FOR ESTABLISHING, DISSEMINATING, AND MONITORING EDUCATIONAL, COMPETENCY, AND ETHICAL STANDARDS IN ACUPUNCTURE, CHINESE HERBOLOGY, ASIAN BODYWORK THERAPY, AND ORIENTAL MEDICINE FOR THE PURPOSE OF ACCREDITATION (U.S. CLS. 100 AND 101).
YONG KIM, EXAMINING ATTORNEY

CLASS 38—COMMUNICATION

FOR ELECTRONIC DATA INTERCHANGE (EDI) SERVICES (U.S. CLS. 100, 101 AND 104).
FIRST USE 7-31-2004; IN COMMERCE 11-6-2004.
STEVEN PEREZ, EXAMINING ATTORNEY

SN 78-680,230. FLATLINERS, LLC, CHESAPEAKE CITY, MD. FILED 7-28-2005.

MODERN DAY MARKET GUNNERS

THE MARK CONSISTS OF STANDARD CHARACTERS WITHOUT CLAIM TO ANY PARTICULAR FONT, STYLE, SIZE, OR COLOR.

NO CLAIM IS MADE TO THE EXCLUSIVE RIGHT TO USE "MARKET GUNNERS", APART FROM THE MARK AS SHOWN.

CLASS 9—ELECTRICAL AND SCIENTIFIC APPARATUS

FOR ENTERTAINMENT, NAMELY VIDEOS AND DVDS FEATURING HUNTING AND WATERFOWL (U.S. CLS. 21, 23, 26, 36 AND 38).

SN 78-681,036. WEHAH FARM, INC., DBA LUNDBERG FAMILY FARMS, RICHVALE, CA. FILED 7-28-2005.

LUNDBERG FAMILY FARMS
SINCE 1937

CLASS 18—LEATHER GOODS

FOR BACKPACKS (U.S. CLS. 1, 2, 3, 22 AND 41).

CLASS 25—CLOTHING

FOR HUNTING APPAREL, NAMELY HATS, JACKETS, SHIRTS AND PANTS (U.S. CLS. 22 AND 39).
AMEETA JORDAN, EXAMINING ATTORNEY

SN 78-681,010. COREPOLICY SYSTEMS, INC., PORTLAND, OR. FILED 7-28-2005.

MEDIAN

THE MARK CONSISTS OF STANDARD CHARACTERS WITHOUT CLAIM TO ANY PARTICULAR FONT, STYLE, SIZE, OR COLOR.

CLASS 35—ADVERTISING AND BUSINESS

FOR MANAGED CARE SERVICES, NAMELY, ELECTRONIC PROCESSING OF HEALTH CARE INFORMATION (U.S. CLS. 100, 101 AND 102).
FIRST USE 7-31-2004; IN COMMERCE 11-6-2004.

THE MARK CONSISTS OF STANDARD CHARACTERS WITHOUT CLAIM TO ANY PARTICULAR FONT, STYLE, SIZE, OR COLOR.

OWNER OF U.S. REG. NO. 3,080,848.
NO CLAIM IS MADE TO THE EXCLUSIVE RIGHT TO USE "FAMILY FARMS SINCE 1937", APART FROM THE MARK AS SHOWN.

CLASS 29—MEATS AND PROCESSED FOODS

FOR RICE-BASED BEVERAGES FOR USE AS MILK SUBSTITUTES (U.S. CL. 46).
FIRST USE 9-10-2001; IN COMMERCE 9-10-2001.

CLASS 30—STAPLE FOODS

FOR RICE; RICE PRODUCTS, NAMELY, RICE CAKES; POPCORN CAKES; BREAKFAST CEREAL; PROCESSED RICE CEREAL; RICE SYRUP FOR USE AS FLAVORING; NATURAL SWEETENER IN THE NATURE OF BROWN RICE SYRUP; RICE FLOUR; PASTA; RICE CHIPS; RISOTTO; PACKAGED SIDE DISHES CONSISTING PRIMARILY OF RICE, PACKAGED FOOD PRODUCTS, NAMELY, MEALS CONSISTING PRIMARILY OF RICE (U.S. CL. 46).

FIRST USE 9-0-1985; IN COMMERCE 9-0-1985.
MELISSA VALLILLO, EXAMINING ATTORNEY

SN 78-681,287. PFIZER INC., NEW YORK, NY. FILED 7-29-2005.

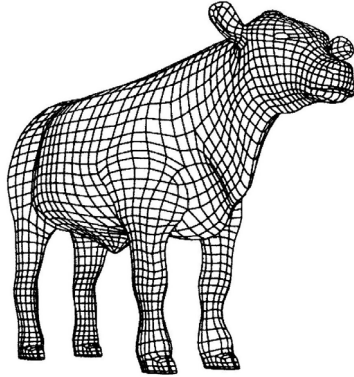

CLASS 9—ELECTRICAL AND SCIENTIFIC APPARATUS

FOR COMPUTER SOFTWARE FOR USE IN DATABASE MANAGEMENT CONTAINING INFORMATION RELATED TO ANIMAL HEALTH; COMPUTER SCREENSAVER SOFTWARE PROGRAMS, PRE-RECORDED CD-ROMS, VIDEO CASSETTES, AUDIO CASSETTES, AND DVD'S; ELECTRONIC PUBLICATIONS, NAMELY, EDUCATIONAL AND TRAINING MANUALS, INFORMATIONAL BOOKLETS, NEWSLETTERS, LEAFLETS, BROCHURES, PRODUCT SHEETS, FLYERS, CATALOGS, RECORDED ON ELECTRONIC MEDIA; ALL OF THE FOREGOING FEATURING INFORMATION RELATED TO ANIMAL HEALTH (U.S. CLS. 21, 23, 26, 36 AND 38).

CLASS 16—PAPER GOODS AND PRINTED MATTER

FOR PRINTED MATERIALS, NAMELY EDUCATIONAL AND TRAINING MANUALS, INFORMATIONAL BOOKLETS, NEWSLETTERS, LEAFLETS, BROCHURES, CHARTS, INFORMATIONAL PRODUCT SHEET FLYERS, MAGAZINES, CATALOGS, ALL RELATED TO ANIMAL HEALTH (U.S. CLS. 2, 5, 22, 23, 29, 37, 38 AND 50).

PAUL CROWLEY, EXAMINING ATTORNEY

SN 78-681,534. DNA DIAGNOSTICS CENTER, INC., FAIRFIELD, OH. FILED 7-29-2005.

DDC

THE MARK CONSISTS OF STANDARD CHARACTERS WITHOUT CLAIM TO ANY PARTICULAR FONT, STYLE, SIZE, OR COLOR.

CLASS 42—SCIENTIFIC, COMPUTER AND LEGAL SERVICES

FOR DNA TESTING FOR FORENSIC PURPOSES (U.S. CLS. 100 AND 101).

FIRST USE 2-8-2005; IN COMMERCE 2-8-2005.

CLASS 44—MEDICAL, BEAUTY AND AGRICULTURAL SERVICES

FOR MEDICAL TESTING, NAMELY, DNA TESTING AND PATERNITY TESTING (U.S. CLS. 100 AND 101). FIRST USE 2-8-2005; IN COMMERCE 2-8-2005. DEBRA LEE, EXAMINING ATTORNEY

SN 78-681,975. SPICE HUT CORPORATION, BELLINGHAM, WA. FILED 7-29-2005.

**TEAQUENT
STOP**

THE MARK CONSISTS OF THE WORDS "TEAQUENT STOP," WHERE THE "O" IN "STOP" IS A TEAPOT AND HAS A LEAF AS STEAM COMING OUT OF THE TEAPOT SPOUT FORMING A PORTION OF THE "Q".

CLASS 30—STAPLE FOODS

FOR TEA, LOOSE-LEAF TEA (U.S. CL. 46).

CLASS 35—ADVERTISING AND BUSINESS

FOR RETAIL STORES FEATURING TEA, FOOD ITEMS, TEA PRODUCTS AND TEA ACCESSORIES NAMELY: TEA DIFFUSERS, TEA MUGS, TEA POTS, TEA STRAINERS, TEA DIFFUSERS, TEA POTS; FOOD KIOSK SERVICES FEATURING TEA, LOOSE-LEAF TEAS AND TEA PRODUCTS; RETAIL STORE SERVICES FEATURING TEA, LOOSE-LEAF TEAS, TEA PRODUCTS, PASTRIES, COOKIES, AND SCONES (U.S. CLS. 100, 101 AND 102).

MARK SPARACINO, EXAMINING ATTORNEY

SN 78-682,120. SMILEY, KATHERINE K. ANCHORAGE, AK. FILED S.R. 7-30-2005; AM. P.R. 7-4-2006.



NO CLAIM IS MADE TO THE EXCLUSIVE RIGHT TO USE "ALASKA", APART FROM THE MARK AS SHOWN.

THE MARK CONSISTS OF TWO STYLIZED WORDS – THE SMALLER WORD ALASKA LOCATED ABOVE THE WORD FREEZE BOTH COVERED IN ICE WITH A FROZEN SOFTBALL CONNECTED.

CLASS 25—CLOTHING

FOR CLOTHING, NAMELY, JERSEYS, JACKETS, SWEAT PANTS, HATS, SWEATERS, SHIRTS, T-SHIRTS, AND SWEATSHIRTS (U.S. CLS. 22 AND 39).

FIRST USE 1-8-2001; IN COMMERCE 1-8-2001.

CLASS 41—EDUCATION AND ENTERTAINMENT

FOR ENTERTAINMENT SERVICES, NAMELY, PARTICIPATION IN FAST PITCH SOFTBALL (U.S. CLS. 100, 101 AND 107).

FIRST USE 1-8-2001; IN COMMERCE 1-8-2001.
TASNEEM HUSSAIN, EXAMINING ATTORNEY

SN 78-685,546. JOHN KNOX VILLAGE, LEE'S SUMMIT, MO.
FILED 8-4-2005.

JOHN KNOX VILLAGE

THE MARK CONSISTS OF STANDARD CHARACTERS WITHOUT CLAIM TO ANY PARTICULAR FONT, STYLE, SIZE, OR COLOR.

OWNER OF U.S. REG. NO. 1,024,379.

NO CLAIM IS MADE TO THE EXCLUSIVE RIGHT TO USE "VILLAGE", APART FROM THE MARK AS SHOWN.

THE NAME(S), PORTRAIT(S), AND/OR SIGNATURE(S) SHOWN IN THE MARK DOES NOT IDENTIFY A PARTICULAR LIVING INDIVIDUAL.

SN 78-685,522. GOAT FUNCTION LLC, BOULDER, CO.
FILED 8-4-2005.

**CLASS 43—HOTEL AND RESTAURANT SERVICES**

FOR CONTINUING CARE RETIREMENT COMMUNITY SERVICES FOR THE BENEFIT OF THE ELDERLY, NAMELY, RETIREMENT HOUSES (U.S. CLS. 100 AND 101).

FIRST USE 9-1-1972; IN COMMERCE 9-1-1972.

CLASS 44—MEDICAL, BEAUTY AND AGRICULTURAL SERVICES

FOR HEALTH CARE SERVICES FOR THE ELDERLY (U.S. CLS. 100 AND 101).

FIRST USE 9-1-1972; IN COMMERCE 9-1-1972.

CLASS 45—PERSONAL SERVICES

FOR SOCIAL SERVICES, NAMELY, COMPANIONSHIP SERVICES FOR THE ELDERLY (U.S. CLS. 100 AND 101).

FIRST USE 9-1-1972; IN COMMERCE 9-1-1972.

CHARLES L. JENKINS, EXAMINING ATTORNEY

SN 78-685,647. THE GILLETTE COMPANY, BOSTON, MA.
FILED 8-4-2005.

AQUATANICALS

THE MARK CONSISTS OF STANDARD CHARACTERS WITHOUT CLAIM TO ANY PARTICULAR FONT, STYLE, SIZE, OR COLOR.

CLASS 18—LEATHER GOODS

FOR MEN'S AND WOMEN'S LUGGAGE; BACKPACKS; MESSENGER BAGS; DUFFEL BAGS; ROLLING LUGGAGE AND BAGS; BRIEFCASES; CARRY-ON BAGS; HANDBAGS; SHOULDER BAGS; TOTE BAGS (U.S. CLS. 1, 2, 3, 22 AND 41).

CLASS 25—CLOTHING

FOR MEN'S AND WOMEN'S APPAREL AND CLOTHING, NAMELY, WOVEN SHIRTS, KNIT TOPS, T-SHIRTS, LONG SLEEVED PULLOVERS, FULL ZIP HOODED SHIRTS AND SWEATSHIRTS, PERFORMANCE AND CASUAL PANTS; MEN'S AND WOMEN'S CASUAL OUTERWEAR, NAMELY, JACKETS, WATER-PROOF JACKETS, INSULATED JACKETS AND PERFORMANCE PANTS, ALL MADE OF COTTON, NYLON, WOOL, POLYESTER, AND BLENDS OF THESE MATERIALS; MEN'S AND WOMEN'S FOOTWEAR; CASUAL FOOTWEAR FROM LEATHER, SYNTHETICS, NATURAL FIBERS; ATHLETIC FOOTWEAR FROM SYNTHETIC, NYLON, POLYESTER, AND OTHER MATERIALS; SHOES, AND BOOTS (U.S. CLS. 22 AND 39).

ALICE BENMAMAN, EXAMINING ATTORNEY

CLASS 1—CHEMICALS

FOR CHEMICAL ADDITIVES FOR USE IN SHAVING PREPARATIONS, DEPILATORIES, ANTIPERSPIRANTS, AND DEODORANTS (U.S. CLS. 1, 5, 6, 10, 26 AND 46).

CLASS 3—COSMETICS AND CLEANING PREPARATIONS

FOR SHAVING PREPARATIONS, NAMELY SHAVE FOAMS; DEPILATORIES; ANTIPERSPIRANTS AND DEODORANTS (U.S. CLS. 1, 4, 6, 50, 51 AND 52).

SCOTT SISUN, EXAMINING ATTORNEY

SN 78-685,956. CE RESOURCE, INC., ROSEVILLE, CA. FILED 8-4-2005.



EVIDENCE-BASED PRACTICE RECOMMENDATION

NO CLAIM IS MADE TO THE EXCLUSIVE RIGHT TO USE "EVIDENCE-BASED PRACTICE RECOMMENDATION", APART FROM THE MARK AS SHOWN.

THE MARK CONSISTS OF THE LETTERS "E" AND "B" ON TWO PIECES OF PAPERS.

CLASS 16—PAPER GOODS AND PRINTED MATTER

FOR BOOKLETS AND CATALOGS OF INSTRUCTIONAL TEACHING MATERIAL IN THE AREA OF CONTINUING MEDICAL EDUCATION (U.S. CLS. 2, 5, 22, 23, 29, 37, 38 AND 50).

CLASS 41—EDUCATION AND ENTERTAINMENT

FOR CONTINUING EDUCATION SERVICES, NAMELY, CONDUCTING ONLINE CONTINUING EDUCATION CLASSES IN THE FIELD OF MEDICAL EDUCATION (U.S. CLS. 100, 101 AND 107).

JAMES GRIFFIN, EXAMINING ATTORNEY

SN 78-686,593. LABORATORIOS ANDROMACO LDA, ALFRAGIDE, PORTUGAL, FILED 8-5-2005.

HALIBUT SENSIDERMA

THE MARK CONSISTS OF STANDARD CHARACTERS WITHOUT CLAIM TO ANY PARTICULAR FONT, STYLE, SIZE, OR COLOR.

CLASS 3—COSMETICS AND CLEANING PREPARATIONS

FOR SKIN CREAMS, CLEANSERS, SKIN LOTIONS AND MOISTURIZING STICKS FOR THE TREATMENT OF RASHES, SORES, VARICOSE ULCERS, BURNS, ECZEMA, ACNE, OPERATIVE INCISIONS, PREVENTION OF SUPPURATION, IRRITATIONS OR OTHER SKIN WOUNDS; SKIN CREAMS, CLEANSERS, SKIN LOTIONS AND MOISTURIZING STICKS FOR STIMULATING WOUND HEALING; SKIN CREAMS, CLEANSERS, SKIN LOTIONS AND MOISTURIZING STICKS WITH MARKED PROTECTIVE, REGENERATIVE, SOOTHING, AND ASTRINGENT ACTION; SKIN CREAMS, CLEANSERS, SKIN LOTIONS AND MOISTURIZING STICKS FOR PERSONS CONFINED TO BED REST DUE TO POOR HEALTH; SKIN CREAMS, CLEANSERS, SKIN LOTIONS AND MOISTURIZING STICKS FOR SKIN PROTECTION, MOISTURISATION AND REGENERATION; SKIN CREAMS, CLEANSERS, SKIN LOTIONS AND MOISTURIZING STICKS FOR LIP CARE AND PROTECTION, WITH THE EFFECT OF IMMEDIATE RELIEF, SOFTENING, MOISTURISING AND PREVENTION OF CHAPPING (U.S. CLS. 1, 4, 6, 50, 51 AND 52).

CLASS 5—PHARMACEUTICALS

FOR MEDICINAL SKIN CREAM, MEDICAL CLEANSERS, PHARMACEUTICAL SKIN LOTIONS AND MEDICATED BALMS IN THE FORM OF A STICK APPLICATOR FOR THE TREATMENT OF RASHES, SORES, VARICOSE ULCERS, BURNS, ECZEMA, ACNE, OPERATIVE INCISIONS, PREVENTION OF SUPPURATION, IRRITATIONS OR OTHER SKIN WOUNDS; MEDICINAL SKIN CREAM, MEDICAL CLEANSERS, PHARMACEUTICAL SKIN LOTIONS AND MEDICATED BALMS IN THE FORM OF A STICK APPLICATOR FOR STIMULATING WOUND HEALING; MEDICINAL SKIN CREAM, MEDICAL CLEANSERS, PHARMACEUTICAL SKIN LOTIONS AND MEDICATED BALMS IN THE FORM OF A STICK APPLICATOR WITH MARKED PROTECTIVE, REGENERATIVE, SOOTHING, ASTRINGENT AND ANTISEPTIC ACTION; MEDICINAL SKIN CREAM, MEDICAL CLEANSERS, PHARMACEUTICAL SKIN LOTIONS AND MEDICATED BALMS IN THE FORM OF A STICK APPLICATOR FOR SKIN PROTECTION, MOISTURISATION AND REGENERATION; MEDICINAL SKIN CREAM, MEDICAL CLEANSERS, PHARMACEUTICAL SKIN LOTIONS AND MEDICATED BALMS IN THE FORM OF A STICK APPLICATOR FOR LIP CARE AND PROTECTION, WITH THE EFFECT OF IMMEDIATE RELIEF, SOFTENING, MOISTURISING AND PREVENTION OF CHAPPING. (U.S. CLS. 6, 18, 44, 46, 51 AND 52).

KEVON CHISOLM, EXAMINING ATTORNEY

SN 78-686,692. FARIBAUT FOODS ILLINOIS, INC., MINNEAPOLIS, MN. FILED 8-5-2005.



OWNER OF U.S. REG. NOS. 1,923,909 AND 1,934,806. SEC. 2(F).

CLASS 29—MEATS AND PROCESSED FOODS

FOR CANNED CHILI (U.S. CL. 46). FIRST USE 8-25-1953; IN COMMERCE 8-25-1953.

CLASS 30—STAPLE FOODS

FOR POWDERED CHILI MIX AND CHILI SPICES (U.S. CL. 46).
FIRST USE 8-25-1953; IN COMMERCE 8-25-1953.
LAURA HAMMEL, EXAMINING ATTORNEY

SN 78-686,743. BSH HOME APPLIANCES CORPORATION,
HUNTINGTON BEACH, CA. FILED 8-5-2005.

CONCIERGE

THE MARK CONSISTS OF STANDARD CHARACTERS WITHOUT CLAIM TO ANY PARTICULAR FONT, STYLE, SIZE, OR COLOR.

CLASS 7—MACHINERY

FOR HOUSEHOLD AND KITCHEN MACHINES AND EQUIPMENT, NAMELY, ELECTRIC KITCHEN MACHINES AND EQUIPMENT, NAMELY, MINCING MACHINES, MIXING AND KNEADING MACHINES, JUICE EXTRACTORS, JUICE CENTRIFUGES, ELECTRIC FRUIT SQUEEZERS FOR HOUSEHOLD PURPOSES, GRINDERS, SLICING MACHINES; ELECTRIC MOTOR-DRIVEN TOOLS, NAMELY, ELECTRIC CAN OPENERS, ELECTRIC KNIFE SHARPENERS; FOOD MACHINES AND DEVICES FOR THE PREPARATION OF BEVERAGES AND/OR FOODS, NAMELY, ELECTRIC FOOD PROCESSORS, ELECTRIC BLENDERS; ELECTRIC WASTE DISPOSAL UNITS; NAMELY, GARBAGE DISPOSALS AND WASTE COMPRESSORS; DISHWASHERS; ELECTRIC MACHINES AND APPLIANCES FOR TREATING LAUNDRY AND CLOTHING, NAMELY, WASHING MACHINES, MANGLES; ELECTRIC CLEANING EQUIPMENT FOR HOUSEHOLD USE, NAMELY, VACUUM CLEANERS, AND REPLACEMENT PARTS THEREFOR (U.S. CLS. 13, 19, 21, 23, 31, 34 AND 35).

CLASS 9—ELECTRICAL AND SCIENTIFIC APPARATUS

FOR ELECTRONIC TIMERS; KITCHEN THERMOMETERS; SMOKE DETECTORS, ELECTRIC APPARATUS AND INSTRUMENTS, NAMELY, ELECTRIC IRONS; KITCHEN SCALES, PERSONAL SCALES; ELECTRIC FILM WRAP WELDING DEVICES, ELECTRIC APPARATUS FOR DISPENSING BEVERAGE OR FOODS, NAMELY, VENDING MACHINES, REMOTE CONTROL DEVICES, SIGNALING DEVICES FOR SENDING SIGNALS CONCERNING OPERATIONAL STATUS AND MAINTENANCE REQUIREMENTS OF HOUSEHOLD AND KITCHEN MACHINES AND EQUIPMENT, SUPERVISION CONTROL DEVICES FOR ADJUSTING THE OPERATION OF HOUSEHOLD AND KITCHEN MACHINES AND EQUIPMENT IN AN AUTOMATIC MANNER OR IN RESPONSE TO SIGNALS FROM A REMOTE LOCATION, AND MONITORING DEVICES FOR MONITORING OPERATIONAL STATUS AND MAINTENANCE REQUIREMENTS OF HOUSEHOLD AND KITCHEN MACHINES AND EQUIPMENT; RECORDED AND NOT RECORDED MACHINE READABLE DATA CARRIERS, NAMELY, MAGNETIC DATA CARRIERS FOR HOUSEHOLD APPLIANCES FOR HANDLING DATA CONCERNING OPERATIONAL STATUS AND MAINTENANCE REQUIREMENTS OF HOUSEHOLD AND KITCHEN MACHINES AND EQUIPMENT; ELECTRIC APPARATUS FOR DISPENSING BEVERAGE OR FOODS, NAMELY, VENDING MACHINES; DATA PROCESSING DEVICES AND DATA PROCESSING PROGRAMMES FOR CONTROLLING AND OPERATING HOUSEHOLD APPLIANCES, AND REPLACEMENT PARTS THEREFOR (U.S. CLS. 21, 23, 26, 36 AND 38).

CLASS 11—ENVIRONMENTAL CONTROL APPARATUS

FOR HEATING, STEAM PRODUCING, AND COOKING DEVICES, NAMELY, COOKING, BAKING, FRYING, GRILLING, TOASTING, THAWING, AND HOT-KEEPING APPARATUS, NAMELY, DOMESTIC COOKING OVENS, ELECTRIC AND GAS RANGES, COOK-TOPS, IMMERSION HEATERS, COOKING POTS WITH INTEGRATED HEATING, NAMELY, ELECTRIC COOKING POTS, MICROWAVE APPLIANCES, NAMELY, MICROWAVE OVENS, WARMING DRAWERS, TEA AND COFFEE MAKING APPARATUS, NAMELY, ELECTRIC COFFEE MACHINES, HOT WATER KETTLES, AND TEA POTS; COOLING DEVICES, NAMELY, REFRIGERATORS, FREEZERS, COMBINATION REFRIGERATOR-FREEZERS, DEEP FREEZERS, ICE-MAKERS, ICE-CREAM MACHINES; DRYERS, NAMELY, SPIN CLOTHES DRYERS, TUMBLE LAUNDRY DRYERS, HAND DRYERS, HAIR DRYERS; VENTILATION DEVICES, NAMELY, VENTILATORS, GREASE FILTER DEVICES; EXTRACTOR DEVICES, NAMELY, EXTRACTOR HOODS; AIR CONDITIONING DEVICES AND DEVICES TO IMPROVE AIR QUALITY, NAMELY, AIR HUMIDIFIERS, WARM WATER DEVICES, NAMELY, STORAGE WATER HEATERS AND CONTINUOUS FLOW WATER HEATERS; KITCHEN SINKS; HEAT PUMPS, REPLACEMENT PARTS THEREFOR (U.S. CLS. 13, 21, 23, 31 AND 34).

AMEETA JORDAN, EXAMINING ATTORNEY

SN 78-687,892. MILLER, ABIGAIL, PITTSBURGH, PA. FILED 8-8-2005.

BEFORE KIDS ...

CLASS 9—ELECTRICAL AND SCIENTIFIC APPARATUS

FOR DECORATIVE MAGNETS (U.S. CLS. 21, 23, 26, 36 AND 38).

CLASS 16—PAPER GOODS AND PRINTED MATTER

FOR CALENDARS, CHECK BOOK COVERS, CHECK BOOK HOLDERS, GREETING CARDS, NOTE PADS, ADHESIVE NOTE PADS, NOTE PADS WITH MAGNETIC BACKING, NOTE CARDS, PAPER NAPKINS AND STATIONERY SETS COMPRISING NOTE CARDS AND ENVELOPES (U.S. CLS. 2, 5, 22, 23, 29, 37, 38 AND 50).

CLASS 21—HOUSEWARES AND GLASS

FOR BEVERAGE WARE, DRINKING GLASSES, MUGS, STEMWARE AND WINE GLASSES (U.S. CLS. 2, 13, 23, 29, 30, 33, 40 AND 50).

CLASS 25—CLOTHING

FOR CLOTHING, NAMELY, SHORT SLEEVE SHIRTS, TANK TOPS, T-SHIRTS, NIGHT SHIRTS, SLEEP SHIRTS, PAJAMAS, SHORTS, UNDERGARMENTS, UNDERWEAR, SWEATSHIRTS, BEACH COVER-UPS AND CAMISOLES (U.S. CLS. 22 AND 39).

CLASS 35—ADVERTISING AND BUSINESS

FOR ON-LINE, RETAIL AND TELEPHONE ORDER TAKING SERVICES FEATURING CALENDARS, CHECK BOOK COVERS AND HOLDERS, GREETING CARDS, NOTE PADS, ADHESIVE NOTE PADS, NOTE PADS WITH MAGNETIZED BACKING, NOTE CARDS, NOTE CARDS AND ENVELOPE SETS, PAPER NAPKINS, BEVERAGE WARE, DRINKING GLASSES, MUGS, STEAMWARE, WINE GLASSES, NAIL FILES, MANICURE AND PEDICURE IMPLEMENTS, DECORATIVE MAGNETS, DIAPER BAGS, TOTE BAGS COSMETIC BAGS SOLD EMPTY, CARRY-ALL BAGS, CLOTHING COMPRISING SHORT SLEEVE SHIRTS, TANK TOPS, T-SHIRTS, NIGHT SHIRTS, SLEEP SHIRTS, PAJAMAS, SHORTS, UNDERGARMENTS, UNDERWEAR, SWEATSHIRTS, BEACH COVER-UPS AND CAMISOLES (U.S. CLS. 100, 101 AND 102).

BARBARA A. GOLD, EXAMINING ATTORNEY

SN 78-688,388. MITSUBISHI ELECTRIC CORPORATION, TOKYO, JAPAN, FILED 8-9-2005.

DIGITAL-FS

THE MARK CONSISTS OF STANDARD CHARACTERS WITHOUT CLAIM TO ANY PARTICULAR FONT, STYLE, SIZE, OR COLOR.

CLASS 7—MACHINERY

FOR ELECTRIC DISCHARGE MACHINES FOR USE IN METAL WORKING (U.S. CLS. 13, 19, 21, 23, 31, 34 AND 35).

CLASS 9—ELECTRICAL AND SCIENTIFIC APPARATUS

FOR ELECTRICAL POWER SUPPLIES FOR ELECTRIC DISCHARGE MACHINES FOR USE IN METAL WORKING (U.S. CLS. 21, 23, 26, 36 AND 38).

C. DIONNE CLYBURN, EXAMINING ATTORNEY

SN 78-688,047. ALHI SALES INC., MIAMI, FL. FILED 8-8-2005.

CARMEN'S KITCHEN

THE MARK CONSISTS OF STANDARD CHARACTERS WITHOUT CLAIM TO ANY PARTICULAR FONT, STYLE, SIZE, OR COLOR.

NO CLAIM IS MADE TO THE EXCLUSIVE RIGHT TO USE "KITCHEN", APART FROM THE MARK AS SHOWN.

CLASS 8—HAND TOOLS

FOR KITCHEN UTENSILS, NAMELY, SPOONS, FORKS, LADLES, TURNERS, SKIMMERS, MEAT TENDERIZERS, NAMELY, A KITCHEN Mallet, PLANTAIN SLICERS, AND MORTARS AND PESTLES (U.S. CLS. 23, 28 AND 44).

FIRST USE 8-1-1995; IN COMMERCE 8-30-1992.

CLASS 21—HOUSEWARES AND GLASS

FOR COOKWARE, NAMELY, POTS, PANS, SKILLETS, STOCK POTS, FRY PANS, DEEP FRYERS, STEAMERS, AND GRIDDLES; ROLLING PINS, PLANTAIN SMASHERS, MOLINILLOS, NAMELY, PEPPER GRINDERS, CUTTING BOARDS, LEMON SQUEEZERS, TORTILLA PRESSES AND TORTILLA WARMERS, FRYER BASKETS, SIEVES NAMELY COOKING STRAINERS, COOKING OIL DISPENSERS, SALSA DISHES, MUGS, STOVE BURNER COVERS; DINNERWARE, NAMELY, PLATES, BOWLS, MUGS, CUPS AND SAUCERS; NON-ELECTRIC ESPRESSO COFFEE MAKERS AND FROTHING MUGS; DEMITASSE CUPS AND SAUCERS AND STANDS THEREFOR; ESPRESSO GLASS VACUUM PITCHERS; BROOMS AND DUSTPANS (U.S. CLS. 2, 13, 23, 29, 30, 33, 40 AND 50).

FIRST USE 8-1-1995; IN COMMERCE 8-30-1995.
ODESSA BIBBINS, EXAMINING ATTORNEY

SN 78-688,572. DAKIM, INC., SANTA MONICA, CA. FILED 8-9-2005.

DAKIM

THE MARK CONSISTS OF STANDARD CHARACTERS WITHOUT CLAIM TO ANY PARTICULAR FONT, STYLE, SIZE, OR COLOR.

CLASS 9—ELECTRICAL AND SCIENTIFIC APPARATUS

FOR INTEGRATED COMPUTER HARDWARE AND SOFTWARE SYSTEMS COMPRISED OF DATA PROCESSING EQUIPMENT, COMPUTER HARDWARE, AND COMPUTER SOFTWARE FOR PROVIDING INDIVIDUALS SUFFERING FROM THE SYMPTOMS DERIVED FROM MENTAL IMPAIRMENT OR DECLINE, COGNITIVE MENTAL STIMULATION OR REHABILITATION EXERCISES TO ABATE THE PROGRESS OF THE IMPAIRMENT OR DECLINE AND TO INDIVIDUALS DESIROUS OF MAINTAINING OR IMPROVING THEIR PRESENT NORMAL MENTAL CONDITION BY PRESENTING THE INDIVIDUAL WITH A SEQUENCE OF MENTALLY STIMULATING INTERACTIVE AUDIO/VISUAL QUESTION AND ANSWER EXERCISES THAT ARE CHANGEABLE BASED UPON THE INDIVIDUAL'S PRIOR RESPONSE TO AN EXERCISE (U.S. CLS. 21, 23, 26, 36 AND 38).

FIRST USE 12-31-2001; IN COMMERCE 12-31-2001.

CLASS 44—MEDICAL, BEAUTY AND AGRICULTURAL SERVICES

FOR MENTAL HEALTH THERAPY SERVICES IN THE FIELD OF COGNITIVE MENTAL STIMULATION AND REHABILITATION EXERCISES TO INDIVIDUALS SUFFERING FROM THE SYMPTOMS OF MENTAL IMPAIRMENT OR DECLINE AND TO INDIVIDUALS DESIROUS OF MAINTAINING OR IMPROVING THEIR PRESENT NORMAL MENTAL CONDITION; PROVIDING INFORMATION, INCLUDING THERAPY PROTOCOLS, IN THE FIELD OF THE ABATEMENT OF THE PROGRESS OF MENTAL IMPAIRMENT OR DECLINE IN INDIVIDUALS AND FOR MAINTAINING OR IMPROVING NORMAL MENTAL CONDITION IN INDIVIDUALS (U.S. CLS. 100 AND 101).

FIRST USE 12-31-2001; IN COMMERCE 12-31-2001.
JIM RINGLE, EXAMINING ATTORNEY

CLASS 16—PAPER GOODS AND PRINTED MATTER

FOR BOOKS, PAMPHLETS AND MANUALS IN THE FIELDS OF BUSINESS, NAMELY MARKETING PLANS, INTERNET USE, EVENT MARKETING, TRADE SHOWS, PROMOTIONAL MATERIALS, COMMUNICATION SYSTEMS, SALES, EMPLOYEE DEVELOPMENT, EMPLOYEE MANUALS, HIRING PROCEDURES, HUMAN RESOURCES, INCENTIVE PROGRAMS, CONTESTS, EMPLOYEE COMPENSATION SYSTEMS, CREATING AN IMPROVED WORK ENVIRONMENT, AND TAI CHI (U.S. CLS. 2, 5, 22, 23, 29, 37, 38 AND 50).

FIRST USE 12-31-1985; IN COMMERCE 12-31-1985.

SN 78-689,509. GLOBAL SPORTS CONSULTANTS, LLC, DBA JET SET SPORTS, FAR HILLS, NJ. FILED 8-10-2005.

JET SET SPORTS

THE MARK CONSISTS OF STANDARD CHARACTERS WITHOUT CLAIM TO ANY PARTICULAR FONT, STYLE, SIZE, OR COLOR.

NO CLAIM IS MADE TO THE EXCLUSIVE RIGHT TO USE "SPORTS", APART FROM THE MARK AS SHOWN.

CLASS 9—ELECTRICAL AND SCIENTIFIC APPARATUS

FOR SCUBA EQUIPMENT, NAMELY, GOGGLES, SNORKELS, DIVING MASKS; SKI GOGGLES; MAGNETICALLY ENCODED CREDIT CARDS (U.S. CLS. 21, 23, 26, 36 AND 38).

CLASS 16—PAPER GOODS AND PRINTED MATTER

FOR CREDIT CARDS WITHOUT MAGNETIC CODING (U.S. CLS. 2, 5, 22, 23, 29, 37, 38 AND 50).
JOHN DALIER, EXAMINING ATTORNEY

CLASS 35—ADVERTISING AND BUSINESS

FOR CONSULTING SERVICES RELATED TO BUSINESS MANAGEMENT; ADVISORY SERVICES RELATING TO BUSINESS MANAGEMENT; CONSULTING AND BUSINESS MANAGEMENT CONSULTING IN THE FIELDS OF MARKETING PLANS, INTERNET USE, EVENT MARKETING, TRADE SHOWS, PROMOTIONAL MATERIALS, COMMUNICATION SYSTEMS, SALES, EMPLOYEE DEVELOPMENT, EMPLOYEE MANUALS, HIRING PROCEDURES, HUMAN RESOURCES, INCENTIVE PROGRAMS, CONTESTS, EMPLOYEE COMPENSATION SYSTEMS, CREATING AN IMPROVED WORK ENVIRONMENT, AND TAI CHI BUSINESS INFORMATION SYSTEMS, NAMELY PROVIDING INFORMATION FOR BUSINESSES CONCERNING MARKETING PLANS, INTERNET USE, EVENT MARKETING, TRADE SHOWS, PROMOTIONAL MATERIALS, COMMUNICATION SYSTEMS, SALES, EMPLOYEE DEVELOPMENT, EMPLOYEE MANUALS, HIRING PROCEDURES, HUMAN RESOURCES, INCENTIVE PROGRAMS, CONTESTS, EMPLOYEE COMPENSATION SYSTEMS, CREATING AN IMPROVED WORK ENVIRONMENT, AND TAI CHI (U.S. CLS. 100, 101 AND 102).

FIRST USE 12-31-1985; IN COMMERCE 12-31-1985.

SN 78-691,398. SALES CREATORS, INCORPORATED, SPOKANE, WA. FILED 8-12-2005.

SALES CREATORS

THE MARK CONSISTS OF STANDARD CHARACTERS WITHOUT CLAIM TO ANY PARTICULAR FONT, STYLE, SIZE, OR COLOR.

NO CLAIM IS MADE TO THE EXCLUSIVE RIGHT TO USE "SALES", APART FROM THE MARK AS SHOWN.

CLASS 41—EDUCATION AND ENTERTAINMENT

FOR PROVIDING OF TRAINING AND INSTRUCTION IN THE FIELDS OF BUSINESS, NAMELY MARKETING PLANS, INTERNET USE, EVENT MARKETING, TRADE SHOWS, PROMOTIONAL MATERIALS, COMMUNICATION SYSTEMS, SALES, EMPLOYEE DEVELOPMENT, EMPLOYEE MANUALS, HIRING PROCEDURES, HUMAN RESOURCES, INCENTIVE PROGRAMS, CONTESTS, EMPLOYEE COMPENSATION SYSTEMS, CREATING AN IMPROVED WORK ENVIRONMENT, AND TAI CHI; AND EDUCATION SERVICES, NAMELY CONDUCTING, SEMINARS, CONFERENCES, WORKSHOPS AND MEETING IN THE FIELDS OF BUSINESS, NAMELY MARKETING PLANS, INTERNET USE, EVENT MARKETING, TRADE SHOWS, PROMOTIONAL MATERIALS, COMMUNICATION SYSTEMS, SALES, EMPLOYEE DEVELOPMENT, EMPLOYEE MANUALS, HIRING PROCEDURES, HUMAN RESOURCES, INCENTIVE PROGRAMS, CONTESTS, EMPLOYEE COMPENSATION SYSTEMS, CREATING AN IMPROVED WORK ENVIRONMENT, AND TAI CHI (U.S. CLS. 100, 101 AND 107).

FIRST USE 12-31-1985; IN COMMERCE 12-31-1985.
ANTHONY RINKER, EXAMINING ATTORNEY

SN 78-691,761. DATRAN MEDIA, L.L.C., NEW YORK, NY.
FILED 8-12-2005.

SN 78-692,958. JDS UNIPHASE CORPORATION, MILPITAS,
CA. FILED 8-15-2005.



JDSU

CLASS 35—ADVERTISING AND BUSINESS

FOR BUSINESS MARKETING AND MANAGEMENT CONSULTATION SERVICES, NAMELY, PROVIDING ONLINE DATA COLLECTION, DATA VERIFICATION, DATA DELIVERY, ONLINE REPORTING AND ANALYTICS FOR OPTIMIZING THE WEBSITE TRAFFIC OF OTHERS (U.S. CLS. 100, 101 AND 102).

FIRST USE 5-1-2005; IN COMMERCE 5-1-2005.

CLASS 42—SCIENTIFIC, COMPUTER AND LEGAL SERVICES

FOR PROVIDING ONLINE, NON-DOWNLOADABLE SOFTWARE FOR DATA COLLECTION, DATA VERIFICATION, DATA DELIVERY, ONLINE REPORTING AND ANALYTICS FOR OPTIMIZING THE WEBSITE TRAFFIC OF OTHERS (U.S. CLS. 100 AND 101).

FIRST USE 5-1-2005; IN COMMERCE 5-1-2005.
WILLIAM ROSSMAN, EXAMINING ATTORNEY

SN 78-692,815. HUMANA MILITARY HEALTHCARE SERVICES, INC., LOUISVILLE, KY. FILED 8-15-2005.

HUMANA MILITARY
HEALTHCARE SERVICES



NO CLAIM IS MADE TO THE EXCLUSIVE RIGHT TO USE MILITARY HEALTHCARE SERVICES, APART FROM THE MARK AS SHOWN.

CLASS 35—ADVERTISING AND BUSINESS

FOR MANAGEMENT OF THE HEALTH BENEFIT PLANS FOR OTHERS; PHYSICIAN REFERRALS (U.S. CLS. 100, 101 AND 102).

FIRST USE 6-1-2005; IN COMMERCE 6-1-2005.

CLASS 44—MEDICAL, BEAUTY AND AGRICULTURAL SERVICES

FOR PROVIDING HEALTH CARE INFORMATION, AND PROVIDING INFORMATION ABOUT NUTRITION, WELLNESS, FITNESS AND HEALTHY HABITS; HEALTH MAINTENANCE ORGANIZATIONS AND PREFERRED PROVIDER ORGANIZATIONS SERVICES TO BENEFICIARIES AND PROVIDERS IN THE FIELD OF HEALTH CARE AND PRESCRIPTION DRUGS; DISEASE MANAGEMENT SERVICES (U.S. CLS. 100 AND 101).

FIRST USE 6-1-2005; IN COMMERCE 6-1-2005.
SUSAN LESLIE DUBOIS, EXAMINING ATTORNEY

THE MARK CONSISTS OF STANDARD CHARACTERS WITHOUT CLAIM TO ANY PARTICULAR FONT, STYLE, SIZE, OR COLOR.

CLASS 2—PAINTS

FOR OPTICAL COATINGS; PIGMENTS; FLEXOGRAPHIC, INTAGLIO, AND GRAVURE INKS, AND HIGH PERFORMANCE COATINGS AND DISPERSIONS TO PROVIDE SECURITY AND BRAND PROTECTION, AUTHENTICATION, AND DIFFERENTIATION (U.S. CLS. 6, 11 AND 16).

CLASS 9—ELECTRICAL AND SCIENTIFIC APPARATUS

FOR COMMUNICATIONS HARDWARE AND SOFTWARE FOR CONNECTING ELECTRONIC COMMUNICATIONS NETWORKS; TELECOMMUNICATIONS AND DATA NETWORKING HARDWARE AND SOFTWARE, NAMELY DEVICES FOR TRANSMITTING, ROUTING, AND RECEIVING AUDIO, VIDEO, AND OTHER DATA ACROSS NETWORKS; COMPUTER HARDWARE FOR TELECOMMUNICATIONS; COMPUTER HARDWARE; HARDWARE, SOFTWARE AND SYSTEMS, NAMELY TELECOMMUNICATIONS AND DATA NETWORKING HARDWARE, SOFTWARE, AND COMPONENTS FOR TESTING AND MEASUREMENT OF TELECOMMUNICATIONS AND NETWORKING HARDWARE, SOFTWARE AND SYSTEMS; COMPUTER IMAGING HARDWARE; LASERS NOT FOR MEDICAL USE; SEMICONDUCTORS; COMMUNICATIONS, TELECOMMUNICATIONS, OPTICAL AND COMPUTING SWITCHES, ADAPTORS, CONNECTORS, SPLITTERS, COUPLERS, METERS, MODULATORS, RECEIVERS, AMPLIFIERS, TRANSMITTERS, MONITORS, TEST SYSTEMS; TRANSCIEVERS; TRANSPONDERS; MULTIPLEXERS; SCIENTIFIC AND TECHNICAL APPARATUS, NAMELY, OPTICAL MIRRORS; OPTICAL FILTERS; OPTICAL LENSES; POWER CONVERTERS; POWER SUPPLIES; LIQUID CRYSTAL DISPLAYS; LIQUID CRYSTAL DISPLAY PROJECTORS; IMAGE PROJECTORS; INTERNALLY ILLUMINATED SIGN AND LIGHT ENGINES; MOUNTING RACKS FOR COMMUNICATIONS OR COMPUTER HARDWARE, TELECOMMUNICATIONS HARDWARE OR COMPUTER HARDWARE (U.S. CLS. 21, 23, 26, 36 AND 38).

CLASS 16—PAPER GOODS AND PRINTED MATTER

FOR PAPER LABELS; PRINTED PAPER LABELS; ADHESIVE LABELS; COUPONS; COUPON BOOKS (U.S. CLS. 2, 5, 22, 23, 29, 37, 38 AND 50).

CLASS 20—FURNITURE AND ARTICLES NOT OTHERWISE CLASSIFIED

FOR PLASTIC LABELS (U.S. CLS. 2, 13, 22, 25, 32 AND 50).

CLASS 24—FABRICS

FOR CLOTH LABELS; TEXTILE LABELS (U.S. CLS. 42 AND 50).

CLASS 37—CONSTRUCTION AND REPAIR

FOR REPAIR AND MAINTENANCE OF COMPUTER AND COMMUNICATIONS HARDWARE AND SOFTWARE AND MEDICAL DEVICES (U.S. CLS. 100, 103 AND 106).

CLASS 41—EDUCATION AND ENTERTAINMENT

FOR EDUCATION SERVICES, NAMELY, PROVIDING CLASSES, SEMINARS, AND WORKSHOPS IN THE FIELDS OF THE DESIGN, SELECTION, IMPLEMENTATION, INSTALLATION, USE, AND TESTING OF COMMUNICATIONS SYSTEMS AND EQUIPMENT FOR OTHERS AND IN THE FIELDS OF PRODUCT SECURITY, COMMUNICATIONS NETWORKS, OPTICAL NETWORKS, OPTICAL HARDWARE, COMMUNICATIONS HARDWARE AND FIBER OPTICS; TRAINING SERVICES IN THE FIELDS OF THE DESIGN, SELECTION, IMPLEMENTATION, INSTALLATION, USE, AND TESTING OF COMMUNICATIONS SYSTEMS AND EQUIPMENT FOR OTHERS AND IN THE FIELDS OF PRODUCT SECURITY, COMMUNICATIONS NETWORKS, OPTICAL HARDWARE, COMMUNICATIONS HARDWARE, AND FIBER OPTICS (U.S. CLS. 100, 101 AND 107).

CLASS 42—SCIENTIFIC, COMPUTER AND LEGAL SERVICES

FOR CONSULTATION SERVICES IN THE FIELDS OF THE DESIGN, SELECTION, IMPLEMENTATION, INSTALLATION, USE, AND TESTING OF COMMUNICATIONS SYSTEMS AND EQUIPMENT FOR OTHERS; CONSULTATION SERVICES IN THE FIELDS OF PRODUCT SECURITY, COMMUNICATIONS HARDWARE, COMMUNICATIONS NETWORKS, OPTICAL NETWORKS, OPTICAL HARDWARE, FIBER OPTICS; ENGINEERING; DESIGN FOR OTHERS IN THE FIELDS OF PRINTING, PRODUCT SECURITY, COMMUNICATIONS HARDWARE, COMPUTER HARDWARE, OPTICAL HARDWARE, FIBER OPTICS (U.S. CLS. 100 AND 101).

ANNE E. GUSTASON, EXAMINING ATTORNEY

SN 78-692.980. JDS UNIPHASE CORPORATION, SAN JOSE, CA. FILED 8-15-2005.

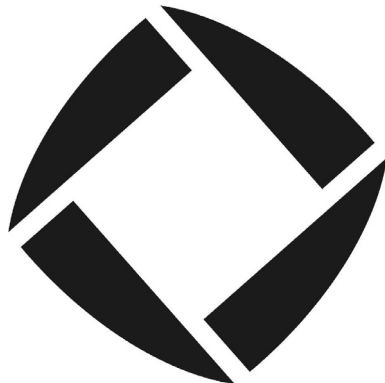
**CLASS 2—PAINTS**

FOR OPTICAL COATINGS; PIGMENTS; FLEXOGRAPHIC, INTAGLIO, AND GRAVURE INKS, AND HIGH PERFORMANCE COATINGS AND DISPERSIONS TO PROVIDE SECURITY AND BRAND PROTECTION, AUTHENTICATION, AND DIFFERENTIATION (U.S. CLS. 6, 11 AND 16).

CLASS 9—ELECTRICAL AND SCIENTIFIC APPARATUS

FOR COMMUNICATIONS HARDWARE AND SOFTWARE FOR CONNECTING ELECTRONIC COMMUNICATIONS NETWORKS; TELECOMMUNICATIONS AND DATA NETWORKING HARDWARE AND SOFTWARE, NAMELY DEVICES FOR TRANSMITTING, ROUTING, AND RECEIVING AUDIO, VIDEO, AND OTHER DATA ACROSS NETWORKS; COMPUTER HARDWARE FOR TELECOMMUNICATIONS; COMPUTER HARDWARE; HARDWARE, SOFTWARE AND SYSTEMS, NAMELY TELECOMMUNICATIONS AND DATA NETWORKING HARDWARE, SOFTWARE, AND COMPONENTS FOR TESTING AND MEASUREMENT OF TELECOMMUNICATIONS AND NETWORKING HARDWARE, SOFTWARE AND SYSTEMS; COMPUTER IMAGING HARDWARE; LASERS NOT FOR MEDICAL USE; SEMICONDUCTORS; COMMUNICATIONS, TELECOMMUNICATIONS, OPTICAL AND COMPUTING SWITCHES, ADAPTORS, CONNECTORS, SPLITTERS, COUPLERS, METERS, MODULATORS, RECEIVERS, AMPLIFIERS, TRANSMITTERS, MONITORS, TEST SYSTEMS; TRANSCEIVERS; TRANSPONDERS; MULTIPLEXERS; SCIENTIFIC AND TECHNICAL APPARATUS, NAMELY, OPTICAL MIRRORS; OPTICAL FILTERS; OPTICAL LENSES; POWER CONVERTERS; POWER SUPPLIES; LIQUID CRYSTAL DISPLAYS; LIQUID CRYSTAL DISPLAY PROJECTORS; IMAGE PROJECTORS; INTERNALLY ILLUMINATED SIGN AND LIGHT ENGINES; MOUNTING RACKS FOR COMMUNICATIONS OR COMPUTER HARDWARE, TELECOMMUNICATIONS HARDWARE OR COMPUTER HARDWARE (U.S. CLS. 21, 23, 26, 36 AND 38).

CLASS 16—PAPER GOODS AND PRINTED MATTER

FOR PAPER LABELS; PRINTED PAPER LABELS; ADHESIVE LABELS; COUPONS; COUPON BOOKS (U.S. CLS. 2, 5, 22, 23, 29, 37, 38 AND 50).

CLASS 20—FURNITURE AND ARTICLES NOT OTHERWISE CLASSIFIED

FOR PLASTIC LABELS (U.S. CLS. 2, 13, 22, 25, 32 AND 50).

CLASS 24—FABRICS

FOR CLOTH LABELS; TEXTILE LABELS (U.S. CLS. 42 AND 50).

CLASS 37—CONSTRUCTION AND REPAIR

FOR REPAIR AND MAINTENANCE OF COMPUTER AND COMMUNICATIONS HARDWARE AND SOFTWARE AND MEDICAL DEVICES (U.S. CLS. 100, 103 AND 106).

CLASS 41—EDUCATION AND ENTERTAINMENT

FOR EDUCATION SERVICES, NAMELY, PROVIDING CLASSES, SEMINARS, AND WORKSHOPS IN THE FIELDS OF THE DESIGN, SELECTION, IMPLEMENTATION, INSTALLATION, USE, AND TESTING OF COMMUNICATIONS SYSTEMS AND EQUIPMENT FOR OTHERS, AND IN THE FIELDS OF PRODUCT SECURITY, COMMUNICATIONS NETWORKS, OPTICAL NETWORKS, OPTICAL HARDWARE, COMMUNICATIONS HARDWARE AND FIBER OPTICS; TRAINING SERVICES IN THE FIELDS OF THE DESIGN, SELECTION, IMPLEMENTATION, INSTALLATION, USE, AND TESTING OF COMMUNICATIONS SYSTEMS AND EQUIPMENT FOR OTHERS, AND IN THE FIELDS OF PRODUCT SECURITY, COMMUNICATIONS NETWORKS, OPTICAL HARDWARE, COMMUNICATIONS HARDWARE, AND FIBER OPTICS (U.S. CLS. 100, 101 AND 107).

CLASS 42—SCIENTIFIC, COMPUTER AND LEGAL SERVICES

FOR CONSULTATION SERVICES IN THE FIELDS OF THE DESIGN, SELECTION, IMPLEMENTATION, INSTALLATION, USE, AND TESTING OF COMMUNICATIONS SYSTEMS AND EQUIPMENT FOR OTHERS; CONSULTATION SERVICES IN THE FIELDS OF PRODUCT SECURITY, COMMUNICATIONS HARDWARE, COMMUNICATIONS NETWORKS, OPTICAL NETWORKS, OPTICAL HARDWARE, FIBER OPTICS; ENGINEERING; DESIGN FOR OTHERS IN THE FIELDS OF PRINTING, PRODUCT SECURITY, COMMUNICATIONS HARDWARE, COMPUTER HARDWARE, OPTICAL HARDWARE, FIBER OPTICS (U.S. CLS. 100 AND 101).

ANNE E. GUSTASON, EXAMINING ATTORNEY

SN 78-692,990. JDS UNIPHASE CORPORATION, SAN JOSE, CA. FILED 8-15-2005.

**CLASS 2—PAINTS**

FOR OPTICAL COATINGS; PIGMENTS; FLEXOGRAPHIC, INTAGLIO, AND GRAVURE INKS, AND HIGH PERFORMANCE COATINGS AND DISPERSIONS TO PROVIDE SECURITY AND BRAND PROTECTION, AUTHENTICATION, AND DIFFERENTIATION (U.S. CLS. 6, 11 AND 16).

CLASS 9—ELECTRICAL AND SCIENTIFIC APPARATUS

FOR COMMUNICATIONS HARDWARE AND SOFTWARE FOR CONNECTING ELECTRONIC COMMUNICATIONS NETWORKS; TELECOMMUNICATIONS AND DATA NETWORKING HARDWARE AND SOFTWARE, NAMELY DEVICES FOR TRANSMITTING, ROUTING, AND RECEIVING AUDIO, VIDEO, AND OTHER DATA ACROSS NETWORKS; COMPUTER HARDWARE FOR TELECOMMUNICATIONS; COMPUTER HARDWARE; HARDWARE, SOFTWARE AND SYSTEMS, NAMELY TELECOMMUNICATIONS AND DATA NETWORKING HARDWARE, SOFTWARE, AND COMPONENTS FOR TESTING AND MEASUREMENT OF TELECOMMUNICATIONS AND NETWORKING HARDWARE, SOFTWARE AND SYSTEMS; COMPUTER IMAGING HARDWARE; LASERS NOT FOR MEDICAL USE; SEMICONDUCTORS; COMMUNICATIONS, TELECOMMUNICATIONS, OPTICAL AND COMPUTING SWITCHES, ADAPTORS, CONNECTORS, SPLITTERS, COUPLERS, METERS, MODULATORS, RECEIVERS, AMPLIFIERS, TRANSMITTERS, MONITORS, TEST SYSTEMS; TRANSCIEVERS; TRANSPONDERS; MULTIPLEXERS; SCIENTIFIC AND TECHNICAL APPARATUS, NAMELY, OPTICAL MIRRORS; OPTICAL FILTERS; OPTICAL LENSES; POWER CONVERTERS; POWER SUPPLIES; LIQUID CRYSTAL DISPLAYS; LIQUID CRYSTAL DISPLAY PROJECTORS; IMAGE PROJECTORS; INTERNALLY ILLUMINATED SIGN AND LIGHT ENGINES; MOUNTING RACKS FOR COMMUNICATIONS OR COMPUTER HARDWARE, TELECOMMUNICATIONS HARDWARE OR COMPUTER HARDWARE (U.S. CLS. 21, 23, 26, 36 AND 38).

ANNE E. GUSTASON, EXAMINING ATTORNEY

SN 78-693,229. MTS EUROPE GMBH, KONSTANZ, FED REP GERMANY, FILED 8-16-2005.



THE COLOR(S) BLUE AND BLACK IS/ARE CLAIMED AS A FEATURE OF THE MARK.

THE COLOR BLUE APPEARS IN THE FULLY SHADED SQUARE ON THE LEFT SIDE OF THE MARK. THE LETTERS "MTS," POSITIONED TO THE RIGHT OF THE BLUE SQUARE, APPEAR IN BLACK COLOR. ADDITIONALLY, THREE SLANTED LINES OF DIFFERING LENGTH ARE POSITIONED AS SUPERIMPOSED OVER THE BLUE SQUARE, RUNNING FROM THE LOWER LEFT TO THE UPPER RIGHT, AND ALSO ARE COLORED BLACK.

CLASS 10—MEDICAL APPARATUS

FOR MEDICAL DEVICES AND SHOCK WAVE TECHNOLOGY PRODUCTS, DEVICES AND EQUIPMENT, NAMELY, EXTRACORPOREAL SHOCK WAVE THERAPY (ESWT) DEVICES FOR USE AS TREATMENT IN THE FIELDS OF ORTHOPEDICS, UROLOGY AND VETERINARY MEDICINE (U.S. CLS. 26, 39 AND 44).

FIRST USE 12-4-2001; IN COMMERCE 12-4-2001.

CLASS 42—SCIENTIFIC, COMPUTER AND LEGAL SERVICES

FOR DESIGN FOR OTHERS IN THE FIELD OF MEDICAL DEVICES AND SHOCK WAVE TECHNOLOGY PRODUCTS (U.S. CLS. 100 AND 101).

FIRST USE 12-4-2001; IN COMMERCE 12-4-2001.

KIMBERLY PERRY, EXAMINING ATTORNEY

SN 78-693,237. ANGLO SAXON REAL ESTATE AGENCY (ISRAEL 1992) LTD, TEL AVIV, ISRAEL, FILED 8-16-2005.



THE MARK CONSISTS OF THE LETTER A AND THE LETTER S. THESE TWO LETTERS ARE SHAPED AS A HOUSE WHICH IS INDICATIVE OF REAL ESTATE SERVICES.

CLASS 35—ADVERTISING AND BUSINESS

FOR REAL ESTATE SALES MANAGEMENT, REAL ESTATE MARKETING SERVICES, NAMELY, ON-LINE SERVICES FEATURING TOURS OF RESIDENTIAL AND COMMERCIAL REAL ESTATE (U.S. CLS. 100, 101 AND 102).

FIRST USE 1-1-1985; IN COMMERCE 1-1-1985.

CLASS 36—INSURANCE AND FINANCIAL

FOR APPRAISAL OF REAL ESTATE, ASSESSMENT AND MANAGEMENT OF REAL ESTATE, FINANCIAL VALUATION OF PERSONAL PROPERTY AND REAL ESTATE, PROVIDING INFORMATION IN THE FIELD OF REAL ESTATE BY MEANS OF LINKING THE WEB SITE TO OTHER WEB SITES FEATURING REAL ESTATE INFORMATION, REAL ESTATE AGENCIES, REAL ESTATE CONSULTATION (U.S. CLS. 100, 101 AND 102).

FIRST USE 1-1-1985; IN COMMERCE 1-1-1985.

FRED CARL, EXAMINING ATTORNEY

SN 78-693,265. HUMANA MILITARY HEALTHCARE SERVICES, INC., LOUISVILLE, KY. FILED 8-16-2005.

HUMANA MILITARY

THE MARK CONSISTS OF STANDARD CHARACTERS WITHOUT CLAIM TO ANY PARTICULAR FONT, STYLE, SIZE, OR COLOR.

NO CLAIM IS MADE TO THE EXCLUSIVE RIGHT TO USE "MILITARY", APART FROM THE MARK AS SHOWN.

CLASS 35—ADVERTISING AND BUSINESS

FOR MANAGEMENT OF THE HEALTH BENEFIT PLANS FOR OTHERS; PHYSICIAN REFERRALS (U.S. CLS. 100, 101 AND 102).

FIRST USE 12-31-1993; IN COMMERCE 12-31-1993.

CLASS 44—MEDICAL, BEAUTY AND AGRICULTURAL SERVICES

FOR PROVIDING HEALTH CARE INFORMATION, AND PROVIDING INFORMATION ABOUT NUTRITION, WELLNESS, FITNESS AND HEALTHY HABITS; HEALTH MAINTENANCE ORGANIZATIONS AND PREFERRED PROVIDER ORGANIZATIONS SERVICES TO BENEFICIARIES AND PROVIDERS IN THE FIELD OF HEALTH CARE AND PRESCRIPTION DRUGS; DISEASE MANAGEMENT SERVICES (U.S. CLS. 100 AND 101).

FIRST USE 12-31-1993; IN COMMERCE 12-31-1993.

SUSAN LESLIE DUBOIS, EXAMINING ATTORNEY

SN 78-694,514. VIRGINIA MILITARY INSTITUTE, LEXINGTON, VA. FILED 8-17-2005.

Virginia Military Institute

THE MARK CONSISTS OF STANDARD CHARACTERS WITHOUT CLAIM TO ANY PARTICULAR FONT, STYLE, SIZE, OR COLOR.

NO CLAIM IS MADE TO THE EXCLUSIVE RIGHT TO USE "MILITARY INSTITUTE AS TO CLASS 41 ONLY", APART FROM THE MARK AS SHOWN.

SEC. 2(F).

CLASS 14—JEWELRY

FOR PRECIOUS METALS, JEWELRY, NAMELY, GOLD PINS, GOLD EARRINGS, TIE TACKS; CHARMS AND RINGS, WATCHES AND CLOCKS, ORNAMENTS OF PRECIOUS METAL (U.S. CLS. 2, 27, 28 AND 50).

FIRST USE 12-31-1842; IN COMMERCE 12-31-1842.

CLASS 16—PAPER GOODS AND PRINTED MATTER

FOR PAPER ARTICLES, NAMELY, WRITING PAPER, FOLDERS, NOTE PADS, STATIONERY, LOOSELEAF BINDERS, DECALS, BUMPER STICKERS, NOTE BOOKS, CALENDARS, POST CARDS, POSTERS AND PENS, PAPER BABY BIBS (U.S. CLS. 2, 5, 22, 23, 29, 37, 38 AND 50).

FIRST USE 12-31-1915; IN COMMERCE 12-31-1915.

CLASS 18—LEATHER GOODS

FOR LEATHER AND IMITATION LEATHER GOODS, NAMELY, BRIEF CASE TYPE PORTFOLIO COVERS AND BRIEF CASES; TRAVEL BAGS, BACKPACKS, WALLETS AND UMBRELLAS (U.S. CLS. 1, 2, 3, 22 AND 41).

FIRST USE 12-31-1869; IN COMMERCE 12-31-1869.

CLASS 20—FURNITURE AND ARTICLES NOT OTHERWISE CLASSIFIED

FOR FURNITURE; NON-METAL KEY CHAINS; PILLOWS; DIPLOMA FRAMES; AND MIRRORS (U.S. CLS. 2, 13, 22, 25, 32 AND 50).

FIRST USE 12-31-1979; IN COMMERCE 12-31-1979.

CLASS 21—HOUSEWARES AND GLASS

FOR DRINKING GLASSES, PITCHERS, MUGS, PLASTIC CUPS, INSULATING SLEEVE HOLDERS FOR BEVERAGE CANS AND WASTE PAPER BASKETS (U.S. CLS. 2, 13, 23, 29, 30, 33, 40 AND 50).

FIRST USE 12-31-1979; IN COMMERCE 12-31-1979.

CLASS 24—FABRICS

FOR BLANKETS, NAMELY BED BLANKETS, BLANKET THROWS, BLANKETS FOR OUTDOOR USE, CHILDREN'S BLANKETS, PET BLANKETS, RECEIVING BLANKETS, WOOLEN BLANKETS; HAND TOWELS (U.S. CLS. 42 AND 50).

FIRST USE 12-31-1915; IN COMMERCE 12-31-1915.

CLASS 25—CLOTHING

FOR CLOTHING, NAMELY, T-SHIRTS, SPORT SHIRTS, SWEAT PANTS, SHORTS, SWEAT SHIRTS, SWEATERS, JERSEYS, PANTS, TIES, BABY BIBS NOT OF PAPER, CAPS, HATS, SHOES, JACKETS AND BATH ROBES (U.S. CLS. 22 AND 39).

FIRST USE 12-31-1839; IN COMMERCE 12-31-1839.

CLASS 28—TOYS AND SPORTING GOODS

FOR STUFFED TOY ANIMALS, SPORT BALLS, AND CHRISTMAS TREE ORNAMENTS (U.S. CLS. 22, 23, 38 AND 50).

FIRST USE 12-31-1915; IN COMMERCE 12-31-1915.

CLASS 41—EDUCATION AND ENTERTAINMENT

FOR EDUCATIONAL SERVICES, NAMELY, PROVIDING COURSES OF INSTRUCTION AT THE COLLEGE LEVEL; ENTERTAINMENT SERVICES, NAMELY, ORGANIZING AND CONDUCTING COLLEGIATE SPORTING AND CULTURAL EVENTS (U.S. CLS. 100, 101 AND 107).

FIRST USE 12-31-1839; IN COMMERCE 12-31-1839.
YONG KIM, EXAMINING ATTORNEY

SN 78-694,755. SIGNATURE ENGRAVING SYSTEMS, INC., HOLYOKE, MA. FILED 8-17-2005.

SIGNATURE GIFTS

THE MARK CONSISTS OF STANDARD CHARACTERS WITHOUT CLAIM TO ANY PARTICULAR FONT, STYLE, SIZE, OR COLOR.

NO CLAIM IS MADE TO THE EXCLUSIVE RIGHT TO USE "GIFTS", APART FROM THE MARK AS SHOWN.

CLASS 35—ADVERTISING AND BUSINESS

FOR RETAIL STORE SERVICES AND WHOLESALE DISTRIBUTORSHIP SERVICES FEATURING ENGRAVED AND ENGRAVABLE GIFTS; RETAIL GIFT SHOPS; ON-LINE RETAIL STORE SERVICES AND WHOLESALE DISTRIBUTORSHIP SERVICES FEATURING ENGRAVED AND ENGRAVABLE GIFTS; MAIL ORDER CATALOG SERVICES FEATURING ENGRAVED AND ENGRAVABLE GIFTS (U.S. CLS. 100, 101 AND 102).

SN 78-694,588. ALVA, JOSE LUIS, MIAMI, FL. FILED 8-17-2005.

CLASS 40—MATERIAL TREATMENT

FOR ENGRAVING (U.S. CLS. 100, 103 AND 106).
TINA BROWN, EXAMINING ATTORNEY



SN 78-694,759. SIGNATURE ENGRAVING SYSTEMS, INC., HOLYOKE, MA. FILED 8-17-2005.

SIGNATURE SELECTIONS

THE FOREIGN WORDING IN THE MARK TRANSLATES INTO ENGLISH AS THE CARIBBEAN GHOSTS. SEC. 2(F) AS TO "CARIBBEAN".

CLASS 9—ELECTRICAL AND SCIENTIFIC APPARATUS

FOR SERIES OF AUDIO CASSETTES, VIDEO CASSETTES, COMPACT DISCS, RECORD ALBUMS AND OTHER MEDIA, NAMELY, VIDEO DISCS, FEATURING MUSICAL VIDEO, AUDIO OR AUDIO-VISUAL PERFORMANCES (U.S. CLS. 21, 23, 26, 36 AND 38).

FIRST USE 1-1-1988; IN COMMERCE 1-1-1988.

CLASS 41—EDUCATION AND ENTERTAINMENT

FOR ENTERTAINMENT SERVICES, NAMELY, LIVE PERFORMANCES BY A MUSICAL GROUP (U.S. CLS. 100, 101 AND 107).

FIRST USE 7-1-1991; IN COMMERCE 7-1-1991.
NAAKWAMA ANKRAH, EXAMINING ATTORNEY

THE MARK CONSISTS OF STANDARD CHARACTERS WITHOUT CLAIM TO ANY PARTICULAR FONT, STYLE, SIZE, OR COLOR.

NO CLAIM IS MADE TO THE EXCLUSIVE RIGHT TO USE "SELECTIONS", APART FROM THE MARK AS SHOWN.

CLASS 35—ADVERTISING AND BUSINESS

FOR RETAIL STORE SERVICES AND WHOLESALE DISTRIBUTORSHIP SERVICES FEATURING ENGRAVED AND ENGRAVABLE GIFTS; RETAIL GIFT SHOPS; ON-LINE RETAIL STORE SERVICES AND WHOLESALE DISTRIBUTORSHIP SERVICES FEATURING ENGRAVED AND ENGRAVABLE GIFTS; MAIL ORDER CATALOG SERVICES FEATURING ENGRAVED AND ENGRAVABLE GIFTS (U.S. CLS. 100, 101 AND 102).

CLASS 40—MATERIAL TREATMENT

FOR ENGRAVING (U.S. CLS. 100, 103 AND 106).
TINA BROWN, EXAMINING ATTORNEY

SN 78-695,049. TRIESTE SERVICES CORPORATION, MIAMI, FL. FILED 8-18-2005.

CHUTEBOXE

THE MARK CONSISTS OF STANDARD CHARACTERS WITHOUT CLAIM TO ANY PARTICULAR FONT, STYLE, SIZE, OR COLOR.

CLASS 5—PHARMACEUTICALS

FOR VITAMINS AND NUTRITIONAL SUPPLEMENTS (U.S. CLS. 6, 18, 44, 46, 51 AND 52).

CLASS 25—CLOTHING

FOR CLOTHING, NAMELY, ACTIVE WEAR, TANK-TOPS, T-SHIRTS, SHIRTS, SWEAT SHIRTS, UNDER-SHIRTS, SWEAT PANTS, SWEAT SUITS, JOGGING SUITS, SHORTS, GYM SHORTS, JACKETS, HATS, CAPS AND FOOTWEAR, NAMELY SNEAKERS (U.S. CLS. 22 AND 39).
 JAMES GRIFFIN, EXAMINING ATTORNEY

SN 78-695,099. LOMBARDI & ROSS RESEARCH + DEVELOPMENT ESTABLISHMENT, VADUZ, LIECHTENSTEIN, FILED 8-18-2005.



LOMBAGINE
 PARIS

NO CLAIM IS MADE TO THE EXCLUSIVE RIGHT TO USE "PARIS", APART FROM THE MARK AS SHOWN.

CLASS 3—COSMETICS AND CLEANING PREPARATIONS

FOR LAUNDRY BLEACH; CLEANING, POLISHING, SCOURING AND ABRASIVE PREPARATIONS, NAMELY, GLASS CLEANER, CARPET CLEANER, DEGREASING PREPARATIONS FOR USE AS A MULTIPURPOSES CLEANER, CLEANING PREPARATIONS FOR HOUSEHOLD PURPOSES, GENERAL PURPOSES SCOURING POWDERS AND SCOURING LIQUIDS; SOAPS, NAMELY, COSMETIC SOAPS, DEODORANT SOAPS, LAUNDRY SOAPS, MEDICATED SOAPS, PERFUMED SOAPS AND DISINFECTANT SOAPS; PERFUMERY; ESSENTIAL OILS FOR PERSONAL USE; COSMETICS; HAIR LOTIONS; DENTIFRICES (U.S. CLS. 1, 4, 6, 50, 51 AND 52).

CLASS 14—JEWELRY

FOR JEWELRY; PRECIOUS STONES; HOROLOGICAL AND CHRONOMETRIC INSTRUMENTS; PRECIOUS METALS AND THEIR ALLOYS (U.S. CLS. 2, 27, 28 AND 50).

CLASS 24—FABRICS

FOR TEXTILES AND TEXTILE GOODS, NAMELY, TOWELS, WALL HANGINGS, PLACE MATS, NAPKINS, TABLECLOTHS, TABLE LINENS, BED BLANKETS, BED LINENS, BED PADS, BED SHEETS, BED SKIRTS AND BEDSPREADS (U.S. CLS. 42 AND 50).

CLASS 25—CLOTHING

FOR CLOTHING, NAMELY, PANTS, SHIRTS, JACKETS, SKIRTS, UNDERWEAR, TIES, MANTLES AND MUFFLERS; BELTS; FOOTWEAR; HEADWEAR (U.S. CLS. 22 AND 39).
 KATRINA EDGE, EXAMINING ATTORNEY

SN 78-695,275. VALUE PLACE FRANCHISE SERVICES, LLC, WICHITA, KS. FILED 8-18-2005.



OWNER OF U.S. REG. NOS. 2,893,350 AND 3,034,643.
 NO CLAIM IS MADE TO THE EXCLUSIVE RIGHT TO USE "FROM \$149 WEEKLY", APART FROM THE MARK AS SHOWN.
 THE COLOR(S) YELLOW, RED AND BLACK IS/ARE CLAIMED AS A FEATURE OF THE MARK.
 "THE MARK CONSISTS OF A RED HOUSE-SHAPED BUILDING WITH BLACK ROOF AND BLACK RECTANGULAR BASE AND WORDING WHICH IS YELLOW WITH BLACK TRIM."

CLASS 36—INSURANCE AND FINANCIAL

FOR SHORT-TERM FURNISHED APARTMENT RENTAL SERVICES (U.S. CLS. 100, 101 AND 102).
 FIRST USE 4-15-2005; IN COMMERCE 4-15-2005.

CLASS 43—HOTEL AND RESTAURANT SERVICES

FOR RESIDENTIAL HOTELS AND EXTENDED-STAY HOTELS (U.S. CLS. 100 AND 101).
 FIRST USE 4-15-2005; IN COMMERCE 4-15-2005.
 MATTHEW PAPPAS, EXAMINING ATTORNEY

SN 78-695,290. VALUE PLACE FRANCHISE SERVICES, LLC, WICHITA, KS. FILED 8-18-2005.



OWNER OF U.S. REG. NOS. 2,893,350 AND 3,034,643.
 THE COLOR(S) YELLOW, RED AND BLACK IS/ARE CLAIMED AS A FEATURE OF THE MARK.
 "THE MARK CONSISTS OF A RED HOUSE-SHAPED BUILDING WITH BLACK ROOF AND BLACK BASE AND WORDING WHICH IS YELLOW WITH BLACK TRIM."

CLASS 36—INSURANCE AND FINANCIAL

FOR SHORT-TERM FURNISHED APARTMENT RENTAL SERVICES (U.S. CLS. 100, 101 AND 102).
 FIRST USE 4-15-2005; IN COMMERCE 4-15-2005.

CLASS 43—HOTEL AND RESTAURANT SERVICES

FOR RESIDENTIAL HOTELS AND EXTENDED-STAY HOTELS (U.S. CLS. 100 AND 101).
FIRST USE 4-15-2005; IN COMMERCE 4-15-2005.
MATTHEW PAPPAS, EXAMINING ATTORNEY

CLASS 34—SMOKERS' ARTICLES

FOR CIGAR BANDS; CIGAR CUTTERS; CIGAR HUMIDIFIERS; CIGAR TUBES; CIGARS; NON-ELECTRIC CIGAR LIGHTERS NOT OF PRECIOUS METAL (U.S. CLS. 2, 8, 9 AND 17).
FIRST USE 9-22-2004; IN COMMERCE 9-22-2004.
MONIQUE MILLER, EXAMINING ATTORNEY

SN 78-695,514. QUANTUM FOOD DESIGN, LLC, CORAL GABLES, FL. FILED 8-18-2005.

SN 78-695,780. ARROWHEAD CENTER, INC., LAS CRUCES, NM. FILED 8-18-2005.

BEYOND * SUGAR

THE MARK CONSISTS OF STANDARD CHARACTERS WITHOUT CLAIM TO ANY PARTICULAR FONT, STYLE, SIZE, OR COLOR.

NO CLAIM IS MADE TO THE EXCLUSIVE RIGHT TO USE "SUGAR", APART FROM THE MARK AS SHOWN.

CLASS 5—PHARMACEUTICALS

FOR NUTRITIONAL ADDITIVES FOR USE IN FOODS AND DIETARY SUPPLEMENTS FOR HUMAN CONSUMPTION (U.S. CLS. 6, 18, 44, 46, 51 AND 52).

CLASS 30—STAPLE FOODS

FOR NATURAL SWEETENER, SUGAR SUBSTITUTES, FOOD ADDITIVES FOR NON-NUTRITIONAL PURPOSES FOR USE AS A FLAVORING, INGREDIENT OR FILLER IN FOODS AND BEVERAGES (U.S. CL. 46).
TARAH HARDY, EXAMINING ATTORNEY

ARROWHEAD CENTER

THE MARK CONSISTS OF STANDARD CHARACTERS WITHOUT CLAIM TO ANY PARTICULAR FONT, STYLE, SIZE, OR COLOR.

NO CLAIM IS MADE TO THE EXCLUSIVE RIGHT TO USE "CENTER", APART FROM THE MARK AS SHOWN.

CLASS 35—ADVERTISING AND BUSINESS

FOR BUSINESS CONSULTATION SERVICES, NAMELY PROVIDING GUIDANCE FOR THE NEW BUSINESS FORMATION OF OTHERS IN THE AREAS OF TECHNOLOGY TRANSFER, BUSINESS DEVELOPMENT SERVICES, NAMELY, PROVIDING START-UP SUPPORT FOR BUSINESSES OF OTHERS, BUSINESS PLANNING, AND BUSINESS MARKETING SERVICES FOR START-UP AND EMERGING GROWTH COMPANIES; MARKET ANALYSIS; BUSINESS RESEARCH; BUSINESS DEVELOPMENT SERVICES, NAMELY IDENTIFYING AND COORDINATING RESEARCH SPONSORS, STRATEGIC PARTNERSHIPS AND COMMERCIAL RELATIONSHIPS FOR DEVELOPING BUSINESSES AND ENTREPRENEURS (U.S. CLS. 100, 101 AND 102).
FIRST USE 7-18-1989; IN COMMERCE 1-31-2005.

SN 78-695,743. BRAWNER, SHAWN, TEMECULA, CA. FILED 8-18-2005.

CHEAP BASTARD CIGAR COMPANY

CLASS 42—SCIENTIFIC, COMPUTER AND LEGAL SERVICES

FOR PRODUCT DEVELOPMENT FOR OTHERS IN THE FIELDS OF BUSINESS, AND SCIENCE AND TECHNOLOGY; DESIGN FOR OTHERS FOR HIGHER-TECH START-UP AND EMERGING GROWTH COMPANIES IN THE FIELD OF ENGINEERING; SCIENTIFIC AND TECHNOLOGY DEVELOPMENT; AGRICULTURAL RESEARCH; ENVIRONMENTAL RESEARCH; ENGINEERING RESEARCH; LICENSING OF INTELLECTUAL PROPERTY; RESEARCH IN THE FIELD OF HEALTH CARE (U.S. CLS. 100 AND 101).
FIRST USE 7-18-1989; IN COMMERCE 1-31-2005.
DAVID MURRAY, EXAMINING ATTORNEY

THE MARK CONSISTS OF STANDARD CHARACTERS WITHOUT CLAIM TO ANY PARTICULAR FONT, STYLE, SIZE, OR COLOR.

NO CLAIM IS MADE TO THE EXCLUSIVE RIGHT TO USE "CIGAR COMPANY" FOR CLASS 34 OR "COMPANY" FOR CLASS 25, APART FROM THE MARK AS SHOWN.

SN 78-696,288. THAT'S MY DOG, INC., HAZEL GREEN, WI. FILED 8-19-2005.

CLASS 25—CLOTHING

FOR DENIM JACKETS; DOWN JACKETS; HAT BANDS; HATS; HEAVY JACKETS; JACKETS; LEATHER JACKETS; MEN AND WOMEN JACKETS, COATS, TROUSERS, VESTS; MOCK TURTLE-NECK SWEATERS; SHORT-SLEEVED OR LONG-SLEEVED T-SHIRTS; SWEATERS; T-SHIRTS; TURTLENECK SWEATERS; V-NECK SWEATERS (U.S. CLS. 22 AND 39).
FIRST USE 9-22-2004; IN COMMERCE 9-22-2004.

THAT'S MY DOG

THE MARK CONSISTS OF STANDARD CHARACTERS WITHOUT CLAIM TO ANY PARTICULAR FONT, STYLE, SIZE, OR COLOR.

NO CLAIM IS MADE TO THE EXCLUSIVE RIGHT TO USE "DOG", APART FROM THE MARK AS SHOWN.

CLASS 41—EDUCATION AND ENTERTAINMENT

FOR DOG TRAINING SERVICES; EDUCATIONAL SERVICES, NAMELY CONDUCTING SEMINARS IN THE FIELD OF DOG TRAINING (U.S. CLS. 100, 101 AND 107).

FIRST USE 5-31-1998; IN COMMERCE 5-31-1998.

CLASS 43—HOTEL AND RESTAURANT SERVICES

FOR PET KENNEL AND BOARDING SERVICES (U.S. CLS. 100 AND 101).

FIRST USE 5-31-1998; IN COMMERCE 5-31-1998.

ARETHA SOMERVILLE, EXAMINING ATTORNEY

SN 78-696,342. PRIVACASH, INC., TOLEDO, OH. FILED 8-19-2005.

MERCADO

THE MARK CONSISTS OF STANDARD CHARACTERS WITHOUT CLAIM TO ANY PARTICULAR FONT, STYLE, SIZE, OR COLOR.

"THE FOREIGN WORDING IN THE MARK TRANSLATES INTO ENGLISH AS MARKET."

CLASS 9—ELECTRICAL AND SCIENTIFIC APPARATUS

FOR MAGNETICALLY ENCODED CREDIT CHARGE CARDS; MAGNETICALLY ENCODED DEBIT CARDS; MAGNETICALLY ENCODED STORED VALUE CARDS; MAGNETICALLY ENCODED BANK CARDS; MAGNETICALLY ENCODED CARDS USED TO MAKE AN ELECTRONIC TRANSFER OF MONETARY FUNDS (U.S. CLS. 21, 23, 26, 36 AND 38).

CLASS 36—INSURANCE AND FINANCIAL

FOR DEBIT CARD SERVICES; ISSUING STORED VALUE CARDS; ELECTRONIC TRANSFER OF FUNDS FOR OTHERS TO AND FROM A PORTABLE ENCODED DATA CARRIER DEVICE; ELECTRONIC TRANSFER OF MONEY FOR OTHERS BETWEEN REMOTELY LOCATED COMPUTERS (U.S. CLS. 100, 101 AND 102).

SCOTT SISUN, EXAMINING ATTORNEY

SN 78-696,365. AUTHENTIDATE HOLDING CORP., BERKELEY HEIGHTS, NJ. FILED 8-19-2005.

AUTHENTIDATE

THE MARK CONSISTS OF STANDARD CHARACTERS WITHOUT CLAIM TO ANY PARTICULAR FONT, STYLE, SIZE, OR COLOR.

OWNER OF U.S. REG. NO. 2,525,514.

CLASS 35—ADVERTISING AND BUSINESS

FOR DOCUMENT AND DATA MANAGEMENT AND PROCESSING SERVICES, NAMELY, AUTHENTICATION, TIME STAMPING AND VERIFICATION OF DOCUMENTS AND DATA FILES (U.S. CLS. 100, 101 AND 102).

FIRST USE 3-1-1999; IN COMMERCE 3-1-1999.

CLASS 39—TRANSPORTATION AND STORAGE

FOR ELECTRONIC STORAGE AND RETRIEVAL OF DOCUMENTS AND DATA FILES (U.S. CLS. 100 AND 105).

FIRST USE 3-1-1999; IN COMMERCE 3-1-1999.

CLASS 40—MATERIAL TREATMENT

FOR CONVERSION OF DOCUMENTS INTO ELECTRONIC, MAGNETIC, OPTICAL OR OTHER FORMATS; CODING OF DOCUMENTS AND DATA FILES (U.S. CLS. 100, 103 AND 106).

FIRST USE 3-1-1999; IN COMMERCE 3-1-1999.

CLASS 42—SCIENTIFIC, COMPUTER AND LEGAL SERVICES

FOR CONSULTING SERVICES, NAMELY SOFTWARE DEVELOPMENT AND MAINTENANCE OF INTERFACES TO SYSTEMS FOR AUTHENTICATION, TIME STAMPING AND VERIFICATION OF DOCUMENTS AND DATA FILES (U.S. CLS. 100 AND 101).

FIRST USE 3-1-1999; IN COMMERCE 3-1-1999.

JOHN DALIER, EXAMINING ATTORNEY

SN 78-697,636. CLAIRVOYANTE, INC., SEBASTOPOL, CA. FILED 8-22-2005.

PENTILE RGBW

THE MARK CONSISTS OF STANDARD CHARACTERS WITHOUT CLAIM TO ANY PARTICULAR FONT, STYLE, SIZE, OR COLOR.

OWNER OF U.S. REG. NO. 3,051,464.

NO CLAIM IS MADE TO THE EXCLUSIVE RIGHT TO USE "RGBW", APART FROM THE MARK AS SHOWN.

CLASS 9—ELECTRICAL AND SCIENTIFIC APPARATUS

FOR CENTRAL PROCESSING UNITS FOR PROCESSING INFORMATION, DATA, SOUND OR IMAGES; COMPUTER PROGRAMS FOR EDITING IMAGES, SOUND AND VIDEO; COMPUTER SOFTWARE FOR ORGANIZING AND VIEWING DIGITAL IMAGES AND PHOTOGRAPHS; COMPUTER SOFTWARE TO ENHANCE THE AUDIO-VISUAL CAPABILITIES OF MULTIMEDIA APPLICATIONS, NAMELY, FOR THE INTEGRATION OF TEXT, AUDIO, GRAPHICS, STILL IMAGES AND MOVING PICTURES; ELECTRIC LUMINESCENT DISPLAY PANELS; ELECTRONIC CARDS FOR PROCESSING IMAGES; FLAT PANEL DISPLAY SCREENS; HOME THEATER PRODUCTS, NAMELY, LCD; LCD LARGE-SCREEN DISPLAYS; LCD PROJECTORS USED TO DISPLAY ADVERTISEMENTS; LIGHT EMITTING DIODE DISPLAYS; LIQUID CRYSTAL DISPLAY (LCD) PROJECTORS; LIQUID CRYSTAL DISPLAYS; SOFTWARE FOR PROCESSING IMAGES, GRAPHICS AND TEXT; VIDEO DISPLAY CARDS (U.S. CLS. 21, 23, 26, 36 AND 38).

CLASS 35—ADVERTISING AND BUSINESS

FOR LICENSING OF COMPUTER SOFTWARE (U.S. CLS. 100, 101 AND 102).

CLASS 42—SCIENTIFIC, COMPUTER AND LEGAL SERVICES

FOR LICENSING OF INTELLECTUAL PROPERTY; PATENT LICENSING (U.S. CLS. 100 AND 101).
BRENDAN REGAN, EXAMINING ATTORNEY

SN 78-697,859. W LAB ACQUISITION CORP., BOSTON, MA.
FILED 8-22-2005.

PRE-KINI

THE MARK CONSISTS OF STANDARD CHARACTERS WITHOUT CLAIM TO ANY PARTICULAR FONT, STYLE, SIZE, OR COLOR.

CLASS 3—COSMETICS AND CLEANING PREPARATIONS

FOR NON-MEDICATED SKIN CARE PREPARATIONS; DEPILATORIES (U.S. CLS. 1, 4, 6, 50, 51 AND 52).

CLASS 5—PHARMACEUTICALS

FOR TOPICAL PAIN RELIEVER (U.S. CLS. 6, 18, 44, 46, 51 AND 52).
BARNEY CHARLON, EXAMINING ATTORNEY

SN 78-699,014. BDP INTERNATIONAL, INC., PHILADELPHIA, PA. FILED 8-24-2005.

BDP SMART...LOGISTICS MADE
EASY

THE MARK CONSISTS OF STANDARD CHARACTERS WITHOUT CLAIM TO ANY PARTICULAR FONT, STYLE, SIZE, OR COLOR.

OWNER OF U.S. REG. NOS. 2,295,420 AND 2,301,666.
NO CLAIM IS MADE TO THE EXCLUSIVE RIGHT TO USE "LOGISTICS", APART FROM THE MARK AS SHOWN.

CLASS 35—ADVERTISING AND BUSINESS

FOR MANAGEMENT ASSISTANCE, NAMELY, ASSISTING IN THE MANAGEMENT OF TRANSPORTATION AND FREIGHT LOGISTICS; BUSINESS ANALYSIS IN THE FIELD OF SUPPLY CHAIN PROCESSES (U.S. CLS. 100, 101 AND 102).

CLASS 39—TRANSPORTATION AND STORAGE

FOR TRANSPORT BROKERAGE AND FREIGHT FORWARDING SERVICES; ARRANGING FOR THE TRANSPORTATION OF GOODS BY OCEAN, RAIL, TRUCK AND AIR (U.S. CLS. 100 AND 105).
NELSON SNYDER, EXAMINING ATTORNEY

SN 78-699,268. GROUP HEALTH COOPERATIVE, SEATTLE, WA. FILED 8-24-2005.

HEALTHPAYS

THE MARK CONSISTS OF STANDARD CHARACTERS WITHOUT CLAIM TO ANY PARTICULAR FONT, STYLE, SIZE, OR COLOR.

CLASS 36—INSURANCE AND FINANCIAL

FOR INSURANCE SERVICES, NAMELY, ADMINISTRATION AND ORGANIZATION OF PREPAID AND/OR PREFERRED PROVIDER MEDICAL, HOSPITAL AND RELATED HEALTH CARE PLANS AND HEALTH CARE NETWORKS (U.S. CLS. 100, 101 AND 102).
FIRST USE 4-0-1987; IN COMMERCE 4-0-1987.

CLASS 44—MEDICAL, BEAUTY AND AGRICULTURAL SERVICES

FOR HEALTH CARE SERVICES, MANAGED HEALTH CARE SERVICES, AND HEALTH CARE SERVICES IN THE NATURE OF A HEALTH MAINTENANCE ORGANIZATION (U.S. CLS. 100 AND 101).
FIRST USE 4-0-1987; IN COMMERCE 4-0-1987.
SONYA STEPHENS, EXAMINING ATTORNEY

SN 78-700,346. DISC MARKETING, LLC, DBA DMI MUSIC & MEDIA SOLUTIONS, PASADENA, CA. FILED 8-25-2005.

DMI

THE MARK CONSISTS OF STANDARD CHARACTERS WITHOUT CLAIM TO ANY PARTICULAR FONT, STYLE, SIZE, OR COLOR.

OWNER OF U.S. REG. NOS. 2,819,355, 2,878,873 AND 2,881,085.

CLASS 9—ELECTRICAL AND SCIENTIFIC APPARATUS

FOR PRE-RECORDED CDS, DVDS, CD-ROMS, AND ENHANCED-CDS FEATURING AUDIO-VISUAL ENTERTAINMENT, NAMELY, MUSIC, VIDEOS, INTERACTIVE GAMES, PROMOTIONS AND SWEEPSTAKES (U.S. CLS. 21, 23, 26, 36 AND 38).
FIRST USE 12-17-2002; IN COMMERCE 12-17-2002.

CLASS 35—ADVERTISING AND BUSINESS

FOR ADVERTISING SERVICES, NAMELY, CREATION AND DISSEMINATION OF DIGITAL MEDIA ADVERTISING PRODUCTS FEATURING ENTERTAINMENT (U.S. CLS. 100, 101 AND 102).
FIRST USE 5-31-2005; IN COMMERCE 6-3-2005.

CLASS 41—EDUCATION AND ENTERTAINMENT

FOR ENTERTAINMENT SERVICES, NAMELY, CREATING, PRODUCING AND PROVIDING AUDIO-VISUAL ENTERTAINMENT FOR OTHERS, IN THE NATURE OF MUSIC, VIDEOS, INTERACTIVE GAMES, PROMOTIONS AND SWEEPSTAKES (U.S. CLS. 100, 101 AND 107).

FIRST USE 8-31-2001; IN COMMERCE 8-31-2001.
TIMOTHY FINNEGAN, EXAMINING ATTORNEY

SN 78-700,976. HISAMITSU PHARMACEUTICAL CO., INC., SAGA, JAPAN, FILED 8-26-2005.

FERTIUP

THE MARK CONSISTS OF STANDARD CHARACTERS WITHOUT CLAIM TO ANY PARTICULAR FONT, STYLE, SIZE, OR COLOR.

PRIORITY CLAIMED UNDER SEC. 44(D) ON JAPAN APPLICATION NO. 2005-77279, FILED 8-18-2005, REG. NO. 4980458, DATED 8-18-2006, EXPIRES 8-18-2016.

CLASS 1—CHEMICALS

FOR PRESERVATIVES FOR FREEZING SPERM FOR MEDICAL AND VETERINARY USE (U.S. CLS. 1, 5, 6, 10, 26 AND 46).

CLASS 5—PHARMACEUTICALS

FOR PHARMACEUTICALS FOR CELL CULTIVATION FOR MEDICAL OR VETERINARY USE; SEMEN FOR ARTIFICIAL INSEMINATION; CULTURE MEDIUM FOR FREEZING SPERM FOR MEDICAL AND VETERINARY USE; CULTURE MEDIUM FOR SPERM PRESERVATION FOR MEDICAL AND VETERINARY USE; CULTURE MEDIUM FOR IN VITRO FERTILIZED EMBRYOS FOR MEDICAL AND VETERINARY USE; CULTURE MEDIUM FOR MEDICAL AND VETERINARY USE (U.S. CLS. 6, 18, 44, 46, 51 AND 52).

SEAN CROWLEY, EXAMINING ATTORNEY

SN 78-701,851. CORELOGIC SYSTEMS, INC., SACRAMENTO, CA. FILED 8-26-2005.

CORELOGIC

THE MARK CONSISTS OF STANDARD CHARACTERS WITHOUT CLAIM TO ANY PARTICULAR FONT, STYLE, SIZE, OR COLOR.

CLASS 36—INSURANCE AND FINANCIAL

FOR ONLINE SERVICES, NAMELY, PROVIDING ONLINE COMPUTER DATABASES FOR ASSESSMENT AND MANAGEMENT OF LOAN RISK AND FRAUD IN THE FIELDS OF MORTGAGE LENDING AND INVESTING; PROVIDING ONLINE COMPUTER DATABASE FOR EXAMINATION AND VALUATION OF REAL ESTATE; PROVIDING ONLINE COMPUTER DATABASE FOR GRADING AND ASSESSING RISK OF LOANS; AND PROVIDING AUTOMATED FISCAL VALUATIONS AND ASSESSMENTS OF MORTGAGE LENDING AND INVESTING (U.S. CLS. 100, 101 AND 102).

CLASS 42—SCIENTIFIC, COMPUTER AND LEGAL SERVICES

FOR ONLINE SERVICES, NAMELY, PROVIDING ONLINE NON-DOWNLOADABLE SOFTWARE FOR USE IN ASSESSMENT, GRADING AND MANAGEMENT OF LOAN RISK AND FRAUD IN THE FIELDS OF MORTGAGE LENDING AND INVESTING (U.S. CLS. 100 AND 101).

SAMUEL E. SHARPER JR., EXAMINING ATTORNEY

SN 78-701,940. CASEY RESEARCH, LLC, ASPEN, CO. FILED 8-27-2005.

Casey Energy Confidential

THE MARK CONSISTS OF STANDARD CHARACTERS WITHOUT CLAIM TO ANY PARTICULAR FONT, STYLE, SIZE, OR COLOR.

NO CLAIM IS MADE TO THE EXCLUSIVE RIGHT TO USE "ENERGY", APART FROM THE MARK AS SHOWN.

THE NAME(S), PORTRAIT(S), AND/OR SIGNATURE(S) SHOWN IN THE MARK IDENTIFIES DOUGLAS R. CASEY, WHOSE CONSENT(S) TO REGISTER IS SUBMITTED.

CLASS 9—ELECTRICAL AND SCIENTIFIC APPARATUS

FOR DOWNLOADABLE ELECTRONIC PUBLICATIONS IN THE NATURE OF NEWSLETTERS IN THE FIELD OF NATIONAL AND INTERNATIONAL INVESTMENT IN ENERGY MARKETS (U.S. CLS. 21, 23, 26, 36 AND 38).

FIRST USE 7-12-2005; IN COMMERCE 7-20-2005.

CLASS 16—PAPER GOODS AND PRINTED MATTER

FOR PRINTED PUBLICATIONS, NAMELY, NEWSLETTERS IN THE FIELD OF NATIONAL AND INTERNATIONAL INVESTMENT IN ENERGY MARKETS (U.S. CLS. 2, 5, 22, 23, 29, 37, 38 AND 50).

FIRST USE 7-12-2005; IN COMMERCE 7-12-2005.

CLASS 41—EDUCATION AND ENTERTAINMENT

FOR ONLINE PUBLICATIONS, NAMELY, NEWSLETTERS IN THE FIELD OF NATIONAL AND INTERNATIONAL INVESTMENT IN ENERGY MARKETS (U.S. CLS. 100, 101 AND 107).

FIRST USE 7-12-2005; IN COMMERCE 7-12-2005.
LAURIE KAUFMAN, EXAMINING ATTORNEY

SN 78-702,373. TNA ENTERTAINMENT, LLC, DALLAS, TX.
FILED 8-29-2005.

GENESIS

THE MARK CONSISTS OF STANDARD CHARACTERS WITHOUT CLAIM TO ANY PARTICULAR FONT, STYLE, SIZE, OR COLOR.

CLASS 9—ELECTRICAL AND SCIENTIFIC APPARATUS

FOR PRERECORDED VIDEO-TAPES, COMPACT DISCS AND DVDS FEATURING WRESTLING AND SPORTS ENTERTAINMENT. (U.S. CLS. 21, 23, 26, 36 AND 38).

CLASS 41—EDUCATION AND ENTERTAINMENT

FOR ENTERTAINMENT SERVICES, NAMELY, LIVE WRESTLING MATCHES. (U.S. CLS. 100, 101 AND 107).
JENNIFER MCROBBIE, EXAMINING ATTORNEY

SN 78-702,384. AMERIJAH PRODUCTIONS, LLC, FRANCONIA, NH. FILED 8-29-2005.

AMERIJAH

THE MARK CONSISTS OF STANDARD CHARACTERS WITHOUT CLAIM TO ANY PARTICULAR FONT, STYLE, SIZE, OR COLOR.

CLASS 9—ELECTRICAL AND SCIENTIFIC APPARATUS

FOR AUDIO RECORDINGS FEATURING MUSIC; MUSICAL SOUND RECORDINGS; SOUND RECORDINGS FEATURING MUSIC (U.S. CLS. 21, 23, 26, 36 AND 38).

FIRST USE 6-30-2004; IN COMMERCE 11-15-2004.

CLASS 41—EDUCATION AND ENTERTAINMENT

FOR MUSIC PRODUCTION SERVICES; MUSIC PUBLISHING SERVICES (U.S. CLS. 100, 101 AND 107).
FIRST USE 10-30-2004; IN COMMERCE 10-30-2004.
JOSETTE BEVERLY, EXAMINING ATTORNEY

SN 78-702,527. VIKING INTERWORKS, INC. A SANMINA-SCI COMPANY, RANCHO SANTA MARGARITA, CA. FILED 8-29-2005.



NO CLAIM IS MADE TO THE EXCLUSIVE RIGHT TO USE "COMPANY", APART FROM THE MARK AS SHOWN. THE MARK CONSISTS OF DESIGN PLUS WORDS, LETTERS AND/OR NUMBERS.

CLASS 35—ADVERTISING AND BUSINESS

FOR INTEGRATED TRACKING AND MANAGEMENT OF COMMERCIAL TRANSACTIONS ON A GLOBAL COMPUTER NETWORK (U.S. CLS. 100, 101 AND 102).
FIRST USE 11-1-2002; IN COMMERCE 11-1-2002.

CLASS 42—SCIENTIFIC, COMPUTER AND LEGAL SERVICES

FOR TECHNICAL SUPPORT SERVICES, NAMELY, TROUBLESHOOTING OF COMPUTER HARDWARE AND SOFTWARE PROBLEMS (U.S. CLS. 100 AND 101).
FIRST USE 11-1-2002; IN COMMERCE 11-1-2002.
MATTHEW MCDOWELL, EXAMINING ATTORNEY

SN 78-702,547. NORTHERN & SHELL TITLES LIMITED, LONDON, ENGLAND, FILED 8-29-2005.



OWNER OF U.S. REG. NO. 1,901,212.
THE MARK CONSISTS OF THE WORD OK! OVER THE WORDS FIRST FOR CELEBRITY NEWS ALL CONTAINED IN A BOX.

CLASS 9—ELECTRICAL AND SCIENTIFIC APPARATUS

FOR DOWNLOADABLE ELECTRONIC PUBLICATIONS IN THE NATURE OF ONLINE MAGAZINES, IN THE FIELD OF CELEBRITY LIFESTYLE, FASHION AND CLOTHING, CULTURAL AND POLITICAL EVENTS, THE PERFORMING ARTS, TRAVEL AND ASTROLOGY (U.S. CLS. 21, 23, 26, 36 AND 38).

FIRST USE 1-10-2003; IN COMMERCE 1-10-2003.

CLASS 41—EDUCATION AND ENTERTAINMENT

FOR COMPUTER SERVICES, NAMELY PROVIDING ONLINE PUBLICATIONS IN THE FIELD OF CELEBRITY LIFESTYLE, FASHION AND CLOTHING, CULTURAL AND POLITICAL (U.S. CLS. 100, 101 AND 107).
FIRST USE 1-10-2003; IN COMMERCE 1-10-2003.
DARRYL SPRUILL, EXAMINING ATTORNEY

SN 78-702,913. EXBROOK EXCHANGE, INC., SAN FRANCISCO, CA. FILED 8-29-2005.

SN 78-703,197. NUVASIVE, INC., SAN DIEGO, CA. FILED 8-30-2005.

EXBROOK

THE MARK CONSISTS OF STANDARD CHARACTERS WITHOUT CLAIM TO ANY PARTICULAR FONT, STYLE, SIZE, OR COLOR.

CLASS 35—ADVERTISING AND BUSINESS

FOR BUSINESS MANAGEMENT AND CONSULTING SERVICES IN THE FIELDS OF MEDIA PLACEMENT, MEDIA STRATEGIES, BRAND DEVELOPMENT, IDENTITY DESIGN, AND BUSINESS-TO-MARKET COMMUNICATION STRATEGIES (U.S. CLS. 100, 101 AND 102).
FIRST USE 5-0-2003; IN COMMERCE 5-0-2003.

CLASS 42—SCIENTIFIC, COMPUTER AND LEGAL SERVICES

FOR CONSULTATION IN THE FIELDS OF GRAPHIC DESIGN, VISUAL DESIGN AND PRODUCT DEVELOPMENT (U.S. CLS. 100 AND 101).
FIRST USE 6-0-2003; IN COMMERCE 6-0-2003.
YONG KIM, EXAMINING ATTORNEY

EXTENSURE

THE MARK CONSISTS OF STANDARD CHARACTERS WITHOUT CLAIM TO ANY PARTICULAR FONT, STYLE, SIZE, OR COLOR.

CLASS 5—PHARMACEUTICALS

FOR SURGICAL IMPLANTS COMPRISING BONE ALLOGRAFT FOR USE IN THE TREATMENT OF AILMENTS ASSOCIATED WITH THE SPINE AND SURROUNDING TISSUES AND STRUCTURES (U.S. CLS. 6, 18, 44, 46, 51 AND 52).

CLASS 10—MEDICAL APPARATUS

FOR SURGICAL IMPLANTS COMPRISING ARTIFICIAL MATERIAL FOR USE IN THE TREATMENT OF AILMENTS ASSOCIATED WITH THE SPINE AND SURROUNDING TISSUES (U.S. CLS. 26, 39 AND 44).
CATHERINE FAINT, EXAMINING ATTORNEY

SN 78-703,065. WEST PUBLISHING CORPORATION, EAGAN, MN. FILED 8-30-2005.

SN 78-703,412. SITTEPCITY, INC., CHICAGO, IL. FILED 8-30-2005.

KEYCLE

THE MARK CONSISTS OF STANDARD CHARACTERS WITHOUT CLAIM TO ANY PARTICULAR FONT, STYLE, SIZE, OR COLOR.

CLASS 38—COMMUNICATION

FOR PROVIDING ON-LINE CHAT ROOMS FOR TRANSMISSION OF MESSAGES AMONG COMPUTER USERS CONCERNING ANALYSIS OF CRITICAL CASES AFFECTING VARIOUS PRACTICE AREAS (U.S. CLS. 100, 101 AND 104).

CLASS 42—SCIENTIFIC, COMPUTER AND LEGAL SERVICES

FOR PROVIDING A SERIES OF ONLINE CONTINUING LEGAL EDUCATION PROGRAMS, NAMELY, COURSES (U.S. CLS. 100 AND 101).
KEVON CHISOLM, EXAMINING ATTORNEY

SPEEDSITTING

THE MARK CONSISTS OF STANDARD CHARACTERS WITHOUT CLAIM TO ANY PARTICULAR FONT, STYLE, SIZE, OR COLOR.

CLASS 35—ADVERTISING AND BUSINESS

FOR REFERRALS IN THE FIELD OF CHILDCARE AND NEWBORN CARE (U.S. CLS. 100, 101 AND 102).
FIRST USE 8-24-2004; IN COMMERCE 10-1-2004.

CLASS 45—PERSONAL SERVICES

FOR SOCIAL INTRODUCTION AGENCY FOR INTRODUCING CARE GIVERS AND PARENTS IN THE FIELDS OF CHILDCARE AND NEWBORN CARE (U.S. CLS. 100 AND 101).
FIRST USE 8-24-2004; IN COMMERCE 10-1-2004.
KYLE PEETE, EXAMINING ATTORNEY

SN 78-703,523. KARL HAMACHER GMBH, MASCHINEN-FABRIK ROHRLEITUNGS- UND ARMATURENWERK, BOCHUM, FED REP GERMANY, FILED 8-30-2005.

SN 78-703,730. INDUSTRIAL COLOR, INC., NEW YORK, NY, FILED 8-30-2005.

COALMAXX

THE MARK CONSISTS OF STANDARD CHARACTERS WITHOUT CLAIM TO ANY PARTICULAR FONT, STYLE, SIZE, OR COLOR.

PRIORITY CLAIMED UNDER SEC. 44(D) ON FED REP GERMANY APPLICATION NO. 30523591.5/0, FILED 4-20-2005, REG. NO. 30523591, DATED 8-2-2005, EXPIRES 4-30-2015.

CLASS 6—METAL GOODS

FOR COMMON METAL, NAMELY, METAL RINGS, TUBES, PIPES, DUCTS OF METAL, ELBOWS FOR PIPES, FEEDING PIECES, BREECHES PIPES, T-PIECES, CONNECTION PIECES, PIPE JUNCTIONS, PIPE FLANGES, ADAPTER PIECES, THREADED PIPES, CLIPS FOR PIPES, PIPE MUFFS, NUTS, SHELL COUPLING PIECES, TIE PLATES, VALVES OTHER THAN FOR PARTS OF MACHINES; PARTS OF THE AFOREMENTIONED GOODS OF METAL; REINFORCING METAL SLEEVES FOR PRESSURE PIPES; FITTINGS OF METAL FOR PIPES AND DUCTS FOR GASES, LIQUIDS AND SOLIDS IN PARTICULATE FORM (U.S. CLS. 2, 12, 13, 14, 23, 25 AND 50).

CLASS 17—RUBBER GOODS

FOR RUBBER TUBES; JUNCTIONS, NOT OF METAL FOR CONNECTING PIPES, DUCTS AND TUBES IN PRESSURIZED DUCT SYSTEMS; PIPE MUFFS, NOT OF METAL FOR USE WITH PRESSURIZED PIPES AND DUCTS FOR GASES, LIQUIDS AND SOLIDS IN PARTICULATE FORM; SEALANT COMPOUND FOR JOINTS IN PIPES AND DUCTS; SEALS FOR PIPES AND DUCTS FOR CONVEYING GASES, LIQUIDS AND SOLIDS IN PARTICULATE FORM; AND, PIPE GASKETS (U.S. CLS. 1, 5, 12, 13, 35 AND 50).

KATHLEEN M. VANSTON, EXAMINING ATTORNEY

SN 78-703,712. INDUSTRIAL COLOR, INC., NEW YORK, NY, FILED 8-30-2005.

INDUSTRIAL COLOR

NO CLAIM IS MADE TO THE EXCLUSIVE RIGHT TO USE "COLOR", APART FROM THE MARK AS SHOWN.

CLASS 40—MATERIAL TREATMENT

FOR DIGITAL CAPTURE, NAMELY ELECTRONIC DIGITIZING OF PHOTOS INTO COMPUTER READABLE MEDIA; POST PRODUCTION SERVICES IN THE FIELD OF DIGITAL IMAGING, NAMELY, RESTORATION AND ENHANCEMENT OF PHOTOGRAPHS ALTERATION AND RETOUCHING OF PHOTOGRAPHS (U.S. CLS. 100, 103 AND 106).

FIRST USE 11-25-2002; IN COMMERCE 11-25-2002.

CLASS 41—EDUCATION AND ENTERTAINMENT

FOR POST PRODUCTION SERVICES IN THE FIELD OF DIGITAL IMAGING, NAMELY, PHOTO EDITING (U.S. CLS. 100, 101 AND 107).

FIRST USE 11-25-2002; IN COMMERCE 11-25-2002.
ELLEN PERKINS, EXAMINING ATTORNEY

INDUSTRIAL COLOR

THE MARK CONSISTS OF STANDARD CHARACTERS WITHOUT CLAIM TO ANY PARTICULAR FONT, STYLE, SIZE, OR COLOR.

NO CLAIM IS MADE TO THE EXCLUSIVE RIGHT TO USE "COLOR", APART FROM THE MARK AS SHOWN.

CLASS 40—MATERIAL TREATMENT

FOR DIGITAL CAPTURE, NAMELY ELECTRONIC DIGITIZING OF PHOTOS INTO COMPUTER READABLE MEDIA; POST PRODUCTION SERVICES IN THE FIELD OF DIGITAL IMAGING, NAMELY, RESTORATION AND ENHANCEMENT OF PHOTOGRAPHS ALTERATION AND RETOUCHING OF PHOTOGRAPHS (U.S. CLS. 100, 103 AND 106).

FIRST USE 11-25-2002; IN COMMERCE 11-25-2002.

CLASS 41—EDUCATION AND ENTERTAINMENT

FOR POST PRODUCTION SERVICES IN THE FIELD OF DIGITAL IMAGING, NAMELY, PHOTO EDITING (U.S. CLS. 100, 101 AND 107).

FIRST USE 11-25-2002; IN COMMERCE 11-25-2002.

ELLEN PERKINS, EXAMINING ATTORNEY

SN 78-704,065. PHILLIPS FOODS, INC., BALTIMORE, MD, FILED 8-31-2005.

ASIAN RHYTHMS

THE MARK CONSISTS OF STANDARD CHARACTERS WITHOUT CLAIM TO ANY PARTICULAR FONT, STYLE, SIZE, OR COLOR.

NO CLAIM IS MADE TO THE EXCLUSIVE RIGHT TO USE "ASIAN", APART FROM THE MARK AS SHOWN.

CLASS 29—MEATS AND PROCESSED FOODS

FOR FROZEN, PASTEURIZED, PROCESSED AND CANNED SEAFOOD, NAMELY, CRAB MEAT, SOFT-SHELL CRABS, FISH, SHRIMP, LOBSTER MEAT, SCALLOPS, OYSTERS, CLAMS AND MUSSELS; FROZEN PREPARED FOODS CONSISTING PRIMARILY OF SEAFOOD, NAMELY, CRAB CAKES, CRAB CLAWS, CRAB IMPERIAL, STUFFED SHRIMP AND STUFFED FISH; FROZEN PREPARED ENTREES CONSISTING PRIMARILY OF SEAFOOD, CHICKEN, BEEF OR VEGETABLES; FROZEN PREPARED APPETIZERS CONSISTING PRIMARILY OF SEAFOOD, MEAT OR VEGETABLES; SOUPS, CHOWDERS AND BISQUES; AND DIPS EXCLUDING SALSAS AND OTHER SAUCES USED AS DIPS (U.S. CL. 46).

CLASS 30—STAPLE FOODS

FOR SEASONINGS; SAUCES; FROZEN PREPARED ENTREES CONSISTING PRIMARILY OF NOODLES OR RICE; AND PREPARED FROZEN DESSERTS, NAMELY, PIES, CAKES, CUSTARDS AND PUDDINGS; SEASONING AND SPICE MIXES FOR PREPARING DISHES CONSISTING PRIMARILY OF SEAFOOD (U.S. CL. 46).
TRACY WHITAKER-BOWN, EXAMINING ATTORNEY

SN 78-704,202. PAINTSTAR PAINTBALL LLC, SEWICKLEY, PA. FILED 8-31-2005.

PaintStar PAINTBALL

THE MARK CONSISTS OF STANDARD CHARACTERS WITHOUT CLAIM TO ANY PARTICULAR FONT, STYLE, SIZE, OR COLOR.

NO CLAIM IS MADE TO THE EXCLUSIVE RIGHT TO USE "PAINTBALL", APART FROM THE MARK AS SHOWN.

CLASS 25—CLOTHING

FOR SHIRTS; JERSEYS; JACKETS; SWEATSHIRTS; PANTS; SHORTS; HATS; BANDANAS; GLOVES (U.S. CLS. 22 AND 39).

CLASS 35—ADVERTISING AND BUSINESS

FOR RETAIL STORE SERVICES FEATURING PAINTBALL EQUIPMENT (U.S. CLS. 100, 101 AND 102).

CLASS 37—CONSTRUCTION AND REPAIR

FOR REPAIR AND MAINTENANCE OF PAINTBALL EQUIPMENT (U.S. CLS. 100, 103 AND 106).

CLASS 41—EDUCATION AND ENTERTAINMENT

FOR PROVIDING AND OPERATING INDOOR PAINTBALL FACILITIES; PROVIDING AND OPERATING OUTDOOR PAINTBALL FACILITIES; PROVIDING INSTRUCTION FOR USING PAINTBALL EQUIPMENT AND PLAYING THE SPORT OF PAINTBALL; ORGANIZING PAINTBALL GAMES AND COMPETITIONS; RENTAL OF PAINTBALL EQUIPMENT (U.S. CLS. 100, 101 AND 107).

KATHERINE STOIDES, EXAMINING ATTORNEY

SN 78-704,245. VALUE CITY OF MICHIGAN, INC., WESTLAND, MI. FILED 8-31-2005.

VALUE BUCKS

THE MARK CONSISTS OF STANDARD CHARACTERS WITHOUT CLAIM TO ANY PARTICULAR FONT, STYLE, SIZE, OR COLOR.

NO CLAIM IS MADE TO THE EXCLUSIVE RIGHT TO USE "BUCKS", APART FROM THE MARK AS SHOWN.

CLASS 35—ADVERTISING AND BUSINESS

FOR RETAIL DEPARTMENT STORE SERVICES (U.S. CLS. 100, 101 AND 102).
FIRST USE 4-1-2005; IN COMMERCE 4-1-2005.

CLASS 36—INSURANCE AND FINANCIAL

FOR FINANCIAL SERVICES, NAMELY, CHARGE CARD SERVICES, CREDIT CARD SERVICES, ISSUING STORED VALUE CARDS AND STORED VALUE GIFT CARDS (U.S. CLS. 100, 101 AND 102).
FIRST USE 4-1-2005; IN COMMERCE 4-1-2005.
KELLEY WELLS, EXAMINING ATTORNEY

SN 78-704,471. ROYALTON FOODSERVICE EQUIPMENT, CO., NORTH ROYALTON, OH. FILED 8-31-2005.

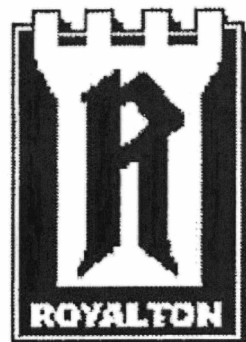

NO CLAIM IS MADE TO THE EXCLUSIVE RIGHT TO USE "ROYALTON", APART FROM THE MARK AS SHOWN.

CLASS 11—ENVIRONMENTAL CONTROL APPARATUS

FOR COMMERCIAL COOKING OVENS, ELECTRIC FOOD WARMERS, AND RADIANT HEATED HOLDING AND TRANSPORT CABINETS FOR BULK FOODS (U.S. CLS. 13, 21, 23, 31 AND 34).
FIRST USE 1-1-1980; IN COMMERCE 1-1-1980.

CLASS 20—FURNITURE AND ARTICLES NOT OTHERWISE CLASSIFIED

FOR FOOD STORAGE CABINETS; FOOD PREPARATION TABLES FOR BANQUETS FOR USE IN THE FOOD SERVICE INDUSTRY (U.S. CLS. 2, 13, 22, 25, 32 AND 50).
FIRST USE 1-1-1980; IN COMMERCE 1-1-1980.
ALLISON HOLTZ, EXAMINING ATTORNEY

SN 78-704,584. MUNCE, DON, LEE'S SUMMIT, MO. FILED 8-31-2005.

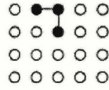

Center for Enrollment Leadership

NO CLAIM IS MADE TO THE EXCLUSIVE RIGHT TO USE "CENTER FOR ENROLLMENT LEADERSHIP", APART FROM THE MARK AS SHOWN.

THE MARK CONSISTS OF FOUR ROWS OF DOTS, WITH FIVE DOTS PER ROW, IN A RECTANGULAR SHAPE, OF WHICH THREE DOTS ARE SOLID, AND THE REST ARE OUTLINES ONLY. THE THREE SOLID DOTS ARE CONNECTED WITH STRAIGHT LINES. UNDER THE DOTS APPEAR THE WORDS "CENTER FOR ENROLLMENT LEADERSHIP".

CLASS 9—ELECTRICAL AND SCIENTIFIC APPARATUS

FOR PRE-RECORDED AUDIOTAPES, VIDEOTAPES, DVD'S, AND CD'S FEATURING INSTRUCTION IN THE FIELD OF COLLEGE AND UNIVERSITY ADMISSIONS AND ENROLLMENT (U.S. CLS. 21, 23, 26, 36 AND 38).

CLASS 16—PAPER GOODS AND PRINTED MATTER

FOR BOOKS AND BOOKLETS CONCERNING COLLEGE AND UNIVERSITY ADMISSIONS AND ENROLLMENT (U.S. CLS. 2, 5, 22, 23, 29, 37, 38 AND 50).

CLASS 35—ADVERTISING AND BUSINESS

FOR CONSULTING SERVICES FOR COLLEGES AND UNIVERSITIES IN THE FIELD OF ADMISSIONS AND ENROLLMENT, STRATEGIC PLANNING FOR ADMISSIONS AND ENROLLMENT, OPERATIONAL AUDITS IN THE ADMISSION AND ENROLLMENT FIELD, AND COMMUNICATIONS SKILLS RELATING TO ADMISSIONS AND ENROLLMENT (U.S. CLS. 100, 101 AND 102).

FIRST USE 11-3-2004; IN COMMERCE 11-3-2004.

CLASS 41—EDUCATION AND ENTERTAINMENT

FOR CONDUCTING WORKSHOPS AND SEMINARS IN THE FIELD OF COLLEGE AND UNIVERSITY ADMISSIONS AND ENROLLMENT (U.S. CLS. 100, 101 AND 107).

FIRST USE 11-3-2004; IN COMMERCE 11-3-2004.
DOMINIC FATHY, EXAMINING ATTORNEY

SN 78-704,703. TURBOCHEF TECHNOLOGIES, INC., ATLANTA, GA. FILED 8-31-2005.

TURBOCHEF

THE MARK CONSISTS OF STANDARD CHARACTERS WITHOUT CLAIM TO ANY PARTICULAR FONT, STYLE, SIZE, OR COLOR.

OWNER OF U.S. REG. NOS. 1,762,672, 2,662,613 AND 2,715,929.

CLASS 7—MACHINERY

FOR RESIDENTIAL KITCHEN APPLIANCES, NAMELY DISH WASHING MACHINES (U.S. CLS. 13, 19, 21, 23, 31, 34 AND 35).

CLASS 11—ENVIRONMENTAL CONTROL APPARATUS

FOR RESIDENTIAL KITCHEN APPLIANCES, NAMELY DOMESTIC COOKING OVENS, COOKING RANGES, ELECTRIC AND GAS STOVES, ELECTRIC AND GAS COOKTOPS, REFRIGERATORS, FREEZERS, COMBINATION MICROWAVE/THERMAL OVENS, VENTILATION HOODS FOR COOKING, ICE MAKERS, AND REFRIGERATED WINE COOLERS (U.S. CLS. 13, 21, 23, 31 AND 34).
TARAH HARDY, EXAMINING ATTORNEY

SN 78-704,761. VITA ZAHNFABRIK H. RAUTER GMBH & CO. KG, D-79713 BAD SACKINGEN, FED REP GERMANY, FILED 8-31-2005.

4M1

THE MARK CONSISTS OF STANDARD CHARACTERS WITHOUT CLAIM TO ANY PARTICULAR FONT, STYLE, SIZE, OR COLOR.

OWNER OF U.S. REG. NOS. 2,954,165, 2,954,167 AND 2,954,170.
SEC. 2(F).

CLASS 5—PHARMACEUTICALS

FOR DENTAL RESTORATIVE MATERIALS OF A SPECIFIC TOOTH COLOR (U.S. CLS. 6, 18, 44, 46, 51 AND 52).

FIRST USE 2-0-1998; IN COMMERCE 2-0-1998.

CLASS 10—MEDICAL APPARATUS

FOR ARTIFICIAL TEETH OF A SPECIFIC COLOR; COLOR SCALES FOR DETERMINING THE COLORS OF DENTAL RESTORATIVE MATERIALS AND ARTIFICIAL TEETH TO MATCH NATURAL TOOTH COLORS (U.S. CLS. 26, 39 AND 44).

FIRST USE 2-0-1998; IN COMMERCE 2-0-1998.
ELISSA GARBER KON, EXAMINING ATTORNEY

SN 78-704,794. TOTAL TRIATHLON INC., TAMPA, FL.
FILED 8-31-2005.



THE COLOR(S) WHITE, BLACK AND BROWN IS/ARE CLAIMED AS A FEATURE OF THE MARK.

THE MARK CONSISTS OF A BLACK/WHITE DOG WITH A BROWN SPOT ON ITS BACK, BROWN AREAS AROUND ITS EYES, BROWN TAIL, AND BROWN EARS.

CLASS 25—CLOTHING

FOR CLOTHING, NAMELY, ATHLETIC UNIFORMS, SPORT SHIRTS, SPORT JACKETS, SPORTS JERSEYS, TANK-TOPS, T-SHIRTS, SHORTS, TIGHTS, BATHING SUITS, SWIM CAPS, CAPS WITH VISORS AND BEANIES (U.S. CLS. 22 AND 39).

FIRST USE 11-1-2004; IN COMMERCE 11-1-2004.

CLASS 41—EDUCATION AND ENTERTAINMENT

FOR PHYSICAL FITNESS CONSULTATION AND INSTRUCTION, NAMELY, PROVIDING TRIATHLON, CYCLING AND RUNNING TRAINING (U.S. CLS. 100, 101 AND 107).

FIRST USE 11-1-2004; IN COMMERCE 11-1-2004.

H. M. FISHER, EXAMINING ATTORNEY

SN 78-704,799. VITA ZAHNFABRIK H. RAUTER GMBH & CO. KG, D-79713 BAD SACKINGEN, FED REP GERMANY, FILED 8-31-2005.

4M3

THE MARK CONSISTS OF STANDARD CHARACTERS WITHOUT CLAIM TO ANY PARTICULAR FONT, STYLE, SIZE, OR COLOR.

OWNER OF U.S. REG. NOS. 2,954,165, 2,954,167 AND 2,954,170.

SEC. 2(F).

CLASS 5—PHARMACEUTICALS

FOR DENTAL RESTORATIVE MATERIALS OF A SPECIFIC TOOTH COLOR (U.S. CLS. 6, 18, 44, 46, 51 AND 52).

FIRST USE 2-0-1998; IN COMMERCE 2-0-1998.

CLASS 10—MEDICAL APPARATUS

FOR ARTIFICIAL TEETH OF A SPECIFIC COLOR; COLOR SCALES FOR DETERMINING THE COLORS OF DENTAL RESTORATIVE MATERIALS AND ARTIFICIAL TEETH TO MATCH NATURAL TOOTH COLORS (U.S. CLS. 26, 39 AND 44).

FIRST USE 2-0-1998; IN COMMERCE 2-0-1998.

ELISSA GARBER KON, EXAMINING ATTORNEY

SN 78-704,821. VITA ZAHNFABRIK H. RAUTER GMBH & CO. KG, D79713 BAD SACKINGEN, FED REP GERMANY, FILED 8-31-2005.

5M3

THE MARK CONSISTS OF STANDARD CHARACTERS WITHOUT CLAIM TO ANY PARTICULAR FONT, STYLE, SIZE, OR COLOR.

OWNER OF U.S. REG. NOS. 2,954,165, 2,954,170 AND OTHERS.

SEC. 2(F).

CLASS 5—PHARMACEUTICALS

FOR DENTAL RESTORATIVE MATERIALS OF A SPECIFIC TOOTH COLOR (U.S. CLS. 6, 18, 44, 46, 51 AND 52).

FIRST USE 2-0-1998; IN COMMERCE 2-0-1998.

CLASS 10—MEDICAL APPARATUS

FOR ARTIFICIAL TEETH OF A SPECIFIC COLOR; COLOR SCALES FOR DETERMINING THE COLORS OF DENTAL RESTORATIVE MATERIALS AND ARTIFICIAL TEETH TO MATCH NATURAL TOOTH COLORS (U.S. CLS. 26, 39 AND 44).

FIRST USE 2-0-1998; IN COMMERCE 2-0-1998.

ELISSA GARBER KON, EXAMINING ATTORNEY

SN 78-704,833. VITA ZAHNFABRIK H. RAUTER GMBH & CO. KG, D-79713 BAD SACKINGEN, FED REP GERMANY, FILED 8-31-2005.

4M2

THE MARK CONSISTS OF STANDARD CHARACTERS WITHOUT CLAIM TO ANY PARTICULAR FONT, STYLE, SIZE, OR COLOR.

OWNER OF U.S. REG. NOS. 2,954,165, 2,954,167 AND 2,954,170.

SEC. 2(F).

CLASS 5—PHARMACEUTICALS

FOR DENTAL RESTORATIVE MATERIALS OF A SPECIFIC TOOTH COLOR (U.S. CLS. 6, 18, 44, 46, 51 AND 52).

FIRST USE 2-0-1998; IN COMMERCE 2-0-1998.

CLASS 10—MEDICAL APPARATUS

FOR ARTIFICIAL TEETH OF A SPECIFIC COLOR; COLOR SCALES FOR DETERMINING THE COLORS OF DENTAL RESTORATIVE MATERIALS AND ARTIFICIAL TEETH TO MATCH NATURAL TOOTH COLORS (U.S. CLS. 26, 39 AND 44).

FIRST USE 2-0-1998; IN COMMERCE 2-0-1998.
ELISSA GARBER KON, EXAMINING ATTORNEY

CLASS 10—MEDICAL APPARATUS

FOR ARTIFICIAL TEETH OF A SPECIFIC COLOR; COLOR SCALES FOR DETERMINING THE COLORS OF DENTAL RESTORATIVE MATERIALS AND ARTIFICIAL TEETH TO MATCH NATURAL TOOTH COLORS (U.S. CLS. 26, 39 AND 44).

FIRST USE 2-0-1998; IN COMMERCE 2-0-1998.
ELISSA GARBER KON, EXAMINING ATTORNEY

SN 78-704,852. VITA ZAHNFABRIK H. RAUTER GMBH & CO. KG, D-79713 BAD SACKINGEN, FED REP GERMANY, FILED 8-31-2005.

SN 78-704,873. VITA ZAHNFABRIK H. RAUTER GMBH & CO. KG, D-79713 BAD SACKINGEN, FED REP GERMANY, FILED 8-31-2005.

2M2

THE MARK CONSISTS OF STANDARD CHARACTERS WITHOUT CLAIM TO ANY PARTICULAR FONT, STYLE, SIZE, OR COLOR.

OWNER OF U.S. REG. NOS. 2,954,165, 2,954,166 AND 2,954,167.
SEC. 2(F).

CLASS 5—PHARMACEUTICALS

FOR DENTAL RESTORATIVE MATERIALS OF A SPECIFIC TOOTH COLOR (U.S. CLS. 6, 18, 44, 46, 51 AND 52).

FIRST USE 2-0-1998; IN COMMERCE 2-0-1998.

CLASS 10—MEDICAL APPARATUS

FOR ARTIFICIAL TEETH OF A SPECIFIC COLOR; COLOR SCALES FOR DETERMINING THE COLORS OF DENTAL RESTORATIVE MATERIALS AND ARTIFICIAL TEETH TO MATCH NATURAL TOOTH COLORS (U.S. CLS. 26, 39 AND 44).

FIRST USE 2-0-1998; IN COMMERCE 2-0-1998.
ELISSA GARBER KON, EXAMINING ATTORNEY

SN 78-704,854. VITA ZAHNFABRIK H. RAUTER GMBH & CO. KG, D-79713 BAD SACKINGEN, FED REP GERMANY, FILED 8-31-2005.

2M1

THE MARK CONSISTS OF STANDARD CHARACTERS WITHOUT CLAIM TO ANY PARTICULAR FONT, STYLE, SIZE, OR COLOR.

OWNER OF U.S. REG. NOS. 2,954,165, 2,954,170 AND OTHERS.
SEC. 2(F).

CLASS 5—PHARMACEUTICALS

FOR DENTAL RESTORATIVE MATERIALS OF A SPECIFIC TOOTH COLOR (U.S. CLS. 6, 18, 44, 46, 51 AND 52).

FIRST USE 2-0-1998; IN COMMERCE 2-0-1998.

5M1

THE MARK CONSISTS OF STANDARD CHARACTERS WITHOUT CLAIM TO ANY PARTICULAR FONT, STYLE, SIZE, OR COLOR.

OWNER OF U.S. REG. NOS. 2,954,165, 2,954,170 AND OTHERS.
SEC. 2(F).

CLASS 5—PHARMACEUTICALS

FOR DENTAL RESTORATIVE MATERIALS OF A SPECIFIC TOOTH COLOR (U.S. CLS. 6, 18, 44, 46, 51 AND 52).

FIRST USE 2-0-1998; IN COMMERCE 2-0-1998.

CLASS 10—MEDICAL APPARATUS

FOR ARTIFICIAL TEETH OF A SPECIFIC COLOR; COLOR SCALES FOR DETERMINING THE COLORS OF DENTAL RESTORATIVE MATERIALS AND ARTIFICIAL TEETH TO MATCH NATURAL TOOTH COLORS (U.S. CLS. 26, 39 AND 44).

FIRST USE 2-0-1998; IN COMMERCE 2-0-1998.
ELISSA GARBER KON, EXAMINING ATTORNEY

SN 78-705,232. VERIMATRIX, INC., SAN DIEGO, CA. FILED 9-1-2005.

FEDERATED AUTHENTICATION

THE MARK CONSISTS OF STANDARD CHARACTERS WITHOUT CLAIM TO ANY PARTICULAR FONT, STYLE, SIZE, OR COLOR.

NO CLAIM IS MADE TO THE EXCLUSIVE RIGHT TO USE "AUTHENTICATION", APART FROM THE MARK AS SHOWN.

CLASS 9—ELECTRICAL AND SCIENTIFIC APPARATUS

FOR COMPUTER SOFTWARE AND HARDWARE FOR IDENTIFICATION OF USERS ON A PUBLIC NETWORK (U.S. CLS. 21, 23, 26, 36 AND 38).

CLASS 42—SCIENTIFIC, COMPUTER AND LEGAL SERVICES

FOR COMPUTER NETWORK SERVICES, NAMELY, PROVIDING IDENTIFICATION OF USERS ON A PUBLIC NETWORK AND PROVIDING TECHNICAL AND CUSTOMER SUPPORT THEREWITH IN THE NATURE OF MONITORING COMPUTER NETWORKS, TROUBLESHOOTING COMPUTER SOFTWARE AND HARDWARE PROBLEMS (U.S. CLS. 100 AND 101).

HEATHER THOMPSON, EXAMINING ATTORNEY

CLASS 9—ELECTRICAL AND SCIENTIFIC APPARATUS

FOR COMPUTER SOFTWARE FOR AUTOMATING A PROCESS FOR IDENTIFICATION AND REGISTRATION OF WORKS OF AUTHORSHIP, SAID WORKS COMPRISING MUSIC, BOOKS, MULTI-MEDIA, VIDEO, SOFTWARE AND PRINTED MEDIA (U.S. CLS. 21, 23, 26, 36 AND 38).

CLASS 42—SCIENTIFIC, COMPUTER AND LEGAL SERVICES

FOR COMPUTER NETWORK SERVICES, NAMELY, PROVIDING TECHNICAL SUPPORT FOR A COPYRIGHT REGISTRY SYSTEM OFFERED OVER A PUBLIC NETWORK IN THE NATURE OF MONITORING COMPUTER NETWORKS, TROUBLESHOOTING COMPUTER SOFTWARE AND HARDWARE PROBLEMS (U.S. CLS. 100 AND 101).

HEATHER THOMPSON, EXAMINING ATTORNEY

SN 78-705,249. PHILLIPS FOODS, INC., BALTIMORE, MD. FILED 9-1-2005.

LATIN RHYTHMS

THE MARK CONSISTS OF STANDARD CHARACTERS WITHOUT CLAIM TO ANY PARTICULAR FONT, STYLE, SIZE, OR COLOR.

NO CLAIM IS MADE TO THE EXCLUSIVE RIGHT TO USE "LATIN", APART FROM THE MARK AS SHOWN.

SN 78-705,385. GAYLORD ENTERTAINMENT COMPANY, NASHVILLE, TN. FILED 9-1-2005.

CLASS 29—MEATS AND PROCESSED FOODS

FOR FROZEN, PASTEURIZED, PROCESSED AND CANNED SEAFOOD, NAMELY, CRAB MEAT, SOFT-SHELL CRABS, FISH, SHRIMP, LOBSTER MEAT, SCALLOPS, OYSTERS, CLAMS AND MUSSELS; FROZEN PREPARED FOODS CONSISTING PRIMARILY OF SEAFOOD, NAMELY, CRAB CAKES, CRAB CLAWS, CRAB IMPERIAL, STUFFED SHRIMP AND STUFFED FISH; FROZEN PREPARED ENTREES CONSISTING PRIMARILY OF SEAFOOD, CHICKEN, BEEF OR VEGETABLES; FROZEN PREPARED APPETIZERS CONSISTING PRIMARILY OF SEAFOOD, MEAT OR VEGETABLES; SOUPS, CHOWDERS AND BISQUES; AND DIPS EXCLUDING SALSAS AND OTHER SAUCES USED AS DIPS (U.S. CL. 46).

CLASS 30—STAPLE FOODS

FOR SEASONINGS; SAUCES; FROZEN PREPARED ENTREES CONSISTING PRIMARILY OF NOODLES OR RICE; AND PREPARED FROZEN DESSERTS, NAMELY, PIES, CAKES, CUSTARDS AND PUDDINGS; SEASONING AND SPICE MIXES FOR PREPARING DISHES CONSISTING PRIMARILY OF SEAFOOD (U.S. CL. 46).

TRACY WHITAKER-BOWN, EXAMINING ATTORNEY

OPRYLAND

THE MARK CONSISTS OF STANDARD CHARACTERS WITHOUT CLAIM TO ANY PARTICULAR FONT, STYLE, SIZE, OR COLOR.

OWNER OF U.S. REG. NOS. 2,844,869, 2,997,213 AND OTHERS.

SN 78-705,251. VERIMATRIX, INC., SAN DIEGO, CA. FILED 9-1-2005.

FEDERATED REGISTRY

THE MARK CONSISTS OF STANDARD CHARACTERS WITHOUT CLAIM TO ANY PARTICULAR FONT, STYLE, SIZE, OR COLOR.

NO CLAIM IS MADE TO THE EXCLUSIVE RIGHT TO USE "REGISTRY", APART FROM THE MARK AS SHOWN.

CLASS 21—HOUSEWARES AND GLASS

FOR SOUVENIRS, NAMELY, PLATES, DISHES, BEVERAGE GLASSWARE, MUGS AND CUPS (U.S. CLS. 2, 13, 23, 29, 30, 33, 40 AND 50).

CLASS 25—CLOTHING

FOR CLOTHING, NAMELY, T-SHIRTS AND HATS (U.S. CLS. 22 AND 39).

CLASS 41—EDUCATION AND ENTERTAINMENT

FOR AMUSEMENT PARK SERVICES; ENTERTAINMENT SERVICES, NAMELY, CONCERTS, LIVE MUSICAL PERFORMANCES, AND LIVE THEATRICAL PERFORMANCES (U.S. CLS. 100, 101 AND 107).

PAULA MAYS, EXAMINING ATTORNEY

SN 78-706,024. INJECTABLE THERAPY SERVICES, INC.,
GLENDALE, CA. FILED 9-2-2005.

ITS PHARMACY

THE MARK CONSISTS OF STANDARD CHARACTERS WITHOUT CLAIM TO ANY PARTICULAR FONT, STYLE, SIZE, OR COLOR.

NO CLAIM IS MADE TO THE EXCLUSIVE RIGHT TO USE "PHARMACY", APART FROM THE MARK AS SHOWN.

CLASS 35—ADVERTISING AND BUSINESS

FOR RETAIL PHARMACY SERVICES, INCLUDING PHARMACY SERVICES FOR PATIENTS WITH INTRAVENOUS PHARMACEUTICAL NEEDS (U.S. CLS. 100, 101 AND 102).

FIRST USE 12-31-1998; IN COMMERCE 12-31-1998.

CLASS 44—MEDICAL, BEAUTY AND AGRICULTURAL SERVICES

FOR HOME HEALTH CARE SERVICES; INFUSION THERAPY SERVICES (U.S. CLS. 100 AND 101).

FIRST USE 12-31-1998; IN COMMERCE 12-31-1998.

ALICE SUE CARRUTHERS, EXAMINING ATTORNEY

SN 78-706,052. WAKASHACHIYA CO., LTD., NAGOYA-SHI,
AICHI, JAPAN, FILED 9-2-2005.

OWNER OF JAPAN REG. NO. 31446659, DATED 4-30-1996,
EXPIRES 4-30-2016.

OWNER OF JAPAN REG. NO. 2284863, DATED 11-30-1990,
EXPIRES 11-30-2010.

OWNER OF JAPAN REG. NO. 2264910, DATED 9-21-1990,
EXPIRES 9-21-2010.

WAKASHACHIYA, MEANS YOUNG; KILLER WHALE;
HOUSE IN ENGLISH.

THE NON-LATIN CHARACTER(S) IN THE MARK
TRANSLITERATES INTO WAKASHACHIYA, AND THIS
MEANS YOUNG; KILLER WHALE; HOUSE IN ENGLISH.

CLASS 30—STAPLE FOODS

FOR SEASONINGS, NAMELY, MISO BEAN PASTE, WORCESTER SAUCE, MEAT GRAVIES, KETCHUP, SOY SAUCE, VINEGAR, VINEGAR MIXES, SALAD DRESSINGS, WHITE SAUCE, MAYONNAISE, SAUCES FOR BARBECUED MEAT, CUBE SUGAR, FRUCTOSE, CRYSTAL SUGAR, SUGAR, MALTOSE, HONEY, GLUCOSE, POWDERED STARCH SYRUP, STARCH SYRUP, TABLE SALT MIXED WITH SESAME SEEDS, COOKING SALT, ROASTED AND GROUND SESAME SEEDS, CELERY SALT, CHEMICAL SEASONINGS; SPICES; UNROASTED COFFEE; CEREAL PREPARATIONS, NAMELY, UDON NOODLES, OATMEAL, DRIED COOKED-RICE, ENRICHED RICE, PASTA-WRAPPINGS FOR GYOZA, CORN FLAKES, POWDER OF SWEETENED BEAN JAM, ARTIFICIAL RICE, SPAGHETTI, SOMEN NOODLES, INSTANT UDON NOODLES, INSTANT SOBA NOODLES, INSTANT CHINESE NOODLES, SOBA NOODLES, CHINESE NOODLES, BEAN-STARCH NOODLES, BREAD CRUMB, CHINESE RICE NOODLES, DRIED PIECES OF WHEAT GLUTEN, CANNED COOKED RICE, MACARONI, POUNDED RICE CAKES; ALMOND PASTE; CHINESE STUFFED DUMPLINGS; SANDWICHES; CHINESE STEAMED DUMPLINGS; SUSHI; FRIED BALLS OF BATTER MIX WITH SMALL PIECES OF OCTOPUS; STEAMED BUNS STUFFED WITH MINCED MEAT; HAMBURGER; PIZZAS; BOXED LUNCHES, CONSISTING OF NOODLES, RICE, COOKED VEGETABLES, COOKED FISH, BEEF, CHICKEN OR PICKLES; HOT DOGS, NAMELY, HOT DOG SANDWICHES; MEAT PIES; RAVIOLI; YEAST POWDER; FERMENTING MALTED RICE; YEAST; BAKING POWDER; INSTANT CONFECTIONERY MIXES, NAMELY, INSTANT JELLY MIXES, INSTANT DOUGHNUTS MIXES, INSTANT PUDDING MIXES, INSTANT PANCAKE MIXES, MIXES OF SWEET RED-BEAN JELLY (U.S. CL. 46).

CLASS 43—HOTEL AND RESTAURANT SERVICES

FOR PROVIDING UDON OR SOBA NOODLES, NAMELY, SERVING UDON OR SOBA NOODLES; PROVIDING RICE BOWL DISHES, NAMELY, SERVING RICE BOWL DISHES; PROVIDING ALCOHOLIC BEVERAGES, NAMELY, SERVING ALCOHOLIC BEVERAGES; PROVIDING TEA, COFFEE, COCOA, CARBONATED DRINKS OR FRUIT JUICE BEVERAGES, NAMELY, SERVING TEA, COFFEE, COCOA, CARBONATED DRINKS OR FRUIT JUICE BEVERAGES (U.S. CLS. 100 AND 101).

RUDY R. SINGLETON, EXAMINING ATTORNEY

SN 78-706,200. LOGO ACQUISITION CORPORATION, BEVERLY HILLS, CA. FILED 9-2-2005.

THE MARK CONSISTS OF STANDARD CHARACTERS WITHOUT CLAIM TO ANY PARTICULAR FONT, STYLE, SIZE, OR COLOR.

CLASS 16—PAPER GOODS AND PRINTED MATTER

FOR PUBLICATIONS, NAMELY, BOOKS, MAGAZINES, PAMPHLETS, BROCHURES, CIRCULARS, ALL FEATURING INFORMATION REGARDING THE TELECOMMUNICATIONS INDUSTRY (U.S. CLS. 2, 5, 22, 23, 29, 37, 38 AND 50).

CLASS 38—COMMUNICATION

FOR WIRELESS BROADBAND COMMUNICATION SERVICES; SATELLITE TELECOMMUNICATION SERVICES, NAMELY, SATELLITE TRANSMISSION SERVICES; ELECTRONIC DATA TRANSMISSION, NAMELY, PROVIDING COMPUTER COMMUNICATIONS AND DATA TRANSMISSION SERVICES VIA RADIO AT REMOTE LOCATIONS; WIRELESS ELECTRONIC TRANSMISSION OF MESSAGES AND DATA; WIRELESS ELECTRONIC TRANSMISSION OF DATA (U.S. CLS. 100, 101 AND 104).

CLASS 42—SCIENTIFIC, COMPUTER AND LEGAL SERVICES

FOR INFORMATION TECHNOLOGY CONSULTING; LEGAL SERVICES IN THE FIELD OF TELECOMMUNICATIONS; COMPUTER CONSULTING; COMPUTER SOFTWARE CONSULTING; TECHNOLOGICAL CONSULTING IN THE TECHNOLOGY FIELD OF WIRELESS COMMUNICATION NETWORKS (U.S. CLS. 100 AND 101).

WENDY JUN, EXAMINING ATTORNEY

SN 78-706,798. NORTH SEA PLASTICS LIMITED, GLASGOW, UNITED KINGDOM, FILED 9-5-2005.

SILVERSHIELD

THE MARK CONSISTS OF STANDARD CHARACTERS WITHOUT CLAIM TO ANY PARTICULAR FONT, STYLE, SIZE, OR COLOR.

PRIORITY CLAIMED UNDER SEC. 44(D) ON UNITED KINGDOM APPLICATION NO. 2396019, FILED 7-5-2005, REG. NO. 2396019A, DATED 7-5-2005, EXPIRES 7-5-2015.

CLASS 17—RUBBER GOODS

FOR PLASTIC MATERIALS, NAMELY, THERMOPLASTICS IN THE FORM OF SHEETS, FILMS, BLOCKS, POLYETHYLENE FOAM, BRAID AND MATTING FOR USE IN MANUFACTURE OF PROSTHETIC AND ORTHOTIC GOODS; PLASTIC MATERIALS IN SHEET FORM FOR USE IN THE PROSTHETICS AND ORTHOTICS INDUSTRIES; PLASTIC MATERIALS, NAMELY, FILMS, BLOCKS POLYETHYLENE FOAM, BRAID AND MATTING FOR USE IN THE PROSTHETICS AND ORTHOTICS INDUSTRIES; PLASTIC MATERIALS WITH ANTI-MICROBIAL PROPERTIES, NAMELY, SHEETS, FILMS, BLOCKS, POLYETHYLENE FOAM, BRAID AND MATTING FOR USE IN MANUFACTURE OF PROSTHETIC AND ORTHOTIC GOODS (U.S. CLS. 1, 5, 12, 13, 35 AND 50).

CLASS 40—MATERIAL TREATMENT

FOR TREATMENT OF PLASTICS; TREATMENT OF PLASTICS WITH ANTI-MICROBIAL MATERIALS; CUSTOM MANUFACTURE OF PLASTIC MATERIALS, NAMELY, SHEETS, FILMS, BLOCKS, POLYETHYLENE FOAM, BRAID AND MATTING FOR USE IN MANUFACTURE OF PROSTHETIC AND ORTHOTIC GOODS; CUSTOM MANUFACTURE OF PLASTIC MATERIALS FOR USE IN THE PROSTHETICS AND ORTHOTICS INDUSTRIES; RELATED CONSULTATION SERVICES RELATING TO ALL THE AFORESAID SERVICES (U.S. CLS. 100, 103 AND 106).

TRACY CROSS, EXAMINING ATTORNEY

SN 78-707,007. STEFAN HITZ FIRMA MAXNO E.K., ERFTSTADT-HERRIG, FED REP GERMANY, FILED 9-6-2005.



OWNER OF ERPN CMNTY TM OFC REG. NO. 002684595, DATED 8-27-2003, EXPIRES 5-6-2012.

THE COLOR BEIGE IS CLAIMED AS A FEATURE OF THE MARK.

THE MARK CONSISTS OF THE WORDING "CONCEPT FOR YOU" IN THE COLOR BEIGE, AND A BEIGE BAR SURROUNDING THE WORD "FOR".

CLASS 20—FURNITURE AND ARTICLES NOT OTHERWISE CLASSIFIED

FOR FURNITURE, NAMELY FOLDING SEATS AND FOLDING EASY CHAIRS; AIR CUSHION, NOT FOR MEDICAL PURPOSES (U.S. CLS. 2, 13, 22, 25, 32 AND 50).

CLASS 28—TOYS AND SPORTING GOODS

FOR FISHING EQUIPMENT AND ACCESSORIES, NAMELY GUT FOR FISHING, FISH HOOKS, BAGS FOR FISHING RODS, DECOYS FOR FISHING (U.S. CLS. 22, 23, 38 AND 50).

ALEXANDER L. POWERS, EXAMINING ATTORNEY

SN 78-707,254. SOGGY PAWS, INC., CHICAGO, IL. FILED 9-6-2005.

Soggy Paws

THE MARK CONSISTS OF STANDARD CHARACTERS WITHOUT CLAIM TO ANY PARTICULAR FONT, STYLE, SIZE, OR COLOR.

CLASS 35—ADVERTISING AND BUSINESS

FOR RETAIL STORES FEATURING A WIDE VARIETY OF PET CARE PRODUCTS (U.S. CLS. 100, 101 AND 102).

FIRST USE 10-30-2003; IN COMMERCE 4-1-2004.

CLASS 44—MEDICAL, BEAUTY AND AGRICULTURAL SERVICES

FOR ANIMAL GROOMING (U.S. CLS. 100 AND 101).

FIRST USE 10-30-2003; IN COMMERCE 9-14-2004.
ANGELA M. MICHELI, EXAMINING ATTORNEY

SN 78-707,985. CONDOR USA, INC., WESTON, NJ. FILED 9-7-2005.

SN 78-709,015. KUBIK INC., MISSISSAUGA, CANADA, FILED 9-8-2005.

CONDOR LITTLE

THE MARK CONSISTS OF STANDARD CHARACTERS WITHOUT CLAIM TO ANY PARTICULAR FONT, STYLE, SIZE, OR COLOR.

THE NAME "CONDOR LITTLE" DOES NOT IDENTIFY A LIVING INDIVIDUAL.

CLASS 3—COSMETICS AND CLEANING PREPARATIONS

FOR TOOTHPASTE, DENTAL PROPHYLAXIS PREPARATION, NAMELY MOUTHWASH (U.S. CLS. 1, 4, 6, 50, 51 AND 52).

CLASS 21—HOUSEWARES AND GLASS

FOR TOOTHBRUSHES, DENTAL FLOSS, DENTAL FLOSS DISPENSERS, DENTURE BRUSHES (U.S. CLS. 2, 13, 23, 29, 30, 33, 40 AND 50).

MATTHEW PAPPAS, EXAMINING ATTORNEY

SN 78-708,964. HOWELL, JOHN C., RIDGELAND, MS. FILED 9-8-2005.

NOROCKS

THE MARK CONSISTS OF STANDARD CHARACTERS WITHOUT CLAIM TO ANY PARTICULAR FONT, STYLE, SIZE, OR COLOR.

CLASS 41—EDUCATION AND ENTERTAINMENT

FOR VIDEO AND DIGITAL MULTIMEDIA TELEVISION SHOW AND VIDEO- DISC AND CASSETTE PRODUCTION SERVICES AND CONSULTATION IN SUCH FIELDS (U.S. CLS. 100, 101 AND 107).

CLASS 42—SCIENTIFIC, COMPUTER AND LEGAL SERVICES

FOR WEB BASED MULTIMEDIA COMPUTER PROGRAMMING, WEB SITE DESIGN AND CONSULTING IN SUCH FIELDS (U.S. CLS. 100 AND 101).

HANNO RITTNER, EXAMINING ATTORNEY

Think kubik

THE MARK CONSISTS OF STANDARD CHARACTERS WITHOUT CLAIM TO ANY PARTICULAR FONT, STYLE, SIZE, OR COLOR.

CLASS 35—ADVERTISING AND BUSINESS

FOR ARRANGING AND CONDUCTING OF EXHIBITS FOR BUSINESS AND ADVERTISING PURPOSES FOR OTHERS (U.S. CLS. 100, 101 AND 102).

CLASS 37—CONSTRUCTION AND REPAIR

FOR CONSTRUCTION AND INSTALLATION OF EXHIBITS FOR BUSINESS AND ADVERTISING PURPOSES FOR OTHERS FOR TRADE SHOWS, MUSEUMS, RETAIL STORES, BUSINESS OFFICES AND VISITOR CENTRES (U.S. CLS. 100, 103 AND 106).

CLASS 42—SCIENTIFIC, COMPUTER AND LEGAL SERVICES

FOR DESIGNING EXHIBITS FOR BUSINESS AND ADVERTISING PURPOSES FOR OTHERS FOR TRADE SHOWS, MUSEUMS, RETAIL STORES, BUSINESS OFFICES AND VISITOR CENTRES (U.S. CLS. 100 AND 101).

JULIE WATSON, EXAMINING ATTORNEY

SN 78-709,066. FREUDENBERG-NOK GENERAL PARTNERSHIP, PLYMOUTH, MI. FILED 9-8-2005.

FN

THE MARK CONSISTS OF STANDARD CHARACTERS WITHOUT CLAIM TO ANY PARTICULAR FONT, STYLE, SIZE, OR COLOR.

CLASS 6—METAL GOODS

FOR METAL GASKETS FOR USE IN LAND VEHICLE APPLICATIONS (U.S. CLS. 2, 12, 13, 14, 23, 25 AND 50).
FIRST USE 11-0-1990; IN COMMERCE 11-0-1990.

CLASS 17—RUBBER GOODS

FOR NON-METAL GASKETS, O-RINGS AND SEALS FOR USE IN LAND VEHICLE, FLUID POWER, AND INDUSTRIAL APPLICATIONS; NOISE, VIBRATION AND HARSHNESS DAMPING CONTROLS FOR USE IN LAND VEHICLE AND INDUSTRIAL APPLICATIONS (U.S. CLS. 1, 5, 12, 13, 35 AND 50).

FIRST USE 11-0-1990; IN COMMERCE 11-0-1990.
KYLE PEETE, EXAMINING ATTORNEY

SN 78-709,193. LOUISVILLE MEDICAL CENTER DEVELOPMENT CORPORATION, LOUISVILLE, KY. FILED 9-8-2005.



NO CLAIM IS MADE TO THE EXCLUSIVE RIGHT TO USE "LOUISVILLE'S HEALTH SCIENCE BUSINESS CENTER", APART FROM THE MARK AS SHOWN.

THE COLOR(S) BLACK AND RED IS/ARE CLAIMED AS A FEATURE OF THE MARK.

THE MARK CONSISTS OF THE WORD NUCLEUS WITH STYLIZED ARCS ABOVE AND THE WORDS LOUISVILLE'S HEALTH SCIENCE BUSINESS CENTER BELOW, ALL IN THE COLOR BLACK EXCEPT THE LETTERS "U" AND "L" OF THE WORD NUCLEUS ARE THE COLOR RED.

CLASS 35—ADVERTISING AND BUSINESS

FOR BUSINESS MANAGEMENT AND CONSULTATION IN THE AREA OF LIFE SCIENCES AND HEALTHCARE TECHNOLOGY, NAMELY, SUPPORT FOR ENTREPRENEURS THROUGH AN INCUBATOR PROGRAM, PROVIDING BUSINESS EVALUATION AND ADVICE, CONCEPT EVALUATION THROUGH TECHNICAL AND MARKET FEASIBILITY ANALYSIS, PLANNING AND ASSISTANCE IN CONNECTION WITH OPERATIONS, BUSINESS-BUILDING, PRODUCT DEVELOPMENT, SALES, MARKETING, DISTRIBUTION, FINANCING, FUNDING, AND RESOURCE ACQUISITION; ECONOMIC FORECASTING AND ANALYSIS IN THE AREA OF LIFE SCIENCES AND HEALTHCARE TECHNOLOGY (U.S. CLS. 100, 101 AND 102).

CLASS 36—INSURANCE AND FINANCIAL

FOR INVESTMENT CONSULTATION IN THE AREA OF LIFE SCIENCES AND HEALTHCARE TECHNOLOGY, NAMELY, PROVIDING ADVICE FOR VENTURE CAPITAL FUNDING AND ENTREPRENEUR LEADERSHIP FOR BUSINESS VENTURES; INVESTMENT BROKERAGE IN THE AREA OF LIFE SCIENCES AND HEALTHCARE TECHNOLOGY, NAMELY, FINDING INVESTORS FOR BUSINESSES IN SEARCH OF INVESTMENT CAPITAL AND FINDING BUSINESS INVESTMENT OPPORTUNITIES FOR INTERESTED INVESTORS, EVALUATING AND SCREENING OF BUSINESS INVESTMENT OPPORTUNITIES FOR OTHERS, AND ADVISING ENTREPRENEURS IN CONNECTION WITH THEIR STRATEGIES FOR RAISING PRIVATE EQUITY; MANAGEMENT OF CAPITAL INVESTMENT FUNDS IN THE AREA OF LIFE SCIENCES AND HEALTHCARE TECHNOLOGY (U.S. CLS. 100, 101 AND 102).

STANLEY I. OSBORNE, EXAMINING ATTORNEY

SN 78-709,466. LITTLEBOY, JOHN FREDERICK F'ANSON, PALO ALTO, CA. FILED 9-8-2005.

inky-dinky

THE MARK CONSISTS OF STANDARD CHARACTERS WITHOUT CLAIM TO ANY PARTICULAR FONT, STYLE, SIZE, OR COLOR.

CLASS 21—HOUSEWARES AND GLASS

FOR DINNERWARE, NAMELY, PLATES, CUPS AND SAUCERS; DISHES AND PLATES; PAPER PLATES; PLASTIC CUPS; PLATES (U.S. CLS. 2, 13, 23, 29, 30, 33, 40 AND 50).

FIRST USE 5-17-2005; IN COMMERCE 5-30-2005.

CLASS 24—FABRICS

FOR PLASTIC PLACE MATS (U.S. CLS. 42 AND 50).

FIRST USE 10-23-2003; IN COMMERCE 12-4-2003.

ALAIN LAPTER, EXAMINING ATTORNEY

SN 78-709,671. J.D. FOOD PRODUCTS CO., LTD., SAMUTSAKORN, THAILAND, FILED 9-9-2005.

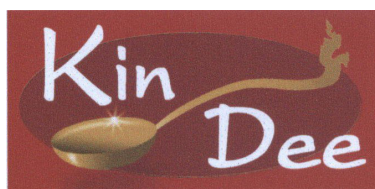

THE COLOR(S) RED, MAROON, GOLD AND WHITE IS/ARE CLAIMED AS A FEATURE OF THE MARK.

THE MARK CONSISTS OF THE WORDS KIN DEE IN THE COLOR WHITE, WITH A GOLD SPOON ON A RED RECTANGLE AND MAROON OVAL BACKGROUND.

THE FOREIGN WORDING IN THE MARK TRANSLATES INTO ENGLISH AS EAT WELL.

CLASS 29—MEATS AND PROCESSED FOODS

FOR INSTANT CURRY SOUPS; INSTANT SOUPS; INSTANT GREEN CURRY SOUP; INSTANT RED CURRY SOUP; NAM YA SOUP; TOM YUM SOUP; TOM KHA SOUP (U.S. CL. 46).

FIRST USE 3-3-2005; IN COMMERCE 3-3-2005.

CLASS 30—STAPLE FOODS

FOR INSTANT RICE NOODLES; INSTANT RICE NOODLES, NAMELY, PAD THAI; INSTANT RICE NOODLES, NAMELY, PAD THAI WITH PEANUTS; INSTANT RICE NOODLES WITH SPICY SEAFOOD FLAVORING; INSTANT FRIED RICE; INSTANT FRIED RICE WITH HOLY BASIL FLAVORING; INSTANT FRIED RICE WITH YELLOW CURRY AND CHICKEN; INSTANT FRIED RICE WITH GREEN CURRY FLAVORING; INSTANT FRIED RICE WITH SHRIMP; SATAY SAUCE; PEANUT SAUCE; SPICES; SEASONINGS; NAM YA CURRY PASTE; RED CURRY PASTE; GREEN CURRY PASTE; YELLOW CURRY PASTE (U.S. CL. 46).

FIRST USE 3-3-2005; IN COMMERCE 3-3-2005.

DOMINIC J. FERRAIUOLO, EXAMINING ATTORNEY

SN 78-711,254. TACO, INC., CRANSTON, RI. FILED 9-12-2005.

X - PUMP BLOCK

THE MARK CONSISTS OF STANDARD CHARACTERS WITHOUT CLAIM TO ANY PARTICULAR FONT, STYLE, SIZE, OR COLOR.

CLASS 9—ELECTRICAL AND SCIENTIFIC APPARATUS

FOR ENVIRONMENTAL CONTROLS FOR USE IN HEATING AND COOLING SYSTEMS, NAMELY, A DEVICE CONTROLLING PIPING, PUMPING AND AIR ELIMINATION FOR USE IN RADIANT HEATING AND COOLING SYSTEMS (U.S. CLS. 21, 23, 26, 36 AND 38).

CLASS 11—ENVIRONMENTAL CONTROL APPARATUS

FOR MACHINERY IN THE FIELD OF HEATING AND COOLING SYSTEMS, NAMELY, A PIPING, PUMPING, AIR ELIMINATION AND CONTROL SYSTEM DEVICE FOR USE IN RADIANT HEATING AND COOLING SYSTEMS; ELECTRICAL APPARATUS IN THE FIELD OF HEATING AND COOLING SYSTEMS, NAMELY, AN ELECTRONICALLY CONTROLLED PIPING, PUMPING, AIR ELIMINATION AND CONTROL SYSTEM DEVICE FOR USE IN RADIANT HEATING AND COOLING SYSTEMS (U.S. CLS. 13, 21, 23, 31 AND 34).
JAMES GRIFFIN, EXAMINING ATTORNEY

CLASS 41—EDUCATION AND ENTERTAINMENT

FOR EDUCATIONAL SERVICES, NAMELY, PROVIDING A WEBSITE FEATURING INTERACTIVE INSTRUCTION IN THE FIELD OF HEALTH CARE AND CHILD BEHAVIOR (U.S. CLS. 100, 101 AND 107).

CLASS 44—MEDICAL, BEAUTY AND AGRICULTURAL SERVICES

FOR PROVIDING A WEBSITE FEATURING INFORMATION IN THE FIELD OF HEALTH CARE AND CHILD PSYCHOLOGY RELATED TO BED-WETTING (U.S. CLS. 100 AND 101).
ELIZABETH J. WINTER, EXAMINING ATTORNEY

SN 78-711,332. BEECH-NUT NUTRITION CORPORATION, ST. LOUIS, MO. FILED 9-12-2005.

BEECH-NUT

THE MARK CONSISTS OF STANDARD CHARACTERS WITHOUT CLAIM TO ANY PARTICULAR FONT, STYLE, SIZE, OR COLOR.
OWNER OF U.S. REG. NOS. 2,210,983, 2,296,459 AND OTHERS.

CLASS 8—HAND TOOLS

FOR CHILDREN'S PLASTIC TABLEWARE, NAMELY, SPOONS AND FORKS (U.S. CLS. 23, 28 AND 44).
FIRST USE 2-28-1998; IN COMMERCE 2-28-1998.

CLASS 10—MEDICAL APPARATUS

FOR BABY BOTTLES (U.S. CLS. 26, 39 AND 44).
FIRST USE 2-28-1998; IN COMMERCE 2-28-1998.

CLASS 21—HOUSEWARES AND GLASS

FOR CHILDREN'S TABLEWARE, NAMELY, PLATES AND CUPS (U.S. CLS. 2, 13, 23, 29, 30, 33, 40 AND 50).
FIRST USE 2-28-1998; IN COMMERCE 2-28-1998.
REBECCA GAN, EXAMINING ATTORNEY

SN 78-712,398. INFLEXION, INC., NEWTON, MA. FILED 9-14-2005.

DRY2NIGHT

THE MARK CONSISTS OF STANDARD CHARACTERS WITHOUT CLAIM TO ANY PARTICULAR FONT, STYLE, SIZE, OR COLOR.

SN 78-712,506. TAKE-TWO INTERACTIVE SOFTWARE, INC., NEW YORK, NY. FILED 9-14-2005.

BIGS

THE MARK CONSISTS OF STANDARD CHARACTERS WITHOUT CLAIM TO ANY PARTICULAR FONT, STYLE, SIZE, OR COLOR.

CLASS 9—ELECTRICAL AND SCIENTIFIC APPARATUS

FOR COMPUTER GAME PROGRAMS; COMPUTER GAME SOFTWARE AND COMPUTER GAME CARTRIDGES (U.S. CLS. 21, 23, 26, 36 AND 38).

CLASS 41—EDUCATION AND ENTERTAINMENT

FOR PROVIDING COMPUTER GAMES PLAYED THROUGH A GLOBAL COMPUTER NETWORK (U.S. CLS. 100, 101 AND 107).
DAVID TAYLOR, EXAMINING ATTORNEY

SN 78-712,519. MCKENZIE OIL COMPANY, INC., EUFAULA, AL. FILED 9-14-2005.

SN 78-713,360. GREYSTONE HOME COLLECTION, L.L.C., NEW YORK, NY. FILED 9-15-2005.



NO CLAIM IS MADE TO THE EXCLUSIVE RIGHT TO USE "CLEAN", APART FROM THE MARK AS SHOWN.

THE COLOR(S) RED, GREEN AND BLUE IS/ARE CLAIMED AS A FEATURE OF THE MARK.

THE COLOR RED APPEARS ON THE CURVED DESIGN; THE COLOR GREEN APPEARS ON THE WORD GO; THE COLOR BLUE APPEARS ON THE WORD CLEAN.

CLASS 35—ADVERTISING AND BUSINESS

FOR RETAIL STORE SERVICES FEATURING CONVENIENCE STORE ITEMS AND GASOLINE (U.S. CLS. 100, 101 AND 102).

CLASS 37—CONSTRUCTION AND REPAIR

FOR CAR WASHING SERVICES (U.S. CLS. 100, 103 AND 106).

ANDREA SAUNDERS, EXAMINING ATTORNEY

SN 78-713,284. INTEGRATED BIOSCIENCES, INC., DBA INTEGRATED BIOSCIENCES, LEWISBERRY, PA. FILED 9-15-2005.

Where outsourcing comes
full circle

THE MARK CONSISTS OF STANDARD CHARACTERS WITHOUT CLAIM TO ANY PARTICULAR FONT, STYLE, SIZE, OR COLOR.

CLASS 40—MATERIAL TREATMENT

FOR CUSTOM MANUFACTURE OF MEDICAL DEVICES AND RELATED SERVICES, NAMELY, MOLDING, ASSEMBLY AND STERILIZATION OF MEDICAL DEVICES (U.S. CLS. 100, 103 AND 106).

FIRST USE 1-31-2004; IN COMMERCE 1-31-2004.

CLASS 42—SCIENTIFIC, COMPUTER AND LEGAL SERVICES

FOR PRODUCT DESIGN, PRODUCT PROTOTYPING, AND QUALITY CONTROL SERVICES OF CUSTOM MANUFACTURED MEDICAL DEVICES (U.S. CLS. 100 AND 101).

FIRST USE 1-31-2004; IN COMMERCE 1-31-2004.
JENNY PARK, EXAMINING ATTORNEY

GREYSTONE HOME COLLECTION

THE MARK CONSISTS OF STANDARD CHARACTERS WITHOUT CLAIM TO ANY PARTICULAR FONT, STYLE, SIZE, OR COLOR.

NO CLAIM IS MADE TO THE EXCLUSIVE RIGHT TO USE "HOME COLLECTION", APART FROM THE MARK AS SHOWN.

CLASS 11—ENVIRONMENTAL CONTROL APPARATUS

FOR LIGHTING FIXTURES, NAMELY LAMPS, LAMP SHADES, CHANDELIERS AND SCONCES (U.S. CLS. 13, 21, 23, 31 AND 34).

FIRST USE 10-1-2003; IN COMMERCE 10-1-2003.

CLASS 16—PAPER GOODS AND PRINTED MATTER

FOR ART, NAMELY PAINTINGS, PHOTOGRAPHS, ARTISTIC PRINTS AND ETCHINGS (U.S. CLS. 2, 5, 22, 23, 29, 37, 38 AND 50).

FIRST USE 10-1-2003; IN COMMERCE 10-1-2003.

CLASS 20—FURNITURE AND ARTICLES NOT OTHERWISE CLASSIFIED

FOR HOME FURNISHINGS, NAMELY MIRRORS, SHELVES, ARMOIRES, DINING ROOM TABLES, CHAIRS, FURNITURE CHESTS, NIGHT STANDS, BEDS, DRESSERS, BUFFETS, END TABLES, SOFAS, COFFEE TABLES, CONSOLE TABLES, BENCHES, GAME TABLES, BAR STOOLS AND DESKS (U.S. CLS. 2, 13, 22, 25, 32 AND 50).

FIRST USE 10-1-2003; IN COMMERCE 10-1-2003.

CLASS 21—HOUSEWARES AND GLASS

FOR GARDEN ACCESSORIES, NAMELY PLANTERS, VASES AND BIRDCAGES (U.S. CLS. 2, 13, 23, 29, 30, 33, 40 AND 50).

FIRST USE 10-1-2003; IN COMMERCE 10-1-2003.

CLASS 24—FABRICS

FOR TEXTILE FABRICS FOR HOME FURNISHINGS, NAMELY UPHOLSTERY FABRICS, FABRICS FOR USE IN THE MANUFACTURE OF DRAPERIES, CURTAINS AND TEXTILE INTERIOR BLINDS (U.S. CLS. 42 AND 50).

FIRST USE 10-1-2003; IN COMMERCE 10-1-2003.

MARIA-VICTORIA SUAREZ, EXAMINING ATTORNEY

SN 78-713,535. FIEGEL ENTERPRISES, LLC, PLANO, TX. FILED 9-15-2005.

TIGERDROPPINGS.COM

THE MARK CONSISTS OF STANDARD CHARACTERS WITHOUT CLAIM TO ANY PARTICULAR FONT, STYLE, SIZE, OR COLOR.

CLASS 35—ADVERTISING AND BUSINESS

FOR PROVIDING ONLINE DIRECTORY INFORMATION SERVICES AND HYPERLINKS TO OTHER WEB SITES; DISSEMINATION OF ADVERTISING FOR OTHERS VIA THE INTERNET; PROVIDING CONSUMER INFORMATION SERVICES AND MAKING REFERRALS IN THE FIELD OF ENTERTAINMENT SERVICES FOR PRODUCTS, SERVICES, EVENTS, ACTIVITIES, SPORTS, ATTRACTIONS AND FACILITIES IN PARTICULAR GEOGRAPHIC LOCATIONS; ONLINE RETAIL STORE SERVICES FEATURING SPORTS MEMORABILIA AND CLOTHING (U.S. CLS. 100, 101 AND 102).

FIRST USE 8-13-2001; IN COMMERCE 8-13-2001.

CLASS 38—COMMUNICATION

FOR PROVIDING ONLINE ELECTRONIC MESSAGE BOARDS FOR TRANSMISSION OF MESSAGES AMONG USERS CONCERNING SPORTS, POLITICS, EVENTS, SPORTING AND CULTURAL ACTIVITIES AND GENERAL INTERESTS (U.S. CLS. 100, 101 AND 104).

FIRST USE 8-13-2001; IN COMMERCE 8-13-2001.
MARC LEIPZIG, EXAMINING ATTORNEY

CLASS 31—NATURAL AGRICULTURAL PRODUCTS

FOR HERBAL LICKS FOR EQUINES; EQUINE HERBAL FEED BLOCKS; HERBAL EQUINE FEED; ANIMAL FEED; EQUINE FEED; BEET LICKS FOR EQUINES; SALT LICKS FOR EQUINES; EQUINE FEED BLOCKS (U.S. CLS. 1 AND 46).

FIRST USE 4-30-2004; IN COMMERCE 4-30-2004.
SONYA STEPHENS, EXAMINING ATTORNEY

SN 78-713,723. GROUPE DYNAMITE INC., MONT-ROYAL, QUEBEC, CANADA, FILED 9-15-2005.

SN 78-713,636. EQUIGLOBAL USA LIMITED, EAST KINGSTON, NH. FILED 9-15-2005.



THE COLOR(S) RED, WHITE, LIGHT BLUE AND DARK BLUE IS/ARE CLAIMED AS A FEATURE OF THE MARK.

THE MARK CONSISTS OF A DARK BLUE GALLOPING HORSE ON TOP OF A LIGHT BLUE GLOBE OUTLINED IN DARK BLUE AND CONTAINING THE CONTINENTS OF NORTH AND SOUTH AMERICA IN DARK BLUE SUPERIMPOSED ON A FLAG CONSISTING OF FIVE ALTERNATING RED AND BLUE HORIZONTAL STRIPES AND A DARK BLUE SQUARE CONTAINING THREE LARGE WHITE STARS WITH FIVE POINTS.

CLASS 5—PHARMACEUTICALS

FOR NATURAL REMEDIES FOR ANIMALS, NAMELY, NATURAL ANIMAL FEED ADDITIVE FOR USE AS NUTRITIONAL SUPPLEMENT FOR MEDICAL PURPOSES; FOOD ADDITIVES FOR ANIMALS, NAMELY, FEED SUPPLEMENTS FOR EQUINES; HERBAL ADDITIVES FOR ANIMALS, NAMELY NUTRITIONAL HERBAL ADDITIVES TO FOODSTUFFS FOR ANIMALS FOR MEDICAL PURPOSES; HERBAL FOOD SUPPLEMENTS FOR ANIMALS, NAMELY, HERBAL DIETARY SUPPLEMENTS FOR ANIMALS; HERBAL EQUINE FEED SUPPLEMENTS; ANIMAL FEED SUPPLEMENTS; EQUINE FEED SUPPLEMENTS (U.S. CLS. 6, 18, 44, 46, 51 AND 52).

FIRST USE 4-30-2004; IN COMMERCE 4-30-2004.

DYNAMITE

THE MARK CONSISTS OF STANDARD CHARACTERS WITHOUT CLAIM TO ANY PARTICULAR FONT, STYLE, SIZE, OR COLOR.

OWNER OF CANADA REG. NO. TMA653615, DATED 11-25-2005, EXPIRES 11-25-2020.

CLASS 25—CLOTHING

FOR SUITS; BLAZERS; PANTS, NAMELY, DRESSY PANTS, CASUAL PANTS, COTTON PANTS, DENIM PANTS, SUEDE PANTS, LEATHER PANTS, CAPRI PANTS, STIRRUP PANTS; SHORTS, NAMELY, DENIM SHORTS, CASUAL SHORTS, DRESSY SHORTS, SUEDE SHORTS, LEATHER SHORTS, SHORT-SKIRT COMBINATIONS; SKIRTS, NAMELY, DENIM SKIRTS, CASUAL SKIRTS, DRESSY SKIRTS, SUEDE SKIRTS, LEATHER SKIRTS; BLOUSES, NAMELY, DENIM BLOUSES, CASUAL BLOUSES, DRESSY BLOUSES; JACKETS, NAMELY, CASUAL JACKETS, DRESSY JACKETS, DENIM JACKETS, SUEDE JACKETS, LEATHER JACKETS; VESTS, NAMELY, CASUAL VESTS, DRESSY VESTS, SUEDE VESTS, LEATHER VESTS, DENIM VESTS; LIGHTER WEIGHT ACTIVE WEAR, NAMELY, JACKETS, TOPS, SHORTS, SKIRTS, SHORT-SKIRT COMBINATIONS, PANTS; DRESSES, NAMELY, CASUAL DRESSES, DRESSY DRESSES, DENIM DRESSES, SUNDRESSES; OUTERWEAR, NAMELY, COATS; TOPS, NAMELY, DRESSY TOPS, CASUAL TOPS; SWEAT-SUITS; SWEATSHIRTS; SWEATPANTS; SLEEPWEAR; SWIMWEAR; OVERALLS; JUMPERS; SWEATERS; LINGERIE, NAMELY, BRASSIERES, PANTIES; SCARVES; NECKERCHIEFS; HOSIERY; SOCKS (U.S. CLS. 22 AND 39).

CLASS 35—ADVERTISING AND BUSINESS

FOR RETAIL STORES FEATURING CLOTHING, FOOTWEAR, FASHION ACCESSORIES, LEATHER APPAREL, LUGGAGE, HANDBAGS, WALLET, AND HOME DECORATION ACCESSORIES (U.S. CLS. 100, 101 AND 102).

FRED MANDIR, EXAMINING ATTORNEY

SN 78-713,746. BOWTIE, INC., IRVINE, CA. FILED 9-15-2005.

SN 78-713,944. TRI-AMAZON DISTRIBUTING INC., WHITBY, ONTARIO, CANADA, FILED 9-15-2005.

AUSTRALIAN SHEPHERDS

THE MARK CONSISTS OF STANDARD CHARACTERS WITHOUT CLAIM TO ANY PARTICULAR FONT, STYLE, SIZE, OR COLOR.

OWNER OF U.S. REG. NOS. 2,835,579 AND 2,870,733. SEC. 2(F).

CLASS 16—PAPER GOODS AND PRINTED MATTER

FOR PRINTED PUBLICATIONS, NAMELY, MAGAZINES AND PERIODICALS IN THE FIELD OF ANIMALS, PETS AND FEATURES OF GENERAL INTEREST TO ANIMAL AND PET OWNERS (U.S. CLS. 2, 5, 22, 23, 29, 37, 38 AND 50).

FIRST USE 11-0-2000; IN COMMERCE 11-0-2000.

CLASS 44—MEDICAL, BEAUTY AND AGRICULTURAL SERVICES

FOR COMPUTER SERVICES, NAMELY, PROVIDING ONLINE INFORMATION IN THE FIELD OF ANIMALS AND PETS RELATING TO BREEDING, SELECTION, CARE, HEALTH, FEEDING AND GROOMING (U.S. CLS. 100 AND 101).

FIRST USE 1-0-2001; IN COMMERCE 1-0-2001. SANI KHOURI, EXAMINING ATTORNEY

SN 78-713,896. ERNEST, JAMISON, NEW YORK, NY. FILED 9-15-2005.

YELLOW FEVER

THE MARK CONSISTS OF STANDARD CHARACTERS WITHOUT CLAIM TO ANY PARTICULAR FONT, STYLE, SIZE, OR COLOR.

OWNER OF U.S. REG. NOS. 2,856,048 AND 2,961,075.

CLASS 10—MEDICAL APPARATUS

FOR ADULT SEXUAL AIDS AND TOYS, NAMELY ARTIFICIAL PENISES, VIBRATORS, INFLATABLE LIFE-SIZED DOLLS (U.S. CLS. 26, 39 AND 44).

CLASS 18—LEATHER GOODS

FOR BONDAGE TOOLS, NAMELY, WHIPS (U.S. CLS. 1, 2, 3, 22 AND 41).

TANYA AMOS, EXAMINING ATTORNEY

BETTER THAN SUGAR

THE MARK CONSISTS OF STANDARD CHARACTERS WITHOUT CLAIM TO ANY PARTICULAR FONT, STYLE, SIZE, OR COLOR.

OWNER OF CANADA REG. NO. TMA615065, DATED 7-16-2004, EXPIRES 7-16-2015.

CLASS 5—PHARMACEUTICALS

FOR FOOD SUPPLEMENTS, NAMELY STEVIA POWDER BLENDS AS AN INGREDIENT WITHIN OR AS A STAND-ALONE DIETARY SUPPLEMENT; HOT AND COLD CHOCOLATE DRINK POWDER SUPPLEMENTS; DIABETIC CHOCOLATE BARS; VITAMINS (U.S. CLS. 6, 18, 44, 46, 51 AND 52).

CLASS 30—STAPLE FOODS

FOR ICE CREAM; CHEWING GUM; STEVIA POWDER BLENDS FOR USE AS AN ADDITIVE FOR NON-NUTRITIONAL PURPOSES FOR USE AS A FLAVORING IN HOT AND COLD CHOCOLATE DRINK POWDER SUPPLEMENTS, ICE CREAM, DIABETIC CHOCOLATE BARS, SPORTS DRINK POWDER BLENDS, FLAVOURED CRYSTALS FOR BEVERAGES, GUM AND VITAMINS (U.S. CL. 46).

CLASS 32—LIGHT BEVERAGES

FOR SPORTS DRINK POWDER BLENDS, FLAVORED CRYSTALS FOR BEVERAGES (U.S. CLS. 45, 46 AND 48). KATHERINE M. DUBRAY, EXAMINING ATTORNEY

SN 78-714,051. EON ENTERPRISES, INC., DENVER, CO. FILED 9-15-2005.



NO CLAIM IS MADE TO THE EXCLUSIVE RIGHT TO USE "OFFICE", APART FROM THE MARK AS SHOWN.

"THE COLOR(S) MAROON, AQUA AND WHITE IS/ARE CLAIMED AS A FEATURE OF THE MARK."

"THE MARK CONSISTS OF A RECTANGULAR BACKGROUND THAT HAS BEEN DIVIDED ONCE INTO TWO HALVES. THE TOP HALF IS WHITE AND THE BOTTOM HALF IS AQUA. THE TERM "EON" APPEARS IN THE CENTER OF THE TWO DIVIDED HALVES IN LARGE STYLIZED MAROON-COLORED LETTERS AND THE WORDING "TODAY'S OFFICE" APPEARS BENEATH THE WORDING "EON" IN WHITE STYLIZED LETTERS."

CLASS 35—ADVERTISING AND BUSINESS

FOR RETAIL DISTRIBUTORSHIP SERVICES IN THE FIELD OF OFFICE AND BUSINESS SUPPLIES PROVIDED TO COMMERCIAL CUSTOMERS; ON-LINE RETAIL STORE SERVICES PROVIDED TO COMMERCIAL CUSTOMERS FEATURING OFFICE PRODUCTS AND OFFICE SUPPLIES, PAPER GOODS, ART SUPPLIES, BUSINESS MACHINES, OFFICE ELECTRONICS, BUSINESS FURNITURE AND INTERIOR FURNITURE, COMPUTERS, COMPUTER ACCESSORIES, JANITORIAL AND CLEANING EQUIPMENT AND SUPPLIES, BUSINESS PRINTING SUPPLIES IN THE NATURE OF PAPER, TONER, STAPLES, LETTERHEAD, BUSINESS FORMS AND COMPUTER SOFTWARE; PREPARING PROMOTIONAL MATERIAL FOR OTHERS (U.S. CLS. 100, 101 AND 102).

FIRST USE 6-30-2005; IN COMMERCE 6-30-2005.

CLASS 37—CONSTRUCTION AND REPAIR

FOR INSTALLATION, REPAIR AND MAINTENANCE SERVICES, NAMELY INSTALLATION, REPAIR AND MAINTENANCE OF BUSINESS AND OFFICE EQUIPMENT AND FURNITURE (U.S. CLS. 100, 103 AND 106).

FIRST USE 6-30-2005; IN COMMERCE 6-30-2005.

CLASS 39—TRANSPORTATION AND STORAGE

FOR WAREHOUSING SERVICES, NAMELY, STORAGE, DISTRIBUTION, PICK-UP AND PACKING FOR SHIPMENT OF DOCUMENTS, PACKAGES, OFFICE SUPPLIES, OFFICE FURNITURE, AND OTHER FREIGHT FOR OTHERS (U.S. CLS. 100 AND 105).

FIRST USE 6-30-2005; IN COMMERCE 6-30-2005.

CLASS 40—MATERIAL TREATMENT

FOR COMMERCIAL PRINTING SERVICES (U.S. CLS. 100, 103 AND 106).

FIRST USE 6-30-2005; IN COMMERCE 6-30-2005.

CLASS 43—HOTEL AND RESTAURANT SERVICES

FOR COFFEE SUPPLY SERVICES FOR OFFICES (U.S. CLS. 100 AND 101).

FIRST USE 6-30-2005; IN COMMERCE 6-30-2005.
SONYA STEPHENS, EXAMINING ATTORNEY

SN 78-714,084. VERACITY PROGRAMS, INC., OVERLAND PARK, KS. FILED 9-15-2005.

VERACITY ADVANCED
SUBSTANCE ABUSE PROGRAMS

THE MARK CONSISTS OF STANDARD CHARACTERS WITHOUT CLAIM TO ANY PARTICULAR FONT, STYLE, SIZE, OR COLOR.

NO CLAIM IS MADE TO THE EXCLUSIVE RIGHT TO USE "ADVANCED SUBSTANCE ABUSE PROGRAMS", APART FROM THE MARK AS SHOWN.

CLASS 35—ADVERTISING AND BUSINESS

FOR SUBSTANCE ABUSE PROGRAM MANAGEMENT SERVICES, NAMELY BUSINESS ADMINISTRATION AND MANAGEMENT (U.S. CLS. 100, 101 AND 102).

FIRST USE 9-23-2004; IN COMMERCE 9-23-2004.

CLASS 44—MEDICAL, BEAUTY AND AGRICULTURAL SERVICES

FOR PROVIDING DRUG TESTING FOR SUBSTANCE ABUSE (U.S. CLS. 100 AND 101).

FIRST USE 9-23-2004; IN COMMERCE 9-23-2004.
ANDREA EVANS, EXAMINING ATTORNEY

SN 78-714,203. THE RONALD REAGAN PRESIDENTIAL LIBRARY FOUNDATION, SIMI VALLEY, CA. FILED 9-15-2005.



NO CLAIM IS MADE TO THE EXCLUSIVE RIGHT TO USE "PUB", APART FROM THE MARK AS SHOWN.

THE NAME(S), PORTRAIT(S), AND/OR SIGNATURE(S) SHOWN IN THE MARK IDENTIFIES RONALD REAGAN, WHOSE CONSENT(S) TO REGISTER IS SUBMITTED.

THE MARK CONSISTS OF THE WORDS "THE RONALD REAGAN" IN STYLIZED FORM OVER A SHIELD WITH A HERALDRIC-LIKE DESIGN, WITH THE WORD "REAGAN" JUST UNDER THE DESIGN AND THE WORD "PUB" AT THE BOTTOM.

CLASS 25—CLOTHING

FOR HATS (U.S. CLS. 22 AND 39).

CLASS 43—HOTEL AND RESTAURANT SERVICES

FOR PUB (U.S. CLS. 100 AND 101).
KAELIE KUNG, EXAMINING ATTORNEY

SN 78-714,508. CARROL BOYES CORPORATION, NEW YORK, NY. FILED 9-16-2005.



CaRRoL BoYeS

THE NAME CARROL BOYES IDENTIFIES A LIVING INDIVIDUAL WHOSE CONSENT IS OF RECORD.

CLASS 8—HAND TOOLS

FOR TABLEWARE, NAMELY, FORKS, KNIVES AND SPOONS (U.S. CLS. 23, 28 AND 44).

FIRST USE 8-1-2004; IN COMMERCE 8-1-2004.

CLASS 20—FURNITURE AND ARTICLES NOT OTHERWISE CLASSIFIED

FOR PICTURE FRAMES, NOT OF PRECIOUS METAL, MIRROR FRAMES, TABLES (U.S. CLS. 2, 13, 22, 25, 32 AND 50).

FIRST USE 8-1-2004; IN COMMERCE 8-1-2004.

CLASS 21—HOUSEWARES AND GLASS

FOR CUTTING BOARDS, SERVING PLATTERS, FLOWER VASES AND BOWLS, NOT OF PRECIOUS METALS, EGG CUPS, NOT OF PRECIOUS METALS, TEA POTS, NOT OF PRECIOUS METALS (U.S. CLS. 2, 13, 23, 29, 30, 33, 40 AND 50).

FIRST USE 8-1-2004; IN COMMERCE 8-1-2004.

DOMINIC J. FERRAIUOLO, EXAMINING ATTORNEY

CLASS 18—LEATHER GOODS

FOR CLOTHING FOR ANIMALS; CLOTHING FOR ANIMALS, NAMELY, HATS FOR ANIMALS; ACCESSORIES FOR ANIMALS, NAMELY, PET COLLARS AND ANIMAL LEASHES (U.S. CLS. 1, 2, 3, 22 AND 41).

CLASS 21—HOUSEWARES AND GLASS

FOR BOWLS FOR ANIMALS; DISHES (U.S. CLS. 2, 13, 23, 29, 30, 33, 40 AND 50).

CLASS 28—TOYS AND SPORTING GOODS

FOR TOYS FOR ANIMALS, NAMELY, PET TOYS; YOGA MATS; GOLF FLAGS; EXERCISE AND GYMNASIAC BANNERS (U.S. CLS. 22, 23, 38 AND 50).

NELSON SNYDER, EXAMINING ATTORNEY

SN 78-714,733. MDS FOODS, INC., MASSILLON, OH. FILED 9-16-2005.

SN 78-715,019. MC CONSULTANTS, INC., CARLSBAD, CA. FILED 9-16-2005.

AMISH CLASSICS

THE MARK CONSISTS OF STANDARD CHARACTERS WITHOUT CLAIM TO ANY PARTICULAR FONT, STYLE, SIZE, OR COLOR.

OWNER OF U.S. REG. NO. 2,179,636.

NO CLAIM IS MADE TO THE EXCLUSIVE RIGHT TO USE "AMISH", APART FROM THE MARK AS SHOWN.

OWNER OF U.S. REG. NOS. 2,384,895 AND 2,390,978.

CLASS 29—MEATS AND PROCESSED FOODS

FOR UNPROCESSED, SEMI-PROCESSED AND PROCESSED MEATS, NAMELY DELI MEATS, SMOKED MEATS, POULTRY, ROAST BEEF, PORK, BEEF AND FISH; AND ENTREES CONSISTING PRIMARILY OF MEAT, FISH, POULTRY, VEGETABLES, SALAD OIL, SALADS, DESSERTS, CHEESE SPREADS, MARMALADE, PICKLES AND PROCESSED EGGS (U.S. CL. 46).

FIRST USE 2-28-2005; IN COMMERCE 2-28-2005.

CLASS 30—STAPLE FOODS

FOR COOKIES, CAKES, BREADS, PASTRIES, BROWNIES, DOUGHNUTS, PIES, DESSERTS; PASTA AND ENTREES CONSISTING PRIMARILY OF MACARONI, RICE AND PASTA SALAD; SALAD DRESSINGS, MUSTARD, CATSUP, AND RELISH (U.S. CL. 46).

FIRST USE 2-28-2005; IN COMMERCE 2-28-2005.

KAREN K. BUSH, EXAMINING ATTORNEY

CLASS 36—INSURANCE AND FINANCIAL

FOR FINANCIAL CONSTRUCTION RISK MANAGEMENT AND INSURANCE RISK ASSESSMENT AND MANAGEMENT (U.S. CLS. 100, 101 AND 102).

FIRST USE 10-20-1997; IN COMMERCE 10-20-1997.

CLASS 42—SCIENTIFIC, COMPUTER AND LEGAL SERVICES

FOR POST-CONSTRUCTION FORENSIC ANALYSIS IN THE CONSTRUCTION FIELD, AND PROPERTY DAMAGE ANALYSIS (U.S. CLS. 100 AND 101).

FIRST USE 10-20-1997; IN COMMERCE 10-20-1997.

PAUL E. FAHRENKOPF, EXAMINING ATTORNEY

SN 78-714,872. MUTTLUKS INC., TORONTO, ONTARIO, CANADA, FILED 9-16-2005.

SN 78-715,052. PARKER, ZACHARY T., DBA O.G. RIDER ENTERTAINMENT, SYLMAR, CA. FILED 9-16-2005.

MUTTOPIA

THE MARK CONSISTS OF STANDARD CHARACTERS WITHOUT CLAIM TO ANY PARTICULAR FONT, STYLE, SIZE, OR COLOR.

O.G.RIDER

THE MARK CONSISTS OF STANDARD CHARACTERS WITHOUT CLAIM TO ANY PARTICULAR FONT, STYLE, SIZE, OR COLOR.

NO CLAIM IS MADE TO THE EXCLUSIVE RIGHT TO USE "RIDER", APART FROM THE MARK AS SHOWN.

CLASS 9—ELECTRICAL AND SCIENTIFIC APPARATUS

FOR PRERECORDED VIDEO CASSETTES AND DIGITAL VIDEO DISCS FEATURING AUTOMOBILES DISPLAYED AT CAR SHOWS, STREET COMPETITIONS, AND DANCE COMPETITIONS (U.S. CLS. 21, 23, 26, 36 AND 38).

FIRST USE 0-0-2001; IN COMMERCE 0-0-2001.

CLASS 41—EDUCATION AND ENTERTAINMENT

FOR PRODUCTION OF VIDEO CASSETTES AND DIGITAL VIDEO DISKS FOR OTHERS, NAMELY, PHOTOGRAPHING, COMPILING, AND AUTHORIZING VIDEO CASSETTES AND DIGITAL VIDEO DISKS THAT FEATURE MODIFIED AUTOMOBILES DISPLAYED AT CAR SHOWS, STREET COMPETITIONS AND DANCE COMPETITIONS (U.S. CLS. 100, 101 AND 107).

FIRST USE 0-0-2001; IN COMMERCE 0-0-2001.
TONI HICKEY, EXAMINING ATTORNEY

SN 78-715,653. BOARD OF REGENTS OF THE UNIVERSITY OF NEBRASKA, LINCOLN, NE. FILED 9-19-2005.



OWNER OF U.S. REG. NOS. 2,081,722, 2,735,214 AND OTHERS.

THE MARK CONSISTS OF N AND HUSKERS STYLIZED.

CLASS 25—CLOTHING

FOR ATHLETIC UNIFORMS; BASEBALL CAPS; INFANT AND TODDLER ONE PIECE CLOTHING; JACKETS; SWEAT PANTS; SWEAT SHIRTS; T-SHIRTS (U.S. CLS. 22 AND 39).

FIRST USE 8-0-1983; IN COMMERCE 8-0-1983.

CLASS 41—EDUCATION AND ENTERTAINMENT

FOR EDUCATIONAL RESEARCH; EDUCATIONAL SERVICES, NAMELY, PROVIDING COURSES OF INSTRUCTION AT THE COLLEGE LEVEL; ENTERTAINMENT IN THE NATURE OF COMPETITIONS IN THE FIELD OF ATHLETICS (U.S. CLS. 100, 101 AND 107).

FIRST USE 8-0-1983; IN COMMERCE 8-0-1983.
JESSICA A. POWERS, EXAMINING ATTORNEY

SN 78-715,623. FACTORY FIVE LICENSING, INC., WARHAM, MA. FILED 9-19-2005.

FACTORY FIVE RACING

THE MARK CONSISTS OF STANDARD CHARACTERS WITHOUT CLAIM TO ANY PARTICULAR FONT, STYLE, SIZE, OR COLOR.

NO CLAIM IS MADE TO THE EXCLUSIVE RIGHT TO USE "RACING", APART FROM THE MARK AS SHOWN.

CLASS 12—VEHICLES

FOR USER-ASSEMBLED AUTOMOBILES, NAMELY, KIT CARS (U.S. CLS. 19, 21, 23, 31, 35 AND 44).

FIRST USE 4-1-1996; IN COMMERCE 4-1-1996.

CLASS 25—CLOTHING

FOR MENS AND WOMENS CLOTHING, NAMELY, SHIRTS, CAPS, JACKETS AND VISORS (U.S. CLS. 22 AND 39).

FIRST USE 4-1-1996; IN COMMERCE 4-1-1996.
SEAN CROWLEY, EXAMINING ATTORNEY

SN 78-716,306. HOTEL.DE AG, 90411 NÜRNBERG, FED REP GERMANY, FILED 9-20-2005.

myRES
simply book for less
simple brilliant cheap



NO CLAIM IS MADE TO THE EXCLUSIVE RIGHT TO USE BOOK FOR LESS, SIMPLE, CHEAP, HOTELS IN MOSKAU, DEHLI, NEW YORK, LONDON, BERLIN, KAIRO, AND KAPSTADT, APART FROM THE MARK AS SHOWN.

CLASS 35—ADVERTISING AND BUSINESS

FOR COMPUTERIZED DATA MANAGEMENT FOR OTHERS OF DATA STORED ON A SERVER; MARKET RESEARCH SERVICES AND MARKET RESEARCH STUDIES IN THE FIELD OF INVESTIGATING PRICES FOR GOODS AND SERVICES; COMPUTERIZED INTERNET DATA MANAGEMENT SERVICES AND ELECTRONIC PROCESSING OF ORDERS FOR OTHERS, BOTH IN THE FIELD OF RESERVATION ORDERS REGARDING HOTEL ROOMS AND TRAVEL SERVICES; COMPILATION AND SYSTEMATIZATION OF MULTIMEDIA INFORMATION IN DATABANKS; AUCTIONING VIA TELECOMMUNICATIONS NETWORKS WHERE BIDDING IS DONE OVER THE INTERNET; BUSINESS SERVICES, NAMELY PROVIDING COMPUTER DATABASES REGARDING THE PURCHASE AND SALE OF A WIDE VARIETY OF PRODUCTS AND SERVICES OF OTHERS; ELECTRONIC DATA PROCESSING FOR OTHERS; PROVIDING CUSTOMER SERVICE FOR OTHERS VIA TELEPHONE IN THE FIELD OF TRAVEL RESERVATION PLANNING; BUSINESS MARKETING SERVICES, NAMELY GOODS OR SERVICES PRICE QUOTATIONS; PROVIDING A WEB SITE AT WHICH USERS CAN OFFER COMMERCIAL GOODS FOR SALE AND BUY COMMERCIAL GOODS OFFERED BY OTHERS; ADVERTISING SERVICES FOR OTHERS (U.S. CLS. 100, 101 AND 102).

CLASS 38—COMMUNICATION

FOR PROVIDING ON-LINE COMMUNICATION LINKS WHICH TRANSFER THE WEBSITE USER TO OTHER LOCAL AND GLOBAL WEBPAGES OF OTHERS FOR E-COMMERCE IN THE FIELD OF RESERVATIONS OF GUEST ROOMS AVAILABLE IN PENSIONS AND OTHER GUEST ROOMS; PROVISION OF ACCESS TO ELECTRONIC SITES FOR OTHERS IN THE FIELD OF SITES WITH OFFERS OF AVAILABLE ROOMS ON THE INTERNET (U.S. CLS. 100, 101 AND 104).

CLASS 42—SCIENTIFIC, COMPUTER AND LEGAL SERVICES

FOR COMPUTER PROGRAMMING SERVICES IN DATA NETWORKS FOR OTHERS; DESIGNING INTERNET HOME PAGES, INTERNET WEB SITES, AND SOFTWARE THEREFORE FOR OTHERS; COMPUTER SERVICES, NAMELY CREATING WEB SITES FOR OTHERS; CUSTOM DESIGN OF COMPUTER SOFTWARE FOR OTHERS FOR ADMINISTRATING A MULTIMEDIA DATABANK (U.S. CLS. 100 AND 101).
KALIE KUNG, EXAMINING ATTORNEY

SN 78-716,575. WEST PUBLISHING CORPORATION, EAGAN, MN. FILED 9-20-2005.

TalentMonitor

THE MARK CONSISTS OF STANDARD CHARACTERS WITHOUT CLAIM TO ANY PARTICULAR FONT, STYLE, SIZE, OR COLOR.

CLASS 35—ADVERTISING AND BUSINESS

FOR PROVIDING INFORMATION TO LAW FIRMS IN THE FIELD OF HUMAN RESOURCES MANAGEMENT REGARDING KEY BENCHMARKS ON LAW FIRM STAFFING, DEPARTMENT STAFFING, SECRETARY-PARTNER RATIOS, SALARY LEVELS, BENEFITS AND PRO BONO ACTIVITIES (U.S. CLS. 100, 101 AND 102).

CLASS 41—EDUCATION AND ENTERTAINMENT

FOR EDUCATIONAL SERVICES, NAMELY, PROVIDING SEMINARS TO LAW FIRM PRINCIPLES IN THE FIELD OF HUMAN RESOURCES MANAGEMENT REGARDING BEST PRACTICES IN DEVELOPING HIGH POTENTIAL LAW FIRM STAFF AND LEGAL TALENT (U.S. CLS. 100, 101 AND 107).
ELIZABETH BEYER, EXAMINING ATTORNEY

SN 78-716,857. OMX, INC., ITASCA, IL. FILED 9-20-2005.

**OFFICEMAX HAVE IT ALL
PLEDGE**

THE MARK CONSISTS OF STANDARD CHARACTERS WITHOUT CLAIM TO ANY PARTICULAR FONT, STYLE, SIZE, OR COLOR.
OWNER OF U.S. REG. NOS. 1,511,330, 2,367,604 AND OTHERS.

CLASS 2—PAINTS

FOR PRINTER INK CARTRIDGES (U.S. CLS. 6, 11 AND 16).

CLASS 9—ELECTRICAL AND SCIENTIFIC APPARATUS

FOR BLANK ELECTRONIC MEDIA, NAMELY BLANK RECORDABLE CDS AND DVDS, COMPUTER ACCESSORIES AND SUPPLIES, NAMELY, MOUSE PADS, COMPUTER MICE, VOLTAGE SURGE PROTECTORS, COMPUTER KEYBOARDS, COMPUTER STANDS FOR HOLDING A COMPUTER AND ACCESSORIES, CALCULATORS, AND EXTENSION CORDS (U.S. CLS. 21, 23, 26, 36 AND 38).
AMY MCMENAMIN, EXAMINING ATTORNEY

SN 78-716,903. JIM O'NEAL DISTRIBUTING, INC., CHATSWORTH, CA. FILED 9-20-2005.

AZONIC

THE MARK CONSISTS OF STANDARD CHARACTERS WITHOUT CLAIM TO ANY PARTICULAR FONT, STYLE, SIZE, OR COLOR.

CLASS 9—ELECTRICAL AND SCIENTIFIC APPARATUS

FOR SUNGLASSES, CASES FOR SUNGLASSES, FRAMES FOR SUNGLASSES, LENSES FOR SUNGLASSES, PROTECTIVE GEAR FOR MOTORCYCLE AND BICYCLE ACCESSORIES, NAMELY, SPORTS GOGGLES, MOTORCYCLE GOGGLES, BICYCLE GOGGLES, AND SKI GOGGLES, PROTECTIVE HELMETS FOR SPORTS, NAMELY, MOTORCYCLE, SKI, SNOWBOARD, AND BICYCLE HELMETS, GLOVES FOR PROTECTION AGAINST ACCIDENTS, MOTORCYCLE AND BICYCLE ACCESSORIES, NAMELY, COURSE SAFETY MARKERS, COMPUTER GAME PROGRAMS; AND MOTORCYCLE AND BICYCLE ACCESSORIES, NAMELY, HELMET BAGS (U.S. CLS. 21, 23, 26, 36 AND 38).

FIRST USE 6-1-1996; IN COMMERCE 6-1-1996.

CLASS 12—VEHICLES

FOR BICYCLES AND BICYCLE PARTS, NAMELY, FRAMES, SHOCKS, FORKS, NECKS, HANDLE BARS, TUBES AND CONNECTORS FOR BICYCLE FRAMES, HANDLE BAR ENDS, HANDLE BAR STEMS, RACING NUMBER PLATES, SPROCKETS AND CHAIN RINGS, PEDALS, SADDLES, SEAT POSTS AND SEAT POST CLAMPS, MOTORCYCLE LEVERS, BICYCLE LEVERS AND PERCHES, BICYCLE HANDLEBAR PADS; MOTORCYCLE PARTS AND ACCESSORIES, NAMELY, MOTORCYCLE CLUTCHES, PIT BOARDS, WATER BOTTLE CAGES, WHEELS, HUBS, AXELS, CRANK, BOTTOM BRACKET, HANDLE BAR GRIPS, HEADLOCKS, AND TRIPLE CLAMP BAR MOUNTS (U.S. CLS. 19, 21, 23, 31, 35 AND 44).

FIRST USE 9-1-1994; IN COMMERCE 9-1-1994.

CLASS 16—PAPER GOODS AND PRINTED MATTER

FOR STICKERS, STICKERS FOR BUMPERS, DECORATIVE STICKERS FOR HELMETS (U.S. CLS. 2, 5, 22, 23, 29, 37, 38 AND 50).

FIRST USE 3-1-1991; IN COMMERCE 3-1-1991.

CLASS 18—LEATHER GOODS

FOR MOTORCYCLE AND BICYCLE ACCESSORIES, NAMELY, TRAVEL BAGS, BELT BAGS, AND SPORTS BAGS, BACKPACKS; RUCKSACKS; SMALL BACKPACKS; UMBRELLAS; AND WALLETS (U.S. CLS. 1, 2, 3, 22 AND 41).

FIRST USE 3-1-1991; IN COMMERCE 12-1-1991.

CLASS 21—HOUSEWARES AND GLASS

FOR MOTORCYCLE AND BICYCLE ACCESSORIES, NAMELY, PLASTIC WATER BOTTLES SOLD EMPTY AND BACKPACK WATER CANTEENS (U.S. CLS. 2, 13, 23, 29, 30, 33, 40 AND 50).

FIRST USE 9-1-1991; IN COMMERCE 12-9-1991.

CLASS 25—CLOTHING

FOR MOTORCYCLE AND BICYCLE ACCESSORIES, NAMELY, PANTS, JERSEYS, JACKETS, BOOTS AND SHOES, RAIN SUITS, GLOVES, UNDERGARMENTS, SOCKS, BELTS; CASUAL CLOTHING, NAMELY, SHORT SLEEVED AND LONG SLEEVED T-SHIRTS, SHORTS, SHIRTS, TANK TOPS, SWEAT PANTS, SWEAT SHIRTS, PANTS, JACKETS, HATS, NAMELY, BASEBALL CAPS AND BEANIES AND WET SUITS (U.S. CLS. 22 AND 39).

FIRST USE 3-1-1991; IN COMMERCE 9-1-1991.

CLASS 28—TOYS AND SPORTING GOODS

FOR PROTECTIVE PADDING AND GEAR FOR MOTORCYCLE AND BICYCLES, NAMELY, KIDNEY BELTS, SOCKS, CHEST PROTECTORS, KNEE PROTECTOR, SHIN PROTECTOR, ELBOW GUARDS, AND HANDLE GRIPS (U.S. CLS. 22, 23, 38 AND 50).

FIRST USE 9-1-1991; IN COMMERCE 12-1-1991.

MARIAM MAHMOUDI, EXAMINING ATTORNEY

SN 78-717,331. WISCONSIN ALUMNI RESEARCH FOUNDATION, MADISON, WI. FILED 9-21-2005.

TCI

THE MARK CONSISTS OF STANDARD CHARACTERS WITHOUT CLAIM TO ANY PARTICULAR FONT, STYLE, SIZE, OR COLOR.

CLASS 9—ELECTRICAL AND SCIENTIFIC APPARATUS

FOR COMPUTER SOFTWARE FEATURING MATHEMATICAL ALGORITHMS AND INDICES FOR USE IN ANALYZING AND EVALUATING DAIRY COW HEALTH AND PRODUCTIVITY (U.S. CLS. 21, 23, 26, 36 AND 38).

FIRST USE 10-2-2005; IN COMMERCE 2-3-2006.

CLASS 42—SCIENTIFIC, COMPUTER AND LEGAL SERVICES

FOR MATHEMATICAL ANALYSIS OF DAIRY COW HEALTH AND PRODUCTIVITY (U.S. CLS. 100 AND 101).

FIRST USE 10-2-2005; IN COMMERCE 2-3-2006.

TIMOTHY FINNEGAN, EXAMINING ATTORNEY

SN 78-717,632. ALLSUP, INC., BELLEVILLE, IL. FILED 9-21-2005.

ALLSUPCARE

THE MARK CONSISTS OF STANDARD CHARACTERS WITHOUT CLAIM TO ANY PARTICULAR FONT, STYLE, SIZE, OR COLOR.

OWNER OF U.S. REG. NOS. 1,731,614 AND 2,899,795.

CLASS 36—INSURANCE AND FINANCIAL

FOR SOCIAL SECURITY AND MEDICARE CLAIMS ADMINISTRATION AND CONSULTING SERVICES RENDERED TO INSURERS, FINANCIAL INSTITUTIONS, AND INDIVIDUALS; PROVIDING INFORMATION IN THE FIELD OF DISABILITY INSURANCE BENEFITS; INSURANCE CLAIMS CONSULTATION; PROVIDING INFORMATION ON INSURANCE MATTERS; FINANCIAL AND INVESTMENT CONSULTATION; FINANCIAL LOANS CONSULTATION (U.S. CLS. 100, 101 AND 102).

CLASS 44—MEDICAL, BEAUTY AND AGRICULTURAL SERVICES

FOR PROVIDING INFORMATION ABOUT DISCOUNT MEDICAL SERVICES AND PHARMACEUTICAL CONSULTATION (U.S. CLS. 100 AND 101).

MICHAEL KAZAZIAN, EXAMINING ATTORNEY

SN 78-718,329. KOHL'S ILLINOIS, INC., AURORA, IL. FILED 9-22-2005.

APT. 9

THE MARK CONSISTS OF STANDARD CHARACTERS WITHOUT CLAIM TO ANY PARTICULAR FONT, STYLE, SIZE, OR COLOR.

OWNER OF U.S. REG. NO. 2,972,150.

CLASS 6—METAL GOODS

FOR DECORATIVE SCULPTURES OF METAL (U.S. CLS. 2, 12, 13, 14, 23, 25 AND 50).

CLASS 20—FURNITURE AND ARTICLES NOT OTHERWISE CLASSIFIED

FOR DECORATIVE SCULPTURES OF PLASTIC; DECORATIVE SCULPTURES OF WOOD; HAMPERS; WINE-RACKS (U.S. CLS. 2, 13, 22, 25, 32 AND 50).

CLASS 21—HOUSEWARES AND GLASS

FOR DECORATIVE SCULPTURES OF CERAMIC; STORAGE BASKETS OF WICKER AND WOOD (U.S. CLS. 2, 13, 23, 29, 30, 33, 40 AND 50).

CLASS 27—FLOOR COVERINGS

FOR NON-TEXTILE DECORATIVE WALL HANGINGS (U.S. CLS. 19, 20, 37, 42 AND 50).

MYRIAH HABEEB, EXAMINING ATTORNEY

SN 78-719,127. ARKEMA, 92800 PUTEAUX, FRANCE, FILED 9-23-2005.



PRIORITY CLAIMED UNDER SEC. 44(D) ON FRANCE APPLICATION NO. 053350480, FILED 4-4-2005, REG. NO. 053350480, DATED 4-4-2005, EXPIRES 4-4-2015.

THE COLOR(S) GREEN AND BLACK IS/ARE CLAIMED AS A FEATURE OF THE MARK.

THE MARK IS IN THE COLOR GREEN, EXCEPT FOR THE BORDER IN THE CENTER, WHICH IS BLACK.

THE MARK CONSISTS OF A STYLIZED REPRESENTATION OF A LEAF.

CLASS 1—CHEMICALS

FOR CHEMICALS USED IN INDUSTRY; UNPROCESSED PLASTICS; POLYMERS USED FOR THE FILTRATION OF LIQUIDS AND IN THE MANUFACTURE OF COSMETICS; POLYMERS USED IN THE FORM OF POWDER, MELTED BY LASER SINTERING, FOR THE CREATION OF PROTOTYPES MAINLY FOR AUTOMOBILE, AEROSPACE AND BUILDING INDUSTRY (U.S. CLS. 1, 5, 6, 10, 26 AND 46).

CLASS 2—PAINTS

FOR PLASTIC COATINGS AND PAINTS FOR SURFACE PROTECTION AND METAL COVERING FOR HEALTHCARE, FLUIDS, APPLIANCES, TEXTILE, BUILDING AND AUTOMOBILE INDUSTRY; ANTI-RUST AND ANTI-CORROSION COATINGS AND PAINTS USED IN HEALTHCARE, BUILDING AND AUTOMOBILE INDUSTRY; ANTI BACTERIAL TREATED AND FIREPROOF COATINGS FOR HEALTHCARE AND TRANSPORT INDUSTRIES; PROTECTIVE COVERINGS IN POWDER FORM USED FOR SURFACE COVERING AND METAL PROTECTION (U.S. CLS. 6, 11 AND 16).

CLASS 17—RUBBER GOODS

FOR SEMI-FINISHED ACRYLIC MOLDED PLASTIC SUBSTANCES AND POLYAMIDE THERMOPLASTIC FORMULATED POWDER FOR COATING PARTS (U.S. CLS. 1, 5, 12, 13, 35 AND 50).

DOMINIC J. FERRAIUOLO, EXAMINING ATTORNEY

SN 78-719,175. PLANET HOLLYWOOD (REGION IV), INC., ORLANDO, FL. FILED 9-23-2005.

PLANET HOLLYWOOD RESORT & CASINO

THE MARK CONSISTS OF STANDARD CHARACTERS WITHOUT CLAIM TO ANY PARTICULAR FONT, STYLE, SIZE, OR COLOR.

OWNER OF U.S. REG. NOS. 1,776,944 AND 1,890,377.

NO CLAIM IS MADE TO THE EXCLUSIVE RIGHT TO USE "RESORT & CASINO", APART FROM THE MARK AS SHOWN.

CLASS 9—ELECTRICAL AND SCIENTIFIC APPARATUS

FOR (BASED ON INTENT TO USE) GAMING DEVICES, NAMELY SLOT MACHINES WITH OR WITHOUT VIDEO OUTPUT (U.S. CLS. 21, 23, 26, 36 AND 38).

CLASS 25—CLOTHING

FOR (BASED ON INTENT TO USE) CLOTHING, NAMELY T-SHIRTS, SHIRTS, SWEATSHIRTS, POLO SHIRTS, SPORT SHIRTS, SHORTS, JACKETS, CAPS (U.S. CLS. 22 AND 39).

CLASS 28—TOYS AND SPORTING GOODS

FOR (BASED ON INTENT TO USE) GAMING AND CASINO EQUIPMENT, NAMELY POKER CHIPS, GAMING TABLES, PLAYING CARDS (U.S. CLS. 22, 23, 38 AND 50).

CLASS 41—EDUCATION AND ENTERTAINMENT

FOR (BASED ON USE IN COMMERCE) CASINO ENTERTAINMENT SERVICES (U.S. CLS. 100, 101 AND 107).

FIRST USE 0-0-2005; IN COMMERCE 0-0-2005.

CLASS 43—HOTEL AND RESTAURANT SERVICES

FOR (BASED ON USE IN COMMERCE) HOTEL, RESTAURANT AND BAR SERVICES (U.S. CLS. 100 AND 101).

FIRST USE 0-0-2005; IN COMMERCE 0-0-2005.
ANNE MADDEN, EXAMINING ATTORNEY

SN 78-719,315. PROMOTORA DE CAFÉ COLOMBIA S.A. PROCAFECOL S.A., BOGOTA, D.C., COLOMBIA, FILED 9-23-2005.



NO CLAIM IS MADE TO THE EXCLUSIVE RIGHT TO USE "LATTE", APART FROM THE MARK AS SHOWN. THE WORD "CORAZON" TRANSLATES TO "HEART".

CLASS 29—MEATS AND PROCESSED FOODS

FOR MILK BASED BEVERAGES CONTAINING FRUIT JUICE AND MILK BASED BEVERAGES CONTAINING COFFEE (U.S. CL. 46).

CLASS 30—STAPLE FOODS

FOR COFFEE, COFFEE SUBSTITUTES; COFFEE-BASED BEVERAGES, COCOA-BASED BEVERAGES AND CHOCOLATE-BASED BEVERAGES NOT BEING DAIRY-BASED OR VEGETABLE BASED (U.S. CL. 46).
ANDREA K. NADELMAN, EXAMINING ATTORNEY

SN 78-719,415. EG PARTNERS, LTD, NACOGUCHES, TX. FILED 9-23-2005.



NO CLAIM IS MADE TO THE EXCLUSIVE RIGHT TO USE BUSINESS, APART FROM THE MARK AS SHOWN.

"THE COLOR(S) BLUE, YELLOW, BLACK, WHITE AND RED IS/ARE CLAIMED AS A FEATURE OF THE MARK."

THE COLOR BLUE APPEARS IN THE OUTLINE OF THE NUMERAL "7,000,000." THE COLOR YELLOW APPEARS IN THE DESIGN OF THE CROWN, THE COLOR BLACK APPEARS IN THE OUTLINE OF THE MARK AND THE TERM "FIGURE." THE COLOR WHITE APPEARS IN THE NUMERAL "7,000,000." THE COLOR RED APPEARS IN THE TERM "BUSINESS."

CLASS 9—ELECTRICAL AND SCIENTIFIC APPARATUS

FOR PRERECORDED AUDIO AND VIDEO CASSETTES TAPES, CD-ROMS, MAGNETIC TAPES AND OPTICAL DISKS FEATURING LECTURES OR SPOKEN WORD IN THE FIELDS OF BUSINESS DEVELOPMENT, SALES IMPROVEMENT, COMMUNICATION SKILLS, DOCTOR/PATIENT RELATIONSHIPS, MOTIVATION, CUSTOMER SERVICE, SELF-IMPROVEMENT, BUSINESS MANAGEMENT, LEADERSHIP TRAINING, PERSONAL AND PROFESSIONAL INSPIRATION AND ACHIEVEMENT AND DEVELOPING SELF-ESTEEM (U.S. CLS. 21, 23, 26, 36 AND 38).

FIRST USE 2-1-2005; IN COMMERCE 2-1-2005.

CLASS 41—EDUCATION AND ENTERTAINMENT

FOR EDUCATIONAL SERVICES, NAMELY CONDUCTING CLASSES, SEMINARS, WORKSHOPS, TELECONFERENCES AND INDIVIDUAL AND GROUP COACHING IN THE FIELDS OF BUSINESS DEVELOPMENT, SALES IMPROVEMENT, COMMUNICATION SKILLS, DOCTOR/PATIENT RELATIONSHIPS, MOTIVATION, CUSTOMER SERVICE, SELF-IMPROVEMENT, BUSINESS MANAGEMENT, LEADERSHIP TRAINING, PERSONAL AND PROFESSIONAL INSPIRATION AND ACHIEVEMENT AND DEVELOPING SELF-ESTEEM (U.S. CLS. 100, 101 AND 107).

FIRST USE 2-1-2005; IN COMMERCE 2-1-2005.
MARIA-VICTORIA SUAREZ, EXAMINING ATTORNEY

SN 78-719,647. GLOBAL VALLEY NETWORKS, INC., PATTERSON, CA. FILED 9-23-2005.

GLOBAL VALLEY INET

THE MARK CONSISTS OF STANDARD CHARACTERS WITHOUT CLAIM TO ANY PARTICULAR FONT, STYLE, SIZE, OR COLOR.

NO CLAIM IS MADE TO THE EXCLUSIVE RIGHT TO USE "INET", APART FROM THE MARK AS SHOWN.

CLASS 38—COMMUNICATION

FOR TELECOMMUNICATIONS SERVICES, NAMELY, DIGITAL SUBSCRIBER LINE AND BROADBAND SERVICES, PROVIDING TELEPHONE SYSTEM AND BROADBAND BASED MULTIPLE USER ACCESS TO A GLOBAL COMPUTER INFORMATION NETWORK FOR THE TRANSFER AND DISSEMINATION OF A WIDE RANGE OF INFORMATION, FACSIMILE TRANSMISSION SERVICES; WIRELESS COMMUNICATION SERVICES, NAMELY, WIRELESS TELEPHONE, FACSIMILE TRANSMISSION, AND DIGITAL MESSAGING SERVICES, PROVIDING WIRELESS COMMUNICATIONS ACCESS TO A GLOBAL COMPUTER NETWORK (U.S. CLS. 100, 101 AND 104).

FIRST USE 8-9-2004; IN COMMERCE 8-9-2004.

CLASS 42—SCIENTIFIC, COMPUTER AND LEGAL SERVICES

FOR TECHNICAL SUPPORT, NAMELY, TROUBLESHOOTING OF COMPUTER HARDWARE AND SOFTWARE PROBLEMS (U.S. CLS. 100 AND 101).

FIRST USE 8-9-2004; IN COMMERCE 8-9-2004.
TASNEEM HUSSAIN, EXAMINING ATTORNEY

SN 78-720,220. KUBIK INC., MISSISSAUGA, ONTARIO, CANADA, FILED 9-26-2005.

SN 78-720,615. HNI TECHNOLOGIES INC., MUSCATINE, IA, FILED 9-26-2005.

kubik

THE MARK CONSISTS OF STANDARD CHARACTERS WITHOUT CLAIM TO ANY PARTICULAR FONT, STYLE, SIZE, OR COLOR.

CLASS 35—ADVERTISING AND BUSINESS

FOR ARRANGING AND CONDUCTING OF EXHIBITIONS FOR BUSINESS AND ADVERTISING PURPOSES FOR OTHERS (U.S. CLS. 100, 101 AND 102).

CLASS 37—CONSTRUCTION AND REPAIR

FOR CONSTRUCTION AND INSTALLATION OF EXHIBITS FOR BUSINESS AND ADVERTISING PURPOSES FOR OTHERS FOR TRADESHOWS, MUSEUMS, RETAIL STORES, BUSINESS OFFICES AND VISITOR CENTRES (U.S. CLS. 100, 103 AND 106).

CLASS 42—SCIENTIFIC, COMPUTER AND LEGAL SERVICES

FOR DESIGNING EXHIBITS FOR BUSINESS AND ADVERTISING PURPOSES FOR OTHERS FOR TRADE SHOWS, MUSEUMS, RETAIL STORES, BUSINESS OFFICES AND VISITOR CENTRES (U.S. CLS. 100 AND 101).
ANDREA SAUNDERS, EXAMINING ATTORNEY

SN 78-720,494. SUPER BAKERY, INCORPORATED, PITTSBURGH, PA. FILED 9-26-2005.



CLASS 5—PHARMACEUTICALS

FOR NUTRITIONALLY FORTIFIED BEVERAGES, NAMELY, NUTRITIONALLY FORTIFIED DRINKS COMPRISING PROTEIN RECOVERY SHAKES (U.S. CLS. 6, 18, 44, 46, 51 AND 52).

CLASS 30—STAPLE FOODS

FOR BAKERY PRODUCTS AND NUTRITIONALLY FORTIFIED BAKERY PRODUCTS, COMPRISING BAGELS, BREAD, BISCUITS, BUNS, ROLLS, CAKES, COOKIES, CRUSTS, NAMELY, PIZZA CRUST AND FROZEN PIE CRUST, CUPCAKES, DONUTS AND MINI-DONUTS, DONUT STICKS, DOUGH, FOOD BARS, NAMELY, READY-TO-EAT, CEREAL DERIVED FOOD BARS, FRENCH TOAST, FRUIT PIES, GLAZED RINGS, NAMELY, YEAST RAISED DONUTS, LOAFS AND MINI-LOAFS, NAMELY, CAKE BATTER AND MUFFIN-TYPE LOAFS, MARSHMALLOW TREATS, MUFFINS, PANCAKES, PASTRIES, PITA BREAD, PIZZA, SCONES, SNACK CAKES, TOAST, TORTILLAS, WAFFLES AND WRAPS, NAMELY, SANDWICH WRAPS, CONFECTIONERY, NAMELY, CANDY BARS (U.S. CL. 46).

TINA BROWN, EXAMINING ATTORNEY

GET SET

THE MARK CONSISTS OF STANDARD CHARACTERS WITHOUT CLAIM TO ANY PARTICULAR FONT, STYLE, SIZE, OR COLOR.

CLASS 16—PAPER GOODS AND PRINTED MATTER

FOR FLIP CHARTS AND FLIP CHART CARRYING CASES; CLIPBOARDS; DRY ERASE WRITING BOARDS (U.S. CLS. 2, 5, 22, 23, 29, 37, 38 AND 50).

FIRST USE 2-28-2003; IN COMMERCE 2-28-2003.

CLASS 20—FURNITURE AND ARTICLES NOT OTHERWISE CLASSIFIED

FOR OFFICE FURNITURE AND RAIL SYSTEMS COMPRISED PRIMARILY OF RAILS USED TO DISPLAY AND TO MOVE CLIPBOARDS, FLIP CHARTS AND WRITING BOARDS FOR OFFICES (U.S. CLS. 2, 13, 22, 25, 32 AND 50).

FIRST USE 2-28-2003; IN COMMERCE 2-28-2003.
HOWARD B. LEVINE, EXAMINING ATTORNEY

SN 78-720,802. DOMINTECH CO., LTD., WU KU HSIANG, TAIWAN, FILED 9-26-2005.



CLASS 37—CONSTRUCTION AND REPAIR

FOR SEMICONDUCTOR PACKAGE ADJUSTMENT SERVICES, NAMELY, REPAIR AND MAINTENANCE OF SEMICONDUCTOR PACKAGING MACHINES; INTEGRATED CIRCUIT PACKAGE ADJUSTMENT SERVICES, NAMELY, REPAIR AND MAINTENANCE OF INTEGRATED CIRCUIT PACKAGING MACHINES (U.S. CLS. 100, 103 AND 106).

CLASS 40—MATERIAL TREATMENT

FOR CUSTOM MANUFACTURE OF SEMICONDUCTORS, WAFERS AND INTEGRATED CIRCUITS (U.S. CLS. 100, 103 AND 106).

TANYA AMOS, EXAMINING ATTORNEY

SN 78-721,119. TROPICAL LIVING, INC., HANAIEI, HI.
FILED 9-27-2005.

SN 78-721,922. PAVILION INTEGRATION CORPORATION,
SAN JOSE, CA. FILED 9-28-2005.



THE COLOR(S) GREEN AND BLUE IS/ARE CLAIMED AS A FEATURE OF THE MARK.

THE COLOR BLUE APPEARS IN THE CIRCULAR BORDER AND IN THE WORDS "TROPICAL LIVING" AND THE COLOR GREEN APPEARS IN THE STYLIZED DEPICTION OF THE PALM LEAF.

THE MARK CONSISTS OF A CIRCULAR BORDER WITH A STYLIZED DEPICTION OF A PALM LEAF SET INSIDE THE BORDER AND A SHADED STYLIZED DEPICTION OF LAND LOCATED AT THE BOTTOM OF THE BORDER WITH THE WORDING "TROPICAL LIVING" SET OUTSIDE AND UNDERNEATH THE BORDER.

CLASS 20—FURNITURE AND ARTICLES NOT OTHERWISE CLASSIFIED

FOR FURNITURE, CHAIRS, TABLES, SOFAS, BEANBAG CHAIRS, AND PILLOWS (U.S. CLS. 2, 13, 22, 25, 32 AND 50).

CLASS 36—INSURANCE AND FINANCIAL

FOR REAL ESTATE AGENCIES SPECIALIZING IN VACANT PROPERTY, HOMES AND VILLAS; REAL ESTATE BROKERAGE SPECIALIZING IN VACANT PROPERTY, HOMES AND VILLAS; LEASING OF VACANT PROPERTY, HOMES AND VILLAS (U.S. CLS. 100, 101 AND 102).

MICHAEL LEWIS, EXAMINING ATTORNEY

SN 78-721,918. PAVILION INTEGRATION CORPORATION,
SAN JOSE, CA. FILED 9-28-2005.

SHIVA

THE MARK CONSISTS OF STANDARD CHARACTERS WITHOUT CLAIM TO ANY PARTICULAR FONT, STYLE, SIZE, OR COLOR.

CLASS 9—ELECTRICAL AND SCIENTIFIC APPARATUS

FOR LASERS NOT FOR MEDICAL USE (U.S. CLS. 21, 23, 26, 36 AND 38).

CLASS 10—MEDICAL APPARATUS

FOR MEDICAL, SURGICAL AND MEDICAL DIAGNOSTIC LASERS FOR MEDICAL USE (U.S. CLS. 26, 39 AND 44).

DOMINIC J. FERRAIUOLO, EXAMINING ATTORNEY

LAPIS

THE MARK CONSISTS OF STANDARD CHARACTERS WITHOUT CLAIM TO ANY PARTICULAR FONT, STYLE, SIZE, OR COLOR.

CLASS 9—ELECTRICAL AND SCIENTIFIC APPARATUS

FOR LASERS NOT FOR MEDICAL USE AND COMPONENTS FOR SOLID-STATE LASER SYSTEMS, NAMELY, OPTICAL PUMPS FOR SOLID-STATE LASER SYSTEMS NOT FOR MEDICAL USE (U.S. CLS. 21, 23, 26, 36 AND 38).

CLASS 10—MEDICAL APPARATUS

FOR MEDICAL, SURGICAL AND MEDICAL DIAGNOSTIC LASERS FOR MEDICAL USE AND COMPONENTS FOR SOLID-STATE LASER SYSTEMS, NAMELY, OPTICAL PUMPS FOR SOLID-STATE LASER SYSTEMS, FOR MEDICAL USE (U.S. CLS. 26, 39 AND 44).

MICHAEL LEWIS, EXAMINING ATTORNEY

SN 78-723,772. PACE INVESTMENTS, WINDSOR, CO. FILED
9-29-2005.



NO CLAIM IS MADE TO THE EXCLUSIVE RIGHT TO USE "MAIL N COPY", APART FROM THE MARK AS SHOWN.

CLASS 35—ADVERTISING AND BUSINESS

FOR ADVERTISING AND BUSINESS SERVICES, NAMELY, PHOTOCOPYING SERVICES; WORD-PROCESSING AND TYPING SERVICES; RENTAL OF OFFICE MACHINERY AND EQUIPMENT; PHOTOCOPYING AND REPRODUCING AND COMPILING DOCUMENTS FOR OTHERS; LEASE AND RENTAL OF COPY MACHINES, TYPEWRITERS AND WORD PROCESSORS; RETAIL OUTLETS FEATURING MAILING, SHIPPING, PACKAGING, FAXING AND ELECTRONIC COMMUNICATIONS AND PHOTOCOPYING; AND RETAIL STORE SERVICES OFFERING STAMPS AND OFFICE SUPPLIES (U.S. CLS. 100, 101 AND 102).

FIRST USE 9-1-1999; IN COMMERCE 9-1-1999.

CLASS 38—COMMUNICATION

FOR COMMUNICATIONS SERVICES, NAMELY, FACSIMILE AND ELECTRONIC MESSAGE SERVICES, MESSAGE DELIVERY AND SENDING SERVICES, RENTAL OF TELEPHONE, FACSIMILE OR OTHER COMMUNICATION EQUIPMENT; VIDEO TELECONFERENCING (U.S. CLS. 100, 101 AND 104).

FIRST USE 9-1-1999; IN COMMERCE 9-1-1999.

CLASS 39—TRANSPORTATION AND STORAGE

FOR TRANSPORTATION AND STORAGE SERVICES, NAMELY THE SHIPPING AND DELIVERY OF GOODS, PARCELS AND DOCUMENTS; PICK-UP, WAREHOUSING, STORAGE, PACKING OF GOODS FOR TRANSPORT; AND DOCUMENT BOX RENTAL, DOCUMENT FORWARDING AND RECEIPT AND DELIVERY OF DOCUMENTS FOR OTHERS (U.S. CLS. 100 AND 105).

FIRST USE 9-1-1999; IN COMMERCE 9-1-1999.
JULIE GUTTADAURO, EXAMINING ATTORNEY

SN 78-725,285. CLAYTON CORPORATION, FENTON, MO.
FILED 10-3-2005.

**How to treat
concrete**

SN 78-724,345. SIGNUM BIOSCIENCES, INC., MONMOUTH JUNCTION, NJ. FILED 9-30-2005.

caffion

THE MARK CONSISTS OF STANDARD CHARACTERS WITHOUT CLAIM TO ANY PARTICULAR FONT, STYLE, SIZE, OR COLOR.

CLASS 5—PHARMACEUTICALS

FOR NUTRITIONALLY FORTIFIED BEVERAGES; DRINK ADDITIVES, NAMELY, POWDERED NUTRITIONAL SUPPLEMENT DRINK MIXES (U.S. CLS. 6, 18, 44, 46, 51 AND 52).

CLASS 32—LIGHT BEVERAGES

FOR SPORTS DRINKS (U.S. CLS. 45, 46 AND 48).
LINDA ORNDORFF, EXAMINING ATTORNEY

SN 78-725,248. FOUR DREAMS, LLC, GREENSBORO, NC.
FILED 10-3-2005.

water

THE MARK CONSISTS OF STANDARD CHARACTERS WITHOUT CLAIM TO ANY PARTICULAR FONT, STYLE, SIZE, OR COLOR.

CLASS 20—FURNITURE AND ARTICLES NOT OTHERWISE CLASSIFIED

FOR FURNITURE, NAMELY BEDS, SOFAS, TABLES, CHAIRS, DRESSERS, ARMOIRES AND OUTDOOR FURNITURE, BUT NONE OF SUCH GOODS CONTAINING, FEATURING OR USED IN WATER (U.S. CLS. 2, 13, 22, 25, 32 AND 50).

CLASS 25—CLOTHING

FOR CLOTHING, NAMELY SHIRTS, PANTS, SCARVES, BELTS, SOCKS AND SHOES, NOT SPECIFICALLY DESIGNED FOR USE IN WATER (U.S. CLS. 22 AND 39).

CAROLYN CATALDO, EXAMINING ATTORNEY

NO CLAIM IS MADE TO THE EXCLUSIVE RIGHT TO USE "CONCRETE", APART FROM THE MARK AS SHOWN.

CLASS 2—PAINTS

FOR SEALERS, PAINTS AND COATINGS FOR USE ON STUCCO, MASONRY, CEMENT, CONCRETE, BRICK, STONE, AGGREGATE, FLOORING, AND CEILING AND WALL SURFACES (U.S. CLS. 6, 11 AND 16).

FIRST USE 3-21-2005; IN COMMERCE 3-21-2005.

CLASS 3—COSMETICS AND CLEANING PREPARATIONS

FOR STAIN REMOVERS AND DEGREASING PREPARATIONS, NOT USED IN MANUFACTURING PROCESSES, FOR RESIDENTIAL AND COMMERCIAL USES (U.S. CLS. 1, 4, 6, 50, 51 AND 52).

FIRST USE 3-21-2005; IN COMMERCE 3-21-2005.
WENDY JUN, EXAMINING ATTORNEY

SN 78-727,076. SPORT ESCAPES, INC., MARLBORO, MA.
FILED 10-5-2005.

**Wine, Dine
& Gamble!**

CLASS 39—TRANSPORTATION AND STORAGE

FOR TRAVEL AGENCY AND TOUR OPERATOR SERVICES, NAMELY ARRANGING AIR, CAR AND BUS TRANSPORTATION BY MAKING RESERVATIONS AND BOOKINGS AND THE ORGANIZATION OF TOURS, GOLF EXCURSIONS AND SIGHTSEEING TOURS BY PLANNING, COORDINATING AND EXECUTING THE DETAILS OF THE TRIP (U.S. CLS. 100 AND 105).

FIRST USE 3-19-2003; IN COMMERCE 3-19-2003.

CLASS 43—HOTEL AND RESTAURANT SERVICES

FOR TRAVEL AGENCY SERVICES, NAMELY MAKING RESERVATIONS FOR RESTAURANTS AND ARRANGEMENTS OF LODGING, NAMELY MAKING RESERVATIONS AND BOOKING FOR TEMPORARY LODGING (U.S. CLS. 100 AND 101).

FIRST USE 3-19-2003; IN COMMERCE 3-19-2003.
SEAN CROWLEY, EXAMINING ATTORNEY

SN 78-727,806. SPORT ESCAPES, INC., MARLBOROUGH, MA. FILED 10-6-2005.

SN 78-728,170. PLANET HOLLYWOOD (REGION IV), INC., ORLANDO, FL. FILED 10-6-2005.



NO CLAIM IS MADE TO THE EXCLUSIVE RIGHT TO USE "GOLF & GAMBLE", APART FROM THE MARK AS SHOWN.

CLASS 39—TRANSPORTATION AND STORAGE

FOR TRAVEL SERVICES FOR INDIVIDUALS AND GROUPS, NAMELY, ARRANGING TRAVEL TOURS, TRAVEL BOOKINGS AGENCY, AND TRAVEL AGENCY SERVICES, NAMELY, RESERVATIONS AND BOOKING FOR TRANSPORTATION; TRAVEL AGENCY SERVICES, NAMELY, MAKING RESERVATIONS AND BOOKING FOR INDIVIDUALS AND GROUPS FOR TOURS (U.S. CLS. 100 AND 105).

FIRST USE 2-1-1996; IN COMMERCE 2-1-1996.

CLASS 41—EDUCATION AND ENTERTAINMENT

FOR TRAVEL AGENCY SERVICES, NAMELY, MAKING RESERVATIONS AND BOOKINGS FOR INDIVIDUALS AND GROUPS FOR TICKETS AND TEE TIMES AT GOLF COURSES AND TO SPORT ACTIVITIES, TOURNAMENTS, SHOWS AND OTHER ENTERTAINMENT EVENTS (U.S. CLS. 100, 101 AND 107).

FIRST USE 2-1-1996; IN COMMERCE 2-1-1996.

CLASS 43—HOTEL AND RESTAURANT SERVICES

FOR TRAVEL AGENCY SERVICES, NAMELY, MAKING RESERVATIONS AND BOOKINGS FOR INDIVIDUALS AND GROUPS FOR TEMPORARY LODGING AND FOR MEALS (U.S. CLS. 100 AND 101).

FIRST USE 2-1-1996; IN COMMERCE 2-1-1996.
MICHAEL KAZAZIAN, EXAMINING ATTORNEY

OWNER OF U.S. REG. NO. 1,788,712.

NO CLAIM IS MADE TO THE EXCLUSIVE RIGHT TO USE "RESORT & CASINO", APART FROM THE MARK AS SHOWN.

THE COLOR(S) RED AND WHITE IS/ARE CLAIMED AS A FEATURE OF THE MARK.

THE MARK CONSISTS OF RED ARCHED LETTERS WITH A WHITE TRIM.

CLASS 9—ELECTRICAL AND SCIENTIFIC APPARATUS

FOR (BASED ON INTENT TO USE) GAMING DEVICES, NAMELY, SLOT MACHINES WITH OR WITHOUT VIDEO OUTPUT (U.S. CLS. 21, 23, 26, 36 AND 38).

CLASS 25—CLOTHING

FOR (BASED ON INTENT TO USE) CLOTHING, NAMELY T-SHIRTS, SHIRTS, SWEATSHIRTS, POLO SHIRTS, SPORT SHIRTS, SHORTS, JACKETS, CAPS (U.S. CLS. 22 AND 39).

CLASS 28—TOYS AND SPORTING GOODS

FOR (BASED ON INTENT TO USE) GAMING AND CASINO EQUIPMENT, NAMELY POKER CHIPS, GAMING TABLES, PLAYING CARDS (U.S. CLS. 22, 23, 38 AND 50).

CLASS 41—EDUCATION AND ENTERTAINMENT

FOR (BASED ON USE IN COMMERCE) CASINO ENTERTAINMENT SERVICES (U.S. CLS. 100, 101 AND 107).

FIRST USE 0-0-2005; IN COMMERCE 0-0-2005.

CLASS 43—HOTEL AND RESTAURANT SERVICES

FOR (BASED ON USE IN COMMERCE) HOTEL, RESTAURANT AND BAR SERVICES (U.S. CLS. 100 AND 101).

FIRST USE 0-0-2005; IN COMMERCE 0-0-2005.
ANNE MADDEN, EXAMINING ATTORNEY

SN 78-728,249. GEOGRAPHIC TECHNOLOGIES GROUP, INC., GOLDSBORO, NC. FILED 10-6-2005.

GEOGRAPHIC TECHNOLOGIES
GROUP

THE MARK CONSISTS OF STANDARD CHARACTERS WITHOUT CLAIM TO ANY PARTICULAR FONT, STYLE, SIZE, OR COLOR.

NO CLAIM IS MADE TO THE EXCLUSIVE RIGHT TO USE "GROUP", APART FROM THE MARK AS SHOWN. SEC. 2(F).

CLASS 9—ELECTRICAL AND SCIENTIFIC APPARATUS

FOR COMPUTER SOFTWARE FOR GEOGRAPHIC INFORMATION SYSTEMS AND COMPUTER GEOGRAPHIC LOCATIONAL SYSTEMS (U.S. CLS. 21, 23, 26, 36 AND 38).

FIRST USE 7-11-1997; IN COMMERCE 7-11-1997.

CLASS 42—SCIENTIFIC, COMPUTER AND LEGAL SERVICES

FOR SOFTWARE CONSULTATION AND SOFTWARE INSTALLATION SERVICES IN THE FIELD OF GEOGRAPHIC INFORMATION SYSTEMS; DATA MINING AND DATA MAPPING SERVICES; DESIGN AND DEVELOPMENT OF INFORMATION AND DATA BASES (U.S. CLS. 100 AND 101).

FIRST USE 7-11-1997; IN COMMERCE 7-11-1997.

SARAH WAYDA, EXAMINING ATTORNEY

SN 78-728,585. LES BOXERS BOYZ INC., MONTREAL, QUEBEC, CANADA, FILED 10-7-2005.

BILLY & ELLI

THE MARK CONSISTS OF STANDARD CHARACTERS WITHOUT CLAIM TO ANY PARTICULAR FONT, STYLE, SIZE, OR COLOR.

OWNER OF CANADA REG. NO. TMA649,709, DATED 10-5-2005, EXPIRES 10-5-2020.

CLASS 25—CLOTHING

FOR CLOTHING NAMELY T-SHIRTS, JOGGING OUTFITS, FLEECE-LINED SWEATERS AND PANTS, PANTS, DRESSES, SKIRTS, SWEATERS, SHIRTS, JACKETS, JUMPSUITS, JUMPERS, INFANT SLEEPERS, OVERALLS, BLOUSES, PYJAMAS, NIGHT DRESSES, BATHROBES, SHORTS, BERMUDA SHORTS, UNDERCLOTHING, BOXER BRIEFS, CAMISOLES, TIGHTS, HOSIERY, SOCKS, ROMPERS, SNOWSUITS, TOQUES, SCARVES, MITTENS, GLOVES, SWIM SUITS, COATS, RAIN JACKETS, RAINCOATS, WAIST-LENGTH JACKETS, HATS, BELT AND HEADBANDS (U.S. CLS. 22 AND 39).

FIRST USE 2-15-2005; IN COMMERCE 2-15-2005.

CLASS 26—FANCY GOODS

FOR HAIR ACCESSORIES NAMELY, BARRETTES, ELASTICS, HAIR ORNAMENTS IN THE FORM OF COMBS, RIBBONS, HAIR TIES, PINS AND HAIR CLIPS (U.S. CLS. 37, 39, 40, 42 AND 50).

MARIAM MAHMOUDI, EXAMINING ATTORNEY

SN 78-728,994. MARQUEZ, EDUARDO J., MIAMI, FL. FILED 10-7-2005.



NO CLAIM IS MADE TO THE EXCLUSIVE RIGHT TO USE "AVIONICS SALES CORPORATION", APART FROM THE MARK AS SHOWN.

CLASS 35—ADVERTISING AND BUSINESS

FOR (BASED ON USE IN COMMERCE) RETAIL STORE AND DISTRIBUTORSHIP SERVICES IN FIELD OF AIRCRAFT ELECTRONICS EQUIPMENT (U.S. CLS. 100, 101 AND 102).

FIRST USE 1-1-1992; IN COMMERCE 1-1-1992.

CLASS 37—CONSTRUCTION AND REPAIR

FOR (BASED ON INTENT TO USE) AIRCRAFT ELECTRONIC REPAIR AND MAINTENANCE SERVICES (U.S. CLS. 100, 103 AND 106).

KATRINA EDGE, EXAMINING ATTORNEY

SN 78-731,013. VIN I.Q. INC., EDMONTON, ALBERTA, CANADA, FILED 10-11-2005.



THE MARK CONSISTS OF A RECTANGLE WITH THE WORDS VIN IQ IN STYLIZED LETTERS; BENEATH THE WORDS APPEAR A BAR CODE WITH THE FOLLOWING NUMBERS AND LETTERS: 1FMZU72E3YZB08287.

CLASS 9—ELECTRICAL AND SCIENTIFIC APPARATUS

FOR PORTABLE WIRELESS HANDHELD COMPUTER HARDWARE AND SOFTWARE FOR USE IN BARCODE LASER SCANNING OF VEHICLE INFORMATION AND DIGITAL PHOTOGRAPHIC CAPTURING OF VEHICLE IMAGES; DOWNLOADABLE WEB-ENABLED SOFTWARE APPLICATION FOR USE IN THE FIELD OF MANAGING VEHICLE INFORMATION, INVENTORY, SALES AND MARKETING INFORMATION (U.S. CLS. 21, 23, 26, 36 AND 38).

CLASS 42—SCIENTIFIC, COMPUTER AND LEGAL SERVICES

FOR PROVISION TO OTHERS OF NON-DOWNLOADABLE WEB-ENABLED SOFTWARE APPLICATION FOR USE IN THE FIELD OF MANAGING VEHICLE INFORMATION, INVENTORY, SALES AND MARKETING INFORMATION (U.S. CLS. 100 AND 101).

LEIGH CAROLINE CASE, EXAMINING ATTORNEY

SN 78-732,077. SOTTOPELLE, INC., SCOTTSDALE, AZ. FILED 10-12-2005.

SOTTOPELLE VITALITY CENTERS

THE MARK CONSISTS OF STANDARD CHARACTERS WITHOUT CLAIM TO ANY PARTICULAR FONT, STYLE, SIZE, OR COLOR.

OWNER OF U.S. REG. NO. 2,916,806.

NO CLAIM IS MADE TO THE EXCLUSIVE RIGHT TO USE "SOTTO PELLE" AND "CENTERS", APART FROM THE MARK AS SHOWN.

THE FOREIGN WORDING SOTTO PELLE IN THE MARK TRANSLATES INTO ENGLISH AS "UNDER SKIN."

CLASS 41—EDUCATION AND ENTERTAINMENT

FOR MEDICAL TRAINING AND TEACHING; CONDUCTING SEMINARS IN THE FIELDS OF OBSTETRICS AND GYNECOLOGY; INSTRUCTION IN THE FIELD OF OBSTETRICS AND GYNECOLOGY; TRAINING SERVICES FOR PHYSICIANS IN THE FIELD OF OBSTETRICS, GYNECOLOGY AND HORMONE REPLACEMENT THERAPY SERVICES (U.S. CLS. 100, 101 AND 107).

CLASS 44—MEDICAL, BEAUTY AND AGRICULTURAL SERVICES

FOR MEDICAL CLINICS; MEDICAL CONSULTATIONS; MEDICAL SERVICES; PROVIDING MEDICAL INFORMATION; PROVIDING HEALTH INFORMATION; DIETARY AND NUTRITIONAL GUIDANCE; MEDICAL SERVICES, NAMELY, OBSTETRIC AND GYNECOLOGY SERVICES; AND HORMONE REPLACEMENT THERAPY (U.S. CLS. 100 AND 101).

STEVEN PEREZ, EXAMINING ATTORNEY

SN 78-733,147. ARAMARK CORPORATION, PHILADELPHIA, PA. FILED 10-14-2005.

YOU DESERVE IT!

THE MARK CONSISTS OF STANDARD CHARACTERS WITHOUT CLAIM TO ANY PARTICULAR FONT, STYLE, SIZE, OR COLOR.

CLASS 35—ADVERTISING AND BUSINESS

FOR VENDING SERVICES IN THE FIELD OF COFFEE AND BEVERAGES (U.S. CLS. 100, 101 AND 102).

CLASS 43—HOTEL AND RESTAURANT SERVICES

FOR COFFEE SERVICES, NAMELY COFFEE SUPPLY SERVICES, OFFICE COFFEE SUPPLY SERVICES; RESTAURANTS AND RESTAURANT SERVICES (U.S. CLS. 100 AND 101).

SCOTT SISUN, EXAMINING ATTORNEY

SN 78-735,243. TAXSMART, INC., AGOURA HILLS, CA. FILED 10-18-2005.

Total Practice

THE MARK CONSISTS OF STANDARD CHARACTERS WITHOUT CLAIM TO ANY PARTICULAR FONT, STYLE, SIZE, OR COLOR.

NO CLAIM IS MADE TO THE EXCLUSIVE RIGHT TO USE "PRACTICE", APART FROM THE MARK AS SHOWN.

CLASS 16—PAPER GOODS AND PRINTED MATTER

FOR EDUCATIONAL PUBLICATIONS, NAMELY, TRAINING MANUALS IN THE FIELD OF TAXATION (U.S. CLS. 2, 5, 22, 23, 29, 37, 38 AND 50).

FIRST USE 4-1-2005; IN COMMERCE 6-1-2005.

CLASS 35—ADVERTISING AND BUSINESS

FOR ADVICE IN THE FIELD OF BUSINESS MANAGEMENT AND MARKETING (U.S. CLS. 100, 101 AND 102).

FIRST USE 4-1-2005; IN COMMERCE 6-1-2005.

CLASS 41—EDUCATION AND ENTERTAINMENT

FOR PUBLISHING AND DISTRIBUTION OF BOOKS, REVIEWS AND OTHER PRINTED MATTER AS WELL AS RELATED ELECTRONIC DATA CARRIERS (U.S. CLS. 100, 101 AND 107).

FIRST USE 4-1-2005; IN COMMERCE 6-1-2005.

DARRYL SPRUILL, EXAMINING ATTORNEY

SN 78-735,670. W.H. SHIRLEY, INC., BASALT, CO. FILED 10-18-2005.



NO CLAIM IS MADE TO THE EXCLUSIVE RIGHT TO USE "INC.", APART FROM THE MARK AS SHOWN.

THE STIPPLING SHOWN IN THE DRAWING IS A FEATURE OF THE MARK.

CLASS 35—ADVERTISING AND BUSINESS

FOR CONSULTING SERVICES IN BUSINESS ORGANIZATION AND MANAGEMENT (U.S. CLS. 100, 101 AND 102).

FIRST USE 10-15-2002; IN COMMERCE 8-3-2003.

CLASS 41—EDUCATION AND ENTERTAINMENT

FOR PERSONAL COACHING SERVICES IN THE FIELD OF BUSINESS ORGANIZATION AND MANAGEMENT (U.S. CLS. 100, 101 AND 107).

FIRST USE 10-15-2002; IN COMMERCE 8-3-2003.
CHARLES L. JENKINS, EXAMINING ATTORNEY

SN 78-735,676. BENEFICIAL LIFE INSURANCE COMPANY, SALT LAKE CITY, UT. FILED 10-18-2005.



THE MARK CONSISTS OF STYLIZED WORDS "CPA" AND "PLUS".

CLASS 35—ADVERTISING AND BUSINESS

FOR ASSISTANCE, ADVISORY SERVICES AND CONSULTANCY WITH REGARD TO BUSINESS PLANNING, BUSINESS ANALYSIS, BUSINESS MANAGEMENT AND BUSINESS ORGANIZATION (U.S. CLS. 100, 101 AND 102).

CLASS 36—INSURANCE AND FINANCIAL

FOR ASSISTANCE, ADVISORY SERVICES AND CONSULTANCY WITH REGARD TO INVESTMENT SERVICES, NAMELY, ASSET MANAGEMENT SERVICES AND INDIVIDUAL INSURANCE STRATEGIES (U.S. CLS. 100, 101 AND 102).

CYNTHIA SLOAN, EXAMINING ATTORNEY

SN 78-736,076. ROCKSTEADY STUDIOS LIMITED, FINCHLEY LONDON, UNITED KINGDOM, FILED 10-19-2005.

ROCKSTEADY

THE MARK CONSISTS OF STANDARD CHARACTERS WITHOUT CLAIM TO ANY PARTICULAR FONT, STYLE, SIZE, OR COLOR.

PRIORITY CLAIMED UNDER SEC. 44(D) ON UNITED KINGDOM APPLICATION NO. 2392385, FILED 5-19-2005, REG. NO. 2392385, DATED 3-31-2006, EXPIRES 5-19-2015.

CLASS 9—ELECTRICAL AND SCIENTIFIC APPARATUS

FOR COMPUTER GAMES SOFTWARE; ELECTRONIC GAME PROGRAMS; COMPUTER GAMES SOFTWARE AND ELECTRONIC GAME PROGRAMS ADAPTED FOR USE WITH TELEVISION RECEIVERS AND COMPUTERS; APPARATUS FOR COMPUTER AND ELECTRONIC GAMES ADAPTED FOR USE WITH TELEVISION RECEIVERS AND COMPUTERS, NAMELY, REMOTE CONTROLS, JOY STICKS, CABLES, MEMORY CARDS, INTERACTIVE FLOOR MATS, ADAPTERS FOR MULTI-PLAYER CAPACITY, VIBRATION SENSORS AND MODULES, AND MOUSE PADS; HANDHELD PERSONAL COMPUTERS FOR PLAYING ELECTRONIC GAMES; VIDEO GAME MACHINES FOR USE WITH TELEVISIONS; SUNGLASSES AND SPECTACLES (U.S. CLS. 21, 23, 26, 36 AND 38).

CLASS 16—PAPER GOODS AND PRINTED MATTER

FOR BOOKS, NEWSPAPER PAMPHLETS, MAGAZINES, JOURNALS, AND PRINTED PERIODICALS, ALL RELATING TO COMPUTER GAMES, ELECTRONIC GAMES AND VIDEO GAMES; BOOK COVERS, CALENDARS; PICTURES; PHOTOGRAPHS; PAPER STATIONERY; PENCILS; POSTERS; PENS; TISSUE PAPER; CRAYONS; STICKERS; DECALCOMANIA; DIARIES; GREETING CARDS; ADDRESS BOOKS; BINDERS (U.S. CLS. 2, 5, 22, 23, 29, 37, 38 AND 50).

CLASS 28—TOYS AND SPORTING GOODS

FOR STAND ALONE VIDEO GAME MACHINES; ARCADE-TYPE ELECTRONIC VIDEO GAMES FOR AMUSEMENT GAME MACHINES; HAND-HELD VIDEO GAME MACHINES; ARCADE-TYPE ELECTRONIC VIDEO GAMES FOR HAND-HELD VIDEO GAME MACHINES; PLAYING CARDS; TOY ACTION FIGURES; COIN OPERATED VIDEO GAMES (U.S. CLS. 22, 23, 38 AND 50).

CLASS 41—EDUCATION AND ENTERTAINMENT

FOR ENTERTAINMENT SERVICES, NAMELY, PROVIDING ON-LINE COMPUTER GAMES; COMPUTER GAMES, INTERACTIVE COMPUTER GAMES, AND VIDEO GAMES PROVIDED ON-LINE FROM DATABASES OR WEB SITES AND GLOBAL COMPUTER NETWORKS; COMPUTER GAMES PROVIDED ON-LINE FROM DATABASES OR WEB SITES AND GLOBAL COMPUTER NETWORKS (U.S. CLS. 100, 101 AND 107).

CHRISTOPHER BUONGIORNO, EXAMINING ATTORNEY

SN 78-736,363. INTERNATIONAL MASTERS PUBLISHERS AB, MALMO, SWEDEN, FILED 10-19-2005.



OWNER OF U.S. REG. NOS. 2,844,855 AND 3,000,645.

CLASS 41—EDUCATION AND ENTERTAINMENT

FOR ENTERTAINMENT SERVICES, NAMELY, PROVIDING ON-LINE COMPUTER GAMES, NAMELY, CROSSWORD PUZZLES, WORD SCRAMBLES, QUOTE SCRAMBLES, HIDDEN PICTURE PUZZLES, HIDDEN WORD PUZZLES, TRIVIA QUESTIONS AND CARD GAMES; PROVIDING INFORMATION AND TRIVIA VIA A GLOBAL COMPUTER NETWORK ON A MEMBERS-ONLY WEBSITE ON FICTIONAL CREATURES; ENTERTAINMENT SERVICES, NAMELY, PROVIDING ON-LINE COMPUTER GAMES, NAMELY, CROSSWORD PUZZLES, WORD SCRAMBLES, QUOTE SCRAMBLES, HIDDEN PICTURE PUZZLES, HIDDEN WORD PUZZLES, TRIVIA QUESTIONS AND CARD GAMES (U.S. CLS. 100, 101 AND 107).

FIRST USE 10-1-2004; IN COMMERCE 10-1-2004.

CLASS 42—SCIENTIFIC, COMPUTER AND LEGAL SERVICES

FOR PROVIDING INFORMATION AND TRIVIA VIA A GLOBAL COMPUTER NETWORK ON A MEMBERS-ONLY WEBSITE ON THE GENERAL HISTORY OF MODERN AND PRE-HISTORIC ANIMALS AND THEIR HABITATS (U.S. CLS. 100 AND 101).

FIRST USE 10-1-2004; IN COMMERCE 10-1-2004.
STEVEN JACKSON, EXAMINING ATTORNEY

CLASS 9—ELECTRICAL AND SCIENTIFIC APPARATUS

FOR DATA PROCESSING DEVICES FOR THE GRAPHICS INDUSTRY, NAMELY DATA PROCESSING COMPUTER PROGRAMS AND CENTRAL PROCESSING UNITS FOR PROCESSING DATA AND IMAGES; ELECTRIC AND ELECTRONIC DEVICES NAMELY COMPUTER SOFTWARE AND HARDWARE FOR CONTROLLING, REGULATING, AND NETWORKING PRINTING MACHINE AND MACHINES FOR THE FURTHER PROCESSING OF PRINTED PRODUCTS NAMELY MACHINES FOR BINDING, EMBOSsing, CUTTING, PUNCHING AND FOLDING; DATA PROCESSING PROGRAMS FOR CONTROLLING MACHINES FOR THE GRAPHICS INDUSTRY, FOR PROCESSING AND TRANSMITTING INFORMATION, DATA, IMAGES, AND GRAPHICS, AND FOR CONTROLLING PRODUCTION PROCESSES IN CONNECTION WITH THE MANUFACTURING OF PRINTED PRODUCTS (U.S. CLS. 21, 23, 26, 36 AND 38).

CLASS 37—CONSTRUCTION AND REPAIR

FOR REPAIR AND MAINTENANCE OF PUNCHING MACHINES, CREASING MACHINES, EMBOSsing MACHINES AND MACHINES FOR MANUFACTURING PACKAGING (U.S. CLS. 100, 103 AND 106).

ALAIN LAPTEY, EXAMINING ATTORNEY

SN 78-736,967. HEIDELBERGER DRUCKMASCHINEN AG, HEIDELBERG D69115, FED REP GERMANY, FILED 10-20-2005.

SN 78-737,655. LOUIS GARNEAU SPORTS INC., SAINT-AUGUSTIN-DE-DEsMAURES, QUEBEC, CANADA, FILED 10-20-2005.

Dyset

EXO-NERV

THE MARK CONSISTS OF STANDARD CHARACTERS WITHOUT CLAIM TO ANY PARTICULAR FONT, STYLE, SIZE, OR COLOR.

THE MARK CONSISTS OF STANDARD CHARACTERS WITHOUT CLAIM TO ANY PARTICULAR FONT, STYLE, SIZE, OR COLOR.

PRIORITY CLAIMED UNDER SEC. 44(D) ON FED REP GERMANY APPLICATION NO. 30528865207, FILED 5-17-2005, REG. NO. 30528856, DATED 6-20-2005, EXPIRES 5-31-2015.

CLASS 7—MACHINERY

FOR PRINTING MACHINES; MACHINES FOR THE FURTHER PROCESSING OF PRINTED PRODUCTS, NAMELY MACHINES FOR BINDING, CUTTING, PUNCHING AND FOLDING; SHEET FEEDERS; MACHINES FOR PRODUCING PACKAGING MATERIALS, NAMELY CARD BOXES; PUNCHING MACHINES; CREASING MACHINES; EMBOSsing MACHINES; AND COMPONENT PARTS AND ACCESSORIES FOR THE AFOREMENTIONED GOODS (U.S. CLS. 13, 19, 21, 23, 31, 34 AND 35).

CLASS 9—ELECTRICAL AND SCIENTIFIC APPARATUS

FOR REINFORCEMENT SYSTEM COMPRISED OF PROTRUDING RIBS APPLIED ON THE OUTER SURFACE OF A FRAME SUBMITTED TO RELATIVELY HIGH STRESSES SPECIALLY ADAPTED FOR SPORTS EQUIPMENT, NAMELY SUNGLASS FRAMES, CYCLIST HELMETS (U.S. CLS. 21, 23, 26, 36 AND 38).

CLASS 12—VEHICLES

FOR REINFORCEMENT SYSTEM COMPRISED OF PROTRUDING RIBS APPLIED ON THE OUTER SURFACE OF A FRAME SUBMITTED TO RELATIVELY HIGH STRESSES SPECIALLY ADAPTED FOR SPORTS EQUIPMENT, NAMELY BICYCLE FRAMES, WATER BOTTLE HOLDERS FOR BICYCLES (U.S. CLS. 19, 21, 23, 31, 35 AND 44).

KATINA MISTER, EXAMINING ATTORNEY

SN 78-741,637. BDSRCO, INC., WILMINGTON, DE. FILED 10-27-2005.

SN 78-742,744. JIM'S FORMAL WEAR CO., TRENTON, IL. FILED 10-28-2005.

SKULLBOARDS CO.

THE MARK CONSISTS OF STANDARD CHARACTERS WITHOUT CLAIM TO ANY PARTICULAR FONT, STYLE, SIZE, OR COLOR.

NO CLAIM IS MADE TO THE EXCLUSIVE RIGHT TO USE "CO.", APART FROM THE MARK AS SHOWN.

CLASS 18—LEATHER GOODS

FOR FASHION ACCESSORIES, NAMELY, BACKPACKS (U.S. CLS. 1, 2, 3, 22 AND 41).

CLASS 25—CLOTHING

FOR CLOTHING, NAMELY, T-SHIRTS, KNIT TOPS AND BOTTOMS, WOVEN TOPS AND BOTTOMS, SHORTS, PANTS, FLEECE TOPS AND BOTTOMS, SWIMWEAR, FOOTWEAR, HEADWEAR AND OUTERWEAR, NAMELY, COATS, PARKAS, RAINCOATS AND JACKETS (U.S. CLS. 22 AND 39).

YONG KIM, EXAMINING ATTORNEY

SN 78-741,684. CAREER EDUCATION CORPORATION, HOFFMAN ESTATES, IL. FILED 10-27-2005.

BLISH.COM

THE MARK CONSISTS OF STANDARD CHARACTERS WITHOUT CLAIM TO ANY PARTICULAR FONT, STYLE, SIZE, OR COLOR.

CLASS 35—ADVERTISING AND BUSINESS

FOR PROVIDING AN ON-LINE WEBSITE TO ENABLE USERS TO PURCHASE AND EXCHANGE DIGITAL CONTENT IN THE FIELDS OF MUSIC, PHOTOGRAPHS, GAMES, VIDEO AND MULTIMEDIA CONTENT (U.S. CLS. 100, 101 AND 102).

CLASS 38—COMMUNICATION

FOR PROVIDING ONLINE FACILITIES IN THE NATURE OF CHAT ROOMS AND BULLETIN BOARDS FOR REAL-TIME INTERACTION WITH OTHER COMPUTER USERS CONCERNING PURCHASE AND EXCHANGE OF DIGITAL CONTENT IN THE FIELDS OF MUSIC, PHOTOGRAPHS, GAMES, VIDEO AND MULTIMEDIA CONTENT; PROVISION OF CONNECTIVITY SERVICES AND ACCESS TO ELECTRONIC COMMUNICATIONS NETWORKS (U.S. CLS. 100, 101 AND 104).

CLASS 41—EDUCATION AND ENTERTAINMENT

FOR ENTERTAINMENT SERVICES, NAMELY, PROVIDING ONLINE FACILITIES IN THE NATURE OF WEBSITES FEATURING INFORMATION ABOUT MUSIC, PHOTOGRAPHS, GAMES, VIDEO AND MULTIMEDIA CONTENT (U.S. CLS. 100, 101 AND 107).

ATTIYA MALIK, EXAMINING ATTORNEY

STEPHEN GEOFFREY

THE MARK CONSISTS OF STANDARD CHARACTERS WITHOUT CLAIM TO ANY PARTICULAR FONT, STYLE, SIZE, OR COLOR.

THE NAME IN THE MARK DOES NOT IDENTIFY A LIVING INDIVIDUAL.

CLASS 25—CLOTHING

FOR FORMAL WEAR, NAMELY TUXEDOS (U.S. CLS. 22 AND 39).

CLASS 45—PERSONAL SERVICES

FOR RENTAL OF FORMAL WEAR TO OTHERS (U.S. CLS. 100 AND 101).

BILL DAWE, EXAMINING ATTORNEY

SN 78-743,210. ZEICHICK, ROBERT A., CARMEL, CA. FILED 10-29-2005.

Thirdwind

THE MARK CONSISTS OF STANDARD CHARACTERS WITHOUT CLAIM TO ANY PARTICULAR FONT, STYLE, SIZE, OR COLOR.

CLASS 16—PAPER GOODS AND PRINTED MATTER

FOR SERIES OF EDUCATIONAL AND ENTERTAINMENT BOOKS FEATURING INFORMATION ON FINDING TRUE SUCCESS, A BALANCED LIFE, AND PERSONAL FULFILLMENT; ENTERTAINMENT AND EDUCATIONAL MAGAZINES FEATURING INFORMATION ON FINDING TRUE SUCCESS, A BALANCED LIFE, AND PERSONAL FULFILLMENT; PERSONAL PLANNERS FEATURING THEMES AND INFORMATION ON FINDING TRUE SUCCESS, A BALANCED LIFE, AND PERSONAL FULFILLMENT; PERSONAL ORGANIZERS FEATURING THEMES AND INFORMATION ON FINDING TRUE SUCCESS, A BALANCED LIFE, AND PERSONAL FULFILLMENT (U.S. CLS. 2, 5, 22, 23, 29, 37, 38 AND 50).

CLASS 41—EDUCATION AND ENTERTAINMENT

FOR EDUCATIONAL AND ENTERTAINMENT SERVICES, NAMELY, EDUCATION AND ENTERTAINMENT WORKSHOPS AND SEMINARS THAT FEATURE INFORMATION AND PROVIDE INSTRUCTION ON FINDING TRUE SUCCESS, CREATING A BALANCED LIFE, AND ESTABLISHING PERSONAL FULFILLMENT; RADIO AND TELEVISION PROGRAMS FEATURING INFORMATION AND PROVIDE INSTRUCTION ON FINDING TRUE SUCCESS, CREATING A BALANCED LIFE, AND ESTABLISHING PERSONAL FULFILLMENT; PROVIDING AN EDUCATIONAL WEB SITE THAT FEATURES EDUCATIONAL INFORMATION AND PROVIDES INSTRUCTION ON FINDING TRUE SUCCESS, CREATING A BALANCED LIFE, AND ESTABLISHING PERSONAL FULFILLMENT (U.S. CLS. 100, 101 AND 107).

JENNIFER WILLISTON, EXAMINING ATTORNEY

SN 78-744,356. THE PHIL AND AMY MICKELSON CHARITABLE FOUNDATION, CARLSBAD, CA. FILED 11-1-2005.

START SMART

CLASS 41—EDUCATION AND ENTERTAINMENT

FOR CHARITABLE SERVICES, NAMELY, PROVIDING SCHOOL SUPPLIES TO CHILDREN IN NEED (U.S. CLS. 100, 101 AND 107).

CLASS 45—PERSONAL SERVICES

FOR CHARITABLE SERVICES, NAMELY, PROVIDING CLOTHING TO NEEDY PERSONS (U.S. CLS. 100 AND 101).

STEVEN PEREZ, EXAMINING ATTORNEY

SN 78-747,037. IVOCLAR VIVADENT, INC., AMHERST, NY. FILED 11-4-2005.

ONE SMILE CHEMISTRY

THE MARK CONSISTS OF STANDARD CHARACTERS WITHOUT CLAIM TO ANY PARTICULAR FONT, STYLE, SIZE, OR COLOR.

CLASS 5—PHARMACEUTICALS

FOR MATERIALS FOR USE IN DENTISTRY, NAMELY CERAMIC RESTORATIVE MATERIALS FOR THE MANUFACTURE OF CROWNS AND BRIDGES, INLAYS, AND PROSTHESIS; DENTAL ALLOYS; DENTAL FILLING MATERIALS; MATERIALS FOR CAVITY TREATMENT, NAMELY ALLOYS; GLASS CERAMIC MATERIALS FOR THE RESTORATION OF DAMAGED TEETH; CERAMIC STRATUM; COLOR STAINS FOR USE IN DENTISTRY; PRECIOUS METAL ALLOYS AND NON-PRECIOUS METAL ALLOYS FOR DENTAL TECHNOLOGY; CORE MATERIALS FOR USE IN DENTISTRY, NAMELY ZIRCONIUM OXIDE, LITHIUM DISILICATE AND DENTAL ALLOY; OPAQUE MATERIALS OF GLASS CERAMIC SYSTEMS FOR USE IN DENTISTRY; RESIN, METAL AND CERAMIC INGOTS FOR DENTAL FILLINGS AND FOR SEALING PURPOSES; PREFABRICATED PARTS FOR CROWNS, BRIDGES AND ARTIFICIAL TEETH (U.S. CLS. 6, 18, 44, 46, 51 AND 52).

CLASS 10—MEDICAL APPARATUS

FOR DENTAL CROWNS AND CERAMIC ALLOY USED IN DENTAL CROWNS (U.S. CLS. 26, 39 AND 44).

SUSAN STIGLITZ, EXAMINING ATTORNEY

SN 78-747,148. NATIONAL SECURITY AGENCY, FT. MEADE, MD. FILED 11-4-2005.

CryptoKids

THE MARK CONSISTS OF STANDARD CHARACTERS WITHOUT CLAIM TO ANY PARTICULAR FONT, STYLE, SIZE, OR COLOR.

CLASS 41—EDUCATION AND ENTERTAINMENT

FOR PROVIDING INFORMATION IN THE FIELD OF LINGUISTICS (U.S. CLS. 100, 101 AND 107).

FIRST USE 11-1-2005; IN COMMERCE 11-1-2005.

CLASS 42—SCIENTIFIC, COMPUTER AND LEGAL SERVICES

FOR PROVIDING INFORMATION IN THE FIELD OF CRYPTOGRAPHY AND COMPUTER SCIENCE (U.S. CLS. 100 AND 101).

FIRST USE 11-1-2005; IN COMMERCE 11-1-2005.

KATINA MISTER, EXAMINING ATTORNEY

SN 78-747,642. HOLDERMAN, JAMES F. III, CHICAGO, IL. FILED 11-4-2005.

GOD NEEDS YOU

THE MARK CONSISTS OF STANDARD CHARACTERS WITHOUT CLAIM TO ANY PARTICULAR FONT, STYLE, SIZE, OR COLOR.

CLASS 14—JEWELRY

FOR JEWELRY, NAMELY BRACELETS, CHAINS, NECKLACES AND LOCKETS AND CRUCIFIXES; TIME PIECES, NAMELY WATCHES, POCKET-WATCHES, CLOCKS (U.S. CLS. 2, 27, 28 AND 50).

CLASS 16—PAPER GOODS AND PRINTED MATTER

FOR PRINTED MATERIALS, NAMELY PRINTED INFORMATIONAL CARDS IN THE FIELD OF RELIGION AND SPIRITUALITY, BUMPER STICKERS, STICKERS, BLANK OR PARTIALLY PRINTED PAPER LABELS, POSTERS, CALENDARS, AND PAMPHLETS IN THE FIELD OF RELIGION AND SPIRITUALITY (U.S. CLS. 2, 5, 22, 23, 29, 37, 38 AND 50).

CLASS 25—CLOTHING

FOR CLOTHING, NAMELY, T-SHIRTS, SHIRTS, JACKETS, VESTS, SHORTS AND UNDERWEAR; ATHLETIC WEAR, NAMELY, JOGGING PANTS, JOGGING SUITS, WARM UP SUITS, SWEATSHIRTS, PULLOVERS, AND WRISTBANDS; FOOTWEAR, NAMELY, SHOES AND SOCKS; HEADWEAR, NAMELY, HATS, CAPS, VISORS AND HEADBANDS; OUTERWEAR, NAMELY, SCARVES (U.S. CLS. 22 AND 39).

ROBERT C. CLARK JR., EXAMINING ATTORNEY

SN 78-747,815. IVAX INTERNATIONAL B.V., WATERFORD, IRELAND, FILED 11-4-2005.

X-ACT

THE MARK CONSISTS OF STANDARD CHARACTERS WITHOUT CLAIM TO ANY PARTICULAR FONT, STYLE, SIZE, OR COLOR.

CLASS 5—PHARMACEUTICALS

FOR INHALERS FILLED WITH MOLECULES TARGETED TO BE ADMINISTERED BY INHALATION, NAMELY CORTICOSTEROIDS, BETA AGONISTS, CROMOGLYCATES, ANTICHOLINERGICS, PROTEINS AND POLYPEPTIDES FOR THE TREATMENT OF RESPIRATORY DISEASES AND OTHER DISEASES, NAMELY, DIABETES MELLITUS, EOSINOPHILIC ESOPHAGITIS WHERE DRUG ADMINISTRATION BY INHALATION IS APPROPRIATE (U.S. CLS. 6, 18, 44, 46, 51 AND 52).

CLASS 10—MEDICAL APPARATUS

FOR MEDICAL APPARATUS FOR FACILITATING THE INHALATION OF PHARMACEUTICAL PREPARATIONS; INHALERS FOR MEDICAL PURPOSES, SOLD EMPTY; METERED DOSE INHALERS FOR MEDICAL PURPOSES, SOLD EMPTY; DRY POWDER INHALERS FOR MEDICAL PURPOSES, SOLD EMPTY; AEROSOL INHALERS FOR MEDICAL PURPOSES, SOLD EMPTY; AQUEOUS INHALERS FOR MEDICAL PURPOSES, SOLD EMPTY; ALL FOR THE TREATMENT OF RESPIRATORY CONDITIONS OR AILMENTS; NEBULIZERS FOR RESPIRATION THERAPY; PARTS, COMPONENTS AND FITTINGS FOR THE AFORESAID GOODS (U.S. CLS. 26, 39 AND 44).

ANN E. SAPPENFIELD, EXAMINING ATTORNEY

SN 78-747,819. IVAX INTERNATIONAL B.V., WATERFORD, IRELAND, FILED 11-4-2005.

SPIROMAX

THE MARK CONSISTS OF STANDARD CHARACTERS WITHOUT CLAIM TO ANY PARTICULAR FONT, STYLE, SIZE, OR COLOR.

CLASS 5—PHARMACEUTICALS

FOR INHALERS FILLED WITH MOLECULES TARGETED TO BE ADMINISTERED BY INHALATION, NAMELY CORTICOSTEROIDS, BETA AGONISTS, CROMOGLYCATES, ANTICHOLINERGICS, PROTEINS AND POLYPEPTIDES FOR THE TREATMENT OF RESPIRATORY DISEASES AND OTHER DISEASES, NAMELY, DIABETES MELLITUS, EOSINOPHILIC ESOPHAGITIS WHERE DRUG ADMINISTRATION BY INHALATION IS APPROPRIATE (U.S. CLS. 6, 18, 44, 46, 51 AND 52).

CLASS 10—MEDICAL APPARATUS

FOR MEDICAL APPARATUS FOR FACILITATING THE INHALATION OF PHARMACEUTICAL PREPARATIONS; INHALERS FOR MEDICAL PURPOSES, SOLD EMPTY; METERED DOSE INHALERS FOR MEDICAL PURPOSES, SOLD EMPTY; DRY POWDER INHALERS FOR MEDICAL PURPOSES, SOLD EMPTY; AEROSOL INHALERS FOR MEDICAL PURPOSES, SOLD EMPTY; AQUEOUS INHALERS FOR MEDICAL PURPOSES, SOLD EMPTY; ALL FOR THE TREATMENT OF RESPIRATORY CONDITIONS OR AILMENTS; NEBULIZERS FOR RESPIRATION THERAPY; PARTS, COMPONENTS AND FITTINGS FOR THE AFORESAID GOODS (U.S. CLS. 26, 39 AND 44).

ANN E. SAPPENFIELD, EXAMINING ATTORNEY

SN 78-748,817. CLEVER SPIDER CONSULTING GROUP, LLC, GREAT NECK, NY, FILED 11-7-2005.

CLEVER SPIDER

THE MARK CONSISTS OF STANDARD CHARACTERS WITHOUT CLAIM TO ANY PARTICULAR FONT, STYLE, SIZE, OR COLOR.

CLASS 35—ADVERTISING AND BUSINESS

FOR PROMOTING, ADVERTISING AND MARKETING OF THE ON-LINE WEBSITES OF OTHERS; RETAIL STORE SERVICES FEATURING COMPUTERS AND COMPUTER RELATED EQUIPMENT; ONLINE RETAIL STORE SERVICES FEATURING COMPUTERS AND COMPUTER RELATED EQUIPMENT; ADVERTISING SERVICES, NAMELY, CREATING CORPORATE IDENTITY AND PREPARING ADVERTISEMENTS FOR OTHERS (U.S. CLS. 100, 101 AND 102).

FIRST USE 9-1-2003; IN COMMERCE 1-1-2004.

CLASS 42—SCIENTIFIC, COMPUTER AND LEGAL SERVICES

FOR COMPUTER CONSULTING SERVICES, NAMELY, DESIGNING AND IMPLEMENTING WEB SITES FOR OTHERS; WEBSITE HOSTING; HOSTING OF DIGITAL CONTENT ON THE INTERNET; TECHNICAL SUPPORT SERVICES, NAMELY TROUBLESHOOTING OF COMPUTER HARDWARE AND COMPUTER-RELATED EQUIPMENT PROBLEMS (U.S. CLS. 100 AND 101).

FIRST USE 9-1-2003; IN COMMERCE 1-1-2004.
LINDA LAVACHE, EXAMINING ATTORNEY

SN 78-748,965. ASPEN SKIING COMPANY, ASPEN, CO. FILED 11-8-2005.

THANKSJIBBING

THE MARK CONSISTS OF STANDARD CHARACTERS WITHOUT CLAIM TO ANY PARTICULAR FONT, STYLE, SIZE, OR COLOR.

CLASS 41—EDUCATION AND ENTERTAINMENT

FOR SKI AND SNOWBOARD RESORT SERVICES; PROMOTING AND CONDUCTING SKIING AND SNOWBOARDING EXHIBITIONS AND COMPETITIONS; PROMOTING AND CONDUCTING MUSICAL AND LIVE ENTERTAINMENT PERFORMANCES; ENTERTAINMENT SERVICES, NAMELY PERSONAL APPEARANCES BY SPORTS AND ENTERTAINMENT INDUSTRY CELEBRITIES (U.S. CLS. 100, 101 AND 107).
FIRST USE 7-0-2003; IN COMMERCE 11-29-2003.

CLASS 43—HOTEL AND RESTAURANT SERVICES

FOR RESTAURANT SERVICES; BOOKING TEMPORARY LODGING AND LIFT TICKET PACKAGES (U.S. CLS. 100 AND 101).
FIRST USE 7-0-2003; IN COMMERCE 11-29-2003.
NORA BUCHANAN WILL, EXAMINING ATTORNEY

SN 78-749,164. QUANTA SERVICES, HOUSTON, TX. FILED 11-8-2005.

RIGGIN & DIGGIN

THE MARK CONSISTS OF STANDARD CHARACTERS WITHOUT CLAIM TO ANY PARTICULAR FONT, STYLE, SIZE, OR COLOR.

CLASS 37—CONSTRUCTION AND REPAIR

FOR INSTALLATION AND MAINTENANCE OF ELECTRIC POWER AND UTILITY LINES (U.S. CLS. 100, 103 AND 106).
FIRST USE 6-3-1999; IN COMMERCE 6-3-1999.

CLASS 40—MATERIAL TREATMENT

FOR CUSTOM CONSTRUCTION OF ELECTRIC POWER AND UTILITY LINES FOR OTHERS (U.S. CLS. 100, 103 AND 106).
FIRST USE 6-3-1999; IN COMMERCE 6-3-1999.
SEAN CROWLEY, EXAMINING ATTORNEY

SN 78-750,345. RENAISSANCE LEARNING, INC., WISCONSIN RAPIDS, WI. FILED 11-9-2005.

EYEHEAR

THE MARK CONSISTS OF STANDARD CHARACTERS WITHOUT CLAIM TO ANY PARTICULAR FONT, STYLE, SIZE, OR COLOR.

CLASS 9—ELECTRICAL AND SCIENTIFIC APPARATUS

FOR COMPUTER SOFTWARE FOR ASSESSING LANGUAGE SKILL LEVELS AND TEACHING LANGUAGES FOR USE IN THE FIELD OF LANGUAGE INSTRUCTION (U.S. CLS. 21, 23, 26, 36 AND 38).

CLASS 16—PAPER GOODS AND PRINTED MATTER

FOR EDUCATIONAL PUBLICATIONS, NAMELY, WRITTEN TRAINING MANUALS IN THE FIELD OF LANGUAGE INSTRUCTION (U.S. CLS. 2, 5, 22, 23, 29, 37, 38 AND 50).
MYRIAH HABEEB, EXAMINING ATTORNEY

SN 78-751,531. CLEVER SPIDER CONSULTING GROUP, LLC, GREAT NECK, NY. FILED 11-10-2005.

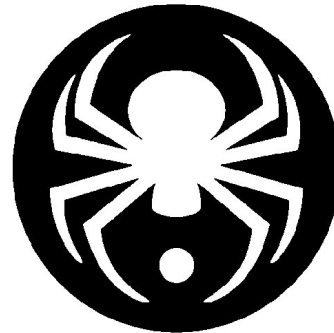
**CLASS 35—ADVERTISING AND BUSINESS**

FOR PROMOTING, ADVERTISING AND MARKETING OF THE ON-LINE WEBSITES OF OTHERS; RETAIL STORE SERVICES FEATURING COMPUTERS AND COMPUTER RELATED EQUIPMENT; ONLINE RETAIL STORE SERVICES FEATURING COMPUTERS AND COMPUTER RELATED EQUIPMENT; ADVERTISING SERVICES, NAMELY, CREATING CORPORATE IDENTITY AND PREPARING ADVERTISEMENTS FOR OTHERS (U.S. CLS. 100, 101 AND 102).
FIRST USE 9-1-2003; IN COMMERCE 1-1-2004.

CLASS 42—SCIENTIFIC, COMPUTER AND LEGAL SERVICES

FOR COMPUTER CONSULTING SERVICES, NAMELY, DESIGNING AND IMPLEMENTING WEB SITES FOR OTHERS; WEBSITE HOSTING; HOSTING OF DIGITAL CONTENT ON THE INTERNET; TECHNICAL SUPPORT SERVICES, NAMELY, TROUBLESHOOTING OF COMPUTER HARDWARE AND COMPUTER-RELATED EQUIPMENT PROBLEMS (U.S. CLS. 100 AND 101).

FIRST USE 9-1-2003; IN COMMERCE 1-1-2004.
LINDA LAVACHE, EXAMINING ATTORNEY

SN 78-751,765. IMAGINATION HOLDINGS PTY LTD, KENT TOWN, AUSTRALIA, FILED 11-10-2005.

GENDER DEFENDER

THE MARK CONSISTS OF STANDARD CHARACTERS WITHOUT CLAIM TO ANY PARTICULAR FONT, STYLE, SIZE, OR COLOR.

CLASS 9—ELECTRICAL AND SCIENTIFIC APPARATUS

FOR PRE-RECORDED DVDS AND CD-ROMS CONTAINING GAMES, BOARD GAMES, INTERACTIVE VIDEO GAMES, VIDEO GAMES, DVD GAMES, GAME SHOWS, AND GAMES CONTAINING INTERACTIVE QUESTIONS AND ANSWERS, AND INSTRUCTIONAL MANUALS SOLD AS A UNIT; VIDEO GAME PROGRAMS BASED ON TELEVISION SHOWS, CARTOON AND FILMS; MULTIMEDIA DVD GAME PROGRAMS THAT MAY BE PLAYED VIA A DVD MACHINE, COMPUTER AND TELEVISION OR COMPUTER MONITOR; SOFTWARE, NAMELY MULTIMEDIA GAME SOFTWARE RECORDED ON DVD OR CD-ROM (U.S. CLS. 21, 23, 26, 36 AND 38).

CLASS 28—TOYS AND SPORTING GOODS

FOR TOYS, PLAYTHINGS AND GAMES, NAMELY BOARD GAMES, PARTY GAMES AND PARLOR GAMES AND EQUIPMENT SOLD AS A UNIT FOR PLAYING SUCH GAMES; INTERACTIVE GAMES, NAMELY BOARD GAMES, CARD GAMES THAT MAY BE PLAYED VIA A DVD MACHINE, COMPUTER AND TELEVISION OR COMPUTER MONITOR AND THAT COMPRISE COMPONENT PIECES, NAMELY GAME BOARDS, CARDS AND GAME EQUIPMENT SOLD AS A UNIT (U.S. CLS. 22, 23, 38 AND 50).

GISELLE AGOSTO, EXAMINING ATTORNEY

SN 78-752,065. AMYLEX CORPORATION, PETALUMA, CA, FILED 11-11-2005.

TECHNOLOGY ALIGNED WITH NATURE

THE MARK CONSISTS OF STANDARD CHARACTERS WITHOUT CLAIM TO ANY PARTICULAR FONT, STYLE, SIZE, OR COLOR.

CLASS 16—PAPER GOODS AND PRINTED MATTER

FOR BIODEGRADABLE PACKAGING FOR FOOD AND BEVERAGES MADE FROM A COMPOSITE OF STARCHES AND GRAIN MEAL, NAMELY, HINGE LID CONTAINERS, BOXES, TRAYS, AND CARRY-OUT CARTONS; BIODEGRADABLE PACKAGING FOR COMMERCIAL AND INDUSTRIAL USE MADE FROM A COMPOSITE OF STARCHES AND GRAIN MEAL, NAMELY, BOXES AND INSERTS FOR COOKIE PACKAGING (U.S. CLS. 2, 5, 22, 23, 29, 37, 38 AND 50).

CLASS 21—HOUSEWARES AND GLASS

FOR BIODEGRADABLE CONTAINERS FOR HOUSEHOLD USE; BIODEGRADABLE CONTAINERS FOR HOUSEHOLD USE, NAMELY BOWLS, PLATES, CUPS, AND PORTION CUPS (U.S. CLS. 2, 13, 23, 29, 30, 33, 40 AND 50).

HEATHER SAPP, EXAMINING ATTORNEY

SN 78-752,399. ZIMMER TECHNOLOGY, INC., CHICAGO, IL, FILED 11-11-2005.

ELDERS IN MOTION

THE MARK CONSISTS OF STANDARD CHARACTERS WITHOUT CLAIM TO ANY PARTICULAR FONT, STYLE, SIZE, OR COLOR.

CLASS 16—PAPER GOODS AND PRINTED MATTER

FOR PRINTED MATERIALS, NAMELY, TRAINING MANUALS, COURSE MATERIALS, INFORMATION BOOKLETS, BROCHURES AND PAMPHLETS IN THE FIELD OF ORTHOPAEDIC SURGERY, PRINTED EDUCATIONAL MATERIALS, NAMELY BROCHURES, PAMPHLETS, AND BOOKS, FOR USE IN AN EDUCATIONAL PROGRAM IN THE FIELD OF ORTHOPAEDIC SURGERY, FOR CONSUMERS (U.S. CLS. 2, 5, 22, 23, 29, 37, 38 AND 50).

CLASS 41—EDUCATION AND ENTERTAINMENT

FOR EDUCATIONAL SERVICES, NAMELY, CONDUCTING CONFERENCES, SEMINARS, WORKSHOPS AND CLASSES IN THE FIELD OF ORTHOPAEDIC SURGERY (U.S. CLS. 100, 101 AND 107).

STEVEN JACKSON, EXAMINING ATTORNEY

SN 78-752,518. HYI, COVINA, CA. FILED 11-11-2005.



THE MARK CONSISTS OF A STYLIZED FISH, FACING LEFT, WITH FEROCIOUS-LOOKING TEETH WITH THE WORDS/NUMBER OF "OPENWATER 606" BELOW IT.

CLASS 8—HAND TOOLS

FOR HAND TOOLS, NAMELY, BILLY CLUBS, KNIVES, KNIFE SHEATHS, PLIERS, FORCEPS, CRIMPERS AND FISHING LINE CUTTERS (U.S. CLS. 23, 28 AND 44).

FIRST USE 10-12-2005; IN COMMERCE 10-12-2005.

CLASS 9—ELECTRICAL AND SCIENTIFIC APPARATUS

FOR ELECTRICAL AND SCIENTIFIC APPARATUS, NAMELY, SUNGLASSES AND STRAPS (U.S. CLS. 21, 23, 26, 36 AND 38).

FIRST USE 10-12-2005; IN COMMERCE 10-12-2005.

CLASS 18—LEATHER GOODS

FOR NON-LEATHER ALL PURPOSE ATHLETIC BAGS, NAMELY NYLON ALL-PURPOSE ATHLETIC BAGS; NON-LEATHER BACKPACKS, NAMELY NYLON BACKPACKS (U.S. CLS. 1, 2, 3, 22 AND 41).

FIRST USE 10-12-2005; IN COMMERCE 10-12-2005.

CLASS 28—TOYS AND SPORTING GOODS

FOR SPORTING GOODS, NAMELY, FISHING TACKLE BAGS, FISHING TACKLE BOXES, UTILITY BOXES FOR FISHING WEIGHTS, FISHING LURES AND FISHING HOOKS, FISHING REEL COVERS, FISHING ROD HOLDERS, FISHING ROD GUARDS, FISHING ROD WRAPS AND NON-LEATHER FISHING JIG TUBE BAGS (U.S. CLS. 22, 23, 38 AND 50).

FIRST USE 10-12-2005; IN COMMERCE 10-12-2005.

MYRIAH HABEEB, EXAMINING ATTORNEY

SN 78-752,636. FLEETCOR TECHNOLOGIES OPERATING COMPANY, LLC, NORCROSS, GA. FILED 11-11-2005.

YOUR COMPLETE FLEET
PURCHASING CARD PROGRAM

THE MARK CONSISTS OF STANDARD CHARACTERS WITHOUT CLAIM TO ANY PARTICULAR FONT, STYLE, SIZE, OR COLOR.

CLASS 35—ADVERTISING AND BUSINESS

FOR RETAIL GASOLINE SUPPLY SERVICES FOR MOTOR VEHICLE FLEET OWNERS; PREPARING BUSINESS REPORTS FOR THE TRANSPORTATION AND VEHICLE FLEET INDUSTRIES; BILLING AND DATA PROCESSING SERVICES FOR THE TRANSPORTATION AND VEHICLE FLEET INDUSTRIES; BUSINESS MANAGEMENT, INVENTORY CONTROL, AND BOOKKEEPING FOR TRANSPORTATION AND VEHICLE FLEET INDUSTRIES; AND WHOLESALE DISTRIBUTORSHIPS FEATURING MOTOR VEHICLE FUELS, LUBRICANTS, AND PETROLEUM PRODUCTS (U.S. CLS. 100, 101 AND 102).

FIRST USE 7-5-2005; IN COMMERCE 7-5-2005.

CLASS 36—INSURANCE AND FINANCIAL

FOR PROVIDING PAYMENT SERVICES FOR PURCHASING MOTOR FUELS, PETROLEUM PRODUCTS AND OTHER VEHICLE RELATED GOODS AND SERVICES (U.S. CLS. 100, 101 AND 102).

FIRST USE 7-5-2005; IN COMMERCE 7-5-2005.

CLASS 37—CONSTRUCTION AND REPAIR

FOR MOTOR FUEL AND VEHICLE MAINTENANCE SERVICES TO VEHICLE FLEET OWNERS IN THE NATURE OF AUTOMOBILE SERVICE STATIONS (U.S. CLS. 100, 103 AND 106).

FIRST USE 7-5-2005; IN COMMERCE 7-5-2005.

KAREN K. BUSH, EXAMINING ATTORNEY

SN 78-753,253. AMERICAN FLATBREAD HOLDING COMPANY, WAITSFIELD, VT. FILED 11-14-2005.

THE FIVE FACES OF FOOD

THE MARK CONSISTS OF STANDARD CHARACTERS WITHOUT CLAIM TO ANY PARTICULAR FONT, STYLE, SIZE, OR COLOR.

NO CLAIM IS MADE TO THE EXCLUSIVE RIGHT TO USE "FOOD", APART FROM THE MARK AS SHOWN.

CLASS 30—STAPLE FOODS

FOR PREPARED FOODS, NAMELY FRESH AND FROZEN FLATBREAD PIZZA (U.S. CL. 46).

FIRST USE 12-31-1994; IN COMMERCE 12-31-1994.

CLASS 43—HOTEL AND RESTAURANT SERVICES

FOR RESTAURANT SERVICES; TAKE-OUT RESTAURANT SERVICES; CATERING SERVICES; BAR SERVICES (U.S. CLS. 100 AND 101).

FIRST USE 12-31-1994; IN COMMERCE 12-31-1994.

GEOFFREY FOSDICK, EXAMINING ATTORNEY

SN 78-753,756. IMAGINATION HOLDINGS PTY LTD, KENT TOWN, AUSTRALIA, FILED 11-14-2005.

LITERATI

THE MARK CONSISTS OF STANDARD CHARACTERS WITHOUT CLAIM TO ANY PARTICULAR FONT, STYLE, SIZE, OR COLOR.

CLASS 9—ELECTRICAL AND SCIENTIFIC APPARATUS

FOR PRE-RECORDED DVDS AND CD-ROMS CONTAINING GAMES, BOARD GAMES, INTERACTIVE VIDEO GAMES, VIDEO GAMES, COMPUTER GAMES, GAME SHOWS, AND GAMES CONTAINING INTERACTIVE QUESTIONS AND ANSWERS, AND INSTRUCTION MANUALS SOLD AS A UNIT; VIDEO GAME PROGRAMS BASED ON TELEVISION SHOWS, CARTOON AND FILMS; MULTIMEDIA COMPUTER GAME PROGRAMS THAT MAY BE PLAYED VIA A DVD MACHINE, COMPUTER AND TELEVISION OR COMPUTER MONITOR; SOFTWARE, NAMELY, MULTIMEDIA GAME SOFTWARE RECORDED ON DVD OR CD-ROM (U.S. CLS. 21, 23, 26, 36 AND 38).

CLASS 28—TOYS AND SPORTING GOODS

FOR TOYS, PLAYTHINGS AND GAMES, NAMELY BOARD GAMES, PARTY GAMES AND PARLOR GAMES AND EQUIPMENT SOLD AS A UNIT FOR PLAYING SUCH GAMES; INTERACTIVE GAMES, NAMELY BOARD GAMES AND CARD GAMES, THAT MAY BE PLAYED VIA A DVD MACHINE, COMPUTER AND TELEVISION OR COMPUTER MONITOR AND GAME EQUIPMENT SOLD AS A UNIT (U.S. CLS. 22, 23, 38 AND 50).

GISELLE AGOSTO, EXAMINING ATTORNEY

SN 78-754,086. IVAX INTERNATIONAL B.V., WATERFORD, IRELAND, FILED 11-15-2005.

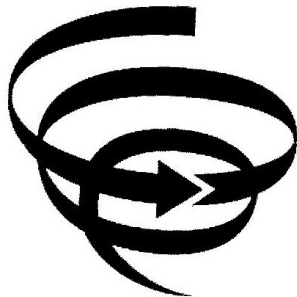

CLASS 5—PHARMACEUTICALS

FOR INHALERS FILLED WITH MOLECULES TARGETED TO BE ADMINISTERED BY INHALATION, NAMELY CORTICOSTEROIDS, BETA AGONISTS, CROMOGLYCATES, ANTICHOLINERGICS, PROTEINS AND POLYPEPTIDES FOR THE TREATMENT OF RESPIRATORY DISEASES AND OTHER DISEASES, NAMELY, DIABETES MELLITUS, EOSINOPHILIC ESOPHAGITIS WHERE DRUG ADMINISTRATION BY INHALATION IS APPROPRIATE (U.S. CLS. 6, 18, 44, 46, 51 AND 52).

CLASS 10—MEDICAL APPARATUS

FOR MEDICAL APPARATUS FOR FACILITATING THE INHALATION OF PHARMACEUTICAL PREPARATIONS; INHALERS FOR MEDICAL PURPOSES, SOLD EMPTY; METERED DOSE INHALERS FOR MEDICAL PURPOSES, SOLD EMPTY; DRY POWDER INHALERS FOR MEDICAL PURPOSES, SOLD EMPTY; AEROSOL INHALERS FOR MEDICAL PURPOSES, SOLD EMPTY; AQUEOUS INHALERS FOR MEDICAL PURPOSES, SOLD EMPTY; ALL FOR THE TREATMENT OF RESPIRATORY CONDITIONS OR AILMENTS; NEBULIZERS FOR RESPIRATION THERAPY; PARTS, COMPONENTS AND FITTINGS FOR THE AFORESAID GOODS (U.S. CLS. 26, 39 AND 44).

ANN E. SAPPENFIELD, EXAMINING ATTORNEY

SN 78-754,340. ANDREAE, GILES, LONDON, ENGLAND, FILED 11-15-2005.

EDWARD MONKTON

THE MARK CONSISTS OF STANDARD CHARACTERS WITHOUT CLAIM TO ANY PARTICULAR FONT, STYLE, SIZE, OR COLOR.

PRIORITY CLAIMED UNDER SEC. 44(D) ON UNITED KINGDOM APPLICATION NO. 2392466, FILED 5-20-2005, REG. NO. 2392466, DATED 5-20-2005, EXPIRES 5-20-2015.

THE MARK DOES NOT IDENTIFY A LIVING INDIVIDUAL.

CLASS 3—COSMETICS AND CLEANING PREPARATIONS

FOR PERFUME, TOILET WATER; BATH GEL, SHOWER GEL, TOILET SOAPS; DEODORANT FOR BODY CARE; COSMETICS, NAMELY MAKE-UP, NAIL VARNISH AND NAIL POLISH; CREAMS, MILKS, LOTIONS, GELS AND POWDERS FOR THE FACE, THE BODY AND THE HANDS; SUN CARE PREPARATIONS, NAMELY, SUN BLOCK, SUN SCREEN, SUN CREAMS, AND AFTER SUN CREAMS; MAKE-UP PREPARATIONS; HAIR SHAMPOOS; BODY SHAMPOOS, NON-MEDICATED GELS, SPRAYS, MOUSSES AND BALMS FOR HAIR STYLING AND HAIR CARE; HAIR LACQUERS; HAIR COLORING AND HAIR DECOLORANT PREPARATION; ESSENTIAL OILS FOR PERSONAL USE; AND DENTIFRICES (U.S. CLS. 1, 4, 6, 50, 51 AND 52).

CLASS 4—LUBRICANTS AND FUELS

FOR CANDLES; TEA LIGHTS; ROOM SCENTERS NAMELY SCENTED CANDLES; LAMP OILS; WAX FILLED POTS; WAX FILLED JARS; CANDLES IN TINS (U.S. CLS. 1, 6 AND 15).

CLASS 6—METAL GOODS

FOR KEY RINGS OF COMMON METAL (U.S. CLS. 2, 12, 13, 14, 23, 25 AND 50).

CLASS 9—ELECTRICAL AND SCIENTIFIC APPARATUS

FOR PRERECORDED VIDEOTAPES, VIDEODISCS, DIGITAL VIDEODISCS, COMPACT DISCS, PRERECORDED AUDIOTAPES, ALL FEATURING MUSIC AND SOUND RECORDINGS IN THE FIELD OF ANIMATION, CARTOONS, AND COMEDY; MULTI-MEDIA SOFTWARE RECORDED ON CD-ROMS FOR ENTERTAINMENT FEATURING ANIMATION, CARTOONS AND COMEDY; MULTI-MEDIA SOFTWARE RECORDED ON MINI DISCS FOR ENTERTAINMENT FEATURING ANIMATION, CARTOONS, AND COMEDY; COMPACT DISC HOLDERS, ENTERTAINMENT COMPUTER SOFTWARE, NAMELY COMPUTER GAME SOFTWARE, DOWNLOADABLE ENTERTAINMENT SOFTWARE FOR ENTERTAINMENT CONTAINING ANIMATION, CARTOONS AND COMEDY PROVIDED VIA ON-LINE DATABASES, THE INTERNET AND WEBSITES; DOWNLOADABLE ELECTRONIC PUBLICATIONS IN THE NATURE OF MAGAZINES, NEWSLETTERS, COMIC BOOKS AND COMIC STRIPS IN THE FIELD OF ANIMATION, CARTOONS AND COMEDY THAT ARE PROVIDED VIA ON-LINE DATABASES, THE INTERNET AND WEBSITES; PRERECORDED VIDEOTAPES FEATURING ANIMATED CARTOONS; CALCULATORS; RADIO PAGERS; SUNGLASSES; SUNGLASS CASES; SUNGLASS CHAINS; COMPUTER GAME PROGRAMS; COMPUTER GAME CARTRIDGES; COMPUTER GAME CASSETTES; COMPUTER GAME TAPES; COMPUTER PROGRAMS, NAMELY SCREEN SAVERS; MOUSEPADS, DECORATIVE REFRIGERATOR MAGNETS (U.S. CLS. 21, 23, 26, 36 AND 38).

CLASS 14—JEWELRY

FOR PRECIOUS METAL JEWELRY BOXES, PRECIOUS METAL MONEY CLIPS, COSTUME JEWELRY; CLOCKS; WATCHES, STOPWATCHES, ALARM CLOCKS, WATCH STRAPS; BELT BUCKLES OF PRECIOUS METAL; TIE CLIPS; CUFFLINKS; TIE PINS (U.S. CLS. 2, 27, 28 AND 50).

CLASS 16—PAPER GOODS AND PRINTED MATTER

FOR PRINTED MATTER, NAMELY BOOKS IN THE FIELD OF HUMOR; COMIC BOOKS; CALENDARS; STATIONERY; POSTERS; STICKERS; GREETING CARDS; MOUNTED AND UNMOUNTED PHOTOGRAPHS; DECALOMANIAS; WRAPPING PAPER AND PACKAGING MATERIALS, NAMELY CARDBOARD BOXES AND PAPER GIFT BAGS, SOLD EMPTY; PENS; PENCILS; ERASER; PRINTED INVITATIONS, WRITING PAPER; POSTCARDS; ADDRESS BOOKS; NOTEBOOKS; DIARIES, AND CARTOON STRIP (U.S. CLS. 2, 5, 22, 23, 29, 37, 38 AND 50).

CLASS 18—LEATHER GOODS

FOR LEATHER PURSES, LEATHER COLLARS FOR PETS, LEATHER ATTACHE CASES, LEATHER BRIEFCASES, LEATHER RUCKSACKS, LEATHER BACKPACKS, LEATHER HANDBAGS, LEATHER HAVERSACKS, LEATHER SATCHELS, LEATHER SHOPPING BAGS, LEATHER SUITCASES, LEATHER TRAVELING BAGS, LEATHER SUITCASES, LEATHER BOOK BAGS, HANDBAGS, LUGGAGE, CREDIT CARD CASES, BUSINESS CARD CASES, WALLETS, PURSES, BACKPACKS, FANNY PACKS, KEY CASES, AND UMBRELLAS (U.S. CLS. 1, 2, 3, 22 AND 41).

CLASS 20—FURNITURE AND ARTICLES NOT OTHERWISE CLASSIFIED

FOR NON-METALLIC KEY RINGS; LEATHER KEY RINGS (U.S. CLS. 2, 13, 22, 25, 32 AND 50).

CLASS 21—HOUSEWARES AND GLASS

FOR CONTAINERS FOR HOUSEHOLD OR KITCHEN USE; FLASKS, SPORTS BOTTLES SOLD EMPTY; HAIR COMBS; BODY SPONGES, FACIAL SPONGES FOR APPLYING MAKE-UP; HAIRBRUSHES, TOILET BRUSHES, SHOE BRUSHES, SCRUBBING BRUSHES, SHAVING BRUSHES; GLASSWARE, NAMELY, DRINKING GLASSES, SHOT GLASSES, TUMBLERS, MUGS, HIGHBALL GLASSES, FREEZER MUGS, TANKARDS, AND DRINKING STEMS; CANDLESTICKS NOT OF PRECIOUS METAL, CHINA ORNAMENTS, CORK-SCREWS, CROCKERY, NAMELY, PLATES, BOWLS, SAUCERS; MUGS, DRINKING GLASSES, SIDE PLATES, EGG CUPS, FIGURINES MADE OF CHINA, CRYSTAL, EARTHENWARE, GLASS, PORCELAIN, CERAMIC AND MELANITE; LUNCH BOXES; NON-METAL PIGGY BANKS; POTTERY, NAMELY MUGS, PLATES, BOWLS, CUPS, SIDE PLATES AND SAUCERS; SOAP DISPENSERS AND MANUAL TOOTHBRUSHES (U.S. CLS. 2, 13, 23, 29, 30, 33, 40 AND 50).

CLASS 24—FABRICS

FOR CURTAINS, FABRIC VALANCES, TABLECLOTHS NOT MADE OF PAPER, BEDSHEETS, BED SPREADS, DUVET COVERS, BATH LINEN, BED LINEN, COASTERS IN THE FORM OF TABLE LINEN, FLANNEL, HANDKERCHIEFS, HOUSEHOLD LINEN, TOWELS, TEA TOWELS (U.S. CLS. 42 AND 50).

CLASS 25—CLOTHING

FOR T-SHIRTS, SWEATSHIRTS, TOPS, TROUSERS, SHORTS, SOCKS, JACKETS, SWEATERS, BOXER SHORTS, UNDERPANTS, VESTS, TIES, SCARVES, FOOTWEAR, HEADWEAR; BELTS; SWIMWEAR; UNDERWEAR; KITCHEN APRONS (U.S. CLS. 22 AND 39).

CLASS 28—TOYS AND SPORTING GOODS

FOR CARD GAMES, BOARD GAMES, ACTION SKILL GAMES, MECHANICAL ACTION TOYS, BATH TOYS, INFANT TOYS, SOFT TOYS, NAMELY PLUSH TOYS, DOLLS AND ACCESSORIES; DECORATIONS FOR CHRISTMAS TREES (U.S. CLS. 22, 23, 38 AND 50).

CLASS 30—STAPLE FOODS

FOR CAKES, BISCUITS, COOKIES, READY TO EAT CEREAL DERIVED FOOD BARS, CANDY, MUFFINS, DONUTS, COCOA, FLAVORED ICES, HONEY, TREATLE, CONDIMENTS, NAMELY, SAUCES; SUGAR CONFECTIONERY; CHEESE FLAVORED PUFFED CORN SNACKS, PUFFED CORN SNACKS, AND PREPARED MEALS CONSISTING PRIMARILY OF PASTA OR RICE (U.S. CL. 46).

GENE MACIOL, EXAMINING ATTORNEY

SN 78-756,816. MALEK, GREGORY, BROOKLYN, NY.
FILED 11-18-2005.



THE MARK CONSISTS OF UNLIKE WORD WITH SLANTED RECTANGLE IN K.

CLASS 25—CLOTHING

FOR CAPS; HATS; JACKETS; PANTS; SHIRTS; SHOES; SNEAKERS (U.S. CLS. 22 AND 39).

CLASS 35—ADVERTISING AND BUSINESS

FOR ADVERTISING, MARKETING AND PROMOTION SERVICES (U.S. CLS. 100, 101 AND 102).
PETER CHENG, EXAMINING ATTORNEY

CLASS 21—HOUSEWARES AND GLASS

FOR CONTAINERS FOR HOUSEHOLD AND KITCHEN USE NOT OF PRECIOUS METAL; HOUSEHOLD AND KITCHEN UTENSILS, NAMELY, GARLIC PRESSES, EGG SEPARATORS, TART CUTTERS, BAKING PROBES IN THE NATURE OF CAKE TESTERS, GRATERS, ONION HOLDERS, FOOD AND PASTRY BRUSHES FOR BASTING, HAND PRESSES FOR DISPENSING AND DECORATING FOOD, POT AND PAN SCRAPERS, FOOD SCRAPERS, SPATULAS, SCOOPS, SPOONS, NAMELY, MIXING, SERVING AND SLOTTED SPOONS, FOOD MASHERS, KITCHEN LADLES, WHISKS, HOUSEHOLD UTENSILS, NAMELY TURNERS, DOUGH ROLLING PINS; CUTTING BOARDS; PASTRY BOARDS; JAR OPENERS; CORN COB HOLDERS; BUTTER DISPENSERS; FOOD SHAKERS FOR DISPENSING SEASONINGS, SPICES AND FLOUR; PITCHERS; BOWLS; SERVING PLATTERS; COOKWARE, NAMELY, POTS, MEAL COOKING PANS, GLASS COOKING PANS, POT LIDS AND POT COVERS; CROCKS; BAKEWARE, NAMELY, FOOD MOLDS, BREAD MOLDS, COOKIE MOLDS; BAKING RACKS; COOLING RACKS; SPRING FORM PANS; MUFFIN PANS; BAKING SHEETS; PIE PANS; PIE PLATES; CAKE PANS; LOAF PANS; TRIVETS; SALT MILLS; PEPPER MILLS; KITCHEN TOOL ORGANIZERS, NAMELY, CONTAINERS NOT OF PRECIOUS METAL FOR ORGANIZING HOUSEHOLD AND KITCHEN UTENSILS; SOAP DISPENSERS; FOOD STRAINERS; STONWARE, NAMELY, BOWLS, PIE PLATES, BAKING PANS, ROASTING PANS AND BAKING SHEETS; BAKING DISHES; BAKING PANS; ROASTING PANS; PLATES; CORKSCREWS; NON-ELECTRIC PASTRY BLENDERS; COLANDERS FOR HOUSEHOLD USE; NON-ELECTRIC JUICERS; PASTRY CUTTERS (U.S. CLS. 2, 13, 23, 29, 30, 33, 40 AND 50).

SN 78-757,369. COLUMBIA INSURANCE COMPANY, OMAHA, NE. FILED 11-18-2005.



The Pampered Chef
discover the chef in you

OWNER OF U.S. REG. NOS. 1,627,989, 2,542,543 AND OTHERS.

CLASS 8—HAND TOOLS

FOR HAND TOOLS AND IMPLEMENTS, NAMELY, KITCHEN KNIVES, NON-ELECTRIC FRUIT AND VEGETABLE PEELERS, HAND OPERATED FOOD SLICERS AND CHOPPERS, PIZZA CUTTERS, NON-ELECTRIC CAN OPENERS, FRUIT ZESTERS, FRUIT SCORERS, FRUIT AND VEGETABLE CORERS, SCISSORS, GARNISHERS, KNIFE SHARPENERS, WEDGERS, TONGS, FORKS, CUTLERY, NAMELY, STEAK KNIVES (U.S. CLS. 23, 28 AND 44).

CLASS 9—ELECTRICAL AND SCIENTIFIC APPARATUS

FOR PRE-RECORDED AUDIO AND VIDEO CASSETTES FEATURING COOKING; FOOD THERMOMETERS; MEASURING SPOONS; MEASURING CUPS; FOOD SCALES; KITCHEN TIMERS (U.S. CLS. 21, 23, 26, 36 AND 38).

CLASS 16—PAPER GOODS AND PRINTED MATTER

FOR COOKBOOKS; CATALOGS AND BROCHURES FEATURING HOUSEHOLD AND KITCHEN UTENSILS AND RECIPES; PRINTED RECIPES ON CARDS; PARCHMENT PAPER (U.S. CLS. 2, 5, 22, 23, 29, 37, 38 AND 50).

CLASS 24—FABRICS

FOR OVEN MITTS; BARBECUE MITTS; HOT MITTS IN THE NATURE OF POT HOLDERS (U.S. CLS. 42 AND 50).

CLASS 29—MEATS AND PROCESSED FOODS

FOR EDIBLE OILS AND SOUP MIXES (U.S. CL. 46).

CLASS 30—STAPLE FOODS

FOR SPECIALTY FOOD ITEMS, NAMELY, VINEGARS, CAKE MIXES, MIXES FOR MAKING BAKERY GOODS, SPICES, SEASONINGS, EXTRACTS USED AS FOOD FLAVORINGS, SAUCES, SALSAS, SALAD DRESSINGS; PREPARATIONS FOR MAKING COFFEE, NAMELY COFFEE BEANS; PREPARATIONS FOR MAKING TEA, NAMELY TEA; PREPARATIONS FOR MAKING COCOA, NAMELY COCOA AND COCOA MIXES (U.S. CL. 46).

CLASS 35—ADVERTISING AND BUSINESS

FOR SHOP-AT-HOME PARTY SERVICES IN THE FIELD OF HOUSEWARES, HOUSEHOLD AND KITCHEN UTENSILS, KITCHEN HAND TOOLS AND IMPLEMENTS, PRINTED MATTER, NAMELY, COOKBOOKS AND PRINTED RECIPES ON CARDS, PRE-RECORDED VIDEO TAPES AND FOOD (U.S. CLS. 100, 101 AND 102).
KIMBERLY FRYE, EXAMINING ATTORNEY

SN 78-757,472. COLUMBIA INSURANCE COMPANY, OMAHA, NE. FILED 11-18-2005.



OWNER OF U.S. REG. NOS. 1,627,989, 2,542,543 AND OTHERS.

THE FOREIGN WORDING IN THE MARK TRANSLATES INTO ENGLISH AS "DISCOVER THE CHEF IN YOU".

CLASS 8—HAND TOOLS

FOR HAND TOOLS AND IMPLEMENTS, NAMELY, KITCHEN KNIVES, NON-ELECTRIC FRUIT AND VEGETABLE PEELERS, HAND OPERATED FOOD SLICERS AND CHOPPERS, PIZZA CUTTERS, NON-ELECTRIC CAN OPENERS, FRUIT ZESTERS, FRUIT SCORERS, FRUIT AND VEGETABLE CORERS, SCISSORS, GARNISHERS, KNIFE SHARPENERS, WEDGERS, TONGS, FORKS, CUTLERY, NAMELY, STEAK KNIVES (U.S. CLS. 23, 28 AND 44).

CLASS 9—ELECTRICAL AND SCIENTIFIC APPARATUS

FOR PRE-RECORDED AUDIO AND VIDEO CASSETTES FEATURING COOKING; FOOD THERMOMETERS; MEASURING SPOONS; MEASURING CUPS; FOOD SCALES; KITCHEN TIMERS (U.S. CLS. 21, 23, 26, 36 AND 38).

CLASS 16—PAPER GOODS AND PRINTED MATTER

FOR COOKBOOKS; CATALOGS AND BROCHURES FEATURING HOUSEHOLD AND KITCHEN UTENSILS AND RECIPES; PRINTED RECIPES ON CARDS; PARCHMENT PAPER (U.S. CLS. 2, 5, 22, 23, 29, 37, 38 AND 50).

CLASS 21—HOUSEWARES AND GLASS

FOR CONTAINERS FOR HOUSEHOLD AND KITCHEN USE NOT OF PRECIOUS METAL; HOUSEHOLD AND KITCHEN UTENSILS, NAMELY, GARLIC PRESSES, EGG SEPARATORS, TART CUTTERS, BAKING PROBES IN THE NATURE OF CAKE TESTERS, GRATERS, ONION HOLDERS, FOOD AND PASTRY BRUSHES FOR BASTING, HAND PRESSES FOR DISPENSING AND DECORATING FOOD, POT AND PAN SCRAPERS, FOOD SCRAPERS, SPATULAS, SCOOPS, SPOONS, NAMELY, MIXING, SERVING AND SLOTTED SPOONS, FOOD MASHERS, KITCHEN LADLES, WHISKS, HOUSEHOLD UTENSILS, NAMELY TURNERS, DOUGH ROLLING PINS; CUTTING BOARDS; PASTRY BOARDS; JAR OPENERS; CORN COB HOLDERS; BUTTER DISPENSERS; FOOD SHAKERS FOR DISPENSING SEASONINGS, SPICES AND FLOUR; PITCHERS; BOWLS; SERVING PLATTERS; COOKWARE, NAMELY, POTS, MEAL COOKING PANS, GLASS COOKING PANS, POT LIDS AND POT COVERS; CROCKS; BAKEWARE, NAMELY, FOOD MOLDS, BREAD MOLDS, COOKIE MOLDS; BAKING RACKS; COOLING RACKS; SPRING FORM PANS; MUFFIN PANS; BAKING SHEETS; PIE PANS; PIE PLATES; CAKE PANS; LOAF PANS; TRIVETS; SALT MILLS; PEPPER MILLS; KITCHEN TOOL ORGANIZERS, NAMELY, CONTAINERS NOT OF PRECIOUS METAL FOR ORGANIZING HOUSEHOLD AND KITCHEN UTENSILS; SOAP DISPENSERS; FOOD STRAINERS; STONWARE, NAMELY, BOWLS, PIE PLATES, BAKING PANS, ROASTING PANS AND BAKING SHEETS; BAKING DISHES; BAKING PANS; ROASTING PANS; PLATES; CORKSCREWS; NON-ELECTRIC PASTRY BLENDERS; COLANDERS FOR HOUSEHOLD USE; NON-ELECTRIC JUICERS; PASTRY CUTTERS (U.S. CLS. 2, 13, 23, 29, 30, 33, 40 AND 50).

CLASS 24—FABRICS

FOR OVEN MITTS; BARBECUE MITTS; HOT MITTS IN THE NATURE OF POT HOLDERS (U.S. CLS. 42 AND 50).

CLASS 29—MEATS AND PROCESSED FOODS

FOR EDIBLE OILS AND SOUP MIXES (U.S. CL. 46).

CLASS 30—STAPLE FOODS

FOR SPECIALTY FOOD ITEMS, NAMELY, VINEGARS, CAKE MIXES, MIXES FOR MAKING BAKERY GOODS, SPICES, SEASONINGS, EXTRACTS USED AS FOOD FLAVORINGS, SAUCES, SALSAS, SALAD DRESSINGS; PREPARATIONS FOR MAKING COFFEE, NAMELY COFFEE BEANS; PREPARATIONS FOR MAKING TEA, NAMELY TEA; PREPARATIONS FOR MAKING COCOA, NAMELY COCOA AND COCOA MIXES (U.S. CL. 46).

CLASS 35—ADVERTISING AND BUSINESS

FOR SHOP-AT-HOME PARTY SERVICES IN THE FIELD OF HOUSEWARES, HOUSEHOLD AND KITCHEN UTENSILS, KITCHEN HAND TOOLS AND IMPLEMENTS, PRINTED MATTER, NAMELY, COOKBOOKS AND PRINTED RECIPES ON CARDS, PRE-RECORDED VIDEO TAPES AND FOOD (U.S. CLS. 100, 101 AND 102).
KIMBERLY FRYE, EXAMINING ATTORNEY

SN 78-758,395. DAIRY BARN STORES, INC., EAST NORTH-PORT, NY. FILED 11-21-2005.

SN 78-760,020. YUEN CHI GEAR CO., LTD., TAIPEI HSIEN, TAIWAN, FILED 11-23-2005.

DAIRY BARN

JustPull

THE MARK CONSISTS OF STANDARD CHARACTERS WITHOUT CLAIM TO ANY PARTICULAR FONT, STYLE, SIZE, OR COLOR.

OWNER OF U.S. REG. NOS. 791,939 AND 942,983.
NO CLAIM IS MADE TO THE EXCLUSIVE RIGHT TO USE "DAIRY", APART FROM THE MARK AS SHOWN.

THE MARK CONSISTS OF STANDARD CHARACTERS WITHOUT CLAIM TO ANY PARTICULAR FONT, STYLE, SIZE, OR COLOR.

CLASS 6—METAL GOODS

FOR METAL ROLLING DOORS AND METAL ROLL SHUTTERS AND PARTS THEREFOR, NAMELY, SIDE BRACKETS, BARRELS, SHUTTER CASES, ROLLING CHAINS, GRAVITY DROP ROPES, HAND CHAINS, GUIDE RAILS, SHUTTER SLOTS AND BOTTOM RAILS, ALL OF THE FOREGOING OF METAL (U.S. CLS. 2, 12, 13, 14, 23, 25 AND 50).
FIRST USE 7-6-2005; IN COMMERCE 7-6-2005.

CLASS 29—MEATS AND PROCESSED FOODS

FOR MILK, EGGNOG (U.S. CL. 46).
FIRST USE 9-30-1960; IN COMMERCE 4-30-1964.

CLASS 30—STAPLE FOODS

FOR ICE CREAM, BREAD AND PREPARED COFFEE AND COFFEE-BASED BEVERAGES (U.S. CL. 46).
FIRST USE 9-30-1960; IN COMMERCE 4-30-1964.

CLASS 7—MACHINERY

FOR ROLLING DOOR MOTORS; WINCHES; CRANES; ELEVATORS (U.S. CLS. 13, 19, 21, 23, 31, 34 AND 35).
FIRST USE 7-6-2005; IN COMMERCE 7-6-2005.
DAVID MILLER, EXAMINING ATTORNEY

CLASS 32—LIGHT BEVERAGES

FOR JUICE, NAMELY, ORANGE JUICE, LEMONADE, FRUIT PUNCH AND APPLE CIDER (U.S. CLS. 45, 46 AND 48).
FIRST USE 9-30-1960; IN COMMERCE 4-30-1964.
TIMOTHY FINNEGAN, EXAMINING ATTORNEY

SN 78-760,111. MBG INTERNATIONAL PREMIUM BRANDS GMBH, PADERBORN, FED REP GERMANY, FILED 11-23-2005.

SN 78-760,005. YUEN CHI GEAR CO., LTD., TAIPEI HSIEN, TAIWAN, FILED 11-23-2005.

Belt Drivinator

effect

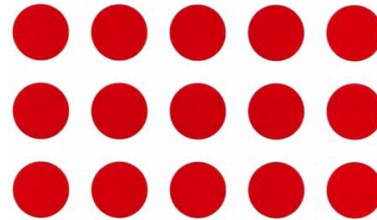

THE MARK CONSISTS OF STANDARD CHARACTERS WITHOUT CLAIM TO ANY PARTICULAR FONT, STYLE, SIZE, OR COLOR.

NO CLAIM IS MADE TO THE EXCLUSIVE RIGHT TO USE "BELT", APART FROM THE MARK AS SHOWN.

OWNER OF FED REP GERMANY REG. NO. 30526311, DATED 6-24-2005, EXPIRES 5-31-2015.

THE COLORS BLACK AND RED ARE CLAIMED AS A FEATURE OF THE MARK.

THE MARK CONSISTS OF WORDING IN BLACK AND CIRCLES IN RED.

CLASS 6—METAL GOODS

FOR METAL ROLLING DOORS AND METAL ROLL SHUTTERS AND PARTS THEREFOR, NAMELY, SIDE BRACKETS, BARRELS, SHUTTER CASES, ROLLING CHAINS, GRAVITY DROP ROPES, HAND CHAINS, GUIDE RAILS, SHUTTER SLOTS AND BOTTOM RAILS, ALL OF THE FOREGOING OF METAL (U.S. CLS. 2, 12, 13, 14, 23, 25 AND 50).
FIRST USE 7-6-2005; IN COMMERCE 7-6-2005.

CLASS 32—LIGHT BEVERAGES

FOR BEER; NONALCOHOLIC BEVERAGES, NAMELY, AERATED WATER, ENERGY DRINKS, FRUIT BEVERAGES, SOFT DRINKS, SPORTS DRINKS, TABLE WATER AND SPARKLING WATER (U.S. CLS. 45, 46 AND 48).

CLASS 7—MACHINERY

FOR ROLLING DOOR MOTORS; WINCHES; CRANES; ELEVATORS (U.S. CLS. 13, 19, 21, 23, 31, 34 AND 35).
FIRST USE 7-6-2005; IN COMMERCE 7-6-2005.
DAVID MILLER, EXAMINING ATTORNEY

CLASS 33—WINES AND SPIRITS

FOR DISTILLED SPIRITS; LIQUEURS; WINES (U.S. CLS. 47 AND 49).
ALICE SUE CARRUTHERS, EXAMINING ATTORNEY

SN 78-760,133. MOSSO, LTD., SAN ANTONIO, TX. FILED 11-23-2005.

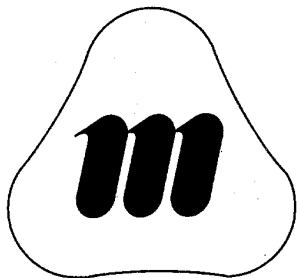

CLASS 35—ADVERTISING AND BUSINESS

FOR ADMINISTRATION, BILLING AND RECONCILIATION OF ACCOUNTS ON BEHALF OF OTHERS; CUSTOMER SERVICE IN THE FIELDS OF REGISTRATION OF DOMAIN NAMES, ADMINISTRATION, BILLING, AND RECONCILIATION OF ACCOUNTS, E-MAIL, AND WEB HOSTING; AND PROVIDING CUSTOMER SERVICE IN THE ABOVE FIELDS THAT ARE OFFERED TO THIRD PARTIES ON BEHALF OF OTHERS (U.S. CLS. 100, 101 AND 102).

FIRST USE 3-1-2006; IN COMMERCE 3-1-2006.

CLASS 38—COMMUNICATION

FOR PROVIDING E-MAIL SERVICES (U.S. CLS. 100, 101 AND 104).

FIRST USE 3-1-2006; IN COMMERCE 3-1-2006.

CLASS 42—SCIENTIFIC, COMPUTER AND LEGAL SERVICES

FOR REGISTRATION OF DOMAIN NAMES FOR IDENTIFICATION OF USERS ON THE INTERNET; HOSTING WEBSITES OF OTHERS ON COMPUTER SERVERS AND MANAGING THOSE SERVERS, ALSO KNOWN AS RESELLER WEB HOSTING, WHOLESALER WEB HOSTING, PRIVATE LABEL WEB HOSTING, OR VIRTUAL HOSTING; AND PROVIDING A WEBSITE FOR THE MANAGEMENT OF WEBSITES UPLOADED ONTO MANAGED SERVERS BY THIRD PARTIES SUCH AS WEBSITE DESIGNERS, DEVELOPERS, AND INTEGRATORS (U.S. CLS. 100 AND 101).

FIRST USE 3-1-2006; IN COMMERCE 3-1-2006.
KIMBERLY FRYE, EXAMINING ATTORNEY

SN 78-761,494. VCR LLC, ENCINO, CA. FILED 11-28-2005.

TRUTH SQUAD

THE MARK CONSISTS OF STANDARD CHARACTERS WITHOUT CLAIM TO ANY PARTICULAR FONT, STYLE, SIZE, OR COLOR.

CLASS 9—ELECTRICAL AND SCIENTIFIC APPARATUS

FOR PRERECORDED CDS, DVD'S, AUDIO AND AUDIO-VIDEO TAPES AND CASSETTES FEATURING MUSICAL PERFORMANCES, COMEDY AND DRAMA. (U.S. CLS. 21, 23, 26, 36 AND 38).

CLASS 25—CLOTHING

FOR APPAREL, NAMELY, BEACH COVER-UPS; BEACHWEAR, BELTS; CLOTH BIBS; JACKETS; DRESSES; SKIRTS, GLOVES AND MITTENS; JEANS; PANTS; FLEECE TOPS; SCARVES; BLOUSES; SHORTS; SKORTS; SWEATPANTS; SWEATERS; SWEAT SHIRTS; SWIMSUITS; JOGGING SUITS; TANK TOPS; TIGHTS; T-SHIRTS; UNDERWEAR; LINGERIE; SLEEPWEAR; PAJAMAS; ROBES; VESTS; WRIST BANDS; RAINWEAR; SOCKS; BOXER SHORTS; HALLOWEEN COSTUMES; FOOTWEAR; SLIPPERS; SHOES; SANDALS; SNEAKERS; HATS; CAPS; VISORS; HEADWEAR (U.S. CLS. 22 AND 39).

CLASS 41—EDUCATION AND ENTERTAINMENT

FOR LIVE PERFORMANCES BY A MUSICAL GROUP CONSISTING OF CHILDREN PROMOTING HONESTY, INTEGRITY AND SELF ESTEEM; ONGOING CHILDREN'S TELEVISION SERIES. (U.S. CLS. 100, 101 AND 107).

FRED CARL, EXAMINING ATTORNEY

SN 78-761,998. HAMBAR, ARMEN, GLENDALE, CA. FILED 11-28-2005.

EDITOR'S TOOLKIT

THE MARK CONSISTS OF STANDARD CHARACTERS WITHOUT CLAIM TO ANY PARTICULAR FONT, STYLE, SIZE, OR COLOR.

CLASS 36—INSURANCE AND FINANCIAL

FOR COLLECTING LICENSE FEES ON BEHALF OF INDEPENDENT WRITERS AND PUBLISHERS AND MAKING PAYMENTS TO THE COPYRIGHT OWNERS OF THE MUSIC (U.S. CLS. 100, 101 AND 102).

FIRST USE 1-1-2002; IN COMMERCE 1-1-2002.

CLASS 41—EDUCATION AND ENTERTAINMENT

FOR MUSIC PRODUCTION SERVICES (U.S. CLS. 100, 101 AND 107).

FIRST USE 1-1-2002; IN COMMERCE 1-1-2002.
RICHARD WHITE, EXAMINING ATTORNEY

SN 78-762,540. GILDAN ACTIVEWEAR INC., ST-LAURENT, QC, CANADA, FILED 11-29-2005.

MORNING-FIT COMFORT

THE MARK CONSISTS OF STANDARD CHARACTERS WITHOUT CLAIM TO ANY PARTICULAR FONT, STYLE, SIZE, OR COLOR.

CLASS 25—CLOTHING

FOR MEN'S, WOMEN'S, YOUTHS' AND CHILDREN'S CLOTHING, NAMELY, DRESSES, GOLF SHIRTS, COLORED SHIRTS, HOODED TOPS, HOSIERY, JOGGING SUITS, JOGGING PANTS, JOGGING SHORTS, JOGGING SETS, JUMPSUITS, KNIT SHIRTS, KNIT TOPS, MUSCLE SHIRTS, ONE AND TWO PIECE PLAY OUTFITS, OVERALLS, PANTS, SHIRTS, SHORT-RIB COLLAR SHIRTS, SHORTS AND SHORTS SETS, SKIRTS, SLEEPWEAR, NAMELY SLEEPERS, PAJAMAS AND NIGHTGOWNS, SOCKS, SPORT SHIRTS, SWEATERS, SWEATPANTS, SWEATSHIRTS, TANK TOPS, T-SHIRTS, TURTLE-NECKS, UNDERSHIRTS, UNDERWEAR, WOMEN'S UNDERGARMENTS (U.S. CLS. 22 AND 39).

CLASS 35—ADVERTISING AND BUSINESS

FOR RETAIL STORE SERVICES FEATURING SPORTSWEAR; DISTRIBUTORSHIP SERVICES IN THE FIELD OF SPORTSWEAR (U.S. CLS. 100, 101 AND 102).

CLASS 40—MATERIAL TREATMENT

FOR MANUFACTURE OF SPORTSWEAR TO THE ORDER AND SPECIFICATION OF OTHERS (U.S. CLS. 100, 103 AND 106).

CLASS 42—SCIENTIFIC, COMPUTER AND LEGAL SERVICES

FOR DESIGN FOR OTHERS IN THE FIELD OF SPORTSWEAR (U.S. CLS. 100 AND 101).
TINA L. SNAPP, EXAMINING ATTORNEY

SN 78-764,356. STYLE FORUM INC., FORT MEYERS, FL. FILED 12-1-2005.

CHRISTOPHER GUY

THE MARK CONSISTS OF STANDARD CHARACTERS WITHOUT CLAIM TO ANY PARTICULAR FONT, STYLE, SIZE, OR COLOR.

THE NAME(S), PORTRAIT(S), AND/OR SIGNATURE(S) SHOWN IN THE MARK IDENTIFIES CHRISTOPHER GUY, WHOSE CONSENT(S) TO REGISTER IS SUBMITTED.

CLASS 20—FURNITURE AND ARTICLES NOT OTHERWISE CLASSIFIED

FOR FURNITURE, AND PARTS AND FITTINGS THEREFOR (U.S. CLS. 2, 13, 22, 25, 32 AND 50).

CLASS 35—ADVERTISING AND BUSINESS

FOR RETAIL AND WHOLESALE STORE OUTLETS FEATURING FURNITURE, HOME FURNISHINGS, HOUSEHOLD GOODS AND ARTICLES FOR INTERIOR DECORATION; CATALOG AND COMPUTERIZED ONLINE ORDERING SERVICES; MAIL ORDER SERVICES FEATURING FURNITURE, HOME FURNISHINGS, HOUSEHOLD GOODS AND ARTICLES FOR INTERIOR DECORATION; TELEPHONE ORDER-TAKING SERVICES FOR OTHERS; DIRECT MAIL ADVERTISING; WINDOW DRESSING AND DISPLAY SERVICES FOR MERCHANDISE; ADVERTISING, MARKETING AND PROMOTION SERVICES; IMPORT AND EXPORT AGENCIES; PROCUREMENT SERVICES, NAMELY PURCHASING FURNITURE AND HOME FURNISHINGS ON BEHALF OF OTHERS; AND CONSULTATION SERVICES RELATING TO THE AFORESAID SERVICES (U.S. CLS. 100, 101 AND 102).

CLASS 42—SCIENTIFIC, COMPUTER AND LEGAL SERVICES

FOR DESIGN OF FURNITURE AND FURNISHINGS; FURNITURE AND HOME FURNISHING DESIGN CONSULTATION SERVICES (U.S. CLS. 100 AND 101).
LAURA KOVALSKY, EXAMINING ATTORNEY

SN 78-766,273. ESEL INTERNATIONAL COMPANY LIMITED, FANLING, N.T., HONG KONG, FILED 12-4-2005.

I-CON BY ESEL

THE MARK CONSISTS OF STANDARD CHARACTERS WITHOUT CLAIM TO ANY PARTICULAR FONT, STYLE, SIZE, OR COLOR.

CLASS 9—ELECTRICAL AND SCIENTIFIC APPARATUS

FOR VIDEO GAME MACHINES FOR USE WITH TELEVISION RECEIVERS; COMPUTER PERIPHERALS; INTEGRATED CIRCUITS AND INTEGRATED CIRCUIT CARDS; ELECTRONIC APPARATUS, NAMELY, STAND ALONE DISPLAYS FOR MEDICAL IMAGES; RECORDED COMPUTER PROGRAMS FOR DATABASE MANAGEMENT; RECORDED COMPUTER SOFTWARE FOR DATABASE MANAGEMENT (U.S. CLS. 21, 23, 26, 36 AND 38).

CLASS 28—TOYS AND SPORTING GOODS

FOR GAMES, NAMELY, BOARD GAMES; GYMNAS-TIC APPARATUS AND DECORATIONS FOR CHRISTMAS TREES (U.S. CLS. 22, 23, 38 AND 50).
CHARLES L. JENKINS, EXAMINING ATTORNEY

SN 78-766,317. ROGUES GALLERY, INC., PORTLAND, ME. FILED 12-5-2005.

ROGUES GALLERY

THE MARK CONSISTS OF STANDARD CHARACTERS WITHOUT CLAIM TO ANY PARTICULAR FONT, STYLE, SIZE, OR COLOR.

OWNER OF U.S. REG. NO. 3,114,812.

CLASS 6—METAL GOODS

FOR METAL KEY FOBS (U.S. CLS. 2, 12, 13, 14, 23, 25 AND 50).
FIRST USE 12-1-2004; IN COMMERCE 12-1-2004.

CLASS 18—LEATHER GOODS

FOR CARRY-ALL BAGS (U.S. CLS. 1, 2, 3, 22 AND 41).
FIRST USE 12-2-2004; IN COMMERCE 12-2-2004.

CLASS 26—FANCY GOODS

FOR BELT BUCKLES NOT OF PRECIOUS METAL; ORNAMENTAL NOVELTY PINS (U.S. CLS. 37, 39, 40, 42 AND 50).

FIRST USE 12-1-2004; IN COMMERCE 12-1-2004.
KATHLEEN M. VANSTON, EXAMINING ATTORNEY

CLASS 35—ADVERTISING AND BUSINESS

FOR SUPPLY CHAIN MANAGEMENT AND CONSULTING SERVICES IN THE AREAS OF CHEMICAL PRODUCT AND SERVICE SOURCING AND PROCUREMENT, PRODUCT INVENTORY AND SUPPLY MANAGEMENT AND COST CONTAINMENT; BUSINESS CONSULTING, MARKETING, COST AND PRICING ANALYSIS RELATING TO ELECTROCHEMICAL LIQUID PURIFICATION UNITS FOR USE IN THE INDUSTRIAL SECTOR (U.S. CLS. 100, 101 AND 102).

SN 78-768,345. ALL-GLASS AQUARIUM CO., INC., FRANKLIN, WI. FILED 12-7-2005.

CLASS 42—SCIENTIFIC, COMPUTER AND LEGAL SERVICES

FOR TECHNICAL CONSULTING RELATING TO ELECTROCHEMICAL LIQUID PURIFICATION UNITS FOR USE IN THE INDUSTRIAL SECTOR (U.S. CLS. 100 AND 101).

KRISTINA KLOIBER, EXAMINING ATTORNEY

ZILLA

THE MARK CONSISTS OF STANDARD CHARACTERS WITHOUT CLAIM TO ANY PARTICULAR FONT, STYLE, SIZE, OR COLOR.

CLASS 11—ENVIRONMENTAL CONTROL APPARATUS

FOR LIGHTS, HEATERS, WATER FILTERS AND WATER FILTERING UNITS FOR VIVARIUMS, TERRARIUMS, AND AQUARIUMS (U.S. CLS. 13, 21, 23, 31 AND 34).

SN 78-769,706. HOLDERMAN, JAMES F., III, CHICAGO, IL. FILED 12-8-2005.

CLASS 16—PAPER GOODS AND PRINTED MATTER

FOR VIVARIUMS, TERRARIUMS, AND AQUARIUMS FOR SMALL ANIMALS; ACCESSORIES FOR VIVARIUMS, TERRARIUMS, AND AQUARIUMS, NAMELY, TANKS AND ARTIFICIAL LANDSCAPES, STANDS, CANOPIES, COVERS, HOODS, AIR STONES, AQUARIUM FISH NETS (U.S. CLS. 2, 5, 22, 23, 29, 37, 38 AND 50).

VISIO BEATIFICA

CLASS 19—NON-METALLIC BUILDING MATERIALS

FOR DECORATIVE STONES FOR VIVARIUMS, TERRARIUMS, AND AQUARIUMS (U.S. CLS. 1, 12, 33 AND 50).

AMY ALFIERI, EXAMINING ATTORNEY

THE MARK CONSISTS OF STANDARD CHARACTERS WITHOUT CLAIM TO ANY PARTICULAR FONT, STYLE, SIZE, OR COLOR.

THE ENGLISH TRANSLATION OF VISIO BEATIFICA IS BEAUTIFUL VISION.

SN 78-769,039. GENERAL ELECTRIC COMPANY, SCHENECTADY, NY. FILED 12-8-2005.

CLASS 16—PAPER GOODS AND PRINTED MATTER

FOR PRINTED MATERIAL COVERING RELIGIOUS AND SPIRITUAL TOPICS, NAMELY BOOKS, MAGAZINES, PAMPHLETS, AND NEWSLETTERS; STICKERS, POSTERS, CALENDARS, AND PHOTOGRAPHIC OR ART PRINTS FEATURING RELIGIOUS, SPIRITUAL, AND/OR MOTIVATIONAL QUOTATIONS (U.S. CLS. 2, 5, 22, 23, 29, 37, 38 AND 50).

IMAGINATION AT WORK

CLASS 41—EDUCATION AND ENTERTAINMENT

FOR EDUCATIONAL SERVICES, NAMELY, CONDUCTING CLASSES, SEMINARS, CONFERENCES AND PROVIDING PARTICIPATORY ACTIVITIES FEATURING DISCUSSION GROUPS, QUESTION AND ANSWER SESSIONS, ORGANIZED GROUP PROJECTS AND TRAINING IN THE FIELD OF RELIGIOUS AND SPIRITUAL DEVELOPMENT (U.S. CLS. 100, 101 AND 107).

PAULA MAHONEY, EXAMINING ATTORNEY

THE MARK CONSISTS OF STANDARD CHARACTERS WITHOUT CLAIM TO ANY PARTICULAR FONT, STYLE, SIZE, OR COLOR.

SN 78-769,966. NUMARA SOFTWARE, INC., TAMPA, FL.
FILED 12-9-2005.



NO CLAIM IS MADE TO THE EXCLUSIVE RIGHT TO USE "SOFTWARE", APART FROM THE MARK AS SHOWN.

THE MARK CONSISTS OF THE WORD NUMARA, WITH A CURVED LINE BEGINNING BELOW THE WORD AND CONTINUING UPWARDS THROUGH THE LETTERS ARA, PLUS THE WORD SOFTWARE. THE MARK IS NOT IN COLOR.

CLASS 9—ELECTRICAL AND SCIENTIFIC APPARATUS

FOR COMPUTER SOFTWARE FOR USE IN THE FIELD OF HELP DESK MANAGEMENT, NAMELY COMPUTER SOFTWARE FOR TRACKING AND MANAGING INFORMATION TECHNOLOGY SUPPORT REQUESTS AND INCIDENT REPORTS FROM USERS AND FOR TRACKING AND MANAGING TECHNOLOGY EQUIPMENT SUPPORT HISTORIES AND SUPPORT COST REPORTING; COMPUTER SOFTWARE FOR USE IN THE FIELD OF INFORMATION TECHNOLOGY ASSET MANAGEMENT, NAMELY COMPUTER SOFTWARE FOR TRACKING, MANAGING AND AUDITING COMPUTER SOFTWARE LICENSES AND COMPLIANCE AND FOR TRACKING AND MANAGING INFORMATION ON COMPUTER HARDWARE ASSETS, LEASE, USER, VENDOR, INSTALLATION AND SYSTEM CONFIGURATION, ASSET PURCHASING AND INSTALLATION AND DEPLOYMENT OF COMPUTER SOFTWARE AND SOFTWARE UPDATES BY LOCAL OR REMOTE MEANS (U.S. CLS. 21, 23, 26, 36 AND 38).

CLASS 42—SCIENTIFIC, COMPUTER AND LEGAL SERVICES

FOR INSTALLATION AND MAINTENANCE OF COMPUTER SOFTWARE FOR USE IN THE FIELD OF HELP DESK MANAGEMENT; INSTALLATION AND MAINTENANCE OF COMPUTER SOFTWARE FOR USE IN THE FIELD OF INFORMATION TECHNOLOGY ASSET MANAGEMENT (U.S. CLS. 100 AND 101).

WILLIAM P. SHANAHAN, EXAMINING ATTORNEY

SN 78-771,346. DAIMLERCHRYSLER AG, D-70567 STUTTGART, FED REP GERMANY, FILED 12-12-2005.

CLK 550

THE MARK CONSISTS OF STANDARD CHARACTERS WITHOUT CLAIM TO ANY PARTICULAR FONT, STYLE, SIZE, OR COLOR.

PRIORITY CLAIMED UNDER SEC. 44(D) ON FED REP GERMANY APPLICATION NO. 30553847.0/1, FILED 9-8-2005, REG. NO. 30553847, DATED 10-17-2005, EXPIRES 9-8-2015.

OWNER OF U.S. REG. NOS. 2,715,268, 2,746,262 AND OTHERS.

NO CLAIM IS MADE TO THE EXCLUSIVE RIGHT TO USE "550", APART FROM THE MARK AS SHOWN.

CLASS 12—VEHICLES

FOR AUTOMOBILES AND THEIR STRUCTURAL PARTS (U.S. CLS. 19, 21, 23, 31, 35 AND 44).

CLASS 28—TOYS AND SPORTING GOODS

FOR MODEL CARS (U.S. CLS. 22, 23, 38 AND 50).
REBECCA GAN, EXAMINING ATTORNEY

SN 78-772,288. AFFILIATE CLASSROOM, INC., COLLEGE PARK, MD. FILED 12-13-2005.

AFFILIATE CLASSROOM

THE MARK CONSISTS OF STANDARD CHARACTERS WITHOUT CLAIM TO ANY PARTICULAR FONT, STYLE, SIZE, OR COLOR.

NO CLAIM IS MADE TO THE EXCLUSIVE RIGHT TO USE "AFFILIATE", APART FROM THE MARK AS SHOWN.

CLASS 35—ADVERTISING AND BUSINESS

FOR PROVIDING AN ONLINE COMMERCIAL INFORMATION DIRECTORY ON THE INTERNET (U.S. CLS. 100, 101 AND 102).

FIRST USE 8-1-2004; IN COMMERCE 10-1-2004.

CLASS 41—EDUCATION AND ENTERTAINMENT

FOR TRAINING IN THE USE OF THE INTERNET FOR MARKETING AND BUSINESS DEVELOPMENT (U.S. CLS. 100, 101 AND 107).

FIRST USE 8-1-2004; IN COMMERCE 10-1-2004.

ROBERT STRUCK, EXAMINING ATTORNEY

SN 78-773,748. JKA INC., DBA DIVERSIFIED DISTRIBUTION, WOONSOCKET, RI. FILED 12-14-2005.

TIMELESS

THE MARK CONSISTS OF STANDARD CHARACTERS WITHOUT CLAIM TO ANY PARTICULAR FONT, STYLE, SIZE, OR COLOR.

CLASS 3—COSMETICS AND CLEANING PREPARATIONS

FOR COTTON PUFFS FOR COSMETIC PURPOSES (U.S. CLS. 1, 4, 6, 50, 51 AND 52).

CLASS 24—FABRICS

FOR BATH GLOVES AND BATH MITTS (U.S. CLS. 42 AND 50).

HOWARD SMIGA, EXAMINING ATTORNEY

SN 78-775,980. NAFTX ENERGY CORP., LOS ANGELES, CA. FILED 12-19-2005.



THE MARK CONSISTS OF THE WORD "NAFTX" AND A LION'S HEAD WITH DOUBLE "WINGS" EXTENDING THEREFROM.

CLASS 35—ADVERTISING AND BUSINESS

FOR WHOLESALE DISTRIBUTORSHIPS FEATURING CRUDE OIL; FLEET MANAGEMENT SERVICES, NAMELY, BUSINESS MANAGEMENT IN THE FIELD OF TRANSPORTATION (U.S. CLS. 100, 101 AND 102). FIRST USE 3-26-2004; IN COMMERCE 3-26-2004.

CLASS 36—INSURANCE AND FINANCIAL

FOR CREDIT CARD SERVICES AND ONLINE ACCOUNT MANAGEMENT SERVICES, NAMELY, ELECTRONIC BILL PAYMENT PROCESSING AND TRANSMISSION OF BILL PAYMENT DATA (U.S. CLS. 100, 101 AND 102). FIRST USE 3-26-2004; IN COMMERCE 3-26-2004.

CLASS 37—CONSTRUCTION AND REPAIR

FOR FUELING SERVICES FOR AIRCRAFT AND MARINE AND GROUND VEHICLES; AVIATION SERVICES, NAMELY, AIRCRAFT MAINTENANCE AND REPAIR AND FUELING SERVICES FOR AIRCRAFT (U.S. CLS. 100, 103 AND 106). FIRST USE 3-6-2004; IN COMMERCE 3-6-2004.

CLASS 39—TRANSPORTATION AND STORAGE

FOR PETROLEUM DISTRIBUTION, NAMELY, TRANSPORTATION OF PETROLEUM (U.S. CLS. 100 AND 105). FIRST USE 3-6-2004; IN COMMERCE 3-6-2004. MARIAM MAHMOUDI, EXAMINING ATTORNEY

SN 78-777,500. GREATCALL, INC., DEL MAR, CA. FILED 12-20-2005.

GREATCALL

THE MARK CONSISTS OF STANDARD CHARACTERS WITHOUT CLAIM TO ANY PARTICULAR FONT, STYLE, SIZE, OR COLOR.

CLASS 9—ELECTRICAL AND SCIENTIFIC APPARATUS

FOR CELLULAR TELEPHONE HANDSETS, BATTERIES FOR HANDSETS, CARRYING CASES FOR CELLULAR PHONES, CARRYING CASES FOR CELL PHONE CHARGERS, BATTERIES AND CELL PHONE HANDS FREE APPARATUSES, TRAVEL AND DESKTOP CHARGERS FOR BATTERIES FOR CELLULAR HANDSETS, HANDS-FREE CAR KITS FOR CELLULAR HANDSETS COMPRISED PRIMARILY OF A MICROPHONE, EXTERNAL SPEAKER, CRADLE, MOUNTING BRACKETS AND POWER CABLES (U.S. CLS. 21, 23, 26, 36 AND 38).

CLASS 38—COMMUNICATION

FOR TELECOMMUNICATIONS SERVICES, NAMELY, CELLULAR TELEPHONE SERVICES, LONG-DISTANCE SERVICES, VOICE AND DATA TRANSMISSION SERVICES (U.S. CLS. 100, 101 AND 104). NORA BUCHANAN WILL, EXAMINING ATTORNEY

SN 78-777,506. GREATCALL, INC., DEL MAR, CA. FILED 12-20-2005.

GREAT CALL

THE MARK CONSISTS OF STANDARD CHARACTERS WITHOUT CLAIM TO ANY PARTICULAR FONT, STYLE, SIZE, OR COLOR.

CLASS 9—ELECTRICAL AND SCIENTIFIC APPARATUS

FOR CELLULAR TELEPHONE HANDSETS, BATTERIES FOR HANDSETS, CARRYING CASES FOR CELLULAR PHONES, CARRYING CASES FOR CELL PHONE CHARGERS, BATTERIES AND CELL PHONE HANDS FREE APPARATUSES, TRAVEL AND DESKTOP CHARGERS FOR BATTERIES FOR CELLULAR HANDSETS, HANDS-FREE CAR KITS FOR CELLULAR HANDSETS COMPRISED PRIMARILY OF A MICROPHONE, EXTERNAL SPEAKER, CRADLE, MOUNTING BRACKETS AND POWER CABLES (U.S. CLS. 21, 23, 26, 36 AND 38).

CLASS 38—COMMUNICATION

FOR TELECOMMUNICATIONS SERVICES, NAMELY, CELLULAR TELEPHONE SERVICES, LONG-DISTANCE SERVICES, VOICE AND DATA TRANSMISSION SERVICES (U.S. CLS. 100, 101 AND 104). NORA BUCHANAN WILL, EXAMINING ATTORNEY

SN 78-779,250. AME RED-E-MIX, INC., ELK RIVER, MN. FILED 12-22-2005.

AME

THE MARK CONSISTS OF STANDARD CHARACTERS WITHOUT CLAIM TO ANY PARTICULAR FONT, STYLE, SIZE, OR COLOR.

CLASS 19—NON-METALLIC BUILDING MATERIALS

FOR CONCRETE, READY-MIX CONCRETE (U.S. CLS. 1, 12, 33 AND 50).
FIRST USE 4-15-1988; IN COMMERCE 10-14-2005.

CLASS 39—TRANSPORTATION AND STORAGE

FOR DELIVERY OF CONCRETE BY TRUCK (U.S. CLS. 100 AND 105).
FIRST USE 4-15-1988; IN COMMERCE 10-14-2005.
CHRIS WELLS, EXAMINING ATTORNEY

SN 78-781,339. ZEPHTEX INDUSTRIES, INC., SAN CLEMENTE, CA. FILED 12-27-2005.

Personalized Cause

THE MARK CONSISTS OF STANDARD CHARACTERS WITHOUT CLAIM TO ANY PARTICULAR FONT, STYLE, SIZE, OR COLOR.

CLASS 14—JEWELRY

FOR JEWELRY MADE FROM NON-PRECIOUS METALS AND OTHER NON-PRECIOUS MATERIALS (U.S. CLS. 2, 27, 28 AND 50).
FIRST USE 10-1-2001; IN COMMERCE 10-1-2001.

CLASS 25—CLOTHING

FOR CLOTHING, NAMELY, SHIRTS, PANTS, SHORTS, JACKETS, HATS, SOCKS, SKIRTS (U.S. CLS. 22 AND 39).
FIRST USE 10-1-2001; IN COMMERCE 10-1-2001.
SOPHIA S. KIM, EXAMINING ATTORNEY

SN 78-780,112. NICE SHOES HOLDINGS LLC, NEW YORK, NY. FILED 12-23-2005.

NICE SPOTS

THE MARK CONSISTS OF STANDARD CHARACTERS WITHOUT CLAIM TO ANY PARTICULAR FONT, STYLE, SIZE, OR COLOR.

NO CLAIM IS MADE TO THE EXCLUSIVE RIGHT TO USE "SPOT", APART FROM THE MARK AS SHOWN.

CLASS 9—ELECTRICAL AND SCIENTIFIC APPARATUS

FOR COMPUTER SOFTWARE FOR COLLABORATIVE REVIEW AND PRODUCTION OF AUDIO AND VIDEO MATERIALS, NAMELY, EDITING, SPECIAL EFFECTS, DUBBING, BROADCASTING; COMPUTER SOFTWARE FOR ARCHIVING AND INDEXING AUDIO AND VIDEO MATERIALS FOR PURPOSES OF COLLABORATIVE REVIEW AND EDITING ACTIVITIES; AND COMPUTER SOFTWARE FOR DVD AUTHORIZING SERVICES (U.S. CLS. 21, 23, 26, 36 AND 38).
FIRST USE 11-3-2005; IN COMMERCE 11-3-2005.

CLASS 35—ADVERTISING AND BUSINESS

FOR POST-PRODUCTION EDITING SERVICES FOR FILM, VIDEO AND AUDIO COMMERCIALS (U.S. CLS. 100, 101 AND 102).
FIRST USE 11-3-2005; IN COMMERCE 11-3-2005.

CLASS 41—EDUCATION AND ENTERTAINMENT

FOR FILM AND VIDEO EDITING; POST-PRODUCTION EDITING SERVICES FOR FILM, VIDEO AND AUDIO (U.S. CLS. 100, 101 AND 107).
FIRST USE 11-3-2005; IN COMMERCE 11-3-2005.
CHRISTINE COOPER, EXAMINING ATTORNEY

SN 78-781,947. KAIBAK LLC, SAUSALITO, CA. FILED 12-28-2005.

KAIBAK

THE MARK CONSISTS OF STANDARD CHARACTERS WITHOUT CLAIM TO ANY PARTICULAR FONT, STYLE, SIZE, OR COLOR.

CLASS 12—VEHICLES

FOR SEAT BACKS FOR KAYAKS; KAYAKING AND BOATING EQUIPMENT, NAMELY WATER DEFLECTING SKIRTS (U.S. CLS. 19, 21, 23, 31, 35 AND 44).

CLASS 25—CLOTHING

FOR SHIRTS; JACKETS; HEAD WEAR; OUTER WEAR, NAMELY, JACKETS AND VESTS (U.S. CLS. 22 AND 39).
ROBERT STRUCK, EXAMINING ATTORNEY

SN 78-782,588. XRG COMPANY LIMITED, HONG KONG, HONG KONG, FILED 12-29-2005.

SN 78-783,808. FAIRVIEW ORCHARDS LANDBESITZ, INC., HAGERSTOWN, MD. FILED 1-3-2006.



INSIDE-OUT

THE MARK CONSISTS OF STANDARD CHARACTERS WITHOUT CLAIM TO ANY PARTICULAR FONT, STYLE, SIZE, OR COLOR.

PRIORITY CLAIMED UNDER SEC. 44(D) ON HONG KONG APPLICATION NO. 300448632, FILED 6-30-2005, REG. NO. 300448632, DATED 6-30-2005, EXPIRES 6-29-2015.

CLASS 35—ADVERTISING AND BUSINESS

FOR BUSINESS MANAGEMENT AND ORGANISATION CONSULTANCY; BUSINESS INVESTIGATIONS, APPRAISAL AND INFORMATION; ECONOMIC FORECASTING; MARKET RESEARCH; PUBLIC RELATIONS; BUSINESS RELOCATION SERVICES; SECRETARIAL AND CLERICAL SERVICES; SHORTHAND SECRETARIAL SERVICES; BUSINESS APPRAISALS; ARRANGING AND CONDUCTING BUSINESS SEMINARS, CONFERENCES, WORKSHOPS AND SYMPOSIUMS (U.S. CLS. 100, 101 AND 102).

CLASS 36—INSURANCE AND FINANCIAL

FOR FINANCIAL SERVICES, NAMELY FINANCIAL ANALYSIS, FINANCIAL MANAGEMENT, FINANCIAL CONSULTATION; INVESTMENT SERVICES, NAMELY INVESTMENT MANAGEMENT, INVESTMENT CONSULTATION; INVESTMENT ANALYSIS, APPRAISAL, VALUATION, INFORMATION AND MANAGEMENT SERVICES AND CONSULTANCY; REAL ESTATE APPRAISAL AND VALUATION; FINANCIAL VALUATION OF PERSONAL PROPERTY AND REAL ESTATE; PROVIDING STOCK MARKET INFORMATION (U.S. CLS. 100, 101 AND 102).

CLASS 41—EDUCATION AND ENTERTAINMENT

FOR EDUCATION SERVICES, NAMELY PROVIDING CLASSES, SEMINARS AND WORKSHOPS IN THE FIELDS OF FINANCE, BUSINESS MANAGEMENT, INVESTMENT, ECONOMICS AND MARKET RESEARCH; TRAINING SERVICES IN THE FIELDS OF FINANCE, BUSINESS MANAGEMENT, INVESTMENT, ECONOMICS AND MARKET RESEARCH; ARRANGING AND CONDUCTING EDUCATIONAL SEMINARS, CONFERENCES, WORKSHOPS AND SYMPOSIUMS; PUBLISHING OF BOOKS, MAGAZINES, LEAFLETS AND ELECTRONIC PUBLICATIONS (U.S. CLS. 100, 101 AND 107).

JENNIFER MCROBBIE, EXAMINING ATTORNEY

CLASS 35—ADVERTISING AND BUSINESS

FOR HOTEL MANAGEMENT FOR OTHERS; BUSINESS MARKETING SERVICES, PUBLIC RELATIONS SERVICES, AND ARRANGING AND CONDUCTING TRADE SHOWS RELATED TO THE TRAVEL INDUSTRY (U.S. CLS. 100, 101 AND 102).

CLASS 36—INSURANCE AND FINANCIAL

FOR LEASING OF REAL ESTATE, APARTMENTS AND OFFICE SPACE; REAL ESTATE ACQUISITION SERVICES; LEASING OF REAL ESTATE FOR TIMBER LOGGING; LEASING OF REAL ESTATE FOR RECREATIONAL SERVICES, NAMELY LEASING HUNTING PRESERVES (U.S. CLS. 100, 101 AND 102).

CLASS 37—CONSTRUCTION AND REPAIR

FOR REAL ESTATE DEVELOPMENT SERVICES (U.S. CLS. 100, 103 AND 106).

CLASS 39—TRANSPORTATION AND STORAGE

FOR SHIP BROKERAGE SERVICES (U.S. CLS. 100 AND 105).

CLASS 40—MATERIAL TREATMENT

FOR TIMBER LOGGING (U.S. CLS. 100, 103 AND 106).

CLASS 41—EDUCATION AND ENTERTAINMENT

FOR HUNTING GUIDE SERVICES, PROVIDING HUNTING PRESERVES (U.S. CLS. 100, 101 AND 107).
JEFF DEFORD, EXAMINING ATTORNEY

SN 78-784,267. COURTSIDE RESTAURANT HOLDING COMPANY, INC., SACRAMENTO, CA. FILED 1-3-2006.

CENTER COURT WITH C. WEBB

THE MARK CONSISTS OF STANDARD CHARACTERS WITHOUT CLAIM TO ANY PARTICULAR FONT, STYLE, SIZE, OR COLOR.

THE NAME "C. WEBB" IDENTIFIES A LIVING INDIVIDUAL WHOSE CONSENT IS OF RECORD.

CLASS 25—CLOTHING

FOR ATHLETIC SHOES; ATHLETIC UNIFORMS; BANDANAS; BIBS NOT OF CLOTH OR PAPER; CAPS; CHILDREN'S AND INFANTS' CLOTH BIBS; CHILDREN'S CLOTH EATING BIBS; CLOTH BIBS FOR ADULT DINERS; GOLF SHIRTS; HATS; HOODS; INFANT AND TODDLER ONE PIECE CLOTHING; JACKETS; JERSEYS; MUSCLE TOPS; POLO SHIRTS; SHIRTS; SHOES; SHORTS; SLEEPING GARMENTS; SOCKS; SPORTS SHIRTS; SWEAT BANDS; SWEAT SHIRTS; SWEAT SUITS; SWEATERS; SWIM WEAR FOR GENTLEMEN AND LADIES; SWIMMING TRUNKS; T-SHIRTS; TANK TOPS; TIES; TOPS; WRAPS (U.S. CLS. 22 AND 39).

CLASS 43—HOTEL AND RESTAURANT SERVICES

FOR RESTAURANT AND BAR SERVICES (U.S. CLS. 100 AND 101).
LEIGH LOWRY, EXAMINING ATTORNEY

SN 78-784,587. FERRELLGAS, L.P., LIBERTY, MO. FILED 1-4-2006.

CHARGE

THE MARK CONSISTS OF STANDARD CHARACTERS WITHOUT CLAIM TO ANY PARTICULAR FONT, STYLE, SIZE, OR COLOR.

CLASS 4—LUBRICANTS AND FUELS

FOR PROPANE GAS; AND PROPANE GAS SOLD IN CYLINDERS (U.S. CLS. 1, 6 AND 15).

CLASS 37—CONSTRUCTION AND REPAIR

FOR PROPANE CYLINDER EXCHANGE SERVICES, NAMELY, REFURBISHMENT AND EXCHANGE OF PROPANE GAS CYLINDERS; LEASING OF PROPANE GAS CYLINDERS; PROVIDING INFORMATION IN THE FIELDS OF GRILL MAINTENANCE AND REPAIR OF GRILLING EQUIPMENT; CONSULTATION AND TECHNICAL SUPPORT SERVICES FOR THE MAINTENANCE AND REPAIR OF PROPANE GAS CYLINDERS AND GRILLING EQUIPMENT (U.S. CLS. 100, 103 AND 106).
DAVID MILLER, EXAMINING ATTORNEY

SN 78-784,712. GIRL SKATEBOARD COMPANY, INC., TORRANCE, CA. FILED 1-4-2006.

FOURSTAR

THE MARK CONSISTS OF STANDARD CHARACTERS WITHOUT CLAIM TO ANY PARTICULAR FONT, STYLE, SIZE, OR COLOR.

CLASS 6—METAL GOODS

FOR METAL KEY CHAINS (U.S. CLS. 2, 12, 13, 14, 23, 25 AND 50).

CLASS 18—LEATHER GOODS

FOR WALLETS, BACKPACKS, PURSES AND LEATHER KEY CHAINS (U.S. CLS. 1, 2, 3, 22 AND 41).

CLASS 20—FURNITURE AND ARTICLES NOT OTHERWISE CLASSIFIED

FOR NON-METAL AND NON-LEATHER KEY CHAINS (U.S. CLS. 2, 13, 22, 25, 32 AND 50).

CLASS 25—CLOTHING

FOR CLOTHING, NAMELY, PANTS, SHIRTS, SHORTS, SUITS, SWEATERS, JACKETS, UNDERWEAR, SWIMWEAR, VESTS, SOCKS, SKIRTS, DRESSES, COATS, SHOES, FOOTWEAR, HATS, CAPS, BELTS, WRISTBANDS AND LEATHER WRISTBANDS (U.S. CLS. 22 AND 39).

FRED CARL, EXAMINING ATTORNEY

SN 78-785,089. SCHMITZ, JOHN C., PORT ANGELES, WA. FILED 1-4-2006.



NO CLAIM IS MADE TO THE EXCLUSIVE RIGHT TO USE "THE REAL ESTATE COMPANY", APART FROM THE MARK AS SHOWN.

THE COLORS MAROON (PANTONE 217), BLACK, GREY AND WHITE ARE CLAIMED AS A FEATURE OF THE MARK.

THE COLOR MAROON (PANTONE 217) APPEARS IN A BOX AROUND THE WORD "JACE", AND IN THE LETTERING OF THE WORDS "THE REAL ESTATE COMPANY". THE COLOR BLACK APPEARS IN THE PORTION OF THE BOX THAT INTERSECTS WITH THE CIRCLE. THE COLOR GREY APPEARS IN THE CIRCLE. THE COLOR WHITE APPEARS IN THE WORDING "JACE".

CLASS 16—PAPER GOODS AND PRINTED MATTER

FOR PUBLICATIONS, NAMELY MAGAZINES, INFORMATIONAL BOOKLETS, BROCHURES, FLYERS AND PRINTED REAL ESTATE FORMS IN THE FIELD OF REAL ESTATE (U.S. CLS. 2, 5, 22, 23, 29, 37, 38 AND 50).

FIRST USE 7-1-2005; IN COMMERCE 7-1-2005.

CLASS 41—EDUCATION AND ENTERTAINMENT

FOR EDUCATIONAL SERVICES, NAMELY PROVIDING PROGRAMS, WORKSHOPS, SEMINARS AND TRAINING IN THE FIELD OF REAL ESTATE AND ACQUISITIONS AND DISTRIBUTION OF COURSE MATERIALS IN CONNECTION THEREWITH (U.S. CLS. 100, 101 AND 107).

FIRST USE 10-1-2005; IN COMMERCE 10-1-2005.
KRISTIN DAHLING, EXAMINING ATTORNEY

SN 78-787,981. HUTCHINSON, IAN B., EUREKA, CA. FILED 1-9-2006.



NO CLAIM IS MADE TO THE EXCLUSIVE RIGHT TO USE "GOLF", APART FROM THE MARK AS SHOWN.

THE MARK CONSISTS OF THE WORDS MAD LAD GOLF, MAD LAD WRITTEN IN TEXT CREATED BY OWNER, OVER A GOLF BALL SKULL WITH A DEMONIC GRIN. BEHIND GOLF BALL SKULL ARE TWO GOLF TEES CROSSED TO FORM AN 'X'.

CLASS 25—CLOTHING

FOR GOLF CAPS; GOLF SHIRTS; GOLF TROUSERS (U.S. CLS. 22 AND 39).

CLASS 28—TOYS AND SPORTING GOODS

FOR DIVOT REPAIR TOOLS; FITTED HEAD COVERS FOR GOLF CLUBS; GOLF ACCESSORY POUCHES; GOLF BAG TAGS; GOLF BAGS; GOLF BALL MARKERS; GOLF BALLS; GOLF CLUB COVERS; GOLF FLAGS; GOLF GLOVES; GOLF TEES (U.S. CLS. 22, 23, 38 AND 50).
SHARON MEIER, EXAMINING ATTORNEY

SN 78-788,497. DEPARTMENT OF THE NAVY, AN AGENCY OF THE UNITED STATES, AS REPRESENTED BY SPACE AND NAVAL WARFARE SYSTEMS COMMAND, SAN DIEGO, CA. FILED 1-10-2006.

FORCEnet

THE MARK CONSISTS OF STANDARD CHARACTERS WITHOUT CLAIM TO ANY PARTICULAR FONT, STYLE, SIZE, OR COLOR.

CLASS 9—ELECTRICAL AND SCIENTIFIC APPARATUS

FOR MILITARY ELECTRONIC DATA PROCESSING SYSTEMS FOR SITUATIONAL AWARENESS AND MILITARY WEAPONS MANAGEMENT COMPOSED OF INTEGRATED AND SCALABLE COMPUTERS, ELECTRONIC SENSORS, NAMELY, THERMAL, ELECTROMAGNETIC, MECHANICAL, CHEMICAL, BIOLOGICAL, OPTICAL, RADIATION, AND ACOUSTIC SENSORS, COMPUTER NETWORKING HARDWARE, APPARATUS FOR TRANSMISSION OF COMMUNICATIONS, SIGNAL PROCESSORS, AND MILITARY COMMAND AND CONTROL SOFTWARE PLATFORMS (U.S. CLS. 21, 23, 26, 36 AND 38).
FIRST USE 12-0-2002; IN COMMERCE 2-27-2003.

CLASS 42—SCIENTIFIC, COMPUTER AND LEGAL SERVICES

FOR MILITARY TECHNICAL RESEARCH AND DEVELOPMENT IN THE FIELD OF INTEGRATED, DISTRIBUTED, AND SCALABLE COMPUTERS, SENSORS, NETWORKS, COMMUNICATIONS, PLATFORMS, AND WEAPONS (U.S. CLS. 100 AND 101).

FIRST USE 12-0-2002; IN COMMERCE 2-27-2003.
ELIZABETH J. WINTER, EXAMINING ATTORNEY

SN 78-790,880. MONTAGE DEVELOPMENT, INC., ENCINO, CA. FILED 1-12-2006.



THE COLORS RED, GOLD, PURPLE, LIGHT BLUE, GREEN, AND WHITE ARE CLAIMED AS A FEATURE OF THE MARK.

THE MARK CONSISTS OF THE WHITE OUTLINE OF A BUILDING WITH, FROM LEFT TO RIGHT, THE COLORS RED, GOLD, PURPLE (ON TOP), LIGHT BLUE (UNDERNEATH), AND GREEN SUPERIMPOSED OVER THE OUTLINE.

CLASS 36—INSURANCE AND FINANCIAL

FOR LEASING OF APARTMENTS; LEASING OF REAL ESTATE; LEASING OF REAL PROPERTY; LEASING OR RENTING OF BUILDINGS; REAL ESTATE CONSULTANCY; REAL ESTATE CONSULTATION; REAL ESTATE EQUITY SHARING, NAMELY, MANAGING AND ARRANGING FOR CO-OWNERSHIP OF REAL ESTATE; REAL ESTATE MANAGEMENT; REAL ESTATE MANAGEMENT CONSULTATION; REAL ESTATE PROCUREMENT FOR OTHERS; RENTAL OF APARTMENTS (U.S. CLS. 100, 101 AND 102).

CLASS 37—CONSTRUCTION AND REPAIR

FOR REAL ESTATE DEVELOPMENT; REAL ESTATE SITE SELECTION (U.S. CLS. 100, 103 AND 106).
BRENDAN REGAN, EXAMINING ATTORNEY

SN 78-795,018. POSTNET INTERNATIONAL FRANCHISE CORPORATION, DENVER, CO. FILED 1-19-2006.

POSTNET

CREATE • DUPLICATE • DELIVER

OWNER OF U.S. REG. NO. 1,801,313.
NO CLAIM IS MADE TO THE EXCLUSIVE RIGHT TO USE "CREATE", "DUPLICATE" OR "DELIVER", APART FROM THE MARK AS SHOWN.

CLASS 35—ADVERTISING AND BUSINESS

FOR BUSINESS ADMINISTRATION SERVICES FOR OTHERS; OFFICE ADMINISTRATION SERVICES FOR OTHERS; OFFICE FUNCTION SERVICES FOR OTHERS; PHOTOCOPYING; DOCUMENT DUPLICATING; DIGITAL COPYING; DOCUMENT PREPARATION SERVICES; SECRETARIAL SERVICES; WORD PROCESSING SERVICES; ELECTRONIC COMMERCE SERVICES, NAMELY PROVIDING INFORMATION PRODUCTS VIA TELECOMMUNICATION NETWORKS FOR ADVERTISING AND SALES PURPOSES; TELEPHONE ANSWERING SERVICES; ADVERTISING SERVICES; RETAIL STORE AND SALES PROMOTION SERVICES FEATURING SHIPPING AND PACKAGING PRODUCTS, BOXES, CARTONS, PACKAGES, MAILERS AND ENVELOPES, MAILING TUBES, PACKAGING TAPES AND CUSHIONING MATERIALS, OFFICE SUPPLIES, PAPER PRODUCTS, PHONES, GREETING CARDS, AND COMPUTER SUPPLIES; FRANCHISING, NAMELY CONSULTATION AND ASSISTANCE IN BUSINESS MANAGEMENT, ORGANIZATION, AND PROMOTION; CUSTOM PACKAGING OF ARTICLES TO THE ORDER AND SPECIFICATION OF OTHERS (U.S. CLS. 100, 101 AND 102).

FIRST USE 12-31-2003; IN COMMERCE 12-31-2003.

CLASS 38—COMMUNICATION

FOR ELECTRONIC COMMUNICATION SERVICES, NAMELY ELECTRONIC TRANSMISSION OF DATA, DOCUMENTS AND INFORMATION VIA ELECTRONICS; PAGER RENTAL AND LEASING SERVICES; ELECTRONIC MAIL SERVICES; FACSIMILE TRANSMISSION SERVICES; VIDEO TELECONFERENCING SERVICES; ELECTRONIC VOICE MESSAGE SERVICES FEATURING RECORDING, STORAGE, AND TRANSMISSION OF VOICE MESSAGES; PROVIDING MULTIPLE USER ACCESS TO THE INTERNET; PROVIDING HIGH SPEED ACCESS TO THE INTERNET (U.S. CLS. 100, 101 AND 104).

FIRST USE 12-31-2003; IN COMMERCE 12-31-2003.

CLASS 39—TRANSPORTATION AND STORAGE

FOR COURIER SERVICES FOR MERCHANDISE; DELIVERY OF GOODS BY LAND AND AIR; FREIGHT TRANSPORTATION BY AIR AND TRUCK; SHIPPING OF GOODS BY AIR AND TRUCK; PACKAGING AND STORAGE OF GOODS FOR TRANSPORTATION; MAIL FORWARDING SERVICES; MAIL BOX RENTAL SERVICES; WRAPPING OF PACKAGES FOR PROTECTION DURING TRAVEL; STORAGE OF ELECTRONIC DATA AND MEDIA, NAMELY, IMAGES, TEXT, VIDEO AND AUDIO DATA (U.S. CLS. 100 AND 105).

FIRST USE 12-31-2003; IN COMMERCE 12-31-2003.

CLASS 40—MATERIAL TREATMENT

FOR SCANNING PRINTED MATERIAL TO CONVERT TO ELECTRONIC MEDIA; PRINTING SERVICES, FEATURING BINDING, COLLATING, STAPLING, LAMINATING, CUTTING, FOLDING, AND FINISHING OF PRINTED, PHOTOCOPIED AND TYPEWRITTEN MATERIALS; CUSTOMIZED PRINTING OF COMPANY NAMES AND LOGOS; DESKTOP PUBLISHING FOR OTHERS; LAMINATING SERVICES OF PRINTED, PHOTOCOPIED AND TYPEWRITTEN MATERIALS; DOCUMENT SCANNING (U.S. CLS. 100, 103 AND 106).

FIRST USE 12-31-2003; IN COMMERCE 12-31-2003.

CLASS 42—SCIENTIFIC, COMPUTER AND LEGAL SERVICES

FOR LEASE AND RENTAL OF COMPUTERS AND COMPUTER PERIPHERALS, COMPUTER PROGRAMS AND RELATED EQUIPMENT (U.S. CLS. 100 AND 101).

FIRST USE 12-31-2003; IN COMMERCE 12-31-2003.
ATTIYA MALIK, EXAMINING ATTORNEY

SN 78-795,052. MEDIA ACCESS PROJECT, WASHINGTON, DC. FILED 1-19-2006.

MAP

THE MARK CONSISTS OF STANDARD CHARACTERS WITHOUT CLAIM TO ANY PARTICULAR FONT, STYLE, SIZE, OR COLOR.

CLASS 41—EDUCATION AND ENTERTAINMENT

FOR EDUCATIONAL SERVICES, NAMELY, WRITING OP-ED PIECES, WRITING ARTICLES, PROVIDING INTERNSHIPS, PROVIDING EDUCATIONAL SPEAKERS, EDUCATIONAL CONFERENCES AND EDUCATIONAL PROGRAMS IN THE FIELDS OF CONSTITUTIONAL RIGHTS, TELECOMMUNICATIONS AND MEDIA POLICY (U.S. CLS. 100, 101 AND 107).

FIRST USE 12-16-1972; IN COMMERCE 12-31-1980.

CLASS 42—SCIENTIFIC, COMPUTER AND LEGAL SERVICES

FOR LEGAL SERVICES; NAMELY, REPRESENTING CLIENTS IN FEDERAL, STATE AND LOCAL PROCEEDINGS AND PROVIDING LEGAL ADVICE ON CONSTITUTIONAL RIGHTS RELATING TO TELECOMMUNICATIONS AND MEDIA POLICY (U.S. CLS. 100 AND 101).

FIRST USE 12-16-1972; IN COMMERCE 12-31-1973.

KIMBERLY PERRY, EXAMINING ATTORNEY

SN 78-795,385. PREVOYANCE GROUP, INC., HARRISON, NY. FILED 1-19-2006.

PREVOYANCE GROUP

THE MARK CONSISTS OF STANDARD CHARACTERS WITHOUT CLAIM TO ANY PARTICULAR FONT, STYLE, SIZE, OR COLOR.

NO CLAIM IS MADE TO THE EXCLUSIVE RIGHT TO USE "GROUP", APART FROM THE MARK AS SHOWN.

THE FOREIGN WORDING IN THE MARK TRANSLATES INTO ENGLISH AS FORESIGHT.

CLASS 35—ADVERTISING AND BUSINESS

FOR BUSINESS PROCESS RE-ENGINEERING SERVICES (U.S. CLS. 100, 101 AND 102).

FIRST USE 2-0-2005; IN COMMERCE 2-0-2005.

CLASS 42—SCIENTIFIC, COMPUTER AND LEGAL SERVICES

FOR CONSULTING SERVICES IN THE FIELD OF INFORMATION TECHNOLOGIES (U.S. CLS. 100 AND 101).

FIRST USE 2-0-2005; IN COMMERCE 2-0-2005.

KYLE PEETE, EXAMINING ATTORNEY

SN 78-795,391. PREVOYANCE GROUP, INC., HARRISON, NY. FILED 1-19-2006.

SN 78-796,401. HORS LA MONDE CORP., BEVERLY HILLS, CA. FILED 1-20-2006.



LO DE HORS DE LA MONDE
PARIS

THE MARK CONSISTS OF STANDARD CHARACTERS WITHOUT CLAIM TO ANY PARTICULAR FONT, STYLE, SIZE, OR COLOR.

NO CLAIM IS MADE TO THE EXCLUSIVE RIGHT TO USE "PARIS", APART FROM THE MARK AS SHOWN.

THE ENGLISH TRANSLATION OF THE FOREIGN WORDING IN THE MARK IS ANYWHERE OUT OF THIS WORLD PARIS.

CLASS 35—ADVERTISING AND BUSINESS

FOR BUSINESS PROCESS RE-ENGINEERING SERVICES (U.S. CLS. 100, 101 AND 102).
FIRST USE 4-0-2005; IN COMMERCE 4-0-2005.

CLASS 42—SCIENTIFIC, COMPUTER AND LEGAL SERVICES

FOR CONSULTING SERVICES IN THE FIELD OF INFORMATION TECHNOLOGIES (U.S. CLS. 100 AND 101).

FIRST USE 4-0-2005; IN COMMERCE 4-0-2005.
KYLE PEETE, EXAMINING ATTORNEY

CLASS 3—COSMETICS AND CLEANING PREPARATIONS

FOR PERFUME (U.S. CLS. 1, 4, 6, 50, 51 AND 52).

CLASS 14—JEWELRY

FOR JEWELRY (U.S. CLS. 2, 27, 28 AND 50).
ALICE BENMAMAN, EXAMINING ATTORNEY

SN 78-797,038. INFINITI WORLDWIDE (BVI) INCORPORATION LIMITED, ROAD TOWN, TORTOLLA, BR. VIRGIN ISLANDS, FILED 1-23-2006.

SN 78-795,637. DECKARD, JOHN G., MOORESVILLE, IN. FILED 1-20-2006.

Outlaw Nation



THE COLOR(S) BLUE, RED, YELLOW, AND BLACK IS/ ARE CLAIMED AS A FEATURE OF THE MARK.

THE WORD NOW APPEARS IN THE COLOR BLACK AND THE BOTTOM RECTANGLE IN THE DESIGN; THE COLOR BLUE APPEARS IN THE TOP RECTANGLE IN THE DESIGN; THE COLOR RED APPEARS IN THE SECOND RECTANGLE IN THE DESIGN; THE COLOR YELLOW APPEARS IN THE THIRD RECTANGLE IN THE DESIGN.

THE MARK CONSISTS OF STANDARD CHARACTERS WITHOUT CLAIM TO ANY PARTICULAR FONT, STYLE, SIZE, OR COLOR.

CLASS 25—CLOTHING

FOR MOTORSPORTS APPAREL, NAMELY, SHIRTS, T-SHIRTS, HATS, CAPS, AND JACKETS (U.S. CLS. 22 AND 39).

CLASS 35—ADVERTISING AND BUSINESS

FOR PROMOTION OF MOTORSPORTS EVENTS AND RACING SERIES (U.S. CLS. 100, 101 AND 102).
HANNO RITTNER, EXAMINING ATTORNEY

CLASS 7—MACHINERY

FOR MACHINES AND MACHINE TOOLS, NAMELY, TYPOGRAPHIC MACHINES; PRINTING MACHINES; INKING APPARATUS FOR PRINTING MACHINES; ENGRAVING MACHINES; PACKING MACHINES; CUTTING MACHINES (U.S. CLS. 13, 19, 21, 23, 31, 34 AND 35).

CLASS 9—ELECTRICAL AND SCIENTIFIC APPARATUS

FOR INK JET PRINTERS; INK JET PRINTERS FOR PRINTING IMAGES ON TEXTILES; WIDE FORMAT INK JET PRINTERS FOR BUSINESS AND COMMERCIAL APPLICATIONS, ADVERTISING, BILLBOARDS, SIGNS, BANNERS AND POSTERS; FACSIMILE MACHINES; PHOTOCOPIERS; SCANNERS (U.S. CLS. 21, 23, 26, 36 AND 38).

MARGERY A. TIERNEY, EXAMINING ATTORNEY

SN 78-798,030. FROM LTOJ SOFTWARE LLC, SCOTTSDALE, AZ. FILED 1-24-2006.

KNOWLEDGEPOWER

THE MARK CONSISTS OF STANDARD CHARACTERS WITHOUT CLAIM TO ANY PARTICULAR FONT, STYLE, SIZE, OR COLOR.

CLASS 16—PAPER GOODS AND PRINTED MATTER

FOR PRINTED MATERIALS, NAMELY, PERFORMANCE TASKS AND ASSESSMENTS IN THE NATURE OF PRINTED TESTS TO BE ADMINISTERED TO STUDENTS AND TEACHERS, BOOKS AND BOOKLETS CONTAINING INSTRUCTIONAL STRATEGIES, PREPARED LEAFLETS AND BOOK INSERTS CONTAINING STANDARDS-ALIGNED PROJECT PLANS FOR CLASSROOM PROJECTS, AND BOOKS AND BOOKLETS CONTAINING INFORMATION FROM EDUCATORS REGARDING CURRICULUM, INSTRUCTION AND ASSESSMENT (U.S. CLS. 2, 5, 22, 23, 29, 37, 38 AND 50).
FIRST USE 10-0-2005; IN COMMERCE 10-0-2005.

CLASS 41—EDUCATION AND ENTERTAINMENT

FOR PROVIDING INSTRUCTION AND EDUCATIONAL CLASSES, COURSES, SEMINARS AND WORKSHOPS TO END-USERS OF CONTINUOUS IMPROVEMENT PRACTICES FOR CAPTURING, ANALYZING, INTERPRETING AND APPLYING DATA RETRIEVED FROM MEASUREMENT OR ASSESSMENT OF RESEARCH-BASED FACTORS IMPACTING EDUCATION AND INSTRUCTIONAL QUALITY OF SCHOOL DISTRICTS AND INDIVIDUAL SCHOOLS, GRADE LEVELS AND CLASSROOMS AND DATA RETRIEVED FROM MEASUREMENT OR ASSESSMENT OF CLASSROOM INSTRUCTIONAL PRACTICES, TEACHER SKILLS, TEACHER PERCEPTIONS AND QUALITY OF STUDENT WORK, LEARNING AND ACHIEVEMENT, IN ORDER TO TEACH, DEVELOP AND IMPROVE END-USER SKILLS AND ABILITIES TO IMPLEMENT, USE AND APPLY SUCH PRACTICES; PROVIDING CUSTOMIZED ANALYSIS AND INFORMATION REGARDING SCHOOL, STUDENT AND TEACHER PERFORMANCE VIA GLOBAL COMPUTER NETWORKS FOR THE PURPOSE OF IMPROVING THE QUALITY OF EDUCATION AND ACADEMIC PERFORMANCE (U.S. CLS. 100, 101 AND 107).

FIRST USE 10-0-2005; IN COMMERCE 10-0-2005.
FRED CARL, EXAMINING ATTORNEY

SN 78-799,331. YACHT SMART, LLC, HOBOKEN, NJ. FILED 1-25-2006.

YACHT SMART

THE MARK CONSISTS OF STANDARD CHARACTERS WITHOUT CLAIM TO ANY PARTICULAR FONT, STYLE, SIZE, OR COLOR.

NO CLAIM IS MADE TO THE EXCLUSIVE RIGHT TO USE "YACHT", APART FROM THE MARK AS SHOWN.

CLASS 36—INSURANCE AND FINANCIAL

FOR FORMATION, BROKERAGE AND MANAGEMENT OF FRACTIONAL OWNERSHIP AND TIME SHARE INTERESTS IN BOATS (U.S. CLS. 100, 101 AND 102).

FIRST USE 9-29-2005; IN COMMERCE 10-13-2005.

CLASS 39—TRANSPORTATION AND STORAGE

FOR LEASING OF BOATS (U.S. CLS. 100 AND 105).

FIRST USE 9-29-2005; IN COMMERCE 10-13-2005.
GRETTA YAO, EXAMINING ATTORNEY

SN 78-799,949. PRL USA HOLDINGS, INC., WILMINGTON, DE. FILED 1-26-2006.

RRL

THE MARK CONSISTS OF STANDARD CHARACTERS WITHOUT CLAIM TO ANY PARTICULAR FONT, STYLE, SIZE, OR COLOR.

OWNER OF U.S. REG. NOS. 1,664,241, 2,027,374 AND OTHERS.

CLASS 37—CONSTRUCTION AND REPAIR

FOR PLANNING AND LAYING OUT OF RESIDENTIAL COMMUNITIES (U.S. CLS. 100, 103 AND 106).

CLASS 43—HOTEL AND RESTAURANT SERVICES

FOR HOTELS, RESTAURANTS, BAR SERVICES, COCKTAIL LOUNGES, GOLF RESORT HOTELS AND RESORT HOTELS (U.S. CLS. 100 AND 101).

CLASS 44—MEDICAL, BEAUTY AND AGRICULTURAL SERVICES

FOR HEALTH SPA SERVICES, NAMELY, COSMETIC BODY CARE SERVICES (U.S. CLS. 100 AND 101).
AMY GEARIN, EXAMINING ATTORNEY

SN 78-802,032. VIRGIN MOBILE USA, LLC, WARREN, NJ. FILED 1-30-2006.

SERVING THE GREATER GOOD

THE MARK CONSISTS OF STANDARD CHARACTERS WITHOUT CLAIM TO ANY PARTICULAR FONT, STYLE, SIZE, OR COLOR.

CLASS 9—ELECTRICAL AND SCIENTIFIC APPARATUS

FOR MOBILE TELEPHONES; TELEPHONES; MODEMS; BATTERIES; BATTERY CHARGERS; AND MOBILE TELEPHONE ACCESSORIES, NAMELY CIGARETTE LIGHTER ADAPTERS, DASHBOARD MOUNTS, HANDS-FREE HEADSETS, CARRYING CASES, AND BELT CLIPS; PERSONAL DIGITAL ASSISTANTS (U.S. CLS. 21, 23, 26, 36 AND 38).

CLASS 38—COMMUNICATION

FOR TELECOMMUNICATIONS SERVICES, NAMELY, TRANSMISSION OF VOICE, DATA, IMAGES, AUDIO, VIDEO, AND INFORMATION VIA TELEPHONE AND THE INTERNET; PERSONAL COMMUNICATIONS SERVICES; PAGER SERVICES; ELECTRONIC MAIL SERVICES; ELECTRONIC TRANSMISSION OF NEWS AND INFORMATION VIA TELEPHONE AND THE INTERNET (U.S. CLS. 100, 101 AND 104).

KATHERINE M. DUBRAY, EXAMINING ATTORNEY

SN 78-803,213. GENENTECH, INC., SOUTH SAN FRANCISCO, CA. FILED 1-31-2006.

GSPIN

THE MARK CONSISTS OF STANDARD CHARACTERS WITHOUT CLAIM TO ANY PARTICULAR FONT, STYLE, SIZE, OR COLOR.

CLASS 10—MEDICAL APPARATUS

FOR MEDICAL DEVICES, NAMELY, INJECTORS FOR ADMINISTERING MEDICINE (U.S. CLS. 26, 39 AND 44).

CLASS 44—MEDICAL, BEAUTY AND AGRICULTURAL SERVICES

FOR PROVIDING INFORMATION ON THE SUBJECT OF MEDICAL CONDITIONS AND THERAPIES RELATING TO HUMAN GROWTH HORMONE, VIA A GLOBAL COMPUTER NETWORK (U.S. CLS. 100 AND 101).

MICHAEL GAAFAR, EXAMINING ATTORNEY

SN 78-804,692. SYRACUSE UNIVERSITY, SYRACUSE, NY. FILED 2-1-2006.

FLECKMAN UNIVERSITY

THE MARK CONSISTS OF STANDARD CHARACTERS WITHOUT CLAIM TO ANY PARTICULAR FONT, STYLE, SIZE, OR COLOR.

CLASS 21—HOUSEWARES AND GLASS

FOR METAL LITTER BASKETS; MUGS; CERAMIC BEVERAGE GLASSWARE; CUPS; PLATES; TUMBLERS; DRINKING GLASSES; DRINKING STEINS; CERAMIC PIGGY BANKS AND CERAMIC FIGURINES; SOAP DISHES; TOOTHBRUSH HOLDERS; CANDLE HOLDERS NOT OF PRECIOUS METAL; CRYSTAL BEVERAGE GLASSWARE (U.S. CLS. 2, 13, 23, 29, 30, 33, 40 AND 50).

CLASS 25—CLOTHING

FOR CAPS; T-SHIRTS; SHORTS; SWEATSHIRTS; KNITTED HATS; COTTON TOPS; FLEECE SWEATSHIRTS AND PANTS; JACKETS; BOXER SHORTS; WIND RESISTANT JACKET SHELLS; NECKTIES; VISORS; INFANT AND TODDLER SPORT SHIRTS, SWEATSHIRTS, SWEATPANTS, BIB OVERALLS, T-SHIRTS, SHORTS, DIAPER PANTS OF CLOTH OR PLASTIC, ROMPERS, TANK SHIRTS, AND SOCKS; BELTS; APRONS; CLOTH AND PLASTIC BABY BIBS; SUSPENDERS; HEADBANDS; CHILDREN'S WARM-UP SUITS; WRISTBANDS; HEADWEAR; GLOVES; SNEAKERS; EARMUFFS; ATHLETIC JERSEYS; ATHLETIC SHOES; RUNNERS' SAFETY VESTS; RUGBY SHIRTS; SWEATERS; SCARVES; NIGHTGOWNS; SOCKS AND FOOTIES; BOOTIES; POLO SHIRTS; VINYL PONCHOS; LEATHER ATHLETIC FOOTWEAR; LEATHER JACKETS (U.S. CLS. 22 AND 39).

MICHAEL SOUDERS, EXAMINING ATTORNEY

SN 78-804,724. JACOBSON ACQUISITION CO., DES MOINES, IA. FILED 2-1-2006.

JACOBSON

THE MARK CONSISTS OF STANDARD CHARACTERS WITHOUT CLAIM TO ANY PARTICULAR FONT, STYLE, SIZE, OR COLOR.

OWNER OF U.S. REG. NOS. 1,867,232 AND 1,899,230. SEC. 2(F).

CLASS 35—ADVERTISING AND BUSINESS

FOR SUPPLY CHAIN MANAGEMENT SERVICES; EMPLOYMENT HIRING, RECRUITING, PLACEMENT, STAFFING AND CAREER NETWORKING SERVICES (U.S. CLS. 100, 101 AND 102).

FIRST USE 1-2-1999; IN COMMERCE 1-2-1999.

CLASS 39—TRANSPORTATION AND STORAGE

FOR WAREHOUSE SERVICES; TRANSPORTATION OF FREIGHT BY TRUCK; PACKAGING ARTICLES FOR TRANSPORTATION (U.S. CLS. 100 AND 105).

FIRST USE 0-0-1980; IN COMMERCE 0-0-1980. STEVEN R. FINE, EXAMINING ATTORNEY

SN 78-806,351. FEDERAL EXPRESS CORPORATION, MEMPHIS, TN. FILED 2-3-2006.

SN 78-808,961. CAITMIN INC., PROVIDENCIALES, TURKS/CAICOS IS., FILED 2-7-2006.



OWNER OF U.S. REG. NOS. 2,461,314, 2,800,470 AND 2,974,365.

NO CLAIM IS MADE TO THE EXCLUSIVE RIGHT TO USE "FREIGHT", APART FROM THE MARK AS SHOWN.

THE COLOR(S) PURPLE AND RED IS/ARE CLAIMED AS A FEATURE OF THE MARK.

THE COLOR PURPLE APPEARS IN THE TERM FED AND THE WORD FREIGHT AND THE COLOR RED APPEARS IN THE TERM EX. NO OTHER COLOR IS CLAIMED AS A FEATURE OF THE MARK.

CLASS 35—ADVERTISING AND BUSINESS

FOR COMPUTERIZED TRACKING AND TRACING OF FREIGHT IN TRANSIT BY LAND (U.S. CLS. 100, 101 AND 102).

FIRST USE 12-31-2001; IN COMMERCE 6-30-2002.

CLASS 39—TRANSPORTATION AND STORAGE

FOR PICK-UP, TRANSPORTATION AND DELIVERY OF FREIGHT TRANSPORTED BY LAND (U.S. CLS. 100 AND 105).

FIRST USE 12-31-2001; IN COMMERCE 6-30-2002.

MELVIN AXILBUND, EXAMINING ATTORNEY

SN 78-808,624. DEMAND SHOES, LLC, BRIDGETON, MO. FILED 2-7-2006.

LUICHINY

THE MARK CONSISTS OF STANDARD CHARACTERS WITHOUT CLAIM TO ANY PARTICULAR FONT, STYLE, SIZE, OR COLOR.

OWNER OF U.S. REG. NO. 2,873,771.

CLASS 25—CLOTHING

FOR CLOTHING, NAMELY, T-SHIRTS, PANTS, JEANS, JACKETS, JACKETS MADE OF DENIM, VESTS, VESTS MADE OF DENIM; HEADGEAR, NAMELY, HATS AND CAPS (U.S. CLS. 22 AND 39).

CLASS 35—ADVERTISING AND BUSINESS

FOR RETAIL STORE SERVICES FEATURING CLOTHING, NAMELY, T-SHIRTS, PANTS, JEANS, JACKETS, JACKETS MADE OF DENIM, VESTS, VESTS MADE OF DENIM; HEADGEAR, NAMELY, HATS AND CAPS (U.S. CLS. 100, 101 AND 102).

ANDREA K. NADELMAN, EXAMINING ATTORNEY

minima

THE MARK CONSISTS OF STANDARD CHARACTERS WITHOUT CLAIM TO ANY PARTICULAR FONT, STYLE, SIZE, OR COLOR.

THE FOREIGN WORDING IN THE MARK TRANSLATES INTO ENGLISH AS MINIMUMS.

CLASS 3—COSMETICS AND CLEANING PREPARATIONS

FOR SHAMPOOS, FACIAL WASHES AND SKIN MOISTURIZERS FOR DRY SKIN (U.S. CLS. 1, 4, 6, 50, 51 AND 52).

CLASS 5—PHARMACEUTICALS

FOR MEDICATED SHAMPOOS, FACIAL WASHES AND SKIN MOISTURIZERS FOR DRY SKIN (U.S. CLS. 6, 18, 44, 46, 51 AND 52).

SUNG IN, EXAMINING ATTORNEY

SN 78-810,118. LOGITECH INTERNATIONAL S.A., 1122 ROMANEL-SUR-MORGES, SWITZERLAND, FILED 2-8-2006.

PLAYGEAR

THE MARK CONSISTS OF STANDARD CHARACTERS WITHOUT CLAIM TO ANY PARTICULAR FONT, STYLE, SIZE, OR COLOR.

CLASS 9—ELECTRICAL AND SCIENTIFIC APPARATUS

FOR ACCESSORIES FOR PORTABLE VIDEO GAME PLAYERS, NAMELY, AMPLIFIERS, KEYBOARDS, HEADPHONES, EAR PHONES, CONNECTORS FOR HEADPHONES; PROTECTIVE SHIELDS FOR SCREENS OF PORTABLE VIDEO GAME PLAYERS; AND CARRYING CASES AND PROTECTIVE CASES FOR PORTABLE VIDEO GAME PLAYERS (U.S. CLS. 21, 23, 26, 36 AND 38).

FIRST USE 4-30-2005; IN COMMERCE 4-30-2005.

CLASS 16—PAPER GOODS AND PRINTED MATTER

FOR DRAWING TEMPLATES AND SHEETS OF PAPER SOLD TOGETHER AS KITS FOR PRINTING COVERS FOR CARRYING CASES (U.S. CLS. 2, 5, 22, 23, 29, 37, 38 AND 50).

FIRST USE 4-30-2005; IN COMMERCE 4-30-2005.

BERYL GARDNER, EXAMINING ATTORNEY

SN 78-811,189. VISION DATABASE SYSTEMS INC., JUPITER, FL. FILED 2-9-2006.

SN 78-813,268. SGY ENTERPRISES LLC, ST. LOUIS, MO. FILED 2-13-2006.



VISIONBASE

THE MARK CONSISTS OF STANDARD CHARACTERS WITHOUT CLAIM TO ANY PARTICULAR FONT, STYLE, SIZE, OR COLOR.
OWNER OF U.S. REG. NO. 2,522,181.

CLASS 9—ELECTRICAL AND SCIENTIFIC APPARATUS

FOR COMPUTER SOFTWARE USED FOR CREATING IDENTIFICATION AND SECURITY SYSTEMS (U.S. CLS. 21, 23, 26, 36 AND 38).
FIRST USE 5-24-1997; IN COMMERCE 5-24-1997.

CLASS 42—SCIENTIFIC, COMPUTER AND LEGAL SERVICES

FOR COMPUTER SERVICES NAMELY DESIGNING AND DEVELOPING COMPUTER SOFTWARE FOR OTHERS (U.S. CLS. 100 AND 101).
FIRST USE 5-24-1997; IN COMMERCE 5-24-1997.
WILLIAM ROSSMAN, EXAMINING ATTORNEY

CLASS 16—PAPER GOODS AND PRINTED MATTER

FOR CARTOONS, NAMELY, NEWSPAPER CARTOONS; PRINTED MATTER AND PAPER GOODS, NAMELY, BOOKS FEATURING CHARACTERS FROM ANIMATED, ACTION ADVENTURE, COMEDY AND/OR DRAMA FEATURES, COMIC BOOKS, CHILDREN'S BOOKS, MAGAZINES FEATURING CHARACTERS FROM ANIMATED, ACTION ADVENTURE, COMEDY AND/OR DRAMA FEATURES, COLORING BOOKS, CHILDREN'S ACTIVITY BOOKS; PERSONAL ORGANIZERS; ADDRESS BOOKS; BOOK MARKS; FABRIC GIFT BAGS; PAPER GIFT BAGS; PAPER PARTY BAGS; STICKERS; CALENDARS; STATIONERY, WRITING PAPER, ENVELOPES, NOTEBOOKS, DIARIES, NOTE CARDS, GREETING CARDS, TRADING CARDS; LITHOGRAPHS; SCHOOL AND OFFICE SUPPLIES, NAMELY, PENS, PENCILS AND CASES THEREFOR, ERASERS, CRAYONS, MARKERS, COLORED PENCILS, PAINTING SETS, CHALK AND CHALKBOARDS; TEMPORARY TATTOOS, DECALS, HEAT TRANSFER PAPER; POSTERS; MOUNTED AND/OR UNMOUNTED PHOTOGRAPHS; BOOK COVERS, GIFT WRAPPING PAPER; PAPER PARTY FAVORS AND PAPER PARTY DECORATIONS—NAMELY, PAPER NAPKINS, PAPER DOILIES, PAPER PLACE MATS, CREPE PAPER, PAPER HATS, INVITATIONS, NAMELY, INVITATION CARDS AND PRINTED INVITATIONS, PAPER TABLE CLOTHS, PAPER CAKE DECORATIONS (U.S. CLS. 2, 5, 22, 23, 29, 37, 38 AND 50).

CLASS 28—TOYS AND SPORTING GOODS

FOR TOYS, GAMES AND PLAYTHINGS, NAMELY, ACTION FIGURES AND ACCESSORIES THEREFOR; STUFFED ANIMALS; DOLLS; PLUSH TOYS; BATHTUB TOYS; BALLOONS; BOARD GAMES; TOY CANDY DISPENSERS AND HOLDERS; CARD GAMES; TOY VEHICLES; STAND ALONE VIDEO GAME MACHINES; HAND HELD UNITS FOR PLAYING ELECTRONIC GAMES; HI BOUNCE BALLS; COSTUME MASKS; PAPER FACE MASKS; TOY MODEL VEHICLES AND RELATED ACCESSORIES THEREFOR SOLD AS UNITS; TOY PEDAL CARS; PLAYSETS FOR ACTION FIGURES; PLAYSETS FOR TOY VEHICLES; SKATEBOARDS; TOY BANKS; TOY MODEL HOBBYCRAFT KITS; JIGSAW AND MANIPULATIVE PUZZLES; ROLLER SKATES; IN-LINE SKATES; CHRISTMAS TREE ORNAMENTS; AMUSEMENT PARK RIDES; TOY VEHICLES MADE OF NON-PRECIOUS METALS; BEACH TOYS, NAMELY, INFLATABLE TOYS; WATER SQUIRTING TOYS; CONSTRUCTION TOYS; TOY BUILDING BLOCKS AND CONNECTING LINKS FOR THE SAME; PROTECTIVE PADS AND PADDING FOR SKATEBOARDING, IN-LINE SKATING, AND ROLLER SKATING; TOY COIN BANKS; PINBALL MACHINES; INFLATABLE SWIMMING POOLS; INFLATABLE POOL TOYS; TOY SNOW GLOBES (U.S. CLS. 22, 23, 38 AND 50).
KATHERINE M. DUBRAY, EXAMINING ATTORNEY

SN 78-814,422. WENGER, JACQUELINE, NEW YORK, NY.
FILED 2-14-2006.

LULU DE GRENOUILLE

THE MARK CONSISTS OF STANDARD CHARACTERS WITHOUT CLAIM TO ANY PARTICULAR FONT, STYLE, SIZE, OR COLOR.

THE NAME SHOWN IN THE MARK DOES NOT IDENTIFY A PARTICULAR LIVING INDIVIDUAL.

THE ENGLISH TRANSLATION OF THE FOREIGN WORDING "DE GRENOUILLE" IS "OF FROG".

CLASS 14—JEWELRY

FOR JEWELRY, NAMELY, BRACELETS, RINGS, EARRINGS, NECKLACES AND PINS; JEWELRY FOR PETS NAMELY, NECKLACES (U.S. CLS. 2, 27, 28 AND 50).

CLASS 18—LEATHER GOODS

FOR TOTE BAGS, POCKETBOOKS; CLOTHING FOR PETS, NAMELY, T-SHIRTS (U.S. CLS. 1, 2, 3, 22 AND 41).

CLASS 24—FABRICS

FOR HOME DECOR, NAMELY PILLOWCASES (U.S. CLS. 42 AND 50).

CLASS 25—CLOTHING

FOR BABY CLOTHING, NAMELY, BABY HATS, BABY T-SHIRTS, BABY PANTS; CLOTHING FOR WOMEN, NAMELY, T-SHIRTS, TOPS, SKIRTS, SHORTS, DRESSES, BELTS, SWIMWEAR, BEACHWEAR, SCARVES; CLOTHING FOR MEN, NAMELY, T-SHIRTS, UNDERWEAR; CLOTHING FOR KIDS, NAMELY, T-SHIRTS, PANTS, DRESSES, TROUSERS AND SHORTS (U.S. CLS. 22 AND 39).

CARRIE ACHEN, EXAMINING ATTORNEY

SN 78-814,752. THOMAS, CORY, MON REPOS, TRINIDAD/
TOBAGO, FILED 2-14-2006.

WATCH YOUR HEAD

THE MARK CONSISTS OF STANDARD CHARACTERS WITHOUT CLAIM TO ANY PARTICULAR FONT, STYLE, SIZE, OR COLOR.

CLASS 16—PAPER GOODS AND PRINTED MATTER

FOR PRINTED MATTER, NAMELY, A NEWSPAPER COMIC STRIP, A CARTOON STRIP (U.S. CLS. 2, 5, 22, 23, 29, 37, 38 AND 50).

FIRST USE 3-1-2006; IN COMMERCE 3-1-2006.

CLASS 41—EDUCATION AND ENTERTAINMENT

FOR ENTERTAINMENT SERVICES, NAMELY, PROVIDING A COMIC STRIP VIA A GLOBAL COMPUTER INFORMATION NETWORK (U.S. CLS. 100, 101 AND 107).

FIRST USE 3-1-2006; IN COMMERCE 3-1-2006.

CARRIE ACHEN, EXAMINING ATTORNEY

SN 78-818,023. LORDSMEN, THE, ELKVIEW, WV. FILED 2-17-2006.

THE LORDSMEN

THE MARK CONSISTS OF STANDARD CHARACTERS WITHOUT CLAIM TO ANY PARTICULAR FONT, STYLE, SIZE, OR COLOR.

CLASS 9—ELECTRICAL AND SCIENTIFIC APPARATUS

FOR SERIES OF PRE-RECORDED CASSETTE TAPES, COMPACT DISCS AND VIDEOS FEATURING GOSPEL MUSIC (U.S. CLS. 21, 23, 26, 36 AND 38).

FIRST USE 5-13-1966; IN COMMERCE 11-2-1970.

CLASS 41—EDUCATION AND ENTERTAINMENT

FOR ENTERTAINMENT IN THE NATURE OF LIVE PERFORMANCES BY A SOUTHERN-STYLE GOSPEL MUSIC GROUP (U.S. CLS. 100, 101 AND 107).

FIRST USE 5-13-1966; IN COMMERCE 11-2-1970.

RONALD MCMORROW, EXAMINING ATTORNEY

SN 78-819,501. NATIONAL TREE COMPANY, CRANFORD,
NJ. FILED 2-21-2006.

CLEAR VIEW

THE MARK CONSISTS OF STANDARD CHARACTERS WITHOUT CLAIM TO ANY PARTICULAR FONT, STYLE, SIZE, OR COLOR.

CLASS 16—PAPER GOODS AND PRINTED MATTER

FOR PLASTIC BAGS FOR HOUSEHOLD USE, NAMELY FOR PACKING AND PACKAGING (U.S. CLS. 2, 5, 22, 23, 29, 37, 38 AND 50).

CLASS 22—CORDAGE AND FIBERS

FOR PLASTIC AND VINYL BAGS USED FOR THE STORAGE OF HOUSEHOLD ITEMS (U.S. CLS. 1, 2, 7, 19, 22, 42 AND 50).

KATHERINE CHANG, EXAMINING ATTORNEY

SN 78-820,632. SYNGENTA PARTICIPATIONS AG, BASEL, SWITZERLAND, FILED 2-22-2006.

SN 78-820,721. THOMSON, JIM, BILTON, RUGBY CV22 7PY, UNITED KINGDOM, FILED 2-22-2006.



VALARIS

THE MARK CONSISTS OF STANDARD CHARACTERS WITHOUT CLAIM TO ANY PARTICULAR FONT, STYLE, SIZE, OR COLOR.

CLASS 1—CHEMICALS

FOR CHEMICALS USED IN INDUSTRY; ADJUVANTS FOR USE IN THE MANUFACTURE OF HERBICIDES AND INSECTICIDES FOR USE IN AGRICULTURE, HORTICULTURE AND FORESTRY; UNPROCESSED ARTIFICIAL RESINS AS RAW MATERIALS IN THE FORM OF POWDERS, LIQUIDS OR PASTES; UNPROCESSED PLASTIC MATERIALS IN POWDER, LIQUID OR PASTE FORM; INDUSTRIAL ADHESIVES FOR USE IN COATING AND SEALING (U.S. CLS. 1, 5, 6, 10, 26 AND 46).

CLASS 2—PAINTS

FOR PAINTS, VARNISHES, AND LACQUERS; RUST PRESERVATIVES IN THE NATURE OF A COATING; WOOD PRESERVATIVES (U.S. CLS. 6, 11 AND 16).

CLASS 5—PHARMACEUTICALS

FOR PREPARATIONS FOR DESTROYING VERMIN; FUNGICIDES AND HERBICIDES, ALL FOR AGRICULTURAL USE (U.S. CLS. 6, 18, 44, 46, 51 AND 52).

CLASS 17—RUBBER GOODS

FOR RUBBER; GUTTA-PERCHA, GUM, ASBESTOS AND MICA TO MAKE OTHER GOODS IN THE FORM OF PELLETS, SHEETS, RODS, SLABS AND SHAPED PIECES; PLASTICS IN EXTRUDED FORM FOR USE IN MANUFACTURE; PACKING MATERIAL FOR FORMING SEALS; RUBBER STOPPERS FOR INDUSTRIAL PACKAGING CONTAINERS; INSULATING MATERIALS, NAMELY POLYURETHANE FOAM AND POLYETHYLENE FOAM; FLEXIBLE PIPES, NOT OF METAL (U.S. CLS. 1, 5, 12, 13, 35 AND 50).

CLASS 19—NON-METALLIC BUILDING MATERIALS

FOR NON-METALLIC RIGID PIPES FOR BUILDING; NON-METALLIC TRANSPORTABLE BUILDINGS (U.S. CLS. 1, 12, 33 AND 50).
GILBERT SWIFT, EXAMINING ATTORNEY

THE MARK CONSISTS OF THE WORD TRANSPORTATION, WITH THE LETTERS "A" STYLIZED AND DEPICTED AS ROAD SIGNAGE AND ROUTE DIRECTIONAL ARROWS AND THE LETTERS "O" STYLIZED AND DEPICTED AS VEHICLE WHEELS AND TIRES, SUPERIMPOSED OVER A MAP OUTLINE OF THE UNITED STATES.

CLASS 9—ELECTRICAL AND SCIENTIFIC APPARATUS

FOR COMPUTER GAME SOFTWARE; COMPUTER GAME EQUIPMENT, NAMELY, FREE-STANDING CONSOLES WITH INTEGRAL KEYBOARD AND DISPLAY SCREEN, AND KEYBOARD-ONLY MODULES ADAPTED FOR USE WITH REMOTE DISPLAY SCREENS; COMPUTER GAME SOFTWARE DOWNLOADABLE FROM THE INTERNET; SOFTWARE FOR MULTIPLE PARTICIPANT INTERACTIVE COMPUTER GAMES AT REMOTE LOCATIONS (U.S. CLS. 21, 23, 26, 36 AND 38).

CLASS 28—TOYS AND SPORTING GOODS

FOR GAMES, TOYS AND PLAYTHINGS, NAMELY, PLAYING PIECES, BOARDS AND PLAYING SURFACES FOR BOARD GAMES; EQUIPMENT SOLD AS A UNIT FOR USE IN PLAYING BOARD GAMES; INDIVIDUAL BOARD GAMES AND COLLECTIONS OF MULTIPLE BOARD GAMES SOLD AS A UNIT; HAND-HELD SELF-CONTAINED, PORTABLE COMPUTER GAME EQUIPMENT, NAMELY, HAND-HELD DEVICES WITH INTEGRAL KEYBOARD AND DISPLAY (U.S. CLS. 22, 23, 38 AND 50).

JAMES MACFARLANE, EXAMINING ATTORNEY

SN 78-822,775. THE PROCTER & GAMBLE COMPANY, CINCINNATI, OH. FILED 2-24-2006.

MELON CHILL

THE MARK CONSISTS OF STANDARD CHARACTERS WITHOUT CLAIM TO ANY PARTICULAR FONT, STYLE, SIZE, OR COLOR.

NO CLAIM IS MADE TO THE EXCLUSIVE RIGHT TO USE "MELON", APART FROM THE MARK AS SHOWN.

CLASS 3—COSMETICS AND CLEANING PREPARATIONS

FOR TOOTHPASTE, ORAL RINSES (U.S. CLS. 1, 4, 6, 50, 51 AND 52).

CLASS 21—HOUSEWARES AND GLASS

FOR DENTAL FLOSS (U.S. CLS. 2, 13, 23, 29, 30, 33, 40 AND 50).
CHRIS WELLS, EXAMINING ATTORNEY

SN 78-823,908. ONE SCOTTSDALE HOLDINGS LLC,
SCOTTSDALE, AZ. FILED 2-27-2006.



ONE SCOTTSDALE

NO CLAIM IS MADE TO THE EXCLUSIVE RIGHT TO USE "SCOTTSDALE", APART FROM THE MARK AS SHOWN.

CLASS 36—INSURANCE AND FINANCIAL

FOR REAL ESTATE BROKERAGE SERVICES FOR CUSTOM HOMES, PRODUCTION HOME AND CUSTOM HOME SITES (U.S. CLS. 100, 101 AND 102).

CLASS 37—CONSTRUCTION AND REPAIR

FOR REAL ESTATE DEVELOPMENT SERVICES, NAMELY, THE DEVELOPMENT OF MASTER PLANNED COMMUNITIES, PLANNING AND DEVELOPMENT OF RESIDENTIAL COMMUNITIES, INCLUDING HOUSES AND APARTMENTS; COMMERCIAL PROPERTIES, INDUSTRIAL BUILDINGS, OFFICE AND RETAIL SPACE (U.S. CLS. 100, 103 AND 106).
CAROLYN CATALDO, EXAMINING ATTORNEY

SN 78-823,941. DREAMWORKS ANIMATION L.L.C., GLENDALE, CA. FILED 2-27-2006.

OVER THE HEDGE

THE MARK CONSISTS OF STANDARD CHARACTERS WITHOUT CLAIM TO ANY PARTICULAR FONT, STYLE, SIZE, OR COLOR.

CLASS 9—ELECTRICAL AND SCIENTIFIC APPARATUS

FOR COMPUTER PERIPHERAL, NAMELY MOUSE PADS, HOLDERS FOR COMPACT DISCS, COMPUTER GAME CARTRIDGES, COMPUTER GAME CASSETTES, AND COMPUTER GAME TAPES; VIDEO GAME CARTRIDGES, VIDEO GAME CASSETTES; PRERECORDED AUDIO CASSETTES FEATURING MOTION PICTURE SOUNDTRACKS, PRERECORDED VIDEO CASSETTES FEATURING ANIMATED MOTION PICTURES, PRERECORDED AUDIO TAPES FEATURING MOTION PICTURE SOUNDTRACKS, PRERECORDED VIDEO TAPES FEATURING ANIMATED MOTION PICTURES, PRERECORDED DISCS FEATURING MUSIC AND MOTION PICTURE SOUND TRACKS; CD ROM AND DVD PROGRAMS FEATURING MUSIC AND MOTION PICTURE SOUND TRACKS; COMPUTER OPERATING SYSTEM SOFTWARE; PRERECORDED COMPUTER SOFTWARE PROGRAMS FEATURING MUSIC AND MOTION PICTURE SOUND TRACKS; INTERACTIVE MULTIMEDIA SOFTWARE PROGRAMS CONTAINING MOTION PICTURES FOR ENTERTAINMENT; INTERACTIVE MULTI-MEDIA SOFTWARE FOR PLAYING GAMES; MAGNETS AND SUNGLASSES (U.S. CLS. 21, 23, 26, 36 AND 38).

CLASS 25—CLOTHING

FOR SHIRTS AND TOPS, DRESSES, SKIRTS, PANTS, TROUSERS, JEANS, SHORTS, ROMPERS, OVERALLS, SWEATSHIRTS AND SWEAT PANTS, SWEATSUITS, CAPS AND HATS, GLOVES, SUSPENDERS, TIES, COATS AND JACKETS, HOSIERY, SHOES, BOOTS, SLIPPERS, PAJAMAS, ROBES, SLEEPSHIRTS, SLEEPWEAR, UNDERWEAR, HALLOWEEN COSTUMES, AND CLOTH BABY BIBS (U.S. CLS. 22 AND 39).

CLASS 28—TOYS AND SPORTING GOODS

FOR ACTION FIGURES AND ACCESSORIES THEREFOR, BATHTUB TOYS, KITES, TOY BUILDING BLOCKS, BOARD GAMES, COSTUME MASKS, HANDHELD UNIT FOR PLAYING ELECTRONIC GAMES, DIE CAST MINIATURE TOY VEHICLES, DOLLS, DOLL ACCESSORIES, DOLL CLOTHING, BEAN BAG DOLLS, BENDABLE PLAY FIGURES, FLYING DISCS, INFLATABLE VINYL PLAY FIGURES, JIGSAW PUZZLES, MARBLES, PLUSH TOYS, PUPPETS, RIDE-ON TOYS, SKATEBOARDS, BALLOONS, ROLLERSKATES, TOY BANKS, WATER SQUIRTING TOYS, STUFFED TOYS, TOY VEHICLES, CHRISTMAS TREE ORNAMENTS; PINBALL MACHINES AND MODEL CRAFT KITS OF TOY FIGURES; AND PLAYING CARDS (U.S. CLS. 22, 23, 38 AND 50).

JULIE GUTTADAURO, EXAMINING ATTORNEY

SN 78-824,611. CAREFLASH, LLC, HOUSTON, TX. FILED 2-27-2006.

CAREFLASH

THE MARK CONSISTS OF STANDARD CHARACTERS WITHOUT CLAIM TO ANY PARTICULAR FONT, STYLE, SIZE, OR COLOR.

CLASS 35—ADVERTISING AND BUSINESS

FOR PROVIDING AND RENTAL OF ONLINE ADVERTISING SPACE TO OTHERS VIA A GLOBAL COMPUTER INFORMATION NETWORK (U.S. CLS. 100, 101 AND 102).

CLASS 38—COMMUNICATION

FOR PROVIDING MULTIPLE-USER ACCESS TO A GLOBAL COMPUTER INFORMATION NETWORK FOR INTERACTION AND COMMUNICATION WITH OTHER COMPUTER USERS (U.S. CLS. 100, 101 AND 104).

CLASS 44—MEDICAL, BEAUTY AND AGRICULTURAL SERVICES

FOR PROVIDING INFORMATION IN THE FIELD OF HEALTHCARE VIA WEBSITES ON THE INTERNET (U.S. CLS. 100 AND 101).

MARLENE BELL, EXAMINING ATTORNEY

CLASS 41—EDUCATION AND ENTERTAINMENT

FOR EDUCATION SERVICES, NAMELY, CONFERENCES, CLASSES, WORKSHOPS AND SEMINARS ON THE SUBJECT OF EYE DISEASES (U.S. CLS. 100, 101 AND 107).

CLASS 42—SCIENTIFIC, COMPUTER AND LEGAL SERVICES

FOR MEDICAL RESEARCH (U.S. CLS. 100 AND 101).
LEIGH CAROLINE CASE, EXAMINING ATTORNEY

SN 78-824,947. PILGRIM HOME AND HEARTH, LLC, FAIRFIELD, CA. FILED 2-28-2006.

SN 78-826,337. NOTICE RECORDS, INC., CHARLOTTE, NC. FILED 3-1-2006.

NAPA FORGE

THE MARK CONSISTS OF STANDARD CHARACTERS WITHOUT CLAIM TO ANY PARTICULAR FONT, STYLE, SIZE, OR COLOR.

NO CLAIM IS MADE TO THE EXCLUSIVE RIGHT TO USE "NAPA", APART FROM THE MARK AS SHOWN.

CLASS 8—HAND TOOLS

FOR FIREPLACE POKERS; FIREPLACE SHOVELS; FIREPLACE TONGS; FIREPLACE TOOL SETS SOLD AS A UNIT (U.S. CLS. 23, 28 AND 44).

CLASS 20—FURNITURE AND ARTICLES NOT OTHERWISE CLASSIFIED

FOR FIREPLACE SCREENS (U.S. CLS. 2, 13, 22, 25, 32 AND 50).

YONG KIM, EXAMINING ATTORNEY

SN 78-825,719. NERBY, JILL A., CORDOVA, TN. FILED 2-28-2006.



*Aniridia Foundation
International*

NO CLAIM IS MADE TO THE EXCLUSIVE RIGHT TO USE ANIRIDIA FOUNDATION INTERNATIONAL, APART FROM THE MARK AS SHOWN.

CLASS 35—ADVERTISING AND BUSINESS

FOR ASSOCIATION SERVICES, NAMELY, PROMOTING THE INTERESTS OF EYE DISEASE PATIENTS (U.S. CLS. 100, 101 AND 102).

NOTICE RECORDS

THE MARK CONSISTS OF STANDARD CHARACTERS WITHOUT CLAIM TO ANY PARTICULAR FONT, STYLE, SIZE, OR COLOR.

NO CLAIM IS MADE TO THE EXCLUSIVE RIGHT TO USE "RECORDS", APART FROM THE MARK AS SHOWN.

CLASS 9—ELECTRICAL AND SCIENTIFIC APPARATUS

FOR PRERECORDED AUDIO AND VIDEO TAPES, DIGITAL AUDIO AND VIDEO TAPES, COMPACT DISCS, DIGITAL VERSATILE DISCS (DVDs) AND DIGITAL FILES FEATURING MUSIC (U.S. CLS. 21, 23, 26, 36 AND 38).

CLASS 41—EDUCATION AND ENTERTAINMENT

FOR ENTERTAINMENT SERVICES, NAMELY, PROVIDING PRERECORDED MUSIC AND INFORMATION IN THE FIELD OF MUSIC ALL ON-LINE VIA A GLOBAL COMPUTER NETWORK; MUSIC PRODUCTION SERVICES; PRODUCTION OF VIDEO DISCS FOR OTHERS (U.S. CLS. 100, 101 AND 107).

JUSTINE D. PARKER, EXAMINING ATTORNEY

SN 78-826,398. ITALIAN AMERICAN CHANNEL, INC., PARAMUS, NJ. FILED 3-1-2006.

CIAO TV

THE MARK CONSISTS OF STANDARD CHARACTERS WITHOUT CLAIM TO ANY PARTICULAR FONT, STYLE, SIZE, OR COLOR.

NO CLAIM IS MADE TO THE EXCLUSIVE RIGHT TO USE "TV", APART FROM THE MARK AS SHOWN.

THE FOREIGN WORDING IN THE MARK TRANSLATES INTO ENGLISH AS HELLO OR GOODBYE.

CLASS 38—COMMUNICATION

FOR BROADCASTING OF AN ENGLISH SPEAKING TELEVISION PROGRAM RELATING TO ITALIAN SUBJECTS (U.S. CLS. 100, 101 AND 104).

CLASS 41—EDUCATION AND ENTERTAINMENT

FOR PRODUCTION OF AN ENGLISH SPEAKING TELEVISION PROGRAM RELATING TO ITALIAN SUBJECTS (U.S. CLS. 100, 101 AND 107).
DAWN FELDMAN, EXAMINING ATTORNEY

SN 78-826,563. SUPERIOR CONCRETE, INC., HARRISONBURG, VA. FILED 3-1-2006.

Virginia Shade

THE MARK CONSISTS OF STANDARD CHARACTERS WITHOUT CLAIM TO ANY PARTICULAR FONT, STYLE, SIZE, OR COLOR.
NO CLAIM IS MADE TO THE EXCLUSIVE RIGHT TO USE "VIRGINIA", APART FROM THE MARK AS SHOWN.

CLASS 1—CHEMICALS

FOR CONCRETE ADDITIVE FOR USE IN A COLORED CONCRETE SYSTEM FOR DRIVEWAYS, PATIOS, AND OTHER FINISHED CONCRETE SURFACES (U.S. CLS. 1, 5, 6, 10, 26 AND 46).
FIRST USE 6-15-2005; IN COMMERCE 6-15-2005.

CLASS 2—PAINTS

FOR COLORED PIGMENTS FOR USE IN A COLORED CONCRETE SYSTEM FOR DRIVEWAYS, PATIOS, AND OTHER FINISHED CONCRETE SURFACES (U.S. CLS. 6, 11 AND 16).
FIRST USE 6-15-2005; IN COMMERCE 6-15-2005.
TONJA GASKINS, EXAMINING ATTORNEY

SN 78-827,444. DROBNIS, MICHAEL H, SPRINGFIELD, VA. FILED 3-2-2006.

SURGERY WORKS

THE MARK CONSISTS OF STANDARD CHARACTERS WITHOUT CLAIM TO ANY PARTICULAR FONT, STYLE, SIZE, OR COLOR.
NO CLAIM IS MADE TO THE EXCLUSIVE RIGHT TO USE "SURGERY", APART FROM THE MARK AS SHOWN.

CLASS 9—ELECTRICAL AND SCIENTIFIC APPARATUS

FOR COMPUTER SOFTWARE FOR USE IN SURGERY PREPARATION, SURGERY SCHEDULING, SURGERY RECORDATION, MEDICAL FORM CREATION AND DISTRIBUTION, PATIENT DEMOGRAPHICS AND INFORMATION, PATIENT INSURANCE INFORMATION ALL IN THE FIELD OF MEDICAL RECORDS AND MEDICAL SERVICE; DATABASE MANAGEMENT SOFTWARE FOR THE DEVELOPMENT OF ON-LINE MEDICAL INFORMATION PROFILES AND ON-LINE SURGERY RELATED PREPARATORY FORMS; MEDICAL SOFTWARE FOR USE IN THE PROCESS OF SURGERY PREPARATION, SURGERY SCHEDULING, SURGERY RECORDATION, MEDICAL FORM CREATION AND DISTRIBUTION, PATIENT DEMOGRAPHICS AND INFORMATION, PATIENT INSURANCE INFORMATION, ALL IN THE FIELD OF MEDICAL RECORDS AND MEDICAL SERVICE (U.S. CLS. 21, 23, 26, 36 AND 38).

CLASS 42—SCIENTIFIC, COMPUTER AND LEGAL SERVICES

FOR COMPUTER SOFTWARE DEVELOPMENT; CUSTOMIZATION OF COMPUTER HARDWARE AND SOFTWARE; DESIGN AND DEVELOPMENT OF ONLINE COMPUTER SOFTWARE SYSTEMS; PROVIDING ONLINE NON-DOWNLOADABLE SOFTWARE FOR USE IN SURGERY PREPARATION, SURGERY SCHEDULING, SURGERY RECORDATION, MEDICAL FORM CREATION AND DISTRIBUTION, PATIENT DEMOGRAPHICS AND INFORMATION, PATIENT INSURANCE INFORMATION ALL IN THE FIELD OF MEDICAL RECORDS AND MEDICAL SERVICE (U.S. CLS. 100 AND 101).
CHERYL CLAYTON, EXAMINING ATTORNEY

SN 78-828,350. PITTSFIELD CHARTER TOWNSHIP, ANN ARBOR, MI. FILED 3-3-2006.



NO CLAIM IS MADE TO THE EXCLUSIVE RIGHT TO USE "TWP.", APART FROM THE MARK AS SHOWN. SEC. 2(F) AS TO "PITTSFIELD TWP.".

CLASS 35—ADVERTISING AND BUSINESS

FOR PROMOTING THE BUSINESS, MUNICIPAL AND CIVIC INTERESTS OF BUSINESSES AND CITIZENS OF PITTSFIELD TOWNSHIP, MICHIGAN (U.S. CLS. 100, 101 AND 102).
FIRST USE 7-0-1987; IN COMMERCE 1-0-2000.

CLASS 42—SCIENTIFIC, COMPUTER AND LEGAL SERVICES

FOR MUNICIPAL GOVERNMENT SERVICES, NAMELY, ESTABLISHING AND ENFORCING BUILDING AND ZONING CODES AND REGULATING DEVELOPMENT WITHIN THE TOWNSHIP (U.S. CLS. 100 AND 101).
FIRST USE 7-0-1987; IN COMMERCE 1-0-2000.
MARK PILARO, EXAMINING ATTORNEY

SN 78-828,382. BLUE ZONE ENTERTAINMENT, LLC, NEW YORK, NY. FILED 3-3-2006.

SN 78-830,584. DC SHOES, INC., VISTA, CA. FILED 3-6-2006.

Blue Zone Entertainment

THE MARK CONSISTS OF STANDARD CHARACTERS WITHOUT CLAIM TO ANY PARTICULAR FONT, STYLE, SIZE, OR COLOR.

NO CLAIM IS MADE TO THE EXCLUSIVE RIGHT TO USE "ENTERTAINMENT", APART FROM THE MARK AS SHOWN.

CLASS 9—ELECTRICAL AND SCIENTIFIC APPARATUS

FOR PRE-RECORDED CD'S, VIDEO TAPES, LASER DISKS AND DVD'S FEATURING MUSICAL ENTERTAINMENT, CELEBRITY INTERVIEWS, ENTERTAINER BIOGRAPHIES, LIVE PERFORMANCES BY MUSICAL ENTERTAINERS, DOCUMENTARY PROGRAMS FEATURING ENTERTAINERS IN THE MUSIC AND MOVIES INDUSTRIES (U.S. CLS. 21, 23, 26, 36 AND 38).

CLASS 35—ADVERTISING AND BUSINESS

FOR PERSONAL MANAGEMENT SERVICES FOR ENTERTAINERS (U.S. CLS. 100, 101 AND 102).
AMY BROZENIC, EXAMINING ATTORNEY

SN 78-828,474. WELLINGTON, RUDOLFO, NEW YORK, NY. FILED 3-3-2006.

Rolo

THE MARK CONSISTS OF STANDARD CHARACTERS WITHOUT CLAIM TO ANY PARTICULAR FONT, STYLE, SIZE, OR COLOR.

CLASS 9—ELECTRICAL AND SCIENTIFIC APPARATUS

FOR PRE-RECORDED CD'S, VIDEO TAPES, LASER DISKS AND DVD'S FEATURING MUSICAL ENTERTAINERS AND A MUSICAL BAND (U.S. CLS. 21, 23, 26, 36 AND 38).

CLASS 41—EDUCATION AND ENTERTAINMENT

FOR ENTERTAINMENT, NAMELY LIVE PERFORMANCES BY MUSICAL BANDS (U.S. CLS. 100, 101 AND 107).
JENNIFER KRISP, EXAMINING ATTORNEY

SEVEN POINT

THE MARK CONSISTS OF STANDARD CHARACTERS WITHOUT CLAIM TO ANY PARTICULAR FONT, STYLE, SIZE, OR COLOR.

CLASS 18—LEATHER GOODS

FOR TRAVEL BAGS; CARRY ALL BAGS; HANDBAGS; BEACH BAGS; TOTE BAGS; BAGS FOR CARRYING BATHING ACCESSORIES; SPORTS BAGS; FELT POUCHES, LEATHER POUCHES, DRAWSTRING POUCHES, ALL SOLD EMPTY; BACKPACKS; PURSES; WALLETS; SATCHELS; BRIEF CASES; ATTACHE CASES; SUITCASES; KEY CASES; UMBRELLAS; COSMETIC CASES SOLD EMPTY (U.S. CLS. 1, 2, 3, 22 AND 41).

CLASS 25—CLOTHING

FOR FOOTWEAR; HEADWEAR; WETSUITS; SWIMWEAR; SINGLET; T-SHIRTS; SHIRTS AND CASUAL TOPS WITH LONG AND SHORT SLEEVES; SLEEVELESS SHIRTS AND TOPS; SLEEVELESS TOPS; JERSEYS; CROP TOPS; TANK TOPS; BLOUSES; BODYSUITS; CARDIGANS; SWEAT TOPS; RUGBY TOPS, SHAWLS; SWEATER VESTS; SWEAT SHIRTS; HOODED PARKAS; JACKETS; WIND RESISTANT JACKETS; BLAZERS; SUITS; TIES; NECKWEAR; BOW TIES; COATS; JUMPERS; SHORTS; BOARD SHORTS; WALKING SHORTS; VOLLEYBALL SHORTS; LONG PANTS; BEACH PANTS; JOGGING SUITS; WIND RESISTANT PANTS; TROUSERS; SLACKS; JEANS; DUNGAREES OVERALLS; DRESSES; SKIRTS; GOWNS; SARONGS; APRONS; PINAFORES; SPORTS BRAS; SKI WEAR AND SNOWBOARD WEAR NAMELY SKI SUITS, SKI PANTS, SKI TROUSERS, SKI JACKETS, SNOWBOARD PANTS, SNOWBOARD TROUSERS AND SNOWBOARD JACKETS; SKATEBOARD WEAR, NAMELY, PANTS, SHORTS, SHIRTS, SKIRTS, SOCKS, FOOTWEAR, HEADWEAR AND UNDERWEAR; LOUNGEWEAR; ROBES; APRONS; TUNICS; UNIFORMS; VEILS; PYJAMAS; NIGHTWEAR; SLEEP MASKS; SLEEPWEAR; DRESSING GOWNS; BATHROBES; UNDERWEAR; FOUNDATION GARMENTS; BRIEFS; RASH GUARDS; LINGERIE; STOCKINGS; THONGS; TIGHTS; PANTYHOSE; SUSPENDERS; BLOOMERS; PANTIES; KNICKERS; FROCKS; LEG WARMERS; LEGGINGS; LEOTARDS; SOCKS; VESTS; BRAS; GARTER BELTS; BELTS; BRACES; MITTENS; GLOVES; SCARVES; EAR MUFFS; CUFFS; WRIST BRANDS; BANDANNAS; HOODS; BALACLAVAS; BEANIES; HEADBANDS; HATS; VISORS; CAPES; CAPS; BERETS; HOODS AND HEADWEAR WITH CANOPY OF SUNSHIELD; BEACH COVER UPS; SUN SUITS; SURF WEAR; SURF CAPS; SURF HOODS; BREECHES SLIPPERS; BOOTS; SHOES; BEACH SHOES; THONGED AND STRAPPED SANDALS; SPORTING AND GYMNASIATIC FOOTWEAR; HEELS; INSOLES; ATHLETIC SHOES; BOOTS FOR SPORTS; SNOW BOOTS; SNOWBOARD BOOTS; GOLF SHOES; GOLF SPIKES; SKI BOOTS; APRÈS SKI BOOTS; KITEBOARD BOOTS; SURFBOARD BOOTS; WAKEBOARD BOOTS (U.S. CLS. 22 AND 39).
TRACY CROSS, EXAMINING ATTORNEY

SN 78-830,867. THE TRUSTEES OF THE GEORGE BALANCHINE TRUST, THE TRUSTEES COMPRISING KARIN VON ARNOLDINGEN, KAY MAZZO BELLAS, PAUL H. EPSTEIN, SUSAN HEMDL, AND BARBARA HORGAN, ALL CITIZENS OF THE UNITED STATES, NEW YORK, NY. FILED 3-7-2006.

SN 78-831,923. CROPP-METCALFE, FAIRFAX, VA. FILED 3-8-2006.

5 STAR TECHNICIAN

GEORGE BALANCHINE'S THE NUTCRACKER

THE MARK CONSISTS OF STANDARD CHARACTERS WITHOUT CLAIM TO ANY PARTICULAR FONT, STYLE, SIZE, OR COLOR.

OWNER OF U.S. REG. NO. 1,539,502.

THE NAME(S), PORTRAIT(S), AND/OR SIGNATURE(S) SHOWN IN THE MARK DOES NOT IDENTIFY A PARTICULAR LIVING INDIVIDUAL.

CLASS 9—ELECTRICAL AND SCIENTIFIC APPARATUS

FOR DVDS FEATURING MUSIC, DANCE, AND BALLET (U.S. CLS. 21, 23, 26, 36 AND 38).

FIRST USE 11-24-1993; IN COMMERCE 11-24-1993.

CLASS 14—JEWELRY

FOR LAPEL PINS (U.S. CLS. 2, 27, 28 AND 50).
FIRST USE 12-0-2004; IN COMMERCE 12-0-2004.

CLASS 16—PAPER GOODS AND PRINTED MATTER

FOR POSTERS (U.S. CLS. 2, 5, 22, 23, 29, 37, 38 AND 50).

FIRST USE 0-0-1993; IN COMMERCE 0-0-1993.

CLASS 18—LEATHER GOODS

FOR TOTE BAGS (U.S. CLS. 1, 2, 3, 22 AND 41).
FIRST USE 0-0-1994; IN COMMERCE 0-0-1994.

CLASS 25—CLOTHING

FOR SCARVES, T-SHIRTS (U.S. CLS. 22 AND 39).
FIRST USE 10-0-1994; IN COMMERCE 10-0-1994.

CLASS 28—TOYS AND SPORTING GOODS

FOR JIGSAW PUZZLES (U.S. CLS. 22, 23, 38 AND 50).
FIRST USE 0-0-1996; IN COMMERCE 0-0-1996.

CLASS 41—EDUCATION AND ENTERTAINMENT

FOR LIVE PERFORMANCES BY A DANCE TROUPE OR A BALLET (U.S. CLS. 100, 101 AND 107).
FIRST USE 11-27-1992; IN COMMERCE 11-27-1992.
RICHARD A. STRASER, EXAMINING ATTORNEY

THE MARK CONSISTS OF STANDARD CHARACTERS WITHOUT CLAIM TO ANY PARTICULAR FONT, STYLE, SIZE, OR COLOR.

NO CLAIM IS MADE TO THE EXCLUSIVE RIGHT TO USE "TECHNICIAN", APART FROM THE MARK AS SHOWN.

CLASS 37—CONSTRUCTION AND REPAIR

FOR PLUMBING CONTRACTOR SERVICES (U.S. CLS. 100, 103 AND 106).

FIRST USE 9-14-2005; IN COMMERCE 2-6-2006.

CLASS 45—PERSONAL SERVICES

FOR MONITORING BURGLAR AND SECURITY ALARMS; MONITORING SECURITY SYSTEMS (U.S. CLS. 100 AND 101).

FIRST USE 9-14-2005; IN COMMERCE 2-6-2006.

PAUL CROWLEY, EXAMINING ATTORNEY

SN 78-832,216. ARAMARK CORPORATION, PHILADELPHIA, PA. FILED 3-8-2006.

THE FRESH FOOD COMPANY

THE MARK CONSISTS OF STANDARD CHARACTERS WITHOUT CLAIM TO ANY PARTICULAR FONT, STYLE, SIZE, OR COLOR.

OWNER OF U.S. REG. NO. 2,309,990.

NO CLAIM IS MADE TO THE EXCLUSIVE RIGHT TO USE "FOOD COMPANY", APART FROM THE MARK AS SHOWN.

SEC. 2(F).

CLASS 41—EDUCATION AND ENTERTAINMENT

FOR EXHIBITION FOOD COOKING SERVICES (U.S. CLS. 100, 101 AND 107).

FIRST USE 12-15-1998; IN COMMERCE 12-15-1998.

CLASS 43—HOTEL AND RESTAURANT SERVICES

FOR RESTAURANTS; RESTAURANT SERVICES; CONTRACT FOOD PREPARATION SERVICES (U.S. CLS. 100 AND 101).

FIRST USE 12-15-1998; IN COMMERCE 12-15-1998.

ESTHER A. BORSUK, EXAMINING ATTORNEY

SN 78-833,304. WOMEN'S EDGE COALITION, WASHINGTON, DC. FILED 3-9-2006.

SN 78-834,270. CANON COMMUNICATIONS, LLC, LOS ANGELES, CA. FILED 3-10-2006.

GO 4 WOMEN

THE MARK CONSISTS OF STANDARD CHARACTERS WITHOUT CLAIM TO ANY PARTICULAR FONT, STYLE, SIZE, OR COLOR.

NO CLAIM IS MADE TO THE EXCLUSIVE RIGHT TO USE "WOMEN", APART FROM THE MARK AS SHOWN.

CLASS 9—ELECTRICAL AND SCIENTIFIC APPARATUS

FOR AUDIOTAPES, PRE-RECORDED CDS, VIDEOTAPES AND DVDS IN THE FIELD OF INTERNATIONAL ECONOMIC POLICIES AND HUMAN RIGHTS THAT SUPPORT WOMEN WORLDWIDE IN THEIR ACTIONS TO END POVERTY IN THEIR LIVES, COMMUNITIES AND NATIONS (U.S. CLS. 21, 23, 26, 36 AND 38).

CLASS 16—PAPER GOODS AND PRINTED MATTER

FOR INFORMATIONAL PAMPHLETS, BOOKS, SCHOLARLY JOURNALS AND PAPERS AND BROCHURES IN THE FIELD OF INTERNATIONAL ECONOMIC POLICIES AND HUMAN RIGHTS THAT SUPPORT WOMEN WORLDWIDE IN THEIR ACTIONS TO END POVERTY IN THEIR LIVES, COMMUNITIES AND NATIONS (U.S. CLS. 2, 5, 22, 23, 29, 37, 38 AND 50).

CLASS 25—CLOTHING

FOR CLOTHING, NAMELY, T-SHIRTS, SWEAT SHIRTS, AND HATS (U.S. CLS. 22 AND 39).

CLASS 35—ADVERTISING AND BUSINESS

FOR PROMOTING PUBLIC AWARENESS OF INTERNATIONAL ECONOMIC POLICIES AND HUMAN RIGHTS THAT SUPPORT WOMEN WORLDWIDE IN THEIR ACTIONS TO END POVERTY IN THEIR LIVES, COMMUNITIES AND NATIONS (U.S. CLS. 100, 101 AND 102).

CLASS 38—COMMUNICATION

FOR TELECOMMUNICATIONS, NAMELY THE DIFFUSION OF RADIO AND TELEVISION PROGRAMS IN THE FIELD OF INTERNATIONAL ECONOMIC POLICIES AND HUMAN RIGHTS THAT SUPPORT WOMEN WORLDWIDE IN THEIR ACTIONS TO END POVERTY IN THEIR LIVES, COMMUNITIES AND NATIONS (U.S. CLS. 100, 101 AND 104).

CLASS 41—EDUCATION AND ENTERTAINMENT

FOR EDUCATIONAL SERVICES, NAMELY CONDUCTING MEETINGS, LECTURES, SEMINARS, AND OTHER EDUCATIONAL PROGRAMS IN THE FIELD OF INTERNATIONAL ECONOMIC POLICIES AND HUMAN RIGHTS THAT SUPPORT WOMEN WORLDWIDE IN THEIR ACTIONS TO END POVERTY IN THEIR LIVES, COMMUNITIES AND NATIONS (U.S. CLS. 100, 101 AND 107).

WON TEAK OH, EXAMINING ATTORNEY

MEDICAL DEVICE LINK

THE MARK CONSISTS OF STANDARD CHARACTERS WITHOUT CLAIM TO ANY PARTICULAR FONT, STYLE, SIZE, OR COLOR.

OWNER OF U.S. REG. NOS. 1,612,477, 2,330,424 AND OTHERS.

NO CLAIM IS MADE TO THE EXCLUSIVE RIGHT TO USE LINK, APART FROM THE MARK AS SHOWN.

SEC. 2(F).

CLASS 35—ADVERTISING AND BUSINESS

FOR PROVIDING A WEBSITE ON A GLOBAL COMPUTER NETWORK FEATURING BUSINESS INFORMATION FOR THE MANUFACTURERS OF MEDICAL PRODUCTS (U.S. CLS. 100, 101 AND 102).

FIRST USE 10-15-1996; IN COMMERCE 10-15-1996.

CLASS 42—SCIENTIFIC, COMPUTER AND LEGAL SERVICES

FOR PROVIDING A WEBSITE ON A GLOBAL COMPUTER NETWORK FEATURING TECHNICAL INFORMATION FOR THE MANUFACTURERS OF MEDICAL PRODUCTS (U.S. CLS. 100 AND 101).

FIRST USE 10-15-1996; IN COMMERCE 10-15-1996.

DANIEL RUSSELL, EXAMINING ATTORNEY

SN 78-834,731. LIARDON, ROBERTS, LAGUNA HILLS, CA. FILED 3-10-2006.

God's Generals

THE MARK CONSISTS OF STANDARD CHARACTERS WITHOUT CLAIM TO ANY PARTICULAR FONT, STYLE, SIZE, OR COLOR.

CLASS 9—ELECTRICAL AND SCIENTIFIC APPARATUS

FOR PRERECORDED VIDEO CASSETTES, COMPACT DISCS AND DVD'S FEATURING LEGENDARY RELIGIOUS REVIVALISTS OF THE NINETEENTH AND TWENTIETH CENTURIES (U.S. CLS. 21, 23, 26, 36 AND 38).

FIRST USE 7-1-1996; IN COMMERCE 7-1-1996.

CLASS 16—PAPER GOODS AND PRINTED MATTER

FOR SERIES OF NON-FICTION BOOKS IN THE FIELD OF LEGENDARY RELIGIOUS REVIVALISTS OF THE NINETEENTH AND TWENTIETH CENTURIES (U.S. CLS. 2, 5, 22, 23, 29, 37, 38 AND 50).

FIRST USE 7-1-1996; IN COMMERCE 7-1-1996.

JOHN WILKE, EXAMINING ATTORNEY

SN 78-835,797. UCB, S.A., BRUXELLES, BELGIUM, FILED 3-13-2006.

SN 78-836,804. RELIX LLC, NEW YORK, NY. FILED 3-14-2006.

LIFE ON YOUR TERMS

THE MARK CONSISTS OF STANDARD CHARACTERS WITHOUT CLAIM TO ANY PARTICULAR FONT, STYLE, SIZE, OR COLOR.

CLASS 16—PAPER GOODS AND PRINTED MATTER

FOR MEDICAL PUBLICATIONS ON THE CENTRAL NERVOUS SYSTEM, NAMELY REPORTS, MANUALS, BROCHURES, NEWSLETTERS, LEAFLETS (U.S. CLS. 2, 5, 22, 23, 29, 37, 38 AND 50).

CLASS 42—SCIENTIFIC, COMPUTER AND LEGAL SERVICES

FOR SCIENTIFIC AND MEDICAL RESEARCH ON THE CENTRAL NERVOUS SYSTEM (U.S. CLS. 100 AND 101).

JOHN GARTNER, EXAMINING ATTORNEY

SN 78-836,477. SAPORITO, DAVE, COCOA, FL. FILED 3-14-2006.

GOD'S REALTY

THE MARK CONSISTS OF STANDARD CHARACTERS WITHOUT CLAIM TO ANY PARTICULAR FONT, STYLE, SIZE, OR COLOR.

NO CLAIM IS MADE TO THE EXCLUSIVE RIGHT TO USE "REALTY", APART FROM THE MARK AS SHOWN.

CLASS 35—ADVERTISING AND BUSINESS

FOR FRANCHISING SERVICES, NAMELY OFFERING TECHNICAL ASSISTANCE IN THE ESTABLISHMENT AND/OR OPERATION OF REAL ESTATE BROKERAGE OFFICES (U.S. CLS. 100, 101 AND 102).

CLASS 36—INSURANCE AND FINANCIAL

FOR REAL ESTATE BROKERAGE; RENTAL OF REAL ESTATE; MANAGEMENT OF COMMERCIAL AND RESIDENTIAL PROPERTIES; REAL ESTATE INVESTMENT; REAL PROPERTY AND INSURANCE BROKERAGE; AND MORTGAGE BROKERAGE AND FINANCING SERVICES (U.S. CLS. 100, 101 AND 102).

AMY ALFIERI, EXAMINING ATTORNEY



NO CLAIM IS MADE TO THE EXCLUSIVE RIGHT TO USE "MUSIC & ARTS FESTIVAL" AND "NYC", APART FROM THE MARK AS SHOWN.

THE COLOR(S) GREEN, WHITE, BLACK, BROWN, AND GRAY IS/ARE CLAIMED AS A FEATURE OF THE MARK.

THE MARK CONSISTS OF AN APPLE WITH STEM AND LEAF IN SHADES OF LIGHT GREEN APPLE GREEN WITH WHITE SHADING WITH A MUSIC NOTE CUT OUT OF IT IN WHITE SHADED IN GRAY. THE APPLE STEM IS BROWN. THE APPLE APPEARS ON THE NYC SKYLINE IN BLACK SILHOUETTE DOTTED IN WHITE. THE DESIGN IS CONTAINED IN A CIRCLE. THE PERIMETER OF THE CIRCLE CONTAINS THE WORDS "GREEN APPLE MUSIC & ARTS FESTIVAL" IN SHADES OF LIGHT GREEN APPLE GREEN THE OUTSIDE RING IS DARK GRAY. WHITE IS THE BACKGROUND COLOR.

CLASS 38—COMMUNICATION

FOR STREAMING OF AUDIO MATERIAL ON THE INTERNET; STREAMING OF VIDEO MATERIAL ON THE INTERNET (U.S. CLS. 100, 101 AND 104).

CLASS 41—EDUCATION AND ENTERTAINMENT

FOR ENTERTAINMENT NAMELY, LIVE PERFORMANCES BY A MUSICAL BAND; ENTERTAINMENT SERVICES, NAMELY, PROVIDING A WEB SITE FEATURING MUSICAL PERFORMANCES, MUSICAL VIDEOS, RELATED FILM CLIPS, PHOTOGRAPHS, AND OTHER MULTIMEDIA MATERIALS; ENTERTAINMENT, NAMELY LIVE MUSIC CONCERTS (U.S. CLS. 100, 101 AND 107).

STEVEN JACKSON, EXAMINING ATTORNEY

SN 78-838,972. MEAD JOHNSON & COMPANY, EVANSVILLE, IN. FILED 3-16-2006.

NO OTHER FORMULA GIVES
YOUR BABY A BETTER START
IN LIFE

THE MARK CONSISTS OF STANDARD CHARACTERS WITHOUT CLAIM TO ANY PARTICULAR FONT, STYLE, SIZE, OR COLOR.

CLASS 5—PHARMACEUTICALS

FOR PEDIATRIC FEEDING FORMULA; FOOD FOR BABIES; VITAMIN AND MINERAL PREPARATIONS FOR USE AS INGREDIENTS IN THE FOOD AND PHARMACEUTICAL INDUSTRY; DIETARY, NUTRITIONAL AND FOOD SUPPLEMENTS (U.S. CLS. 6, 18, 44, 46, 51 AND 52).

CLASS 16—PAPER GOODS AND PRINTED MATTER

FOR PRINTED MATTER, NAMELY, NEWSLETTERS, BROCHURES, BOOKLETS AND PAMPHLETS IN THE FIELD OF INFANT AND CHILD HEALTH, NUTRITION AND DEVELOPMENT (U.S. CLS. 2, 5, 22, 23, 29, 37, 38 AND 50).

CLASS 44—MEDICAL, BEAUTY AND AGRICULTURAL SERVICES

FOR HEALTH CARE SERVICES, NAMELY, PROVIDING INFORMATION TO EXPECTANT AND NEW MOTHERS WHICH FOCUSES ON GOOD HEALTH FOR MOTHER AND INFANTS (U.S. CLS. 100 AND 101).
MATTHEW MCDOWELL, EXAMINING ATTORNEY

SN 78-839,689. INTERNATIONAL FLAVORS & FRAGRANCES INC., NEW YORK, NY. FILED 3-17-2006.

mtech

THE MARK CONSISTS OF STANDARD CHARACTERS WITHOUT CLAIM TO ANY PARTICULAR FONT, STYLE, SIZE, OR COLOR.

CLASS 1—CHEMICALS

FOR CHEMICALS USED IN INDUSTRY; CHEMICALS FOR THE MANUFACTURE OF PERFUMES (U.S. CLS. 1, 5, 6, 10, 26 AND 46).

CLASS 3—COSMETICS AND CLEANING PREPARATIONS

FOR ESSENTIAL OILS FOR USE IN THE MANUFACTURE OF COLOGNES, COSMETICS, TOILETRIES, DETERGENTS, FABRIC SOFTENERS, ODORANTS, DEODORANTS, BLEACHES, BRIGHTENERS AND AIR FRESHENERS (U.S. CLS. 1, 4, 6, 50, 51 AND 52).
KELLY CHOE, EXAMINING ATTORNEY

SN 78-840,225. WALDEN UNIVERSITY, INC., MINNEAPOLIS, MN. FILED 3-17-2006.

REAL PEOPLE. REAL CHANGE.

THE MARK CONSISTS OF STANDARD CHARACTERS WITHOUT CLAIM TO ANY PARTICULAR FONT, STYLE, SIZE, OR COLOR.

CLASS 9—ELECTRICAL AND SCIENTIFIC APPARATUS

FOR PRE-RECORDED VIDEO AND AUDIO CASSETTES, COMPACT DISCS, VIDEO DISCS, DIGITAL VIDEO DISCS, PRE-RECORDED LASER DISCS AND INTERACTIVE VIDEOS ALL IN THE FIELD OF INSTRUCTION AT THE COLLEGE AND GRADUATE SCHOOL LEVELS (U.S. CLS. 21, 23, 26, 36 AND 38).

CLASS 41—EDUCATION AND ENTERTAINMENT

FOR EDUCATIONAL SERVICES AND ONLINE EDUCATIONAL SERVICES, NAMELY, PROVIDING COURSES OF INSTRUCTION AT THE COLLEGE AND GRADUATE SCHOOL LEVELS (U.S. CLS. 100, 101 AND 107).

DAVID YONTEF, EXAMINING ATTORNEY

SN 78-840,557. WALSH, TODD, W., SARATOGA, CA. AND ADAMS, SCOTT, L., SARATOGA, CA. FILED 3-18-2006.

Surf Stronger

THE MARK CONSISTS OF STANDARD CHARACTERS WITHOUT CLAIM TO ANY PARTICULAR FONT, STYLE, SIZE, OR COLOR.

NO CLAIM IS MADE TO THE EXCLUSIVE RIGHT TO USE "SURF", APART FROM THE MARK AS SHOWN.

CLASS 9—ELECTRICAL AND SCIENTIFIC APPARATUS

FOR PRERECORDED VIDEOTAPES AND DVD'S FEATURING SURF FITNESS PROGRAM INSTRUCTION AND WORKOUT FOR SURFING (U.S. CLS. 21, 23, 26, 36 AND 38).

CLASS 25—CLOTHING

FOR APPAREL, NAMELY, SHIRTS, SHORTS, SWEATSHIRTS, SWIMSUITS AND HEADGEAR, NAMELY, HATS, CAPS, SUN VISORS (U.S. CLS. 22 AND 39).
ESTHER BELENKER, EXAMINING ATTORNEY

SN 78-841,660. JOHANSSON, JAMES D., OROVILLE, CA. FILED 3-20-2006.

SIERRA ORO FARM TRAIL

THE MARK CONSISTS OF STANDARD CHARACTERS WITHOUT CLAIM TO ANY PARTICULAR FONT, STYLE, SIZE, OR COLOR.

THE ENGLISH TRANSLATION OF THE SPANISH WORD ORO IN THE MARK IS GOLD.

CLASS 16—PAPER GOODS AND PRINTED MATTER

FOR PRINTED MATERIALS, NAMELY, POST CARDS, CALENDARS, MAPS, FOLDERS, BUMPER STICKERS, POSTERS, ADDRESS BOOKS, PAPER PLACEMATS, AND STATIONERY (U.S. CLS. 2, 5, 22, 23, 29, 37, 38 AND 50).

CLASS 25—CLOTHING

FOR CLOTHING, NAMELY, T-SHIRTS, SWEAT-SHIRTS, HATS, CAPS, AND JACKETS (U.S. CLS. 22 AND 39).

CHARISMA HAMPTON, EXAMINING ATTORNEY

SN 78-842,069. SUNDYNE CORPORATION, ARVADA, CO. FILED 3-21-2006.



OWNER OF U.S. REG. NO. 2,639,537.
THE MARK CONSISTS OF A STYLIZED LETTER "S".

CLASS 7—MACHINERY

FOR CENTRIFUGAL COMPRESSORS AND ELECTRICAL GENERATORS (U.S. CLS. 13, 19, 21, 23, 31, 34 AND 35).

CLASS 9—ELECTRICAL AND SCIENTIFIC APPARATUS

FOR CONTROLLERS FOR CENTRIFUGAL COMPRESSORS AND DRIVE MOTORS (U.S. CLS. 21, 23, 26, 36 AND 38).

DANNEAN HETZEL, EXAMINING ATTORNEY

SN 78-842,231. RECKITT BENCKISER INC., PARSIPPANY, NJ. FILED 3-21-2006.

MICRO-LOCK

THE MARK CONSISTS OF STANDARD CHARACTERS WITHOUT CLAIM TO ANY PARTICULAR FONT, STYLE, SIZE, OR COLOR.

CLASS 5—PHARMACEUTICALS

FOR ALL PURPOSE DISINFECTANTS; DISINFECTANT BATHROOM CLEANERS (U.S. CLS. 6, 18, 44, 46, 51 AND 52).

FIRST USE 6-9-2006; IN COMMERCE 6-9-2006.

CLASS 21—HOUSEWARES AND GLASS

FOR CLEANING CLOTHS IMPREGNATED WITH DISINFECTING PROPERTIES; PRE-MOISTENED WIPES WITH DISINFECTING PROPERTIES FOR USE ON HOUSEHOLD SURFACES (U.S. CLS. 2, 13, 23, 29, 30, 33, 40 AND 50).

FIRST USE 6-9-2006; IN COMMERCE 6-9-2006.
RUSS HERMAN, EXAMINING ATTORNEY

SN 78-843,541. SCHUMACKER & COMPANY, INC., DAVIE, FL. FILED 3-22-2006.



THE MARK CONSISTS OF THE WORD SPAREZ WITH A WHIRLWIND BACKGROUND AND A BOWLING BALL ABOVE THE "A" AND THE "R" OF THE WORD "SPAREZ".

CLASS 35—ADVERTISING AND BUSINESS

FOR PROMOTIONAL SERVICES IN THE FIELD OF BOWLING AND RECREATIONAL SERVICES PROVIDED BY OF OTHERS (U.S. CLS. 100, 101 AND 102).

FIRST USE 2-20-2006; IN COMMERCE 2-20-2006.

CLASS 41—EDUCATION AND ENTERTAINMENT

FOR ENTERTAINMENT IN THE NATURE OF PROVIDING BOWLING ALLEYS AND AMUSEMENT ARCADE ROOMS, AND ENTERTAINMENT IN THE NATURE OF BOWLING TOURNAMENTS AND CONDUCTING PRIVATE PARTIES AT BOWLING ALLEYS (U.S. CLS. 100, 101 AND 107).

FIRST USE 2-20-2006; IN COMMERCE 2-20-2006.
JACQUELINE A. LAVINE, EXAMINING ATTORNEY

SN 78-843,686. UNITED SPACE ALLIANCE, LLC, CAPE CANAVERAL, FL. FILED 3-22-2006.

ATTENTUS

THE MARK CONSISTS OF STANDARD CHARACTERS WITHOUT CLAIM TO ANY PARTICULAR FONT, STYLE, SIZE, OR COLOR.

CLASS 9—ELECTRICAL AND SCIENTIFIC APPARATUS

FOR COMPUTER SOFTWARE FOR USE IN INTEGRATED DATA MANAGEMENT IN THE FIELDS OF SPACECRAFT DESIGN AND DEVELOPMENT AND SPACE OPERATIONS AND IN THE FIELDS OF NATURAL RESOURCE EXPLORATION, EXTRACTION AND PROCESSING; COMPUTER SOFTWARE FOR USE IN DATA MANAGEMENT IN THE FIELDS OF SPACECRAFT DESIGN AND DEVELOPMENT AND SPACE OPERATIONS AND IN THE FIELDS OF NATURAL RESOURCE EXPLORATION, EXTRACTION AND PROCESSING; COMPUTER SOFTWARE FOR USE IN MANAGEMENT OF OPERATIONAL DATA AND ARCHIVAL CONTENT IN THE FIELD OF SPACE OPERATIONS, SPACE FLIGHT AND SPACE EXPLORATION AND IN THE FIELDS OF NATURAL RESOURCE EXPLORATION, EXTRACTION AND PROCESSING (U.S. CLS. 21, 23, 26, 36 AND 38).

CLASS 42—SCIENTIFIC, COMPUTER AND LEGAL SERVICES

FOR INFORMATION TECHNOLOGY CONSULTATION; CUSTOMIZATION OF COMPUTER HARDWARE AND SOFTWARE; TECHNICAL SUPPORT SERVICES, NAMELY, TROUBLESHOOTING OF COMPUTER HARDWARE AND SOFTWARE PROBLEMS (U.S. CLS. 100 AND 101).

RONALD MCMORROW, EXAMINING ATTORNEY

SN 78-843,690. UNITED SPACE ALLIANCE, LLC, CAPE CANAVERAL, FL. FILED 3-22-2006.

QUESTUS

THE MARK CONSISTS OF STANDARD CHARACTERS WITHOUT CLAIM TO ANY PARTICULAR FONT, STYLE, SIZE, OR COLOR.

CLASS 9—ELECTRICAL AND SCIENTIFIC APPARATUS

FOR COMPUTER SOFTWARE FOR USE IN INTEGRATED DATA MANAGEMENT IN THE FIELDS OF SPACECRAFT DESIGN AND DEVELOPMENT AND SPACE OPERATIONS AND IN THE FIELDS OF NATURAL RESOURCE EXPLORATION, EXTRACTION AND PROCESSING; COMPUTER SOFTWARE FOR USE IN DATA MANAGEMENT IN THE FIELDS OF SPACECRAFT DESIGN AND DEVELOPMENT AND SPACE OPERATIONS AND IN THE FIELDS OF NATURAL RESOURCE EXPLORATION, EXTRACTION AND PROCESSING; COMPUTER SOFTWARE FOR USE IN MANAGEMENT OF OPERATIONAL DATA AND ARCHIVAL CONTENT IN THE FIELDS OF SPACE OPERATIONS, SPACE FLIGHT AND SPACE EXPLORATION AND IN THE FIELDS OF NATURAL RESOURCE EXPLORATION, EXTRACTION AND PROCESSING (U.S. CLS. 21, 23, 26, 36 AND 38).

CLASS 42—SCIENTIFIC, COMPUTER AND LEGAL SERVICES

FOR INFORMATION TECHNOLOGY CONSULTATION; CUSTOMIZATION OF COMPUTER HARDWARE AND SOFTWARE; TECHNICAL SUPPORT SERVICES, NAMELY, TROUBLESHOOTING OF COMPUTER HARDWARE AND SOFTWARE PROBLEMS (U.S. CLS. 100 AND 101).

RONALD MCMORROW, EXAMINING ATTORNEY

SN 78-843,950. OCEAN SPRAY CRANBERRIES, INC., LAKEVILLE-MIDDLEBORO, MA. FILED 3-23-2006.

STRAIGHT FROM THE GROVE

THE MARK CONSISTS OF STANDARD CHARACTERS WITHOUT CLAIM TO ANY PARTICULAR FONT, STYLE, SIZE, OR COLOR.

CLASS 31—NATURAL AGRICULTURAL PRODUCTS

FOR FRESH GRAPEFRUIT (U.S. CLS. 1 AND 46).

CLASS 32—LIGHT BEVERAGES

FOR GRAPEFRUIT JUICES AND JUICE DRINKS (U.S. CLS. 45, 46 AND 48).

LAURA HAMMEL, EXAMINING ATTORNEY

SN 78-844,628. WHITETAILS UNLIMITED, INC., STURGEON BAY, WI. FILED 3-23-2006.



THE MARK CONSISTS OF A DEER SILHOUETTE IN A CIRCLE.

CLASS 16—PAPER GOODS AND PRINTED MATTER

FOR MAGAZINES FEATURING WHITETAIL DEER, DEER HUNTING AND DEER MANAGEMENT; CLOTH DECALS (U.S. CLS. 2, 5, 22, 23, 29, 37, 38 AND 50).

FIRST USE 6-1-1993; IN COMMERCE 6-1-1993.

CLASS 25—CLOTHING

FOR CLOTHING, NAMELY SHIRTS, SWEATSHIRTS, JACKETS, SOCKS, HATS (U.S. CLS. 22 AND 39).

FIRST USE 6-1-1993; IN COMMERCE 6-1-1993.

CLASS 35—ADVERTISING AND BUSINESS

FOR ASSOCIATION SERVICES, NAMELY, PROMOTING THE INTERESTS OF PERSONS CONCERNED WITH THE DEVELOPMENT OF DEER MANAGEMENT PROGRAMS DESIGNED TO MAINTAIN A BALANCED AND HEALTHY DEER HERD (U.S. CLS. 100, 101 AND 102).

FIRST USE 6-1-1993; IN COMMERCE 6-1-1993.

PAUL CROWLEY, EXAMINING ATTORNEY

SN 78-845,156. BOARD OF TRUSTEES OF SOUTHERN ILLINOIS UNIVERSITY, EDWARDSVILLE, IL. FILED 3-24-2006.

SN 78-845,939. FELLOWSHIP CHURCH, GRAPEVINE, TX. FILED 3-24-2006.



SIUE

THE MARK CONSISTS OF STANDARD CHARACTERS WITHOUT CLAIM TO ANY PARTICULAR FONT, STYLE, SIZE, OR COLOR.

OWNER OF U.S. REG. NO. 2,467,475.

CLASS 16—PAPER GOODS AND PRINTED MATTER

FOR CALENDARS, POSTERS, STATIONERY, NOTE CARDS, INVITATION CARDS, DECALS, BUMPER STICKERS, BOOKMARKS, BUSINESS CARDS, ANNOUNCEMENT CARDS, CATALOGS IN THE FIELD OF EDUCATION, BLANK, PRINTED AND PARTIALLY PRINTED FORMS, AND BROCHURES, PAMPHLETS, MANUALS, BOOKS, AND BULLETINS IN THE FIELD OF UNIVERSITY EDUCATION, CURRICULUM, SPORTS AND EXTRACURRICULAR ACTIVITIES (U.S. CLS. 2, 5, 22, 23, 29, 37, 38 AND 50).

FIRST USE 9-1-2005; IN COMMERCE 9-1-2005.

CLASS 25—CLOTHING

FOR CLOTHING, NAMELY, T-SHIRTS, SWEAT-SHIRTS, ATHLETIC SHIRTS, SWEATERS, HATS, SOCKS, SKIRTS, PANTS AND SHORTS (U.S. CLS. 22 AND 39).

FIRST USE 9-1-2005; IN COMMERCE 9-1-2005.

CLASS 41—EDUCATION AND ENTERTAINMENT

FOR EDUCATIONAL SERVICES IN THE NATURE OF PROVIDING COURSES AT THE UNIVERSITY LEVEL AND CONTINUING EDUCATION COURSES IN THE FIELDS OF LIBERAL ARTS AND SCIENCES, BUSINESS, EDUCATION, ENGINEERING, DENTAL MEDICINE, PHARMACY, AND NURSING; ENTERTAINMENT SERVICES IN THE NATURE OF LIVE THEATER PRODUCTIONS AND MUSIC PRODUCTION SERVICES; ARRANGING AND CONDUCTING INTERCOLLEGIATE ATHLETIC COMPETITIONS AND PROVIDING FACILITIES FOR AN ARRAY OF INTERCOLLEGIATE ATHLETIC COMPETITIONS AND SPORTING EVENTS (U.S. CLS. 100, 101 AND 107).

FIRST USE 9-1-2005; IN COMMERCE 9-1-2005.

ELIZABETH J. WINTER, EXAMINING ATTORNEY

OWNER OF U.S. REG. NOS. 3,035,703, 3,038,041 AND OTHERS.

NO CLAIM IS MADE TO THE EXCLUSIVE RIGHT TO USE "FELLOWSHIP CHURCH GRAPEVINE", APART FROM THE MARK AS SHOWN.

THE MARK CONSISTS OF A STYLIZED BOX CONTAINING THE LETTERS "FC" FOLLOWED BY THE WORDS "FELLOWSHIP CHURCH GRAPEVINE" WHICH ARE SEPARATED BY A VERTICAL LINE.

CLASS 41—EDUCATION AND ENTERTAINMENT

FOR EDUCATIONAL SERVICES, NAMELY, CONDUCTING CLASSES, CONFERENCES, SEMINARS AND WORKSHOPS IN THE FIELD OF RELIGION AND DISTRIBUTING COURSE MATERIALS IN CONNECTION THEREWITH (U.S. CLS. 100, 101 AND 107).

FIRST USE 12-1-2004; IN COMMERCE 12-1-2004.

CLASS 45—PERSONAL SERVICES

FOR EVANGELISTIC AND MINISTERIAL SERVICES (U.S. CLS. 100 AND 101).

FIRST USE 12-1-2004; IN COMMERCE 12-1-2004.

KEVON CHISOLM, EXAMINING ATTORNEY

SN 78-846,346. WINSLOW AUTOMATION, INC., MILPITAS, CA. FILED 3-26-2006.

SolderQuik

THE MARK CONSISTS OF STANDARD CHARACTERS WITHOUT CLAIM TO ANY PARTICULAR FONT, STYLE, SIZE, OR COLOR.

SEC. 2(F).

CLASS 6—METAL GOODS

FOR HARD SOLDER; LEAD AND ITS ALLOYS; SILVER SOLDER; SOFT SOLDER; TIN AND ITS ALLOYS (U.S. CLS. 2, 12, 13, 14, 23, 25 AND 50).

FIRST USE 5-20-1981; IN COMMERCE 5-20-1981.

CLASS 9—ELECTRICAL AND SCIENTIFIC APPARATUS

FOR LEAD-FREE SOLDERS IN THE ELECTRONICS INDUSTRY (U.S. CLS. 21, 23, 26, 36 AND 38).

FIRST USE 5-20-1981; IN COMMERCE 5-20-1981.

ELIZABETH J. WINTER, EXAMINING ATTORNEY

SN 78-846,760. MANAGEMENT ACTION PROGRAMS, INC.,
SHERMAN OAKS, CA. FILED 3-27-2006.

SN 78-847,317. KIDSWEALTH (USA) INC., TAMPA, FL.
FILED 3-27-2006.

VITAL FACTORS

THE MARK CONSISTS OF STANDARD CHARACTERS WITHOUT CLAIM TO ANY PARTICULAR FONT, STYLE, SIZE, OR COLOR.

CLASS 16—PAPER GOODS AND PRINTED MATTER

FOR PRINTED MATTER, NAMELY BOOKS, NEWSLETTERS, PAMPHLETS, AND INSTRUCTION MANUALS IN THE FIELD OF INSTRUCTING SOMEONE IN THE BETTERMENT OF HIS OR HER LIFE (U.S. CLS. 2, 5, 22, 23, 29, 37, 38 AND 50).

CLASS 35—ADVERTISING AND BUSINESS

FOR BUSINESS CONSULTING SERVICES (U.S. CLS. 100, 101 AND 102).
TARAH HARDY, EXAMINING ATTORNEY

SN 78-847,239. CHEMOCENTRYX, INC., MOUNTAIN VIEW,
CA. FILED 3-27-2006.

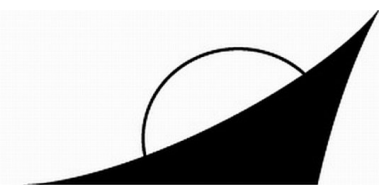

CLASS 5—PHARMACEUTICALS

FOR PHARMACEUTICAL PREPARATIONS FOR USE IN THE TREATMENT OF HUMAN DISEASE, NAMELY, INFLAMMATORY AND AUTOIMMUNE DISEASES, DISORDERS AND SYNDROMES, SUCH AS CHEMOKINE-MEDIATED DISEASES (U.S. CLS. 6, 18, 44, 46, 51 AND 52).

CLASS 42—SCIENTIFIC, COMPUTER AND LEGAL SERVICES

FOR RESEARCH AND DEVELOPMENT FOR NEW PRODUCTS IN THE FIELD OF CHEMOKINES AND GENETIC MATERIALS FOR OTHERS (U.S. CLS. 100 AND 101).
SHARON MEIER, EXAMINING ATTORNEY

KIDSWEALTH

THE MARK CONSISTS OF STANDARD CHARACTERS WITHOUT CLAIM TO ANY PARTICULAR FONT, STYLE, SIZE, OR COLOR.

OWNER OF U.S. REG. NO. 3,091,126.

CLASS 36—INSURANCE AND FINANCIAL

FOR MONEY MANAGEMENT AND WEALTH PLANNING FOR CHILDREN (U.S. CLS. 100, 101 AND 102).
FIRST USE 8-14-2002; IN COMMERCE 6-25-2005.

CLASS 41—EDUCATION AND ENTERTAINMENT

FOR EDUCATIONAL SERVICES FOR CHILDREN, NAMELY PROVIDING INSTRUCTION IN THE FIELD OF MONEY MANAGEMENT AND WEALTH PLANNING (U.S. CLS. 100, 101 AND 107).
FIRST USE 8-14-2002; IN COMMERCE 6-25-2005.
LINDA ESTRADA, EXAMINING ATTORNEY

SN 78-847,347. DEERGUS ENTERTAINMENT, DBA SELFISH CAUSES, LONG BEACH, CA. FILED 3-27-2006.



THE MARK CONSISTS OF THE WORDS "SELFISH CAUSES" WITHIN AN EMBOSSED LABEL TAPE WITH DISTRESSED TEXTURE ALONG THE EDGES.

CLASS 16—PAPER GOODS AND PRINTED MATTER

FOR NOVELTY STATIONERY AND PRINTED MATTER NAMELY GREETING CARDS, OCCASION CARDS AND A SERIES OF FICTION BOOKS (U.S. CLS. 2, 5, 22, 23, 29, 37, 38 AND 50).

CLASS 25—CLOTHING

FOR NOVELTY DECORATED CLOTHING, NAMELY, T-SHIRTS (U.S. CLS. 22 AND 39).
NAKIA HENRY, EXAMINING ATTORNEY

SN 78-847,525. CONE BUSINESS SERVICES LIMITED, HOWDEN, GOOLE, UNITED KINGDOM, FILED 3-28-2006.

SN 78-847,959. TWEEN BRANDS INVESTMENT, LLC, NEW ALBANY, OH. FILED 3-28-2006.

onebay

THE MARK CONSISTS OF STANDARD CHARACTERS WITHOUT CLAIM TO ANY PARTICULAR FONT, STYLE, SIZE, OR COLOR.

CLASS 35—ADVERTISING AND BUSINESS

FOR DISSEMINATION OF ADVERTISING FOR OTHERS VIA THE INTERNET; PROVIDING AND RENTAL OF ADVERTISING SPACE ON THE INTERNET (U.S. CLS. 100, 101 AND 102).

CLASS 42—SCIENTIFIC, COMPUTER AND LEGAL SERVICES

FOR DESIGN, CREATION, HOSTING AND MAINTENANCE OF INTERNET SITES FOR THIRD PARTIES; HOSTING OF DIGITAL CONTENT ON THE INTERNET (U.S. CLS. 100 AND 101).

SCOTT BALDWIN, EXAMINING ATTORNEY

SN 78-847,646. ZYWAVE, INC., WAUWATOSA, WI. FILED 3-28-2006.

MyWaveOSHA

THE MARK CONSISTS OF STANDARD CHARACTERS WITHOUT CLAIM TO ANY PARTICULAR FONT, STYLE, SIZE, OR COLOR.

OWNER OF U.S. REG. NOS. 2,471,937 AND 2,571,896.

CLASS 36—INSURANCE AND FINANCIAL

FOR PROVIDING INSURANCE INFORMATION OVER A GLOBAL COMPUTER NETWORK (U.S. CLS. 100, 101 AND 102).

FIRST USE 12-20-2004; IN COMMERCE 12-20-2004.

CLASS 42—SCIENTIFIC, COMPUTER AND LEGAL SERVICES

FOR WEB HOSTING SERVICES AND DESIGNING AND CREATING WEB PAGES FOR OTHERS (U.S. CLS. 100 AND 101).

FIRST USE 12-20-2004; IN COMMERCE 12-20-2004.
KAREN K. BUSH, EXAMINING ATTORNEY

TOO TUNES

THE MARK CONSISTS OF STANDARD CHARACTERS WITHOUT CLAIM TO ANY PARTICULAR FONT, STYLE, SIZE, OR COLOR.

OWNER OF U.S. REG. NO. 2,780,705.

NO CLAIM IS MADE TO THE EXCLUSIVE RIGHT TO USE TUNES, APART FROM THE MARK AS SHOWN.

CLASS 9—ELECTRICAL AND SCIENTIFIC APPARATUS

FOR AUDIO SPEAKERS, MP3 PLAYERS, CD PLAYERS, DVD PLAYERS AND ACCESSORIES FOR THE AFORESAID GOODS, NAMELY CARRYING CASES, MEMORY CARDS, PRE-RECORDED CDS AND DVDS FEATURING MUSIC AND MOVIES, RADIOS, POUCHES FOR CARRYING SMALL PORTABLE ELECTRONIC DEVICES, AND CD CASES (U.S. CLS. 21, 23, 26, 36 AND 38).

FIRST USE 9-1-2002; IN COMMERCE 6-21-2006.

CLASS 20—FURNITURE AND ARTICLES NOT OTHERWISE CLASSIFIED

FOR PILLOWS WITH BUILT-IN SPEAKERS (U.S. CLS. 2, 13, 22, 25, 32 AND 50).

FIRST USE 9-1-2002; IN COMMERCE 6-6-2006.

GISELLE AGOSTO, EXAMINING ATTORNEY

SN 78-848,643. GOTFRIED, YECHIEL, KIRYAT-BIALIK, ISRAEL, FILED 3-29-2006.

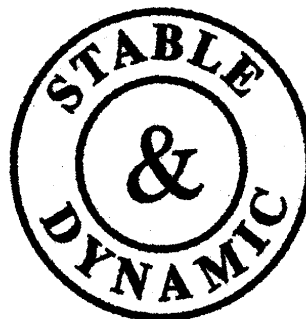

THE MARK CONSISTS OF AN AMPERSAND WITHIN A FIRST CIRCLE, THE WORDS STABLE AND DYNAMIC AROUND THE EXTERIOR OF THE FIRST CIRCLE, AND A SECOND CIRCLE AROUND THE WORDS STABLE AND DYNAMIC.

CLASS 10—MEDICAL APPARATUS

FOR MEDICAL AND SURGICAL APPARATUS, NAMELY ORTHOPEDIC SURGICAL IMPLANTS COMPRISING ARTIFICIAL MATERIALS, OR NATURALLY OCCURRING NON-LIVING MATERIALS, NAMELY METAL; ORTHOPEDIC COMPRESSION AND SECUREMENT DEVICE USED TO SECURE BONE FRACTURES; VETERINARY SURGICAL APPARATUS, NAMELY ORTHOPEDIC SURGICAL IMPLANTS COMPRISING ARTIFICIAL MATERIALS, OR NATURALLY OCCURRING NON-LIVING MATERIALS, NAMELY METAL; VETERINARY ORTHOPEDIC COMPRESSION AND SECUREMENT DEVICE USED TO SECURE BONE FRACTURES IN ANIMALS (U.S. CLS. 26, 39 AND 44).

CLASS 44—MEDICAL, BEAUTY AND AGRICULTURAL SERVICES

FOR POST-OPERATIVE SURGICAL SERVICES, NAMELY POST-OPERATIVE PATIENT PHYSICAL REHABILITATION SERVICES (U.S. CLS. 100 AND 101).
SUSAN BILLHEIMER, EXAMINING ATTORNEY

CLASS 30—STAPLE FOODS

FOR BREADS, PASTRY, CANDY AND FROZEN CONFECTIONS (U.S. CL. 46).
FIRST USE 1-1-1993; IN COMMERCE 1-1-1993.

CLASS 43—HOTEL AND RESTAURANT SERVICES

FOR RESTAURANT SERVICES (U.S. CLS. 100 AND 101).
FIRST USE 1-1-1993; IN COMMERCE 1-1-1993.
JANICE KIM, EXAMINING ATTORNEY

SN 78-849,940. MECA SPORTSWEAR, INC., ST. PAUL, MN.
FILED 3-30-2006.

SN 78-848,695. RAZORGATOR INTERACTIVE GROUP, INC., BEVERLY HILLS, CA. FILED 3-29-2006.



THE MARK CONSISTS OF THE OUTSIDE EDGES OF THE LETTERS M AND B INCORPORATED INTO A CIRCLE CONTAINING BOTH LETTERS WITH THE WORD MASTER ON TOP OF THE WORD BROKER NEXT TO THE LETTER B ON THE OUTSIDE OF THE CIRCLE.

CLASS 9—ELECTRICAL AND SCIENTIFIC APPARATUS

FOR COMPUTER SOFTWARE FOR USE BY PROFESSIONAL TICKET BROKERS FOR INVENTORY MANAGEMENT, TICKET TRADING AND ACCOUNTING (U.S. CLS. 21, 23, 26, 36 AND 38).
FIRST USE 2-28-2001; IN COMMERCE 2-28-2001.

CLASS 42—SCIENTIFIC, COMPUTER AND LEGAL SERVICES

FOR APPLICATION SERVICE PROVIDER (ASP) FEATURING SOFTWARE IN THE FIELD OF TICKET BROKERAGE AND TICKET TRADING (U.S. CLS. 100 AND 101).
PAMELA HIRSCHMAN, EXAMINING ATTORNEY

SN 78-849,803. FIREHOOK OF VIRGINIA, INC., CHANTILLY, VA. FILED 3-30-2006.

FIREHOOK

THE MARK CONSISTS OF STANDARD CHARACTERS WITHOUT CLAIM TO ANY PARTICULAR FONT, STYLE, SIZE, OR COLOR.

SAMCO FREEZERWEAR

THE MARK CONSISTS OF STANDARD CHARACTERS WITHOUT CLAIM TO ANY PARTICULAR FONT, STYLE, SIZE, OR COLOR.
OWNER OF U.S. REG. NO. 3,113,602.
SEC. 2(F) AS TO "FREEZERWEAR".

CLASS 25—CLOTHING

FOR CLOTHING, NAMELY, JACKETS, COATS, INSULATED COVERALLS, INSULATED BIB COVERALLS, INSULATED VESTS, INSULATED PANTS, AND HOODS (U.S. CLS. 22 AND 39).
FIRST USE 12-31-1987; IN COMMERCE 12-31-1987.

CLASS 35—ADVERTISING AND BUSINESS

FOR RETAIL STORE SERVICES, AVAILABLE ONLINE AND THROUGH CATALOG, FEATURING CLOTHING (U.S. CLS. 100, 101 AND 102).
FIRST USE 12-31-1987; IN COMMERCE 12-31-1987.
JOHN WILKE, EXAMINING ATTORNEY

SN 78-850,085. OMAHA STEAKS INTERNATIONAL, INC., OMAHA, NE. FILED 3-30-2006.

GOLDEN PLAINS SIMPLY NATURAL FOODS

THE MARK CONSISTS OF STANDARD CHARACTERS WITHOUT CLAIM TO ANY PARTICULAR FONT, STYLE, SIZE, OR COLOR.
OWNER OF U.S. REG. NO. 1,501,486.
NO CLAIM IS MADE TO THE EXCLUSIVE RIGHT TO USE "NATURAL FOODS", APART FROM THE MARK AS SHOWN.

CLASS 29—MEATS AND PROCESSED FOODS

FOR SOUPS; SALADS EXCEPT MACARONI, RICE AND PASTA SALAD; PRE-CUT VEGETABLE SALAD; FROZEN MEALS CONSISTING PRIMARILY OF MEAT, FISH, POULTRY OR VEGETABLES; PREPARED MEALS CONSISTING PRIMARILY OF MEAT, FISH, POULTRY OR VEGETABLES; PACKAGED MEALS CONSISTING PRIMARILY OF MEAT, FISH, POULTRY OR VEGETABLES (U.S. CL. 46).

CLASS 30—STAPLE FOODS

FOR BUTTER SAUCE; BAKERY DESSERTS; MACARONI SALADS; PASTA SALADS; HOT SAUCE; BARBECUE SAUCE; SOY SAUCE; TARTER SAUCE; SPAGHETTI SAUCE; FROZEN MEALS CONSISTING PRIMARILY OF PASTA OR RICE; PREPARED MEALS CONSISTING PRIMARILY OF PASTA OR RICE; PACKAGED MEALS CONSISTING PRIMARILY OF PASTA OR RICE (U.S. CL. 46).

CLASS 35—ADVERTISING AND BUSINESS

FOR ELECTRONIC RETAILING SERVICES VIA COMPUTER FEATURING FOOD AND FOOD RELATED ITEMS; RETAIL STORE SERVICES, AVAILABLE THROUGH COMPUTER COMMUNICATIONS AND INTERACTIVE TELEVISION, FEATURING FOOD AND FOOD RELATED ITEMS; MAIL ORDER CATALOG SERVICES FEATURING FOOD AND FOOD RELATED ITEMS; TELEPHONE SHOP-AT-HOME SERVICES IN THE FIELD OF FOOD AND FOOD RELATED ITEMS; RETAIL STORE SERVICES FEATURING FOOD AND FOOD RELATED ITEMS (U.S. CLS. 100, 101 AND 102).
RONALD AIKENS, EXAMINING ATTORNEY

SN 78-850,110. OMAHA STEAKS INTERNATIONAL, INC., OMAHA, NE. FILED 3-30-2006.



OWNER OF U.S. REG. NO. 1,501,486.
NO CLAIM IS MADE TO THE EXCLUSIVE RIGHT TO USE "NATURAL FOODS", APART FROM THE MARK AS SHOWN.

CLASS 29—MEATS AND PROCESSED FOODS

FOR SOUPS; SALADS EXCEPT MACARONI, RICE AND PASTA SALAD; PRE-CUT VEGETABLE SALAD; FROZEN MEALS CONSISTING PRIMARILY OF MEAT, FISH, POULTRY OR VEGETABLES; PREPARED MEALS CONSISTING PRIMARILY OF MEAT, FISH, POULTRY OR VEGETABLES; PACKAGED MEALS CONSISTING PRIMARILY OF MEAT, FISH, POULTRY OR VEGETABLES (U.S. CL. 46).

CLASS 30—STAPLE FOODS

FOR BUTTER SAUCE; BAKERY DESSERTS; MACARONI SALADS; PASTA SALADS; HOT SAUCE; BARBECUE SAUCE; SOY SAUCE; TARTER SAUCE; SPAGHETTI SAUCE; FROZEN MEALS CONSISTING PRIMARILY OF PASTA OR RICE; PREPARED MEALS CONSISTING PRIMARILY OF PASTA OR RICE; PACKAGED MEALS CONSISTING PRIMARILY OF PASTA OR RICE (U.S. CL. 46).

CLASS 35—ADVERTISING AND BUSINESS

FOR ELECTRONIC RETAILING SERVICES VIA COMPUTER FEATURING FOOD AND FOOD RELATED ITEMS; RETAIL STORE SERVICES, AVAILABLE THROUGH COMPUTER COMMUNICATIONS AND INTERACTIVE TELEVISION, FEATURING FOOD AND FOOD RELATED ITEMS; MAIL ORDER CATALOG SERVICES FEATURING FOOD AND FOOD RELATED ITEMS; TELEPHONE SHOP-AT-HOME SERVICES IN THE FIELD OF FOOD AND FOOD RELATED ITEMS; RETAIL STORE SERVICES FEATURING FOOD AND FOOD RELATED ITEMS (U.S. CLS. 100, 101 AND 102).
RONALD AIKENS, EXAMINING ATTORNEY

SN 78-850,134. THE GRACIOUS GOURMET, LLC, BRIDGEWATER, CT. FILED 3-30-2006.

THE GRACIOUS GOURMET

THE MARK CONSISTS OF STANDARD CHARACTERS WITHOUT CLAIM TO ANY PARTICULAR FONT, STYLE, SIZE, OR COLOR.
NO CLAIM IS MADE TO THE EXCLUSIVE RIGHT TO USE "GOURMET", APART FROM THE MARK AS SHOWN.

CLASS 29—MEATS AND PROCESSED FOODS

FOR JAMS; JELLIES; MARMALADE; OIL, NAMELY, INFUSED OIL; ROASTED NUTS (U.S. CL. 46).

CLASS 30—STAPLE FOODS

FOR BREAKFAST CEREALS; CHUTNEY; COOKIES; CRACKERS; HONEY; HOT CHOCOLATE; PANCAKE MIXES; PANCAKE SYRUP; RELISH; SALAD DRESSINGS; SALSA; SAUCES; TOPPING SYRUP (U.S. CL. 46).
DARRYL SPRUILL, EXAMINING ATTORNEY

SN 78-850,733. HOLLYWOOD HACIENDA, LLC, STUDIO CITY, CA. FILED 3-30-2006.

HOLLYWOOD HACIENDA

THE MARK CONSISTS OF STANDARD CHARACTERS WITHOUT CLAIM TO ANY PARTICULAR FONT, STYLE, SIZE, OR COLOR.
NO CLAIM IS MADE TO THE EXCLUSIVE RIGHT TO USE "HOLLYWOOD", APART FROM THE MARK AS SHOWN.

CLASS 35—ADVERTISING AND BUSINESS

FOR PRODUCTION AND DISTRIBUTION OF TELEVISION, RADIO, INTERNET, AND WIRELESS NETWORK COMMERCIALS (U.S. CLS. 100, 101 AND 102).

CLASS 41—EDUCATION AND ENTERTAINMENT

FOR PRODUCTION AND DISTRIBUTION OF CABLE TELEVISION PROGRAMS FOR OTHERS (U.S. CLS. 100, 101 AND 107).

CHRISTINE COOPER, EXAMINING ATTORNEY

SN 78-850,747. GERLACH, PAUL H., SAN JOSE, CA. FILED 3-31-2006.

CLASS 16—PAPER GOODS AND PRINTED MATTER

FOR PRINTED INSTRUCTIONAL, EDUCATIONAL, AND TEACHING MATERIALS IN THE FIELDS OF BUSINESS, PSYCHOLOGY, PERSONAL DEVELOPMENT AND ACHIEVEMENT, PERSONAL AWARENESS, AND SELF-HELP (U.S. CLS. 2, 5, 22, 23, 29, 37, 38 AND 50).

CLASS 41—EDUCATION AND ENTERTAINMENT

FOR PERSONAL LIFE COACHING SESSIONS, NAMELY, CONDUCTING INDIVIDUAL SESSIONS, GROUP SESSIONS, CLASSES, SEMINARS, WORKSHOPS, PRESENTATIONS, TRAINING PROGRAMS, MENTORING, AND PROVIDING COURSES OF INSTRUCTION IN THE FIELDS OF BUSINESS, PSYCHOLOGY, PERSONAL DEVELOPMENT AND ACHIEVEMENT, PERSONAL AWARENESS, AND SELF-HELP (U.S. CLS. 100, 101 AND 107).

TRAVIS WHEATLEY, EXAMINING ATTORNEY

FIVE LIFE CATEGORIES

THE MARK CONSISTS OF STANDARD CHARACTERS WITHOUT CLAIM TO ANY PARTICULAR FONT, STYLE, SIZE, OR COLOR.

CLASS 16—PAPER GOODS AND PRINTED MATTER

FOR PRINTED INSTRUCTIONAL, EDUCATIONAL, AND TEACHING MATERIALS IN THE FIELDS OF BUSINESS, PSYCHOLOGY, PERSONAL DEVELOPMENT AND ACHIEVEMENT, PERSONAL AWARENESS, AND SELF-HELP (U.S. CLS. 2, 5, 22, 23, 29, 37, 38 AND 50).

CLASS 41—EDUCATION AND ENTERTAINMENT

FOR PERSONAL LIFE COACHING SESSIONS, NAMELY, CONDUCTING INDIVIDUAL SESSIONS, GROUP SESSIONS, CLASSES, SEMINARS, WORKSHOPS, PRESENTATIONS, TRAINING PROGRAMS, MENTORING, AND PROVIDING COURSES OF INSTRUCTION IN THE FIELDS OF BUSINESS, PSYCHOLOGY, PERSONAL DEVELOPMENT AND ACHIEVEMENT, PERSONAL AWARENESS, AND SELF-HELP (U.S. CLS. 100, 101 AND 107).

TRAVIS WHEATLEY, EXAMINING ATTORNEY

SN 78-851,071. GERLACH, PAUL H., SAN JOSE, CA. FILED 3-31-2006.

THE GERLACH MODEL

THE MARK CONSISTS OF STANDARD CHARACTERS WITHOUT CLAIM TO ANY PARTICULAR FONT, STYLE, SIZE, OR COLOR.

SN 78-851,076. MELLON, BARBARA A., BRADDOCK, PA. AND MELLON, CLARK A., BRADDOCK, PA. FILED 3-31-2006.

BLITZ FOR SIX

THE MARK CONSISTS OF STANDARD CHARACTERS WITHOUT CLAIM TO ANY PARTICULAR FONT, STYLE, SIZE, OR COLOR.

CLASS 16—PAPER GOODS AND PRINTED MATTER

FOR PAPER, POSTERS, PICTORAL PRINTS, PICTURE POST CARDS, ART PICTURES, STATIONERY, ENVELOPES, CALENDARS, STICKERS, BUMPER STICKERS, RUB ON DECORATIVE TRANSFERS, PAPER PENNANTS, NOTE PAPER, NOTE PADS, PENCILS, PENS, GREETING CARDS, PAPER NAPKINS, PAPER PARTY INVITATIONS, PAPER GIFT CARDS, PAPER GIFT BAGS, PAPER PARTY DECORATIONS, COLLECTIBLE CARDS, TRADING CARDS, CARDBOARD DRINK COASTERS (U.S. CLS. 2, 5, 22, 23, 29, 37, 38 AND 50).

CLASS 25—CLOTHING

FOR MEN'S, WOMEN'S, CHILDREN'S AND INFANT'S CLOTHING, NAMELY T-SHIRTS, LONG SLEEVE SHIRTS, SLEEVELESS SHIRTS, TANK TOPS, SPORT SHIRTS, JERSEYS, TURTLENECK SHIRTS, SWEATSHIRTS, SWEATPANTS, COVERALLS, INFANT ONE PIECE CLOTHING, BALL CAPS, TOSSEL CAPS, VISORS, BANDANNAS, SWEATBANDS, FLEECE TOPS AND BOTTOMS, PARKAS, PONCHOS, JACKETS, RAINCOATS, SHORTS, SWIMSUITS, SCARVES, TIES, BIBS, APRONS, GLOVES, SOCKS, BOOTIES, UNDERWEAR, BOXER SHORTS, PAJAMAS, AND WRIST BANDS (U.S. CLS. 22 AND 39).

TRAVIS WHEATLEY, EXAMINING ATTORNEY

SN 78-851,096. METONYMY, INC., DBA PLACEBASE, LOS ANGELES, CA. FILED 3-31-2006.

SN 78-851,809. ENGAGE THOUGHTWARE, LLC, BOUNTIFUL, UT. FILED 3-31-2006.

PUSHPIN

THE MARK CONSISTS OF STANDARD CHARACTERS WITHOUT CLAIM TO ANY PARTICULAR FONT, STYLE, SIZE, OR COLOR.

OWNER OF U.S. REG. NO. 2,399,871.

CLASS 9—ELECTRICAL AND SCIENTIFIC APPARATUS

FOR COMPUTER SOFTWARE FOR PERFORMING MAPPING FUNCTIONS, NAMELY, FOR GENERATING, VIEWING, MANIPULATING, ANALYZING AND PRESENTING MAPPING INFORMATION, SPATIAL INFORMATION AND RELATED IMAGES, AND FOR SUPPORTING GEOGRAPHIC INFORMATION SYSTEMS (U.S. CLS. 21, 23, 26, 36 AND 38).

FIRST USE 4-15-2004; IN COMMERCE 11-7-2004.

CLASS 42—SCIENTIFIC, COMPUTER AND LEGAL SERVICES

FOR ONLINE COMPUTER MAPPING SERVICES AND CUSTOMIZED MAPPING SERVICES; PROVIDING ONLINE GEOGRAPHIC INFORMATION AND MAP IMAGES; PROVIDING GEOGRAPHIC INFORMATION BY MEANS OF A WEBSITE ON A GLOBAL COMPUTER NETWORK; CONSULTING SERVICES IN THE FIELDS OF MAPPING SOFTWARE AND GEOGRAPHIC INFORMATION SYSTEMS SUPPORT AND DEVELOPMENT (U.S. CLS. 100 AND 101).

FIRST USE 4-15-2004; IN COMMERCE 11-7-2004.

ATTIYA MALIK, EXAMINING ATTORNEY

SN 78-851,799. BOY, ROBBY R., HOWARDS GROVE, WI. FILED 3-31-2006.

USfun.com

THE MARK CONSISTS OF STANDARD CHARACTERS WITHOUT CLAIM TO ANY PARTICULAR FONT, STYLE, SIZE, OR COLOR.

CLASS 35—ADVERTISING AND BUSINESS

FOR PROVIDING INFORMATION ABOUT AND MAKING REFERRALS IN THE FIELD OF CONSUMER PRODUCTS AND SERVICES FOR RETAIL SERVICES CONCERNING PRODUCTS, SERVICES, EVENTS, ACTIVITIES, ATTRACTIONS AND FACILITIES IN PARTICULAR GEOGRAPHIC LOCATIONS (U.S. CLS. 100, 101 AND 102).

FIRST USE 4-11-2006; IN COMMERCE 4-11-2006.

CLASS 41—EDUCATION AND ENTERTAINMENT

FOR SPECIAL EVENT PLANNING (U.S. CLS. 100, 101 AND 107).

FIRST USE 4-11-2006; IN COMMERCE 4-11-2006.

MIDGE BUTLER, EXAMINING ATTORNEY



CLASS 9—ELECTRICAL AND SCIENTIFIC APPARATUS

FOR DOWNLOADABLE COMPUTER SOFTWARE, NAMELY COLLABORATION SOFTWARE, FOR THE FACILITATION, ANALYSIS AND EVALUATION OF IDEAS, KNOWLEDGE AND PROCESSES (U.S. CLS. 21, 23, 26, 36 AND 38).

FIRST USE 4-7-2006; IN COMMERCE 4-7-2006.

CLASS 42—SCIENTIFIC, COMPUTER AND LEGAL SERVICES

FOR HOSTING OF ORGANIZATIONAL IDEA CULTURE DIGITAL CONTENT ON A COMPUTER NETWORK; PROVIDING TEMPORARY USE OF NON-DOWNLOADABLE SOFTWARE, NAMELY COLLABORATION SOFTWARE, FOR THE FACILITATION, ANALYSIS AND EVALUATION OF IDEAS, KNOWLEDGE AND PROCESSES (U.S. CLS. 100 AND 101).

FIRST USE 4-7-2006; IN COMMERCE 4-7-2006.

GINA HAYES, EXAMINING ATTORNEY

SN 78-852,100. SHEPARDSON, DOUGLAS E, REDONDO BEACH, CA. FILED 4-2-2006.

Global Friends

THE MARK CONSISTS OF STANDARD CHARACTERS WITHOUT CLAIM TO ANY PARTICULAR FONT, STYLE, SIZE, OR COLOR.

CLASS 28—TOYS AND SPORTING GOODS

FOR FANTASY CHARACTER TOYS (U.S. CLS. 22, 23, 38 AND 50).

CLASS 35—ADVERTISING AND BUSINESS

FOR ADVERTISING AND PUBLICITY SERVICES, NAMELY, PROMOTING THE GOODS AND SERVICES OF THIRD PARTIES THROUGH PRINT MEDIUM (U.S. CLS. 100, 101 AND 102).

KATHERINE STOIDES, EXAMINING ATTORNEY

SN 78-852,412. STEWART, ANTHONY W., INDIANAPOLIS, IN. FILED 4-3-2006.

SN 78-853,037. CON FUNK SHUN, FAIRFIELD, CA. FILED 4-3-2006.

TONY STEWART'S ORIGINAL

THE MARK CONSISTS OF STANDARD CHARACTERS WITHOUT CLAIM TO ANY PARTICULAR FONT, STYLE, SIZE, OR COLOR.

OWNER OF U.S. REG. NOS. 2,454,637, 2,518,639 AND 2,838,665.

NO CLAIM IS MADE TO THE EXCLUSIVE RIGHT TO USE "ORIGINAL", APART FROM THE MARK AS SHOWN.

CLASS 25—CLOTHING

FOR CLOTHING, NAMELY, HEADWEAR, SHIRTS, SHORTS, SWEATSHIRTS AND PANTS (U.S. CLS. 22 AND 39).

CLASS 29—MEATS AND PROCESSED FOODS

FOR CHILI AND BEEF JERKY (U.S. CL. 46).

CLASS 30—STAPLE FOODS

FOR MARINADE, MARINARA SAUCE, DIPPING SAUCE AND BARBECUE SAUCE (U.S. CL. 46).

CLASS 43—HOTEL AND RESTAURANT SERVICES

FOR RESTAURANT AND BAR SERVICES (U.S. CLS. 100 AND 101).
JASON ROTH, EXAMINING ATTORNEY

SN 78-852,417. MERRIMAN, JAMES JOHN, STRONGSVILLE, OH. FILED 4-3-2006.

SUDS-N-MUDS

THE MARK CONSISTS OF STANDARD CHARACTERS WITHOUT CLAIM TO ANY PARTICULAR FONT, STYLE, SIZE, OR COLOR.

CLASS 37—CONSTRUCTION AND REPAIR

FOR SELF-SERVICE LAUNDRIES (U.S. CLS. 100, 103 AND 106).

CLASS 38—COMMUNICATION

FOR INTERNET CAFE SERVICES, NAMELY, PROVIDING TELECOMMUNICATIONS CONNECTIONS TO THE INTERNET IN A CAFE ENVIRONMENT (U.S. CLS. 100, 101 AND 104).

CLASS 43—HOTEL AND RESTAURANT SERVICES

FOR CAFES; COFFEE SHOPS; COFFEE-HOUSE AND SNACK-BAR SERVICES (U.S. CLS. 100 AND 101).
YONG KIM, EXAMINING ATTORNEY

CON FUNK SHUN

THE MARK CONSISTS OF STANDARD CHARACTERS WITHOUT CLAIM TO ANY PARTICULAR FONT, STYLE, SIZE, OR COLOR.

CLASS 9—ELECTRICAL AND SCIENTIFIC APPARATUS

FOR PRE-RECORDED CD'S, VIDEO TAPES, LASER DISKS AND DVD'S FEATURING AUDIO AND/OR AUDIO VISUAL MUSICAL PERFORMANCES AND INTERVIEWS (U.S. CLS. 21, 23, 26, 36 AND 38).

FIRST USE 7-15-1973; IN COMMERCE 12-31-1993.

CLASS 41—EDUCATION AND ENTERTAINMENT

FOR ENTERTAINMENT IN THE NATURE OF LIVE PERFORMANCES BY MUSICAL GROUP (U.S. CLS. 100, 101 AND 107).

FIRST USE 7-15-1973; IN COMMERCE 12-31-1993.
KATHERINE STOIDES, EXAMINING ATTORNEY

SN 78-853,669. SOUTHERN CHAMPION TRAY, CHATTANOOGA, TN. FILED 4-4-2006.

ChampWare

THE MARK CONSISTS OF STANDARD CHARACTERS WITHOUT CLAIM TO ANY PARTICULAR FONT, STYLE, SIZE, OR COLOR.

CLASS 16—PAPER GOODS AND PRINTED MATTER

FOR PAPER CARRIERS FOR FOOD AND DRINKS (U.S. CLS. 2, 5, 22, 23, 29, 37, 38 AND 50).
FIRST USE 3-27-2006; IN COMMERCE 3-27-2006.

CLASS 21—HOUSEWARES AND GLASS

FOR PAPER PLATES AND BOWLS (U.S. CLS. 2, 13, 23, 29, 30, 33, 40 AND 50).
FIRST USE 3-27-2006; IN COMMERCE 3-27-2006.
ALLISON SCHRODY, EXAMINING ATTORNEY

SN 78-853,734. JOHN PILS POSTERS, LTD., BALLWIN, MO.
FILED 4-4-2006.

JOHN PILS

THE MARK CONSISTS OF STANDARD CHARACTERS WITHOUT CLAIM TO ANY PARTICULAR FONT, STYLE, SIZE, OR COLOR.

JOHN PILS IDENTIFIES A LIVING INDIVIDUAL WHOSE CONSENT IS OF RECORD.

CLASS 6—METAL GOODS

FOR METAL ORNAMENTS NOT OF PRECIOUS METAL (U.S. CLS. 2, 12, 13, 14, 23, 25 AND 50).
FIRST USE 10-0-1999; IN COMMERCE 10-0-1999.

CLASS 16—PAPER GOODS AND PRINTED MATTER

FOR ARTWORK, NAMELY, PENCIL LINE DRAWINGS, WATER COLOR PAINTINGS, LITHOGRAPHS, ILLUSTRATIONS, ART PRINTS, PRINTED ART REPRODUCTIONS (U.S. CLS. 2, 5, 22, 23, 29, 37, 38 AND 50).
FIRST USE 7-0-1981; IN COMMERCE 7-0-1981.
JENNIFER KRISP, EXAMINING ATTORNEY

SN 78-853,964. GMP FITNESS, L.L.C., SADDLE RIVER, NJ.
FILED 4-4-2006.



THE COLOR(S) RED, BLACK, WHITE, BLUE AND GREEN. IS/ARE CLAIMED AS A FEATURE OF THE MARK.

THE MARK CONSISTS OF THE MARK CONSISTS OF A MAN AND A WOMAN IN A YOGA POSITION BOTH IN A RED TOP AND BLACK PANTS IN THE FORM OF AN X. THE X BEHIND THE MAN AND WOMAN IS WHITE WITH 2 PURPLE BORDER LINES THAT MAKE UP 4 GREEN HALF DIAMONDS. THE FINAL FORMATION IS A SQUARE WITH 2 PURPLE BORDERS. THE WORDS PRO X 4 LIFE ARE WHITE.

CLASS 9—ELECTRICAL AND SCIENTIFIC APPARATUS

FOR PRERECORDED VIDEO TAPES, AUDIO CASSETTES, CD'S AND DVD'S, FEATURING INFORMATION AND INSTRUCTION RELATING TO HEALTH EDUCATION, EXERCISE, FITNESS INSTRUCTION, NUTRITION, WEIGHT MANAGEMENT AND WELLNESS (U.S. CLS. 21, 23, 26, 36 AND 38).

FIRST USE 1-11-2006; IN COMMERCE 1-11-2006.

CLASS 16—PAPER GOODS AND PRINTED MATTER

FOR PRINTED MATERIALS, NAMELY, BOOKS, BROCHURES, NEWSLETTERS, AND PRINTED CARDS, FEATURING INFORMATION AND INSTRUCTION RELATING TO HEALTH EDUCATION, EXERCISE, FITNESS INSTRUCTION, NUTRITION, WEIGHT MANAGEMENT AND WELLNESS (U.S. CLS. 2, 5, 22, 23, 29, 37, 38 AND 50).

FIRST USE 1-11-2006; IN COMMERCE 1-11-2006.

CLASS 41—EDUCATION AND ENTERTAINMENT

FOR EDUCATIONAL SERVICES, NAMELY, CONDUCTING CLASSES, DEMONSTRATIONS IN EXHIBIT BOOTHS, SEMINARS, CONFERENCES, WORKSHOPS, PROGRAMS AND LECTURES, IN THE FIELDS OF HEALTH AND FITNESS (U.S. CLS. 100, 101 AND 107).

FIRST USE 3-4-2006; IN COMMERCE 3-4-2006.
GIANCARLO CASTRO, EXAMINING ATTORNEY

SN 78-854,255. SOUTHERN CHAMPION TRAY, LP, CHATTANOOGA, TN. FILED 4-5-2006.

ChampWare

CLASS 16—PAPER GOODS AND PRINTED MATTER

FOR PAPER CARRIERS FOR FOOD AND DRINKS (U.S. CLS. 2, 5, 22, 23, 29, 37, 38 AND 50).
FIRST USE 3-27-2006; IN COMMERCE 3-27-2006.

CLASS 21—HOUSEWARES AND GLASS

FOR DINNERWARE, NAMELY, PAPER PLATES AND BOWLS; DISHES AND PLATES; MEAL TRAYS; PLATES; PLATES FOR HORS D'OEUVRE; SERVING TRAYS NOT OF PRECIOUS METAL; TRAYS (U.S. CLS. 2, 13, 23, 29, 30, 33, 40 AND 50).

FIRST USE 3-27-2006; IN COMMERCE 3-27-2006.
ALLISON SCHRODY, EXAMINING ATTORNEY

SN 78-854,353. CWI, INC., BOWLING GREEN, KY. FILED 4-5-2006.

CAMPING WORLD XPRESS

THE MARK CONSISTS OF STANDARD CHARACTERS WITHOUT CLAIM TO ANY PARTICULAR FONT, STYLE, SIZE, OR COLOR.

OWNER OF U.S. REG. NOS. 930,179, 2,648,960 AND OTHERS.

NO CLAIM IS MADE TO THE EXCLUSIVE RIGHT TO USE "CAMPING", APART FROM THE MARK AS SHOWN.

CLASS 35—ADVERTISING AND BUSINESS

FOR RETAIL STORE SERVICES, MAIL ORDER SERVICES, AND COMPUTERIZED ONLINE ORDERING SERVICES, ALL IN THE FIELD OF RECREATIONAL VEHICLE EQUIPMENT, VEHICLE ACCESSORIES, VEHICLE SUPPLIES, CAMPING EQUIPMENT, CAMPING ACCESSORIES, AND CAMPING SUPPLIES (U.S. CLS. 100, 101 AND 102).

CLASS 37—CONSTRUCTION AND REPAIR

FOR INSTALLATION, MAINTENANCE, SERVICE AND REPAIR OF RECREATIONAL VEHICLES, RECREATIONAL VEHICLE EQUIPMENT, RECREATIONAL VEHICLE ACCESSORIES, AND RECREATIONAL VEHICLE SUPPLIES (U.S. CLS. 100, 103 AND 106).

MARY MUNSON, EXAMINING ATTORNEY

CLASS 41—EDUCATION AND ENTERTAINMENT

FOR LANGUAGE TRANSLATION SERVICES; ON-LINE LANGUAGE TRANSLATION SERVICES; REAL-TIME LANGUAGE TRANSLATION SERVICES; TEACHING IN THE FIELD OF LANGUAGE (U.S. CLS. 100, 101 AND 107).

YONG KIM, EXAMINING ATTORNEY

SN 78-854,356. CWI, INC., BOWLING GREEN, KY. FILED 4-5-2006.

SN 78-854,736. OUTDOOR LIFE NETWORK, L.L.C., STAMFORD, CT. FILED 4-5-2006.



OWNER OF U.S. REG. NOS. 930,179, 2,648,960 AND OTHERS.

NO CLAIM IS MADE TO THE EXCLUSIVE RIGHT TO USE "CAMPING", APART FROM THE MARK AS SHOWN.

CLASS 35—ADVERTISING AND BUSINESS

FOR RETAIL STORE SERVICES, MAIL ORDER SERVICES, AND COMPUTERIZED ONLINE ORDERING SERVICES, ALL IN THE FIELD OF RECREATIONAL VEHICLE EQUIPMENT, VEHICLE ACCESSORIES, VEHICLE SUPPLIES, CAMPING EQUIPMENT, CAMPING ACCESSORIES, AND CAMPING SUPPLIES (U.S. CLS. 100, 101 AND 102).

CLASS 37—CONSTRUCTION AND REPAIR

FOR INSTALLATION, MAINTENANCE, SERVICE AND REPAIR OF RECREATIONAL VEHICLES, RECREATIONAL VEHICLE EQUIPMENT, RECREATIONAL VEHICLE ACCESSORIES, AND RECREATIONAL VEHICLE SUPPLIES (U.S. CLS. 100, 103 AND 106).

MARY MUNSON, EXAMINING ATTORNEY

VERSUS TV

THE MARK CONSISTS OF STANDARD CHARACTERS WITHOUT CLAIM TO ANY PARTICULAR FONT, STYLE, SIZE, OR COLOR.

NO CLAIM IS MADE TO THE EXCLUSIVE RIGHT TO USE "TV", APART FROM THE MARK AS SHOWN.

CLASS 38—COMMUNICATION

FOR BROADCAST OF CABLE TELEVISION PROGRAMMES; CABLE TELEVISION BROADCASTING; SATELLITE TELEVISION BROADCASTING; TELEVISION BROADCASTING (U.S. CLS. 100, 101 AND 104).

CLASS 41—EDUCATION AND ENTERTAINMENT

FOR DIRECTION OF MAKING RADIO OR TELEVISION PROGRAMS; DISTRIBUTION OF TELEVISION PROGRAMMING TO CABLE TELEVISION SYSTEMS; PRODUCTION OF CABLE TELEVISION PROGRAMS; PRODUCTION OF RADIO OR TELEVISION PROGRAMS (U.S. CLS. 100, 101 AND 107).

SHAUNIA WALLACE, EXAMINING ATTORNEY

SN 78-854,450. NEXTWIRE SYSTEMS, INC., MENLO PARK, CA. FILED 4-5-2006.

SN 78-854,746. OUTDOOR LIFE NETWORK, L.L.C., STAMFORD, CT. FILED 4-5-2006.

NEWTALK

THE MARK CONSISTS OF STANDARD CHARACTERS WITHOUT CLAIM TO ANY PARTICULAR FONT, STYLE, SIZE, OR COLOR.

CLASS 9—ELECTRICAL AND SCIENTIFIC APPARATUS

FOR COMPUTER SOFTWARE, FIRMWARE AND HARDWARE FOR REAL-TIME SPOKEN LANGUAGE TRANSLATION; COMPUTER SOFTWARE, FIRMWARE AND HARDWARE FOR LANGUAGE TRANSLATION VIA HAND-HELD MOBILE DEVICES; COMPUTER SOFTWARE, FIRMWARE AND HARDWARE FOR WRITTEN LANGUAGE TRANSLATION (U.S. CLS. 21, 23, 26, 36 AND 38).

VERSUS CHANNEL

THE MARK CONSISTS OF STANDARD CHARACTERS WITHOUT CLAIM TO ANY PARTICULAR FONT, STYLE, SIZE, OR COLOR.

NO CLAIM IS MADE TO THE EXCLUSIVE RIGHT TO USE "CHANNEL", APART FROM THE MARK AS SHOWN.

CLASS 38—COMMUNICATION

FOR BROADCAST OF CABLE TELEVISION PROGRAMMES; CABLE TELEVISION BROADCASTING; SATELLITE TELEVISION BROADCASTING; TELEVISION BROADCASTING (U.S. CLS. 100, 101 AND 104).

CLASS 41—EDUCATION AND ENTERTAINMENT

FOR DIRECTION OF MAKING RADIO OR TELEVISION PROGRAMS; DISTRIBUTION OF TELEVISION PROGRAMMING TO CABLE TELEVISION SYSTEMS; PRODUCTION OF CABLE TELEVISION PROGRAMS; PRODUCTION OF RADIO OR TELEVISION PROGRAMS (U.S. CLS. 100, 101 AND 107).
SHAUNIA WALLACE, EXAMINING ATTORNEY

SN 78-854,936. GARMIN LTD., GEORGE TOWN, CAYMAN ISLANDS, FILED 4-5-2006.

We'll take you there

THE MARK CONSISTS OF STANDARD CHARACTERS WITHOUT CLAIM TO ANY PARTICULAR FONT, STYLE, SIZE, OR COLOR.

CLASS 9—ELECTRICAL AND SCIENTIFIC APPARATUS

FOR AUTOMOBILE NAVIGATION APPARATUS FEATURING GPS RECEIVERS, DIGITAL MAP DISPLAYS AND TURN-BY-TURN INSTRUCTIONS; ELECTRONIC MARINE NAVIGATION PRODUCTS, NAMELY, CHART PLOTTERS AND SONAR DEPTH SOUNDERS; AVIONICS, NAMELY, PORTABLE AND PANEL MOUNTED ELECTRONIC NAVIGATION INSTRUMENTS FOR ASSISTING A PILOT IN NAVIGATING AN AIRCRAFT, PRIMARY FLIGHT DISPLAYS AND MULTI-FUNCTION FLIGHT DISPLAYS; GPS RECEIVERS; PORTABLE GPS DEVICES, NAMELY, ELECTRONIC INSTRUMENTS FOR DETERMINING AND OUTPUTTING POSITION AND SPEED; MARINE ELECTRONIC APPARATUS, NAMELY, MARINE SONAR FISH FINDERS; ELECTRONIC CHART PLOTTERS; WIRELESS COMMUNICATIONS RADIOS; WIRELESS COMMUNICATIONS RADIOS FEATURING A GPS RECEIVER; PERSONAL DIGITAL ASSISTANTS FEATURING A GPS RECEIVER AND ELECTRONIC MAPS; SATELLITE RADIO RECEIVERS; ELECTRONIC NAVIGATION DEVICES, NAMELY, GPS RECEIVERS HAVING AN ELECTRONIC COMPASS; ELECTRONIC NAVIGATION DEVICES NAMELY, GPS RECEIVERS HAVING AN ALTIMETER; ELECTRONIC STORAGE MEDIA, NAMELY, CD-ROMS, DVDS, DISCS AND CARDS CONTAINING MAP DATA; AND NAVIGATION SOFTWARE FOR CALCULATING AND DISPLAYING ROUTES; ELECTRONIC EXERCISE MONITOR, NAMELY, AN ELECTRONIC TRACKING DEVICE; ELECTRONIC EXERCISE MONITOR FEATURING A GPS RECEIVER, NAMELY, AN ELECTRONIC TRACKING DEVICE (U.S. CLS. 21, 23, 26, 36 AND 38).

SN 78-854,749. MINITAB INC., STATE COLLEGE, PA. FILED 4-5-2006.

QUALITY. ANALYSIS. RESULTS.

THE MARK CONSISTS OF STANDARD CHARACTERS WITHOUT CLAIM TO ANY PARTICULAR FONT, STYLE, SIZE, OR COLOR.

CLASS 9—ELECTRICAL AND SCIENTIFIC APPARATUS

FOR COMPUTER PROGRAMS AND INSTRUCTIONAL MANUALS SOLD AS A UNIT FOR USE IN THE FIELD OF STATISTICS, QUALITY IMPROVEMENT AND DATA ANALYSIS; CD-ROM, DISKETTES, OR DOWNLOADABLE SOFTWARE FROM A COMPUTER FILE SERVER FEATURING USER MANUALS FOR COMPUTER SOFTWARE IN THE FIELD OF STATISTICS, QUALITY IMPROVEMENT AND DATA ANALYSIS; ELECTRONIC MATERIALS, NAMELY, TRAINING MANUALS USED IN THE FIELD OF STATISTICS, QUALITY IMPROVEMENT AND DATA ANALYSIS RECORDED ON MAGNETIC MEDIA (U.S. CLS. 21, 23, 26, 36 AND 38).

CLASS 10—MEDICAL APPARATUS

FOR ELECTRONIC EXERCISE MONITOR, NAMELY, A HEART RATE MONITOR; ELECTRONIC EXERCISE MONITOR FEATURING A GPS RECEIVER, NAMELY, A HEART RATE MONITOR (U.S. CLS. 26, 39 AND 44).
TRAVIS WHEATLEY, EXAMINING ATTORNEY

CLASS 16—PAPER GOODS AND PRINTED MATTER

FOR PRINTED TRAINING MATERIALS, NAMELY, BOOKS FEATURING INFORMATION IN THE FIELDS OF STATISTICS, DATA ANALYSIS, QUALITY IMPROVEMENT AND COMPUTER SOFTWARE, AND PRINTED USER MANUALS (U.S. CLS. 2, 5, 22, 23, 29, 37, 38 AND 50).

SN 78-854,958. PLAYBOY ENTERPRISES INTERNATIONAL, INC., CHICAGO, IL. FILED 4-5-2006.

TRADE TV

CLASS 41—EDUCATION AND ENTERTAINMENT

FOR PROVIDING TRAINING SESSIONS, CONDUCTING CLASSES AND SEMINARS IN THE FIELD OF STATISTICS, DATA ANALYSIS, QUALITY IMPROVEMENT AND COMPUTER SOFTWARE (U.S. CLS. 100, 101 AND 107).
MICHAEL LEWIS, EXAMINING ATTORNEY

THE MARK CONSISTS OF STANDARD CHARACTERS WITHOUT CLAIM TO ANY PARTICULAR FONT, STYLE, SIZE, OR COLOR.
NO CLAIM IS MADE TO THE EXCLUSIVE RIGHT TO USE "TV", APART FROM THE MARK AS SHOWN.

CLASS 38—COMMUNICATION

FOR CABLE TELEVISION BROADCASTING; CABLE TELEVISION TRANSMISSION; SATELLITE TELEVISION BROADCASTING; SUBSCRIPTION TELEVISION BROADCASTING; TELEVISION BROADCASTING; TELEVISION TRANSMISSION SERVICES (U.S. CLS. 100, 101 AND 104).

CLASS 41—EDUCATION AND ENTERTAINMENT

FOR CABLE TELEVISION PROGRAMMING; DISTRIBUTION OF TELEVISION PROGRAMMING TO CABLE TELEVISION SYSTEMS; ENTERTAINMENT IN THE NATURE OF ON-GOING TELEVISION PROGRAMS IN THE FIELD OF ADULT ENTERTAINMENT; TELEVISION PROGRAMMING; TELEVISION SCHEDULING; TELEVISION SHOW PRODUCTION (U.S. CLS. 100, 101 AND 107).

MARY ROSSMAN, EXAMINING ATTORNEY

SN 78-855,075. RICH, MICHAEL, ORANGE PARK, FL. FILED 4-5-2006.

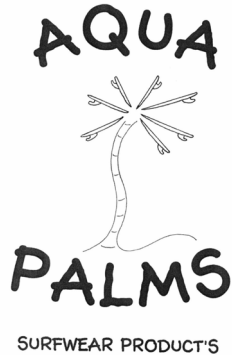

NO CLAIM IS MADE TO THE EXCLUSIVE RIGHT TO USE SURFWEAR PRODUCTS, APART FROM THE MARK AS SHOWN.

CLASS 24—FABRICS

FOR BEACH TOWELS (U.S. CLS. 42 AND 50).

CLASS 25—CLOTHING

FOR CLOTHING, NAMELY, SHIRTS, HALTER TOPS, TANK TOPS, T-SHIRTS, CAPS, HATS (U.S. CLS. 22 AND 39).

PAULA MAHONEY, EXAMINING ATTORNEY

SN 78-855,080. ENGLISH LANGUAGE LEARNING AND INSTRUCTION SYSTEM, INC., SALT LAKE CITY, UT. FILED 4-5-2006.

ELLIS

THE MARK CONSISTS OF STANDARD CHARACTERS WITHOUT CLAIM TO ANY PARTICULAR FONT, STYLE, SIZE, OR COLOR.

CLASS 9—ELECTRICAL AND SCIENTIFIC APPARATUS

FOR EDUCATIONAL COMPUTER SOFTWARE FOR STUDENTS FEATURING INSTRUCTION IN ENGLISH AS A SECOND LANGUAGE AND PRERECORDED DIGITAL VIDEO DISKS FEATURING INSTRUCTIONAL MATERIALS FOR STUDENTS OF ENGLISH AS A SECOND LANGUAGE (U.S. CLS. 21, 23, 26, 36 AND 38). FIRST USE 9-1-1993; IN COMMERCE 9-1-1993.

CLASS 16—PAPER GOODS AND PRINTED MATTER

FOR MANUALS IN THE FIELD OF ENGLISH AS A SECOND LANGUAGE (U.S. CLS. 2, 5, 22, 23, 29, 37, 38 AND 50).

FIRST USE 9-1-1993; IN COMMERCE 9-1-1993.
PAULA MAHONEY, EXAMINING ATTORNEY

SN 78-855,318. HOGG ROBINSON PLC, BASINGSTOKE, HAMPSHIRE, UNITED KINGDOM, FILED 4-6-2006.

HRG TRAVELWATCH

THE MARK CONSISTS OF STANDARD CHARACTERS WITHOUT CLAIM TO ANY PARTICULAR FONT, STYLE, SIZE, OR COLOR.

CLASS 35—ADVERTISING AND BUSINESS

FOR PROVISION OF BUSINESS AND MANAGEMENT INFORMATION AND REPORTS ALL RELATING TO TRAVEL, TRAVEL SERVICES AND THE LOCATION OF TRAVELERS (U.S. CLS. 100, 101 AND 102).

CLASS 39—TRANSPORTATION AND STORAGE

FOR PROVISION OF TRAVEL INFORMATION AND INFORMATION GIVEN TO TRAVELERS RELATING TO MATTERS EFFECTING THE PROGRESS OF THEIR JOURNEY (U.S. CLS. 100 AND 105).

CLASS 43—HOTEL AND RESTAURANT SERVICES

FOR PROVISION OF INFORMATION RELATING TO THE RESERVATION OF HOTEL ACCOMODATION (U.S. CLS. 100 AND 101).

LINDA E. BLOHM, EXAMINING ATTORNEY

SN 78-855,332. TICK TOCK ENERGY, INC., TEUTOPOLIS, IL. FILED 4-6-2006.

TICK TOCK ENERGY

THE MARK CONSISTS OF STANDARD CHARACTERS WITHOUT CLAIM TO ANY PARTICULAR FONT, STYLE, SIZE, OR COLOR.

NO CLAIM IS MADE TO THE EXCLUSIVE RIGHT TO USE ENERGY, APART FROM THE MARK AS SHOWN.

CLASS 35—ADVERTISING AND BUSINESS

FOR RETAIL SERVICES BY DIRECT SOLICITATION BY SALES AGENTS FEATURING THE GOODS OF OTHERS, NAMELY, EQUIPMENT FOR ENERGY EFFICIENCY, RENEWABLE ENERGY, AND DISTRIBUTED POWER GENERATION; BUSINESS SERVICES IN THE NATURE OF ENERGY USAGE MANAGEMENT IN THE FIELD OF ENERGY AND UTILITIES MANAGEMENT, ENERGY EFFICIENCY, ENERGY CONSERVATION, RENEWABLE ENERGY, AND DISTRIBUTED POWER GENERATION, COST ANALYSIS WITH REGARDS TO FUND, LEASE AND/OR REDUCE THE COST OF IMPLEMENTING ENERGY MANAGEMENT, RENEWABLE ENERGY, AND DISTRIBUTED POWER GENERATION EQUIPMENT, MONITORING AND REPORTING ENERGY PERFORMANCE FOR EQUIPMENT AND BUILDINGS, EVALUATING ENERGY CONSUMPTION TRENDS, AND PROVIDING ON-GOING ADVISORY SERVICES ON METHODS TO MINIMIZE ENERGY AND UTILITY CONSUMPTION AND RELATED OPERATING COSTS; CONDUCTING ENERGY EFFICIENCY SURVEYS, ENERGY AUDITING, ENERGY EFFICIENCY ANALYSIS AND STUDIES ALL IN THE FIELDS OF ENERGY CONSERVATION, EFFICIENCY, MANAGEMENT, RENEWABLE ENERGY AND ENERGY GENERATION; BUSINESS CONSULTING RELATING TO OPERATIONS MANAGEMENT (U.S. CLS. 100, 101 AND 102).

CLASS 37—CONSTRUCTION AND REPAIR

FOR INSTALLATION, MAINTENANCE AND REPAIR OF ENERGY EFFICIENCY, RENEWABLE ENERGY, AND DISTRIBUTED POWER GENERATION EQUIPMENT AND SYSTEMS, AND ANCILLARY COMPONENTS FOR FACILITIES (U.S. CLS. 100, 103 AND 106).

CLASS 42—SCIENTIFIC, COMPUTER AND LEGAL SERVICES

FOR DESIGN ENGINEERING OF ENERGY EQUIPMENT, CONDUCTING ECONOMIC FEASIBILITY STUDIES, DESIGN SERVICES IN THE FIELD OF ENERGY EQUIPMENT, INSPECTION OF ENERGY EQUIPMENT (U.S. CLS. 100 AND 101).

TARAH HARDY, EXAMINING ATTORNEY

SN 78-855,387. BIG D ENTERPRISES, LLC, COTO DE CAZA, CA. FILED 4-6-2006.

IPPOS

THE MARK CONSISTS OF STANDARD CHARACTERS WITHOUT CLAIM TO ANY PARTICULAR FONT, STYLE, SIZE, OR COLOR.

THE ENGLISH TRANSLATION OF THE ANCIENT GREEK WORD "IPPOS" IN THE MARK IS "HORSE".

CLASS 18—LEATHER GOODS

FOR GOODS OF LEATHER AND IMITATION LEATHER, NAMELY, TRAVEL CASES, TRUNKS AND SUITCASES, CARRY-ON BAGS, LEATHER SHOPPING BAGS; SPORTS BAGS, GARMENT BAGS FOR TRAVEL, BOOT BAGS, HAT BAGS, COSMETIC BAGS SOLD EMPTY, DUFFEL BAGS, CLUTCH BAGS, BOOK BAGS, TOTE BAGS, CARRYALL BAGS, NET BAGS FOR SHOPPING, TRAVEL BAGS, BACKPACKS, HANDBAGS, CARRYING CASES FOR CLOTHING, SHOES, BOOTS, HATS AND ACCESSORIES, NAMELY, SUITCASES AND GEAR BAGS; WAISTBAGS, KEY CASES, PURSES, WALLET, RUCKSACKS, VANITY CASES SOLD EMPTY, UMBRELLAS; EQUESTRIAN EQUIPMENT, NAMELY, HORSE BLANKETS, SADDLE PADS, SADDLE BAGS AND BRIDLE BAGS (U.S. CLS. 1, 2, 3, 22 AND 41).

CLASS 25—CLOTHING

FOR CLOTHING, NAMELY SHIRTS, BLOUSES, TOPS, JEANS, TEE SHIRTS, SKIRTS, SWEATSHIRTS, SHORTS, PANTS, KNICKERS, HOSIERY, SOCKS, STOCKINGS, TIES, ASCOTS, OUTERWEAR, NAMELY, JACKETS, SWEATERS, VESTS, RAINCOATS, CAPES, SLICKERS, OVERALLS, SCARVES, MUFFLERS; PAJAMAS, HATS, CAPS, BELTS, GLOVES; FOOTWEAR, NAMELY, SHOES, SANDALS, BOOTS, SPORT SHOES; HEADWEAR, NAMELY, SUN VISORS; HEADGEAR, NAMELY, HATS AND CAPS; EQUESTRIAN CLOTHING, NAMELY, JODHPURS, BREECHES, SHOW SHIRTS, HUNT JACKETS, JERSEYS AND POLO STYLE SHIRTS (U.S. CLS. 22 AND 39).

GINA FINK, EXAMINING ATTORNEY

SN 78-855,428. AT&T CORP., NEW YORK, NY. FILED 4-6-2006.

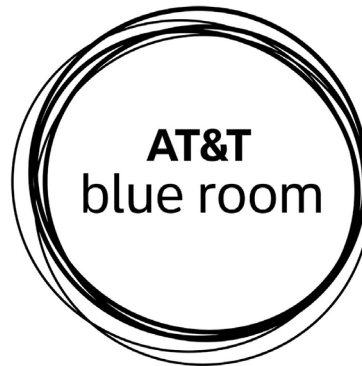

OWNER OF U.S. REG. NOS. 2,051,233, 2,110,288 AND OTHERS.

CLASS 38—COMMUNICATION

FOR TELECOMMUNICATIONS SERVICES, NAMELY, STREAMING OF AUDIO AND VIDEO MATERIAL ON THE INTERNET (U.S. CLS. 100, 101 AND 104).

FIRST USE 1-1-2006, THE MARK WAS FIRST USED ANYWHERE IN A DIFFERENT FORM OTHER THAN THAT SOUGHT TO BE REGISTERED ON 04/15/2005.; IN COMMERCE 1-1-2006, THE MARK WAS FIRST USED IN COMMERCE IN A DIFFERENT FORM OTHER THAN THAT SOUGHT TO BE REGISTERED ON 04/15/2005..

CLASS 41—EDUCATION AND ENTERTAINMENT

FOR PROVIDING NEWSLETTERS IN THE FIELDS OF TELECOMMUNICATIONS PRODUCTS AND SERVICES, ENTERTAINMENT, MUSIC, CONCERTS, VIDEOS, NEWS, AND MOVIES VIA E-MAIL (U.S. CLS. 100, 101 AND 107).

FIRST USE 1-1-2006, THE MARK WAS FIRST USED ANYWHERE IN A DIFFERENT FORM OTHER THAN THAT SOUGHT TO BE REGISTERED ON 04/15/2005.; IN COMMERCE 1-1-2006, THE MARK WAS FIRST USED IN COMMERCE IN A DIFFERENT FORM OTHER THAN THAT SOUGHT TO BE REGISTERED ON 04/15/2005..
TRICIA SONNEBORN, EXAMINING ATTORNEY

SN 78-855,448. TUBE WORLD, INC., SHEBOYGAN, WI.
FILED 4-6-2006.

KÜHL·TUBE

THE MARK CONSISTS OF STANDARD CHARACTERS WITHOUT CLAIM TO ANY PARTICULAR FONT, STYLE, SIZE, OR COLOR.

NO CLAIM IS MADE TO THE EXCLUSIVE RIGHT TO USE TUBE, APART FROM THE MARK AS SHOWN.

THE ENGLISH TRANSLATION OF THE WORD KÜHL IN THE MARK IS COOL.

CLASS 9—ELECTRICAL AND SCIENTIFIC APPARATUS

FOR ELECTRON TUBES WITH A VACUUM FEATURE (U.S. CLS. 21, 23, 26, 36 AND 38).

CLASS 40—MATERIAL TREATMENT

FOR CRYOGENIC PRESERVATION (U.S. CLS. 100, 103 AND 106).

CAROLINE WOOD, EXAMINING ATTORNEY

SN 78-855,486. JADED PIXEL TECHNOLOGIES INC., OTTAWA, ONTARIO, CANADA, FILED 4-6-2006.

**CLASS 9—ELECTRICAL AND SCIENTIFIC APPARATUS**

FOR COMPUTER E-COMMERCE SOFTWARE TO ALLOW USERS TO PERFORM ELECTRONIC BUSINESS TRANSACTIONS VIA A GLOBAL COMPUTER NETWORK (U.S. CLS. 21, 23, 26, 36 AND 38).

FIRST USE 8-27-2005; IN COMMERCE 8-27-2005.

CLASS 42—SCIENTIFIC, COMPUTER AND LEGAL SERVICES

FOR DESIGN, CREATION, HOSTING AND MAINTENANCE OF INTERNET SITES FOR THIRD PARTIES (U.S. CLS. 100 AND 101).

FIRST USE 8-27-2005; IN COMMERCE 8-27-2005.
DANNEAN HETZEL, EXAMINING ATTORNEY

SN 78-855,586. SOTTOPELLE, INC., SCOTTSDALE, AZ.
FILED 4-6-2006.

SOTTOPELLE VITALITY

THE MARK CONSISTS OF STANDARD CHARACTERS WITHOUT CLAIM TO ANY PARTICULAR FONT, STYLE, SIZE, OR COLOR.

OWNER OF U.S. REG. NO. 2,916,806.

NO CLAIM IS MADE TO THE EXCLUSIVE RIGHT TO USE "SOTTO PELLE", APART FROM THE MARK AS SHOWN.

THE FOREIGN WORDING SOTTO PELLE IN THE MARK TRANSLATES INTO ENGLISH AS "UNDER SKIN."

CLASS 5—PHARMACEUTICALS

FOR BIO-IDENTICAL HORMONE PELLETS FOR USE IN HORMONE REPLACEMENT THERAPY AND BIO-IDENTICAL SUBDERMAL TESTOSTERONE AND ESTRODIAL PELLETS FOR HORMONE REPLACEMENT THERAPY (U.S. CLS. 6, 18, 44, 46, 51 AND 52).

CLASS 41—EDUCATION AND ENTERTAINMENT

FOR MEDICAL TRAINING AND TEACHING; CONDUCTING SEMINARS IN THE FIELDS OF OBSTETRICS AND GYNECOLOGY; INSTRUCTION IN THE FIELD OF OBSTETRICS AND GYNECOLOGY; TRAINING SERVICES FOR PHYSICIANS IN THE FIELD OF OBSTETRICS, GYNECOLOGY AND HORMONE REPLACEMENT THERAPY SERVICES (U.S. CLS. 100, 101 AND 107).

CLASS 44—MEDICAL, BEAUTY AND AGRICULTURAL SERVICES

FOR MEDICAL SERVICES, NAMELY, OBSTETRICS AND GYNECOLOGY SERVICES; HORMONE REPLACEMENT THERAPY SERVICES (U.S. CLS. 100 AND 101).
STEVEN PEREZ, EXAMINING ATTORNEY

SN 78-855,619. PLAID RANCH, LLC, PETALUMA, CA.
FILED 4-6-2006.

Plaid Ranch

THE MARK CONSISTS OF STANDARD CHARACTERS WITHOUT CLAIM TO ANY PARTICULAR FONT, STYLE, SIZE, OR COLOR.

NO CLAIM IS MADE TO THE EXCLUSIVE RIGHT TO USE "RANCH", APART FROM THE MARK AS SHOWN.

CLASS 25—CLOTHING

FOR DRESSES; HATS; JACKETS; OVERALLS; SHIRTS; SWEATERS (U.S. CLS. 22 AND 39).
FIRST USE 7-19-1999; IN COMMERCE 7-19-1999.

SN 78-855,752. SAFE SKIES LLC, BROOKLYN, NY. FILED 4-6-2006.

CLASS 41—EDUCATION AND ENTERTAINMENT

FOR HORSE SHOWING; HORSE TRAINING (U.S. CLS. 100, 101 AND 107).
FIRST USE 7-19-1999; IN COMMERCE 7-19-1999.

CLASS 44—MEDICAL, BEAUTY AND AGRICULTURAL SERVICES

FOR HORSE BREEDING AND STUD SERVICES (U.S. CLS. 100 AND 101).
FIRST USE 7-19-1999; IN COMMERCE 7-19-2000.
ANDREA SAUNDERS, EXAMINING ATTORNEY



OWNER OF U.S. REG. NO. 3,071,548.
THE COLOR(S) RED AND WHITE IS/ARE CLAIMED AS A FEATURE OF THE MARK.
THE SHAPE OF THE TORCH HANDLE IS PRIMARILY WHITE WITH RED SHADING. THE FLAME PORTION CONSISTS OF A CENTRAL FLAME IN SOLID WHITE WITH RED SHADING ON EITHER SIDE. THE OUTER BORDER OF THE ENTIRE MARK IS IN SOLID RED.

CLASS 6—METAL GOODS

FOR METAL LOCKS (U.S. CLS. 2, 12, 13, 14, 23, 25 AND 50).
FIRST USE 10-5-2005; IN COMMERCE 10-5-2005.

SN 78-855,645. JOHNSON & JOHNSON, NEW BRUNSWICK, NJ. FILED 4-6-2006.

CLASS 20—FURNITURE AND ARTICLES NOT OTHERWISE CLASSIFIED

FOR NON-METAL LOCKS (U.S. CLS. 2, 13, 22, 25, 32 AND 50).
FIRST USE 10-5-2005; IN COMMERCE 10-5-2005.
STEVEN PEREZ, EXAMINING ATTORNEY

ICY COOL

SN 78-856,067. TURNBULL, ATIIM, NEW YORK, NY. FILED 4-6-2006.

THE MARK CONSISTS OF STANDARD CHARACTERS WITHOUT CLAIM TO ANY PARTICULAR FONT, STYLE, SIZE, OR COLOR.

CLASS 5—PHARMACEUTICALS

FOR ANTI-CAVITY MOUTH RINSE (U.S. CLS. 6, 18, 44, 46, 51 AND 52).

CLASS 21—HOUSEWARES AND GLASS

FOR DENTAL FLOSS (U.S. CLS. 2, 13, 23, 29, 30, 33, 40 AND 50).
JOHN DWYER, EXAMINING ATTORNEY



THE MARK CONSISTS OF THE WORDS CHOCOLATE CAKE WITH A CROWN ABOVE AND A CHESS BOARD BELOW SURROUNDED BY TWO CIRCLES WITH DOTS BETWEEN THE CIRCLES.

CLASS 25—CLOTHING

FOR BATHING SUITS FOR MEN; BELTS; CAPS; COATS FOR MEN AND WOMEN; DRESS SHIRTS; FOOTWEAR FOR MEN; FOOTWEAR FOR MEN AND WOMEN; GOLF SHIRTS; JERSEYS; KNIT SHIRTS; MEN AND WOMEN JACKETS, COATS, TROUSERS, VESTS; OPEN-NECKED SHIRTS; PIQUET SHIRTS; POLO SHIRTS; SHIRT FRONTS; SHIRTS; SHIRTS FOR SUITS; SHORT-SLEEVED OR LONG-SLEEVED T-SHIRTS; SHORT-SLEEVED SHIRTS; SLEEP SHIRTS; SPORT SHIRTS; SPORTS SHIRTS; SPORTS SHIRTS WITH SHORT SLEEVES; SWEAT SHIRTS; T-SHIRTS; WIND SHIRTS (U.S. CLS. 22 AND 39).

SN 78-856,195. 9013-0501 QUEBEC INC., LONGUEUIL, QUEBEC, CANADA, FILED 4-6-2006.

LOLË

CLASS 41—EDUCATION AND ENTERTAINMENT

FOR CONDUCTING ENTERTAINMENT EXHIBITIONS IN THE NATURE OF ART EXHIBITS, DANCE AND MUSIC SHOWS AND FASHION SHOWS; ENTERTAINMENT IN THE NATURE OF FASHION SHOWS; ENTERTAINMENT IN THE NATURE OF LIVE PERFORMANCES BY VARIOUS MUSIC, DANCE, LITERARY GROUPS; ENTERTAINMENT IN THE NATURE OF VISUAL AND AUDIO PERFORMANCES, AND MUSICAL, VARIETY, NEWS AND COMEDY SHOWS; ENTERTAINMENT IN THE NATURE OF VISUAL AND AUDIO PERFORMANCES, NAMELY, MUSICAL BAND, ROCK GROUP, GYMNASTIC, DANCE, AND BALLET PERFORMANCES; ENTERTAINMENT SERVICES, NAMELY, CONDUCTING PARTIES; ORGANIZING EXHIBITIONS FOR ART EXHIBITS, MEDIA EVENTS FOR ENTERTAINMENT PURPOSES, AND FASHION SHOWS (U.S. CLS. 100, 101 AND 107).

THE MARK CONSISTS OF STANDARD CHARACTERS WITHOUT CLAIM TO ANY PARTICULAR FONT, STYLE, SIZE, OR COLOR.

OWNER OF CANADA REG. NO. 610336, DATED 5-14-2004, EXPIRES 5-14-2019.

OWNER OF U.S. REG. NO. 3,058,662.

DAVID ELTON, EXAMINING ATTORNEY

CLASS 18—LEATHER GOODS

FOR BAGS, NAMELY TOTE BAGS, ALL PURPOSE SPORT BAGS, RUCKSACKS AND HANDBAGS (U.S. CLS. 1, 2, 3, 22 AND 41).

CLASS 25—CLOTHING

FOR CLOTHING AND ACCESSORIES FOR WOMEN, NAMELY TOPS, SWEATERS, T-SHIRTS, PANTS, SHIRTS, SKIRTS, VESTS, DRESSES, SHORTS, BLOUSES, COATS, SUITS, BLANKET COATS, JACKETS, BATHING SUITS, PAREOS, SOCKS, LEGGINGS, PYJAMAS, NIGHTGOWNS, BELTS, HATS, TOQUES, CAPS, SCARVES, HEADBANDS, TUBES, GLOVES AND MITTENS, THERMAL UNDERWEAR, UNDERWEAR (U.S. CLS. 22 AND 39).

ELLEN BURNS, EXAMINING ATTORNEY

SN 78-856,074. GLACIER CANYON LODGE, LLC, WISCONSIN DELLS, WI. FILED 4-6-2006.

SN 78-856,837. DESSA LEA, LLC, PHILADELPHIA, PA. FILED 4-7-2006.

GLACIER CANYON LODGE

BUCKETTE

THE MARK CONSISTS OF STANDARD CHARACTERS WITHOUT CLAIM TO ANY PARTICULAR FONT, STYLE, SIZE, OR COLOR.

NO CLAIM IS MADE TO THE EXCLUSIVE RIGHT TO USE "LODGE", APART FROM THE MARK AS SHOWN.

THE MARK CONSISTS OF STANDARD CHARACTERS WITHOUT CLAIM TO ANY PARTICULAR FONT, STYLE, SIZE, OR COLOR.

CLASS 36—INSURANCE AND FINANCIAL

FOR REAL ESTATE SERVICES, NAMELY, RENTAL OF VACATION CONDOMINIUMS; REAL ESTATE TIME-SHARING (U.S. CLS. 100, 101 AND 102).

CLASS 18—LEATHER GOODS

FOR BELT BAGS (U.S. CLS. 1, 2, 3, 22 AND 41).

CLASS 43—HOTEL AND RESTAURANT SERVICES

FOR RESORT HOTELS; PROVIDING CONVENTION FACILITIES (U.S. CLS. 100 AND 101).

DAVID ELTON, EXAMINING ATTORNEY

CLASS 26—FANCY GOODS

FOR BELT BUCKLES OF NON-PRECIOUS METAL (U.S. CLS. 37, 39, 40, 42 AND 50).

ELISSA GARBER KON, EXAMINING ATTORNEY

SN 78-856,936. FIELDING LISA, PACIFIC PALISADES, CA.
FILED 4-7-2006.

SN 78-857,180. PEABODY MANAGEMENT, INC., MEMPHIS,
TN. FILED 4-8-2006.



THE MARK CONSISTS OF THREE FLOWERS ARRANGED SIDE BY SIDE IN A HORIZONTAL POSITION WITH EACH OF THE THREE FLOWERS SEPARATELY FRAMED IN A SQUARE.

CLASS 35—ADVERTISING AND BUSINESS

FOR RETAIL SERVICES, NAMELY, RETAIL GROCERY STORES AND DELICATESSENS FEATURING PHONE-IN AND ON-LINE ORDERING; RETAIL STORE SERVICES FEATURING COOKWARE AND KITCHENWARE; RETAIL SHOPS FEATURING A CHARCUTERIE, PREPARED MEALS, CHEESES, MEATS, BAKED GOODS, COFFEE, ESPRESSO, CHOCOLATE, CONFECTIONS, GIFTS, APRONS AND KITCHEN TOWELS (U.S. CLS. 100, 101 AND 102).

CLASS 43—HOTEL AND RESTAURANT SERVICES

FOR RESTAURANTS, CARRY-OUT RESTAURANTS, SELF-SERVICE RESTAURANTS (U.S. CLS. 100 AND 101).

DEIRDRE ROBERTSON, EXAMINING ATTORNEY

SN 78-857,002. INTERTREND LTD, CAUSEWAY BAY,
HONG KONG, FILED 4-7-2006.

A PURE BREED

THE MARK CONSISTS OF STANDARD CHARACTERS WITHOUT CLAIM TO ANY PARTICULAR FONT, STYLE, SIZE, OR COLOR.

CLASS 12—VEHICLES

FOR BICYCLE BELLS; BICYCLE FRAMES; BICYCLE HANDLEBAR GRIPS; BICYCLE HORNS; BICYCLE PUMPS; BICYCLE SADDLE COVERS; BICYCLE SADDLES; BICYCLE WATER BOTTLE CAGES; BICYCLE WHEELS; BICYCLES; FRAMES FOR BICYCLES; HANDLEBARS ; MOUNTAIN BICYCLES; RACING BICYCLES; RIMS FOR BICYCLE WHEELS; ROAD RACING BICYCLES; TOURING BICYCLES; WATER BOTTLE HOLDERS FOR BICYCLES (U.S. CLS. 19, 21, 23, 31, 35 AND 44).

CLASS 25—CLOTHING

FOR ATHLETIC FOOTWEAR; BICYCLE GLOVES; COATS; CYCLISTS' JERSEYS; FOOTWEAR; JACKETS; JERSEYS ; OVERALLS; RAIN COATS; RAIN JACKETS; RAIN TROUSERS; SHIRTS; SHORT-SLEEVED OR LONG-SLEEVED T-SHIRTS; SHORTS; SOCKS; SPORTS JERSEYS; SPORTS SHIRTS; SWEAT SHIRTS; SWEATERS; TROUSERS; VESTS; WATERPROOF JACKETS AND PANTS; WIND VESTS; WIND-JACKETS (U.S. CLS. 22 AND 39).

JANICE KIM, EXAMINING ATTORNEY

THE PEABODY GALLERIA

THE MARK CONSISTS OF STANDARD CHARACTERS WITHOUT CLAIM TO ANY PARTICULAR FONT, STYLE, SIZE, OR COLOR.

OWNER OF U.S. REG. NOS. 2,569,232, 2,603,576 AND OTHERS.

SEC. 2(F) AS TO THE PEABODY.

CLASS 16—PAPER GOODS AND PRINTED MATTER

FOR CATALOGS FEATURING SLEEPWEAR, SLEEP PRODUCTS, LINENS, BATHING PRODUCTS, CLOTHING, CRYSTAL FIGURES, CERAMIC FIGURINES, KITCHENWARE AND BOOKS (U.S. CLS. 2, 5, 22, 23, 29, 37, 38 AND 50).

FIRST USE 11-1-2005; IN COMMERCE 11-1-2005.

CLASS 35—ADVERTISING AND BUSINESS

FOR CATALOG ORDERING SERVICES AND ELECTRONIC CATALOG SERVICES FEATURING SLEEPWEAR, SLEEP PRODUCTS, LINENS, BATHING PRODUCTS, CLOTHING, CRYSTAL FIGURES, CERAMIC FIGURINES, KITCHENWARE AND BOOKS (U.S. CLS. 100, 101 AND 102).

FIRST USE 12-28-2005; IN COMMERCE 12-28-2005.

DAYNA BROWNE, EXAMINING ATTORNEY

SN 78-857,304. TOBIAS, ANDREW J., PACIFIC PALISADES,
CA. FILED 4-9-2006.

Tobi

THE MARK CONSISTS OF STANDARD CHARACTERS WITHOUT CLAIM TO ANY PARTICULAR FONT, STYLE, SIZE, OR COLOR.

CLASS 7—MACHINERY

FOR HOUSE WARE APPLIANCES, NAMELY, STEAM CLEANING MACHINES (U.S. CLS. 13, 19, 21, 23, 31, 34 AND 35).

CLASS 9—ELECTRICAL AND SCIENTIFIC APPARATUS

FOR HOUSE WARE APPLIANCES, NAMELY, GARMENT STEAMERS (U.S. CLS. 21, 23, 26, 36 AND 38).

DAYNA BROWNE, EXAMINING ATTORNEY

SN 78-857,576. OLD MOTHER HUBBARD, INC., CHELMSFORD, MA. FILED 4-10-2006.

SN 78-857,627. OLD MOTHER HUBBARD, INC., CHELMSFORD, MA. FILED 4-10-2006.

LIVE WELL. TREAT WELL. BE WELL.

WELLBITES

THE MARK CONSISTS OF STANDARD CHARACTERS WITHOUT CLAIM TO ANY PARTICULAR FONT, STYLE, SIZE, OR COLOR.

OWNER OF U.S. REG. NOS. 2,955,422, 2,967,998 AND OTHERS.

THE MARK CONSISTS OF STANDARD CHARACTERS WITHOUT CLAIM TO ANY PARTICULAR FONT, STYLE, SIZE, OR COLOR.

CLASS 5—PHARMACEUTICALS

FOR VITAMINS FOR PETS; DIETARY SUPPLEMENTS FOR PETS; NUTRACEUTICALS FOR USE AS DIETARY SUPPLEMENTS FOR PETS (U.S. CLS. 6, 18, 44, 46, 51 AND 52).

CLASS 31—NATURAL AGRICULTURAL PRODUCTS

FOR PET FOOD AND PET TREATS (U.S. CLS. 1 AND 46).
ATTIYA MALIK, EXAMINING ATTORNEY

CLASS 5—PHARMACEUTICALS

FOR VITAMINS FOR PETS; DIETARY SUPPLEMENTS FOR PETS; NUTRACEUTICALS FOR USE AS DIETARY SUPPLEMENTS FOR PETS (U.S. CLS. 6, 18, 44, 46, 51 AND 52).

CLASS 31—NATURAL AGRICULTURAL PRODUCTS

FOR PET FOOD AND PET TREATS (U.S. CLS. 1 AND 46).
ATTIYA MALIK, EXAMINING ATTORNEY

SN 78-857,689. GOUVEIA, SUSAN, M, GRASS VALLEY, CA. FILED 4-10-2006.

SN 78-857,589. OLD MOTHER HUBBARD, INC., CHELMSFORD, MA. FILED 4-10-2006.

PURE REWARDS



THE MARK CONSISTS OF STANDARD CHARACTERS WITHOUT CLAIM TO ANY PARTICULAR FONT, STYLE, SIZE, OR COLOR.

NO CLAIM IS MADE TO THE EXCLUSIVE RIGHT TO USE "BABYSITTING SOLUTIONS", APART FROM THE MARK AS SHOWN.

CLASS 5—PHARMACEUTICALS

FOR VITAMINS FOR PETS; DIETARY SUPPLEMENTS FOR PETS; NUTRACEUTICALS FOR USE AS DIETARY SUPPLEMENTS FOR PETS (U.S. CLS. 6, 18, 44, 46, 51 AND 52).

THE MARK CONSISTS OF A DAFFODIL FLOWER NEXT TO THE WORDING "BABYSITTING SOLUTIONS," WHICH SUBSTITUTES SWIRLS FOR THE DOTS OVER THE "I'S" IN THE WORD "BABYSITTING SOLUTIONS"; THE WORD "BABYSITTING" SITS ABOVE THE WORD "SOLUTIONS" AND THE "Y" IN THE MARK "BABYSITTING" ALSO ACTS AS THE "L" IN SOLUTIONS.

CLASS 31—NATURAL AGRICULTURAL PRODUCTS

FOR PET FOOD AND PET TREATS (U.S. CLS. 1 AND 46).
ATTIYA MALIK, EXAMINING ATTORNEY

CLASS 38—COMMUNICATION

FOR ONLINE WEB-BASED DOCUMENT DELIVERY RESOURCE OF FORMS AND DOCUMENTS FOR BABYSITTERS AND GUARDIANS (U.S. CLS. 100, 101 AND 104).

CLASS 43—HOTEL AND RESTAURANT SERVICES

FOR PROVIDING AN ONLINE WEB-BASED COMPUTER DATABASE IN THE FIELD OF CHILDCARE, NAMELY A LISTING OF BABYSITTERS FOR GUARDIANS AND BABYSITTERS (U.S. CLS. 100 AND 101).
NAKIA HENRY, EXAMINING ATTORNEY

SN 78-857,817. GROUPGO, LLC, WALTHAM, MA. FILED 4-10-2006.

SN 78-857,696. MONSOD, PETER, WEST COVINA, CA. FILED 4-10-2006.

Broken Rhythm

THE MARK CONSISTS OF STANDARD CHARACTERS WITHOUT CLAIM TO ANY PARTICULAR FONT, STYLE, SIZE, OR COLOR.

CLASS 35—ADVERTISING AND BUSINESS

FOR ONLINE RETAIL STORE SERVICE FEATURING T-SHIRTS, SHORTS, AND FITNESS/KICKBOXING RELATED CLOTHING; RETAIL STORE SERVICE FEATURING T-SHIRTS, SHORTS, AND FITNESS/KICKBOXING RELATED CLOTHING (U.S. CLS. 100, 101 AND 102).

CLASS 41—EDUCATION AND ENTERTAINMENT

FOR TRAINING IN THE FIELD OF FITNESS, KICKBOXING, AND MUAY THAI; TEACHING IN THE FIELD OF FITNESS, KICKBOXING, AND MUAY THAI; AND EDUCATION SERVICES, NAMELY, PROVIDING CLASSES IN FITNESS, KICKBOXING, AND MUAY THAI (U.S. CLS. 100, 101 AND 107).
LINDA E. BLOHM, EXAMINING ATTORNEY

SN 78-857,723. GOMEZ, LIZZETTE, OXNARD, CA. FILED 4-10-2006.

ITTEZ

THE MARK CONSISTS OF STANDARD CHARACTERS WITHOUT CLAIM TO ANY PARTICULAR FONT, STYLE, SIZE, OR COLOR.

CLASS 14—JEWELRY

FOR BRACELETS AND NECKLACES (U.S. CLS. 2, 27, 28 AND 50).

CLASS 18—LEATHER GOODS

FOR TOTE BAGS (U.S. CLS. 1, 2, 3, 22 AND 41).

CLASS 25—CLOTHING

FOR T-SHIRTS, HOODED SWEATERS, UNDERWEAR, SOCKS, HATS (U.S. CLS. 22 AND 39).
ESTHER A. BORSUK, EXAMINING ATTORNEY

LET THE TRIP BEGIN

THE MARK CONSISTS OF STANDARD CHARACTERS WITHOUT CLAIM TO ANY PARTICULAR FONT, STYLE, SIZE, OR COLOR.

CLASS 38—COMMUNICATION

FOR COMPUTER SERVICES NAMELY PROVIDING MULTIPLE USER ACCESS TO COMPUTER NETWORKS AND BULLETIN BOARDS FOR THE TRANSFER AND DISSEMINATION OF A WIDE RANGE OF INFORMATION; PROVIDING ON-LINE ELECTRONIC BULLETIN BOARDS FOR TRANSMISSION OF MESSAGES AMONG COMPUTER USERS CONCERNING TRAVEL; PROVIDING ON-LINE CHAT ROOMS FOR TRANSMISSION OF MESSAGES AMONG COMPUTER USERS CONCERNING TRAVEL (U.S. CLS. 100, 101 AND 104).

CLASS 39—TRANSPORTATION AND STORAGE

FOR PROVIDING INFORMATION AND ADVICE REGARDING TRAVEL INFORMATION VIA THE INTERNET AND E-MAIL; PROVIDING A WIDE RANGE OF GENERAL INTEREST INFORMATION IN THE FIELD OF TRAVEL VIA COMPUTER NETWORKS (U.S. CLS. 100 AND 105).
GISELLE AGOSTO, EXAMINING ATTORNEY

SN 78-857,970. SHOOMINE, LLC, BOSTON, MA. FILED 4-10-2006.

SHOOMINE

THE MARK CONSISTS OF STANDARD CHARACTERS WITHOUT CLAIM TO ANY PARTICULAR FONT, STYLE, SIZE, OR COLOR.

CLASS 35—ADVERTISING AND BUSINESS

FOR RETAIL FURNITURE STORES (U.S. CLS. 100, 101 AND 102).
FIRST USE 6-0-1999; IN COMMERCE 6-0-1999.

CLASS 42—SCIENTIFIC, COMPUTER AND LEGAL SERVICES

FOR INTERIOR DECORATING (U.S. CLS. 100 AND 101).
FIRST USE 6-0-1999; IN COMMERCE 6-0-1999.
MICHAEL KAZAZIAN, EXAMINING ATTORNEY

SN 78-858,713. MONSOD, PETER, WEST COVINA, CA.
FILED 4-11-2006.



THE MARK CONSISTS OF DIGITAL IMAGE OF A MAN DOING A KICKBOX MOVE.

CLASS 35—ADVERTISING AND BUSINESS

FOR ON-LINE RETAIL STORE SERVICES FEATURING T-SHIRTS, SHORTS, AND FITNESS/KICKBOXING RELATED CLOTHING; RETAIL STORES FEATURING T-SHIRTS, SHORTS, AND FITNESS/KICKBOXING RELATED CLOTHING (U.S. CLS. 100, 101 AND 102).

FIRST USE 11-1-2005; IN COMMERCE 11-1-2005.

CLASS 41—EDUCATION AND ENTERTAINMENT

FOR EDUCATIONAL SERVICES NAMELY CONDUCTING PROGRAMS IN THE FIELD OF FITNESS, KICKBOXING, AND MUAY THAI; TEACHING IN THE FIELD OF FITNESS, KICKBOXING, AND MUAY THAI; TRAINING SERVICES IN THE FIELD OF FITNESS, KICKBOXING, AND MUAY THAI (U.S. CLS. 100, 101 AND 107).

FIRST USE 11-1-2005; IN COMMERCE 11-1-2005.

LINDA E. BLOHM, EXAMINING ATTORNEY

SN 78-858,840. TISSUE SCIENCE LABORATORIES PLC, ALDERSHOT, HAMPSHIRE, UNITED KINGDOM, FILED 4-11-2006.

THE NATURAL STRUCTURE OF PERFORMANCE

THE MARK CONSISTS OF STANDARD CHARACTERS WITHOUT CLAIM TO ANY PARTICULAR FONT, STYLE, SIZE, OR COLOR.

CLASS 5—PHARMACEUTICALS

FOR MEDICAL PREPARATIONS FOR THE TREATMENT OF SOFT TISSUE DEFECTS; MEDICAL PREPARATIONS CONTAINING NATURAL COLLAGENOUS TISSUE MATERIALS FOR THE TREATMENT, RECONSTRUCTION, RECONTOURING AND REPAIR OF HUMAN TISSUE; MEDICAL AND SURGICAL IMPLANTS COMPRISING NATURAL COLLAGENOUS TISSUE; SURGICAL AND MEDICAL IMPLANTS IN INJECTABLE AND NON-INJECTABLE FORM PREPARED FROM NATURAL COLLAGENOUS-CONTAINING TISSUES (U.S. CLS. 6, 18, 44, 46, 51 AND 52).

CLASS 10—MEDICAL APPARATUS

FOR SURGICAL AND MEDICAL IMPLANTS COMPRISING ARTIFICIAL MATERIALS FOR USE IN GENERAL, PLASTIC AND RECONSTRUCTIVE, UROLOGICAL, GYNECOLOGICAL, ORTHOPAEDIC, GASTRO-ESOPHAGEAL, ANAL, COLORECTAL AND ABDOMINAL SURGERY (U.S. CLS. 26, 39 AND 44).

PAUL E. FAHRENKOPF, EXAMINING ATTORNEY

SN 78-858,863. WIN PRACTICE PERFORMANCE, LLC, ORLAND PARK, IL. FILED 4-11-2006.

WIN PRACTICE PERFORMANCE

THE MARK CONSISTS OF STANDARD CHARACTERS WITHOUT CLAIM TO ANY PARTICULAR FONT, STYLE, SIZE, OR COLOR.

NO CLAIM IS MADE TO THE EXCLUSIVE RIGHT TO USE "PRACTICE PERFORMANCE", APART FROM THE MARK AS SHOWN.

CLASS 35—ADVERTISING AND BUSINESS

FOR BUSINESS CONSULTATION IN THE FIELD OF DENTAL PRACTICE OPERATION AND MANAGEMENT (U.S. CLS. 100, 101 AND 102).

CLASS 41—EDUCATION AND ENTERTAINMENT

FOR CONDUCTING WORKSHOPS AND SEMINARS IN THE FIELD OF DENTAL PRACTICE MANAGEMENT AND OPERATION AND DISTRIBUTION OF COURSE MATERIALS IN CONNECTION THEREWITH (U.S. CLS. 100, 101 AND 107).

SANDRA MANIOS, EXAMINING ATTORNEY

SN 78-858,893. GLOBAL ORGANICS, LLC, GOODYEAR, AZ. FILED 4-11-2006.



OWNER OF U.S. REG. NO. 2,682,104.

NO CLAIM IS MADE TO THE EXCLUSIVE RIGHT TO USE "GLOBAL ORGANICS, LLC" AND "#1", APART FROM THE MARK AS SHOWN.

THE COLOR(S) LIGHT GREEN, DARK GREEN, LIGHT PURPLE, DARK PURPLE, WHITE IS/ARE CLAIMED AS A FEATURE OF THE MARK.

THE MARK CONSISTS OF LETTERS GO, WITH G BEING DARK PURPLE SURROUNDING A GLOBE IN LIGHT PURPLE WITH LATITUDE AND LONGITUDE LINES IN WHITE, O BEING DARK GREEN, SURROUNDING A LIGHT GREEN GLOBE WITH LATITUDE AND LONGITUDE LINES IN WHITE, THE WORDS "GLOBAL", IN

DARK PURPLE, AND "ORGANICS LLC", IN DARK GREEN WITH LLC IN SUPERScript POSITION FOLLOWING THE GO. A FLAG POSITIONED ABOVE THE "GLOBAL ORGANICS, LLC" WORDS WITH A DARK PURPLE STAFF, THE NUMBERS "#1" IN WHITE ON FLAG, FOUR HORIZONTAL BARS CROSSING THE FLAG COLORED, FROM TOP TO BOTTOM, LIGHT GREEN, DARK GREEN, LIGHT PURPLE, DARK PURPLE, AND THE WORDS "THE WAY THE WORLD IS GOING." IN DARK PURPLE UNDERNEATH THE "GLOBAL ORGANICS, LLC" WORDING.

CLASS 1—CHEMICALS

FOR CHEMICAL ADDITIVES FOR USE IN THE MANUFACTURE OF COSMETICS, NUTRITIONAL SUPPLEMENTS AND PHARMACEUTICALS (U.S. CLS. 1, 5, 6, 10, 26 AND 46).

CLASS 3—COSMETICS AND CLEANING PREPARATIONS

FOR COSMETICS (U.S. CLS. 1, 4, 6, 50, 51 AND 52).

CLASS 5—PHARMACEUTICALS

FOR NUTRACEUTICALS FOR USE AS A DIETARY SUPPLEMENT; NUTRITIONAL SUPPLEMENTS (U.S. CLS. 6, 18, 44, 46, 51 AND 52).

DARRYL SPRUILL, EXAMINING ATTORNEY

SN 78-858,916. WIN PRACTICE PERFORMANCE, LLC, ORLAND PARK, IL. FILED 4-11-2006.



NO CLAIM IS MADE TO THE EXCLUSIVE RIGHT TO USE "PRACTICE PERFORMANCE", APART FROM THE MARK AS SHOWN.

THE MARK CONSISTS OF A STYLIZED GRAPHIC REPRESENTATION OF A HUMAN FIGURE WITH THE WORDS WIN PRACTICE PERFORMANCE PLACED TO THE RIGHT OF THE FIGURE.

CLASS 35—ADVERTISING AND BUSINESS

FOR BUSINESS CONSULTATION IN THE FIELD OF DENTAL PRACTICE OPERATION AND MANAGEMENT (U.S. CLS. 100, 101 AND 102).

CLASS 41—EDUCATION AND ENTERTAINMENT

FOR CONDUCTING WORKSHOPS AND SEMINARS IN THE FIELD OF DENTAL PRACTICE MANAGEMENT AND OPERATION AND DISTRIBUTION OF COURSE MATERIALS IN CONNECTION THEREWITH (U.S. CLS. 100, 101 AND 107).

SANDRA MANIOS, EXAMINING ATTORNEY

SN 78-859,274. DVC HEALTHCARE HOLDINGS, INC., YARDLEY, PA. FILED 4-11-2006.

SCIFLUENT COMMUNICATIONS

THE MARK CONSISTS OF STANDARD CHARACTERS WITHOUT CLAIM TO ANY PARTICULAR FONT, STYLE, SIZE, OR COLOR.

NO CLAIM IS MADE TO THE EXCLUSIVE RIGHT TO USE "COMMUNICATIONS", APART FROM THE MARK AS SHOWN.

CLASS 35—ADVERTISING AND BUSINESS

FOR BUSINESS MARKETING SERVICES; CONSULTANCY SERVICES REGARDING BUSINESS STRATEGIES; PREPARING PROMOTIONAL AND MERCHANDISING MATERIAL FOR OTHERS; SERVICES WITH REGARD TO PRODUCT PRESENTATION TO THE PUBLIC; BUSINESS CONSULTATION AND MANAGEMENT REGARDING MARKETING ACTIVITIES AND LAUNCHING NEW PRODUCTS; BRAND DEVELOPMENT IN THE HEALTH CARE FIELD (U.S. CLS. 100, 101 AND 102).

CLASS 42—SCIENTIFIC, COMPUTER AND LEGAL SERVICES

FOR TECHNICAL WRITING FOR OTHERS (U.S. CLS. 100 AND 101).

TINA BROWN, EXAMINING ATTORNEY

SN 78-859,367. CYRES INC., TORONTO, ONTARIO, CANADA, FILED 4-11-2006.



THE DESIGN PORTION OF THE MARK CONSISTS OF A MISCELLANEOUS DESIGN INCORPORATING THE LETTER "C".

CLASS 25—CLOTHING

FOR SKI AND SNOWBOARD SHOES AND PARTS THEREOF; SNOWBOARD BOOTS; SNOWBOARD GLOVES; SNOWBOARD PANTS; PANTS; SHORTS; T-SHIRTS; SHIRTS; SWEATERS; JACKETS; BELTS; SNEAKERS; BASEBALL CAPS (U.S. CLS. 22 AND 39).

CLASS 28—TOYS AND SPORTING GOODS

FOR BINDINGS FOR SNOWBOARDS; SNOWBOARD DECKS; SNOWBOARD MINIATURE TOY HELMETS; BAGS FOR SKATEBOARDS; BALL BEARINGS FOR SKATEBOARDS; NUTS AND BOLTS FOR SKATEBOARDS; SKATEBOARD DECKS; SKATEBOARD GRIP TAPES; SKATEBOARD RAILS; SKATEBOARD RISER PADS; SKATEBOARD TRUCKS; SKATEBOARD WHEELS SOLD SEPARATELY OR SOLD AS A UNIT WITH SKATEBOARDS; SKATEBOARDS; WAKEBOARD LUBRICANT; WAKEBOARDS; SURFBOARDS; SURFBOARD WAX; SURFBOARD LEASHES; SURFBOARD FINS; BAGS ESPECIALLY DESIGNED FOR SURFBOARDS (U.S. CLS. 22, 23, 38 AND 50).

EVELYN BRADLEY, EXAMINING ATTORNEY

SN 78-859,681. I.C.E.D. MANAGEMENT, INC., WILMINGTON, NY. FILED 4-12-2006.



SN 78-859,463. GOOD CALI TRADING, SAN JOSE, CA. AND EVERSHING TRADING COMPANY, SAN JOSE, CA. FILED 4-12-2006.

OWNER OF U.S. REG. NOS. 963,828, 1,249,263 AND 1,672,738.

THE MARK CONSISTS OF A FANCIFUL DESIGN OF A HUMAN FORM IN STRIDE WITH AN OUTSTRETCHED ARM HOLDING A DOCUMENT.

CLASS 35—ADVERTISING AND BUSINESS

FOR COPYING OF DOCUMENTS FOR OTHERS (U.S. CLS. 100, 101 AND 102).

FIRST USE 12-31-2005; IN COMMERCE 12-31-2005.

CLASS 40—MATERIAL TREATMENT

FOR BINDERY SERVICES FOR OTHERS, NAMELY, COLLATING, FOLDING, STAPLING, PERFORATING, CUTTING AND BINDING OF PRINTED, PHOTOCOPIED AND TYPEWRITTEN MATERIALS; DIGITAL ON-DEMAND PRINTING SERVICES OF BOOKS AND OTHER DOCUMENTS (U.S. CLS. 100, 103 AND 106).

FIRST USE 12-31-2005; IN COMMERCE 12-31-2005.

PAUL E. FAHRENKOPF, EXAMINING ATTORNEY



THE COLOR GREEN IS CLAIMED AS A FEATURE OF THE MARK.

THE MARK CONSISTS OF A GREEN DRAWING OF COCONUT TREE WITH COCONUTS ON THE TREE.

CLASS 16—PAPER GOODS AND PRINTED MATTER

FOR RICE PAPER (U.S. CLS. 2, 5, 22, 23, 29, 37, 38 AND 50).

FIRST USE 5-29-1992; IN COMMERCE 5-29-1995.

CLASS 29—MEATS AND PROCESSED FOODS

FOR FROZEN VEGETABLES (U.S. CL. 46).

FIRST USE 5-29-1992; IN COMMERCE 5-29-1995.

CLASS 30—STAPLE FOODS

FOR CHILI SAUCE; CHINESE RICE NOODLES BIFUN, UNCOOKED; COOKIES; FISH SAUCE; FROZEN CONFECTIONS; HOT SAUCE; PEPPER; PEPPER POWDER; RICE; RICE NOODLES; SAUCES; SOY SAUCE; SOY SAUCE; SPICES (U.S. CL. 46).

FIRST USE 5-29-1992; IN COMMERCE 5-29-1995.

KEVON CHISOLM, EXAMINING ATTORNEY

SN 78-859,754. AMERICAN SEAL AND ENGINEERING COMPANY, INC., ORANGE, CT. FILED 4-12-2006.

AMERISEAL

THE MARK CONSISTS OF STANDARD CHARACTERS WITHOUT CLAIM TO ANY PARTICULAR FONT, STYLE, SIZE, OR COLOR.

CLASS 6—METAL GOODS

FOR METAL SEALS (U.S. CLS. 2, 12, 13, 14, 23, 25 AND 50).

CLASS 17—RUBBER GOODS

FOR NON-METAL SEALS FOR OEM AND AFTER-MARKET MACHINERY AND INDUSTRIAL EQUIPMENT (U.S. CLS. 1, 5, 12, 13, 35 AND 50).

SALLY SHIH, EXAMINING ATTORNEY

SN 78-860,112. HBC DISTRIBUTION INCORPORATED,
OAKLAND, CA. FILED 4-12-2006.

SN 78-860,296. WHEELER, GARY, SANDY SPRINGS, GA.
FILED 4-12-2006.

AGE ESCAPE

THE MARK CONSISTS OF STANDARD CHARACTERS
WITHOUT CLAIM TO ANY PARTICULAR FONT, STYLE,
SIZE, OR COLOR.

CLASS 3—COSMETICS AND CLEANING PREPARATIONS

FOR SKIN CARE AND BEAUTY CARE PREPARATIONS,
NAMESLY TOPICAL SKIN CREAMS, LOTIONS
AND SERUMS (U.S. CLS. 1, 4, 6, 50, 51 AND 52).

CLASS 5—PHARMACEUTICALS

FOR ALLOPATHIC AND HOMEOPATHIC PHARMA-
CEUTICALS FOR USE IN THE TREATMENT AND
PREVENTION OF SKIN DAMAGE, NAMESLY NON-
PRESCRIPTION PREPARATIONS TO TREAT WRIN-
KLES, ROUGHNESS, DRYNESS, FLAKINESS, SENSI-
TIVITY, SPOTS, BLOTCHES AND BLEMISHES (U.S.
CLS. 6, 18, 44, 46, 51 AND 52).

STEVEN PEREZ, EXAMINING ATTORNEY

SN 78-860,159. COLORADO DISTRIBUTION CONSULTING,
LLC, LAKEWOOD, CO. FILED 4-12-2006.

Petey's Bing

THE MARK CONSISTS OF STANDARD CHARACTERS
WITHOUT CLAIM TO ANY PARTICULAR FONT, STYLE,
SIZE, OR COLOR.

NO CLAIM IS MADE TO THE EXCLUSIVE RIGHT TO
USE "BING" AS TO CLASS 32 ONLY, APART FROM THE
MARK AS SHOWN.

CLASS 25—CLOTHING

FOR CAPS; JERSEYS; SHIFTS; TIES; TOPS (U.S. CLS.
22 AND 39).

CLASS 32—LIGHT BEVERAGES

FOR ENERGY DRINKS; FRUIT DRINKS (U.S. CLS. 45,
46 AND 48).

CAROLYN CATALDO, EXAMINING ATTORNEY

GAHRP

THE MARK CONSISTS OF STANDARD CHARACTERS
WITHOUT CLAIM TO ANY PARTICULAR FONT, STYLE,
SIZE, OR COLOR.

CLASS 16—PAPER GOODS AND PRINTED MATTER

FOR HANDBOOKS DETAILING A SET OF GUIDING
PRINCIPLES FOR SOUND HUMAN RESOURCE PRACTICES
WITHIN AN BUSINESS OR ANY OTHER TYPE
OF ORGANIZATION (U.S. CLS. 2, 5, 22, 23, 29, 37, 38
AND 50).

CLASS 35—ADVERTISING AND BUSINESS

FOR CONSULTING SERVICES IN THE FIELD OF
HUMAN RESOURCES FOR BUSINESS MANAGEMENT
AND BUSINESS ADMINISTRATION USING GUIDING
PRINCIPLES FOR SOUND HUMAN RESOURCE PRACTICES
(U.S. CLS. 100, 101 AND 102).

MARGERY A. TIERNEY, EXAMINING ATTORNEY

SN 78-860,307. NATIONAL TABLETOP AND GIFTWARE
ASSOCIATION, ROSEMONT, IL. FILED 4-12-2006.

NTGA

THE MARK CONSISTS OF STANDARD CHARACTERS
WITHOUT CLAIM TO ANY PARTICULAR FONT, STYLE,
SIZE, OR COLOR.

CLASS 35—ADVERTISING AND BUSINESS

FOR ARRANGING AND CONDUCTING BUSINESS
CONFERENCES; ARRANGING AND CONDUCTING
TRADE SHOW EXHIBITIONS IN THE FIELD OF TA-
BLETOP AND GIFTWARE; ASSOCIATION SERVICES,
NAMESLY, PROMOTING THE INTERESTS OF THE
TABLETOP AND GIFTWARE INDUSTRY (U.S. CLS.
100, 101 AND 102).

FIRST USE 0-0-1979; IN COMMERCE 0-0-1979.

CLASS 41—EDUCATION AND ENTERTAINMENT

FOR ARRANGING AND CONDUCTING EDUCA-
TIONAL CONFERENCES; CONDUCTING WORKSHOPS
AND SEMINARS IN THE TABLETOP AND GIFTWARE
MARKET (U.S. CLS. 100, 101 AND 107).

FIRST USE 0-0-1979; IN COMMERCE 0-0-1979.

LANA PHAM, EXAMINING ATTORNEY

SN 78-860,410. NAOMI JANZEN PRODUCTIONS, INC., LA CRESCENTA, CA. FILED 4-12-2006.

SN 78-860,534. TK2 PROJECTS, INC., LAS VEGAS, NV. FILED 4-12-2006.

WHATZIT4?

THE MARK CONSISTS OF STANDARD CHARACTERS WITHOUT CLAIM TO ANY PARTICULAR FONT, STYLE, SIZE, OR COLOR.

CLASS 9—ELECTRICAL AND SCIENTIFIC APPARATUS

FOR COMPUTER GAME SOFTWARE; VIDEO GAME PROGRAMS; VIDEO GAME SOFTWARE; INTERACTIVE MULTIMEDIA COMPUTER GAME PROGRAMS; VIDEO GAME INTERACTIVE HAND HELD REMOTE CONTROLS FOR PLAYING ELECTRONIC GAMES; ELECTRONIC GAME SOFTWARE FOR HANDHELD ELECTRONIC DEVICES; COMPUTER APPLICATION SOFTWARE FOR MOBILE PHONES; COMPUTER SOFTWARE FOR WIRELESS CONTENT DELIVERY; COMPUTER HARDWARE AND COMPUTER SOFTWARE PROGRAMS FOR THE INTEGRATION OF TEXT, AUDIO, GRAPHICS, STILL IMAGE AND MOVING PICTURES INTO AN INTERACTIVE DELIVERY FOR MULTIMEDIA APPLICATIONS; COMPUTER GAME EQUIPMENT, NAMELY, PRE-RECORDED DIGITAL VIDEO DISCS AND CD-ROMS FEATURING PARLOR GAME INSTRUCTIONS, CGI ANIMATION OF GAME OBJECTS, CGI ANIMATION OF GAME HOST CHARACTERS, STILL AND ANIMATED GRAPHICS OF GAME QUESTIONS, CLUE CATEGORIES, GAME ANSWERS AND GAME SCORING (U.S. CLS. 21, 23, 26, 36 AND 38).

CLASS 28—TOYS AND SPORTING GOODS

FOR EQUIPMENT SOLD AS A UNIT FOR PLAYING A PARLOR GAME, INCLUDING A DIE, RULES OF PLAY, TWO TYPES OF PLAYER TOKENS, A TOKEN COLLECTION VESSEL, PLAYER TOKEN RACKS, A PRE-RECORDED DIGITAL VIDEO DISK SUPPLYING PARLOUR GAME CONTENT, AND A UNIVERSAL REMOTE CONTROL (U.S. CLS. 22, 23, 38 AND 50).

CLASS 41—EDUCATION AND ENTERTAINMENT

FOR ENTERTAINMENT SERVICES, NAMELY, PRODUCTION AND DISTRIBUTION OF A GAME SHOW; ENTERTAINMENT SERVICES, NAMELY, PROVIDING AN ON-LINE COMPUTER GUESSING GAME; ENTERTAINMENT SERVICES, NAMELY, CONDUCTING ON-LINE GUESSING GAME CONTESTS; ENTERTAINMENT, NAMELY, PROVIDING A COMPUTER GAME THAT MAY BE ACCESSED NETWORK-WIDE BY NETWORK USERS (U.S. CLS. 100, 101 AND 107).

MARIA-VICTORIA SUAREZ, EXAMINING ATTORNEY



THE APPLICANT CLAIMS COLOR AS A FEATURE OF THE MARK, NAMELY, GREEN, BLUE, AND WHITE.

THE MARK CONSISTS OF STYLIZED FONT IN GREEN, SURROUNDED BY A EMBOSSED WHITE SEMI-CIRCLE, WITH A BLUE SPHERE TOUCHING THE Y ON THE FONT AND TOUCHING THE SEMI-CIRCLE.

CLASS 35—ADVERTISING AND BUSINESS

FOR PREPARING AUDIO-VISUAL DISPLAYS IN THE FIELD OF FASHION (U.S. CLS. 100, 101 AND 102).

CLASS 41—EDUCATION AND ENTERTAINMENT

FOR ENTERTAINMENT IN THE NATURE OF FASHION SHOWS; ORGANIZATION OF FASHION SHOWS; PRODUCTION OF DVD'S AND VIDEOS FEATURING FASHION SHOWS (U.S. CLS. 100, 101 AND 107).

CLASS 45—PERSONAL SERVICES

FOR FASHION INFORMATION; FASHION TREND CONSULTING FOR THE FASHION INDUSTRY; PROVIDING FASHION INFORMATION; PROVIDING INFORMATION ABOUT FASHION (U.S. CLS. 100 AND 101).

JOHN E. MICHOS, EXAMINING ATTORNEY

SN 78-860,791. CHOCOLATES4CHARITY LLC, CHICAGO, IL. FILED 4-13-2006.



NO CLAIM IS MADE TO THE EXCLUSIVE RIGHT TO USE "CHOCOLATES" AND "CHARITY", APART FROM THE MARK AS SHOWN.

THE MARK CONSISTS OF THE WORD CHOCOLATES ATOP THE NUMBER 4 POSITIONED WITHIN A STAR NEXT TO THE WORD CHARITY IN WHICH EACH LETTER OF CHARITY IS SUPERIMPOSED WITHIN A CIRCLE.

CLASS 30—STAPLE FOODS

FOR CANDY (U.S. CL. 46).

CLASS 36—INSURANCE AND FINANCIAL

FOR CHARITABLE FUND RAISING SERVICES (U.S. CLS. 100, 101 AND 102).
JANICE KIM, EXAMINING ATTORNEY

CLASS 11—ENVIRONMENTAL CONTROL APPARATUS

FOR HAIR DRYERS (U.S. CLS. 13, 21, 23, 31 AND 34).
HOWARD SMIGA, EXAMINING ATTORNEY

SN 78-860,811. WAID, KENTON ALAN, GENEVA, OH.
FILED 4-13-2006.

SN 78-861,145. GOALS FOR AMERICANS FOUNDATION,
ST. LOUIS, MO. FILED 4-13-2006.



NO CLAIM IS MADE TO THE EXCLUSIVE RIGHT TO USE "USA VETS", APART FROM THE MARK AS SHOWN.

CLASS 36—INSURANCE AND FINANCIAL

FOR CHARITABLE FUND RAISING, ACCEPTING AND ADMINISTERING MONETARY CHARITABLE CONTRIBUTIONS TO NEEDY VETERANS AND HOSPITALS (U.S. CLS. 100, 101 AND 102).
FIRST USE 5-27-1996; IN COMMERCE 5-27-1996.

CLASS 45—PERSONAL SERVICES

FOR CHARITABLE SERVICES, NAMELY, PROVIDING PERSONAL CARE ITEMS TO NEEDY VETERANS AND HOSPITALS (U.S. CLS. 100 AND 101).
FIRST USE 5-27-1996; IN COMMERCE 5-27-1996.
CORY BOONE, EXAMINING ATTORNEY

SN 78-860,847. MANA PRODUCTS, INC., LONG ISLAND CITY, NY. FILED 4-13-2006.

Pro Tools Direct

THE MARK CONSISTS OF STANDARD CHARACTERS WITHOUT CLAIM TO ANY PARTICULAR FONT, STYLE, SIZE, OR COLOR.
NO CLAIM IS MADE TO THE EXCLUSIVE RIGHT TO USE "PRO TOOLS", APART FROM THE MARK AS SHOWN.

CLASS 9—ELECTRICAL AND SCIENTIFIC APPARATUS

FOR ELECTRIC HAIR FLAT AND CURLING IRONS (U.S. CLS. 21, 23, 26, 36 AND 38).

CITIZEN PAUL

THE MARK CONSISTS OF STANDARD CHARACTERS WITHOUT CLAIM TO ANY PARTICULAR FONT, STYLE, SIZE, OR COLOR.

THE NAME(S), PORTRAIT(S), AND/OR SIGNATURE(S) SHOWN IN THE MARK DOES NOT IDENTIFY A PARTICULAR LIVING INDIVIDUAL.

CLASS 16—PAPER GOODS AND PRINTED MATTER

FOR PRINTED MATERIALS, NAMELY, BOOKLETS, PAMPHLETS, BROCHURES, MAGAZINES, AND BOOKS PUBLISHED PERIODICALLY ON MATTERS RELATING TO WORLD PEACE, NATIONAL SECURITY, EDUCATION, ECOLOGY, MILITARY AFFAIRS, HUMAN RIGHTS, HEALTH AND NUTRITION, COMMERCE, NATURE AND THE ENVIRONMENT, HUMAN SERVICES ECONOMICS AND BUSINESS, JUSTICE AND POLITICS (U.S. CLS. 2, 5, 22, 23, 29, 37, 38 AND 50).

CLASS 35—ADVERTISING AND BUSINESS

FOR PROMOTING PUBLIC AWARENESS FOR WORLD PEACE, NATIONAL SECURITY, EDUCATION, ECOLOGY, MILITARY AFFAIRS, HUMAN RIGHTS, HEALTH AND NUTRITION, COMMERCE, NATURE AND THE ENVIRONMENT, HUMAN SERVICES, ECONOMICS AND BUSINESS, JUSTICE AND POLITICS (U.S. CLS. 100, 101 AND 102).

ANGELA M. MICHELI, EXAMINING ATTORNEY

SN 78-861,265. VERDE REALTY OPERATING PARTNERSHIP, L.P., EL PASO, TX. FILED 4-13-2006.

SANTA TERESA

THE MARK CONSISTS OF THE WORDS SANTA TERESA WITH A LINE UNDER THE LETTER "A" IN SANTA.
THE TERM "SANTA" TRANSLATES INTO ENGLISH AS "SAINT".

CLASS 36—INSURANCE AND FINANCIAL

FOR REAL ESTATE MANAGEMENT SERVICES; REAL ESTATE INVESTMENT OF COMMERCIAL PROPERTIES; MORTGAGE BANKING AND MORTGAGE PROCUREMENT FOR OTHERS; CONSTRUCTION FINANCING FOR HOMEBUILDERS; INSURANCE UNDERWRITING FOR HOMEBUYERS IN THE FIELDS OF HOME AND AUTO INSURANCE; TITLE INSURANCE UNDERWRITING IN THE FIELD OF REAL ESTATE; FINANCIAL SERVICES, NAMELY, PROVIDING CONSTRUCTION LOAN FINANCING FOR HOMEBUILDERS (U.S. CLS. 100, 101 AND 102).

CLASS 37—CONSTRUCTION AND REPAIR

FOR LAND DEVELOPMENT SERVICES, NAMELY, PLANNING AND LAYING OUT OF RESIDENTIAL AND/OR COMMERCIAL COMMUNITIES, RETAIL, INDUSTRIAL AND DISTRIBUTION SPACE, AND APARTMENTS; COMMERCIAL REAL ESTATE PROPERTY DEVELOPMENT (U.S. CLS. 100, 103 AND 106).
PAUL F. GAST, EXAMINING ATTORNEY

SN 78-861,333. CARROLL, JAMES MICHAEL, MADISON, MS. FILED 4-13-2006.

N-A-HURRY

THE MARK CONSISTS OF STANDARD CHARACTERS WITHOUT CLAIM TO ANY PARTICULAR FONT, STYLE, SIZE, OR COLOR.

CLASS 36—INSURANCE AND FINANCIAL

FOR ELECTRONIC CREDIT CARD TRANSACTIONS (U.S. CLS. 100, 101 AND 102).

CLASS 43—HOTEL AND RESTAURANT SERVICES

FOR FAST FOOD AND NON-STOP RESTAURANT SERVICES (U.S. CLS. 100 AND 101).
MATTHEW MCDOWELL, EXAMINING ATTORNEY

SN 78-861,441. RESERVE BRANDS LLC, CHICAGO, IL. FILED 4-13-2006.

BURSTS

THE MARK CONSISTS OF STANDARD CHARACTERS WITHOUT CLAIM TO ANY PARTICULAR FONT, STYLE, SIZE, OR COLOR.

CLASS 29—MEATS AND PROCESSED FOODS

FOR BLANCHED NUTS; FRUIT AND SOY BASED SNACK FOOD; FRUIT-BASED SNACK FOOD; POTATO CHIPS; POTATO CRISPS; POTATO STICKS; POTATO-BASED SNACK FOODS; PROCESSED NUTS; ROASTED NUTS; SHELLED NUTS; SNACK MIX CONSISTING PRIMARILY OF PROCESSED FRUITS, PROCESSED NUTS AND/OR RAISINS; SOY-BASED SNACK FOODS; VEGETABLE-BASED SNACK FOODS (U.S. CL. 46).

CLASS 30—STAPLE FOODS

FOR CHEESE FLAVORED PUFFED CORN SNACKS; CHEESE FLAVORED SNACKS, NAMELY, CHEESE CURLS; CHEESE FLAVORED SNACKS, NAMELY, PUFFED CHEESE BALLS; CORN CHIPS; CORN CURLS; EXTRUDED CORN SNACKS; EXTRUDED WHEAT SNACKS; GRAIN-BASED CHIPS; MICROWAVE POPCORN; POPCORN; POPPED POPCORN; PROCESSED POPCORN; PUFFED CORN SNACKS; RICE-BASED SNACK FOODS; TORTILLA CHIPS; WHEAT-BASED SNACK FOODS (U.S. CL. 46).
ELIZABETH J. WINTER, EXAMINING ATTORNEY

SN 78-861,453. MEDICAL CONSULTANTS NETWORK INC., DENVER, CO. FILED 4-13-2006.

EDEPT

THE MARK CONSISTS OF STANDARD CHARACTERS WITHOUT CLAIM TO ANY PARTICULAR FONT, STYLE, SIZE, OR COLOR.

CLASS 41—EDUCATION AND ENTERTAINMENT

FOR EDUCATION, NAMELY PROVIDING INTERACTIVE ONLINE COURSES, CLASSES, PROGRAMS, SEMINARS, AND WORKSHOPS, AND DISTRIBUTING MATERIALS IN CONJUNCTION THEREWITH, IN THE FIELD OF HEALTH CARE; ONLINE TRAINING SERVICES IN THE NATURE OF COURSES, CLASSES, PROGRAMS, SEMINARS AND WORKSHOPS IN THE FIELD OF HEALTH CARE (U.S. CLS. 100, 101 AND 107).
FIRST USE 3-2-2006; IN COMMERCE 3-2-2006.

CLASS 42—SCIENTIFIC, COMPUTER AND LEGAL SERVICES

FOR PROVIDING ON-LINE NON-DOWNLOADABLE EDUCATION PLATFORM SOFTWARE FOR PROVIDING INTERACTIVE ONLINE COURSES AND FOR MANAGEMENT AND TRACKING OF ALL FORMS OF STAFF TRAINING IN THE FIELD OF HEALTH CARE (U.S. CLS. 100 AND 101).
FIRST USE 3-2-2006; IN COMMERCE 3-2-2006.
MATTHEW MCDOWELL, EXAMINING ATTORNEY

SN 78-861,526. RICHARDS, SUSAN M., OREGON, WI. FILED 4-14-2006.

SN 78-861,535. CHINA CARE FOUNDATION, INC., WESTPORT, CT. FILED 4-14-2006.

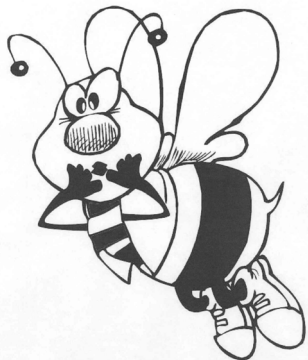

THE MARK CONSISTS OF A CARICATURE OF A BEE.

CLASS 25—CLOTHING

FOR HATS; SHIRTS (U.S. CLS. 22 AND 39).
FIRST USE 10-10-2004; IN COMMERCE 10-10-2004.

CLASS 30—STAPLE FOODS

FOR HONEY (U.S. CL. 46).
FIRST USE 10-10-2004; IN COMMERCE 10-10-2004.
JENNY PARK, EXAMINING ATTORNEY

SN 78-861,528. RICHARDS, SUSAN M., OREGON, WI. FILED 4-14-2006.

BEE BARF

THE MARK CONSISTS OF STANDARD CHARACTERS WITHOUT CLAIM TO ANY PARTICULAR FONT, STYLE, SIZE, OR COLOR.

CLASS 25—CLOTHING

FOR HATS; SHIRTS (U.S. CLS. 22 AND 39).
FIRST USE 10-10-2004; IN COMMERCE 10-10-2004.

CLASS 30—STAPLE FOODS

FOR HONEY (U.S. CL. 46).
FIRST USE 10-10-2004; IN COMMERCE 10-10-2004.
JENNY PARK, EXAMINING ATTORNEY

CHINA CARE

THE MARK CONSISTS OF STANDARD CHARACTERS WITHOUT CLAIM TO ANY PARTICULAR FONT, STYLE, SIZE, OR COLOR.

OWNER OF U.S. REG. NO. 3,035,744.

NO CLAIM IS MADE TO THE EXCLUSIVE RIGHT TO USE "CHINA", APART FROM THE MARK AS SHOWN.

CLASS 35—ADVERTISING AND BUSINESS

FOR PROMOTING PUBLIC AWARENESS OF THE NEED FOR AND BENEFITS OF CHILD ADOPTION FROM CHINA; PROMOTING PUBLIC AWARENESS OF THE NEED FOR AND BENEFITS OF HANDICAPPED CHILD ADOPTION; CHARITABLE SERVICES, NAMELY, ORGANIZING AND CONDUCTING VOLUNTEER PROGRAMS FOR THE BENEFIT OF CHINESE ORPHANAGES (U.S. CLS. 100, 101 AND 102).
FIRST USE 10-10-2000; IN COMMERCE 10-10-2000.

CLASS 36—INSURANCE AND FINANCIAL

FOR CHARITABLE SERVICES, NAMELY, CHARITABLE FUND RAISING, PROVIDING FINANCIAL SUPPORT TO CHINESE ORPHANAGES AND CHINESE ORPHAN SUPPORT ORGANIZATIONS; PROVIDING FINANCIAL AID FOR AMERICAN FAMILIES FOR THE PURPOSE OF ADOPTING CHINESE CHILDREN; PROVIDING FINANCIAL SUPPORT TO PRE-ADOPTIVE AND POST-ADOPTIVE FAMILIES OF HANDICAPPED ORPHANS; PROVIDING FINANCIAL SUPPORT FOR CHARITABLE PROGRAMS OFFERING MEDICAL SERVICES TO UNDERDEVELOPED COUNTRIES (U.S. CLS. 100, 101 AND 102).
FIRST USE 10-10-2000; IN COMMERCE 10-10-2000.

CLASS 45—PERSONAL SERVICES

FOR ADOPTION PLACEMENT SERVICES, NAMELY, COUNSELING PROGRAMS IN RELATION TO ADOPTION PLACEMENT, ADOPTION COUNSELING AND SUPPORT; PROVIDING INFORMATION TO COMMUNITY GROUPS AND PRE-ADOPTIVE FAMILIES ABOUT THE BENEFITS OF ADOPTION FROM CHINA AND HANDICAPPED ADOPTION; PROVIDING ADOPTION COUNSELING, SOCIAL SUPPORT AND INFORMATION TO PRE-ADOPTIVE AND POST-ADOPTIVE FAMILIES OF HANDICAPPED ORPHANS (U.S. CLS. 100 AND 101).
FIRST USE 10-10-2000; IN COMMERCE 10-10-2000.

ANDREA EVANS, EXAMINING ATTORNEY

SN 78-861,596. COMPUPAY, INC., MIRAMAR, FL. FILED 4-14-2006.

MaximumPayroll

THE MARK CONSISTS OF STANDARD CHARACTERS WITHOUT CLAIM TO ANY PARTICULAR FONT, STYLE, SIZE, OR COLOR.

OWNER OF U.S. REG. NOS. 1,735,209 AND 2,806,377.

CLASS 35—ADVERTISING AND BUSINESS

FOR COMPUTERIZED PAYROLL PREPARATION SERVICES; WEB-BASED PAYROLL PREPARATION SERVICES; ADMINISTRATION OF BUSINESS PAYROLL FOR OTHERS (U.S. CLS. 100, 101 AND 102).

CLASS 36—INSURANCE AND FINANCIAL

FOR PAYROLL TAX DEBITING SERVICES (U.S. CLS. 100, 101 AND 102).
BARBARA GAYNOR, EXAMINING ATTORNEY

SN 78-861,716. CPM ENTERPRISES LLC, NEW YORK, NY.
FILED 4-14-2006.

**CLASS 41—EDUCATION AND ENTERTAINMENT**

FOR PERSONAL FITNESS AND EXERCISE TRAINING; OFFERING EXERCISE AND PHYSICAL FITNESS CLASSES; PROVIDING GYMNASIUM FACILITIES; HEALTH CLUB SERVICES, NAMELY, PROVIDING INSTRUCTION AND EQUIPMENT IN THE FIELD OF PHYSICAL EXERCISE (U.S. CLS. 100, 101 AND 107).

CLASS 44—MEDICAL, BEAUTY AND AGRICULTURAL SERVICES

FOR HEALTH SPA SERVICES, NAMELY, COSMETIC BODY CARE SERVICES (U.S. CLS. 100 AND 101).
ANDREA EVANS, EXAMINING ATTORNEY

SN 78-861,742. INOLEX INVESTMENT CORPORATION,
PHILADELPHIA, PA. FILED 4-14-2006.

SPECTRAGARD

THE MARK CONSISTS OF STANDARD CHARACTERS WITHOUT CLAIM TO ANY PARTICULAR FONT, STYLE, SIZE, OR COLOR.

CLASS 1—CHEMICALS

FOR CHEMICAL ADDITIVES FOR USE IN THE MANUFACTURE OF PHARMACEUTICALS AND COSMETICS (U.S. CLS. 1, 5, 6, 10, 26 AND 46).
FIRST USE 3-20-2006; IN COMMERCE 3-20-2006.

CLASS 5—PHARMACEUTICALS

FOR BIOCIDES (U.S. CLS. 6, 18, 44, 46, 51 AND 52).
FIRST USE 3-20-2006; IN COMMERCE 3-20-2006.
GISELLE AGOSTO, EXAMINING ATTORNEY

SN 78-861,910. COMPANY OF EXPERTS, INC., PALM SPRINGS, CA. FILED 4-14-2006.

Company of Experts

THE MARK CONSISTS OF STANDARD CHARACTERS WITHOUT CLAIM TO ANY PARTICULAR FONT, STYLE, SIZE, OR COLOR.

CLASS 16—PAPER GOODS AND PRINTED MATTER

FOR EDUCATIONAL PUBLICATIONS, NAMELY, TRAINING MANUALS IN THE FIELDS OF LEADERSHIP, APPRECIATIVE INQUIRY, STRATEGIC PLANNING, MANAGEMENT STRUCTURE, ORGANIZATIONAL CLIMATE, CONFLICT RESOLUTION AND PERSONNEL MOTIVATION (U.S. CLS. 2, 5, 22, 23, 29, 37, 38 AND 50).
FIRST USE 12-26-1989; IN COMMERCE 12-26-1989.

CLASS 35—ADVERTISING AND BUSINESS

FOR BUSINESS ORGANIZATION AND MANAGEMENT CONSULTING AND ADVISORY SERVICES (U.S. CLS. 100, 101 AND 102).
FIRST USE 12-26-1989; IN COMMERCE 12-26-1989.

CLASS 41—EDUCATION AND ENTERTAINMENT

FOR CONDUCTING WORKSHOPS AND SEMINARS IN THE FIELDS OF LEADERSHIP, APPRECIATIVE INQUIRY, STRATEGIC PLANNING, MANAGEMENT STRUCTURE, ORGANIZATIONAL CLIMATE, CONFLICT RESOLUTIONS AND PERSONNEL MOTIVATION (U.S. CLS. 100, 101 AND 107).
FIRST USE 12-26-1989; IN COMMERCE 12-26-1989.
ELLEN PERKINS, EXAMINING ATTORNEY

SN 78-861,927. CACIOLO, ANTHONY, J., COOPERSBURG, PA. FILED 4-14-2006.

Haze

THE MARK CONSISTS OF STANDARD CHARACTERS WITHOUT CLAIM TO ANY PARTICULAR FONT, STYLE, SIZE, OR COLOR.

CLASS 33—WINES AND SPIRITS

FOR VODKA (U.S. CLS. 47 AND 49).

CLASS 43—HOTEL AND RESTAURANT SERVICES

FOR RESTAURANT AND BAR SERVICES (U.S. CLS. 100 AND 101).
CHARLES L. JENKINS, EXAMINING ATTORNEY

SN 78-861,998. RESORTQUEST HAWAII, LLC, HONOLULU, HI. FILED 4-14-2006.

SN 78-862,123. LIQUIDGENERATION, INC., BEVERLY HILLS, CA. FILED 4-14-2006.

A Perfect Place to Stay.
Our Hawaii. Your Way.

THE MARK CONSISTS OF STANDARD CHARACTERS WITHOUT CLAIM TO ANY PARTICULAR FONT, STYLE, SIZE, OR COLOR.

NO CLAIM IS MADE TO THE EXCLUSIVE RIGHT TO USE "HAWAII", APART FROM THE MARK AS SHOWN.

CLASS 36—INSURANCE AND FINANCIAL

FOR RENTAL AND MANAGEMENT OF VACATION REAL ESTATE; VACATION REAL ESTATE BROKERAGE SERVICES (U.S. CLS. 100, 101 AND 102).

FIRST USE 7-0-2005; IN COMMERCE 7-0-2005.

CLASS 43—HOTEL AND RESTAURANT SERVICES

FOR PROVIDING RESORT HOTEL ACCOMMODATIONS AND TEMPORARY HOUSING ACCOMMODATIONS (U.S. CLS. 100 AND 101).

FIRST USE 7-0-2005; IN COMMERCE 7-0-2005.

MARK T. MULLEN, EXAMINING ATTORNEY

SN 78-862,031. SCHIAPELLI, PATRICIA, COSTA MESA, CA. FILED 4-14-2006.

HAND CANDI

THE MARK CONSISTS OF STANDARD CHARACTERS WITHOUT CLAIM TO ANY PARTICULAR FONT, STYLE, SIZE, OR COLOR.

CLASS 14—JEWELRY

FOR JEWELRY AND WATCHES (U.S. CLS. 2, 27, 28 AND 50).

CLASS 18—LEATHER GOODS

FOR PURSES (U.S. CLS. 1, 2, 3, 22 AND 41).

CLASS 25—CLOTHING

FOR GLOVES (U.S. CLS. 22 AND 39).

MICHAEL KAZAZIAN, EXAMINING ATTORNEY

Ghetto Stiletto

THE MARK CONSISTS OF STANDARD CHARACTERS WITHOUT CLAIM TO ANY PARTICULAR FONT, STYLE, SIZE, OR COLOR.

CLASS 16—PAPER GOODS AND PRINTED MATTER

FOR BUMPER STICKERS; POSTERS (U.S. CLS. 2, 5, 22, 23, 29, 37, 38 AND 50).

CLASS 21—HOUSEWARES AND GLASS

FOR MUGS (U.S. CLS. 2, 13, 23, 29, 30, 33, 40 AND 50).

CLASS 25—CLOTHING

FOR HATS; HEADBANDS; JACKETS; PANTS; SHIRTS; T-SHIRTS; TOPS (U.S. CLS. 22 AND 39).

CLASS 38—COMMUNICATION

FOR BROADCAST OF CABLE TELEVISION PROGRAMMES; CABLE TELEVISION BROADCASTING; MOBILE MEDIA AND ENTERTAINMENT SERVICES IN THE NATURE OF ELECTRONIC TRANSMISSION OF ENTERTAINMENT MEDIA CONTENT; SATELLITE TELEVISION BROADCASTING; STREAMING OF AUDIO MATERIAL ON THE INTERNET; STREAMING OF VIDEO MATERIAL ON THE INTERNET; TELEVISION BROADCASTING (U.S. CLS. 100, 101 AND 104).

CLASS 41—EDUCATION AND ENTERTAINMENT

FOR ENTERTAINMENT IN THE NATURE OF ON-GOING TELEVISION PROGRAMS IN THE FIELD OF COMEDY; ENTERTAINMENT IN THE NATURE OF PRE-RECORDED COMEDIC MESSAGES BY TELEPHONE; ENTERTAINMENT IN THE NATURE OF TELEVISION NEWS SHOWS; ENTERTAINMENT IN THE NATURE OF VISUAL AND AUDIO PERFORMANCES, AND MUSICAL, VARIETY, NEWS AND COMEDY SHOWS; ENTERTAINMENT, NAMELY, PRODUCTION OF COMEDIC TELEVISION PROGRAMS; ENTERTAINMENT SERVICES IN THE NATURE OF ON-GOING TELEVISION PROGRAMS IN THE FIELD OF CHILDREN'S ENTERTAINMENT; ENTERTAINMENT SERVICES, NAMELY, CONDUCTING CONTESTS; ENTERTAINMENT SERVICES, NAMELY, PROVIDING A RADIO PROGRAM IN THE FIELD OF COMEDY VIA A GLOBAL COMPUTER NETWORK; ENTERTAINMENT SERVICES, NAMELY, PROVIDING A TELEVISION PROGRAM IN THE FIELD OF COMEDY VIA A GLOBAL COMPUTER NETWORK; ENTERTAINMENT SERVICES, NAMELY, PROVIDING AN ON-LINE COMPUTER GAME; ENTERTAINMENT SERVICES, NAMELY, PROVIDING ON-LINE COMPUTER GAMES; ENTERTAINMENT, NAMELY, TELEVISION NEWS SHOWS; MOBILE MEDIA AND ENTERTAINMENT SERVICES IN THE NATURE OF CONTENT PREPARATION; MOBILE MEDIA AND ENTERTAINMENT SERVICES IN THE NATURE OF CONTENT PREPARATION, POST-PRODUCTION; PRODUCTION OF CABLE TELEVISION PROGRAMS (U.S. CLS. 100, 101 AND 107).

ELISSA GARBER KON, EXAMINING ATTORNEY

SN 78-862,147. SCYLD COMPUTING CORPORATION, SAN FRANCISCO, CA. FILED 4-14-2006.



OWNER OF U.S. REG. NOS. 2,535,665, 2,995,673 AND OTHERS.

CLASS 9—ELECTRICAL AND SCIENTIFIC APPARATUS

FOR COMPUTER SOFTWARE FOR COMPUTER OPERATING SYSTEMS; COMPUTER OPERATING SYSTEMS; COMPUTER SOFTWARE PLATFORMS FOR USE WITH COMPUTER SERVERS AND CLUSTERS; INSTRUCTION MANUALS SOLD AS A UNIT THEREWITH (U.S. CLS. 21, 23, 26, 36 AND 38).

CLASS 42—SCIENTIFIC, COMPUTER AND LEGAL SERVICES

FOR COMPUTER SOFTWARE DEVELOPMENT SERVICES FOR OTHERS; TECHNICAL SUPPORT NAMELY, TROUBLESHOOTING OF COMPUTER HARDWARE AND SOFTWARE PROBLEMS; COMPUTER CONSULTATION (U.S. CLS. 100 AND 101).

IRA J. GOODSaid, EXAMINING ATTORNEY

SN 78-862,150. COTTON PARADISE, INC., CITY OF INDUSTRY, CA. FILED 4-14-2006.



NO CLAIM IS MADE TO THE EXCLUSIVE RIGHT TO USE "COTTON", APART FROM THE MARK AS SHOWN.

THE MARK CONSISTS OF A COTTON FLOWER IN AN INCOMPLETE CIRCLE WITH JAPANESE KATAKANA CHARACTERS (MEANING "PARADISE" IN ENGLISH) AND "COTTON PARADISE" UNDER IT.

THE FOREIGN WORDING IN THE MARK TRANSLATES INTO ENGLISH AS PARADISE.

THE NON-LATIN CHARACTER(S) IN THE MARK TRANSLITERATES INTO PARADAIU, AND THIS MEANS PARADISE IN ENGLISH.

CLASS 18—LEATHER GOODS

FOR HANDBAGS; PET CARRIERS (U.S. CLS. 1, 2, 3, 22 AND 41).

CLASS 19—NON-METALLIC BUILDING MATERIALS

FOR MODULAR CAT AND DOG HOUSES (U.S. CLS. 1, 12, 33 AND 50).

IRA J. GOODSaid, EXAMINING ATTORNEY

SN 78-862,205. O'BRIEN, PAUL, TUNKHANNOCK, PA. FILED 4-14-2006.

AVERA

THE MARK CONSISTS OF STANDARD CHARACTERS WITHOUT CLAIM TO ANY PARTICULAR FONT, STYLE, SIZE, OR COLOR.

CLASS 3—COSMETICS AND CLEANING PREPARATIONS

FOR BATH SALTS, BATH OILS, BATH GELS, SKIN CONDITIONERS, SKIN AND HAIR RINSES, PERFUMES, AND SKIN LOTIONS (U.S. CLS. 1, 4, 6, 50, 51 AND 52).

CLASS 21—HOUSEWARES AND GLASS

FOR DISPENSERS FOR INSERTING BATH SALTS, BATH OILS, BATH GELS, SKIN CONDITIONERS, SKIN AND HAIR RINSES, PERFUMES AND SKIN LOTIONS INTO A SHOWER WATER STREAM FOR RELAXATION AND THERAPEUTIC PURPOSES (U.S. CLS. 2, 13, 23, 29, 30, 33, 40 AND 50).

JEFFERY COWARD, EXAMINING ATTORNEY

SN 78-862,378. SAVERKEN, INC., HOUSTON, TX. FILED 4-16-2006.

dwrbrir

THE MARK CONSISTS OF STANDARD CHARACTERS WITHOUT CLAIM TO ANY PARTICULAR FONT, STYLE, SIZE, OR COLOR.

CLASS 9—ELECTRICAL AND SCIENTIFIC APPARATUS

FOR ANTI-GLARE GLASSES; CASES FOR CHILDREN'S EYE GLASSES; CHILDREN'S EYE GLASSES; CORRECTIVE GLASSES; ELECTRONIC GLASS AND CERAMIC FUSES FOR USE WITH ANY ELECTRONIC EQUIPMENT USING A/C POWER; FIELD-GLASSES; FRAMES FOR GLASSES AND PINCE-NEZ; GLASS DRIERS FOR LABORATORY PURPOSES; GLASS GRADUATED SCALES; GLASS TUBES FOR SCIENTIFIC PURPOSES; MAGNIFYING GLASSES; OPERA GLASSES; OPTICAL GLASSES; PLATES, GLASS SLIDES OR CHIPS HAVING MULTI-WELL ARRAYS THAT CAN BE USED IN CHEMICAL ANALYSIS, BIOLOGICAL ANALYSIS OR PATTERNING FOR SCIENTIFIC, LABORATORY OR MEDICAL RESEARCH USE (U.S. CLS. 21, 23, 26, 36 AND 38).

CLASS 14—JEWELRY

FOR ANKLE BRACELETS; BODY-PIERCING RINGS; BRACELETS; BRACELETS OF PRECIOUS METAL; CANDLE RINGS OF PRECIOUS METAL; CHARITY BRACELETS; IDENTIFICATION BRACELETS; KEY RINGS OF PRECIOUS METAL; NAPKIN RINGS OF PRECIOUS METAL; NUTCRACKERS, PEPPER POTS, SUGAR BOWLS, SALT SHAKERS, EGG CUPS, NAPKIN HOLDERS, NAPKIN RINGS, TRAYS AND TOOTHPICK HOLDERS OF PRECIOUS METAL; RINGS; RINGS BEING JEWELRY; RUBBER OR SILICON WRISTBANDS IN THE NATURE OF A BRACELET; SERVIETTE RINGS OF PRECIOUS METAL; WATCH BRACELETS; WATCH CROWNS; WATCH FACES; WATCH FOBS; WATCH GLASSES; WATCH MOVEMENTS; WATCH PARTS; WATCH POUCHES; WATCH STRAPS; WATCH STRAPS MADE OF METAL OR LEATHER OR PLASTIC; WATCH WINDERS; WATCH WINDING BUTTONS; WATCHES; WATCHES CONTAINING A GAME FUNCTION; WATCHES CONTAINING AN ELECTRONIC GAME FUNCTION; WATCHES FOR OUTDOOR USE; WRIST WATCHES (U.S. CLS. 2, 27, 28 AND 50).

CLASS 18—LEATHER GOODS

FOR BABY BACKPACKS; BACKPACKS; SCHOOL-CHILDREN'S BACKPACKS; SMALL BACKPACKS (U.S. CLS. 1, 2, 3, 22 AND 41).

CLASS 25—CLOTHING

FOR SHORT-SLEEVED OR LONG-SLEEVED T-SHIRTS; T-SHIRTS; ANKLE SOCKS; ANKLETS; ANTI-PERSPIRANT SOCKS; BRIEFS; DISPOSABLE UNDERWEAR; HEADGEAR, NAMELY, HAT, CAPS; JAPANESE STYLE SOCKS (TABI COVERS); JAPANESE STYLE SOCKS (TABI); JEANS; KNITTED UNDERWEAR; LADIES' UNDERWEAR; MEN'S SOCKS; PARTS OF CLOTHING, NAMELY, GUSSETS FOR TIGHTS, GUSSETS FOR STOCKINGS, GUSSETS FOR BATHING SUITS, GUSSETS FOR UNDERWEAR, GUSSETS FOR LEOTARDS AND GUSSETS FOR FOOTLETS; PERSPIRATION ABSORBENT UNDERWEAR CLOTHING; PLEATED SKIRTS FOR FORMAL KIMONOS (HAKAMA); SKIRT SUITS; SKIRTS; SKIRTS AND DRESSES; SOCK SUSPENDERS; SOCKS; SOCKS AND STOCKINGS; T-SHIRTS; THERMAL SOCKS; THERMAL UNDERWEAR; THONGS; UNDERWEAR; WATER SOCKS; WOMEN'S UNDERWEAR; WOOLLEN SOCKS; WOVEN OR KNITTED UNDERWEAR (U.S. CLS. 22 AND 39).

FIRST USE 6-8-1998; IN COMMERCE 6-20-1998.
STANLEY I. OSBORNE, EXAMINING ATTORNEY

CLASS 9—ELECTRICAL AND SCIENTIFIC APPARATUS

FOR ANTI-GLARE GLASSES; CASES FOR CHILDREN'S EYE GLASSES; CHILDREN'S EYE GLASSES; CORRECTIVE GLASSES; ELECTRONIC GLASS AND CERAMIC FUSES FOR USE WITH ANY ELECTRONIC EQUIPMENT USING A/C POWER; ENCODED MICRO PARTICULATES, TAGS AND TAGGANTS OF PLASTIC, METAL OR SILICATE FOR USE IN THE FIELD OF PASSIVE LABELING, TRACING OR TRACKING OF PERSONS, ANIMALS, VEHICLES OR GOODS OF ANY KIND; FIELD-GLASSES; FRAMES FOR GLASSES AND PINCE-NEZ; GLASS DRIERS FOR LABORATORY PURPOSES; GLASS GRADUATED SCALES; GLASS TUBES FOR SCIENTIFIC PURPOSES; MAGNIFYING GLASSES; OPERA GLASSES; OPTICAL GLASSES; PLATES, GLASS SLIDES OR CHIPS HAVING MULTI-WELL ARRAYS THAT CAN BE USED IN CHEMICAL ANALYSIS, BIOLOGICAL ANALYSIS OR PATTERNING FOR SCIENTIFIC, LABORATORY OR MEDICAL RESEARCH USE; RADIO FREQUENCY IDENTIFICATION (RFID) TAGS (U.S. CLS. 21, 23, 26, 36 AND 38).

CLASS 14—JEWELRY

FOR ANKLE BRACELETS; BODY-PIERCING RINGS; BRACELETS ; BRACELETS OF PRECIOUS METAL; CANDLE RINGS OF PRECIOUS METAL; CHARITY BRACELETS; IDENTIFICATION BRACELETS ; KEY RINGS OF PRECIOUS METAL; NAPKIN RINGS OF PRECIOUS METAL; NUTCRACKERS, PEPPER POTS, SUGAR BOWLS, SALT SHAKERS, EGG CUPS, NAPKIN HOLDERS, NAPKIN RINGS, TRAYS AND TOOTHPICK HOLDERS OF PRECIOUS METAL; RINGS ; RINGS BEING JEWELRY; RUBBER OR SILICON WRISTBANDS IN THE NATURE OF A BRACELET; SERVIETTE RINGS OF PRECIOUS METAL; WATCH BRACELETS; WATCH CROWNS; WATCH FACES; WATCH FOBS; WATCH GLASSES; WATCH MOVEMENTS; WATCH PARTS; WATCH POUCHES; WATCH STRAPS; WATCH STRAPS MADE OF METAL OR LEATHER OR PLASTIC; WATCH WINDERS; WATCH WINDING BUTTONS; WATCHES; WATCHES CONTAINING A GAME FUNCTION; WATCHES CONTAINING AN ELECTRONIC GAME FUNCTION; WATCHES FOR OUTDOOR USE; WRIST WATCHES (U.S. CLS. 2, 27, 28 AND 50).

CLASS 16—PAPER GOODS AND PRINTED MATTER

FOR CARDBOARD HANG TAGS; HANGING FOLDERS; PAPER GIFT TAGS; PAPER HANG TAGS; PAPER IDENTIFICATION TAGS; PAPER TAGS; PRICE TAGS (U.S. CLS. 2, 5, 22, 23, 29, 37, 38 AND 50).

CLASS 18—LEATHER GOODS

FOR BABY BACKPACKS; BACKPACKS; SCHOOL-CHILDREN'S BACKPACKS; SMALL BACKPACKS (U.S. CLS. 1, 2, 3, 22 AND 41).

CLASS 25—CLOTHING

FOR ANKLE SOCKS; ANKLETS ; ANTI-PERSPIRANT SOCKS; BRIEFS ; DISPOSABLE UNDERWEAR; HEADGEAR, NAMELY, HAT, CAPS; JAPANESE STYLE SOCKS (TABI COVERS); JAPANESE STYLE SOCKS (TABI); JEANS; KNITTED UNDERWEAR; LADIES' UNDERWEAR; MEN'S SOCKS; PARTS OF CLOTHING, NAMELY, GUSSETS FOR TIGHTS, GUSSETS FOR STOCKINGS, GUSSETS FOR BATHING SUITS, GUSSETS FOR UNDERWEAR, GUSSETS FOR LEOTARDS AND GUSSETS FOR FOOTLETS; PERSPIRATION ABSORBENT UNDERWEAR CLOTHING; PLEATED SKIRTS FOR FORMAL KIMONOS (HAKAMA); SHORT-SLEEVED OR LONG-SLEEVED T-SHIRTS; SKIRT SUITS; SKIRTS; SKIRTS AND DRESSES; SOCK SUSPENDERS; SOCKS; SOCKS AND STOCKINGS; T-SHIRTS; THERMAL SOCKS; THERMAL UNDERWEAR; THONGS ; UNDERWEAR; WATER SOCKS; WOMEN'S UNDERWEAR; WOOLLEN SOCKS; WOVEN OR KNITTED UNDERWEAR (U.S. CLS. 22 AND 39).

FIRST USE 6-8-1998; IN COMMERCE 6-20-1998.
STANLEY I. OSBORNE, EXAMINING ATTORNEY

SN 78-862,383. SAVERKEN, INC., HOUSTON, TX. FILED 4-16-2006.

do what's right because
it's right

THE MARK CONSISTS OF STANDARD CHARACTERS WITHOUT CLAIM TO ANY PARTICULAR FONT, STYLE, SIZE, OR COLOR.

SN 78-862,568. TV GUIDE MAGAZINE GROUP, INC., LOS ANGELES, CA. FILED 4-17-2006.

J-GUIDE

THE MARK CONSISTS OF STANDARD CHARACTERS WITHOUT CLAIM TO ANY PARTICULAR FONT, STYLE, SIZE, OR COLOR.

OWNER OF U.S. REG. NOS. 650,942, 1,137,497 AND OTHERS.

CLASS 35—ADVERTISING AND BUSINESS

FOR ADVERTISING SERVICES, NAMELY, PROMOTING THE GOODS AND SERVICES OF OTHERS BY PREPARING AND PLACING INFORMATIONAL AND PROMOTIONAL ADVERTISEMENTS VIA BROADCAST, CABLE, SATELLITE AND ON-LINE ELECTRONIC COMMUNICATIONS NETWORKS (U.S. CLS. 100, 101 AND 102).

CLASS 38—COMMUNICATION

FOR COMMUNICATIONS SERVICES, NAMELY, THE TRANSMISSION AND DELIVERY OF PROMOTIONAL, INFORMATIONAL, AND INTERACTIVE TELEVISION PROGRAMMING SERVICES VIA BROADCAST, CABLE, SATELLITE AND ON-LINE ELECTRONIC COMMUNICATIONS NETWORKS (U.S. CLS. 100, 101 AND 104).

CLASS 41—EDUCATION AND ENTERTAINMENT

FOR ENTERTAINMENT SERVICES, NAMELY, PROVIDING PROMOTIONAL, INFORMATIONAL, AND INTERACTIVE TELEVISION PROGRAMMING SERVICES VIA BROADCAST, CABLE, SATELLITE AND ON-LINE ELECTRONIC COMMUNICATIONS NETWORKS (U.S. CLS. 100, 101 AND 107).

JEAN IM, EXAMINING ATTORNEY

SN 78-862,641. A. DAIGGER AND COMPANY, THROUGH ITS ETA/CUISENAIRE DIVISION, VERNON HILLS, IL. FILED 4-17-2006.

ETA CUISENAIRE

THE MARK CONSISTS OF STANDARD CHARACTERS WITHOUT CLAIM TO ANY PARTICULAR FONT, STYLE, SIZE, OR COLOR.

OWNER OF U.S. REG. NOS. 899,601, 1,392,358 AND 2,593,948.

CLASS 9—ELECTRICAL AND SCIENTIFIC APPARATUS

FOR HOUSE MARK FOR CALCULATORS, PRE-RECORDED VIDEOTAPES FEATURING EDUCATIONAL GAMES IN THE FIELD OF MATHEMATICS AND THE SCIENCES; CHILDREN'S EDUCATIONAL SCIENTIFIC KITS COMPRISED PRIMARILY OF ONE OR MORE OF THE FOLLOWING - FORCEPS, MAGNIFYING LENSES, THERMOMETERS, MAGNETS, COMPASSES, GEARS, BELTS, PULLEYS, AXLES, FUNNELS, DISPENSING BOTTLES, TEST TUBES, DROPPERS, CHEMICAL SOLUTIONS, INSTRUCTIONAL MANUALS AND THE LIKE, IN THE FIELDS OF LIFE SCIENCE, EARTH SCIENCE, PHYSICAL SCIENCE AND CHEMISTRY (U.S. CLS. 21, 23, 26, 36 AND 38).

FIRST USE 4-13-2000; IN COMMERCE 4-13-2000.

CLASS 16—PAPER GOODS AND PRINTED MATTER

FOR HOUSE MARK FOR TEMPLATES FOR DRAWING AND DRAFTING; BOOKS IN THE FIELDS OF MATHEMATICS, LIFE SCIENCE, EARTH SCIENCE, SPACE SCIENCE, PHYSICAL SCIENCE AND CHEMISTRY; AND PRINTED TEACHING MATERIALS IN THE FORM OF PAPER AND PLASTIC TRANSPARENCIES THAT INCLUDE MANIPULATIVES (U.S. CLS. 2, 5, 22, 23, 29, 37, 38 AND 50).

FIRST USE 4-13-2000; IN COMMERCE 4-13-2000.

CLASS 28—TOYS AND SPORTING GOODS

FOR HOUSE MARK FOR EDUCATIONAL GAMES, NAMELY, BOARD GAMES AND EQUIPMENT SOLD AS A UNIT FOR PLAYING BOARD GAMES; CARD GAMES AND EQUIPMENT SOLD AS A UNIT FOR PLAYING CARD GAMES IN THE FORM OF ACTIVITY CARDS, SPINNERS, MOVABLE PLAYING PIECES, INSTRUCTIONAL MANUALS AND THE LIKE; ELECTRONIC EDUCATIONAL GAME MACHINES FOR TEACHING CHILDREN ABOUT MATHEMATICS AND READING; PRINTED GAME CARDS; MANIPULATIVES; PUZZLES, NAMELY PUZZLE CUBES AND JIGSAW PUZZLES; KITS COMPRISED OF MANIPULATIVES AND PRINTED MATERIAL FOR TEACHING ABOUT MATHEMATICS, SOLD TOGETHER AS A UNIT; PLASTIC MODELS FOR TEACHING ABOUT MATHEMATICS AND SCIENCE (U.S. CLS. 22, 23, 38 AND 50).

FIRST USE 4-13-2000; IN COMMERCE 4-13-2000.

CLASS 35—ADVERTISING AND BUSINESS

FOR HOUSE MARK FOR MAIL ORDER AND COMPUTERIZED ONLINE ORDERING SERVICES FEATURING EDUCATIONAL MATERIAL AND EQUIPMENT IN THE FIELDS OF MATHEMATICS, READING, WRITING AND THE SCIENCES (U.S. CLS. 100, 101 AND 102).

FIRST USE 4-13-2000; IN COMMERCE 4-13-2000.

DEZMONA MIZELLE, EXAMINING ATTORNEY

SN 78-862,648. RANSOM, LAURENCE, SNOHOMISH, WA. FILED 4-17-2006.

Great Relate

THE MARK CONSISTS OF STANDARD CHARACTERS WITHOUT CLAIM TO ANY PARTICULAR FONT, STYLE, SIZE, OR COLOR.

CLASS 9—ELECTRICAL AND SCIENTIFIC APPARATUS

FOR PRERECORDED AUDIO AND VIDEO TAPES AND CDS FEATURING INSTRUCTIONAL, EDUCATIONAL, AND TEACHING PRESENTATIONS IN THE FIELD OF BUSINESS AND ORGANIZATIONAL PLANNING, MOTIVATIONAL THINKING, LEADERSHIP SKILLS, INNOVATION AND CHANGE (U.S. CLS. 21, 23, 26, 36 AND 38).

FIRST USE 11-0-2004; IN COMMERCE 11-0-2004.

CLASS 16—PAPER GOODS AND PRINTED MATTER

FOR PRINTED INSTRUCTIONAL, EDUCATIONAL, AND TEACHING MATERIALS IN THE FIELD OF BUSINESS AND ORGANIZATIONAL PLANNING, MOTIVATIONAL THINKING, LEADERSHIP SKILLS, INNOVATION AND CHANGE; BOOKS IN THE FIELD OF BUSINESS AND ORGANIZATIONAL PLANNING, MOTIVATIONAL THINKING, LEADERSHIP SKILLS, INNOVATION AND CHANGE (U.S. CLS. 2, 5, 22, 23, 29, 37, 38 AND 50).

FIRST USE 11-0-2004; IN COMMERCE 11-0-2004.

CLASS 41—EDUCATION AND ENTERTAINMENT

FOR EDUCATIONAL SERVICES, NAMELY, ARRANGING AND CONDUCTING EDUCATIONAL CONFERENCES, AND ARRANGING AND CONDUCTING WORKSHOPS, SEMINARS, AND TRAINING PROGRAMS IN THE FIELD OF BUSINESS AND ORGANIZATIONAL PLANNING, MOTIVATIONAL THINKING, LEADERSHIP SKILLS, INNOVATION AND CHANGE, AND COURSE MATERIALS DISTRIBUTED IN CONNECTION THEREWITH (U.S. CLS. 100, 101 AND 107).

FIRST USE 11-0-2004; IN COMMERCE 11-0-2004.
DEZMONA MIZELLE, EXAMINING ATTORNEY

SN 78-862,670. ASIAN AMERICAN JUSTICE CENTER, WASHINGTON, DC. FILED 4-17-2006.



NO CLAIM IS MADE TO THE EXCLUSIVE RIGHT TO USE "ASIAN AMERICAN JUSTICE CENTER", APART FROM THE MARK AS SHOWN.

CLASS 16—PAPER GOODS AND PRINTED MATTER

FOR PUBLICATIONS, NAMELY, BROCHURES, BOOKLETS, AND TEACHING MATERIALS IN THE FIELD OF PROMOTING THE HUMAN AND CIVIL RIGHTS OF ASIAN AMERICANS (U.S. CLS. 2, 5, 22, 23, 29, 37, 38 AND 50).

FIRST USE 10-0-2005; IN COMMERCE 10-0-2005.

CLASS 35—ADVERTISING AND BUSINESS

FOR ASSOCIATION AND LOBBYING SERVICES, NAMELY, PROMOTING THE INTERESTS OF ASIAN AMERICANS IN THE FIELDS OF IMMIGRANT AND CIVIL RIGHTS (U.S. CLS. 100, 101 AND 102).

FIRST USE 10-0-2005; IN COMMERCE 10-0-2005.

CLASS 42—SCIENTIFIC, COMPUTER AND LEGAL SERVICES

FOR LEGAL SERVICES (U.S. CLS. 100 AND 101).
FIRST USE 10-0-2005; IN COMMERCE 10-0-2005.
DAVID COLLIER, EXAMINING ATTORNEY

SN 78-862,776. THE WET SEAL, INC., FOOTHILL RANCH, CA. FILED 4-17-2006.

TREND SPOT 

CLASS 25—CLOTHING

FOR CLOTHING, NAMELY, HATS, CAPS, VISORS, GLOVES, MITTENS, SCARVES, BELTS, TIES, SOCKS, TIGHTS, HOSIERY, STOCKINGS, SHOES, BOOTS, SLIPPERS, BLOUSES, SHIRTS, CAMISOLES, TOPS, TANK-TOPS, T-SHIRTS, SWEATSHIRTS, PULLOVERS, SWEATERS, BLAZERS, JACKETS, COATS, DRESSES, SKIRTS, SKORTS, CAPRIS, JEANS, SHORTS, PANTS, SWEAT-PANTS, LEGGINGS, UNDERWEAR, BRAS, PANTIES, SLIPS, TEDDIES, NIGHTGOWNS, PAJAMAS, SLEEP SHIRTS, BATHROBES, LINGERIE, BEACH COVER-UPS, SWIMWEAR, RAINWEAR (U.S. CLS. 22 AND 39).

FIRST USE 1-13-2006; IN COMMERCE 1-13-2006.

CLASS 35—ADVERTISING AND BUSINESS

FOR RETAIL STORE SERVICES SPECIALIZING IN APPAREL AND ACCESSORIES (U.S. CLS. 100, 101 AND 102).

FIRST USE 1-13-2006; IN COMMERCE 1-13-2006.
JOHN LINCOSKI, EXAMINING ATTORNEY

SN 78-862,830. STEVENS GARY, LITTLETON, CO. FILED 4-17-2006.

AGS Exteriors

THE MARK CONSISTS OF STANDARD CHARACTERS WITHOUT CLAIM TO ANY PARTICULAR FONT, STYLE, SIZE, OR COLOR.

NO CLAIM IS MADE TO THE EXCLUSIVE RIGHT TO USE "EXTERIORS", APART FROM THE MARK AS SHOWN.

CLASS 2—PAINTS

FOR COATINGS, NAMELY, STAINS AND CLEAR FINISHES FOR EXTERIOR AND INTERIOR USE ON A VARIETY OF SUBSTRATES; EXTERIOR PAINT (U.S. CLS. 6, 11 AND 16).

CLASS 19—NON-METALLIC BUILDING MATERIALS

FOR CONSTRUCTION MATERIAL, NAMELY, NON-METAL EXTERIOR BOARDS; CONSTRUCTION MATERIAL, NAMELY, NONMETAL EXTERIOR PANELS (U.S. CLS. 1, 12, 33 AND 50).

CLASS 42—SCIENTIFIC, COMPUTER AND LEGAL SERVICES

FOR TEMPORARY INTERIOR AND EXTERIOR HOME DECORATION CONSULTATION, NAMELY HOME STAGING CONSULTATION FOR THE PURPOSE OF MAKING HOMES MORE APPEALING TO PROSPECTIVE BUYERS (U.S. CLS. 100 AND 101).
HEATHER THOMPSON, EXAMINING ATTORNEY

CLASS 5—PHARMACEUTICALS

FOR IMMUNOHISTOCHEMISTRY TEST REAGENTS COMPRISED PRIMARILY OF DIAGNOSTIC REAGENTS FOR THE DETECTION OF NORMAL CANCER AND OTHER TUMOR CELLS IN MEDICAL RESEARCH AND CLINICAL SPECIMENS (U.S. CLS. 6, 18, 44, 46, 51 AND 52).

CLASS 9—ELECTRICAL AND SCIENTIFIC APPARATUS

FOR IMMUNOHISTOCHEMISTRY TEST KIT COMPRISED PRIMARILY OF AN APPARATUS IN THE NATURE OF A ROBOTIC INSTRUMENT AND RELATED REAGENTS FOR DETECTION OF NORMAL, CANCER AND OTHER TUMOR CELLS IN MEDICAL RESEARCH AND CLINICAL SPECIMENS (U.S. CLS. 21, 23, 26, 36 AND 38).
RONALD MCMORROW, EXAMINING ATTORNEY

SN 78-863,023. WIRELESS EXPERTS INC., LAS VEGAS, NV. FILED 4-17-2006.

FREE ACCESSORIES FOR LIFE

THE MARK CONSISTS OF STANDARD CHARACTERS WITHOUT CLAIM TO ANY PARTICULAR FONT, STYLE, SIZE, OR COLOR.
NO CLAIM IS MADE TO THE EXCLUSIVE RIGHT TO USE "FREE ACCESSORIES", APART FROM THE MARK AS SHOWN.

CLASS 9—ELECTRICAL AND SCIENTIFIC APPARATUS

FOR BATTERY CHARGERS; CASES FOR MOBILE PHONES; CELL PHONE COVERS; CELLULAR TELEPHONES; DECORATIVE CHARMS FOR CELLULAR TELEPHONES; DIGITAL CELLULAR PHONES; MOBILE PHONE STRAPS; SPECIALTY HOLSTER FOR CARRYING CELLULAR PHONES (U.S. CLS. 21, 23, 26, 36 AND 38).

CLASS 38—COMMUNICATION

FOR CELLULAR TELEPHONE COMMUNICATION (U.S. CLS. 100, 101 AND 104).
MARC LEIPZIG, EXAMINING ATTORNEY

SN 78-863,163. ERICKSON, PAGE, ANDREW, GOLETA, CA. FILED 4-17-2006.

Celerus Wave

THE MARK CONSISTS OF STANDARD CHARACTERS WITHOUT CLAIM TO ANY PARTICULAR FONT, STYLE, SIZE, OR COLOR.

SN 78-863,204. YOUNG, STUART, DEL MAR, CA. FILED 4-17-2006.

VETOVACTIONS

THE MARK CONSISTS OF STANDARD CHARACTERS WITHOUT CLAIM TO ANY PARTICULAR FONT, STYLE, SIZE, OR COLOR.

CLASS 5—PHARMACEUTICALS

FOR VETERINARY PHARMACEUTICAL PREPARATIONS, NAMELY, AGENTS FOR THE RELIEF OF PAIN; BIOLOGICAL TISSUE IMPLANTS, NAMELY, AVITAL PROCESSED ANIMAL CONNECTIVE TISSUE; BOVINE COLLAGEN AND PMMA (POLYMETHYL METHACRYLATE) MICROSPHERES IN INJECTABLE FORM TO TREAT DISEASES OF THE SPINE (U.S. CLS. 6, 18, 44, 46, 51 AND 52).

CLASS 10—MEDICAL APPARATUS

FOR IMPLANTS CONSISTING OF ARTIFICIAL MATERIALS, NAMELY, SURGICAL TISSUE IMPLANTS COMPRISING COLLAGEN BASED AND NON COLLAGEN BASED INJECTABLES AND NON-FUSION SPINAL IMPLANTS COMPRISING COLLAGEN BASED AND NON COLLAGEN BASED INJECTABLES TO TREAT DISEASES OF THE SPINE; TISSUE IMPLANTS CONSISTING OF ARTIFICIAL MATERIALS (U.S. CLS. 26, 39 AND 44).

CLASS 44—MEDICAL, BEAUTY AND AGRICULTURAL SERVICES

FOR VETERINARY SERVICES (U.S. CLS. 100 AND 101).
DARRYL SPRUILL, EXAMINING ATTORNEY

SN 78-863,218. YOUNG, STUART, DEL MAR, CA. FILED 4-17-2006.

COLLOVATIONS

THE MARK CONSISTS OF STANDARD CHARACTERS WITHOUT CLAIM TO ANY PARTICULAR FONT, STYLE, SIZE, OR COLOR.

CLASS 5—PHARMACEUTICALS

FOR PHARMACEUTICAL PREPARATIONS, NAMELY, AGENTS FOR THE RELIEF OF PAIN; BIOLOGICAL TISSUE IMPLANTS, NAMELY, AVITAL PROCESSED HUMAN OR ANIMAL CONNECTIVE TISSUE; BOVINE COLLAGEN AND PMMA (POLYMETHYL METHACRYLATE) MICROSPHERES IN INJECTABLE FORM TO TREAT DISEASES OF THE SPINE (U.S. CLS. 6, 18, 44, 46, 51 AND 52).

CLASS 10—MEDICAL APPARATUS

FOR IMPLANTS CONSISTING OF ARTIFICIAL MATERIALS, NAMELY, SURGICAL TISSUE IMPLANTS COMPRISING COLLAGEN BASED AND NON COLLAGEN BASED INJECTABLES AND NON-FUSION SPINAL IMPLANTS COMPRISING COLLAGEN BASED AND NON COLLAGEN BASED INJECTABLES TO TREAT DISEASES OF THE SPINE; TISSUE IMPLANTS CONSISTING OF ARTIFICIAL MATERIALS (U.S. CLS. 26, 39 AND 44).

CLASS 44—MEDICAL, BEAUTY AND AGRICULTURAL SERVICES

FOR VETERINARY SERVICES (U.S. CLS. 100 AND 101).
DARRYL SPRUILL, EXAMINING ATTORNEY

SN 78-863,618. KAHAN, JASON, BOCA RATON, FL. FILED 4-18-2006.



THE MARK CONSISTS OF STYLIZED (ROUNDED END POINTS) LETTERS M, R, V WITH A PERSONIFIED CHARACTER STYLIZED (COUNTERS KNOCKED OUT) WITH THE LETTERS VOD STANDING ON TOP OF THE LETTER O IN THE OVERALL MARK.

CLASS 9—ELECTRICAL AND SCIENTIFIC APPARATUS

FOR DOWNLOADABLE FILMS AND TV PROGRAMS PROVIDED VIA A VIDEO-ON-DEMAND (U.S. CLS. 21, 23, 26, 36 AND 38).

CLASS 38—COMMUNICATION

FOR BROADCASTING SERVICES AND PROVISION OF TELECOMMUNICATION ACCESS TO FILMS AND TV PROGRAMMES PROVIDED VIA A VIDEO-ON-DEMAND SERVICE; VIDEO-ON-DEMAND TRANSMISSION SERVICES (U.S. CLS. 100, 101 AND 104).

CLASS 41—EDUCATION AND ENTERTAINMENT

FOR PROVISION OF NON-DOWNLOADABLE FILMS AND TV PROGRAMMES VIA A VIDEO-ON-DEMAND SERVICE (U.S. CLS. 100, 101 AND 107).
PAM WILLIS, EXAMINING ATTORNEY

SN 78-863,633. HOUSECLICKERS, INC., EASTSOUND, WA. FILED 4-18-2006.

HOUSECLICKERS

THE MARK CONSISTS OF STANDARD CHARACTERS WITHOUT CLAIM TO ANY PARTICULAR FONT, STYLE, SIZE, OR COLOR.

CLASS 9—ELECTRICAL AND SCIENTIFIC APPARATUS

FOR MAGNETICALLY ENCODED CREDIT CARDS (U.S. CLS. 21, 23, 26, 36 AND 38).

CLASS 36—INSURANCE AND FINANCIAL

FOR REAL ESTATE AGENCIES; REAL ESTATE BROKERAGE; REAL ESTATE CONSULTANCY; REAL ESTATE CONSULTATION; REAL ESTATE LISTING; REAL ESTATE MULTIPLE LISTING SERVICES (U.S. CLS. 100, 101 AND 102).
STEVEN PEREZ, EXAMINING ATTORNEY

SN 78-863,781. PRESCRIPTION WELLBEING, NFP, CHICAGO, IL. FILED 4-18-2006.

PRESCRIPTION WELL-BEING

THE MARK CONSISTS OF STANDARD CHARACTERS WITHOUT CLAIM TO ANY PARTICULAR FONT, STYLE, SIZE, OR COLOR.

CLASS 36—INSURANCE AND FINANCIAL

FOR CHARITABLE FUND RAISING (U.S. CLS. 100, 101 AND 102).
FIRST USE 10-5-2001; IN COMMERCE 10-5-2001.

CLASS 44—MEDICAL, BEAUTY AND AGRICULTURAL SERVICES

FOR CHARITABLE SERVICES, NAMELY, PROVIDING HEALTH SPA SERVICES FOR HEALTH AND WELLNESS OF THE BODY AND SPIRIT AND BEAUTY AND HAIR CARE SERVICES FOR PEOPLE SUFFERING FROM CANCER OR OTHER LIFE THREATENING ILLNESSES (U.S. CLS. 100 AND 101).

FIRST USE 10-5-2001; IN COMMERCE 10-5-2001.
TONI HICKEY, EXAMINING ATTORNEY

SN 78-863,827. DOLPHIN QUEST, INC., MIDDLEBURG, VA.
FILED 4-18-2006.



OWNER OF U.S. REG. NOS. 2,600,953, 3,052,523 AND 3,061,757.

THE MARK CONSISTS OF STYLIZED DESIGN OF MOTHER DOLPHIN AND CALF AND WAVES.

CLASS 41—EDUCATION AND ENTERTAINMENT

FOR ENTERTAINMENT AND EDUCATION SERVICES, NAMELY, CONDUCTING INTERACTIVE PROGRAMS FOR ADULTS AND CHILDREN IN WHICH PARTICIPANTS INTERACT WITH DOLPHINS IN A MARINE ENVIRONMENT AND LEARN PRINCIPLES OF CONSERVATION AND PRESERVATION OF DOLPHINS AND THE MARINE ECOSYSTEM; CONDUCTING INTERACTIVE PROGRAMS FOR CHILDREN IN THE CLASSROOMS AT THE ELEMENTARY AND SECONDARY SCHOOL LEVELS IN THE FIELD OF CONSERVATION AND PRESERVATION OF DOLPHINS AND THE MARINE ECOSYSTEM; AND PROVIDING EDUCATIONAL CURRICULA, RESOURCE INFORMATION AND LESSON PLANS VIA THE INTERNET TO TEACHERS AND CLASSROOMS AT THE ELEMENTARY AND SECONDARY SCHOOL LEVELS, ALL CONCERNING CONSERVATION AND PRESERVATION OF DOLPHINS AND THE MARINE ECOSYSTEM (U.S. CLS. 100, 101 AND 107).

FIRST USE 2-1-2006; IN COMMERCE 2-1-2006.

CLASS 42—SCIENTIFIC, COMPUTER AND LEGAL SERVICES

FOR PROVIDING SCIENTIFIC RESEARCH INFORMATION VIA THE INTERNET ON THE SUBJECT OF CONSERVATION AND PRESERVATION OF DOLPHINS AND THE MARINE ECOSYSTEM (U.S. CLS. 100 AND 101).

FIRST USE 2-1-2006; IN COMMERCE 2-1-2006.
JOHN DWYER, EXAMINING ATTORNEY

SN 78-863,930. HELIX FINANCIAL SYSTEMS, L.P., NEW YORK, NY. FILED 4-18-2006.

HELIX FINANCIAL SYSTEMS

THE MARK CONSISTS OF STANDARD CHARACTERS WITHOUT CLAIM TO ANY PARTICULAR FONT, STYLE, SIZE, OR COLOR.

NO CLAIM IS MADE TO THE EXCLUSIVE RIGHT TO USE "FINANCIAL SYSTEMS", APART FROM THE MARK AS SHOWN.

CLASS 9—ELECTRICAL AND SCIENTIFIC APPARATUS

FOR COMPUTER SOFTWARE FOR USE BY FINANCIAL AND SECURITIES TRADERS AND TRADING INSTITUTIONS FOR TRADE MONITORING AND MANAGEMENT, NAMELY, ASSET MANAGEMENT, SECURITIES LENDING, BANKING AND MONETARY TRANSACTIONS, FINANCIAL TRADING, TRADE PROCESSING, TRADE FLOW ADMINISTRATION, REPURCHASE POSITION MANAGEMENT, REPURCHASE AGREEMENT POSITION MANAGEMENT, MORTGAGE ALLOCATION AND MANAGEMENT OF SECURED FINANCIAL COLLATERAL, TRADE SUPPORT, SECURITIES TRADER AND SELLER VERIFICATION AND IDENTIFICATION, FINANCIAL ANALYTICS, INSTANT PRICING, RISK ASSESSMENT AND ANALYSIS, MARGIN MANAGEMENT, AND FOR MARK-TO-MARKET AND PROFIT AND LOSS REPORTING (U.S. CLS. 21, 23, 26, 36 AND 38).

CLASS 38—COMMUNICATION

FOR PROVIDING ON-LINE COMMUNICATIONS LINKS BETWEEN FINANCIAL AND SECURITIES TRADERS FOR ELECTRONIC DATA TRANSMISSION (U.S. CLS. 100, 101 AND 104).

MARILYN IZZI, EXAMINING ATTORNEY

SN 78-863,968. ELIZABETH TRUCK CENTER INC., ELIZABETH, NJ. FILED 4-18-2006.



THE APPLICANT CLAIMS COLOR AS A FEATURE OF THE MARK, NAMELY, SILVER, GOLD, WHITE, RED AND BLACK.

THE MARK CONSISTS OF THE LETTERS "ETC" IN ADJACENT DECENDING CAPITAL LETTERS IN SILVER WITH RED AND BLACK OUTLINE OVER A GOLD SCROLL REATURING THE WORDS "CUSTOM CHROME SHOP" IN WHITE WITH BLACK OUTLINE.

CLASS 25—CLOTHING

FOR CAPS; HATS; SHIRTS; SWEAT SHIRTS (U.S. CLS. 22 AND 39).

FIRST USE 7-31-2004; IN COMMERCE 7-31-2004.

CLASS 35—ADVERTISING AND BUSINESS

FOR RETAIL STORES FEATURING AUTOMOTIVE ACCESSORIES (U.S. CLS. 100, 101 AND 102).
FIRST USE 7-31-2004; IN COMMERCE 7-31-2004.
GRETTA YAO, EXAMINING ATTORNEY

SN 78-863,983. ELIZABETH TRUCK CENTER INC., ELIZABETH, NJ. FILED 4-18-2006.



THE MARK CONSISTS OF THE LETTERS "ETC" IN ADJACENT DECENDING CAPITAL LETTERS.

CLASS 25—CLOTHING

FOR CAPS; HATS; SHIRTS; SWEAT SHIRTS (U.S. CLS. 22 AND 39).
FIRST USE 7-31-2004; IN COMMERCE 7-31-2004.

CLASS 35—ADVERTISING AND BUSINESS

FOR RETAIL STORES FEATURING AUTOMOTIVE ACCESSORIES (U.S. CLS. 100, 101 AND 102).
FIRST USE 7-31-2004; IN COMMERCE 7-31-2004.
GRETTA YAO, EXAMINING ATTORNEY

SN 78-864,111. HELIX FINANCIAL SYSTEMS, L.P., NEW YORK, NY. FILED 4-18-2006.



NO CLAIM IS MADE TO THE EXCLUSIVE RIGHT TO USE "FINANCIAL SYSTEMS", APART FROM THE MARK AS SHOWN.

CLASS 9—ELECTRICAL AND SCIENTIFIC APPARATUS

FOR COMPUTER SOFTWARE FOR USE BY FINANCIAL AND SECURITIES TRADERS AND TRADING INSTITUTIONS FOR TRADE MONITORING AND MANAGEMENT, NAMELY, ASSET MANAGEMENT, SECURITIES LENDING, BANKING AND MONETARY TRANSACTIONS, FINANCIAL TRADING, TRADE PROCESSING, TRADE FLOW ADMINISTRATION, REPURCHASE POSITION MANAGEMENT, REPURCHASE AGREEMENT POSITION MANAGEMENT, MORTGAGE ALLOCATION AND MANAGEMENT OF SECURED FINANCIAL COLLATERAL, TRADE SUPPORT, SECURITIES TRADER AND SELLER VERIFICATION AND IDENTIFICATION, FINANCIAL ANALYTICS, INSTANT PRICING, RISK ASSESSMENT AND ANALYSIS, MARGIN MANAGEMENT, AND FOR MARK-TO-MARKET AND PROFIT AND LOSS REPORTING (U.S. CLS. 21, 23, 26, 36 AND 38).

CLASS 38—COMMUNICATION

FOR PROVIDING ON-LINE COMMUNICATIONS LINKS BETWEEN FINANCIAL AND SECURITIES TRADERS FOR ELECTRONIC DATA TRANSMISSION (U.S. CLS. 100, 101 AND 104).
MARILYN IZZI, EXAMINING ATTORNEY

SN 78-864,126. MUSCO FOOD CORP., MASPETH, NY. FILED 4-18-2006.

VANTIA

THE MARK CONSISTS OF STANDARD CHARACTERS WITHOUT CLAIM TO ANY PARTICULAR FONT, STYLE, SIZE, OR COLOR.

CLASS 29—MEATS AND PROCESSED FOODS

FOR ANCHOVY PASTE; CANNED TOMATOES; CHEESE; EDIBLE OIL; FISH; MEAT; PROCESSED ANCHOVIES; PROCESSED MEAT; PROCESSED MUSHROOMS; PROCESSED OLIVES; PROCESSED VEGETABLES AND FRUITS; SALADS EXCEPT MACARONI, RICE, AND PASTA SALAD; TUNA FISH; VEGETABLE-BASED SPREADS (U.S. CL. 46).
FIRST USE 1-0-1993; IN COMMERCE 1-0-1993.

CLASS 30—STAPLE FOODS

FOR GNOCCHI; PASTA; POLENTA; RICE; SAUCES; SPICES; TOMATO SAUCE; VINEGAR (U.S. CL. 46).
FIRST USE 1-0-1993; IN COMMERCE 1-0-1993.
JOHN WILKE, EXAMINING ATTORNEY

SN 78-864,151. INTECON SYSTEMS, INC., SAN DIEGO, CA.
FILED 4-18-2006.

Binary Ionization Technology

THE MARK CONSISTS OF STANDARD CHARACTERS WITHOUT CLAIM TO ANY PARTICULAR FONT, STYLE, SIZE, OR COLOR.

NO CLAIM IS MADE TO THE EXCLUSIVE RIGHT TO USE "TECHNOLOGY", APART FROM THE MARK AS SHOWN.

SEC. 2(F) AS TO BINARY IONIZATION.

CLASS 1—CHEMICALS

FOR CHEMICALS FOR TREATING HAZARDOUS WASTE; CHEMICALS FOR USE IN THE DECONTAMINATION OF POLLUTED SITES (U.S. CLS. 1, 5, 6, 10, 26 AND 46).

FIRST USE 5-6-1999; IN COMMERCE 5-6-1999.

CLASS 7—MACHINERY

FOR POWER-OPERATED SPRAYERS (U.S. CLS. 13, 19, 21, 23, 31, 34 AND 35).

FIRST USE 5-6-1999; IN COMMERCE 5-6-1999.

CLASS 11—ENVIRONMENTAL CONTROL APPARATUS

FOR AIR PURIFICATION UNITS (U.S. CLS. 13, 21, 23, 31 AND 34).

FIRST USE 5-6-1999; IN COMMERCE 5-6-1999.

CLASS 40—MATERIAL TREATMENT

FOR DECONTAMINATION OF HAZARDOUS MATERIALS (U.S. CLS. 100, 103 AND 106).

FIRST USE 5-6-1999; IN COMMERCE 5-6-1999.

MARGERY A. TIERNEY, EXAMINING ATTORNEY

SN 78-864,227. ASSOCIATION OF THREAT ASSESSMENT PROFESSIONALS, INC., HUNTINGTON BEACH, CA.
FILED 4-18-2006.

ATAP

THE MARK CONSISTS OF STANDARD CHARACTERS WITHOUT CLAIM TO ANY PARTICULAR FONT, STYLE, SIZE, OR COLOR.

CLASS 35—ADVERTISING AND BUSINESS

FOR ASSOCIATION SERVICES, NAMELY, PROMOTING THE INTERESTS OF INDIVIDUALS AND GROUPS WITH AN INTEREST IN THE FIELDS OF THREAT ASSESSMENT, THREAT MANAGEMENT, PUBLIC AND PRIVATE LAW ENFORCEMENT, AND PERSONAL SECURITY (U.S. CLS. 100, 101 AND 102).

FIRST USE 6-30-1995; IN COMMERCE 6-30-1995.

CLASS 41—EDUCATION AND ENTERTAINMENT

FOR PUBLICATION OF BOOKS, GUIDES, AND MANUALS IN THE FIELDS OF THREAT ASSESSMENT, THREAT MANAGEMENT, PUBLIC AND PRIVATE LAW ENFORCEMENT, AND PERSONAL SECURITY; EDUCATIONAL SERVICES, NAMELY CONDUCTING MEETINGS, CONFERENCES, SEMINARS, WORKSHOPS, AND CLASSES, IN THE FIELDS OF THREAT ASSESSMENT, THREAT MANAGEMENT, PUBLIC AND PRIVATE LAW ENFORCEMENT, AND PERSONAL SECURITY (U.S. CLS. 100, 101 AND 107).

FIRST USE 6-30-1995; IN COMMERCE 6-30-1995.

SHARON MEIER, EXAMINING ATTORNEY

SN 78-864,246. COATES, TRACY, PAHRUMP, NV. FILED 4-18-2006.



CLASS 16—PAPER GOODS AND PRINTED MATTER

FOR PAPER GOODS AND PRINTED MATTER NAMELY STICKERS AND POSTERS (U.S. CLS. 2, 5, 22, 23, 29, 37, 38 AND 50).

FIRST USE 1-1-2003; IN COMMERCE 1-1-2003.

CLASS 25—CLOTHING

FOR CLOTHING, NAMELY HATS, PANTS, T-SHIRTS, PANTIES, BOXER SHORTS, LINGERIE, SWEATERS, SHOES, SWIM SUITS (U.S. CLS. 22 AND 39).

FIRST USE 1-1-2003; IN COMMERCE 1-1-2003.

CLASS 35—ADVERTISING AND BUSINESS

FOR RETAIL STORE SERVICES FEATURING TOBACCO AND TOBACCO ACCESSORIES (U.S. CLS. 100, 101 AND 102).

FIRST USE 1-1-2003; IN COMMERCE 1-1-2003.

CLASS 44—MEDICAL, BEAUTY AND AGRICULTURAL SERVICES

FOR SERVICES, NAMELY TATTOOING AND BODY PIERCING SERVICES (U.S. CLS. 100 AND 101).

FIRST USE 1-1-2003; IN COMMERCE 1-1-2003.

NICHOLAS ALTREE, EXAMINING ATTORNEY

SN 78-864,505. HAVEN, TEENA, DESTIN, FL. FILED 4-19-2006.

SN 78-864,628. DRAPER KNITTING COMPANY, INC., CANTON, MA. FILED 4-19-2006.

DESTIN - THE HAMPTONS OF THE SOUTH

THE MARK CONSISTS OF STANDARD CHARACTERS WITHOUT CLAIM TO ANY PARTICULAR FONT, STYLE, SIZE, OR COLOR.

NO CLAIM IS MADE TO THE EXCLUSIVE RIGHT TO USE "DESTIN", APART FROM THE MARK AS SHOWN.

CLASS 18—LEATHER GOODS

FOR TOTE BAGS (U.S. CLS. 1, 2, 3, 22 AND 41).

CLASS 25—CLOTHING

FOR T-SHIRTS (U.S. CLS. 22 AND 39).
DANIEL RUSSELL, EXAMINING ATTORNEY

SN 78-864,512. INTERFACE, INC., ATLANTA, GA. FILED 4-19-2006.

MISSION ZERO

THE MARK CONSISTS OF STANDARD CHARACTERS WITHOUT CLAIM TO ANY PARTICULAR FONT, STYLE, SIZE, OR COLOR.

CLASS 3—COSMETICS AND CLEANING PREPARATIONS

FOR CARPET CLEANING PREPARATIONS (U.S. CLS. 1, 4, 6, 50, 51 AND 52).

CLASS 5—PHARMACEUTICALS

FOR ANTIMICROBIAL PREPARATIONS FOR USE IN THE TREATMENT, SANITATION, AND DISINFECTING OF CARPETS AND FABRICS (U.S. CLS. 6, 18, 44, 46, 51 AND 52).

CLASS 24—FABRICS

FOR TEXTILE FABRICS FOR USE IN THE MANUFACTURE OF UPHOLSTERY, OFFICE PARTITION PANELS AND SCREENS, CEILING COVERS, AND WALL HANGINGS (U.S. CLS. 42 AND 50).

CLASS 27—FLOOR COVERINGS

FOR CARPETING (U.S. CLS. 19, 20, 37, 42 AND 50).

CLASS 37—CONSTRUCTION AND REPAIR

FOR INSTALLATION AND MAINTENANCE OF CARPET (U.S. CLS. 100, 103 AND 106).
KATHRYN COWARD, EXAMINING ATTORNEY

DRAPER CANINE THERAPY

THE MARK CONSISTS OF STANDARD CHARACTERS WITHOUT CLAIM TO ANY PARTICULAR FONT, STYLE, SIZE, OR COLOR.

NO CLAIM IS MADE TO THE EXCLUSIVE RIGHT TO USE "CANINE THERAPY", APART FROM THE MARK AS SHOWN.

CLASS 18—LEATHER GOODS

FOR DOG PARKAS (U.S. CLS. 1, 2, 3, 22 AND 41).
FIRST USE 2-1-2006; IN COMMERCE 2-1-2006.

CLASS 20—FURNITURE AND ARTICLES NOT OTHERWISE CLASSIFIED

FOR DOG BEDS (U.S. CLS. 2, 13, 22, 25, 32 AND 50).
FIRST USE 2-1-2006; IN COMMERCE 2-1-2006.
DOMINIC FATHY, EXAMINING ATTORNEY

SN 78-864,798. GREENBUSH LOGISTICS, INC., ABBEVILLE, AL. FILED 4-19-2006.



OWNER OF U.S. REG. NO. 3,109,851.

CLASS 35—ADVERTISING AND BUSINESS

FOR TRANSPORTATION LOGISTICS SERVICES, NAMELY, ARRANGING THE TRANSPORTATION OF GOODS FOR OTHERS; TRANSPORTATION LOGISTICS SERVICES, NAMELY, PLANNING AND SCHEDULING SHIPMENTS FOR USERS OF TRANSPORTATION SERVICES (U.S. CLS. 100, 101 AND 102).

CLASS 39—TRANSPORTATION AND STORAGE

FOR FREIGHT TRANSPORTATION BY MEANS OF TRUCKS; SUPPLY CHAIN, LOGISTICS AND REVERSE LOGISTICS SERVICES, NAMELY, STORAGE, TRANSPORTATION AND DELIVERY OF DOCUMENTS, PACKAGES, RAW MATERIALS, AND OTHER FREIGHT FOR OTHERS BY AIR, RAIL, SHIP OR TRUCK (U.S. CLS. 100 AND 105).
RUDY R. SINGLETON, EXAMINING ATTORNEY

SN 78-865,057. THE CLOROX COMPANY, OAKLAND, CA.
FILED 4-19-2006.

DEDICATED TO A HEALTHIER
WORLD

THE MARK CONSISTS OF STANDARD CHARACTERS
WITHOUT CLAIM TO ANY PARTICULAR FONT, STYLE,
SIZE, OR COLOR.

CLASS 3—COSMETICS AND CLEANING PREPARATIONS

FOR HOUSEHOLD AND LAUNDRY BLEACH; LIQUID ALL FABRIC BLEACH; BLEACHING POWDER; LAUNDRY SOIL AND STAIN REMOVER; TOILET BOWL CLEANER; AUTOMATIC TOILET BOWL CLEANER; ALL-PURPOSE HOUSEHOLD AND COMMERCIAL CLEANERS (U.S. CLS. 1, 4, 6, 50, 51 AND 52).

CLASS 5—PHARMACEUTICALS

FOR ALL-PURPOSE HOUSEHOLD AND COMMERCIAL DISINFECTANTS; ALL-PURPOSE DISINFECTANT SPRAY; TOILET BOWL DISINFECTANT; DISPOSABLE WIPES IMPREGNATED WITH DISINFECTING CHEMICALS FOR HOUSEHOLD CLEANING USE (U.S. CLS. 6, 18, 44, 46, 51 AND 52).

MARLENE BELL, EXAMINING ATTORNEY

SN 78-865,333. ERIC P WIKOFF, DESOTO, TX. FILED 4-19-2006.



THE COLOR(S) GREY, WHITE AND BLACK IS/ARE CLAIMED AS A FEATURE OF THE MARK.

THE MARK CONSISTS OF STATE OF TEXAS COLORED GREY ON A BLACK BACKGROUND WITH THE WORDS "CERTIFIED" IN GREY, SMALL CAPITALIZED LETTERS AND IN LARGER GREY CAPITAL LETTERS "G"Z" ACROSS THE EMBLEM. THE CAPITAL LETTER G IN G'Z HAS A WHITE SPOT THROUGHOUT THE CENTER.

CLASS 9—ELECTRICAL AND SCIENTIFIC APPARATUS

FOR MUSICAL VIDEO RECORDINGS; SOUND RECORDINGS FEATURING MUSIC; VIDEO RECORDINGS FEATURING MUSIC (U.S. CLS. 21, 23, 26, 36 AND 38).

CLASS 35—ADVERTISING AND BUSINESS

FOR ADVERTISING PARTICULARLY SERVICES FOR THE PROMOTION OF GOODS; ADVERTISING VIA ELECTRONIC MEDIA AND SPECIFICALLY THE INTERNET; DISTRIBUTION OF PRODUCTS FOR ADVERTISING PURPOSES; PRODUCT MERCHANDISING; PROMOTION, ADVERTISING AND MARKETING OF ON-LINE WEBSITES; PROVIDING A WEB SITE WHICH FEATURES ADVERTISEMENTS FOR THE GOODS AND SERVICES OF OTHERS ON A GLOBAL COMPUTER NETWORK; PROVIDING SPACE AT A WEB SITE FOR THE ADVERTISEMENT OF THE GOODS AND SERVICES OF OTHERS (U.S. CLS. 100, 101 AND 102).

PAM WILLIS, EXAMINING ATTORNEY

SN 78-865,343. FELDMAN, PETER M., DEL MAR, CA. FILED 4-19-2006.

AVAILABILITY MARKETING

THE MARK CONSISTS OF STANDARD CHARACTERS WITHOUT CLAIM TO ANY PARTICULAR FONT, STYLE, SIZE, OR COLOR.

NO CLAIM IS MADE TO THE EXCLUSIVE RIGHT TO USE "MARKETING", APART FROM THE MARK AS SHOWN.

CLASS 35—ADVERTISING AND BUSINESS

FOR ADVERTISING AND COMMERCIAL INFORMATION SERVICES, VIA THE INTERNET; ADVERTISING AND MARKETING; ADVERTISING VIA ELECTRONIC MEDIA AND SPECIFICALLY THE INTERNET; ADVERTISING, MARKETING AND PROMOTION SERVICES (U.S. CLS. 100, 101 AND 102).

FIRST USE 4-13-2006; IN COMMERCE 4-13-2006.

CLASS 42—SCIENTIFIC, COMPUTER AND LEGAL SERVICES

FOR COMPUTER SERVICE, NAMELY, ACTING AS AN APPLICATION SERVICE PROVIDER IN THE FIELD OF KNOWLEDGE MANAGEMENT TO HOST COMPUTER APPLICATION SOFTWARE FOR SEARCHING AND RETRIEVING INFORMATION FROM DATABASES AND COMPUTER NETWORKS (U.S. CLS. 100 AND 101).

FIRST USE 4-13-2006; IN COMMERCE 4-13-2006.

ARETHA SOMERVILLE, EXAMINING ATTORNEY

SN 78-865,358. WIKOFF, ERIC P, DESOTO, TX. FILED 4-19-2006.

CERTIFIED ENTERTAINMENT

THE MARK CONSISTS OF STANDARD CHARACTERS WITHOUT CLAIM TO ANY PARTICULAR FONT, STYLE, SIZE, OR COLOR.

NO CLAIM IS MADE TO THE EXCLUSIVE RIGHT TO USE "ENTERTAINMENT", APART FROM THE MARK AS SHOWN.

CLASS 9—ELECTRICAL AND SCIENTIFIC APPARATUS

FOR AUDIO RECORDINGS FEATURING MUSIC; MUSICAL SOUND RECORDINGS; MUSICAL VIDEO RECORDINGS; SOUND RECORDINGS FEATURING MUSIC; VIDEO RECORDINGS FEATURING MUSIC (U.S. CLS. 21, 23, 26, 36 AND 38).

CLASS 35—ADVERTISING AND BUSINESS

FOR ADVERTISING AND PROMOTION SERVICES AND RELATED CONSULTING; ADVERTISING PARTICULARLY SERVICES FOR THE PROMOTION OF GOODS; ADVERTISING, MARKETING AND PROMOTION SERVICES; MODELING FOR ADVERTISING OR SALES PROMOTION; MODELING SERVICES FOR ADVERTISING OR SALES PROMOTION; ON-LINE RETAIL STORE SERVICES FEATURING DOWNLOADABLE PRE-RECORDED MUSIC AND VIDEO; PERSONAL MANAGEMENT SERVICES FOR MUSICAL PERFORMERS; PREPARING PROMOTIONAL AND MERCHANDISING MATERIAL FOR OTHERS; PRODUCT MERCHANDISING; PROMOTING THE CONCERTS OF OTHERS; PROMOTING THE GOODS AND SERVICES OF OTHERS BY PROVIDING A WEB SITE AT WHICH USERS CAN LINK TO MUSIC; PROMOTING THE GOODS AND SERVICES OF OTHERS BY PROVIDING HYPERTEXT LINKS TO THE WEB SITES OF OTHERS; PROMOTING THE PARTIES AND SPECIAL EVENTS OF OTHERS; PROMOTION AND MARKETING SERVICES AND RELATED CONSULTING; PROMOTION USING AUDIOVISUAL MEDIA; RETAIL MUSIC AND RECORD STORES (U.S. CLS. 100, 101 AND 102).

CLASS 41—EDUCATION AND ENTERTAINMENT

FOR COMPOSITION OF MUSIC FOR OTHERS; ENTERTAINMENT IN THE NATURE OF VISUAL AND AUDIO PERFORMANCES, NAMELY, MUSICAL BAND, ROCK GROUP, GYMNASIAC, DANCE, AND BALLET PERFORMANCES; ENTERTAINMENT IN THE NATURE OF MUSICAL GROUP; ENTERTAINMENT NAMELY, LIVE PERFORMANCES BY A MUSICAL BAND; ENTERTAINMENT SERVICES, NAMELY, PROVIDING A WEB SITE FEATURING MUSICAL PERFORMANCES, MUSICAL VIDEOS, RELATED FILM CLIPS, PHOTOGRAPHS, AND OTHER MULTIMEDIA MATERIALS; ENTERTAINMENT, NAMELY LIVE MUSIC CONCERTS; ENTERTAINMENT, NAMELY LIVE PERFORMANCES BY MUSICAL BANDS; MUSIC PRODUCTION SERVICES; MUSIC PUBLISHING SERVICES; PLANNING ARRANGEMENT OF SHOWING MOVIES, SHOWS, PLAYS OR MUSICAL PERFORMANCES; PRESENTATION OF MUSICAL PERFORMANCE; RECORD MASTER PRODUCTION; RECORD PRODUCTION (U.S. CLS. 100, 101 AND 107).

ARETHA SOMERVILLE, EXAMINING ATTORNEY

SN 78-865,388. VICTOR INNOVATEX, INC. SAINT-GEORGES, QUEBEC, CANADA, FILED 4-20-2006.



VICTOR

THE MARK CONSISTS OF A STYLIZED LETTER "V" IN A DARK OVAL ABOVE THE WORD "VICTOR".

CLASS 24—FABRICS

FOR COMMERCIAL AND UPHOLSTERY FABRICS FOR OFFICE FURNITURE SYSTEMS AND SEATING (U.S. CLS. 42 AND 50).

FIRST USE 10-0-2003; IN COMMERCE 10-0-2003.

CLASS 40—MATERIAL TREATMENT

FOR MANUFACTURING ENVIRONMENTAL-FRIENDLY FABRIC FOR OFFICE FURNITURE MANUFACTURERS FOLLOWING A PROGRAM AIMED TOWARDS SUSTAINING AND SAFEGUARDING THE ENVIRONMENT; CONSULTING SERVICES FOR OFFICE FURNITURE MANUFACTURERS WISHING TO WORK WITH SUPPLIERS AND CONSULTANTS WHO ALSO WORK TO SUSTAIN AND PROTECT THE ENVIRONMENT (U.S. CLS. 100, 103 AND 106).

FIRST USE 10-0-2003; IN COMMERCE 10-0-2003.

HOWARD B. LEVINE, EXAMINING ATTORNEY

SN 78-865,460. AMERICAN CITY BUSINESS JOURNALS, INC., CHARLOTTE, NC. FILED 4-20-2006.



OWNER OF U.S. REG. NOS. 1,175,109, 1,557,943 AND OTHERS.

SEC. 2(F) AS TO SPORTING NEWS.

CLASS 16—PAPER GOODS AND PRINTED MATTER

FOR PRINTED PUBLICATIONS, NAMELY, MAGAZINES IN THE FIELD OF PROFESSIONAL AND AMATEUR SPORTS, AND SPORTS NEWS, SCORES AND STATISTICS; AND BOOKS PUBLISHED ANNUALLY, IN THE FIELD OF PROFESSIONAL AND AMATEUR SPORTS, AND SPORTS NEWS, SCORES AND STATISTICS (U.S. CLS. 2, 5, 22, 23, 29, 37, 38 AND 50).

FIRST USE 4-7-2006; IN COMMERCE 4-7-2006.

CLASS 38—COMMUNICATION

FOR RADIO BROADCASTING AND PODCASTING IN THE FIELD OF PROFESSIONAL AND AMATEUR SPORTS, AND SPORTS NEWS, SCORES AND STATISTICS (U.S. CLS. 100, 101 AND 104).

FIRST USE 3-31-2006; IN COMMERCE 3-21-2006.

CLASS 41—EDUCATION AND ENTERTAINMENT

FOR PROVIDING A WEBSITE FEATURING INFORMATION ABOUT PROFESSIONAL AND AMATEUR SPORTS, AND SPORTS NEWS, SCORES AND STATISTICS; ENTERTAINMENT SERVICES IN THE NATURE OF RADIO, TELEVISION AND INTERACTIVE TELEVISION PROGRAMS IN THE FIELD OF PROFESSIONAL AND AMATEUR SPORTS, SPORTS NEWS, SCORES AND STATISTICS (U.S. CLS. 100, 101 AND 107).

FIRST USE 3-31-2006; IN COMMERCE 3-31-2006.

HEATHER THOMPSON, EXAMINING ATTORNEY

SN 78-865,611. SQS SOLUTIONS INC., LONG LAKE, MN. FILED 4-20-2006.

SN 78-865,938. MARTIN-COOK, DIANA DAWN, SAN DIEGO, CA. FILED 4-20-2006.

NO EXCUSE

Branola

THE MARK CONSISTS OF STANDARD CHARACTERS WITHOUT CLAIM TO ANY PARTICULAR FONT, STYLE, SIZE, OR COLOR.

THE MARK CONSISTS OF STANDARD CHARACTERS WITHOUT CLAIM TO ANY PARTICULAR FONT, STYLE, SIZE, OR COLOR.

CLASS 16—PAPER GOODS AND PRINTED MATTER

FOR PRINTED INSTRUCTIONAL MATERIALS, WORKBOOKS AND MANUALS FOR MANAGEMENT AND EFFECTIVE CORPORATE ORGANIZATIONAL TRAINING (U.S. CLS. 2, 5, 22, 23, 29, 37, 38 AND 50).

CLASS 5—PHARMACEUTICALS

FOR BISCUITS, BREAD, BREAD ROLLS, CAKES, CEREAL PRODUCTS, CONFECTIONERY, CRACKERS, NOODLES, FISH SAUCE, RELISH, SAUCES, CEREAL-BASED SNACK-FOODS AND PREPARED DIETARY ITEMS THAT ARE GLUTEN-FREE TO ACCOMMODATE SPECIAL MEDICAL AND HEALTH CONDITIONS; DIETARY FIBER AS AN ADDITIVE FOR FOOD PRODUCTS (U.S. CLS. 6, 18, 44, 46, 51 AND 52).

CLASS 41—EDUCATION AND ENTERTAINMENT

FOR EDUCATIONAL SERVICES, NAMELY WORKSHOP AND SEMINARS IN THE FIELD OF EFFECTIVE MANAGEMENT AND CORPORATE ORGANIZATIONAL TRAINING (U.S. CLS. 100, 101 AND 107). KEVIN CORWIN, EXAMINING ATTORNEY

CLASS 16—PAPER GOODS AND PRINTED MATTER

FOR PRINTED RECIPES SOLD AS A COMPONENT OF FOOD PACKAGING (U.S. CLS. 2, 5, 22, 23, 29, 37, 38 AND 50).

CLASS 30—STAPLE FOODS

FOR CEREAL BASED SNACK FOOD; CEREAL-BASED SNACK FOODS; GRAIN-BASED FOOD BARS ALSO CONTAINING NUTS, SEEDS, DRIED FRUIT; READY TO EAT, CEREAL DERIVED FOOD BARS (U.S. CL. 46). JEFF DEFORD, EXAMINING ATTORNEY

SN 78-865,791. PAPER PAYMENT SERVICES, LLC, SHOREVIEW, MN. FILED 4-20-2006.

SN 78-865,954. SQUEEM CORPORATION, ORLANDO, FL. FILED 4-20-2006.

SIMPLE TRADITIONS

CONTROLFIT

THE MARK CONSISTS OF STANDARD CHARACTERS WITHOUT CLAIM TO ANY PARTICULAR FONT, STYLE, SIZE, OR COLOR.

THE MARK CONSISTS OF STANDARD CHARACTERS WITHOUT CLAIM TO ANY PARTICULAR FONT, STYLE, SIZE, OR COLOR.

CLASS 16—PAPER GOODS AND PRINTED MATTER

FOR GREETING CARDS (U.S. CLS. 2, 5, 22, 23, 29, 37, 38 AND 50).

CLASS 10—MEDICAL APPARATUS

FOR ORTHOPEDIC SUPPORTS (U.S. CLS. 26, 39 AND 44).

CLASS 35—ADVERTISING AND BUSINESS

FOR RETAIL STORE SERVICES, NAMELY, MAIL ORDER CATALOG SERVICES, COMPUTERIZED ONLINE ORDERING SERVICES, DIRECT MAIL ADVERTISING, AND DISTRIBUTORSHIP SERVICES FEATURING STATIONERY, NAMELY GREETING CARDS, ENVELOPES, AND POSTCARDS, AND BUSINESS PROMOTIONAL AND COLLECTIBLE ITEMS, NAMELY, A WIDE VARIETY OF CUSTOMIZED PROMOTIONAL ITEMS IMPRINTED WITH COMPANY NAMES AND LOGOS (U.S. CLS. 100, 101 AND 102). MELVIN AXILBUND, EXAMINING ATTORNEY

CLASS 25—CLOTHING

FOR CORSETS; FOUNDATION GARMENTS; GIRDLES (U.S. CLS. 22 AND 39). JEFF DEFORD, EXAMINING ATTORNEY

SN 78-865,969. CHATEAU INTERNATIONAL, INC., NEW YORK, NY. FILED 4-20-2006.



THE LINING IS A FEATURE OF THE MARK AND DOES NOT INDICATE COLOR.

THE NAME GRACIE ROBERTS DOES NOT IDENTIFY A LIVING INDIVIDUAL.

CLASS 3—COSMETICS AND CLEANING PREPARATIONS

FOR PERFUMES AND COSMETICS, NAMELY ARTIFICIAL FINERGNAILS, ARTIFICIAL EYELASHES, SUNSCREENS, AFTER-SUN LOTIONS, ANTI-AGING CREAMS, HAIR SHAMPOOS, HAIR CONDITIONERS, HAIR BLEACHING PREPARATIONS, HAIR SPRAYS, LIPSTICKS, FACIAL MAKEUP, BODY POWDERS, BEAUTY MASKS, COSMETIC PENCILS, EYE MAKEUP, SKIN CREAMS, EYE CREAMS, PERSONAL DEODORANTS, ANTIPERSPIRANTS, DEPILATORIES, HAIR DYES, EMERY BOARDS, NAIL CARE PREPARATIONS, ENAMEL FOR NAILS, COLOGNES AND AFTER SHAVE LOTIONS (U.S. CLS. 1, 4, 6, 50, 51 AND 52).

CLASS 9—ELECTRICAL AND SCIENTIFIC APPARATUS

FOR EYEGLASS FRAMES, SUNGLASSES, EYEGLASS CHAINS, EYEGLASS CASES AND EYEGLASS CLEANING CLOTHS ENCLOSED THEREIN; CONTACT LENS CASES; CONTACT LENS BLANKS, CONTAINERS FOR CONTACT LENSES (U.S. CLS. 21, 23, 26, 36 AND 38).

CLASS 14—JEWELRY

FOR JEWELRY, NAMELY ANKLE BRACELETS, AMULETS, BEADS FOR USE IN PIERCING, BELLY RINGS, BRACELETS, BROOCHES, CHAINS, CHARMS, COSTUME JEWELRY, CROSSES, EARRINGS, IDENTIFICATION BRACELETS, LAPEL PINS, NECKLACES, PENDANTS, JEWELRY PINS FOR USE ON HATS, RINGS, KEY CHAINS OF PRECIOUS METAL; WATCHES FOR MEN, WOMEN AND CHILDREN (U.S. CLS. 2, 27, 28 AND 50).

CLASS 18—LEATHER GOODS

FOR LEATHER GOODS, NAMELY LUGGAGE, HANDBAGS, POCKETBOOKS, SHOULDER BAGS, PURSES, WALLETS, BILLFOLDS, FRENCH PURSES, ATHLETIC BAGS, ATTACHE CASES, BRIEFCASE-TYPE PORTFOLIOS; BACKPACKS, MINI BACKPACKS, RUCKSACKS AND HAVERSACKS; WAIST PACKS AND FANNY PACKS; CARRYALLS, BUSINESS CARD CASES, CREDIT CARD CASES, KEY CASES, CHANGE PURSES, CLUTCH BAGS AND PURSES, UMBRELLAS, OVERNIGHT BAGS AND CASES, VANITY CASES SOLD EMPTY, COSMETIC CASES SOLD EMPTY; SUITCASES, CARRY-ON BAGS, CARRY-ON LUGGAGE, DUFFEL BAGS, SUIT BAGS, GARMENT BAGS AND TRUNKS FOR TRAVEL, SPORTS BAGS, CARRY-ALL BAGS AND TRAVEL BAGS, SOLD EMPTY, FOR ENCLOSING COSMETICS, TOILETRIES, LOTIONS, TOOTH BRUSHES AND TOOTHPASTE; LEATHER KEY CHAINS (U.S. CLS. 1, 2, 3, 22 AND 41).

CLASS 25—CLOTHING

FOR CLOTHING FOR MEN, WOMEN AND CHILDREN, NAMELY BELTS, TIES, SCARVES, HOSIERY, SOCKS, LEGGINGS, STOCKINGS, PANTYHOSE, PANTS, JACKETS, COATS, SHIRTS, SKIRTS, DRESSES, GOWNS, SUITS, JEANS, JUMPERS, OVERALLS, JUMPSUITS, SHORTS, SHOES, BOOTS AND SLIPPERS, VESTS, HATS, CAPS AND SWIMSUITS (U.S. CLS. 22 AND 39).

JOHN E. MICHOS, EXAMINING ATTORNEY

SN 78-866,209. KING'S COUNTRY SHOPPES, INC., DBA KING'S FAMILY RESTAURANTS, MCKEESPORT, PA. FILED 4-20-2006.



THE MARK CONSISTS OF A FACE COMPRISING TWO EYES AND A FROWNING MOUTH CLOSED ON ONE SIDE AND OPEN ON THE OTHER SIDE.

CLASS 6—METAL GOODS

FOR METAL HOLIDAY ORNAMENTS; METAL KEY CHAINS; METAL RINGS AND CHAINS FOR KEYS (U.S. CLS. 2, 12, 13, 14, 23, 25 AND 50).

CLASS 14—JEWELRY

FOR ORNAMENTAL LAPEL PINS; ORNAMENTAL PINS; WATCHES; WRIST WATCHES (U.S. CLS. 2, 27, 28 AND 50).

CLASS 16—PAPER GOODS AND PRINTED MATTER

FOR DECALS; DECORATIVE PENCIL-TOP ORNAMENTS; PARTY ORNAMENTS OF PAPER; PENCIL ORNAMENTS (STATIONERY); TEMPORARY TATTOOS (U.S. CLS. 2, 5, 22, 23, 29, 37, 38 AND 50).

CLASS 21—HOUSEWARES AND GLASS

FOR CHINA ORNAMENTS; HOLIDAY ORNAMENTS OF CERAMIC; HOLIDAY ORNAMENTS OF PORCELAIN; MUGS; PLASTIC WATER BOTTLES SOLD EMPTY (U.S. CLS. 2, 13, 23, 29, 30, 33, 40 AND 50).

CLASS 25—CLOTHING

FOR BOXER SHORTS; CAPS; CHILDREN'S AND INFANTS' CLOTH BIBS; HATS; SHORT-SLEEVED OR LONG-SLEEVED T-SHIRTS; SWEAT SHIRTS; TOPS (U.S. CLS. 22 AND 39).

CLASS 28—TOYS AND SPORTING GOODS

FOR CHRISTMAS TREE ORNAMENTS; STRESS RELIEF BALLS FOR HAND EXERCISE; STUFFED DOLLS AND ANIMALS; TOY WATCHES (U.S. CLS. 22, 23, 38 AND 50).

MONIQUE MILLER, EXAMINING ATTORNEY

SN 78-866,775. SALON SANTIAGO, INC., FORT LAUDERDALE, FL. FILED 4-21-2006.



THE MARK CONSISTS OF TWO UNIQUE STYLIZED OVERLAPPING CURVES CENTERED MOSTLY WITHIN AN ELLIPSE.

CLASS 3—COSMETICS AND CLEANING PREPARATIONS

FOR HAIR CARE PREPARATIONS (U.S. CLS. 1, 4, 6, 50, 51 AND 52).
FIRST USE 7-0-2005; IN COMMERCE 7-30-2005.

CLASS 44—MEDICAL, BEAUTY AND AGRICULTURAL SERVICES

FOR HAIR CARE AND SALON SERVICES, NAMELY, BEAUTY SALONS, HAIR CUTTING, HAIR STYLING, MANICURES, AND PEDICURES (U.S. CLS. 100 AND 101).
FIRST USE 4-0-2002; IN COMMERCE 4-0-2002.
BARBARA A. LOUGHRAN, EXAMINING ATTORNEY

SN 78-866,790. VMDIRECT, LLC, LAS VEGAS, NV. FILED 4-21-2006.

DIGITAL LIFE MADE SIMPLE

THE MARK CONSISTS OF STANDARD CHARACTERS WITHOUT CLAIM TO ANY PARTICULAR FONT, STYLE, SIZE, OR COLOR.

CLASS 35—ADVERTISING AND BUSINESS

FOR DISSEMINATION OF ADVERTISING AND ADVERTISING MATERIAL, NAMELY, LIVE AND RECORDED ADVERTISEMENT MESSAGES FOR OTHERS VIA AN ONLINE ELECTRONIC COMMUNICATIONS NETWORK; OPERATING ON-LINE MARKETPLACES FOR SELLERS OF GOODS AND/OR SERVICES (U.S. CLS. 100, 101 AND 102).

CLASS 38—COMMUNICATION

FOR WEBCASTING SERVICES FEATURING AUDIO/VISUAL PROGRAMMING IN THE AREAS OF SPORTS, RADIO, TELEVISION, ENTERTAINMENT, CORPORATE, BUSINESS, PERSONAL, AND MUSIC EVENTS AND TALK SHOWS; ELECTRONIC TRANSMISSION OF LIVE, PRERECORDED AND INTERACTIVE PICTURES, VIDEO, TEXT AND AUDIO OVER A GLOBAL COMPUTER NETWORK; ELECTRONIC STORE-AND-FORWARD MESSAGING (U.S. CLS. 100, 101 AND 104).
JACQUELINE A. LAVINE, EXAMINING ATTORNEY

SN 78-866,793. WINDOW FILM DEPOT, INC., MARIETTA, GA. FILED 4-21-2006.

WINDOW FILM DEPOT

THE MARK CONSISTS OF STANDARD CHARACTERS WITHOUT CLAIM TO ANY PARTICULAR FONT, STYLE, SIZE, OR COLOR.

NO CLAIM IS MADE TO THE EXCLUSIVE RIGHT TO USE "WINDOW FILM", APART FROM THE MARK AS SHOWN.

CLASS 35—ADVERTISING AND BUSINESS

FOR DISTRIBUTORSHIPS IN THE FIELD OF POLYESTER FILM AND OTHER WINDOW COVERING SYSTEMS FOR COMMERCIAL AND RESIDENTIAL APPLICATIONS; RETAIL STORES FEATURING POLYESTER FILM AND OTHER WINDOW COVERING SYSTEMS FOR COMMERCIAL AND RESIDENTIAL APPLICATIONS (U.S. CLS. 100, 101 AND 102).
FIRST USE 1-1-2004; IN COMMERCE 1-1-2004.

CLASS 37—CONSTRUCTION AND REPAIR

FOR INSTALLATION, MAINTENANCE AND REPAIR OF POLYESTER FILM AND OTHER WINDOW COVERING SYSTEMS FOR COMMERCIAL AND RESIDENTIAL APPLICATIONS (U.S. CLS. 100, 103 AND 106).
FIRST USE 1-1-2004; IN COMMERCE 1-1-2004.
JACQUELINE A. LAVINE, EXAMINING ATTORNEY

SN 78-866,946. HILDEGARD PUBLISHING COMPANY, BRYN MAWR, PA. FILED 4-21-2006.

HILDEGARD PUBLISHING COMPANY

THE MARK CONSISTS OF STANDARD CHARACTERS WITHOUT CLAIM TO ANY PARTICULAR FONT, STYLE, SIZE, OR COLOR.

NO CLAIM IS MADE TO THE EXCLUSIVE RIGHT TO USE "PUBLISHING COMPANY", APART FROM THE MARK AS SHOWN.

CLASS 16—PAPER GOODS AND PRINTED MATTER

FOR PRINTED MATERIALS, NAMELY, SHEET MUSIC, MUSIC CATALOGUES, AND PARTIALLY PRINTED BUSINESS FORMS (U.S. CLS. 2, 5, 22, 23, 29, 37, 38 AND 50).

FIRST USE 9-0-1990; IN COMMERCE 9-0-1990.

CLASS 41—EDUCATION AND ENTERTAINMENT

FOR PUBLISHING WORKS OF MUSIC COMPOSED BY WOMEN (U.S. CLS. 100, 101 AND 107).

FIRST USE 10-0-1989; IN COMMERCE 4-0-1990.
ANDREW RHIM, EXAMINING ATTORNEY

SN 78-866,998. STA TRAVEL, INC., LOS ANGELES, CA.
FILED 4-21-2006.

THE STUDENT EXPERIENCE

THE MARK CONSISTS OF STANDARD CHARACTERS WITHOUT CLAIM TO ANY PARTICULAR FONT, STYLE, SIZE, OR COLOR.

NO CLAIM IS MADE TO THE EXCLUSIVE RIGHT TO USE "STUDENT", APART FROM THE MARK AS SHOWN.

CLASS 39—TRANSPORTATION AND STORAGE

FOR TRAVEL AGENCY SERVICES THROUGH A GLOBAL COMPUTER NETWORK, NAMELY, MAKING RESERVATIONS AND BOOKINGS FOR TRANSPORTATION, ARRANGING TRAVEL TOURS, PROVIDING TRAVEL INFORMATION SERVICES, AND TRAVEL GUIDE SERVICES (U.S. CLS. 100 AND 105).

FIRST USE 4-10-2006; IN COMMERCE 4-10-2006.

CLASS 43—HOTEL AND RESTAURANT SERVICES

FOR TRAVEL AGENCY SERVICES THROUGH A GLOBAL COMPUTER NETWORK, NAMELY, MAKING RESERVATIONS AND BOOKINGS FOR TEMPORARY LODGING (U.S. CLS. 100 AND 101).

FIRST USE 4-10-2006; IN COMMERCE 4-10-2006.
ANDREW RHIM, EXAMINING ATTORNEY

SN 78-866,990. ARENA FOOTBALL LEAGUE, LLC, CHICAGO, IL. FILED 4-21-2006.

Stockton Lightning

THE MARK CONSISTS OF STANDARD CHARACTERS WITHOUT CLAIM TO ANY PARTICULAR FONT, STYLE, SIZE, OR COLOR.

NO CLAIM IS MADE TO THE EXCLUSIVE RIGHT TO USE "STOCKTON", APART FROM THE MARK AS SHOWN.

SN 78-867,070. POMWONDERFUL LLC, LOS ANGELES, CA.
FILED 4-21-2006.

CLASS 16—PAPER GOODS AND PRINTED MATTER

FOR PRINTED ANNUAL MEDIA GUIDES CONTAINING INFORMATION ABOUT FOOTBALL, GENERAL MERCHANDISE CATALOGS, BUMPER STICKERS, WRITING PADS AND PENS, PENCILS, TRADING CARDS, POSTERS, PAPER PENNANTS, POST CARDS, CALENDARS, PAPER STICKERS, APPLIQUES IN THE FORM OF DECALS, PRINTED EVENT ADMISSION TICKETS, GREETING CARDS, STATISTICAL BOOKS, NEWSLETTERS AND PAMPHLETS IN THE FIELD OF FOOTBALL FOR DISTRIBUTION TO TELEVISION AND RADIO MEDIA (U.S. CLS. 2, 5, 22, 23, 29, 37, 38 AND 50).

CLASS 25—CLOTHING

FOR MEN'S, WOMEN'S AND CHILDREN'S CLOTHING, NAMELY PLAYER UNIFORMS, FOOTWEAR, JERSEY TOPS AND PANTS; CHEERLEADER UNIFORMS; REPLICA UNIFORM SHIRTS, COACHES' CAPS, WOOL HATS, PAINTERS' CAPS, BASEBALL CAPS, VISORS, HEADBANDS, BELTS, T-SHIRTS, TANK TOPS, GOLF SHIRTS, SWEATERS, SWEATSHIRTS, LEATHER JACKETS, NECKTIES, COATS, SHORTS, SWEATPANTS, PANTS, SOCKS AND UNDERWEAR (U.S. CLS. 22 AND 39).

CLASS 41—EDUCATION AND ENTERTAINMENT

FOR ENTERTAINMENT SERVICES, NAMELY ORGANIZING AND PRESENTING FOOTBALL GAMES BEFORE LIVE AUDIENCES AND ON TELEVISION, RADIO, FOR GLOBAL COMPUTER NETWORK DISPLAY AND OTHER MEDIA (U.S. CLS. 100, 101 AND 107).
JOHN GARTNER, EXAMINING ATTORNEY

POWERED BY POMx

THE MARK CONSISTS OF STANDARD CHARACTERS WITHOUT CLAIM TO ANY PARTICULAR FONT, STYLE, SIZE, OR COLOR.

CLASS 30—STAPLE FOODS

FOR TEA; PREPARED READY-TO-DRINK TEA; TEA-BASED PREPARATION FOR MAKING BEVERAGES; ICED TEA; TEA-BASED BEVERAGES WITH FRUIT FLAVORING; FRUIT TEA AND BEVERAGES MADE OF TEA (U.S. CL. 46).

FIRST USE 3-31-2006; IN COMMERCE 3-31-2006.

CLASS 32—LIGHT BEVERAGES

FOR NON-ALCOHOLIC FRUIT EXTRACTS USED IN THE PREPARATION OF BEVERAGES; PREPARATIONS FOR MAKING FRUIT DRINKS; FRUIT FLAVORED BEVERAGES; NON-ALCOHOLIC BEVERAGES CONTAINING FRUIT JUICES; SMOOTHIES; BOTTLED DRINKING WATER; NON-ALCOHOLIC BEVERAGES WITH TEA FLAVOR; LOW CALORIE FRUIT FLAVORED BEVERAGES; LOW CALORIE FRUIT JUICE DRINKS; SPORTS DRINKS; ENERGY DRINKS; LOW CALORIE NON-ALCOHOLIC BEVERAGES WITH TEA FLAVOR (U.S. CLS. 45, 46 AND 48).

FIRST USE 3-31-2006; IN COMMERCE 3-31-2006.
BARBARA A. LOUGHRAN, EXAMINING ATTORNEY

SN 78-867,123. PLACER VINEYARDS, LLC, ROSEVILLE, CA. FILED 4-21-2006.

SN 78-867,178. PLACER VINEYARDS, LLC, ROSEVILLE, CA. FILED 4-21-2006.



THE MARK CONSISTS OF A STYLIZED LETTER "V" WITH A "DOT" ON TOP.

THE MARK CONSISTS OF A STYLIZED LETTER "V" WITH A "DOT" ON TOP.

CLASS 36—INSURANCE AND FINANCIAL

FOR INVESTMENT SERVICES, NAMELY ASSET ACQUISITION, CONSULTATION, DEVELOPMENT AND MANAGEMENT SERVICES; LAND LEASING; REAL ESTATE ACQUISITION SERVICES; REAL ESTATE BROKERAGE; REAL ESTATE CONSULTATION; REAL ESTATE INVESTMENT; REAL ESTATE MANAGEMENT CONSULTATION (U.S. CLS. 100, 101 AND 102). FIRST USE 12-9-2002; IN COMMERCE 12-9-2002.

CLASS 21—HOUSEWARES AND GLASS

FOR MUGS (U.S. CLS. 2, 13, 23, 29, 30, 33, 40 AND 50).

CLASS 25—CLOTHING

FOR HATS; PANTS; SHIRTS (U.S. CLS. 22 AND 39). STEPHANIE DAVIS, EXAMINING ATTORNEY

CLASS 37—CONSTRUCTION AND REPAIR

FOR LAND DEVELOPMENT SERVICES, NAMELY, PLANNING AND LAYING OUT OF RESIDENTIAL AND/OR COMMERCIAL COMMUNITIES; REAL ESTATE DEVELOPMENT (U.S. CLS. 100, 103 AND 106). FIRST USE 12-9-2002; IN COMMERCE 12-9-2002. STEPHANIE DAVIS, EXAMINING ATTORNEY

SN 78-867,330. PLAYERS MANAGEMENT GROUP, LAS VEGAS, NV. FILED 4-21-2006.

SN 78-867,166. PLACER VINEYARDS, LLC, ROSEVILLE, CA. FILED 4-21-2006.

THE POKER POSSE

PLACER VINEYARDS

THE MARK CONSISTS OF STANDARD CHARACTERS WITHOUT CLAIM TO ANY PARTICULAR FONT, STYLE, SIZE, OR COLOR.

NO CLAIM IS MADE TO THE EXCLUSIVE RIGHT TO USE "POKER", APART FROM THE MARK AS SHOWN.

THE MARK CONSISTS OF STANDARD CHARACTERS WITHOUT CLAIM TO ANY PARTICULAR FONT, STYLE, SIZE, OR COLOR.

CLASS 25—CLOTHING

FOR BELTS; CAPS; JERSEYS; LEATHER BELTS; SHORT SETS; TIES; TOPS; WRAPS (U.S. CLS. 22 AND 39).

CLASS 21—HOUSEWARES AND GLASS

FOR MUGS (U.S. CLS. 2, 13, 23, 29, 30, 33, 40 AND 50).

CLASS 41—EDUCATION AND ENTERTAINMENT

CLASS 25—CLOTHING

FOR HATS; PANTS; SHIRTS (U.S. CLS. 22 AND 39). STEPHANIE DAVIS, EXAMINING ATTORNEY

FOR ENTERTAINMENT SERVICES, NAMELY, ARRANGING AND CONDUCTING OF COMPETITIONS FOR PROFESSIONAL GAMING AND POKER EVENTS (U.S. CLS. 100, 101 AND 107). DEZMONA MIZELLE, EXAMINING ATTORNEY

SN 78-867.446. ELEMENTAL ORGANICS, LLC, BOCA RATON, FL. FILED 4-22-2006.

SN 78-867.554. PANBOR FURNITURE COMPANY LIMITED, GUEISHAN, TAOYUAN, TAIWAN, FILED 4-23-2006.

Bodhi Tea

THE MARK CONSISTS OF STANDARD CHARACTERS WITHOUT CLAIM TO ANY PARTICULAR FONT, STYLE, SIZE, OR COLOR.

NO CLAIM IS MADE TO THE EXCLUSIVE RIGHT TO USE TEA, APART FROM THE MARK AS SHOWN.

CLASS 3—COSMETICS AND CLEANING PREPARATIONS

FOR COSMETIC CREAMS FOR SKIN CARE (U.S. CLS. 1, 4, 6, 50, 51 AND 52).

CLASS 5—PHARMACEUTICALS

FOR HERBAL TEAS FOR MEDICINAL PURPOSES (U.S. CLS. 6, 18, 44, 46, 51 AND 52).

CLASS 30—STAPLE FOODS

FOR HERBAL TEA (U.S. CL. 46).
PATRICIA EVANKO, EXAMINING ATTORNEY

SN 78-867.545. WONDERNET LTD., GIVAT HASHLOSHA, ISRAEL, FILED 4-23-2006.

SIGNificant

THE MARK CONSISTS OF STANDARD CHARACTERS WITHOUT CLAIM TO ANY PARTICULAR FONT, STYLE, SIZE, OR COLOR.

CLASS 9—ELECTRICAL AND SCIENTIFIC APPARATUS

FOR COMPUTER HARDWARE; COMPUTER SOFTWARE FOR MANAGEMENT OF DIGITAL SIGNATURES; DOCUMENT MANAGEMENT AND FOR ENABLING ELECTRONIC SIGNING OF DOCUMENTS (U.S. CLS. 21, 23, 26, 36 AND 38).

CLASS 42—SCIENTIFIC, COMPUTER AND LEGAL SERVICES

FOR APPLICATION SERVICE PROVIDER (ASP) FEATURING SOFTWARE IN THE FIELD OF DIGITAL SIGNATURES; DOCUMENT MANAGEMENT AND FOR ENABLING ELECTRONIC SIGNING OF DOCUMENTS; COMPUTER CONSULTATION; COMPUTER HARDWARE DEVELOPMENT; COMPUTER NETWORK DESIGN FOR OTHERS; COMPUTER PROGRAMMING FOR OTHERS; COMPUTER SOFTWARE DEVELOPMENT; CUSTOMIZATION OF COMPUTER HARDWARE AND SOFTWARE (U.S. CLS. 100 AND 101).

MATTHEW MCDOWELL, EXAMINING ATTORNEY



TENLLIS

THE MARK CONSISTS OF AN ABSTRACT FIGURE REMINISCENT OF A CROWN OR PLANT BUD ABOVE THE WORD "TENLLIS".

CLASS 20—FURNITURE AND ARTICLES NOT OTHERWISE CLASSIFIED

FOR BATH PILLOWS; BED FRAMES; BED HEADBOARDS; BEDROOM FURNITURE; BEDS; BEDS FOR HOUSEHOLD PETS; BEDSPRINGS; CHAIR BEDS; CHAIR PADS; CHAIRS; FOLDING BEDS; FURNITURE; MATERNITY PILLOWS; MATTRESSES; MATTRESSES MADE OF FLEXIBLE WOOD; PILLOWFORMS; PILLOWS; SOFA BEDS; SOFAS; WATERBEDS; WOOD BEDSTEADS; WOODEN BEDS (U.S. CLS. 2, 13, 22, 25, 32 AND 50).

CLASS 24—FABRICS

FOR BED BLANKETS; BED CANOPIES; BED LINEN; BED PADS; BED SHEETS; BED SHEETS OF PAPER; BED SKIRTS; BED SPREADS; MATTRESS COVERS; MATTRESS PADS; PILLOW COVERS; PILLOWCASES (U.S. CLS. 42 AND 50).

GILBERT SWIFT, EXAMINING ATTORNEY

SN 78-867.566. FOUR HORSEMEN ENTERTAINMENT, L.L.C., MORTON GROVE, IL. FILED 4-23-2006.

Four Horsemen of the Apocalypse: WAR

THE MARK CONSISTS OF STANDARD CHARACTERS WITHOUT CLAIM TO ANY PARTICULAR FONT, STYLE, SIZE, OR COLOR.

CLASS 9—ELECTRICAL AND SCIENTIFIC APPARATUS

FOR COMPUTER GAME CARTRIDGES; COMPUTER GAME CASSETTES; COMPUTER GAME DISCS; COMPUTER GAME EQUIPMENT CONTAINING MEMORY DEVICES NAMELY, DISCS; COMPUTER GAME JOYSTICKS; COMPUTER GAME PROGRAMS; COMPUTER GAME SOFTWARE; COMPUTER PROGRAMS FOR PRE-RECORDED GAMES; COMPUTER SOFTWARE FOR USE IN THE ENCRYPTION AND DECRYPTION OF DIGITAL FILES, INCLUDING AUDIO, VIDEO, TEXT, BINARY, STILL IMAGES, GRAPHICS AND MULTIMEDIA FILES; COMPUTER SOFTWARE FOR USE IN THE SAFEGUARDING OF DIGITAL FILES, INCLUDING AUDIO, VIDEO, TEXT, BINARY, STILL IMAGES, GRAPHICS AND MULTIMEDIA FILES; COMPUTERIZED VIDEO TABLE GAMES FOR GAMING PURPOSES; DOWNLOADABLE FILMS AND TV PROGRAMS PROVIDED VIA A VIDEO-ON-DEMAND; ELECTRICAL CIRCUITS FOR USE IN AMUSEMENT GAME MACHINES FOR REPRODUCING MUSIC, SPEECH AND SPECIAL EFFECTS; ELECTRONIC AND ELECTRO-MECHANICAL GAMING TABLES WITH VIDEO OUTPUT; ELECTRONIC GAME PROGRAMS; ELECTRONIC GAME SOFTWARE FOR CELLULAR TELEPHONES; ELECTRONIC GAME SOFTWARE FOR HANDHELD ELECTRONIC DEVICES; ELECTRONIC GAME SOFTWARE FOR WIRELESS DEVICES; GAME SOFTWARE; GAMING EQUIPMENT, NAMELY, SLOT MACHINES WITH OR WITHOUT VIDEO OUTPUT; GAMING MACHINES; HAND HELD JOY STICK UNITS FOR PLAYING VIDEO GAMES; INTERACTIVE MULTIMEDIA COMPUTER GAME PROGRAM; INTERACTIVE VIDEO GAME PROGRAMS; INTERACTIVE VIDEO GAMES OF VIRTUAL REALITY COMPRISED OF COMPUTER HARDWARE AND SOFTWARE; JACKETS FOR VIDEO CASSETTES; JOYSTICKS FOR VIDEO GAMES; MACHINES FOR PLAYING GAMES OF CHANCE; PLAYER-OPERATED ELECTRONIC CONTROLLERS FOR ELECTRONIC VIDEO GAME MACHINES; VIDEO GAME CARTRIDGES; VIDEO GAME DISCS; VIDEO GAME INTERACTIVE CONTROL FLOOR PADS OR MATS; VIDEO GAME INTERACTIVE HAND HELD REMOTE CONTROLS FOR PLAYING ELECTRONIC GAMES; VIDEO GAME INTERACTIVE REMOTE CONTROL UNITS; VIDEO GAME JOYSTICKS; VIDEO GAME MACHINES FOR USE WITH TELEVISIONS; VIDEO GAME SOFTWARE; VIDEO GAME TAPE CASSETTES; VIDEO OUTPUT GAME MACHINES FOR USE WITH TELEVISIONS; VIDEOTAPES AND VIDEO DISKS RECORDED WITH ANIMATION; VIRTUAL REALITY GAME SOFTWARE (U.S. CLS. 21, 23, 26, 36 AND 38).

CLASS 28—TOYS AND SPORTING GOODS

FOR ACTION SKILL GAMES; ACTION TARGET GAMES; AMUSEMENT GAME MACHINES; ARCADE GAMES; BOARD GAMES; CARD GAMES; COIN-OPERATED VIDEO GAMES; ELECTRIC ACTION TOYS; ELECTRONIC EDUCATIONAL GAME MACHINES FOR CHILDREN; ELECTRONICALLY OPERATED TOY MOTOR VEHICLES; EQUIPMENT SOLD AS A UNIT FOR PLAYING A MEMORY GAME; EQUIPMENT SOLD AS A UNIT FOR PLAYING ACTION TYPE TARGET GAMES; EQUIPMENT SOLD AS A UNIT FOR PLAYING BOARD GAMES; EQUIPMENT SOLD AS A UNIT FOR PLAYING CARD GAMES; FANTASY CHARACTER TOYS; HAND HELD UNIT FOR PLAYING ELECTRONIC GAMES; HAND HELD UNIT FOR PLAYING VIDEO GAMES; HAND-HELD GAMES WITH LIQUID CRYSTAL DISPLAYS; MECHANICAL ACTION TOYS; MECHANICAL TOYS; MINIATURE TOY HELMETS; MODELED PLASTIC TOY FIGURINES; MOLDED TOY FIGURES; PLASTIC CHARACTER TOYS; RADIO CONTROLLED TOY VEHICLES; TOY ACTION FIGURES; TOY ACTION FIGURES AND ACCESSORIES THEREFOR; TOY AIRPLANES; TOY ANIMALS AND ACCESSORIES THEREFOR; TOY ARMOR; TOY CAP PISTOLS; TOY CLOCKS AND WATCHES; TOY FIGURES; TOY GUNS; TOY HOLSTERS; TOY MASKS; TOY MODEL CARS; TOY MODEL HOBBYCRAFT KITS; TOY MODEL KIT CARS; TOY MODEL VEHICLES AND RELATED ACCESSORIES

SOLD AS UNITS; TOY PISTOLS; TOY ROBOTS; TOY SWORDS; TOY VEHICLES; TOY VEHICLES AND ACCESSORIES THEREFOR; TOY WATER GLOBES; TOY, NAMELY, BATTERY-POWERED COMPUTER GAME WITH LCD SCREEN WHICH FEATURES ANIMATION AND SOUND EFFECTS; TOYS, NAMELY, A DISK TO TOSS IN PLAYING A GAME WHEREIN OTHER DISKS ARE FLIPPED AND COLLECTED; TRADING CARD GAMES; TRANSFORMING ROBOTIC TOY VEHICLES; TRANSFORMING ROBOTIC TOYS; WIND-UP TOYS; WIND-UP WALKING TOYS (U.S. CLS. 22, 23, 38 AND 50).

JANICE KIM, EXAMINING ATTORNEY

SN 78-867,612. CARDIOTEL DIAGNOSTICS, LLC, TEQUESTA, FL. FILED 4-23-2006.

CARDIOTEL

THE MARK CONSISTS OF STANDARD CHARACTERS WITHOUT CLAIM TO ANY PARTICULAR FONT, STYLE, SIZE, OR COLOR.

CLASS 5—PHARMACEUTICALS

FOR MEDICAL DIAGNOSTIC TEST STRIPS FOR USE IN MONITORING HEART DISEASE (U.S. CLS. 6, 18, 44, 46, 51 AND 52).

CLASS 10—MEDICAL APPARATUS

FOR HEART MONITORS; HEART MONITORS TO BE WORN DURING EXERCISE (U.S. CLS. 26, 39 AND 44).

CLASS 44—MEDICAL, BEAUTY AND AGRICULTURAL SERVICES

FOR REMOTE MONITORING OF DATA INDICATIVE OF THE HEALTH OR CONDITION OF AN INDIVIDUAL OR GROUP OF INDIVIDUALS; TELEMEDICINE; TRANSTELEPHONE HEART MONITORING SERVICES (U.S. CLS. 100 AND 101).

CLASS 45—PERSONAL SERVICES

FOR MONITORING TELEPHONE CALLS FROM SUBSCRIBERS AND NOTIFYING EMERGENCY FACILITIES (U.S. CLS. 100 AND 101).

KATHERINE STOIDES, EXAMINING ATTORNEY

SN 78-867,747. THE VISTA FOUNDATION, MIDDLETOWN, PA. FILED 4-24-2006.

UNIQUE POTENTIAL WITHIN REACH

THE MARK CONSISTS OF STANDARD CHARACTERS WITHOUT CLAIM TO ANY PARTICULAR FONT, STYLE, SIZE, OR COLOR.

CLASS 41—EDUCATION AND ENTERTAINMENT

FOR EDUCATIONAL SERVICES IN THE NATURE OF A SCHOOL FOR STUDENTS AT THE PRE-SCHOOL, ELEMENTARY AND SECONDARY LEVELS (U.S. CLS. 100, 101 AND 107).

FIRST USE 9-23-2002; IN COMMERCE 9-23-2002.

CLASS 44—MEDICAL, BEAUTY AND AGRICULTURAL SERVICES

FOR MENTAL HEALTH SERVICES, NAMELY, BEHAVIORAL THERAPY (U.S. CLS. 100 AND 101).

FIRST USE 9-23-2002; IN COMMERCE 9-23-2002.

JIM RINGLE, EXAMINING ATTORNEY

CLASS 3—COSMETICS AND CLEANING PREPARATIONS

FOR BEAUTY CREAMS FOR BODY CARE; BODY AND BEAUTY CARE COSMETICS; COSMETIC CREAMS FOR SKIN CARE; COSMETIC PREPARATIONS FOR BODY CARE; LOTIONS FOR FACE AND BODY CARE; NON-MEDICATED SKIN CARE PREPARATIONS; NON-MEDICATED SKIN CREAMS; NON-MEDICATED STIMULATING LOTIONS FOR THE SKIN; NON-MEDICATED SUN CARE PREPARATIONS; SKIN CARE PRODUCTS, NAMELY, NON-MEDICATED SKIN SERUM; SKIN CLARIFIERS; SKIN CLEANSERS; SKIN CLEANSING CREAM; SKIN CLEANSING LOTION; SKIN CONDITIONERS; SKIN CREAM; SKIN CREAMS; SKIN CREAMS IN LIQUID AND IN SOLID FORM; SKIN CREAMS IN LIQUID AND SOLID; SKIN CREAMS IN LIQUID AND SOLID FORM; SKIN EMOLLIENTS; SKIN GELS FOR ACCELERATING, ENHANCING OR EXTENDING TANS; SKIN LIGHTENERS; SKIN LIGHTENING CREAMS; SKIN LOTION; SKIN LOTIONS; SKIN MOISTURIZER; SUN CARE LOTIONS (U.S. CLS. 1, 4, 6, 50, 51 AND 52).

SN 78-867,864. ENGVALL, RICHARD, SACRAMENTO, CA. FILED 4-24-2006.

CLASS 5—PHARMACEUTICALS

FOR ACNE MEDICATIONS; NUTRITIONAL SUPPLEMENTS (U.S. CLS. 6, 18, 44, 46, 51 AND 52).

JASON TURNER, EXAMINING ATTORNEY



AdventureIT2
Bringing Technology into a Human Experience

CLASS 41—EDUCATION AND ENTERTAINMENT

FOR COMPUTER EDUCATION TRAINING SERVICES (U.S. CLS. 100, 101 AND 107).

FIRST USE 3-28-2006; IN COMMERCE 3-28-2006.

CLASS 42—SCIENTIFIC, COMPUTER AND LEGAL SERVICES

FOR COMPUTER CONSULTING, NAMELY, DESIGNING AND IMPLEMENTING WEB SITES FOR OTHERS (U.S. CLS. 100 AND 101).

FIRST USE 3-28-2006; IN COMMERCE 3-28-2006.

TINA L. SNAPP, EXAMINING ATTORNEY

SN 78-867,883. ISOMERS LABORATORIES INC., TORONTO, CANADA, FILED 4-24-2006.

INTELLISOME

THE MARK CONSISTS OF STANDARD CHARACTERS WITHOUT CLAIM TO ANY PARTICULAR FONT, STYLE, SIZE, OR COLOR.

SN 78-868,239. THE SUSAN G. KOMEN BREAST CANCER FOUNDATION, INC., DALLAS, TX. FILED 4-24-2006.

I AM THE CURE

THE MARK CONSISTS OF STANDARD CHARACTERS WITHOUT CLAIM TO ANY PARTICULAR FONT, STYLE, SIZE, OR COLOR.

CLASS 35—ADVERTISING AND BUSINESS

FOR PROMOTING PUBLIC AWARENESS OF BREAST CANCER (U.S. CLS. 100, 101 AND 102).

CLASS 41—EDUCATION AND ENTERTAINMENT

FOR EDUCATIONAL SERVICES, NAMELY, SEMINARS PROMOTING EDUCATION OF BREAST CANCER AND IDENTIFYING THE BENEFITS OF EARLY DETECTION OF BREAST CANCER; ORGANIZING AND CONDUCTING EVENTS TO RAISE MONEY FOR BREAST CANCER RESEARCH AND LOCAL COMMUNITY BREAST HEALTH AWARENESS PROGRAMS (U.S. CLS. 100, 101 AND 107).

FRED CARL, EXAMINING ATTORNEY

SN 78-868,350. HYDRABATHS, INC., SANTA ANA, CA. FILED 4-24-2006.

SN 78-868,368. NIELSEN & BAINBRIDGE LLC, PARAMUS, NJ. FILED 4-24-2006.

HYDRABATHS

ARCHIVAL PLUS

THE MARK CONSISTS OF STANDARD CHARACTERS WITHOUT CLAIM TO ANY PARTICULAR FONT, STYLE, SIZE, OR COLOR.

THE MARK CONSISTS OF STANDARD CHARACTERS WITHOUT CLAIM TO ANY PARTICULAR FONT, STYLE, SIZE, OR COLOR.

NO CLAIM IS MADE TO THE EXCLUSIVE RIGHT TO USE "ARCHIVAL", APART FROM THE MARK AS SHOWN.

CLASS 7—MACHINERY

FOR WATER PUMPS FOR WHIRLPOOL BATHS (U.S. CLS. 13, 19, 21, 23, 31, 34 AND 35). FIRST USE 2-14-1978; IN COMMERCE 4-4-1978.

CLASS 16—PAPER GOODS AND PRINTED MATTER

FOR MEMORY BOOKS (U.S. CLS. 2, 5, 22, 23, 29, 37, 38 AND 50).

CLASS 11—ENVIRONMENTAL CONTROL APPARATUS

FOR BATH TUB JETS; BATH TUBS; WHIRLPOOL BATHS; WHIRLPOOL JETS (U.S. CLS. 13, 21, 23, 31 AND 34). FIRST USE 2-14-1978; IN COMMERCE 4-4-1978. BARNEY CHARLON, EXAMINING ATTORNEY

CLASS 20—FURNITURE AND ARTICLES NOT OTHERWISE CLASSIFIED

FOR READY MADE FRAMES FOR ARTWORK AND PHOTOGRAPHS (U.S. CLS. 2, 13, 22, 25, 32 AND 50). MARIA-VICTORIA SUAREZ, EXAMINING ATTORNEY

SN 78-868,360. RE:PLAY PUBLISHING, LLC, SHORT HILLS, NJ. FILED 4-24-2006.

SN 78-868,392. NIELSEN & BAINBRIDGE LLC, PARAMUS, NJ. FILED 4-24-2006.



THE BEST OF SPORTS NOW AND THEN

ARTCARE ARCHIVAL PLUS

THE MARK CONSISTS OF THE WORD "RE:PLAY" IN LOWER CASE STACKED ON TOP OF THE TAGLINE IN ALL CAPS "THE BEST OF SPORTS NOW AND THEN".

THE MARK CONSISTS OF STANDARD CHARACTERS WITHOUT CLAIM TO ANY PARTICULAR FONT, STYLE, SIZE, OR COLOR.

OWNER OF U.S. REG. NOS. 2,548,281, 3,033,604 AND 3,043,706.

NO CLAIM IS MADE TO THE EXCLUSIVE RIGHT TO USE "ARCHIVAL", APART FROM THE MARK AS SHOWN.

CLASS 16—PAPER GOODS AND PRINTED MATTER

FOR GENERAL FEATURE MAGAZINES; MAGAZINES FEATURING SPORTS (U.S. CLS. 2, 5, 22, 23, 29, 37, 38 AND 50).

CLASS 16—PAPER GOODS AND PRINTED MATTER

FOR MEMORY BOOKS (U.S. CLS. 2, 5, 22, 23, 29, 37, 38 AND 50).

CLASS 41—EDUCATION AND ENTERTAINMENT

FOR PUBLICATION OF SPORTS MAGAZINES (U.S. CLS. 100, 101 AND 107). LEIGH CAROLINE CASE, EXAMINING ATTORNEY

CLASS 20—FURNITURE AND ARTICLES NOT OTHERWISE CLASSIFIED

FOR READY MADE FRAMES FOR ARTWORK AND PHOTOGRAPHS (U.S. CLS. 2, 13, 22, 25, 32 AND 50). MARIA-VICTORIA SUAREZ, EXAMINING ATTORNEY

SN 78-868,494. PLAYERS MANAGEMENT GROUP, LAS VEGAS, NV. FILED 4-24-2006.

SN 78-868,519. ROCKIN' BABY, INC., LOS ANGELES, CA. FILED 4-24-2006.

THANK GOD FOR POKER

THE MARK CONSISTS OF STANDARD CHARACTERS WITHOUT CLAIM TO ANY PARTICULAR FONT, STYLE, SIZE, OR COLOR.

NO CLAIM IS MADE TO THE EXCLUSIVE RIGHT TO USE "POKER", APART FROM THE MARK AS SHOWN.

CLASS 25—CLOTHING

FOR BELTS; CAPS; JERSEYS; LEATHER BELTS; SHORT SETS; TIES; TOPS AND WRAPS (U.S. CLS. 22 AND 39).

CLASS 35—ADVERTISING AND BUSINESS

FOR ADVERTISING AND PROMOTION SERVICES AND RELATED CONSULTING; ARRANGING AND CONDUCTING MARKETING PROMOTIONAL EVENTS FOR OTHERS; DEVELOPMENT OF MARKETING STRATEGIES AND CONCEPTS (U.S. CLS. 100, 101 AND 102).
DEZMONA MIZELLE, EXAMINING ATTORNEY

SN 78-868,510. THE EQUESTRIAN CONNECTION, LLC, MOSCOW MILLS, MO. FILED 4-24-2006.

Connective Gear

THE MARK CONSISTS OF STANDARD CHARACTERS WITHOUT CLAIM TO ANY PARTICULAR FONT, STYLE, SIZE, OR COLOR.

NO CLAIM IS MADE TO THE EXCLUSIVE RIGHT TO USE GEAR, APART FROM THE MARK AS SHOWN.

CLASS 18—LEATHER GOODS

FOR HORSE BLANKETS; HORSE BRIDLES; HORSE COLLARS; HORSE FLANKS AND SHANKS, NAMELY, HORSE PROTECTIVE PADDING, BRACES, AND LEG BOOTS FOR THE FLANKS AND LEGS; HORSE FLY VEILS FOR HORSES; HORSE HALTERS; PADS FOR HORSE SADDLES (U.S. CLS. 1, 2, 3, 22 AND 41).

CLASS 20—FURNITURE AND ARTICLES NOT OTHERWISE CLASSIFIED

FOR TACK HORSES (U.S. CLS. 2, 13, 22, 25, 32 AND 50).

CLASS 41—EDUCATION AND ENTERTAINMENT

FOR HORSE SHOWING; HORSE TRAINING (U.S. CLS. 100, 101 AND 107).
JOHN HWANG, EXAMINING ATTORNEY



NO CLAIM IS MADE TO THE EXCLUSIVE RIGHT TO USE "KID SHOP", APART FROM THE MARK AS SHOWN.

THE MARK CONSISTS OF A WOMAN HOLDING A BABY IN A BABY CARRIER.

CLASS 18—LEATHER GOODS

FOR BABY BACKPACKS; BABY CARRIERS WORN ON THE BODY; BABY CARRYING BAGS; BAGS FOR CARRYING BABIES' ACCESSORIES; DIAPER BAGS; INFANT CARRIERS WORN ON THE BODY (U.S. CLS. 1, 2, 3, 22 AND 41).

CLASS 24—FABRICS

FOR BED BLANKETS; BED LINEN; BED PADS; BED SHEETS; BED SKIRTS; BED SPREADS; BEDSHEETS; CHILDREN'S BLANKETS; PILLOW CASES; PILLOW COVERS; PILLOW SHAMS; PILLOWCASES; QUILTS; QUILTS OF TEXTILE; RECEIVING BLANKETS (U.S. CLS. 42 AND 50).

CLASS 35—ADVERTISING AND BUSINESS

FOR ON-LINE RETAIL STORE SERVICES FEATURING INFANT AND CHILDREN'S CARRIERS, BEDDING, BED SHEETS, QUILTS, BLANKETS, BED SKIRTS, PILLOW CASES, PILLOW SHAMS, PILLOW COVERS, PILLOWS, CHILDREN'S BLANKETS AND COVERS, CAR SEAT COVERS, SHOPPING CART COVERS, CLOTHING, DIAPER BAGS, BAGS, TOYS AND HOUSEHOLD ITEMS; RETAIL STORES FEATURING INFANT AND CHILDREN'S CARRIERS, BEDDING, BED SHEETS, QUILTS, BLANKETS, BED SKIRTS, PILLOW CASES, PILLOW SHAMS, PILLOW COVERS, PILLOWS, CHILDREN'S BLANKETS AND COVERS, CAR SEAT COVERS, SHOPPING CART COVERS, CLOTHING, DIAPER BAGS, BAGS, TOYS AND HOUSEHOLD ITEMS (U.S. CLS. 100, 101 AND 102).

ALLISON HOLTZ, EXAMINING ATTORNEY

SN 78-868,948. UNIFIED DEVELOPMENT, INC., CHESTERFIELD, MO. FILED 4-25-2006.

INVITE. CONNECT. ENGAGE.

THE MARK CONSISTS OF STANDARD CHARACTERS WITHOUT CLAIM TO ANY PARTICULAR FONT, STYLE, SIZE, OR COLOR.

CLASS 35—ADVERTISING AND BUSINESS

FOR PROMOTION, ADVERTISING AND MARKETING OF ONLINE WEBSITES (U.S. CLS. 100, 101 AND 102).

FIRST USE 6-10-2005; IN COMMERCE 2-1-2006.

CLASS 42—SCIENTIFIC, COMPUTER AND LEGAL SERVICES

FOR DESIGNING AND IMPLEMENTING WEBSITES FOR OTHERS (U.S. CLS. 100 AND 101).

FIRST USE 6-10-2005; IN COMMERCE 2-1-2006.
MARILYN IZZI, EXAMINING ATTORNEY

CLASS 42—SCIENTIFIC, COMPUTER AND LEGAL SERVICES

FOR COMPUTER SERVICES, NAMELY, PROVIDING SEARCH ENGINES FOR OBTAINING DATA ON A GLOBAL COMPUTER NETWORK; PROVIDING CUSTOMIZED ON-LINE WEB PAGES FEATURING USER-DEFINED INFORMATION, WHICH INCLUDES SEARCH ENGINES, AND ON-LINE LINKS TO OTHER WEB SITES (U.S. CLS. 100 AND 101).

FIRST USE 5-0-2005; IN COMMERCE 10-0-2005.
KEVON CHISOLM, EXAMINING ATTORNEY

SN 78-869,117. BEN & JERRY'S HOMEMADE, INC., BURLINGTON, VT. FILED 4-25-2006.

SN 78-869,571. REVENUE SCIENCE, INC., BELLEVUE, WA. FILED 4-25-2006.

PURPLE GRAZE

THE MARK CONSISTS OF STANDARD CHARACTERS WITHOUT CLAIM TO ANY PARTICULAR FONT, STYLE, SIZE, OR COLOR.

CLASS 29—MEATS AND PROCESSED FOODS

FOR DAIRY-BASED BEVERAGES (U.S. CL. 46).

CLASS 30—STAPLE FOODS

FOR FROZEN CONFECTIONS; ICE CREAM (U.S. CL. 46).

PETER CHENG, EXAMINING ATTORNEY

SN 78-869,497. ZVENTS, INC., MENLO PARK, CA. FILED 4-25-2006.

ZVENTS

THE MARK CONSISTS OF STANDARD CHARACTERS WITHOUT CLAIM TO ANY PARTICULAR FONT, STYLE, SIZE, OR COLOR.

CLASS 41—EDUCATION AND ENTERTAINMENT

FOR PROVIDING INFORMATION IN THE FIELD OF COMMUNITY ENTERTAINMENT, SPORTING AND CULTURAL EVENTS VIA THE INTERNET (U.S. CLS. 100, 101 AND 107).

FIRST USE 5-0-2005; IN COMMERCE 10-0-2005.

TRUECLICK

THE MARK CONSISTS OF STANDARD CHARACTERS WITHOUT CLAIM TO ANY PARTICULAR FONT, STYLE, SIZE, OR COLOR.

CLASS 35—ADVERTISING AND BUSINESS

FOR ADVERTISING AND BUSINESS MANAGEMENT CONSULTANCY; ADVERTISING AND COMMERCIAL INFORMATION SERVICES, VIA THE INTERNET; ADVERTISING AND MARKETING; ADVERTISING AND PROMOTION SERVICES AND RELATED CONSULTING; ADVERTISING BY TRANSMISSION OF ONLINE PUBLICITY FOR THIRD PARTIES THROUGH ELECTRONIC COMMUNICATIONS NETWORKS; BUSINESS CONSULTATION AND MANAGEMENT REGARDING MARKETING ACTIVITIES AND LAUNCHING OF NEW PRODUCTS; BUSINESS MARKETING SERVICES; COMMERCIAL INFORMATION AGENCIES; CONDUCTING MARKETING STUDIES; COOPERATIVE ADVERTISING AND MARKETING SERVICES BY WAY OF SOLICITATION, CUSTOMER SERVICE AND PROVIDING MARKETING INFORMATION VIA WEBSITES ON A GLOBAL COMPUTER NETWORK; CREATION OF MARKETING TOOLS DESIGNED TO INCREASE A CLIENT COMPANY'S KNOWLEDGE OF CUSTOMER NEEDS, AND ITS COMPETITORS' PRODUCTS AND SERVICES, PRICING, ADVERTISING STRATEGY AND SALES STRATEGY; DEVELOPMENT OF MARKETING STRATEGIES AND CONCEPTS; DISSEMINATION OF ADVERTISING FOR OTHERS VIA AN ONLINE COMMUNICATIONS NETWORK ON THE INTERNET; ELECTRONIC COMMERCE SERVICES, NAMELY PROVIDING INFORMATION PRODUCTS VIA TELECOMMUNICATION NETWORKS FOR ADVERTISING AND SALES PURPOSES; PROVIDING A SEARCHABLE ONLINE ADVERTISING GUIDE FEATURING THE GOODS AND SERVICES OF OTHER ONLINE VENDORS ON THE INTERNET; STATISTICAL EVALUATIONS OF MARKETING DATA (U.S. CLS. 100, 101 AND 102).

CLASS 39—TRANSPORTATION AND STORAGE

FOR ELECTRONIC STORAGE OF DATA; STORAGE SERVICES FOR ARCHIVING DATABASES, IMAGES AND OTHER ELECTRONIC DATA (U.S. CLS. 100 AND 105).

CLASS 42—SCIENTIFIC, COMPUTER AND LEGAL SERVICES

FOR COMPUTER SERVICE, NAMELY, ACTING AS AN APPLICATION SERVICE PROVIDER IN THE FIELD OF KNOWLEDGE MANAGEMENT TO HOST COMPUTER APPLICATION SOFTWARE FOR THE COLLECTION, EDITING, ORGANIZING, MODIFYING, BOOK MARKING, TRANSMISSION, STORAGE AND SHARING OF DATA AND INFORMATION; DATA MINING; DATA WAREHOUSING; HOSTING THE WEB SITES OF OTHERS ON A COMPUTER SERVER FOR A GLOBAL COMPUTER NETWORK; PROVIDING INFORMATION AT THE SPECIFIC REQUEST OF END-USERS BY MEANS OF TELEPHONE OR GLOBAL COMPUTER NETWORKS (U.S. CLS. 100 AND 101).

BILL DAWE, EXAMINING ATTORNEY

SN 78-869,707. WYNDHAM TM CORP., LAS VEGAS, NV.
FILED 4-26-2006.

BLUE HARMONY

THE MARK CONSISTS OF STANDARD CHARACTERS WITHOUT CLAIM TO ANY PARTICULAR FONT, STYLE, SIZE, OR COLOR.

CLASS 3—COSMETICS AND CLEANING PREPARATIONS

FOR BATH SOAPS IN LIQUID, SOLID OR GEL FORM; BODY AND BEAUTY CARE COSMETICS; BODY AND BEAUTY CARE PREPARATIONS; BODY CREAM; BODY CREAM SOAP; BODY LOTION; CONDITIONERS; HAIR CONDITIONER; HAIR SHAMPOO; HAND SOAPS; NON-MEDICATED TOILETRIES (U.S. CLS. 1, 4, 6, 50, 51 AND 52).

CLASS 44—MEDICAL, BEAUTY AND AGRICULTURAL SERVICES

FOR HEALTH SPA SERVICES, NAMELY, COSMETIC BODY CARE SERVICES (U.S. CLS. 100 AND 101).
DARRYL SPRUILL, EXAMINING ATTORNEY

SN 78-869,723. ICF CONSULTING GROUP HOLDINGS, INC.,
FAIRFAX, VA. FILED 4-26-2006.

PASSION EXPERTISE TRUST

THE MARK CONSISTS OF STANDARD CHARACTERS WITHOUT CLAIM TO ANY PARTICULAR FONT, STYLE, SIZE, OR COLOR.

CLASS 9—ELECTRICAL AND SCIENTIFIC APPARATUS

FOR COMPUTER SOFTWARE, NAMELY, CLIENT/ SERVER-BASED, WEB-BASED AND WEB-ACCESSIBLE ANALYTICAL TOOLS FOR ANALYZING AND EVALUATING ENVIRONMENTAL REGULATORY ISSUES, NAMELY, CLIMATE CHANGE, STRATOSPHERIC OZONE, ENERGY EFFICIENCY, POLLUTION PREVENTION, WASTE MANAGEMENT, EMERGENCY MANAGEMENT, TRANSPORTATION AND INTERNATIONAL ENVIRONMENTAL MANAGEMENT SYSTEM STANDARDS, INCLUDING ISO 14001 INTERNATIONAL ENVIRONMENTAL MANAGEMENT STANDARDS; COMPUTER SOFTWARE FOR ANALYSIS AND EVALUATION OF ENERGY INDUSTRY ISSUES, NAMELY, DEVELOPMENT ANALYSIS, IMPLEMENTATION OF REGULATORY AND BUSINESS STRATEGIES; AND FINANCIAL REPORTING ISSUES, NAMELY, FEDERAL FINANCIAL AND REPORTING REQUIREMENTS (U.S. CLS. 21, 23, 26, 36 AND 38).

CLASS 35—ADVERTISING AND BUSINESS

FOR BUSINESS MANAGEMENT CONSULTING SERVICES CONCERNING SYSTEMATIC, INTEGRATED APPROACH TO CHANGE MANAGEMENT OF AN ORGANIZATION INCLUDING MISSION, BUSINESS PROCESS, CAPITAL INVESTMENT AND ORGANIZATIONAL CULTURE; BUSINESS CONSULTING REGARDING IMPROVEMENT OF THE ENVIRONMENT INCLUDING THE MEETING OF INTERNATIONAL ENVIRONMENTAL MANAGEMENT STANDARDS; BUSINESS CONSULTING REGARDING FINANCIAL AND REGULATORY ADHERENCE IN THE ENERGY INDUSTRY RETAIL AND WHOLESALE MARKETS; BUSINESS CONSULTING REGARDING ECONOMIC AND COMMUNITY DEVELOPMENT; BUSINESS CONSULTING REGARDING TRANSPORTATION DEVELOPMENT INVOLVING ENERGY CONSUMPTION; AIR QUALITY, HAZARDOUS MATERIALS TRANSPORT, AND LAND USE; BUSINESS CONSULTING REGARDING INFORMATION MANAGEMENT AND BUSINESS CONSULTING REGARDING STRATEGIC COMMUNICATIONS; CLEARINGHOUSE SERVICES, NAMELY DISTRIBUTING JOURNALS AND PUBLICATIONS, RELATING TO A FEDERAL PROGRAM AND OTHER TYPES OF DIRECT SUPPORT KNOWN AS TECHNICAL ASSISTANCE (U.S. CLS. 100, 101 AND 102).

CLASS 42—SCIENTIFIC, COMPUTER AND LEGAL SERVICES

FOR COMPUTER PROGRAMMING DEVELOPMENT AND CUSTOMIZATION SERVICES FOR OTHERS; HOSTING THE WEB SITES OF OTHERS ON A COMPUTER SERVER FOR A GLOBAL COMPUTER NETWORK (U.S. CLS. 100 AND 101).

ANNE MADDEN, EXAMINING ATTORNEY

SN 78-869,848. TKB TECHNOLOGIES, LLC, ELLISVILLE,
MO. FILED 4-26-2006.

CYL FIL

THE MARK CONSISTS OF STANDARD CHARACTERS WITHOUT CLAIM TO ANY PARTICULAR FONT, STYLE, SIZE, OR COLOR.

CLASS 5—PHARMACEUTICALS

FOR OXYGEN FOR MEDICAL USE (U.S. CLS. 6, 18, 44, 46, 51 AND 52).

CLASS 10—MEDICAL APPARATUS

FOR MEDICAL APPARATUS FOR TREATING RESPIRATORY CONDITIONS (U.S. CLS. 26, 39 AND 44).
BRIDGETT SMITH, EXAMINING ATTORNEY

SN 78-869,877. MET-RX SUBSTRATE TECHNOLOGY, INC.,
BOHEMIA, NY. FILED 4-26-2006.

MET-RX ENGINEERED BODY

THE MARK CONSISTS OF STANDARD CHARACTERS WITHOUT CLAIM TO ANY PARTICULAR FONT, STYLE, SIZE, OR COLOR.

OWNER OF U.S. REG. NOS. 2,058,523, 2,556,583 AND OTHERS.

CLASS 5—PHARMACEUTICALS

FOR VITAMIN SUPPLEMENTS, MINERAL SUPPLEMENTS AND NUTRITIONAL SUPPLEMENTS (U.S. CLS. 6, 18, 44, 46, 51 AND 52).

CLASS 29—MEATS AND PROCESSED FOODS

FOR PROTEIN-BASED, NUTRIENT-DENSE SNACK BARS AND MILK POWDER FOR NUTRITIONAL PURPOSES (U.S. CL. 46).

CLASS 30—STAPLE FOODS

FOR GRAIN-BASED FOOD BARS AND GRAIN-BASED BEVERAGES (U.S. CL. 46).

CLASS 32—LIGHT BEVERAGES

FOR SPORTS DRINKS (U.S. CLS. 45, 46 AND 48).
KATHERINE STOIDES, EXAMINING ATTORNEY

SN 78-869,899. SC FONTANA DEVELOPMENT CORPORATION, UPLAND, CA. FILED 4-26-2006.

SHADY TRAILS

THE MARK CONSISTS OF STANDARD CHARACTERS WITHOUT CLAIM TO ANY PARTICULAR FONT, STYLE, SIZE, OR COLOR.

CLASS 36—INSURANCE AND FINANCIAL

FOR REAL ESTATE LISTING, LEASING AND BROKERAGE SERVICES (U.S. CLS. 100, 101 AND 102).
FIRST USE 6-1-2005; IN COMMERCE 6-1-2005.

CLASS 37—CONSTRUCTION AND REPAIR

FOR LAND DEVELOPMENT AND CONSTRUCTION SERVICES, NAMELY, PLANNING DEVELOPMENT AND CONSTRUCTION OF A RESIDENTIAL COMMUNITY, CUSTOM LOT PROGRAMS, AND COMMERCIAL PROJECTS (U.S. CLS. 100, 103 AND 106).

FIRST USE 6-1-2005; IN COMMERCE 6-1-2005.
LINDA ESTRADA, EXAMINING ATTORNEY

SN 78-870,002. ICF CONSULTING GROUP HOLDINGS, INC.,
FAIRFAX, VA. FILED 4-26-2006.

PASSION EXPERTISE RESULTS

THE MARK CONSISTS OF STANDARD CHARACTERS WITHOUT CLAIM TO ANY PARTICULAR FONT, STYLE, SIZE, OR COLOR.

CLASS 9—ELECTRICAL AND SCIENTIFIC APPARATUS

FOR COMPUTER SOFTWARE, NAMELY, CLIENT/SERVER-BASED, WEB-BASED AND WEB-ACCESSIBLE ANALYTICAL TOOLS FOR ANALYZING AND EVALUATING ENVIRONMENTAL REGULATORY ISSUES, NAMELY, CLIMATE CHANGE, STRATOSPHERIC OZONE, ENERGY EFFICIENCY, POLLUTION PREVENTION, WASTE MANAGEMENT, EMERGENCY MANAGEMENT, TRANSPORTATION AND INTERNATIONAL ENVIRONMENTAL MANAGEMENT SYSTEM STANDARDS, INCLUDING ISO 14001 INTERNATIONAL ENVIRONMENTAL MANAGEMENT STANDARDS; COMPUTER SOFTWARE FOR ANALYSIS AND EVALUATION OF ENERGY INDUSTRY ISSUES, NAMELY, DEVELOPMENT ANALYSIS, IMPLEMENTATION OF REGULATORY AND BUSINESS STRATEGIES; AND FINANCIAL REPORTING ISSUES, NAMELY, FEDERAL FINANCIAL AND REPORTING REQUIREMENTS (U.S. CLS. 21, 23, 26, 36 AND 38).

CLASS 35—ADVERTISING AND BUSINESS

FOR BUSINESS MANAGEMENT CONSULTING SERVICES CONCERNING SYSTEMATIC, INTEGRATED APPROACH TO CHANGE MANAGEMENT OF AN ORGANIZATION INCLUDING MISSION, BUSINESS PROCESS, CAPITAL INVESTMENT AND ORGANIZATIONAL CULTURE; BUSINESS CONSULTING REGARDING IMPROVEMENT OF THE ENVIRONMENT INCLUDING THE MEETING OF INTERNATIONAL ENVIRONMENTAL MANAGEMENT STANDARDS; BUSINESS CONSULTING REGARDING FINANCIAL AND REGULATORY ADHERENCE IN THE ENERGY INDUSTRY RETAIL AND WHOLESALE MARKETS; BUSINESS CONSULTING REGARDING ECONOMIC AND COMMUNITY DEVELOPMENT; BUSINESS CONSULTING REGARDING TRANSPORTATION DEVELOPMENT INVOLVING ENERGY CONSUMPTION; AIR QUALITY, HAZARDOUS MATERIALS TRANSPORT, AND LAND USE; BUSINESS CONSULTING REGARDING INFORMATION MANAGEMENT AND BUSINESS CONSULTING REGARDING STRATEGIC COMMUNICATIONS; CLEARINGHOUSE SERVICES, NAMELY DISTRIBUTING JOURNALS AND PUBLICATIONS, RELATING TO A FEDERAL PROGRAM AND OTHER TYPES OF DIRECT SUPPORT KNOWN AS TECHNICAL ASSISTANCE (U.S. CLS. 100, 101 AND 102).

CLASS 42—SCIENTIFIC, COMPUTER AND LEGAL SERVICES

FOR COMPUTER PROGRAMMING DEVELOPMENT AND CUSTOMIZATION SERVICES FOR OTHERS; HOSTING THE WEB SITES OF OTHERS ON A COMPUTER SERVER FOR A GLOBAL COMPUTER NETWORK (U.S. CLS. 100 AND 101).

ANNE MADDEN, EXAMINING ATTORNEY

SN 78-870,327. SIRNA THERAPEUTICS, INC., BOULDER, CO. FILED 4-26-2006.

SIRNA-034

SN 78-870,111. ZOOVE CORP., PALO ALTO, CA. FILED 4-26-2006.

STARSTAR

THE MARK CONSISTS OF STANDARD CHARACTERS WITHOUT CLAIM TO ANY PARTICULAR FONT, STYLE, SIZE, OR COLOR.

CLASS 9—ELECTRICAL AND SCIENTIFIC APPARATUS

FOR COMPUTER SOFTWARE FOR DIRECT RESPONSE MARKETING USING COMPUTERS, TELEPHONES AND WIRELESS DEVICES (U.S. CLS. 21, 23, 26, 36 AND 38).

CLASS 38—COMMUNICATION

FOR TRANSFER OF DATA BY TELECOMMUNICATION (U.S. CLS. 100, 101 AND 104).

CAROLINE WEIMER, EXAMINING ATTORNEY

THE MARK CONSISTS OF STANDARD CHARACTERS WITHOUT CLAIM TO ANY PARTICULAR FONT, STYLE, SIZE, OR COLOR.

OWNER OF U.S. REG. NOS. 2,953,833 AND 2,996,055.

CLASS 1—CHEMICALS

FOR MEDICINAL AND BIOLOGICAL PREPARATIONS FOR RESEARCH AND LABORATORY USE, NAMELY, PREPARATIONS FOR THE MODULATION OF GENE EXPRESSION WORKING AT DNA, TRANSCRIPTION, RNA OR TRANSLATION PROCESSES (U.S. CLS. 1, 5, 6, 10, 26 AND 46).

CLASS 5—PHARMACEUTICALS

FOR MEDICINAL AND BIOLOGICAL PREPARATIONS FOR PHARMACEUTICAL, CLINICAL OR MEDICAL LABORATORY USE, NAMELY, PREPARATIONS FOR THE MODULATION OF GENE EXPRESSION WORKING AT DNA, TRANSCRIPTION, RNA OR TRANSLATION PROCESSES (U.S. CLS. 6, 18, 44, 46, 51 AND 52).

JOANNA DUKOVIC, EXAMINING ATTORNEY

SN 78-870,320. RED HAWK CAFE LLC, ALPHARETTA, GA. FILED 4-26-2006.

WISE FORK

THE MARK CONSISTS OF STANDARD CHARACTERS WITHOUT CLAIM TO ANY PARTICULAR FONT, STYLE, SIZE, OR COLOR.

CLASS 35—ADVERTISING AND BUSINESS

FOR RESTAURANT FRANCHISING (U.S. CLS. 100, 101 AND 102).

CLASS 43—HOTEL AND RESTAURANT SERVICES

FOR BAR SERVICES; RESTAURANT AND BAR SERVICES; RESTAURANT SERVICES; RESTAURANTS; TAKE-OUT RESTAURANT SERVICES (U.S. CLS. 100 AND 101).

DEIRDRE ROBERTSON, EXAMINING ATTORNEY

SN 78-870,407. MYTHOS SOLAR ENERGY, MENLO PARK, CA. FILED 4-26-2006.

making solar simple

THE MARK CONSISTS OF STANDARD CHARACTERS WITHOUT CLAIM TO ANY PARTICULAR FONT, STYLE, SIZE, OR COLOR.

CLASS 9—ELECTRICAL AND SCIENTIFIC APPARATUS

FOR APPARATUS FOR CONVERTING SOLAR RADIATION TO ENERGY, NAMELY PHOTOVOLTAIC SOLAR MODULES; APPARATUS FOR CONVERTING SOLAR RADIATION TO ENERGY, NAMELY THERMAL SOLAR MODULES (U.S. CLS. 21, 23, 26, 36 AND 38).

CLASS 35—ADVERTISING AND BUSINESS

FOR PROMOTING GOODS AND SERVICES OF OTHERS THROUGH DISTRIBUTION OF PROMOTIONAL LITERATURE; PROMOTING GOODS AND SERVICES OF OTHERS BY PROVIDING A WEBSITE THROUGH WHICH USERS MAY IDENTIFY SOURCES OF GOODS AND SERVICES; PROMOTING GOODS AND SERVICES OF OTHERS BY PROVIDING A WEBSITE THROUGH WHICH USERS MAY PURCHASE GOODS AND SERVICES (U.S. CLS. 100, 101 AND 102).

JENNIFER DIXON, EXAMINING ATTORNEY

SN 78-870,489. PETERSEN, AMY, SAN FRANCISCO, CA.
FILED 4-26-2006.

DENA CALI

THE MARK CONSISTS OF STANDARD CHARACTERS WITHOUT CLAIM TO ANY PARTICULAR FONT, STYLE, SIZE, OR COLOR.

OWNER OF U.S. REG. NO. 2,905,050.

THE NAME(S), PORTRAIT(S), AND/OR SIGNATURE(S) SHOWN IN THE MARK IDENTIFIES AMY PETERSEN, WHOSE CONSENT(S) TO REGISTER IS MADE OF RECORD.

CLASS 3—COSMETICS AND CLEANING PREPARATIONS

FOR HAIR COLOR; HAIR CONDITIONER; HAIR GEL; HAIR RELAXERS; HAIR SHAMPOO; HAIR SPRAY (U.S. CLS. 1, 4, 6, 50, 51 AND 52).

CLASS 9—ELECTRICAL AND SCIENTIFIC APPARATUS

FOR ELECTRIC HAIR CURLING IRONS; FLAT IRONS (U.S. CLS. 21, 23, 26, 36 AND 38).

CLASS 21—HOUSEWARES AND GLASS

FOR COMBS; HAIR BRUSHES (U.S. CLS. 2, 13, 23, 29, 30, 33, 40 AND 50).

CLASS 26—FANCY GOODS

FOR BOBBY PINS; HAIR BANDS; HAIR CLIPS; HAIR SCRUNCHIES (U.S. CLS. 37, 39, 40, 42 AND 50).
AMY ALFIERI, EXAMINING ATTORNEY

SN 78-870,593. TUCKER, JOEL G., LOS ANGELES, CA.
FILED 4-26-2006.



The logo for 'The Stockroom' features the word 'The' in a smaller font above 'Stockroom'. The 'o' in 'Stockroom' is replaced by a chain link connecting the two 'o's.

OWNER OF U.S. REG. NOS. 2,930,354, 2,935,888 AND 2,964,720.

THE MARK CONSISTS OF THE WORDS "THE STOCKROOM" WHERE THE TWO CONTIGUOUS OS IN STOCKROOM ARE CONNECTED BY A CHAIN AND APPEAR TO BE HANDCUFFS.

CLASS 14—JEWELRY

FOR JEWELRY, NAMELY CHAINS, AMULETS, RINGS, STUDS AND BRACELETS (U.S. CLS. 2, 27, 28 AND 50).

CLASS 25—CLOTHING

FOR CLOTHING, NAMELY, FETISH WEAR, NAMELY, LEATHER, RUBBER AND PVC UNDERWEAR, PANTS, SHIRTS, DRESSES, STOCKINGS AND HATS; UNDERWEAR; CORSETS; SHIRTS; GLOVES; SKIRTS; STOCKINGS AND PANTS (U.S. CLS. 22 AND 39).

CLASS 35—ADVERTISING AND BUSINESS

FOR RETAIL STORES FEATURING ADULT PRODUCTS, NAMELY, ADULT NOVELTIES, SEXUAL AIDS, AND TOYS, ADULT VIDEOS, MAGAZINES, BOOKS, AND PRINTED MATERIALS, CLOTHING, SHOES, LEATHER ACCESSORIES, FETISH WEAR, UNDERWEAR, CORSETS, SHIRTS, GLOVES, SKIRTS, STOCKINGS, PANTS, CONDOMS, LINGERIE, MOISTURIZING AND LUBRICATING CREAMS, BODY LOTIONS AND OILS, PLAYING CARDS AND GREETING CARDS (U.S. CLS. 100, 101 AND 102).

LEIGH CAROLINE CASE, EXAMINING ATTORNEY

SN 78-870,664. RINGCENTRAL, INC., SAN MATEO, CA.
FILED 4-27-2006.



The logo for 'ECENTREX' is the word 'ECENTREX' in a bold, serif font.

THE MARK CONSISTS OF STANDARD CHARACTERS WITHOUT CLAIM TO ANY PARTICULAR FONT, STYLE, SIZE, OR COLOR.

CLASS 9—ELECTRICAL AND SCIENTIFIC APPARATUS

FOR SOFTWARE FOR TELECOMMUNICATIONS SERVICES, NAMELY, SOFTWARE FOR THE OPERATION AND MANAGEMENT OF TELEPHONE COMMUNICATION, FACSIMILE, VOICEMAIL, CALL PROCESSING, CALL WAITING AND INTERNET TELEPHONY (VOIP) SERVICES (U.S. CLS. 21, 23, 26, 36 AND 38).

CLASS 38—COMMUNICATION

FOR TELECOMMUNICATIONS SERVICES, NAMELY, PROVIDING TELEPHONE COMMUNICATION SERVICES, FACSIMILE TRANSMISSION SERVICES, AND SERVICES FOR VOICEMAIL, CALL PROCESSING, CALL WAITING AND INTERNET TELEPHONY (VOIP) (U.S. CLS. 100, 101 AND 104).
HOWARD B. LEVINE, EXAMINING ATTORNEY

SN 78-870,753. FRITO-LAY NORTH AMERICA, INC., PLANO, TX. FILED 4-27-2006.

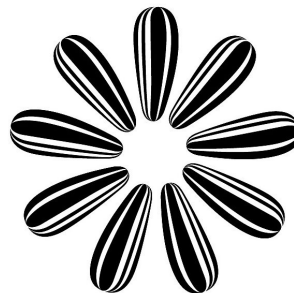

THE MARK CONSISTS OF A STYLIZED IMAGE OF A FLOWER WHOSE PETALS ARE COMPRISED OF SUNFLOWER SEEDS.

CLASS 29—MEATS AND PROCESSED FOODS

FOR POTATO CHIPS, POTATO CRISPS, POTATO-BASED SNACK FOODS; PORK RINDS; SUNFLOWER OIL; EDIBLE OIL (U.S. CL. 46).

CLASS 30—STAPLE FOODS

FOR CHEESE-FLAVORED PUFFED CORN SNACKS; PUFFED CORN SNACKS; CORN CHIPS; EXTRUDED CORN SNACKS; TORTILLA CHIPS; CEREAL-BASED SNACK FOODS; GRAIN-BASED CHIPS; FLOUR-BASED CHIPS; WHEAT-BASED SNACK FOODS; EXTRUDED WHEAT SNACKS; SNACK MIX CONSISTING PRIMARILY OF TORTILLA CHIPS, PRETZELS, MULTIGRAIN SNACK CHIPS, CHEESE-FLAVORED PUFFED CORN SNACKS AND/OR CORN CHIPS (U.S. CL. 46).
FRANK LATTUCA, EXAMINING ATTORNEY

SN 78-870,764. INTELLIGENT NUTRIENTS, INC., MINNEAPOLIS, MN. FILED 4-27-2006.

**INTELLIGENT NUTRIENTS
JASMINA**

THE MARK CONSISTS OF STANDARD CHARACTERS WITHOUT CLAIM TO ANY PARTICULAR FONT, STYLE, SIZE, OR COLOR.

OWNER OF U.S. REG. NOS. 2,098,544, 2,930,189 AND OTHERS.

NO CLAIM IS MADE TO THE EXCLUSIVE RIGHT TO USE "NUTRIENTS", APART FROM THE MARK AS SHOWN.

CLASS 3—COSMETICS AND CLEANING PREPARATIONS

FOR HAIR CARE PRODUCTS NAMELY, SHAMPOOS, CONDITIONERS, SPRAY AND SCULPTING GELS, HAIR COLOR, AND WAVING LOTIONS; SKIN CARE PRODUCTS, NAMELY, SOAP, MOISTURIZERS, TONERS, SKIN CLEANING CREAMS, BODY LOTIONS AND GELS, BODY AND FACIAL LOTIONS, MASKS AND ASTRINGENTS; COSMETICS, NAMELY, LIPSTICK, EYE SHADOW, FOUNDATION, BLUSH, FACE POWDER, CONCEALOR, EYE PENCILS, LIP PENCILS AND MASCARA; PERSONAL HYGIENE PRODUCTS, NAMELY BATH AND BODY GELS, FRAGRANCES FOR PERSONAL USE, BODY OILS AND LOTIONS, SKIN CREAMS, SKIN LOTIONS, SKIN EMOLLIENTS, SKIN MOISTURIZING OILS AND LOTIONS; PERFUMES AND COLOGNES; AND HOUSEHOLD CLEANING PRODUCTS, NAMELY, ALL PURPOSE CLEANSERS, CLEANERS FOR USE ON DISHES, CLEANERS FOR USE ON FABRIC, AND CLEANSERS FOR USE ON FLOORS, WALLS, WINDOWS AND TOILETS; INCENSE AND ROOM FRAGRANCES; AND BREATH FRESHENERS (U.S. CLS. 1, 4, 6, 50, 51 AND 52).

CLASS 5—PHARMACEUTICALS

FOR DIETARY AND NUTRITIONAL SUPPLEMENTS (U.S. CLS. 6, 18, 44, 46, 51 AND 52).

CLASS 29—MEATS AND PROCESSED FOODS

FOR PROCESSED EDIBLE SEEDS AND PROCESSED NUTS (U.S. CL. 46).

CLASS 30—STAPLE FOODS

FOR COFFEE, TEA, COCOA, SALT, VINEGAR, SPICES, CANDY AND SNACK BARS MADE OF GRAINS AND CONTAINING SOY PROTEIN, VITAMINS AND MINERALS, FRUITS AND NUTS (U.S. CL. 46).

CLASS 32—LIGHT BEVERAGES

FOR BEERS; MINERAL AND AERATED WATERS; NON-ALCOHOLIC BEVERAGES, NAMELY, NON-ALCOHOLIC FRUIT JUICE BEVERAGES, BEVERAGES WITH TEA FLAVOR, CARBONATED BEVERAGES, APERITIFS, AND COCKTAIL MIXES, AND PREPARATIONS FOR MAKING ALL OF THE AFOREMENTIONED BEVERAGES; AND SYRUPS FOR BEVERAGES (U.S. CLS. 45, 46 AND 48).

CLASS 35—ADVERTISING AND BUSINESS

FOR WHOLESALE DISTRIBUTORSHIP, RETAIL STORE, ON-LINE RETAIL STORE AND MAIL ORDER STORE SERVICES FEATURING PERSONAL CARE PRODUCTS, HAIR AND SKIN CARE PRODUCTS, COSMETICS, PERSONAL HYGIENE PREPARATIONS, HOUSEHOLD CLEANING PREPARATIONS, CLEANERS, DIETARY SUPPLEMENTS, FOOD AND BEVERAGES (U.S. CLS. 100, 101 AND 102).

MARC LEIPZIG, EXAMINING ATTORNEY

SN 78-870,767. INTELLIGENT NUTRIENTS, INC., MINNEAPOLIS, MN. FILED 4-27-2006.

**INTELLIGENT NUTRIENTS
JASMINAS**

THE MARK CONSISTS OF STANDARD CHARACTERS WITHOUT CLAIM TO ANY PARTICULAR FONT, STYLE, SIZE, OR COLOR.

OWNER OF U.S. REG. NOS. 2,098,544, 2,930,189 AND OTHERS.

NO CLAIM IS MADE TO THE EXCLUSIVE RIGHT TO USE "NUTRIENTS", APART FROM THE MARK AS SHOWN.

CLASS 3—COSMETICS AND CLEANING PREPARATIONS

FOR HAIR CARE PRODUCTS NAMELY, SHAMPOOS, CONDITIONERS, SPRAY AND SCULPTING GELS, HAIR COLOR, AND WAVING LOTIONS; SKIN CARE PRODUCTS, NAMELY, SOAP, MOISTURIZERS, TONERS, SKIN CLEANING CREAMS, BODY LOTIONS AND GELS, BODY AND FACIAL LOTIONS, MASKS AND ASTRINGENTS; COSMETICS, NAMELY, LIPSTICK, EYE SHADOW, FOUNDATION, BLUSH, FACE POWDER, CONCEALOR, EYE PENCILS, LIP PENCILS AND MASCARA; PERSONAL HYGIENE PRODUCTS, NAMELY BATH AND BODY GELS, FRAGRANCES FOR PERSONAL USE, BODY OILS AND LOTIONS, SKIN CREAMS, SKIN LOTIONS, SKIN EMOLLIENTS, SKIN MOISTURIZING OILS AND LOTIONS; PERFUMES AND COLOGNES; AND HOUSEHOLD CLEANING PRODUCTS, NAMELY, ALL PURPOSE CLEANSERS, CLEANERS FOR USE ON DISHES, CLEANERS FOR USE ON FABRIC, AND CLEANSERS FOR USE ON FLOORS, WALLS, WINDOWS AND TOILETS; INCENSE AND ROOM FRAGRANCES; AND BREATH FRESHENERS (U.S. CLS. 1, 4, 6, 50, 51 AND 52).

CLASS 5—PHARMACEUTICALS

FOR DIETARY AND NUTRITIONAL SUPPLEMENTS (U.S. CLS. 6, 18, 44, 46, 51 AND 52).

CLASS 29—MEATS AND PROCESSED FOODS

FOR PROCESSED EDIBLE SEEDS AND PROCESSED NUTS (U.S. CL. 46).

CLASS 30—STAPLE FOODS

FOR COFFEE, TEA, COCOA, SALT, VINEGAR, SPICES, CANDY AND SNACK BARS MADE OF GRAINS AND CONTAINING SOY PROTEIN, VITAMINS AND MINERALS, FRUITS AND NUTS (U.S. CL. 46).

SN 78-871,286. BIG-TIME MARKETING, INC., ATLANTA, GA. FILED 4-27-2006.

CLASS 32—LIGHT BEVERAGES

FOR BEERS; MINERAL AND AERATED WATERS; NON-ALCOHOLIC BEVERAGES, NAMELY, NON-ALCOHOLIC FRUIT JUICE BEVERAGES, BEVERAGES WITH TEA FLAVOR, CARBONATED BEVERAGES, APERITIFS, AND COCKTAIL MIXES, AND PREPARATIONS FOR MAKING ALL OF THE AFOREMENTIONED BEVERAGES; AND SYRUPS FOR BEVERAGES (U.S. CLS. 45, 46 AND 48).

CLASS 35—ADVERTISING AND BUSINESS

FOR WHOLESALE DISTRIBUTORSHIP, RETAIL STORE, ON-LINE RETAIL STORE AND MAIL ORDER STORE SERVICES FEATURING PERSONAL CARE PRODUCTS, HAIR AND SKIN CARE PRODUCTS, COSMETICS, PERSONAL HYGIENE PREPARATIONS, HOUSEHOLD CLEANING PREPARATIONS, CLEANERS, DIETARY SUPPLEMENTS, FOOD AND BEVERAGES (U.S. CLS. 100, 101 AND 102).

MARC LEIPZIG, EXAMINING ATTORNEY

THE VORTEX

THE MARK CONSISTS OF STANDARD CHARACTERS WITHOUT CLAIM TO ANY PARTICULAR FONT, STYLE, SIZE, OR COLOR.

OWNER OF U.S. REG. NO. 1,941,190.

CLASS 25—CLOTHING

FOR APPAREL, NAMELY SHIRTS AND TANK TOPS (U.S. CLS. 22 AND 39).

FIRST USE 3-2-1993; IN COMMERCE 3-2-1993.

CLASS 42—SCIENTIFIC, COMPUTER AND LEGAL SERVICES

FOR BAR AND RESTAURANT SERVICES (U.S. CLS. 100 AND 101).

FIRST USE 3-2-1993; IN COMMERCE 3-2-1993.

MICHAEL ENGEL, EXAMINING ATTORNEY

SN 78-870,941. JONES HOLDINGS, LLC, CLEVELAND, TN. FILED 4-27-2006.

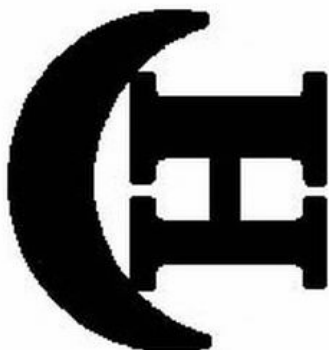

THE MARK CONSISTS OF A CRESCENT MOON AND A SIDEWAYS "H".

CLASS 25—CLOTHING

FOR HATS AND SHIRTS (U.S. CLS. 22 AND 39).
FIRST USE 10-18-2002; IN COMMERCE 10-18-2002.

CLASS 43—HOTEL AND RESTAURANT SERVICES

FOR GUEST RANCH SERVICES (U.S. CLS. 100 AND 101).
FIRST USE 0-0-1924; IN COMMERCE 0-0-1924.
JASON ROTH, EXAMINING ATTORNEY

SN 78-871,403. BELIEFNET, INC., NEW YORK, NY. FILED 4-27-2006.

JOVIALITES

THE MARK CONSISTS OF STANDARD CHARACTERS WITHOUT CLAIM TO ANY PARTICULAR FONT, STYLE, SIZE, OR COLOR.

CLASS 9—ELECTRICAL AND SCIENTIFIC APPARATUS

FOR ELECTRONIC GAME PROGRAMS; ELECTRONIC GAME SOFTWARE FOR HANDHELD ELECTRONIC DEVICES; INTERACTIVE VIDEO GAME PROGRAMS; PRE-RECORDED CD'S, VIDEO TAPES, LASER DISKS AND DVD'S FEATURING RELIGIOUS AND SPIRITUAL CHARACTERS (U.S. CLS. 21, 23, 26, 36 AND 38).

CLASS 21—HOUSEWARES AND GLASS

FOR MUGS (U.S. CLS. 2, 13, 23, 29, 30, 33, 40 AND 50).

CLASS 25—CLOTHING

FOR CAPS; HATS; SHORT-SLEEVED OR LONG-SLEEVED T-SHIRTS; SWEAT SHIRTS (U.S. CLS. 22 AND 39).

CLASS 28—TOYS AND SPORTING GOODS

FOR ACTION FIGURES; ACTION FIGURES AND ACCESSORIES THEREFOR; ACTION SKILL GAMES; ARCADE GAMES; ARCADE-TYPE ELECTRONIC VIDEO GAMES; BALLOONS; BATH TOYS; BENDABLE TOYS; BOARD GAMES; CARD GAMES; CASES FOR ACTION FIGURES; CASES FOR TOY VEHICLES; CHILDREN'S MULTIPLE ACTIVITY TOYS; CHILDREN'S PLAY COSMETICS; CHRISTMAS TREE DECORATIONS; CHRISTMAS TREE ORNAMENTS; COLLECTABLE TOY FIGURES; CONSTRUCTION TOYS; DOLL CASES; DOLL CLOTHING; DOLL COSTUMES; DOLLS AND ACCESSORIES THEREFOR; DOLLS AND PLAYSETS THEREFOR; DRAWING TOYS; ELECTRIC ACTION TOYS; ELECTRONIC EDUCATIONAL GAME MACHINES FOR CHILDREN; ELECTRONICALLY OPERATED TOY MOTOR VEHICLES; EQUIPMENT SOLD AS A UNIT FOR PLAYING A MEMORY GAME; EQUIPMENT SOLD AS A UNIT FOR PLAYING BOARD GAMES; EQUIPMENT SOLD AS A UNIT FOR PLAYING CARD GAMES; FANTASY CHARACTER TOYS; FLYING DISCS; HAND HELD UNIT FOR PLAYING ELECTRONIC GAMES; HAND HELD UNIT FOR PLAYING VIDEO GAMES; INFANT TOYS; INFLATABLE TOYS; JUMP ROPES; KITES; LCD GAME MACHINES; LEVER ACTION TOYS; MANIPULATIVE GAMES; MECHANICAL TOYS; MOLDED PLASTIC TOY FIGURINES; MOLDED TOY FIGURES; MUSICAL TOYS; PARLOR GAMES; PARTY GAMES; PLASTIC CHARACTER TOYS; PLAY FIGURES; PLAY MATS FOR USE WITH TOY VEHICLES; PLUSH TOYS; POP UP TOYS; POSITIONABLE TOY FIGURES; PULL TOYS; PUPPETS; PUSH TOYS; PUZZLES; RIDE-ON TOYS; RUBBER CHARACTER TOYS; SAND TOYS; SANDBOX TOYS; SOFT SCULPTURE PLUSH TOYS; SOFT SCULPTURE TOYS; SPORT BALLS; SQUEEZABLE SQUEAKING TOYS; SQUEEZE TOYS; STACKING TOYS; STUFFED DOLLS AND ANIMALS; STUFFED PUPPETS; STUFFED TOY ANIMALS; STUFFED TOYS; TALKING TOYS; TOY ACTION FIGURES; TOY ACTION FIGURES AND ACCESSORIES THEREFOR; TOY BOXES; TOY FIGURES; TOY FURNITURE; TOY VEHICLES; TOY VEHICLES AND ACCESSORIES THEREFOR; TOY, NAMELY, BATTERY-POWERED COMPUTER GAME WITH LCD SCREEN WHICH FEATURES ANIMATION AND SOUND EFFECTS; WIND-UP TOYS; YO-YOS (U.S. CLS. 22, 23, 38 AND 50).

WON TEAK OH, EXAMINING ATTORNEY

SN 78-871,411. FIRST GEAR, INC., PEOSTA, IA. FILED 4-27-2006.



OWNER OF U.S. REG. NOS. 1,775,338 AND 1,867,082.

CLASS 6—METAL GOODS

FOR FIGURINES OF COMMON METALS AND PEWTER FIGURINES (U.S. CLS. 2, 12, 13, 14, 23, 25 AND 50). FIRST USE 2-0-2006; IN COMMERCE 2-0-2006.

CLASS 16—PAPER GOODS AND PRINTED MATTER

FOR NEWSLETTERS REGARDING SCALE-MODEL REPLICA VEHICLES AND SCALE MODEL REPLICAS OF OTHER PRODUCTS (U.S. CLS. 2, 5, 22, 23, 29, 37, 38 AND 50).

FIRST USE 0-0-1996; IN COMMERCE 0-0-1996.

CLASS 28—TOYS AND SPORTING GOODS

FOR SCALE-MODEL REPLICAS OF SOLDIERS, OTHER PERSONS, ANIMALS, WEAPONS AND VEHICLES (U.S. CLS. 22, 23, 38 AND 50).

FIRST USE 2-0-2006; IN COMMERCE 2-0-2006.

BARBARA RUTLAND, EXAMINING ATTORNEY

SN 78-871,466. EYGN LIMITED, NASSAU, BAHAMAS, FILED 4-27-2006.

WHAT WE DO MATTERS

THE MARK CONSISTS OF STANDARD CHARACTERS WITHOUT CLAIM TO ANY PARTICULAR FONT, STYLE, SIZE, OR COLOR.

CLASS 9—ELECTRICAL AND SCIENTIFIC APPARATUS

FOR PRE-RECORDED AUDIO AND AUDIO-VIDEO RECORDINGS IN THE FIELDS OF ACCOUNTING, BUSINESS, ACCOUNT AUDITING, TAX PREPARATION, BUSINESS MANAGEMENT, FINANCIAL MANAGEMENT, AND INFORMATION TECHNOLOGY; COMPUTER SOFTWARE FOR USE IN PROCESSING, TRACKING, CALCULATING, MEASURING AND ANALYZING INFORMATION IN THE FIELDS OF ACCOUNTING, BUSINESS, ACCOUNT AUDITING, TAX PREPARATION, BUSINESS MANAGEMENT, FINANCIAL MANAGEMENT AND INFORMATION TECHNOLOGY (U.S. CLS. 21, 23, 26, 36 AND 38).

CLASS 16—PAPER GOODS AND PRINTED MATTER

FOR BOOKS, MANUALS, NEWSLETTERS, JOURNALS, BROCHURES AND PRINTED REPORTS ON THE SUBJECTS OF ACCOUNTING, BUSINESS, ACCOUNT AUDITING, TAX PREPARATION, BUSINESS MANAGEMENT, FINANCIAL MANAGEMENT, AND INFORMATION TECHNOLOGY (U.S. CLS. 2, 5, 22, 23, 29, 37, 38 AND 50).

CLASS 35—ADVERTISING AND BUSINESS

FOR TAX CONSULTATION, TAX PREPARATION, ACCOUNTING, BUSINESS AUDITING, AND BUSINESS CONSULTATION SERVICES; BUSINESS CONSULTATION IN THE FIELD OF INTELLECTUAL PROPERTY; HEALTH CARE UTILIZATION AND REVIEW SERVICES; HEALTH CARE COST REVIEW AND COST CONTAINMENT; BUSINESS MERGER AND ACQUISITION SERVICES, NAMELY, IDENTIFYING MERGER CANDIDATES AND BUYERS, AND NEGOTIATING FINANCING; FORENSIC ACCOUNTING; LEGISLATIVE ANALYSIS, NAMELY, TRACKING AND MONITORING FEDERAL AND STATE LEGISLATION IN THE FIELDS OF ACCOUNTING, BUSINESS, ACCOUNT AUDITING AND TAX; BUSINESS CONSULTATION IN THE NATURE OF ENVIRONMENTAL ADVISORY SERVICES, NAMELY, HELPING CLIENTS REDUCE THE RISK AND COST OF MANAGING ENVIRONMENTAL ISSUES THROUGH ASSESSMENTS OF MANAGEMENT PROCEDURES AND PHYSICAL OPERATIONS (U.S. CLS. 100, 101 AND 102).

CLASS 36—INSURANCE AND FINANCIAL

FOR CORPORATE FINANCE SERVICES, NAMELY, CORPORATE FINANCIAL CONSULTING, CORPORATE ASSET VALUATION, FINANCIAL VALUATION OF REAL AND PERSONAL PROPERTY, FINANCIAL ANALYSIS AND CONSULTATION, NAMELY, RESTRUCTURING OF BANKRUPT COMPANIES; AND INSURANCE CONSULTATION, NAMELY, INSURANCE REGULATORY SUPPORT AND ADVISORY SERVICES (U.S. CLS. 100, 101 AND 102).

CLASS 41—EDUCATION AND ENTERTAINMENT

FOR EDUCATIONAL SERVICES, NAMELY, CONDUCTING CLASSES AND SEMINARS IN THE FIELDS OF ACCOUNTING, BUSINESS, ACCOUNT AUDITING, TAX PREPARATION, BUSINESS MANAGEMENT, FINANCIAL MANAGEMENT, AND USE OF COMPUTER SOFTWARE (U.S. CLS. 100, 101 AND 107).

CLASS 42—SCIENTIFIC, COMPUTER AND LEGAL SERVICES

FOR LEGAL SERVICES, NAMELY, LITIGATION MANAGEMENT CONSULTING, DATA ANALYSIS, DAMAGE QUANTIFICATION, LITIGATION PREVENTION AND EARLY CASE ASSESSMENT; CONDUCTING ELECTRONIC DISCOVERY SERVICES VIA GLOBAL COMPUTER NETWORKS FOR LAWYERS AND CORPORATIONS; EXPERT WITNESS SERVICES AND EXPERT WITNESS TESTIMONY IN THE FIELD OF DAMAGES ANALYSIS, FRAUD INVESTIGATION AND CONTRACT DISPUTES; BANKRUPTCY LITIGATION SUPPORT SERVICES, NAMELY, DEBTOR SOLVENCY ANALYSIS, PLAN CONFIRMATION MATTERS, SUBSTANTIVE CONSOLIDATION AND EQUITABLE SUBORDINATION; INFORMATION TECHNOLOGY CONSULTING SERVICES; COMPUTER CONSULTATION IN THE FIELD OF COMPUTER SECURITY (U.S. CLS. 100 AND 101).

DAYNA BROWNE, EXAMINING ATTORNEY

SN 78-871,749. PAIROJ, THAWANSAKVUDHI, BANGKOK, THAILAND, FILED 4-28-2006.

AsiaCucina

THE MARK CONSISTS OF A STYLIZED LETTER "ASIA-CUCINA".

CLASS 20—FURNITURE AND ARTICLES NOT OTHERWISE CLASSIFIED

FOR KITCHEN CABINETS (U.S. CLS. 2, 13, 22, 25, 32 AND 50).

FIRST USE 10-7-2005; IN COMMERCE 1-8-2006.

CLASS 37—CONSTRUCTION AND REPAIR

FOR INSTALLATION OF KITCHEN CABINETS (U.S. CLS. 100, 103 AND 106).

FIRST USE 10-7-2005; IN COMMERCE 1-8-2006.
CORY BOONE, EXAMINING ATTORNEY

SN 78-871,771. SKEMA, INC., ATLANTA, GA. FILED 4-28-2006.

BARKOLOGY

THE MARK CONSISTS OF STANDARD CHARACTERS WITHOUT CLAIM TO ANY PARTICULAR FONT, STYLE, SIZE, OR COLOR.

OWNER OF U.S. REG. NO. 3,112,606.

CLASS 25—CLOTHING

FOR CAPS; JERSEYS; SHIRTS; T-SHIRTS; TOPS (U.S. CLS. 22 AND 39).

FIRST USE 11-30-2004; IN COMMERCE 11-30-2004.

CLASS 27—FLOOR COVERINGS

FOR DOOR MATS (U.S. CLS. 19, 20, 37, 42 AND 50).

FIRST USE 12-31-2005; IN COMMERCE 12-31-2005.

FRED MANDIR, EXAMINING ATTORNEY

SN 78-871,773. FIRST FOLIAGE LLC, HOMESTEAD, FL. FILED 4-28-2006.

Health, Harmony & Style

THE MARK CONSISTS OF STANDARD CHARACTERS WITHOUT CLAIM TO ANY PARTICULAR FONT, STYLE, SIZE, OR COLOR.

NO CLAIM IS MADE TO THE EXCLUSIVE RIGHT TO USE "STYLE", APART FROM THE MARK AS SHOWN.

CLASS 25—CLOTHING

FOR CLOTHING IN THE NATURE OF GARDENING ATTIRE, NAMELY, VESTS, APRONS, GLOVES AND CAPS (U.S. CLS. 22 AND 39).

CLASS 31—NATURAL AGRICULTURAL PRODUCTS

FOR LIVING PLANTS, NAMELY, FLOWERING AND NON-FLOWERING PLANTS FOR LANDSCAPING (U.S. CLS. 1 AND 46).

CLASS 44—MEDICAL, BEAUTY AND AGRICULTURAL SERVICES

FOR SERVICES RELATING TO THE GROWING OF PLANTS, NAMELY, LANDSCAPE GARDENING AND GARDEN DESIGN FOR OTHERS (U.S. CLS. 100 AND 101).

JAMES STEIN, EXAMINING ATTORNEY

SN 78-871,968. PLAYBOY ENTERPRISES INTERNATIONAL, INC., CHICAGO, IL. FILED 4-28-2006.

SN 78-872,145. BROADJAM, INC., MADISON, WI. FILED 4-28-2006.

BATH BUNNY

THE MARK CONSISTS OF STANDARD CHARACTERS WITHOUT CLAIM TO ANY PARTICULAR FONT, STYLE, SIZE, OR COLOR.

OWNER OF U.S. REG. NO. 810,555.
NO CLAIM IS MADE TO THE EXCLUSIVE RIGHT TO USE "BATH", APART FROM THE MARK AS SHOWN.

CLASS 3—COSMETICS AND CLEANING PREPARATIONS

FOR BODY LOTION; BODY SCRUB; LIP BALM; SHOWER GEL; SOAPS FOR BODY CARE (U.S. CLS. 1, 4, 6, 50, 51 AND 52).

CLASS 21—HOUSEWARES AND GLASS

FOR BATH PRODUCTS, NAMELY, LOOFAH SPONGES (U.S. CLS. 2, 13, 23, 29, 30, 33, 40 AND 50).
MARY ROSSMAN, EXAMINING ATTORNEY

SN 78-871,969. PLAYBOY ENTERPRISES INTERNATIONAL, INC., CHICAGO, IL. FILED 4-28-2006.

BATH

 BUNNY

OWNER OF U.S. REG. NOS. 679,997, 2,848,639 AND OTHERS.

NO CLAIM IS MADE TO THE EXCLUSIVE RIGHT TO USE "BATH", APART FROM THE MARK AS SHOWN.

THE MARK CONSISTS OF WORDS BATH BUNNY WITH RABBIT HEAD DESIGN IN THE MIDDLE.

CLASS 3—COSMETICS AND CLEANING PREPARATIONS

FOR BODY LOTION; BODY SCRUB; LIP BALM; SHOWER GEL; SOAPS FOR BODY CARE (U.S. CLS. 1, 4, 6, 50, 51 AND 52).

CLASS 21—HOUSEWARES AND GLASS

FOR BATH PRODUCTS, NAMELY, LOOFAH SPONGES (U.S. CLS. 2, 13, 23, 29, 30, 33, 40 AND 50).
MARY ROSSMAN, EXAMINING ATTORNEY

BROADJAM.COM

THE MARK CONSISTS OF STANDARD CHARACTERS WITHOUT CLAIM TO ANY PARTICULAR FONT, STYLE, SIZE, OR COLOR.

OWNER OF U.S. REG. NOS. 2,489,128, 2,528,326 AND OTHERS.

CLASS 35—ADVERTISING AND BUSINESS

FOR PROMOTING THE MUSIC OF OTHERS THROUGH THE DISSEMINATION OF INFORMATION ABOUT COMPOSERS, SONG WRITERS AND THEIR WORK ON A GLOBAL COMPUTER NETWORK; AND PROVIDING AN ON-LINE INTERACTIVE DATABASE OF MUSIC FOR USE IN ADVERTISING WHICH FEATURES SEARCHABLE INFORMATION AND AUDIO PLAYBACK CAPABILITIES (U.S. CLS. 100, 101 AND 102).
FIRST USE 3-1-2003; IN COMMERCE 3-1-2003.

CLASS 42—SCIENTIFIC, COMPUTER AND LEGAL SERVICES

FOR COMPUTER SERVICES, NAMELY, CREATING AND MAINTAINING WEB SITES FOR OTHERS; WEB-SITE DEVELOPMENT AND PROGRAMMING SERVICES FOR OTHERS, NAMELY, MULTI-MEDIA DATABASE DEVELOPMENT, DIGITAL COMPUTER AIDED DESIGN FOR OTHERS, DESIGN OF HOMEPAGES AND WEBSITES AND MANAGING WEBSITES FOR OTHERS; HOSTING THE WEB SITES OF OTHERS ON A COMPUTER SERVER FOR A GLOBAL COMPUTER NETWORK; TECHNICAL SUPPORT SERVICES, NAMELY, PROVIDING BACK-UP COMPUTER PROGRAMS AND FACILITIES; TECHNICAL SUPPORT SERVICES, NAMELY, TROUBLESHOOTING COMPUTER HARDWARE AND SOFTWARE PROBLEMS (U.S. CLS. 100 AND 101).

FIRST USE 3-1-2003; IN COMMERCE 3-1-2003.
HEATHER SAPP, EXAMINING ATTORNEY

SN 78-872,202. ERNIE BALL, INC., SAN LUIS OBISPO, CA. FILED 4-28-2006.

ERNIE
 BALL

OWNER OF U.S. REG. NOS. 855,571, 2,241,605 AND 2,769,185.

"ERNIE BALL" IDENTIFIES A LIVING INDIVIDUAL WHOSE CONSENT IS OF RECORD.

CLASS 15—MUSICAL INSTRUMENTS

FOR ACOUSTIC GUITARS; BASS GUITARS; ELECTRIC GUITARS; GUITAR PICKS; GUITAR STRAPS; GUITAR STRINGS; GUITARS; MUSICAL INSTRUMENTS, NAMELY, BASS GUITARS (U.S. CLS. 2, 21 AND 36).

FIRST USE 1-31-1962; IN COMMERCE 1-31-1962.

CLASS 41—EDUCATION AND ENTERTAINMENT

FOR CONDUCTING ENTERTAINMENT EXHIBITIONS IN THE NATURE OF MUSICAL PERFORMANCES AND COMPETITIONS; ENTERTAINMENT IN THE NATURE OF COMPETITIONS IN THE FIELD OF MUSICAL PERFORMANCES; ENTERTAINMENT IN THE NATURE OF LIVE PERFORMANCES BY MUSICIANS AND LIVE BANDS OR MUSICAL GROUPS; ENTERTAINMENT IN THE NATURE OF VISUAL AND AUDIO PERFORMANCES, NAMELY, MUSICAL BAND, ROCK GROUP, GYMNASTIC, DANCE, AND BALLET PERFORMANCES; ENTERTAINMENT IN THE NATURE OF PROMOTING, SPONSORING AND CONDUCTING MUSICAL PERFORMANCES AND COMPETITIONS; PROVIDING LIVE MUSIC PERFORMANCES BY MUSICAL BANDS; CONDUCTING COMPETITIONS BY LIVE BANDS; ENTERTAINMENT NAMELY, LIVE PERFORMANCES BY A MUSICAL BAND; ENTERTAINMENT NAMELY, PRODUCTION OF MUSICAL PERFORMANCES AND COMPETITIONS BY LIVE BANDS; ENTERTAINMENT SERVICES, NAMELY, ARRANGING AND CONDUCTING OF COMPETITIONS FOR MUSICAL PERFORMANCES BY LIVE BANDS; ENTERTAINMENT SERVICES, NAMELY, CONDUCTING CONTESTS; ENTERTAINMENT SERVICES, NAMELY, PARTICIPATION IN MUSICAL PERFORMANCES AND COMPETITIONS BY LIVE BANDS; ENTERTAINMENT SERVICES, NAMELY, PERSONAL APPEARANCES BY A MUSICIAN OR LIVE BAND OR MUSICAL GROUP; ENTERTAINMENT, NAMELY LIVE MUSIC CONCERTS; ENTERTAINMENT, NAMELY LIVE PERFORMANCES BY MUSICAL BANDS; ENTERTAINMENT, NAMELY, LIVE PERFORMANCES BY ROCK GROUPS; ORGANIZING EXHIBITIONS FOR MUSICAL PERFORMANCES AND COMPETITIONS (U.S. CLS. 100, 101 AND 107).

FIRST USE 6-26-1997; IN COMMERCE 6-26-1997.
GRETTA YAO, EXAMINING ATTORNEY

CLASS 28—TOYS AND SPORTING GOODS

FOR SPORTING GOODS, NAMELY SOCCER BALLS, FOOTBALLS, TENNIS BALLS AND PROTECTIVE SHIN GUARDS FOR PLAYING SOCCER (U.S. CLS. 22, 23, 38 AND 50).

FIRST USE 10-1-1975; IN COMMERCE 10-19-1995.
CHRIS DONINGER, EXAMINING ATTORNEY

SN 78-873,010. NEW MEXICO LOTTERY AUTHORITY, ALBUQUERQUE, NM. FILED 4-30-2006.

Measuring Success In Degrees

THE MARK CONSISTS OF STANDARD CHARACTERS WITHOUT CLAIM TO ANY PARTICULAR FONT, STYLE, SIZE, OR COLOR.

CLASS 36—INSURANCE AND FINANCIAL

FOR PROVIDING EDUCATIONAL SCHOLARSHIPS (U.S. CLS. 100, 101 AND 102).

FIRST USE 1-1-2004; IN COMMERCE 2-1-2004.

CLASS 41—EDUCATION AND ENTERTAINMENT

FOR LOTTERY SERVICES (U.S. CLS. 100, 101 AND 107).

FIRST USE 1-1-2004; IN COMMERCE 2-1-2004.
GEOFFREY FOSDICK, EXAMINING ATTORNEY

SN 78-873,077. FIRST FOLIAGE LLC, HOMESTEAD, FL. FILED 5-1-2006.

Salud, Armonia Y Estilo

THE MARK CONSISTS OF STANDARD CHARACTERS WITHOUT CLAIM TO ANY PARTICULAR FONT, STYLE, SIZE, OR COLOR.

NO CLAIM IS MADE TO THE EXCLUSIVE RIGHT TO USE "ESTILO", APART FROM THE MARK AS SHOWN.

THE ENGLISH TRANSLATION OF THE WORD SALUD, ARMONIA Y ESTILO IN THE MARK IS "HEALTH, HARMONY AND STYLE".

CLASS 25—CLOTHING

FOR CLOTHING IN THE NATURE OF GARDENING ATTIRE, NAMELY, VESTS, APRONS, GLOVES AND CAPS (U.S. CLS. 22 AND 39).

CLASS 31—NATURAL AGRICULTURAL PRODUCTS

FOR LIVING PLANTS, NAMELY, FLOWERING AND NON-FLOWERING PLANTS FOR LANDSCAPING (U.S. CLS. 1 AND 46).

SN 78-872,520. GARCIS, S.A. DE C.V., MEXICO CITY, MEXICO, FILED 4-28-2006.

THE MARK CONSISTS OF THE STYLIZED WORD 'GARCIS' AND A WINGED HERON TO THE RIGHT SIDE OF THE WORD.

CLASS 25—CLOTHING

FOR ATHLETIC WEAR, NAMELY, UNIFORMS, SHIRTS, SHORTS, SWEAT SHIRTS, PANTS, CAPS, SPORTS FOOTWEAR, CASUAL FOOTWEAR, SOCCER FOOTWEAR, BIKING AND HIKING FOOTWEAR, TENNIS FOOTWEAR (U.S. CLS. 22 AND 39).

FIRST USE 10-1-1975; IN COMMERCE 10-19-1995.

CLASS 44—MEDICAL, BEAUTY AND AGRICULTURAL SERVICES

FOR SERVICES RELATING TO THE GROWING OF PLANTS, NAMELY, LANDSCAPE GARDENING AND GARDEN DESIGN FOR OTHERS (U.S. CLS. 100 AND 101).

JAMES STEIN, EXAMINING ATTORNEY

SN 78-873,257. SANDHILLS PUBLISHING COMPANY, LINCOLN, NE. FILED 5-1-2006.

First Glimpse

SN 78-873,193. O.C. TANNER COMPANY, SALT LAKE CITY, UT. FILED 5-1-2006.

INSPIRE PERFORMANCE. ACCELERATE RESULTS.

THE MARK CONSISTS OF STANDARD CHARACTERS WITHOUT CLAIM TO ANY PARTICULAR FONT, STYLE, SIZE, OR COLOR.

CLASS 35—ADVERTISING AND BUSINESS

FOR CREATION OF RECOGNITION AND INCENTIVE AWARD PROGRAMS FOR OTHERS, NAMELY, EMPLOYEE ACHIEVEMENT, PRODUCTIVITY, PERFORMANCE, SALES, SERVICE, CUSTOMER SATISFACTION, QUALITY, SAFETY, RETIREMENT, EVENT, AND OTHER RECOGNITION AND INCENTIVE AWARD PROGRAMS WITH AWARDS OF FINE JEWELRY, RINGS, WATCHES, CORPORATE EMBLEMS AND SYMBOLS, WRITING INSTRUMENTS, ACTIVE AND SPORTS ACCESSORIES, CLOCKS, ELECTRONICS, OFFICE ACCESSORIES, CRYSTAL, HOME ACCESSORIES, PLAQUES, AND OTHER FINE GIFTS, MERCHANDISE, CASH, TRAVEL, AND OTHER AWARDS AND INCENTIVES; ADMINISTRATION OF RECOGNITION AND INCENTIVE AWARD PROGRAMS FOR OTHERS TO PROMOTE JOB SAFETY, QUALITY, PRODUCTIVITY, PERFORMANCE, SALES, SERVICE, AND CUSTOMER SATISFACTION (U.S. CLS. 100, 101 AND 102).

CLASS 41—EDUCATION AND ENTERTAINMENT

FOR EDUCATIONAL SERVICES, NAMELY, CONDUCTING SEMINARS, CLASSES AND WORKSHOPS FOR RECOGNITION AND INCENTIVE AWARD PROGRAMS FOR ADMINISTRATORS, MANAGERS, AND PARTICIPANTS ABOUT FORMAL AND INFORMAL RECOGNITION TECHNIQUES INCLUDING IMPROVING EFFECTIVENESS OF AWARD PRESENTATION (U.S. CLS. 100, 101 AND 107).

CLASS 42—SCIENTIFIC, COMPUTER AND LEGAL SERVICES

FOR DESIGN FOR OTHERS IN THE FIELD OF PRINTED AND ON-LINE RECIPIENT AWARD SELECTION BROCHURES, CERTIFICATES, CARDS, PROMOTIONAL AND OTHER COMMUNICATION MATERIALS FOR USE WITH RECOGNITION AND INCENTIVE AWARD PROGRAMS (U.S. CLS. 100 AND 101).

MARK T. MULLEN, EXAMINING ATTORNEY

THE MARK CONSISTS OF STANDARD CHARACTERS WITHOUT CLAIM TO ANY PARTICULAR FONT, STYLE, SIZE, OR COLOR.

CLASS 16—PAPER GOODS AND PRINTED MATTER

FOR MAGAZINE RELATED TO CONSUMER ELECTRONICS (U.S. CLS. 2, 5, 22, 23, 29, 37, 38 AND 50).

FIRST USE 4-25-2006; IN COMMERCE 4-25-2006.

CLASS 41—EDUCATION AND ENTERTAINMENT

FOR COMPUTER SERVICES, NAMELY, PROVIDING AN ONLINE MAGAZINE RELATED TO CONSUMER ELECTRONICS (U.S. CLS. 100, 101 AND 107).

FIRST USE 4-25-2006; IN COMMERCE 4-25-2006.

GILBERT SWIFT, EXAMINING ATTORNEY

SN 78-873,463. OLD MOTHER HUBBARD, INC., CHELMSFORD, MA. FILED 5-1-2006.

HEALTHY INDULGENCE

THE MARK CONSISTS OF STANDARD CHARACTERS WITHOUT CLAIM TO ANY PARTICULAR FONT, STYLE, SIZE, OR COLOR.

NO CLAIM IS MADE TO THE EXCLUSIVE RIGHT TO USE "HEALTHY", APART FROM THE MARK AS SHOWN.

CLASS 5—PHARMACEUTICALS

FOR VITAMINS FOR PETS; DIETARY SUPPLEMENTS FOR PETS; NUTRACEUTICALS FOR USE AS DIETARY SUPPLEMENTS FOR PETS (U.S. CLS. 6, 18, 44, 46, 51 AND 52).

CLASS 31—NATURAL AGRICULTURAL PRODUCTS

FOR PET FOOD AND PET TREATS (U.S. CLS. 1 AND 46).

ATTIYA MALIK, EXAMINING ATTORNEY

SN 78-873,609. SOMEBODY CARES TAMPA BAY, INC.,
CLEARWATER, FL. FILED 5-1-2006.

SN 78-874,248. BELLSOUTH INTELLECTUAL PROPERTY
CORPORATION, WILMINGTON, DE. FILED 5-2-2006.

CAREFEST

PC 2 GO

THE MARK CONSISTS OF STANDARD CHARACTERS
WITHOUT CLAIM TO ANY PARTICULAR FONT, STYLE,
SIZE, OR COLOR.

THE MARK CONSISTS OF STANDARD CHARACTERS
WITHOUT CLAIM TO ANY PARTICULAR FONT, STYLE,
SIZE, OR COLOR.

CLASS 25—CLOTHING

FOR HATS; SHIRTS; T-SHIRTS (U.S. CLS. 22 AND 39).
FIRST USE 9-1-2001; IN COMMERCE 9-1-2001.

CLASS 9—ELECTRICAL AND SCIENTIFIC APPARATUS

FOR REMOTE DESKTOP SOFTWARE FOR USE IN
TRANSMITTING DATA BETWEEN COMPUTERS AND
OTHER ELECTRONIC DEVICES (U.S. CLS. 21, 23, 26, 36
AND 38).

CLASS 35—ADVERTISING AND BUSINESS

FOR CHARITABLE SERVICES, NAMELY ORGANIZ-
ING AND CONDUCTING VOLUNTEER PROGRAMS
AND COMMUNITY SERVICE PROJECTS (U.S. CLS.
100, 101 AND 102).

FIRST USE 9-1-2001; IN COMMERCE 9-1-2001.
TINA L. SNAPP, EXAMINING ATTORNEY

CLASS 38—COMMUNICATION

FOR TELECOMMUNICATIONS SERVICES; NAMELY,
ELECTRONIC TRANSMISSION OF MESSAGES, DATA,
IMAGES, VIDEO AND INFORMATION VIA A GLOBAL
COMPUTER COMMUNICATIONS NETWORK (U.S. CLS.
100, 101 AND 104).

NORA BUCHANAN WILL, EXAMINING ATTORNEY

SN 78-874,018. FINISHRICH, INC., NEW YORK, NY. FILED
5-2-2006.

SN 78-874,300. ALLERGAN, INC., IRVINE, CA. FILED 5-2-
2006.

FINISH RICH

BREAST IMPLANTS TODAY

THE MARK CONSISTS OF STANDARD CHARACTERS
WITHOUT CLAIM TO ANY PARTICULAR FONT, STYLE,
SIZE, OR COLOR.

OWNER OF U.S. REG. NOS. 2,671,222, 2,694,730 AND
2,867,154.

THE MARK CONSISTS OF STANDARD CHARACTERS
WITHOUT CLAIM TO ANY PARTICULAR FONT, STYLE,
SIZE, OR COLOR.

NO CLAIM IS MADE TO THE EXCLUSIVE RIGHT TO
USE "BREAST IMPLANTS", APART FROM THE MARK AS
SHOWN.

CLASS 9—ELECTRICAL AND SCIENTIFIC APPARATUS

FOR SERIES OF PRE-RECORDED CD-ROMS, AUDIO
CASSETTE TAPES, VIDEOTAPES AND DVDS FEATUR-
ING INVESTMENT ADVICE AND FINANCIAL PLAN-
NING (U.S. CLS. 21, 23, 26, 36 AND 38).

FIRST USE 0-0-1994; IN COMMERCE 0-0-1999.

CLASS 35—ADVERTISING AND BUSINESS

FOR PROVIDING INFORMATION VIA A WEBSITE
FOR LOCATING A DOCTOR WHO PERFORMS BREAST
SURGERY (U.S. CLS. 100, 101 AND 102).

CLASS 16—PAPER GOODS AND PRINTED MATER

FOR SERIES OF NON-FICTION BOOKS IN THE
FIELDS OF INVESTMENT ADVICE AND FINANCIAL
PLANNING; NEWSLETTERS IN THE FIELDS OF IN-
VESTMENT ADVICE AND FINANCIAL PLANNING
(U.S. CLS. 2, 5, 22, 23, 29, 37, 38 AND 50).

FIRST USE 0-0-1998; IN COMMERCE 0-0-1999.
GEORGIA CARTY, EXAMINING ATTORNEY

CLASS 44—MEDICAL, BEAUTY AND AGRI- CULTURAL SERVICES

FOR PROVIDING INFORMATION VIA A WEBSITE
ON A WIDE RANGE OF INFORMATION CONCERNING
BREAST SURGERY OPTIONS AND SHARING PEER
SURGICAL EXPERIENCES CONCERNING BREAST
SURGERY (U.S. CLS. 100 AND 101).

CATHERINE FAINT, EXAMINING ATTORNEY

SN 78-874,767. EXTREMELY GIFTED INC., SAN MARCOS, TX. FILED 5-2-2006.



THE COLOR(S) BLACK, WHITE, BLUE AND TURQUOISE IS/ARE CLAIMED AS A FEATURE OF THE MARK.

THE MARK CONSISTS OF STYLIZED LETTERING WITH BLACK "EXTREMELY" EXCEPT FOR BLUE "X" AND ALSO BLUE "GIFTED" AND TURQUOISE AND WHITE UNDERLINING.

CLASS 35—ADVERTISING AND BUSINESS

FOR ISSUING GIFT CERTIFICATES WHICH MAY THEN BE REDEEMED FOR GOODS OR SERVICES (U.S. CLS. 100, 101 AND 102).

FIRST USE 3-17-2006; IN COMMERCE 3-17-2006.

CLASS 42—SCIENTIFIC, COMPUTER AND LEGAL SERVICES

FOR DESIGNING OF PACKAGING AND WRAPPING MATERIALS (U.S. CLS. 100 AND 101).

FIRST USE 3-17-2006; IN COMMERCE 3-17-2006.

CLASS 45—PERSONAL SERVICES

FOR GIFT WRAPPING; PREPARATION OF CUSTOMIZED GIFT BASKETS; PREPARATION OF CUSTOMIZED GIFT BASKETS WITH SELECTED ITEMS REGARDING A PARTICULAR OCCASION OR THEME (U.S. CLS. 100 AND 101).

FIRST USE 3-17-2006; IN COMMERCE 3-17-2006.
WILLIAM VERHOSEK, EXAMINING ATTORNEY

SN 78-875,789. THE ANIMAL HOUSE PET CLINIC, S.C., GREEN BAY, WI. FILED 5-3-2006.



NO CLAIM IS MADE TO THE EXCLUSIVE RIGHT TO USE "HOUSE" FOR CLASS 043, APART FROM THE MARK AS SHOWN.

THE MARK CONSISTS OF THE STYLIZED WORDS THE ANIMAL HOUSE WITH THE LETTER "M" FORMED TO DEPICT A BUILDING WITH A PEAKED ROOF; EMERGING FROM THE ROOF IS THE PROFILE OF A CAT'S HEAD POINTING TO THE LEFT AND THE PROFILE OF A DOG'S HEAD POINTING TO THE RIGHT.

CLASS 43—HOTEL AND RESTAURANT SERVICES

FOR PET BOARDING SERVICES; PET DAY CARE SERVICES (U.S. CLS. 100 AND 101).

FIRST USE 4-15-2004; IN COMMERCE 4-15-2004.

CLASS 44—MEDICAL, BEAUTY AND AGRICULTURAL SERVICES

FOR ANIMAL GROOMING; VETERINARY SERVICES (U.S. CLS. 100 AND 101).

FIRST USE 4-15-2004; IN COMMERCE 4-15-2004.

ANDREW RHIM, EXAMINING ATTORNEY

SN 78-875,885. A & A MIDWEST REBUILDERS SUPPLIERS, INC., CHICAGO, IL. FILED 5-3-2006.

AAEQ

THE MARK CONSISTS OF STANDARD CHARACTERS WITHOUT CLAIM TO ANY PARTICULAR FONT, STYLE, SIZE, OR COLOR.

CLASS 35—ADVERTISING AND BUSINESS

FOR WHOLESALE STORE SERVICES IN THE FIELD OF AUTO PARTS, ENGINE CORES, SCRAP METAL, TRANSMISSION CORES, TRANSFER CASE CORES, TORQUE CONVERTERS (U.S. CLS. 100, 101 AND 102).

CLASS 40—MATERIAL TREATMENT

FOR MANUFACTURING OF AUTOMOTIVE DRIVE TRAIN COMPONENTS TO THE ORDER AND/OR SPECIFICATION OF OTHERS, NAMELY, ENGINE CYLINDER HEADS FOR LAND VEHICLE ENGINES, AUTOMOTIVE ENGINE BLOCKS FOR CARS AND TRUCKS, CRANKSHAFTS FOR CARS AND TRUCKS, ENGINE CONNECTING RODS FOR CARS AND TRUCKS, INTAKE AND EXHAUST MANIFOLDS FOR CARS AND TRUCKS, AND ENGINE TIMING COMPONENTS FOR CARS AND TRUCKS, NAMELY, TIMING COVERS; RECYCLING SCRAP METALS (U.S. CLS. 100, 103 AND 106).

CHRISTINE COOPER, EXAMINING ATTORNEY

SN 78-876,206. BRODER BROS., CO., TREVOSE, PA. FILED 5-4-2006.



OWNER OF U.S. REG. NOS. 1,978,685 AND 2,930,590.

CLASS 18—LEATHER GOODS

FOR TOTE BAGS, MESSENGER BAGS, HANDBAGS, BACKPACKS (U.S. CLS. 1, 2, 3, 22 AND 41).

FIRST USE 1-0-2004; IN COMMERCE 1-0-2004.

CLASS 25—CLOTHING

FOR CLOTHING, NAMELY, HENLEYS, T-SHIRTS, LONG SLEEVE T-SHIRTS, SWEATSHIRTS, SWEATPANTS, SHORTS, HATS, WOVEN SHIRTS AND BOTTOMS (U.S. CLS. 22 AND 39).

FIRST USE 1-25-1994; IN COMMERCE 1-25-1994.
TRAVIS WHEATLEY, EXAMINING ATTORNEY

CLASS 43—HOTEL AND RESTAURANT SERVICES

FOR COFFEE-HOUSE SERVICES (U.S. CLS. 100 AND 101).

FIRST USE 6-1-2001; IN COMMERCE 6-1-2001.
HEATHER THOMPSON, EXAMINING ATTORNEY

SN 78-876,243. EXTREMELY GIFTED INC., SAN MARCOS, TX. FILED 5-4-2006.

SN 78-879,811. FLEXI-MAT CORPORATION, PLAINFIELD, IL. FILED 5-9-2006.

eXtremely Gifted

THE MARK CONSISTS OF STANDARD CHARACTERS WITHOUT CLAIM TO ANY PARTICULAR FONT, STYLE, SIZE, OR COLOR.

CLASS 35—ADVERTISING AND BUSINESS

FOR ADVERTISING SERVICES, NAMELY, PROMOTING THE GIFT CARDS OF OTHERS; COMPUTERIZED ON-LINE GIFT ORDERING SERVICE WHICH MATCHES THE GIFT GIVER'S REQUIREMENTS WITH THE GIFT RECIPIENT'S WANTS AND NEEDS; ISSUING GIFT CERTIFICATES WHICH MAY THEN BE REDEEMED FOR GOODS OR SERVICES (U.S. CLS. 100, 101 AND 102).

FIRST USE 1-22-2004; IN COMMERCE 3-17-2006.

CLASS 42—SCIENTIFIC, COMPUTER AND LEGAL SERVICES

FOR DESIGNING OF PACKAGING AND WRAPPING MATERIALS (U.S. CLS. 100 AND 101).

FIRST USE 1-22-2006; IN COMMERCE 3-17-2006.

CLASS 45—PERSONAL SERVICES

FOR GIFT WRAPPING; PREPARATION OF CUSTOMIZED GIFT BASKETS; PREPARATION OF CUSTOMIZED GIFT BASKETS WITH SELECTED ITEMS REGARDING A PARTICULAR OCCASION OR THEME (U.S. CLS. 100 AND 101).

FIRST USE 1-22-2004; IN COMMERCE 3-17-2006.
WILLIAM VERHOSEK, EXAMINING ATTORNEY

SN 78-879,206. MASARWEH, JOSEPH E., CAPITOLA, CA. FILED 5-8-2006.

GOOD FRIENDS GREAT COFFEE

THE MARK CONSISTS OF STANDARD CHARACTERS WITHOUT CLAIM TO ANY PARTICULAR FONT, STYLE, SIZE, OR COLOR.

CLASS 30—STAPLE FOODS

FOR COFFEE (U.S. CL. 46).
FIRST USE 6-1-2001; IN COMMERCE 6-1-2001.

SOFT TOUCH

THE MARK CONSISTS OF STANDARD CHARACTERS WITHOUT CLAIM TO ANY PARTICULAR FONT, STYLE, SIZE, OR COLOR.

CLASS 12—VEHICLES

FOR PET CARE PRODUCTS, NAMELY, SEAT SAFETY HARNESSES USED FOR SECURING A DOG IN AN AUTOMOBILE, PET AUTO SEATS (U.S. CLS. 19, 21, 23, 31, 35 AND 44).

CLASS 18—LEATHER GOODS

FOR PET CARE PRODUCTS, NAMELY, DOG HARNESSES (U.S. CLS. 1, 2, 3, 22 AND 41).

CLASS 20—FURNITURE AND ARTICLES NOT OTHERWISE CLASSIFIED

FOR PET BEDS; PET CARE PRODUCTS, NAMELY, PET PILLOWS, PET CARRIERS AND PET KENNELS (U.S. CLS. 2, 13, 22, 25, 32 AND 50).

BRENDAN REGAN, EXAMINING ATTORNEY

SN 78-880,410. CSX IP, INC., JACKSONVILLE, FL. FILED 5-10-2006.

THE GREENBRIER

THE MARK CONSISTS OF STANDARD CHARACTERS WITHOUT CLAIM TO ANY PARTICULAR FONT, STYLE, SIZE, OR COLOR.

OWNER OF U.S. REG. NOS. 1,618,123, 2,754,408 AND OTHERS.

CLASS 35—ADVERTISING AND BUSINESS

FOR RETAIL FURNITURE AND HOUSEHOLD DECORATIVE ACCESSORY STORES (U.S. CLS. 100, 101 AND 102).

CLASS 42—SCIENTIFIC, COMPUTER AND LEGAL SERVICES

FOR INTERIOR DECORATION CONSULTATION (U.S. CLS. 100 AND 101).
DORITT L. CARROLL, EXAMINING ATTORNEY

SN 78-883,245. SALADO SALES, INC., TEMPLE, TX. FILED 5-15-2006.

CVP

THE MARK CONSISTS OF STANDARD CHARACTERS WITHOUT CLAIM TO ANY PARTICULAR FONT, STYLE, SIZE, OR COLOR.

OWNER OF U.S. REG. NOS. 1,924,371 AND 1,962,235.

CLASS 3—COSMETICS AND CLEANING PREPARATIONS

FOR TOOTH PASTE; MOUTHWASH; NON-MEDICATED MOUTHWASH AND GARGLE; COTTON FOR COSMETIC PURPOSES; PERSONAL DEODORANTS; NAIL BUFFING PREPARATIONS; EMERY BOARDS; NAIL POLISH REMOVER; ALL PURPOSE COTTON SWABS FOR PERSONAL USE; FACE AND BODY LOTIONS; BABY WIPES; BABY SHAMPOO; BABY LOTION; BABY OIL; BABY POWDER; LAUNDRY PREPARATIONS; NAMELY, BLEACH; LIQUID FABRIC SOFTENER; FABRIC SOFTENER DRYER SHEETS; LAUNDRY DETERGENT; DISHWASHING DETERGENT; DISHWASHER DETERGENT; ALL PURPOSE CLEANERS FOR HOUSEHOLD USE AND AMMONIA (U.S. CLS. 1, 4, 6, 50, 51 AND 52).

FIRST USE 4-18-1994; IN COMMERCE 7-5-1994.

CLASS 4—LUBRICANTS AND FUELS

FOR CHARCOAL; CHARCOAL BRIQUETTES, LIGHTER FLUID; FIREPLACE LOGS (U.S. CLS. 1, 6 AND 15).

FIRST USE 5-10-2004; IN COMMERCE 6-14-2004.

CLASS 5—PHARMACEUTICALS

FOR HAND SANITIZER FOR HOUSEHOLD USE; MEDICATED OINTMENT FOR DIAPER RASH; EYE DROPS; EYE WASHES; CONTACT LENS SOLUTIONS; SALINE NASAL SPRAYS; EAR DROPS; HYDROGEN PEROXIDE FOR MEDICAL USE; RUBBING ALCOHOL; ALCOHOL FOR TOPICAL USE; COTTON SWABS FOR MEDICAL USE; EPSON SALTS; ANTIBIOTIC OINTMENTS; TOPICAL ANALGESICS; TOPICAL ALLERGY MEDICATIONS; FEMININE HYGIENE PADS; PANTY LINERS; TAMPONS; ANTIBIOTIC CREAMS; ANTI-ITCH LOTION; HYDROCORTISONE CREAM; GAUZE PADS; MEDICAL ADHESIVE TAPE; ADHESIVE BANDAGES; GAUZE; PREPARATIONS FOR TREATING COLDS AND COUGHS; COUGH SYRUPS; EXPECTORANTS; COUGH DROPS; THROAT LOZENGES; ORAL ALLERGY MEDICATIONS; ANTIHISTAMINES; DECONGESTANTS; NASAL SPRAY PREPARATIONS; PETROLEUM JELLY FOR MEDICAL PURPOSES; ANTACIDS; LAXATIVES; ORAL ANALGESICS; PAIN RELIEF MEDICATION; ASPIRIN; SLEEP PILLS AND TABLETS; ANTI-SLEEPING PILLS AND MEDICAL DENTAL RINSE; ALL PURPOSE DISINFECTANTS, AIR FRESHENERS, INSECTICIDES FOR DOMESTIC USE AND RODENTICIDES (U.S. CLS. 6, 18, 44, 46, 51 AND 52).

FIRST USE 5-1-1994; IN COMMERCE 5-1-1994.

CLASS 8—HAND TOOLS

FOR RAZOR BLADES; RAZORS AND PLASTIC CUTLERY (U.S. CLS. 23, 28 AND 44).

FIRST USE 0-0-1996; IN COMMERCE 0-0-1996.

CLASS 16—PAPER GOODS AND PRINTED MATTER

FOR FACIAL TISSUE; DISPOSABLE DIAPERS; BATH TISSUE; PAPER TOWELS; PAPER NAPKINS; KITCHEN TRASH BAGS; LAWN TRASH BAGS; LARGE HOUSEHOLD TRASH BAGS; PLASTIC FOOD STORAGE, SANDWICH AND FREEZER BAGS FOR HOUSEHOLD USE; PLASTIC WRAP FOR HOUSEHOLD USE; TRANSPARENT AND INVISIBLE ADHESIVE TAPE FOR HOUSEHOLD USE; PAPER FILTERS FOR COFFEE MAKERS (U.S. CLS. 2, 5, 22, 23, 29, 37, 38 AND 50).

FIRST USE 12-14-1993; IN COMMERCE 4-1-1994.

CLASS 21—HOUSEWARES AND GLASS

FOR NON-ELECTRIC TOOTHBRUSHES; PAPER PLATES, BOWLS AND CUPS; FOAM PLATES, BOWLS AND CUPS; PLASTIC PLATES, BOWLS AND CUPS (U.S. CLS. 2, 13, 23, 29, 30, 33, 40 AND 50).

FIRST USE 3-21-1994; IN COMMERCE 8-15-1994.

CLASS 29—MEATS AND PROCESSED FOODS

FOR PROCESSED NUTS (U.S. CL. 46).

FIRST USE 3-14-2006; IN COMMERCE 5-15-2006.

CLASS 30—STAPLE FOODS

FOR CANDY (U.S. CL. 46).

FIRST USE 5-4-2004; IN COMMERCE 8-1-2004.

ANGELA M. MICHELI, EXAMINING ATTORNEY

SN 78-884,229. JOHNSON & JOHNSON, NEW BRUNSWICK, NJ. FILED 5-16-2006.

ADVANCING ORAL
HEALTH...IMPROVING OVERALL
HEALTH

THE MARK CONSISTS OF STANDARD CHARACTERS WITHOUT CLAIM TO ANY PARTICULAR FONT, STYLE, SIZE, OR COLOR.

CLASS 5—PHARMACEUTICALS

FOR HUMAN PHARMACEUTICALS FOR PERIODONTITIS (U.S. CLS. 6, 18, 44, 46, 51 AND 52).

CLASS 16—PAPER GOODS AND PRINTED MATTER

FOR PROMOTIONAL MATERIALS, NAMELY, BROCHURES RELATED TO PERIODONTITIS (U.S. CLS. 2, 5, 22, 23, 29, 37, 38 AND 50).

CORY BOONE, EXAMINING ATTORNEY

SN 78-886,640. VALENCIA, DEBRA, HERMOSA BEACH, CA.
FILED 5-18-2006.

vida valencia

THE MARK CONSISTS OF STANDARD CHARACTERS WITHOUT CLAIM TO ANY PARTICULAR FONT, STYLE, SIZE, OR COLOR.

THE ENGLISH TRANSLATION OF THE WORD "VIDA" IN THE MARK IS "LIFE".

CLASS 3—COSMETICS AND CLEANING PREPARATIONS

FOR BATH SALTS; BODY LOTIONS; BUBBLE BATH; ESSENTIAL OILS; LIP GLOSS; SOAPS FOR BODY CARE (U.S. CLS. 1, 4, 6, 50, 51 AND 52).

CLASS 16—PAPER GOODS AND PRINTED MATTER

FOR ENVELOPES; GIFT WRAP PAPER; GREETING CARDS; PAPER BOXES; PAPER GIFT BAGS; STATIONERY (U.S. CLS. 2, 5, 22, 23, 29, 37, 38 AND 50).

CLASS 20—FURNITURE AND ARTICLES NOT OTHERWISE CLASSIFIED

FOR CHAIRS; PICTURE FRAMES; PILLOWS; TABLES; WOOD BOXES; WOODEN JEWELLERY BOXES (U.S. CLS. 2, 13, 22, 25, 32 AND 50).

CLASS 21—HOUSEWARES AND GLASS

FOR BEVERAGE GLASSWARE; CERAMIC SCULPTURES, VASES, VESSELS, BOWLS, PLATES AND POTS; CUPS; DISHES AND PLATES; MUGS; VASES (U.S. CLS. 2, 13, 23, 29, 30, 33, 40 AND 50).

CLASS 24—FABRICS

FOR BED BLANKETS; BED LINEN; BED SHEETS; TEXTILE FABRICS FOR HOME AND COMMERCIAL INTERIORS; TEXTILE PLACE MATS; TEXTILE TABLECLOTHS; TOWELLING COVERLETS; TOWELS (U.S. CLS. 42 AND 50).

JIM RINGLE, EXAMINING ATTORNEY

SN 78-887,079. BEN & JERRY'S HOMEMADE, INC., BURLINGTON, VT. FILED 5-18-2006.

ADDICTED TO CHOCOLATE

THE MARK CONSISTS OF STANDARD CHARACTERS WITHOUT CLAIM TO ANY PARTICULAR FONT, STYLE, SIZE, OR COLOR.

CLASS 29—MEATS AND PROCESSED FOODS

FOR DAIRY-BASED BEVERAGES (U.S. CL. 46).

CLASS 30—STAPLE FOODS

FOR FROZEN CONFECTIONS; ICE CREAM (U.S. CL. 46).
PETER CHENG, EXAMINING ATTORNEY

SN 78-887,280. THE WET SEAL, INC., FOOTHILL RANCH, CA. FILED 5-18-2006.



THE MARK CONSISTS OF A BUTTERFLY DESIGN.

CLASS 25—CLOTHING

FOR CLOTHING, NAMELY, HATS, CAPS, VISORS, GLOVES, MITTENS, SCARVES, BELTS, TIES, SOCKS, TIGHTS, HOSIERY, STOCKINGS, SHOES, BOOTS, SLIPPERS, BLOUSES, SHIRTS, CAMISOLES, TOPS, TANK-TOPS, T-SHIRTS, SWEATSHIRTS, PULLOVERS, SWEATERS, BLAZERS, JACKETS, COATS, DRESSES, SKIRTS, SKORTS, CAPRIS, JEANS, SHORTS, PANTS, SWEAT-PANTS, UNDERWEAR, BRAS, PANTIES, SLIPS, TEDDIES, NIGHTGOWNS, PAJAMAS, SLEEP SHIRTS, BATHROBES, LINGERIE, BEACH COVER-UPS, SWIMWEAR, RAINWEAR (U.S. CLS. 22 AND 39).
FIRST USE 5-12-2005; IN COMMERCE 6-0-2005.

CLASS 35—ADVERTISING AND BUSINESS

FOR RETAIL AND ONLINE RETAIL STORE SERVICES IN THE FIELD OF CLOTHING AND ACCESSORIES (U.S. CLS. 100, 101 AND 102).
FIRST USE 3-28-2005; IN COMMERCE 6-0-2005.
JOHN LINCOSKI, EXAMINING ATTORNEY

SN 78-888,361. THE STELOR GROUP LIMITED, LLC, DARNESTOWN, MD. FILED 5-19-2006.

REDEFINING TRUST IN INTERNET SECURITY

THE MARK CONSISTS OF STANDARD CHARACTERS WITHOUT CLAIM TO ANY PARTICULAR FONT, STYLE, SIZE, OR COLOR.

CLASS 9—ELECTRICAL AND SCIENTIFIC APPARATUS

FOR DOWNLOADABLE COMPUTER COMMUNICATION SOFTWARE FOR ACCESSING ELECTRONICALLY ACTIVATED ACCESS CONTROL MECHANISMS, ELECTRONIC LOCKS, AND COMPUTERS (U.S. CLS. 21, 23, 26, 36 AND 38).

CLASS 42—SCIENTIFIC, COMPUTER AND LEGAL SERVICES

FOR PROVIDING TEMPORARY USE OF NON-DOWNLOADABLE COMPUTER COMMUNICATION SOFTWARE FOR ACCESSING ELECTRONICALLY ACTIVATED ACCESS CONTROL MECHANISMS, ELECTRONIC LOCKS, AND COMPUTERS (U.S. CLS. 100 AND 101).

ELIZABETH J. WINTER, EXAMINING ATTORNEY

SN 78-893,121. WAKA, LLC, CHANTILLY, VA. FILED 5-25-2006.

LEADERS CUP

THE MARK CONSISTS OF STANDARD CHARACTERS WITHOUT CLAIM TO ANY PARTICULAR FONT, STYLE, SIZE, OR COLOR.

NO CLAIM IS MADE TO THE EXCLUSIVE RIGHT TO USE "CUP" IN INTERNATIONAL CLASS 41, APART FROM THE MARK AS SHOWN.

CLASS 25—CLOTHING

FOR CAPS; DRESS SHIRTS; GOLF SHIRTS; HEADBANDS AGAINST SWEATING; HOODS; JERSEYS; KNIT SHIRTS; MANTLES; OPEN-NECKED SHIRTS; PERSPIRATION ABSORBENT UNDERWEAR CLOTHING; POLO SHIRTS; SHIRTS; SHIRTS; SHORT-SLEEVED OR LONG-SLEEVED T-SHIRTS; SHORT-SLEEVED SHIRTS; SHOULDER WRAPS; SPORT SHIRTS; STOCKINGS; SWEAT BANDS; SWEAT PANTS; SWEAT SHIRTS; SWEAT SHORTS; SWEAT SUITS; T-SHIRTS; TOPS; UNDERARM CLOTHING SHIELDS; WIND SHIRTS; WRAPS (U.S. CLS. 22 AND 39).

CLASS 41—EDUCATION AND ENTERTAINMENT

FOR ENTERTAINMENT IN THE NATURE OF COMPETITIONS IN THE FIELD OF KICKBALL TOURNAMENTS AND GAMES; ENTERTAINMENT IN THE NATURE OF KICKBALL GAMES; ENTERTAINMENT IN THE NATURE OF KICKBALL TOURNAMENTS; ENTERTAINMENT SERVICES NAMELY PROVIDING A WEBSITE FEATURING, PHOTOGRAPHIC, AUDIO, VIDEO AND PROSE PRESENTATIONS FEATURING KICKBALL LEAGUES, GAMES, TOURNAMENTS AND COMPETITIONS; ENTERTAINMENT SERVICES, NAMELY, PARTICIPATION IN KICKBALL TOURNAMENTS, LEAGUES AND COMPETITIONS; PROVIDING FACILITIES FOR KICKBALL TOURNAMENTS (U.S. CLS. 100, 101 AND 107).

BONNIE LUKEN, EXAMINING ATTORNEY

SN 78-896,434. MARKMONITOR INC., BOISE, ID. FILED 5-30-2006.

BUY GENUINE

THE MARK CONSISTS OF STANDARD CHARACTERS WITHOUT CLAIM TO ANY PARTICULAR FONT, STYLE, SIZE, OR COLOR.

CLASS 35—ADVERTISING AND BUSINESS

FOR MANAGEMENT AND BUSINESS CONSULTING SERVICES IN THE FIELD OF COUNTERFEIT AND GRAY MARKET PRODUCT DETECTION (U.S. CLS. 100, 101 AND 102).

CLASS 42—SCIENTIFIC, COMPUTER AND LEGAL SERVICES

FOR PROVIDING ONLINE NON-DOWNLOADABLE SOFTWARE FOR COUNTERFEIT AND GRAY MARKET PRODUCT DETECTION (U.S. CLS. 100 AND 101).

ELISSA GARBER KON, EXAMINING ATTORNEY

SN 78-897,467. NEW MEXICO LOTTERY AUTHORITY, ALBUQUERQUE, NM. FILED 5-31-2006.

Benefitting New Mexico's Future

THE MARK CONSISTS OF STANDARD CHARACTERS WITHOUT CLAIM TO ANY PARTICULAR FONT, STYLE, SIZE, OR COLOR.

CLASS 36—INSURANCE AND FINANCIAL

FOR PROVIDING EDUCATIONAL SCHOLARSHIPS (U.S. CLS. 100, 101 AND 102).

FIRST USE 4-27-1996; IN COMMERCE 4-27-1996.

CLASS 41—EDUCATION AND ENTERTAINMENT

FOR LOTTERY SERVICES (U.S. CLS. 100, 101 AND 107).

FIRST USE 4-27-1996; IN COMMERCE 4-27-1996.

GEOFFREY FOSDICK, EXAMINING ATTORNEY

SN 78-897,661. JAKKS PACIFIC, INC., MALIBU, CA. FILED 5-31-2006.



THE MARK CONSISTS OF THE WORD VMIGO STYLIZED.

CLASS 9—ELECTRICAL AND SCIENTIFIC APPARATUS

FOR HAND HELD JOY STICK UNITS FOR PLAYING VIDEO GAMES; INTERACTIVE VIDEO GAME PROGRAMS; JOYSTICKS FOR VIDEO GAMES; VIDEO GAME CARTRIDGES; VIDEO GAME JOYSTICKS; VIDEO OUTPUT GAME MACHINES FOR USE WITH TELEVISIONS (U.S. CLS. 21, 23, 26, 36 AND 38).

CLASS 28—TOYS AND SPORTING GOODS

FOR BABY MULTIPLE ACTIVITY TOYS; CHILDREN'S MULTIPLE ACTIVITY TOYS; HAND HELD UNIT FOR PLAYING ELECTRONIC GAMES; HAND HELD UNIT FOR PLAYING VIDEO GAMES; HAND-HELD GAMES WITH LIQUID CRYSTAL DISPLAYS; MUSICAL TOYS; STAND ALONE VIDEO OUTPUT GAME MACHINES; STUFFED TOYS; TOY ANIMALS AND ACCESSORIES THEREFORE; TOY FIGURES; TOY, NAMELY, BATTERY-POWERED COMPUTER GAME WITH LCD SCREEN WHICH FEATURES ANIMATION AND SOUND EFFECTS (U.S. CLS. 22, 23, 38 AND 50).

ADA HAN, EXAMINING ATTORNEY

SN 78-899,611. BISSELL HOMECARE, INC., GRAND RAPIDS, MI. FILED 6-2-2006.

ORGANIC CLEAN

THE MARK CONSISTS OF STANDARD CHARACTERS WITHOUT CLAIM TO ANY PARTICULAR FONT, STYLE, SIZE, OR COLOR.

NO CLAIM IS MADE TO THE EXCLUSIVE RIGHT TO USE "CLEAN", APART FROM THE MARK AS SHOWN.

CLASS 7—MACHINERY

FOR FLOOR STEAM CLEANING MACHINES; VACUUM CLEANERS; AND WATER EXTRACTION CLEANING MACHINES FOR CARPET, UPHOLSTERY, AND HARD FLOORS (U.S. CLS. 13, 19, 21, 23, 31, 34 AND 35).

CLASS 21—HOUSEWARES AND GLASS

FOR BROOMS FOR HARD FLOOR SURFACES, NON-ELECTRIC CARPET AND FLOOR SWEEPERS, DUST PANS, FEATHER BROOMS, FEATHER DUSTERS, FLOOR BRUSHES, MOPS, AND SQUEEGEES (U.S. CLS. 2, 13, 23, 29, 30, 33, 40 AND 50).

GEORGIA CARTY, EXAMINING ATTORNEY

SN 78-899,568. PLATINUM PERFORMANCE INC., BUELLTON, CA. FILED 6-2-2006.

FEEDING FOR THE FUTURE

THE MARK CONSISTS OF STANDARD CHARACTERS WITHOUT CLAIM TO ANY PARTICULAR FONT, STYLE, SIZE, OR COLOR.

CLASS 5—PHARMACEUTICALS

FOR NUTRITIONAL SUPPLEMENTS (U.S. CLS. 6, 18, 44, 46, 51 AND 52).

CLASS 31—NATURAL AGRICULTURAL PRODUCTS

FOR ANIMAL FEED (U.S. CLS. 1 AND 46).
TOBY BULLOFF, EXAMINING ATTORNEY

SN 78-900,837. CHURCH & DWIGHT CO., INC., PRINCETON, NJ. FILED 6-5-2006.

SN 78-899,569. PLATINUM PERFORMANCE INC., BUELLTON, CA. FILED 6-2-2006.

ARE YOU FEEDING FOR THE FUTURE

THE MARK CONSISTS OF STANDARD CHARACTERS WITHOUT CLAIM TO ANY PARTICULAR FONT, STYLE, SIZE, OR COLOR.

CLASS 5—PHARMACEUTICALS

FOR NUTRITIONAL SUPPLEMENTS (U.S. CLS. 6, 18, 44, 46, 51 AND 52).

CLASS 31—NATURAL AGRICULTURAL PRODUCTS

FOR ANIMAL FEED (U.S. CLS. 1 AND 46).
TOBY BULLOFF, EXAMINING ATTORNEY

TOSS 'N FRESH

THE MARK CONSISTS OF STANDARD CHARACTERS WITHOUT CLAIM TO ANY PARTICULAR FONT, STYLE, SIZE, OR COLOR.

CLASS 3—COSMETICS AND CLEANING PREPARATIONS

FOR CARPET CLEANERS; CARPET CLEANERS WITH DEODORIZER; CARPET CLEANING PREPARATIONS (U.S. CLS. 1, 4, 6, 50, 51 AND 52).

CLASS 5—PHARMACEUTICALS

FOR AIR DEODORANT; AIR DEODORIZER; AIR FRESHENERS; AIR FRESHENING PREPARATIONS; CAR DEODORIZER; CARPET DEODORIZERS; DEODORIZERS FOR AUTOMOBILES (U.S. CLS. 6, 18, 44, 46, 51 AND 52).

TANYA AMOS, EXAMINING ATTORNEY

SN 78-902,439. INTERFACE, INC., ATLANTA, GA. FILED 6-7-2006.



CLASS 5—PHARMACEUTICALS

FOR ANTIMICROBIAL PREPARATIONS FOR USE IN THE TREATMENT, SANITATION, AND DISINFECTING OF CARPETS AND FABRICS (U.S. CLS. 6, 18, 44, 46, 51 AND 52).

CLASS 24—FABRICS

FOR TEXTILE FABRICS FOR USE IN THE MANUFACTURE OF UPHOLSTERY, OFFICE PARTITION PANELS AND SCREENS, CEILING COVERS, AND WALL HANGINGS (U.S. CLS. 42 AND 50).

CLASS 27—FLOOR COVERINGS

FOR CARPETING (U.S. CLS. 19, 20, 37, 42 AND 50).

CLASS 37—CONSTRUCTION AND REPAIR

FOR INSTALLATION AND MAINTENANCE OF CARPET (U.S. CLS. 100, 103 AND 106).

CLASS 42—SCIENTIFIC, COMPUTER AND LEGAL SERVICES

FOR DESIGN OF CARPET AND FABRIC FOR OTHERS (U.S. CLS. 100 AND 101).
KATHRYN COWARD, EXAMINING ATTORNEY

SN 78-907,796. REHELbacher, HORST, OSCEOLA, WI. FILED 6-14-2006.

HORST

THE MARK CONSISTS OF STANDARD CHARACTERS WITHOUT CLAIM TO ANY PARTICULAR FONT, STYLE, SIZE, OR COLOR.

CLASS 3—COSMETICS AND CLEANING PREPARATIONS

FOR HAIR CARE PRODUCTS NAMELY, SHAMPOOS, CONDITIONERS, SPRAY AND SCULPTING GELS, HAIR COLOR, AND WAVING LOTIONS; SKIN CARE PRODUCTS, NAMELY, SOAP, MOISTURIZERS, TONERS, SKIN CLEANING CREAMS, BODY LOTIONS AND GELS, BODY AND FACIAL LOTIONS, MASKS AND ASTRINGENTS; COSMETICS, NAMELY, LIPSTICK, EYE SHADOW, FOUNDATION, BLUSH, FACE POWDER, CONCEALER, EYE PENCILS, LIP PENCILS AND MASCARA; PERSONAL HYGIENE PRODUCTS, NAMELY BATH AND BODY GELS, FRAGRANCES FOR PERSONAL USE, BODY OILS AND LOTIONS, SKIN CREAMS, SKIN LOTIONS, SKIN EMOLLIENTS, SKIN MOISTURIZING OILS AND LOTIONS; PERFUMES AND COLOGNES; AND HOUSEHOLD CLEANING PRODUCTS, NAMELY, ALL PURPOSE CLEANSERS, CLEANERS FOR USE ON DISHES, CLEANERS FOR USE ON FABRIC, AND CLEANSERS FOR USE ON FLOORS, WALLS, WINDOWS AND TOILETS; INCENSE AND ROOM FRAGRANCES; BREATH FRESHENERS (U.S. CLS. 1, 4, 6, 50, 51 AND 52).

CLASS 4—LUBRICANTS AND FUELS

FOR CANDLES (U.S. CLS. 1, 6 AND 15).

CLASS 5—PHARMACEUTICALS

FOR DIETARY SUPPLEMENTS, PERSONAL LUBRICANTS, CHOLESTEROL REDUCERS, COUGH LOZENGES, DECONGESTANTS, LAXATIVES AND MEDICATED LIP BALM (U.S. CLS. 6, 18, 44, 46, 51 AND 52).

CLASS 29—MEATS AND PROCESSED FOODS

FOR PROCESSED EDIBLE SEEDS AND PROCESSED NUTS (U.S. CL. 46).

CLASS 30—STAPLE FOODS

FOR SNACK BARS MADE OF GRAINS AND CONTAINING SOY PROTEIN, VITAMINS AND MINERALS, FRUITS AND NUTS; COFFEE, TEA, COCOA, SALT, VINEGAR, SPICES, CANDY (U.S. CL. 46).

CLASS 32—LIGHT BEVERAGES

FOR BEERS; MINERAL AND AERATED WATERS; NON-ALCOHOLIC BEVERAGES, NAMELY, NON-ALCOHOLIC FRUIT JUICE BEVERAGES, BEVERAGES WITH TEA FLAVOR, CARBONATED BEVERAGES, APERITIFS, AND COCKTAIL MIXES, AND PREPARATIONS FOR MAKING ALL OF THE AFOREMENTIONED BEVERAGES; AND SYRUPS FOR BEVERAGES (U.S. CLS. 45, 46 AND 48).

CLASS 35—ADVERTISING AND BUSINESS

FOR WHOLESALE DISTRIBUTORSHIP, RETAIL STORE, ON-LINE RETAIL STORE AND MAIL ORDER STORE SERVICES FEATURING DIETARY SUPPLEMENTS, SNACK BARS, PERSONAL CARE PRODUCTS, HAIR AND SKIN CARE PRODUCTS, COSMETICS, PERSONAL HYGIENE PREPARATIONS, HOUSEHOLD CLEANING PREPARATIONS, CLEANERS, FOOD AND BEVERAGES, BOOKS, DVD'S AND AUDIO RECORDINGS (U.S. CLS. 100, 101 AND 102).

CLASS 43—HOTEL AND RESTAURANT SERVICES

FOR RESTAURANT AND BAR SERVICES; PROVIDING BANQUET AND SOCIAL FUNCTION FACILITIES FOR SPECIAL OCCASIONS (U.S. CLS. 100 AND 101).
MARC LEIPZIG, EXAMINING ATTORNEY

SN 78-912,577. DEGUSSA BUILDING SYSTEMS, SHAKOPEE, MN. FILED 6-20-2006.

EMACO

THE MARK CONSISTS OF STANDARD CHARACTERS WITHOUT CLAIM TO ANY PARTICULAR FONT, STYLE, SIZE, OR COLOR.

CLASS 2—PAINTS

FOR COATINGS IN THE NATURE OF POLYMER-BASED COMPOSITIONS USED FOR PROTECTING AND RESTORING CEMENTITIOUS SURFACES AND STRUCTURAL ELEMENTS, NAMELY REINFORCING BAR (REBAR) (U.S. CLS. 6, 11 AND 16).

CLASS 19—NON-METALLIC BUILDING MATERIALS

FOR CEMENTITIOUS MIXTURE IN THE NATURE OF FAST-SETTING HYDRAULIC-CEMENT MORTAR, CEMENTITIOUS BONDING AGENTS, REPAIR MORTARS FOR LEVELING OR RESURFACING DISTRESSED CONCRETE BOTH INTERIOR AND EXTERIOR AND GROUTS (U.S. CLS. 1, 12, 33 AND 50).

WENDY GOODMAN, EXAMINING ATTORNEY

SN 78-912,759. TITAN NUTRITION, INC., DBA KOLOSEUM NUTRITIONAL SCIENCES, BREA, CA. FILED 6-20-2006.



NO CLAIM IS MADE TO THE EXCLUSIVE RIGHT TO USE "NUTRITIONAL SCIENCES", APART FROM THE MARK AS SHOWN.

THE ENGLISH TRANSLATION OF KOLOSEUM IS "COLLOSSEUM."

CLASS 5—PHARMACEUTICALS

FOR DIETARY AND NUTRITIONAL SUPPLEMENTS (U.S. CLS. 6, 18, 44, 46, 51 AND 52).

CLASS 9—ELECTRICAL AND SCIENTIFIC APPARATUS

FOR PRE-RECORDED VIDEO TAPES AND DVD'S FEATURING EXERCISE, FITNESS, WEIGHT TRAINING, NUTRITIONAL INFORMATION AND INSTRUCTION (U.S. CLS. 21, 23, 26, 36 AND 38).

CLASS 25—CLOTHING

FOR SPORT SHIRTS, T-SHIRTS, TANK TOPS, SPORTS BRAS, LEOTARDS, SWIMSUITS, SWEATSHIRTS, SWEATPANTS, SHORTS, JACKETS, HOODED JACKETS, AND TRACK SUITS; HEADWEAR, NAMELY, SWEATBANDS, SPORT HATS, AND CAPS; FOOTWEAR, NAMELY, SOCKS, PEDS, SANDALS, FLIPFLOPS, AND TENNIS SHOES (U.S. CLS. 22 AND 39).

CLASS 41—EDUCATION AND ENTERTAINMENT

FOR EDUCATIONAL SERVICES, NAMELY, PHYSICAL FITNESS AND WEIGHT TRAINING INSTRUCTION THROUGH PRIVATE INSTRUCTION OR SEMINARS IN THE FIELDS OF NUTRITION, DIET AND EXERCISE AND PRINTED MATERIALS USED IN CONNECTION THEREWITH (U.S. CLS. 100, 101 AND 107).

ALLISON SCHRODY, EXAMINING ATTORNEY

SN 78-915,607. JAKKS PACIFIC, INC., MALIBU, CA. FILED 6-23-2006.

THE MARK CONSISTS OF THE WORD VMIGO STYLIZED.

CLASS 9—ELECTRICAL AND SCIENTIFIC APPARATUS

FOR HAND HELD JOY STICK UNITS FOR PLAYING VIDEO GAMES; INTERACTIVE VIDEO GAME PROGRAMS; JOYSTICKS FOR VIDEO GAMES; VIDEO GAME CARTRIDGES; VIDEO GAME JOYSTICKS; VIDEO OUTPUT GAME MACHINES FOR USE WITH TELEVISIONS (U.S. CLS. 21, 23, 26, 36 AND 38).

CLASS 28—TOYS AND SPORTING GOODS

FOR BABY MULTIPLE ACTIVITY TOYS; CHILDREN'S MULTIPLE ACTIVITY TOYS; HAND HELD UNIT FOR PLAYING ELECTRONIC GAMES; HAND HELD UNIT FOR PLAYING VIDEO GAMES; HAND-HELD GAMES WITH LIQUID CRYSTAL DISPLAYS; MUSICAL TOYS; STAND ALONE VIDEO OUTPUT GAME MACHINES; STUFFED TOYS; TOY ANIMALS AND ACCESSORIES THEREFORE; TOY FIGURES; TOY, NAMELY, BATTERY-POWERED COMPUTER GAME WITH LCD SCREEN WHICH FEATURES ANIMATION AND SOUND EFFECTS (U.S. CLS. 22, 23, 38 AND 50).

ADA HAN, EXAMINING ATTORNEY

SN 78-920,329. POMWONDERFUL LLC, LOS ANGELES, CA.
FILED 6-29-2006.



CLASS 3—COSMETICS AND CLEANING PREPARATIONS

FOR NON-MEDICATED BREATH FRESHENING DISSOLVING STRIPS; NON-MEDICATED ORAL CARE DISSOLVING STRIPS; NON-MEDICATED MOUTHWASH AND TOOTHPASTE (U.S. CLS. 1, 4, 6, 50, 51 AND 52).

CLASS 5—PHARMACEUTICALS

FOR PREPARATIONS FOR TREATING COUGHS, COLDS AND FLUS; COUGH EXPECTORANTS, COUGH DROPS, COUGH LOZENGES, COUGH SYRUPS, COUGH TABLETS, PILLS, STRIPS, LIQUIDS AND MISTS; MEDICATED BREATH FRESHENING DISSOLVING STRIPS; MEDICATED ORAL CARE DISSOLVING STRIPS; MEDICATED MOUTHWASH AND TOOTHPASTE; CONFECTIONERIES FOR MEDICINAL PURPOSES, NAMELY, CHEWING GUM, MEDICATED CANDY CHEWS, CANDY AND MINTS (U.S. CLS. 6, 18, 44, 46, 51 AND 52).

CLASS 30—STAPLE FOODS

FOR NON-MEDICATED CONFECTIONERIES, NAMELY, CHEWING GUM, CANDY CHEWS, CANDY AND MINTS (U.S. CL. 46).
BARBARA A. LOUGHRAN, EXAMINING ATTORNEY

SN 78-921,724. ARBONNE INTERNATIONAL, LLC, IRVINE, CA. FILED 7-2-2006.

Arbonne = REsults

THE MARK CONSISTS OF STANDARD CHARACTERS WITHOUT CLAIM TO ANY PARTICULAR FONT, STYLE, SIZE, OR COLOR.
OWNER OF U.S. REG. NOS. 1,770,981, 2,096,008 AND OTHERS.

CLASS 3—COSMETICS AND CLEANING PREPARATIONS

FOR NON-MEDICATED SKIN CARE PREPARATIONS (U.S. CLS. 1, 4, 6, 50, 51 AND 52).

CLASS 5—PHARMACEUTICALS

FOR DIETARY AND NUTRITIONAL SUPPLEMENTS; HERBAL SUPPLEMENTS; VITAMIN AND MINERAL SUPPLEMENTS (U.S. CLS. 6, 18, 44, 46, 51 AND 52).

CLASS 16—PAPER GOODS AND PRINTED MATTER

FOR PRINTED INSTRUCTIONAL, EDUCATIONAL, AND TEACHING MATERIALS IN THE FIELD OF FRAGRANCES, TOILETRIES, SKIN, HAIR, BEAUTY, COSMETIC AND HEALTH CARE PRODUCTS (U.S. CLS. 2, 5, 22, 23, 29, 37, 38 AND 50).

CLASS 35—ADVERTISING AND BUSINESS

FOR RETAIL SHOP-AT-HOME PARTY SERVICES IN THE FIELD OF FRAGRANCES, TOILETRIES, SKIN, HAIR, BEAUTY, COSMETIC AND HEALTH CARE PRODUCTS (U.S. CLS. 100, 101 AND 102).
KATHERINE STOIDES, EXAMINING ATTORNEY

SN 78-921,725. ARBONNE INTERNATIONAL, LLC, IRVINE, CA. FILED 7-2-2006.

Arbonne = REsultados

THE MARK CONSISTS OF STANDARD CHARACTERS WITHOUT CLAIM TO ANY PARTICULAR FONT, STYLE, SIZE, OR COLOR.

OWNER OF U.S. REG. NOS. 1,770,981, 2,096,008 AND OTHERS.

THE ENGLISH TRANSLATION OF RESULTADOS IS RESULTS.

CLASS 3—COSMETICS AND CLEANING PREPARATIONS

FOR NON-MEDICATED SKIN CARE PREPARATIONS (U.S. CLS. 1, 4, 6, 50, 51 AND 52).

CLASS 5—PHARMACEUTICALS

FOR DIETARY AND NUTRITIONAL SUPPLEMENTS; HERBAL SUPPLEMENTS; VITAMIN AND MINERAL SUPPLEMENTS (U.S. CLS. 6, 18, 44, 46, 51 AND 52).

CLASS 16—PAPER GOODS AND PRINTED MATTER

FOR PRINTED INSTRUCTIONAL, EDUCATIONAL, AND TEACHING MATERIALS IN THE FIELD OF FRAGRANCES, TOILETRIES, SKIN, HAIR, BEAUTY, COSMETIC AND HEALTH CARE PRODUCTS (U.S. CLS. 2, 5, 22, 23, 29, 37, 38 AND 50).

CLASS 35—ADVERTISING AND BUSINESS

FOR RETAIL SHOP-AT-HOME PARTY SERVICES IN THE FIELD OF FRAGRANCES, TOILETRIES, SKIN, HAIR, BEAUTY, COSMETIC AND HEALTH CARE PRODUCTS (U.S. CLS. 100, 101 AND 102).
KATHERINE STOIDES, EXAMINING ATTORNEY

SN 78-924,513. ZACK, STEPHEN BURKE, CORSICANA, TX.
FILED 7-7-2006.

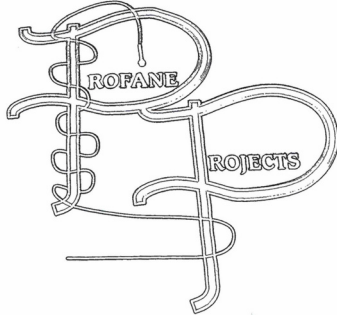

THE MARK CONSISTS OF THE WORDING "PROFANE PROJECTS" WITH ENLARGED, STYLIZED "P"'S, AND A MICROPHONE AND CORD WINDING AROUND THE WORDING.

CLASS 9—ELECTRICAL AND SCIENTIFIC APPARATUS

FOR AUDIO RECORDINGS FEATURING MUSIC (U.S. CLS. 21, 23, 26, 36 AND 38).

CLASS 41—EDUCATION AND ENTERTAINMENT

FOR MUSIC PRODUCTION SERVICES (U.S. CLS. 100, 101 AND 107).
CORY BOONE, EXAMINING ATTORNEY

CLASS 36—INSURANCE AND FINANCIAL

FOR REAL ESTATE MANAGEMENT SERVICES; REAL ESTATE INVESTMENT OF COMMERCIAL PROPERTIES; MORTGAGE BANKING AND MORTGAGE PROCUREMENT FOR OTHERS; CONSTRUCTION FINANCING FOR HOMEBUILDERS; INSURANCE UNDERWRITING FOR HOMEBUYERS IN THE FIELDS OF HOME AND AUTO INSURANCE; TITLE INSURANCE UNDERWRITING IN THE FIELD OF REAL ESTATE; FINANCIAL SERVICES, NAMELY, PROVIDING CONSTRUCTION LOAN FINANCING FOR HOMEBUILDERS (U.S. CLS. 100, 101 AND 102).

CLASS 37—CONSTRUCTION AND REPAIR

FOR LAND DEVELOPMENT SERVICES, NAMELY, PLANNING AND LAYING OUT OF RESIDENTIAL AND/OR COMMERCIAL COMMUNITIES, RETAIL, INDUSTRIAL AND DISTRIBUTION SPACE, AND APARTMENTS; COMMERCIAL REAL ESTATE PROPERTY DEVELOPMENT (U.S. CLS. 100, 103 AND 106).
PAUL F. GAST, EXAMINING ATTORNEY

SN 78-928,874. VERDE REALTY OPERATING PARTNERSHIP, L.P., EL PASO, TX. FILED 7-13-2006.



SN 78-928,865. VERDE REALTY OPERATING PARTNERSHIP, L.P., EL PASO, TX. FILED 7-13-2006.

NO CLAIM IS MADE TO THE EXCLUSIVE RIGHT TO USE "COMMUNITY", APART FROM THE MARK AS SHOWN.

THE MARK CONSISTS OF THE WORDS RIALTA MESA A VERDE COMMUNITY AS PART OF A STYLIZED LOGO. THE TERM "VERDE" TRANSLATES INTO ENGLISH AS "GREEN".



THE MARK CONSISTS OF THE WORDS RIALTA MESA AT SANTA TERESA AS PART OF A STYLIZED LOGO. THE TERM "SANTA" TRANSLATES INTO ENGLISH AS "SAINT".

CLASS 36—INSURANCE AND FINANCIAL

FOR REAL ESTATE MANAGEMENT SERVICES; REAL ESTATE INVESTMENT OF COMMERCIAL PROPERTIES; MORTGAGE BANKING AND MORTGAGE PROCUREMENT FOR OTHERS; CONSTRUCTION FINANCING FOR HOMEBUILDERS; INSURANCE UNDERWRITING FOR HOMEBUYERS IN THE FIELDS OF HOME AND AUTO INSURANCE; TITLE INSURANCE UNDERWRITING IN THE FIELD OF REAL ESTATE; FINANCIAL SERVICES, NAMELY, PROVIDING CONSTRUCTION LOAN FINANCING FOR HOMEBUILDERS (U.S. CLS. 100, 101 AND 102).

CLASS 37—CONSTRUCTION AND REPAIR

FOR LAND DEVELOPMENT SERVICES, NAMELY, PLANNING AND LAYING OUT OF RESIDENTIAL AND/OR COMMERCIAL COMMUNITIES, RETAIL, INDUSTRIAL AND DISTRIBUTION SPACE, AND APARTMENTS; COMMERCIAL REAL ESTATE PROPERTY DEVELOPMENT (U.S. CLS. 100, 103 AND 106).
PAUL F. GAST, EXAMINING ATTORNEY

SN 78-932,758. SYRACUSE UNIVERSITY, SYRACUSE, NY.
FILED 7-19-2006.

MINNOWBROOK

THE MARK CONSISTS OF STANDARD CHARACTERS WITHOUT CLAIM TO ANY PARTICULAR FONT, STYLE, SIZE, OR COLOR.

CLASS 21—HOUSEWARES AND GLASS

FOR CUPS; DRINKING GLASSES; DRINKING STEINS; MUGS; PLATES (U.S. CLS. 2, 13, 23, 29, 30, 33, 40 AND 50).

CLASS 24—FABRICS

FOR BLANKET THROWS; THROWS (U.S. CLS. 42 AND 50).

CLASS 25—CLOTHING

FOR APRONS; BELTS; BOOTIES; BOXER SHORTS; CAPS; CHILDREN'S AND INFANTS' CLOTH BIBS; EAR MUFFS; FLEECE PULLOVERS; FOOTWEAR; GLOVES; HEADBANDS; HEADWEAR; INFANT DIAPER COVERS; JACKETS; KNITTED CAPS; LEATHER JACKETS; NECKTIES; NIGHT GOWNS; PLASTIC BABY BIBS; POLO SHIRTS; PONCHOS; ROMPERS; RUGBY TOPS; SCARVES; SHORTS; SNEAKERS; SOCKS; SPORT SHIRTS; SUSPENDERS; SWEAT SHIRTS; SWEATERS; T-SHIRTS; TANK TOPS; TOPS; VISORS; WARM UP SUITS; WIND RESISTANT JACKETS; WRISTBANDS (U.S. CLS. 22 AND 39).

CLASS 41—EDUCATION AND ENTERTAINMENT

FOR ARRANGING AND CONDUCTING EDUCATIONAL CONFERENCES; ARRANGING OF SEMINARS AND CONFERENCES (U.S. CLS. 100, 101 AND 107).

FIRST USE 0-0-1953; IN COMMERCE 0-0-1953.

CLASS 43—HOTEL AND RESTAURANT SERVICES

FOR PROVISION OF CONFERENCE FACILITIES (U.S. CLS. 100 AND 101).

FIRST USE 0-0-1953; IN COMMERCE 0-0-1953.

ARETHA SOMERVILLE, EXAMINING ATTORNEY

SN 78-932,843. NEXPLORE TECHNOLOGIES, INC., FRISCO, TX. FILED 7-19-2006.

NEXPLORE.COM

THE MARK CONSISTS OF STANDARD CHARACTERS WITHOUT CLAIM TO ANY PARTICULAR FONT, STYLE, SIZE, OR COLOR.

CLASS 9—ELECTRICAL AND SCIENTIFIC APPARATUS

FOR SOFTWARE FOR DEVELOPMENT AND MAINTENANCE OF INTERNET PORTALS PROVIDING CHAT, NETWORKING AND OTHER CAPABILITIES (U.S. CLS. 21, 23, 26, 36 AND 38).

CLASS 35—ADVERTISING AND BUSINESS

FOR ONLINE BUSINESS NETWORKING SERVICES AMONG SUBSCRIBERS USING THE INTERNET (U.S. CLS. 100, 101 AND 102).

CLASS 36—INSURANCE AND FINANCIAL

FOR BROKERAGE IN THE FIELD OF INSURANCE CONTRACTS (U.S. CLS. 100, 101 AND 102).

CLASS 41—EDUCATION AND ENTERTAINMENT

FOR TRAINING IN THE USE OF THE INTERNET IN A WIDE VARIETY OF SUBJECT MATTERS; ENTERTAINMENT SERVICES, NAMELY, PROVIDING A WEB SITE FEATURING MUSICAL PERFORMANCES, MUSICAL VIDEOS, RELATED FILM CLIPS, PHOTOGRAPHS, AND OTHER MULTIMEDIA MATERIALS (U.S. CLS. 100, 101 AND 107).

CLASS 45—PERSONAL SERVICES

FOR ONLINE SOCIAL NETWORKING SERVICES AMONG SUBSCRIBERS USING THE INTERNET (U.S. CLS. 100 AND 101).

CAROL SPILS, EXAMINING ATTORNEY

SN 78-932,866. NEXPLORE TECHNOLOGIES, INC., FRISCO, TX. FILED 7-19-2006.

NEXPLORE

THE MARK CONSISTS OF STANDARD CHARACTERS WITHOUT CLAIM TO ANY PARTICULAR FONT, STYLE, SIZE, OR COLOR.

CLASS 9—ELECTRICAL AND SCIENTIFIC APPARATUS

FOR SOFTWARE FOR DEVELOPMENT AND MAINTENANCE OF INTERNET PORTALS PROVIDING CHAT, NETWORKING AND OTHER CAPABILITIES (U.S. CLS. 21, 23, 26, 36 AND 38).

CLASS 35—ADVERTISING AND BUSINESS

FOR ONLINE BUSINESS NETWORKING SERVICES AMONG SUBSCRIBERS USING THE INTERNET (U.S. CLS. 100, 101 AND 102).

CLASS 36—INSURANCE AND FINANCIAL

FOR BROKERAGE IN THE FIELD OF INSURANCE CONTRACTS (U.S. CLS. 100, 101 AND 102).

CLASS 41—EDUCATION AND ENTERTAINMENT

FOR TRAINING IN THE USE OF THE INTERNET IN A WIDE VARIETY OF SUBJECT MATTERS; ENTERTAINMENT SERVICES, NAMELY, PROVIDING A WEB SITE FEATURING MUSICAL PERFORMANCES, MUSICAL VIDEOS, RELATED FILM CLIPS, PHOTOGRAPHS, AND OTHER MULTIMEDIA MATERIALS (U.S. CLS. 100, 101 AND 107).

CLASS 45—PERSONAL SERVICES

FOR ONLINE SOCIAL NETWORKING SERVICES AMONG SUBSCRIBERS USING THE INTERNET (U.S. CLS. 100 AND 101).
CAROL SPILS, EXAMINING ATTORNEY

SN 78-940,003. MET-RX SUBSTRATE TECHNOLOGY, INC., BOHEMIA, NY. FILED 7-28-2006.

DOUBLE TAKE

THE MARK CONSISTS OF STANDARD CHARACTERS WITHOUT CLAIM TO ANY PARTICULAR FONT, STYLE, SIZE, OR COLOR.

CLASS 5—PHARMACEUTICALS

FOR DIETARY AND NUTRITIONAL SUPPLEMENTS (U.S. CLS. 6, 18, 44, 46, 51 AND 52).

CLASS 29—MEATS AND PROCESSED FOODS

FOR READY TO EAT PROTEIN BASED, NUTRIENT-DENSE FOOD BARS (U.S. CL. 46).

CLASS 30—STAPLE FOODS

FOR READY TO EAT GRAIN-BASED, NUTRIENT-DENSE FOOD BARS (U.S. CL. 46).
KATHERINE STOIDES, EXAMINING ATTORNEY

SN 78-942,928. THE GATES CORPORATION, DENVER, CO. FILED 8-2-2006.

MICRO-V AT

THE MARK CONSISTS OF STANDARD CHARACTERS WITHOUT CLAIM TO ANY PARTICULAR FONT, STYLE, SIZE, OR COLOR.
OWNER OF U.S. REG. NO. 755,498.
NO CLAIM IS MADE TO THE EXCLUSIVE RIGHT TO USE "AT", APART FROM THE MARK AS SHOWN.

CLASS 7—MACHINERY

FOR TRANSMISSION BELTS FOR MACHINES AND ENGINES; POWER TRANSMISSION BELTS FOR MACHINES AND VEHICLE ENGINES; MULTI-RIBBED BELTS FOR MACHINES AND ENGINES; FAN BELTS FOR MOTORS; ENGINE BELTS AND DYNAMO BELTS (U.S. CLS. 13, 19, 21, 23, 31, 34 AND 35).

CLASS 12—VEHICLES

FOR TRANSMISSION BELTS FOR LAND VEHICLES; MULTI-RIBBED BELTS FOR LAND VEHICLES, NOT BEING ENGINE PARTS (U.S. CLS. 19, 21, 23, 31, 35 AND 44).
STANLEY I. OSBORNE, EXAMINING ATTORNEY

SN 78-944,461. VERDE REALTY MLP, EL PASO, TX. FILED 8-3-2006.

VCRS

THE MARK CONSISTS OF STANDARD CHARACTERS WITHOUT CLAIM TO ANY PARTICULAR FONT, STYLE, SIZE, OR COLOR.

CLASS 36—INSURANCE AND FINANCIAL

FOR REAL ESTATE MANAGEMENT SERVICES; REAL ESTATE INVESTMENT OF COMMERCIAL PROPERTIES; MORTGAGE BANKING AND MORTGAGE PROCUREMENT FOR OTHERS; CONSTRUCTION FINANCING FOR HOMEBUILDERS; INSURANCE UNDERWRITING FOR HOMEBUYERS IN THE FIELDS OF HOME AND AUTO INSURANCE; TITLE INSURANCE UNDERWRITING IN THE FIELD OF REAL ESTATE; FINANCIAL SERVICES, NAMELY, PROVIDING CONSTRUCTION LOAN FINANCING FOR HOMEBUILDERS (U.S. CLS. 100, 101 AND 102).

CLASS 37—CONSTRUCTION AND REPAIR

FOR LAND DEVELOPMENT SERVICES, NAMELY, PLANNING AND LAYING OUT OF RESIDENTIAL AND/OR COMMERCIAL COMMUNITIES, RETAIL, INDUSTRIAL AND DISTRIBUTION SPACE, AND APARTMENTS; COMMERCIAL REAL ESTATE PROPERTY DEVELOPMENT (U.S. CLS. 100, 103 AND 106).
PAUL F. GAST, EXAMINING ATTORNEY

SN 78-953,406. JOHNSON & JOHNSON, NEW BRUNSWICK, NJ. FILED 8-16-2006.

CORTAID

THE MARK CONSISTS OF STANDARD CHARACTERS WITHOUT CLAIM TO ANY PARTICULAR FONT, STYLE, SIZE, OR COLOR.
OWNER OF U.S. REG. NOS. 1,099,246, 1,977,356 AND 3,105,752.

CLASS 3—COSMETICS AND CLEANING PREPARATIONS

FOR FACE AND SKIN CARE PRODUCTS, NAMELY, WIPES, CREAMS, LOTIONS, MOISTURIZERS, WASHES AND DISPOSABLE WASHCLOTHS IMPREGNATED WITH COMPOUNDS FOR CLEANSING OF THE SKIN (U.S. CLS. 1, 4, 6, 50, 51 AND 52).

CLASS 5—PHARMACEUTICALS

FOR ANTI-ITCH PREPARATIONS AND SOLUTIONS, NAMELY, CREAMS, LOTIONS, OINTMENTS, COOLING SPRAYS, POISON PLANT SCRUBS AND TREATMENT SPRAYS (U.S. CLS. 6, 18, 44, 46, 51 AND 52).
CORY BOONE, EXAMINING ATTORNEY

SN 79-000,659. AMG GROUP LIMITED, UNITED KINGDOM, FILED 12-12-2003.

VANGO

THE MARK CONSISTS OF STANDARD CHARACTERS WITHOUT CLAIM TO ANY PARTICULAR FONT, STYLE, SIZE, OR COLOR.

OWNER OF INTERNATIONAL REGISTRATION 0721403 DATED 10-1-1999, EXPIRES 10-1-2009.

CLASS 18—LEATHER GOODS

FOR GARMENT BAGS FOR TRAVEL; TRAVELLING BAGS; VALISES (U.S. CLS. 1, 2, 3, 22 AND 41).

CLASS 20—FURNITURE AND ARTICLES NOT OTHERWISE CLASSIFIED

FOR AIR MATTRESSES, NOT FOR MEDICAL PURPOSES; SLEEPING BAGS; CAMP BEDS; TENT PEGS NOT OF METAL (U.S. CLS. 2, 13, 22, 25, 32 AND 50).

CLASS 22—CORDAGE AND FIBERS

FOR TENTS (U.S. CLS. 1, 2, 7, 19, 22, 42 AND 50).
RUDY R. SINGLETON, EXAMINING ATTORNEY

SN 78-977,276. DATASAFE-MEDIA LIMITED, EDINBURGH, MIDLOTHIAN, UNITED KINGDOM, FILED 3-2-2005.

RiDiSc

PRIORITY CLAIMED UNDER SEC. 44(D) ON ERP CMNTY TM OFC APPLICATION NO. 004076295, FILED 10-14-2004, REG. NO. 004076295, DATED 12-16-2005, EXPIRES 10-14-2014.

CLASS 2—PAINTS

FOR FILLED INKJET CARTRIDGES (U.S. CLS. 6, 11 AND 16).

CLASS 9—ELECTRICAL AND SCIENTIFIC APPARATUS

FOR BLANK CD-R, DVD-R, DVD+R, DVD-RW, DVD+RW AND FLOPPY DISCS; UNFILLED INKJET CARTRIDGES FOR PHOTOCOPY MACHINES OR COMPUTER PRINTERS; CARRYING CASES AND STORAGE BOXES, WALLETS AND SLEEVES FOR CDS, DVDS AND FLOPPY DISCS; COMPUTER HARDWARE FOR WRITING, DUPLICATION AND PLAYING BACK MEDIA; DVD/CD DUPLICATORS, DRIVES AND PLAYERS, CASES FOR CDS, DVDS; CONTAINERS, TRAYS, FILES, RACKING AND SHELVES, ALL SPECIFICALLY ADAPTED FOR THE STORAGE, DISPLAY AND TRANSPORTATION OF MAGNETIC DISCS, MAGNETIC DISKETTES, MAGNETIC TAPES, MAGNETIC CARDS, AND CASSETTES AND CARTRIDGES FOR THE USE THEREWITH; CARDBOARD CARRYING CASES, STORAGE BOXES, WALLETS AND SLEEVES FOR STORAGE AND TRANSPORTATION OF ALL FORMS OF OPTICAL STORAGE MEDIA; AND PLASTIC, WOOD AND METAL CARRYING CASES AND STORAGE BOXES FOR STORAGE AND TRANSPORTATION OF ALL FORMS OF OPTICAL STORAGE MEDIA (U.S. CLS. 21, 23, 26, 36 AND 38).

CLASS 16—PAPER GOODS AND PRINTED MATTER

FOR ADHESIVE LABELS (U.S. CLS. 2, 5, 22, 23, 29, 37, 38 AND 50).
PATRICIA EVANKO, EXAMINING ATTORNEY

SN 79-004,000. BRETON SPA, ITALY, FILED 3-18-2004.

BRETONSTONE

THE MARK CONSISTS OF STANDARD CHARACTERS WITHOUT CLAIM TO ANY PARTICULAR FONT, STYLE, SIZE, OR COLOR.

PRIORITY DATE OF 2-10-2004 IS CLAIMED.
OWNER OF INTERNATIONAL REGISTRATION 0829400 DATED 3-18-2004, EXPIRES 3-18-2014.
OWNER OF U.S. REG. NO. 1,356,244.

CLASS 7—MACHINERY

FOR MACHINES FOR MANUFACTURING COMPOUND STONE AND CERAMIC MATERIALS FOR USE IN BUILDING CONSTRUCTION AND FURNITURE; MACHINES AND TRANSPORT, HANDLING AND STORING EQUIPMENT FOR PROCESSING NATURAL STONES, ARTIFICIAL STONES, COMPOUND STONES, CERAMIC AND GLASS MATERIALS, NAMELY, AUTOMATIC OR PROGRAMMABLE BLOCKSAW MACHINES, AUTOMATIC OR PROGRAMMABLE SLAB AND TILE SAW MACHINES, SLAB AND TILE CALIBRATING, GRINDING, POLISHING AND DRESSING MACHINES, CUTTING MACHINES, WAXING MACHINES, SQUARING AND CHAMFERING MACHINES, EDGE SHAVING AND POLISHING MACHINES, CONTOURING MACHINES, RESTORING, REINFORCING AND COATING MACHINES; AND REPLACEMENT PARTS FOR THE AFORESAID GOODS (U.S. CLS. 13, 19, 21, 23, 31, 34 AND 35).

CLASS 19—NON-METALLIC BUILDING MATERIALS

FOR NATURAL STONE, COMPOUND STONE AND CERAMIC MATERIAL, NAMELY, BLOCKS, SLABS, TILES AND OTHER SET MOLDED FORMS OF STONE AND CERAMIC FOR USE IN BUILDING CONSTRUCTION AND FURNITURE; NON-METALLIC COMPOSITE MATERIALS, NAMELY, NATURAL STONE, COMPOUND STONE AND CERAMIC MATERIALS, REINFORCED OR COATED WITH ELEMENTS COMPRISED OF FIBERS, MAT, WEB OR COMPOUNDED NATURAL LAYERS OF SAID MATERIALS FOR USE IN BUILDING AND CONSTRUCTION AND IN FURNITURE (U.S. CLS. 1, 12, 33 AND 50).

VERNA BETH RIRIE, EXAMINING ATTORNEY

CLASS 9—ELECTRICAL AND SCIENTIFIC APPARATUS

FOR SOUND, IMAGE AND DATA RECORDING TRANSMISSION, REPRODUCTION, STORAGE, HANDLING, DISSEMINATION AND RECOVERY APPARATUS, NAMELY CAMERAS, CINEMATOGRAPHIC CAMERAS, VIDEO CAMERAS, ELECTRONIC DATA BASE IN THE FIELD OF SPORT AND ENTERTAINMENT RECORDED ON MAGNETIC AND OPTICAL DATA MEDIA; VIDEODISKS, ACOUSTIC, OPTICAL AND DIGITAL DISKS, COMPACT DISKS, COMPUTERIZED DATA DIRECTORIES, ALL FEATURING IMAGES, SOUNDS, DATA, TEXTS IN THE FIELD OF SPORT AND ENTERTAINMENT; MEDIA FOR DATA STORAGE, NAMELY, BLANK MAGNETIC, OPTICAL, DIGITAL AND ELECTRONIC DATA CARRIERS; DOWNLOADABLE ELECTRONIC PUBLICATIONS IN THE NATURE OF MAGAZINES, IN THE FIELD OF SPORT AND ENTERTAINMENT (U.S. CLS. 21, 23, 26, 36 AND 38).

SN 79-006,246. ALFONSO CAYCEDO LOZANO, E-08330 PREMIA DE MAR (BARCELONA), SPAIN, FILED 7-14-2004.



THE MARK CONSISTS OF STANDARD CHARACTERS WITHOUT CLAIM TO ANY PARTICULAR FONT, STYLE, SIZE, OR COLOR.

OWNER OF INTERNATIONAL REGISTRATION 0688449 DATED 3-6-1998, EXPIRES 3-6-2008.

CLASS 16—PAPER GOODS AND PRINTED MATTER

FOR PRINTING PRODUCTS, NAMELY, PHOTOGRAPHIC PRINTS, PICTORIAL PRINTS, PRINTED ART REPRODUCTIONS, PRINTED CALENDARS; PRINTED MATTER, NAMELY PHOTOGRAPHIC PRINTS, PRINTS AWARDS, PRINTED REPORTS FEATURING SPORTS AND ENTERTAINMENT EVENTS; PRINTED PUBLICATIONS, NAMELY, MAGAZINES, NEWSPAPERS AND BOOKS, MAGAZINE REVIEWS COLUMNS, ALL ABOUT SPORTS, HIGH SCHOOL SPORTS, PROFESSIONAL SPORTS AND ENTERTAINMENT; PERIODICALS ABOUT SPORTS AND ENTERTAINMENT; CATALOGS OF PHOTOGRAPHY; PHOTOGRAPHS; PHOTOGRAPH STANDS, PRINTING BLOCKS; POSTERS; ALBUMS, NAMELY SCRAPBOOKS ALBUMS, EVENT ALBUMS; ALMANACS; PICTURES, PRINTED PROSPECTUSES OF OTHERS (U.S. CLS. 2, 5, 22, 23, 29, 37, 38 AND 50).

CLASS 16—PAPER GOODS AND PRINTED MATTER

FOR PRINTED PUBLICATIONS, NAMELY, PERIODICALS, MAGAZINES AND BOOKS IN THE FIELD OF MEDICINE (U.S. CLS. 2, 5, 22, 23, 29, 37, 38 AND 50).

CLASS 41—EDUCATION AND ENTERTAINMENT

FOR EDUCATION SERVICES, NAMELY, CONDUCTING SEMINARS, CONFERENCES AND SYMPOSIUMS IN THE FIELD OF MEDICINE (U.S. CLS. 100, 101 AND 107).

KATHERINE CHANG, EXAMINING ATTORNEY

CLASS 35—ADVERTISING AND BUSINESS

FOR ADVERTISING, NAMELY, PROVIDING ADVERTISING SPACES IN MAGAZINES AND ON WEBSITES, PROMOTION OF PRODUCTS AND SERVICES OF THIRD PARTIES THROUGH SPONSORING ARRANGEMENTS AND LICENSE AGREEMENTS RELATING TO SPORTS EVENTS, AND PROMOTION RELATING TO THE SALE OF ARTICLES AND SERVICES FOR THIRD PARTIES BY THE TRANSMISSION OF ADVERTISING MATERIAL AND THE DISSEMINATION OF ADVERTISING MESSAGES ON COMPUTER NETWORKS; DISSEMINATION OF ADVERTISING FOR OTHERS VIA THE INTERNET; DISSEMINATION OF ADVERTISEMENTS AND OF ADVERTISING MATERIAL, NAMELY, FLYERS, BROCHURES, LEAFLETS AND SAMPLES; DISSEMINATION OF ADVERTISING FOR OTHERS VIA AN ONLINE COMMUNICATIONS NETWORK ON THE INTERNET; DISTRIBUTION OF ADVERTISING MAIL AND OF ADVERTISING SUPPLEMENTS ATTACHED TO REGULAR EDITIONS; RENTAL OF ADVERTISEMENT SPACE AND ADVERTISING MATERIAL; RENTAL OF ADVERTISING SPACE ON WEB SITE; SALES PROMOTION FOR THIRD PARTIES, NAMELY, PROMOTION RELATING TO THE SALE OF ARTICLES AND SERVICES FOR THIRD PARTIES BY THE TRANSMISSION OF ADVERTISING MATERIAL AND THE DISSEMINATION OF ADVERTISING MESSAGES IN MAGAZINES AND ON COMPUTER NETWORKS; PUBLICATION AND DISTRIBUTION OF ADVERTISING TEXTS; CLASSIFIED ADS SERVICES, NAMELY, PREPARING AND PLACING ADVERTISEMENTS FOR OTHERS IN PAPER MAGAZINES AND ON INTERNET WEBSITES; ON-LINE ADVERTISING ON A COMPUTER NETWORK; COLLECTION, COMPILATION, INPUT AND SYSTEMIZATION OF DATA INTO COMPUTER DATABASES; OPERATION OF A DATA BANK FOR BUSINESS PURPOSES, NAMELY, COLLECTION, PREPARATION, COMPOSITION, STORAGE, PROCESSING, ACQUISITION AND PROVISION OF BUSINESS INFORMATION, DATA, STATISTICS AND INDICES; SERVICES OF STORAGE INPUT OF DATA FOR INFORMATION, NAMELY, DATA PROCESSING SERVICES; RENTAL OF ADVERTISING SPACE; NEWSPAPER SUBSCRIPTIONS (U.S. CLS. 100, 101 AND 102).

SN 79-006,834. SPORTS MEDIAS ET STRATEGIE, FRANCE, FILED 4-23-2004.



OWNER OF INTERNATIONAL REGISTRATION 0837439 DATED 4-23-2004, EXPIRES 4-23-2014.

NO CLAIM IS MADE TO THE EXCLUSIVE RIGHT TO USE "SPORT", APART FROM THE MARK AS SHOWN.

CLASS 36—INSURANCE AND FINANCIAL

FOR FINANCIAL SPONSORSHIP OF SPORTS AND ENTERTAINMENT EVENTS; CAPITAL INVESTMENT, NAMELY, CAPITAL INVESTMENT CONSULTATION; FINANCIAL PARTNERSHIP SERVICES, NAMELY, FORMATION, OFFERING AND MANAGEMENT OF LIMITED PARTNERSHIPS (U.S. CLS. 100, 101 AND 102).

CLASS 38—COMMUNICATION

FOR COMMUNICATION BY COMPUTER TERMINALS; TRANSMISSION AND DISSEMINATION OF DATA, SOUNDS, TEXTS, INFORMATION, IMAGES AND REPORTS, ON ALL TYPES OF MEDIA, ASSISTED BY COMPUTER OR BY RADIO, ELECTRONIC, TELE-MATIC OR WIRE MEDIA, NAMELY, TELEVISION, RADIO, COMPUTER NETWORKS; PROVISION OF ACCESS TO DATABASES BY MEANS OF COMPUTER SERVERS; E-MAILING AND ELECTRONIC TRANSMISSION OF DISPATCHES, NAMELY, ELECTRONIC TRANSMISSION OF MESSAGES, SOUND, TEXTS, DATA, IMAGES AND REPORTS; COMMUNICATION AND INFORMATION TRANSMISSION SERVICES VIA COMPUTER TERMINALS, RADIO, ELECTRONIC COMMUNICATIONS NETWORKS, VIDEO COMMUNICATION SYSTEMS; NEWS AGENCY SERVICES, NAMELY, TRANSMISSION OF NEWS AND COMMUNICATION AND INFORMATION TRANSMISSION SERVICES OF DATA, SOUNDS, TEXTS, NEWS, IMAGES AND REPORTS, PROVIDED ON LINE (U.S. CLS. 100, 101 AND 104).

CLASS 39—TRANSPORTATION AND STORAGE

FOR DELIVERY OF NEWSPAPERS (U.S. CLS. 100 AND 105).

CLASS 40—MATERIAL TREATMENT

FOR OFFSET PRINTING (U.S. CLS. 100, 103 AND 106).

CLASS 41—EDUCATION AND ENTERTAINMENT

FOR ORGANIZATION AND HOLDING OF COMPETITIONS, CONFERENCES, COLLOQUIUMS, CONVENTIONS, SEMINARS, SYMPOSIUMS; ORGANIZATION OF EXHIBITIONS AND EVENTS FOR CULTURAL, SPORTING OR EDUCATIONAL PURPOSES; BOOKING OF SEATS FOR SHOWS; ONLINE COMPUTER GAME SERVICES PROVIDED FOR ENTERTAINMENT FROM A COMPUTER NETWORK; PROVIDING INFORMATION ON CULTURAL EVENTS AND EXHIBITIONS, SPORTING EVENTS AND EXHIBITIONS AND ENTERTAINMENT THEMES IN THE NATURE OF COMPETITIONS, RACES; ORGANIZATION OF SPORTS COMPETITIONS; PROVIDING OF SPORTS FACILITIES; MOTION PICTURE FILM AND FILM STUDIES PRODUCTION; VIDEOTAPE FILM PRODUCTION; PRODUCTION OF MOTION PICTURE FILMS AND FILM STUDIES AND RADIO PROGRAMS; PRODUCTION OF RADIO AND TELEVISION PROGRAMS; VIDEOTAPING; SOUND RECORDING, RENTAL OF VIDEOTAPES; RENTAL OF SOUND RECORDINGS; RENTAL OF AUDIO EQUIPMENT; VIDEOTAPE EDITING; EDITING OF RADIO AND TELEVISION PROGRAMS; DIGITAL IMAGING SERVICES; PUBLICATION OF BOOKS; PHOTOGRAPHY; PHOTOGRAPHIC REPORTING; PUBLISHING OF BOOKS, NEWSPAPERS, MAGAZINES; PUBLICATION OF TEXTS OF OTHERS OTHER THAN PUBLICITY TEXTS; PUBLISHING OF ELECTRONIC PUBLICATIONS, BOOKS, DOWNLOADABLE AND NON-DOWNLOADABLE PERIODICALS ON LINE; ARTICLE WRITING; EDITORIAL CONSULTATION; NEWS REPORTING SERVICES, NAMELY, PROVIDING NEWS IN THE NATURE OF CURRENT EVENT REPORTING; PROVIDING INFORMATION CONCERNING SPORTS AND LEISURE EVENTS AND EXHIBITIONS SUPPLIED ON LINE (U.S. CLS. 100, 101 AND 107).

GINA FINK, EXAMINING ATTORNEY

SN 79-008,144. OÜ EASYFIT, ESTONIA, FILED 10-15-2004.

marko
MARKO KANTANEVA

PRIORITY DATE OF 10-11-2004 IS CLAIMED.
OWNER OF INTERNATIONAL REGISTRATION 0841089 DATED 10-15-2004, EXPIRES 10-15-2014.
THE NAME MARKO KANTANEVA IDENTIFIES A LIVING INDIVIDUAL WHOSE CONSENT IS OF RECORD.

CLASS 18—LEATHER GOODS

FOR WALKING STICKS; LEATHER AND IMITATION LEATHER PURSES AND WALLETS; PRODUCTS MADE OF LEATHER AND IMITATION OF LEATHER, NAMELY TRAVELING BAGS; UMBRELLAS; PET CLOTHING (U.S. CLS. 1, 2, 3, 22 AND 41).

CLASS 25—CLOTHING

FOR CLOTHING TO WEAR IN SPORT ACTIVITIES, NAMELY SPORT COATS, SPORT SHIRTS, SPORTS JACKETS, SPORTS JERSEYS AND BREECHES FOR SPORTS, SPORTS OVER UNIFORMS, JOGGING OUTFITS, SOCKS; FOOTWEAR FOR SPORTS ACTIVITIES AND LEISURE; BEACH FOOTWEAR; HEADGEAR, NAMELY CAPS, HATS, SUN VISORS; BELTS; GLOVES TO WEAR IN SPORT ACTIVITIES, NAMELY SKI GLOVES AND BICYCLE GLOVES (U.S. CLS. 22 AND 39).

CLASS 41—EDUCATION AND ENTERTAINMENT

FOR EDUCATIONAL SERVICES, NAMELY CLASSES, SEMINARS, WORKSHOPS IN THE FIELD OF SPORT AND HEALTH AND HEALTHY WAY OF LIFE; PROVIDING HEALTHY WAY OF LIVING COURSES; SPORTS AND CULTURAL ACTIVITIES, NAMELY ORGANISING COMMUNITY SPORTS AND CULTURAL EVENTS (U.S. CLS. 100, 101 AND 107).

TRACY WHITAKER-BOWN, EXAMINING ATTORNEY

SN 79-009,438. SARAYA FOUNDATION, LIECHTENSTEIN, FILED 5-4-2004.

SARAYA

THE MARK CONSISTS OF STANDARD CHARACTERS WITHOUT CLAIM TO ANY PARTICULAR FONT, STYLE, SIZE, OR COLOR.

PRIORITY DATE OF 1-21-2004 IS CLAIMED.
OWNER OF INTERNATIONAL REGISTRATION 0845050 DATED 5-4-2004, EXPIRES 5-4-2014.

THE ENGLISH TRANSLATION OF "SARAYA" IS "PALACE" OR "COURT" OR "MANOR".

CLASS 25—CLOTHING

FOR BATH ROBES, BATHING SUITS, DRESSING GOWNS, NIGHTGOWNS, PAJAMAS, BRASSIERES, CORSETS, SINGLETTS, PETTICOATS, GLOVES, CARDIGANS, JERSEYS, NECKTIES, NECKERCHIEFS, SCARVES, SWEATERS, SOCKS, STOCKINGS, TIGHTS, TROUSERS, LEGGINGS, SKIRTS, JACKETS, JERKINS, VESTS, WAISTCOATS, JUMPERS, TRACK SUITS, BLOUSES, JEANS, PANTIES, UNDERPANTS, BERMUDA SHORTS, SUITS AND DRESSES, OVERCOATS, ANORAKS, COATS, RAINCOATS, BELTS, SUSPENDERS, PAREUS, SHOES, BOOTS, SLIPPERS (U.S. CLS. 22 AND 39).

CLASS 26—FANCY GOODS

FOR RIBBONS, TEA COSIES, HAIR NETS, HAIR PINS, BARRETTES IN THE NATURE OF HAIR SLIDES, BRAIDS (U.S. CLS. 37, 39, 40, 42 AND 50).

CLASS 29—MEATS AND PROCESSED FOODS

FOR PROCESSED EDIBLE SEAWEED, PRESERVED MUSHROOMS AND TRUFFLES, PROCESSED DRIED FRUITS, FRUIT SALADS, FRUIT BASED SNACK FOOD, SOUPS, POTATO CHIPS, PROCESSED EDIBLE SEEDS, JAMS AND MARMALADE, BUTTER, CHEESE, YOGURT, CREAM, DAIRY-BASED FOOD BEVERAGES, SOY-BASED BEVERAGE USED AS MILK SUBSTITUTE, BUTTER SUBSTITUTE, EDIBLE OILS AND EDIBLE FATS (U.S. CL. 46).

CLASS 30—STAPLE FOODS

FOR COFFEE, TEA, HERBAL INFUSIONS, COCOA, SUGAR, POPPED POPCORN, CHOCOLATE, CHOCOLATE TRUFFLES, CHOCOLATE CHIPS, MARZIPAN, CHOCOLATE FOOD BEVERAGES NOT BEING DAIRY BASED OR VEGETABLE BASED, CHOCOLATE-BASED FILLINGS FOR CAKES AND PIES, CUSTARD-BASED FILLINGS FOR CAKES AND PIES, PUDDINGS, CARAMELS, SWEETMEATS, CANDY, CONFECTIONERY CHIPS FOR BAKING, ICE CREAM, MILK SHAKES, FROZEN YOGURT, FRUIT ICE, HONEY, SAUCES IN THE NATURE OF CONDIMENTS, FLAVORING SYRUPS, MAYONNAISE, SALAD DRESSINGS, SEASONINGS IN GENERAL, SPICES (U.S. CL. 46).

CLASS 31—NATURAL AGRICULTURAL PRODUCTS

FOR SOD, NON-ARTIFICIAL TURF, RAW BARKS, FRESH FRUITS, RAW FRUITS, FRESH HERBS, FRESH EDIBLE SEAWEED, UNPROCESSED TOMATOES, FRESH TRUFFLES, FRESH MUSHROOMS, FRESH BEANS AND NUTS, FRESH POTATOES, LIVE TREES, LIVE FLOWERS, FLOWER BULBS, DRIED FLOWER ARRANGEMENTS, LIVE FLOWER ARRANGEMENTS, LIVE FLOWER WREATHS, DRIED FLOWER WREATHS (U.S. CLS. 1 AND 46).

CLASS 32—LIGHT BEVERAGES

FOR BEER, ALE, PORTER, TABLE WATER, SPRING WATER, AERATED MINERAL WATER, NON-AERATED MINERAL WATER, NON-AERATED DRINKING WATER, CARBONATED SOFT DRINKS, NON-CARBONATED SOFT DRINKS, FRUIT FLAVORED SOFT DRINKS, FRUIT SOFT DRINKS, VEGETABLE, TOMATO AND FRUIT JUICES, AERATED FRUIT JUICES, NON-ALCOHOLIC COCKTAIL MIXES, LEMONADES, SYRUPS FOR MAKING FRUIT DRINKS AND SOFT DRINKS, MALT SYRUPS FOR BEVERAGES (U.S. CLS. 45, 46 AND 48).

CLASS 35—ADVERTISING AND BUSINESS

FOR PRODUCT MERCHANDISING, ADVERTISING AGENCIES, RENTAL OF ADVERTISING SPACE, COST/PRICE ANALYSIS, RATING OF ACCOMMODATIONS, BUSINESS AUDITING, BUSINESS MANAGEMENT OF HOTELS, BUSINESS APPRAISALS, PROFESSIONAL BUSINESS CONSULTANCY, BUSINESS MANAGEMENT AND ORGANIZATION CONSULTANCY, BUSINESS MANAGEMENT ASSISTANCE, BUSINESS MANAGEMENT CONSULTANCY, COMMERCIAL AND INDUSTRIAL MANAGEMENT ASSISTANCE, SALES PROMOTION FOR OTHERS, RENTAL OF DATA PROCESSING EQUIPMENT, MARKETING RESEARCH, PROVIDING STATISTICAL INFORMATION, AUCTIONEERING, DEMONSTRATION OF GOODS, DISSEMINATION OF ADVERTISING SAMPLES, BOOKKEEPING, PUBLIC RELATIONS, PERSONNEL PLACEMENT AND RECRUITMENT, SECRETARIAL AND CLERICAL SERVICES, PROVIDING ACCOUNTING SERVICES, SHOP WINDOW DISPLAY ARRANGEMENT SERVICES (U.S. CLS. 100, 101 AND 102).

CLASS 36—INSURANCE AND FINANCIAL

FOR INSURANCE BROKERAGE, INSURANCE CONSULTANCY, INSURANCE ADMINISTRATION, INSURANCE UNDERWRITING FOR ALL TYPES OF INSURANCE, INSURANCE-RELATED BONDING SERVICES, CREDIT AND DEBIT CARD SERVICES, SAFE DEPOSIT BOX SERVICES, MONETARY EXCHANGE, HOME BANKING, ELECTRONIC FUNDS TRANSFER, FINANCIAL ANALYSIS, FINANCIAL CONSULTANCY, FINANCIAL VALUATION OF PERSONAL PROPERTY AND REAL ESTATE, FINANCIAL MANAGEMENT, TEMPORARY FINANCING OF LOANS, MORTGAGE BANKING, FUNDS INVESTMENT, LEASE-PURCHASE FINANCING, REAL ESTATE TRUSTEESHIP REPRESENTATION, REAL ESTATE AGENCIES, REAL ESTATE APPRAISAL, LEASING OF REAL ESTATE, REAL ESTATE BROKERAGE, REAL ESTATE MANAGEMENT, REAL ESTATE DEVELOPMENT, REAL ESTATE PROCUREMENTS FOR OTHERS, RENTAL OF OFFICES, APARTMENTS AND FLATS, HOUSING AGENCIES (U.S. CLS. 100, 101 AND 102).

CLASS 37—CONSTRUCTION AND REPAIR

FOR BUILDING CONSTRUCTION AND REPAIR, BUILDING RENOVATION, ROOFING REPAIR, INSTALLATION OF THEFT PREVENTION DEVICES, INSTALLATION SERVICES OF BUILDING INSULATION, RESIDENTIAL AND COMMERCIAL BUILDING CONSTRUCTION, CONSTRUCTION OF HOTELS, OF SUPERSTRUCTURES IN THE NATURE OF BUILDINGS, SPORT FACILITIES, RESTAURANTS, AND SWIMMING POOLS; SWIMMING POOL CLEANING SERVICES; CONSTRUCTION OF TOURIST CENTERS; CONSTRUCTION PLANNING (U.S. CLS. 100, 103 AND 106).

CLASS 39—TRANSPORTATION AND STORAGE

FOR MOVING VAN TRANSPORT, TRUCK TRANSPORT, TAXI TRANSPORT, TRANSPORT BROKERAGE, PACKAGING ARTICLES FOR TRANSPORTATION, ELECTRONIC STORAGE OF DATA AND DOCUMENTS, REFRIGERATION STORAGE, WAREHOUSE STORAGE, ARRANGEMENT OF EXCURSIONS FOR TOURISTS, ARRANGEMENT OF TRAVEL TOURS, TRAVEL INFORMATION SERVICES, TRAVEL GUIDE SERVICES, TRAVEL AGENCIES SERVICES CONSISTING IN RESERVATION AND BOOKING FOR TRANSPORTATION, RENTAL OF CARS FOR TOURISTS (U.S. CLS. 100 AND 105).

CLASS 41—EDUCATION AND ENTERTAINMENT

FOR SWIMMING INSTRUCTIONS, HORSE TRAINING, PERSONAL DEVELOPMENT NAMELY STRENGTH AND CONDITIONING TRAINING, CASINOS, ENTERTAINMENT EVENTS IN THE NATURE OF ATHLETICS COMPETITIONS, OF AMUSEMENT PARK RIDES, OF FASHION SHOWS, OF GOLF TOURNAMENTS, OF TENNIS TOURNAMENTS, OF SOCCER AND FOOTBALL GAMES, OF TRACK AND FIELD COMPETITIONS, MULTIMEDIA ENTERTAINMENT SOFTWARE PRODUCTION SERVICES, RENTAL OF SPORTS EQUIPMENT, ORGANIZATION OF EXHIBITIONS FOR CULTURAL OR SPORTING PURPOSES, NAMELY, ORGANIZATION OF ART EXHIBITIONS; ORGANIZATION OF COMMUNITY SPORTING AND CULTURAL EVENTS; PROVIDING FACILITIES FOR RECREATION ACTIVITIES, SPORT CAMPS (U.S. CLS. 100, 101 AND 107).

CLASS 43—HOTEL AND RESTAURANT SERVICES

FOR RESTAURANTS, CARRY-OUT RESTAURANTS, RESTAURANTS FEATURING HOME DELIVERY, RESTAURANTS NAMELY DELICATESSENS, PROVIDING BANQUET FACILITIES FOR SPECIAL OCCASIONS, BAR SERVICES, CAFETERIAS, BAR-RESTAURANTS, SELF-SERVICE RESTAURANTS, PUBLIC CATERING, CATERING, SNACK-BARS, CANTEEN SERVICES, PROVIDING TEMPORARY HOUSING ACCOMMODATIONS, TOURIST HOMES, HOTELS, RESORT HOTELS, HOTEL SERVICES FOR PREFERRED CUSTOMERS, MAKING HOTEL RESERVATIONS FOR OTHERS; TRAVEL AGENCIES SERVICES CONSISTING IN RESERVATION AND BOOKING FOR TEMPORARY LODGING, FOR RESTAURANTS AND FOR MEALS (U.S. CLS. 100 AND 101).

MAUREEN DALL, EXAMINING ATTORNEY

SN 79-010,198. DR. KLAUS KEMNITZ, FED REP GERMANY, AND DR. WERNER ZUSCHRATTER, FED REP GERMANY, FILED 12-8-2004.

FLIN

THE MARK CONSISTS OF STANDARD CHARACTERS WITHOUT CLAIM TO ANY PARTICULAR FONT, STYLE, SIZE, OR COLOR.

PRIORITY DATE OF 6-9-2004 IS CLAIMED.

OWNER OF INTERNATIONAL REGISTRATION 0847336 DATED 12-8-2004, EXPIRES 12-8-2014.

CLASS 9—ELECTRICAL AND SCIENTIFIC APPARATUS

FOR SCIENTIFIC, MEASURING AND OPTICAL APPARATUS AND INSTRUMENTS, NAMELY MICROSCOPES, NANOSCOPIES, LASERS, CAMERAS AND DETECTORS; COMPLEX SYSTEMS FOR CONDUCTING AND DEVELOPING MICROSCOPY AND NANOSCOPY, NAMELY FLUORESCENCE MICROSCOPES AND NANOSCOPIES FOR IRRADIATING CELLS, TISSUE AND BIOLOGICAL SAMPLES, NAMELY PROTEIN AND DNA ASSAYS, INORGANIC SYSTEMS, NAMELY SILICON AND SEMICONDUCTOR SAMPLES MATERIALS; PRE-RECORDED SOFTWARE FOR COORDINATING, DIRECTING AND EVALUATING FLUORESCENCE MEASUREMENT BY FLUORESCENCE MICROSCOPES AND FLUORESCENCE DETECTORS (U.S. CLS. 21, 23, 26, 36 AND 38).

CLASS 10—MEDICAL APPARATUS

FOR OPTICAL AND MEASURING APPARATUS AND INSTRUMENTS FOR MEDICAL PURPOSES, NAMELY MICROSCOPES, NANOSCOPIES, LASERS, CAMERAS AND DETECTORS, FLUORESCENCE MICROSCOPES FOR IRRADIATING CELLS, FLUORESCENCE DETECTORS, LASERS, CAMERAS AND MICROSCOPES FOR MEASURING THE FLUORESCENCE (U.S. CLS. 26, 39 AND 44).

CLASS 42—SCIENTIFIC, COMPUTER AND LEGAL SERVICES

FOR CONDUCTING TECHNICAL AND OPTICAL MEASUREMENTS, NAMELY MEASURING THE FLUORESCENCE IN ALIVE OR DEAD CELLS, TISSUE, PROTEIN- AND DNA SAMPLES; SERVICES OF A TECHNICAL AND SCIENTIFIC MEASURING AND TESTING LABORATORY, NAMELY CONDUCTING FLUORESCENCE MEASUREMENTS BY MEANS OF MICROSCOPES OR NANOSCOPIES (U.S. CLS. 100 AND 101).

FLORENTINA BLANDU, EXAMINING ATTORNEY

SN 79-010,526. STRO PTY LTD, AUSTRALIA, FILED 2-25-2005.

Zomp

THE MARK CONSISTS OF STANDARD CHARACTERS WITHOUT CLAIM TO ANY PARTICULAR FONT, STYLE, SIZE, OR COLOR.

OWNER OF INTERNATIONAL REGISTRATION 0848420 DATED 2-25-2005, EXPIRES 2-25-2015.

ZOMP IS AN ITALIAN SLANG WORD THAT MEANS "TO JUMP AROUND".

CLASS 18—LEATHER GOODS

FOR HANDBAGS (U.S. CLS. 1, 2, 3, 22 AND 41).

CLASS 25—CLOTHING

FOR FASHION FOOTWEAR (U.S. CLS. 22 AND 39).
KATHERINE STOIDES, EXAMINING ATTORNEY

SN 79-010,812. ORLANDI S.P.A., ITALY, FILED 3-4-2005.

SN 79-010,844. GGOZI ENTERTAINMENT CO., LTD., SEOUL, REPUBLIC OF KOREA, FILED 11-19-2004.



PRIORITY DATE OF 3-4-2005 IS CLAIMED.
OWNER OF INTERNATIONAL REGISTRATION 0849296
DATED 3-4-2005, EXPIRES 3-4-2015.

THE COLORS BLACK, WHITE, GREEN AND GRAY ARE CLAIMED AS A FEATURE OF THE MARK.

THE COLOR(S) BLACK APPEARS IN THE WORDING NATUR AND THE TREE TRUNK; THE COLOR GREEN APPEARS IN THE WORDING LACE, CIRCLE DESIGN AND THE TREE; THE COLOR WHITE APPEARS IN THE LETTER "A"; AND THE COLOR GRAY APPEARS IN THE OUTLINE OF THE WORDING.

CLASS 3—COSMETICS AND CLEANING PREPARATIONS

FOR BLEACHING PREPARATIONS FOR LAUNDRY USE, DETERGENT SOAP FOR LAUNDRY USE; CLEANING PREPARATIONS FOR HOUSEHOLD USE; POLISHING PREPARATIONS; SCOURING PREPARATIONS, NAMELY LIQUIDS, POWDERS; ABRASIVE PREPARATIONS, NAMELY CLOTH, SHEETS; SOAPS FOR HOUSEHOLD AND PERSONAL USE; PRE-MOISTENED TOWELETTS IMPREGNATED WITH DISHWASHING DETERGENT; PERFUMERY, ESSENTIAL OILS FOR HOUSEHOLD AND PERSONAL USE; COSMETICS, HAIR LOTIONS; DENTIFRICES; PRE-MOISTENED TOWELS FOR COSMETIC USE (U.S. CLS. 1, 4, 6, 50, 51 AND 52).

CLASS 21—HOUSEWARES AND GLASS

FOR HOUSEHOLD AND KITCHEN UTENSILS, NAMELY TURNERS, SPATULAS, SERVING SPOONS AND FORKS, SERVING LADLES NOT OF PRECIOUS METAL OR COATED THEREWITH; HOUSEHOLD AND KITCHEN CONTAINERS NOT OF PRECIOUS METAL OR COATED THEREWITH; COMBS AND CLEANING SPONGES; COSMETIC, DUSTING, DISHWASHING BRUSHES EXCEPT PAINTBRUSHES; BRUSH-MAKING MATERIALS; ARTICLES FOR CLEANING PURPOSES, NAMELY CLOTHS, FEATHER-DUSTERS, BROOMS, BUCKETS, HOUSEHOLD GLOVES, BROOM HEADS, SPONGES; STEEL WOOL FOR CLEANING; UNWORKED OR SEMI-WORKED GLASS EXCEPT GLASS USED IN BUILDING, NAMELY DECORATIVE GLASS, COLORED SHEET GLASS, COMMON SHEET GLASS, ENAMELLED GLASS; BEVERAGE GLASSWARE; BUSTS, DESKTOP STATUARY, FIGURES, FIGURINES, SCULPTURES, STATUES, STATUETTES, JARS FOR JAM AND JELLIES MADE OF PORCELAIN AND EARTH-WARE (U.S. CLS. 2, 13, 23, 29, 30, 33, 40 AND 50).

CLASS 24—FABRICS

FOR FABRICS, NAMELY, NON-WOVEN TEXTILE FABRICS; HOUSEHOLD, TABLE, BATH AND BED LINEN (U.S. CLS. 42 AND 50).

WILLIAM VERHOSEK, EXAMINING ATTORNEY



OWNER OF INTERNATIONAL REGISTRATION 0849403
DATED 11-19-2004, EXPIRES 11-19-2014.

"MONG.E" DOES NOT IDENTIFY A LIVING INDIVIDUAL.

THE COLOR(S) PINK, YELLOW, PURPLE AND BLUE IS/ARE CLAIMED AS A FEATURE OF THE MARK.

THE COLOR PINK APPEARS ON THE CROWN-SHAPED HEAD, THE BOW ON THE ONE-PIECE DRESS, AND IN THE LETTERING OF THE WORDING "MONG.E". THE COLOR YELLOW IS USED IN THE STAR IN THE MIDDLE OF THE CROWN-SHAPED HEAD AND IN THE LETTER "O" IN THE WORDING "MONG.E", AND IN THE HAIR. THE COLOR PURPLE IS USED ON THE OUTLINE OF THE DRESS AND THE EYES OF THE CHARACTER. THE COLOR BLUE IS USED ON THE OUTLINE OF THE WINGS OF THE DRESS.

THE MARK CONSISTS OF A WOMAN NYMPH WHICH HAS A HEAD IN THE SHAPE OF A CROWN WHICH ORIGINATED FROM A SHELLFISH WITH TWO BIG EYES. A STAR IS IN THE MIDDLE OF HER HEAD. THE CHARACTER IS WEARING A ONE-PIECE DRESS WITH WINGS. THE WORDING "MONG.E" WHICH APPEARS AT THE BOTTOM OF THE GRAPHIC IS THE NAME OF THE NYMPH.

CLASS 14—JEWELRY

FOR SERVING TRAYS OF PRECIOUS METAL; BOXES OF PRECIOUS METAL FOR NEEDLES; PURSES OF PRECIOUS METAL; JEWEL CASES OF PRECIOUS METAL; KEY HOLDERS AND KEY FOBS OF PRECIOUS METAL; WALL CLOCKS; ALARM CLOCKS; ELECTRONIC CLOCKS AND WATCHES; TABLE CLOCKS; WRIST-WATCHES (U.S. CLS. 2, 27, 28 AND 50).

CLASS 21—HOUSEWARES AND GLASS

FOR TRASH CANS IN THE NATURE OF DUST BINS; PLASTIC CUPS; POWDER PUFFS; COMPACTS FOR FACE POWDER SOLD EMPTY; POWDER COMPACTS, NOT OF PRECIOUS METAL SOLD EMPTY; SOAP BOXES; COMBS; COMB CASES; BROOMS; CLOTHES-PINS; DUSTPANS; PITCHERS, NOT OF PRECIOUS METAL; MUGS, NOT OF PRECIOUS METAL; RICE BOWLS, NOT OF PRECIOUS METAL; DISHES, NOT OF PRECIOUS METAL; DRIP MATS FOR TEA, NOT OF PRECIOUS METAL; TEACUPS, NOT OF PRECIOUS METAL; COFFEE CUPS, NOT OF PRECIOUS METAL; GLASS CUPS; MESS-TINS; CHOPPING BOARDS FOR KITCHEN USE; BOTTLE GOURDS; TRAYS NOT OF PRECIOUS METAL; SOAP HOLDERS; BUCKETS; CHOP-STICKS; PLASTIC WATER BOTTLES SOLD EMPTY; INSULATING FLASKS; TOILET PAPER HOLDERS; NON-METAL PIGGY BANKS, PLASTIC BOTTLES SOLD EMPTY (U.S. CLS. 2, 13, 23, 29, 30, 33, 40 AND 50).

CLASS 24—FABRICS

FOR CURTAINS OF TEXTILE, EXCEPT SHOWER CURTAINS; SHOWER CURTAINS; WINDOW BLINDS OF TEXTILE; DECORATIVE WALL HANGINGS OF TEXTILE; MATTRESS COVERS; PILLOWCASES; SLEEPING MATS; QUILTS; QUILT DUVETS; BEDSPREADS; COVERS FOR CUSHIONS; HANDKERCHIEFS OF TEXTILE; TOWELS OF TEXTILE (U.S. CLS. 42 AND 50).
KATHERINE STOIDES, EXAMINING ATTORNEY

CLASS 7—MACHINERY

FOR AUTOMATIC CRIMPING MACHINES (U.S. CLS. 13, 19, 21, 23, 31, 34 AND 35).

CLASS 17—RUBBER GOODS

FOR PACKAGING STRIPS OF PLASTIC (U.S. CLS. 1, 5, 12, 13, 35 AND 50).
CHRIS WELLS, EXAMINING ATTORNEY

SN 79-010.896. COBIAX TECHNOLOGIES AG, SWITZERLAND, FILED 5-6-2005.

COBIAX

THE MARK CONSISTS OF STANDARD CHARACTERS WITHOUT CLAIM TO ANY PARTICULAR FONT, STYLE, SIZE, OR COLOR.

OWNER OF INTERNATIONAL REGISTRATION 0849537 DATED 5-6-2005, EXPIRES 5-6-2015.

CLASS 6—METAL GOODS

FOR METAL REINFORCING MATERIALS FOR BUILDING, NAMELY, METAL STRIPS, METAL BINDING STRIPS, METAL BINDING WIRES, WIRE NETS, WIRE CHAIRS AND CAGES, NAMELY, WELDED WIRE REINFORCEMENT USED FOR SHEAR REINFORCING IN BEAMS, AND METAL CASTING FORMS FOR CONCRETE (U.S. CLS. 2, 12, 13, 14, 23, 25 AND 50).

CLASS 19—NON-METALLIC BUILDING MATERIALS

FOR NON-METAL CASTING FORMS FOR CONCRETE, NAMELY, PLASTIC MOVING ELEMENTS AND VOID FORMING FOR CASTING CONCRETE (U.S. CLS. 1, 12, 33 AND 50).

CLASS 42—SCIENTIFIC, COMPUTER AND LEGAL SERVICES

FOR CONDUCTING ENGINEERING SURVEYS, NAMELY, EXPERT TECHNICAL SURVEYS AND ENGINEERING PROJECT STUDIES; ENGINEERING; AND PATENT EXPLOITATION, NAMELY, PATENT LICENSING (U.S. CLS. 100 AND 101).

TINA BROWN, EXAMINING ATTORNEY

SN 79-011.397. TITAN UMREIFUNGSTECHNIK GMBH & CO. KG, FED REP GERMANY, FILED 1-12-2005.

TITAN



OWNER OF INTERNATIONAL REGISTRATION 0600793 DATED 3-17-1993, EXPIRES 3-17-2013.

CLASS 6—METAL GOODS

FOR METAL SLEEVES OR FLANGES FOR CLOSING; METAL PACKAGING STRIPS (U.S. CLS. 2, 12, 13, 14, 23, 25 AND 50).

SN 79-011.615. TIERPARK DAHLHÖLZLI, BERN, SWITZERLAND, FILED 2-22-2005.



Tierpark
Dählhölzli
Bern

Mehr Platz für weniger Tiere

PRIORITY DATE OF 8-25-2004 IS CLAIMED.

OWNER OF INTERNATIONAL REGISTRATION 0851740 DATED 2-22-2005, EXPIRES 2-22-2015.

NO CLAIM IS MADE TO THE EXCLUSIVE RIGHT TO USE "TIERPARK" AND "BERN", APART FROM THE MARK AS SHOWN.

THE ENGLISH TRANSLATION OF "TIERPARK DAHLHÖLZLI BERN MEHR PLATZ FÜR WENIGER TIERE" IS "DAHLHÖLZLI ANIMAL PARK BERNE MORE SPACE FOR MORE ANIMALS".

CLASS 25—CLOTHING

FOR CLOTHING, NAMELY, BOTTOMS, TOPS, COATS, JACKETS AND SWEATERS; FOOTWEAR; HEADWEAR (U.S. CLS. 22 AND 39).

CLASS 35—ADVERTISING AND BUSINESS

FOR ADVERTISING AGENCIES; BUSINESS MANAGEMENT, BUSINESS OPERATION, BUSINESS ADMINISTRATION AND OFFICE FUNCTIONS; PUBLIC RELATIONS FOR AN ANIMAL PARK (U.S. CLS. 100, 101 AND 102).

CLASS 41—EDUCATION AND ENTERTAINMENT

FOR EDUCATION SERVICES, NAMELY, PROVIDING COURSES AND SEMINARS IN THE FIELD OF ZOOLOGY; ANIMAL TRAINING; ORGANIZING COMMUNITY SPORTING AND CULTURAL EVENTS; ZOOS (U.S. CLS. 100, 101 AND 107).

CLASS 42—SCIENTIFIC, COMPUTER AND LEGAL SERVICES

FOR SCIENTIFIC AND ZOOLOGICAL RESEARCH; DESIGN OF COMPUTERS AND COMPUTER SOFTWARE FOR OTHERS (U.S. CLS. 100 AND 101).
IRA J. GOODSaid, EXAMINING ATTORNEY

SN 79-012,427. CELLPACK AG, SWITZERLAND, FILED 5-10-2005.

CELLPACK

OWNER OF INTERNATIONAL REGISTRATION 0638305 DATED 5-9-1995, EXPIRES 5-9-2015.

CLASS 9—ELECTRICAL AND SCIENTIFIC APPARATUS

FOR ELECTRIC CABLES, CABLE LUGS AND WIRES; CABLE THIMBLES, ELECTRICAL WIRE CONNECTORS, AND PROTECTIVE SHEATHS FOR ELECTRIC WIRES; AERIALS; ELECTRICAL JOINTS AND TERMINATIONS, HEAT-SHRINK TUBES, HEAT-SHRINK SPREADER CAPS, END CAPS AND REPAIR SLEEVES (U.S. CLS. 21, 23, 26, 36 AND 38).

CLASS 17—RUBBER GOODS

FOR ARTIFICIAL RESINS AND PLASTIC MATERIALS USED FOR SEALING, PACKING AND INSULATING MATERIALS; REINFORCED PLASTICS IN THE FORM OF SHEETS, FILMS, BLOCKS, RODS AND TUBES; REINFORCED PLASTICS IN EXTRUDED FORM USED IN PRODUCTION; CAST-RESIN CONNECTORS TO CONNECT AND BRANCH-OFF ELECTRICAL CABLES; CARBON FIBERS NOT FOR TEXTILE USE; INSULATORS OF ELECTRIC MAINS AND ELECTRIC CABLES; ADHESIVE TAPES FOR INDUSTRIAL USE (U.S. CLS. 1, 5, 12, 13, 35 AND 50).

JOHN KELLY, EXAMINING ATTORNEY

SN 79-012,944. UPM RAFLATAC OY, FI-33310 TAMPERE, FINLAND, FILED 2-25-2005.

FlagTag

THE MARK CONSISTS OF STANDARD CHARACTERS WITHOUT CLAIM TO ANY PARTICULAR FONT, STYLE, SIZE, OR COLOR.

OWNER OF INTERNATIONAL REGISTRATION 0855652 DATED 2-25-2005, EXPIRES 2-25-2015.

CLASS 9—ELECTRICAL AND SCIENTIFIC APPARATUS

FOR ELECTRONIC RESONANCE TAGS, LABELS AND CARDS, WITH EMBEDDED RESONANCE CIRCUITS, MICROCHIPS, COMPUTER MEMORIES, RADIO FREQUENCY AND ELECTRONIC READABLE DATA CARRIERS CONTAINING IDENTIFICATION INFORMATION FOR USE IN SECURITY AND IDENTIFICATION VERIFICATION APPLICATIONS; AND ELECTRONIC DATA READING AND DATA RECORDING APPARATUS AND INSTRUMENTS, NAMELY, BAR CODE READERS AND ELECTRONIC READERS FOR READING ELECTRONIC RESONANCE CARDS, TAGS, AND LABELS FOR USE IN SECURITY AND IDENTIFICATION VERIFICATION AND OTHER APPLICATIONS (U.S. CLS. 21, 23, 26, 36 AND 38).

CLASS 16—PAPER GOODS AND PRINTED MATTER

FOR PAPER FOR PACKAGING, CARDBOARD, LABELS, TAGS AND CARDS SUPPLIED IN REELS AND SHEETS WITH ADHESIVE OR SILICON LINER FOR USE IN SHIPPING PALLETS AND CASES FOR CONSUMER GOODS (U.S. CLS. 2, 5, 22, 23, 29, 37, 38 AND 50).
BARNEY CHARLON, EXAMINING ATTORNEY

SN 79-013,779. SANOVO ENGINEERING A/S, DENMARK, FILED 1-25-2005.

SANOVO

THE MARK CONSISTS OF STANDARD CHARACTERS WITHOUT CLAIM TO ANY PARTICULAR FONT, STYLE, SIZE, OR COLOR.

OWNER OF INTERNATIONAL REGISTRATION 0857696 DATED 1-25-2005, EXPIRES 1-25-2015.

CLASS 7—MACHINERY

FOR FILTERING MACHINES FOR THE TREATMENT OF PROCESS WATER FROM THE FOOD INDUSTRY, FILTERS WHICH ARE PARTS OF MACHINES, MACHINES FOR THE TREATMENT, PROCESSING AND PACKAGING OF GOODS MADE OF EGG (U.S. CLS. 13, 19, 21, 23, 31, 34 AND 35).

CLASS 29—MEATS AND PROCESSED FOODS

FOR MEAT, FISH, POULTRY AND GAME; MEAT EXTRACTS; PRESERVED, DRIED AND COOKED FRUITS AND VEGETABLES; JELLIES, JAMS, COMPOSITES; EGGS, MILK; EDIBLE OILS AND FATS; GOODS MADE OF EGG, NAMELY, EGG WHITE, EGG YOLK, EGG POWDER; EGG PRODUCTS FOR INDUSTRIAL PURPOSES, NAMELY, EGG WHITE, EGG YOLK, EGG POWDER, DESSICATED EGGS, FROZEN EGGS (U.S. CL. 46).

CLASS 35—ADVERTISING AND BUSINESS

FOR BUSINESS MANAGEMENT CONSULTANCY FOR COMPANIES, BUSINESS MANAGEMENT ASSISTANCE CONCERNING ENVIRONMENTAL ISSUES IN THE FOOD INDUSTRY (U.S. CLS. 100, 101 AND 102).

MARGERY A. TIERNEY, EXAMINING ATTORNEY

SN 79-014,102. CARPEL SA, FRANCE, FILED 5-11-2005.

PORALU

THE MARK CONSISTS OF STANDARD CHARACTERS WITHOUT CLAIM TO ANY PARTICULAR FONT, STYLE, SIZE, OR COLOR.

OWNER OF INTERNATIONAL REGISTRATION 0858529 DATED 5-11-2005, EXPIRES 5-11-2015.

CLASS 6—METAL GOODS

FOR TRANSPORTABLE BUILDINGS OF METAL; PONTOONS AND LANDING DOCKS FLOATING AND STATIONARY; COMMON METALS AND THEIR ALLOYS FOR FURTHER MANUFACTURE INCLUDING UNWROUGHT AND SEMI-FINISHED COMMON METALS; METAL TUBES AND PIPES; DOORS AND WINDOWS, INCLUDING SKYLIGHTS, ROOF LIGHTS, CELLAR WINDOWS, VERTICALLY PIVOTED WINDOWS, MESH WINDOWS, HORIZONTALLY PIVOTED WINDOWS, AND VERTICAL SKYLIGHTS; VALLEY TUBES; READY-TO-FIT BUILDING COMPONENTS, NAMELY, READY-TO-FIT BUILDING COMPONENTS FOR ROOF CONSTRUCTION AND AS WINDOWS, DOORS, GATES, VALLEYS, WINDOW FRAMES, WINDOW SECTIONS AND ROOF TILES; RAINWATER GUTTERS, WINDOW SILLS, NON-ELECTRIC FASTENERS AND LOCKING MECHANISMS FOR DOORS AND WINDOWS, LOCKS FOR WINDOWS AND DOORS AND THEIR COMPONENTS; NON-ELECTRIC LOCKS; MANUALLY OPERATED SMOKE AND VENTILATION VALVES NOT INCLUDING MACHINE PARTS; COATING MATERIALS FOR WINDOWS, NAMELY, FRAMES AND SHAPED COMPONENTS, WINDOW COMPONENTS, EXTERIOR VENETIAN BLINDS, EXTERIOR ROLLER SHUTTERS, VENETIAN BLINDS, VENETIAN ROLLER BLINDS, SHUTTERS, ROLLER SHUTTERS, VENETIAN BLINDS, VENETIAN ROLLER BLINDS, EXTERIOR ROLLER BLINDS; NON-ELECTRIC LOCK CASES FOR EXTERIOR ROLLER BLINDS, NON-ELECTRIC OPERATING DEVICES FOR EXTERIOR VENETIAN ROLLER BLINDS; PANELS, NAMELY, DOORS PANELS, CEILING PANELS, FENCE PANELS, ROOFING PANELS, WALL PANELS, COUNTERWEIGHTS AND SHINGLES FOR FRAMES AND SLIDING WINDOWS; ALL THE AFOREMENTIONED GOODS OF METAL OR MADE PRIMARILY WITH METAL (U.S. CLS. 2, 12, 13, 14, 23, 25 AND 50).

CLASS 19—NON-METALLIC BUILDING MATERIALS

FOR TRANSPORTABLE CONSTRUCTIONS, NOT OF METAL; PONTOONS AND LANDING DOCKS, NOT OF METAL, FLOATING AND STATIONARY; NON-METAL BUILDING MATERIALS, IN PARTICULAR DOORS, WINDOWS, WINDOWS FOR ROOFS AND GLASS ROOFS AND THEIR COMPONENTS; RAINWATER GUTTERS; GLASS FOR BUILDING, NAMELY, GLASS TILES, GLASS BLOCKS, GLASS SHEETS; DOORS AND WINDOWS, INCLUDING SKYLIGHTS, ROOF LIGHTS, CELLAR WINDOWS, VERTICALLY PIVOTED WINDOWS, MESH WINDOWS, HORIZONTALLY PIVOTED WINDOWS AND VERTICAL SKYLIGHTS; ROOFS, GLASS ROOFS, VERTICAL SKYLIGHTS; VALLEY TUBES; READY-TO-FIT BUILDING COMPONENTS, NAMELY READY-TO-FIT BUILDING COMPONENTS FOR ROOF CONSTRUCTION AND AS WINDOWS, DOORS, GATES, VALLEYS, WINDOW FRAMES, WINDOW SECTIONS AND ROOF TILES; WINDOW SILLS, NON-ELECTRIC FASTENERS AND LOCKING MECHANISMS FOR DOORS AND WINDOWS, LOCKS FOR WINDOWS AND DOORS AND THEIR COMPONENTS; COATING MATERIALS FOR WINDOWS, NAMELY, FRAMES AND SHAPED COMPONENTS, WINDOW COMPONENTS, EXTERIOR VENETIAN BLINDS, EXTERIOR ROLLER SHUTTERS, VENETIAN BLINDS, VENETIAN ROLLER BLINDS, SHUTTERS, ROLLER SHUTTERS, EXTERIOR ROLLER BLINDS; NON-ELECTRIC LOCK CASES FOR EXTERIOR ROLLER BLINDS, NON-ELECTRIC OPERATING DEVICES FOR EXTERIOR VENETIAN ROLLER BLINDS; PANELS, NAMELY, DOORS PANELS, CEILING PANELS, FENCE PANELS, ROOFING PANELS, WALL PANELS, COUNTERWEIGHTS AND SHINGLES FOR FRAMES AND SLIDING WINDOWS, ALL THE AFOREMENTIONED GOODS BEING NON-METAL IN COMPOSITION (U.S. CLS. 1, 12, 33 AND 50).

ELIZABETH HUGHITT, EXAMINING ATTORNEY

SN 79-014,318. ZAI AG, SWITZERLAND, FILED 5-4-2005.



THE MARK CONSISTS OF STANDARD CHARACTERS WITHOUT CLAIM TO ANY PARTICULAR FONT, STYLE, SIZE, OR COLOR.

PRIORITY DATE OF 11-11-2004 IS CLAIMED.
OWNER OF INTERNATIONAL REGISTRATION 0859099
DATED 5-4-2005, EXPIRES 5-4-2015.

CLASS 18—LEATHER GOODS

FOR BAGS AND SHOULDER-STRAP BAGS, SPORTS BAGS, TRAVELING BAGS, FANNY PACKS, RUCKSACKS, SPORTS BAGS MADE OF LEATHER, PLASTIC OR TEXTILE MATERIALS, RUCKSACKS FOR SKIING AND FOR CARRYING SKIS, LEATHER BAGS, ALL PURPOSE SPORT BAGS, BEACH BAGS, VALISES, LUGGAGE TRUNKS, PURSES NOT OF PRECIOUS METAL, UMBRELLAS, PARASOLS, LEATHER CASES FOR KEYS, AND LEATHER STRAPS (U.S. CLS. 1, 2, 3, 22 AND 41).

CLASS 20—FURNITURE AND ARTICLES NOT OTHERWISE CLASSIFIED

FOR SHELVES AND STORAGE RACKS FOR SKI, SNOWBOARD AND SPORTS EQUIPMENT; DISPLAY CASES FOR MERCHANDISE, NAMELY SKIS; SHELVING AND COMPONENT PARTS THEREOF, NAMELY SHELVES AND BRACKETS SOLD AS A UNIT, CUPBOARDS, STORAGE RACKS, PACKING CONTAINERS OF PLASTIC MATERIAL; CONTAINER CLOSURES OF PLASTIC; AND NON-METAL BINS (U.S. CLS. 2, 13, 22, 25, 32 AND 50).

CLASS 25—CLOTHING

FOR CLOTHING, NAMELY HATS, TOPS, PANTS, AND JACKETS; FOOTWEAR EXCLUDING ORTHOPEDIC FOOTWEAR; HEADGEAR, NAMELY HEADBANDS, HATS AND CAPS; SKI WEAR, SNOWBOARD WEAR; SHOES AND BOOTS; ATHLETIC FOOTWEAR; SKI AND SNOWBOARD SHOES AND PARTS THEREOF SOCKS; CAPS; GLOVES, HEADBANDS; FOOTWEAR FOR OUTDOOR ACTIVITIES, WALKING FOOTWEAR, AND CLIMBING FOOTWEAR; KNIT SHIRTS; AND SNOW BOOTS (U.S. CLS. 22 AND 39).

CLASS 28—TOYS AND SPORTING GOODS

FOR SPORTS AND GYMNASTICS APPARATUS, ACCESSORIES, AND TOYS, NAMELY SKIS, SURF SKIS FOR SNOWBOARDING; COVERS FOR SKI BINDINGS AND SKI POLES; SKI COVERS AND SKI EDGES; ROLLER SKATES, INLINE ROLLER SKATES, BOBSLEIGHS, SKIBOBS, SLEIGHS, SLEDS, SKI POLES AND PARTS THEREOF; HOCKEY STICKS; COVERS FOR SKIS, SURF SKIS AND SKI POLES; SKI RACKS; BAGS SPECIFICALLY ADAPTED FOR SPORTS EQUIPMENT, NAMELY BAGS FOR SKI BINDINGS, SKI WAX; KNEE GUARDS, WRIST GUARDS AND ELBOW GUARDS FOR ATHLETIC USE; MONOSKIS; SAILBOARDS, WATERSKIS; MASTS, STRAPS AND SUPPORTING BELTS FOR SAILBOARDS; ICE SKATES, AND SKATEBOARDS; AND TENNIS AND GOLF EQUIPMENT, TENNIS RACKETS, TENNIS BALLS, GOLF CLUBS, GOLF BALLS, GOLF TEES, AND GOLF BAGS (U.S. CLS. 22, 23, 38 AND 50).

CLASS 37—CONSTRUCTION AND REPAIR

FOR REPAIR OF SPORTS EQUIPMENT; RECONDITIONING AND CLEANING OF CLOTHING, PARTICULARLY SPORTS CLOTHING; VEHICLE REPAIR AND MAINTENANCE; INSTALLATION, MAINTENANCE AND REPAIR OF ATHLETIC EXERCISE AND TRAINING MACHINES (U.S. CLS. 100, 103 AND 106).

CLASS 41—EDUCATION AND ENTERTAINMENT

FOR ARRANGING AND CONDUCTING ATHLETIC TRAINING, COURSES AND COMPETITION IN THE FIELDS OF SKIING, SNOWBOARDING AND GOLFING; ARRANGING AND CONDUCTING CULTURAL EVENTS; RENTAL OF SPORTS EQUIPMENT OTHER THAN VEHICLES; RENTAL OF SKIS AND SNOWBOARDING EQUIPMENT; ORGANIZING COMMUNITY SPORTING AND CULTURAL EVENT; PROVIDING SPORTS INFORMATION, INFORMATION IN THE FIELD OF MUSIC, INFORMATION ABOUT PARTIES AND FESTIVALS ALL ON-LINE VIA GLOBAL COMPUTER AND TELEPHONE NETWORKS; EDITING OF RADIO AND TELEVISION PROGRAMS; ORGANIZING ARRANGING INDOOR AND OUTDOOR RECREATIONAL EVENTS; PUBLICATION OF TEXTS, BOOKS, MAGAZINES AND OTHER PRINTED MATTER; ARRANGING PROFESSIONAL WORKSHOP AND TRAINING COURSES; ORGANIZING AND CONDUCTING SPORTS EVENTS, SPORTS COMPETITION AND GAMES, DANCE COMPETITION, AND CULTURAL AND EDUCATIONAL EXHIBITIONS (U.S. CLS. 100, 101 AND 107).

KIMBERLY PERRY, EXAMINING ATTORNEY

SN 79-014,567. GLOBEACCESS AB, SE-402 35 GÖTEBORG, SWEDEN, FILED 6-28-2005.

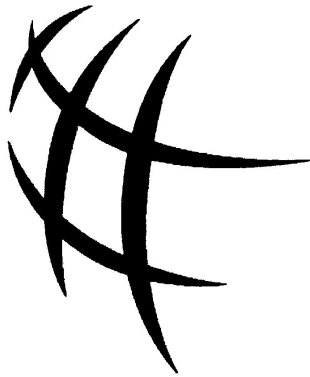

PRIORITY DATE OF 2-10-2005 IS CLAIMED.
OWNER OF INTERNATIONAL REGISTRATION 0860143 DATED 6-28-2005, EXPIRES 6-28-2015.

CLASS 9—ELECTRICAL AND SCIENTIFIC APPARATUS

FOR COMPUTER SOFTWARE FOR PROVIDING A VISUAL INTERFACE FOR THE CONTENT OF A USER'S OWN SYSTEMS AND NETWORKS; COMPUTER SOFTWARE FOR HANDLING COMMUNICATION BETWEEN CLIENT AND SERVER APPLICATIONS; COMPUTER SOFTWARE FOR INTERNET COMMUNICATIONS, NAMELY COMPUTER SOFTWARE FOR READING AND WRITING DATABASE ENTRIES OF INFORMATION; DATABASE ENTRIES OF WEB SITES AND DATABASE ENTRIES OF RESOURCES; COMPUTER SOFTWARE FOR ORGANIZING, PRESENTING AND ACCESSING DATA STORED IN CONTENT SYSTEMS (U.S. CLS. 21, 23, 26, 36 AND 38).

CLASS 38—COMMUNICATION

FOR COMPUTER AIDED TRANSMISSION OF MESSAGES AND IMAGES; DIGITAL TRANSMISSION SERVICES VIA INTERNET, NAMELY INFORMATION TRANSMISSION SERVICES VIA DIGITAL NETWORKS; IP COMMUNICATION SERVICES OF STREAMED INFORMATION, NAMELY DATA CONSISTING OF TEXT AND MEDIA, COMMUNICATIONS BY COMPUTER TERMINALS, TRANSMISSION OF MESSAGES OVER ELECTRONIC MEDIA, PROVIDING MULTIPLE-USER ACCESS TO A GLOBAL OR A LOCAL COMPUTER INFORMATION NETWORK (U.S. CLS. 100, 101 AND 104).

CLASS 42—SCIENTIFIC, COMPUTER AND LEGAL SERVICES

FOR COMPUTER SYSTEMS ANALYSIS SERVICES; TECHNOLOGY SUPERVISION IN THE FIELDS OF COMPUTER NETWORKS, UPDATING OF COMPUTER SOFTWARE FOR OTHERS (U.S. CLS. 100 AND 101).
FLORENTINA BLANDU, EXAMINING ATTORNEY

SN 79-014,882. NBC INC., JAPAN, FILED 6-21-2005.



PRIORITY DATE OF 3-4-2005 IS CLAIMED.
OWNER OF INTERNATIONAL REGISTRATION 0860875 DATED 6-21-2005, EXPIRES 6-21-2015.

THE COLORS BLUE, WHITE AND YELLOW ARE CLAIMED AS A FEATURE OF THE MARK.

THE COLOR BLUE APPEARS IN THE REPRESENTATION OF THE GLOBE AND THE LETTER "V"; THE LINES ON THE GLOBE APPEAR WHITE; AND THE WORD SCREEN, ITS UNDERLINE AND THE OUTLINE OF THE LETTER "V" APPEAR IN YELLOW.

CLASS 7—MACHINERY

FOR CARTRIDGES FOR AIR FILTERING MACHINES FOR ENGINES; AIR AND OIL FILTERING MACHINES FOR CLEANING AND COOLING AIR FOR ENGINES; AIR AND OIL FILTERS FOR CLEANING COOLING AIR FOR ENGINES; FILTERS AS PARTS OF MACHINES AND ENGINES; PRINTING SCREENS, PRINTING PLATES; VACUUM CLEANER BAGS (U.S. CLS. 13, 19, 21, 23, 31, 34 AND 35).

CLASS 24—FABRICS

FOR FABRICS, NAMELY, SYNTHETIC RESIN MATERIAL FOR THE MANUFACTURE OF PRINTING SCREENS; FABRICS FOR TEXTILE USE FOR THE MANUFACTURE OF CLOTHING, CURTAINS, AND COVER CLOTH FOR PREVENTING DUST; FABRIC FOR BOOTS AND SHOES, FILTERING MATERIALS OF TEXTILE NAMELY, MESH-WOVEN FABRIC; MOSQUITO NETS (U.S. CLS. 42 AND 50).

ELIZABETH PIGNATELLO, EXAMINING ATTORNEY

SN 79-014,973. INTEC HOLDING GMBH, FED REP GERMANY, FILED 6-16-2005.

PRELAM

PRIORITY DATE OF 6-3-2005 IS CLAIMED.
OWNER OF INTERNATIONAL REGISTRATION 0861124
DATED 6-16-2005, EXPIRES 6-16-2015.

CLASS 7—MACHINERY

FOR MACHINES FOR THE PRODUCTION OF LAMINATE LAYERS WITH ELECTRONIC CHIPS AND COILS SOLD AS A UNIT; MACHINES FOR PROCESSING LAMINATE LAYERS BY LAMINATING PROCESSES (U.S. CLS. 13, 19, 21, 23, 31, 34 AND 35).

CLASS 9—ELECTRICAL AND SCIENTIFIC APPARATUS

FOR BLANK INTEGRATED CIRCUITS CARDS, NAMELY BLANK SMARTCARDS; ENCODED INTEGRATED CIRCUIT CARDS, NAMELY SMARTCARDS CONTAINING PROGRAMMING TO IDENTIFY PERSONS, OBJECTS AND ANIMALS FOR USE IN ACCESS SYSTEMS, IDENTIFICATION SYSTEMS, ELECTRONIC MONEY SYSTEMS AND PORTABLE DATABASE SYSTEMS; MAGNETIC CARDS; CARDS WITH ELECTRONICALLY SAVED DATA, NAMELY ELECTRONIC CIRCUIT CARDS; RADIO FREQUENCY IDENTIFICATION TAGS PROVIDED WITH COMPUTER CHIPS, SOLD AS A UNIT THEREIN (U.S. CLS. 21, 23, 26, 36 AND 38).

CLASS 17—RUBBER GOODS

FOR PLASTIC CONDUIT FOR ELECTRONIC COMPONENTS; PLASTIC CONDUIT FOR TRANSPONDERS; LAMINATES AND LAMINATE LAYERS MADE FROM PLASTICS AND TEXTILES, NAMELY PLASTIC LAMINATED SHEETS AND PANELS FOR USE IN THE MANUFACTURE OF CHIP CARDS AND SMART CARDS, LAMINATED NEOPRENE SHEETS FOR FURTHER USE IN INDUSTRIAL MANUFACTURE; LAMINATES AND LAMINATE LAYERS MADE FROM PAPER, NAMELY PLASTIC FILMS FOR USE IN LAMINATING PAPER; PLASTIC FILMS FOR USE IN THE MANUFACTURE OF CHIP CARDS AND SMART CARDS (U.S. CLS. 1, 5, 12, 13, 35 AND 50).

JENNIFER MCROBBIE, EXAMINING ATTORNEY

SN 79-014,980. LUNDH, JÖRAN, SWEDEN, FILED 8-17-2005.

LASCAL

OWNER OF INTERNATIONAL REGISTRATION 0861146
DATED 8-17-2005, EXPIRES 8-17-2015.

CLASS 12—VEHICLES

FOR TODDLERS' FOOTBOARDS FOR PRAMS, PUSH-CHAIRS AND CHILD TRAILERS; PRAMS AND PRAM ACCESSORIES, NAMELY APRONS AND HOODS FOR PRAMS, CHANGING BAGS ADAPTED FOR PRAMS, FOOT MUFFS ADAPTED FOR PRAMS, PARASOLS ADAPTED FOR PRAMS, RAIN COVERS ADAPTED FOR PRAMS, AND BASKETS ADAPTED FOR PRAMS; SAFETY SEATS FOR CHILDREN AND VEHICLES; VEHICLE SAFETY EQUIPMENT FOR CHILDREN, NAMELY SEAT SAFETY HARNESSSES FOR MOTOR CARS, SAFETY SEATS, AND CHILD CARRIERS (U.S. CLS. 19, 21, 23, 31, 35 AND 44).

CLASS 19—NON-METALLIC BUILDING MATERIALS

FOR NON-METAL SAFETY GATES AND SAFETY BARRIERS FOR STAIRCASES, DOORWAYS AND GATEWAYS (U.S. CLS. 1, 12, 33 AND 50).

CLASS 20—FURNITURE AND ARTICLES NOT OTHERWISE CLASSIFIED

FOR BEDS FOR CHILDREN, FURNITURE FOR CHILDREN AND CHILDREN'S ROOMS; BASSINETTES, BABY WALKERS AND BABIES PLAYPENS (U.S. CLS. 2, 13, 22, 25, 32 AND 50).

CHERYL CLAYTON, EXAMINING ATTORNEY

SN 79-015,267. 21PUBLISH WEB SERVICES GMBH, FED REP GERMANY, FILED 2-8-2005.

21Publish

THE MARK CONSISTS OF STANDARD CHARACTERS WITHOUT CLAIM TO ANY PARTICULAR FONT, STYLE, SIZE, OR COLOR.

PRIORITY DATE OF 8-9-2004 IS CLAIMED.
OWNER OF INTERNATIONAL REGISTRATION 0861929
DATED 2-8-2005, EXPIRES 2-8-2015.

CLASS 9—ELECTRICAL AND SCIENTIFIC APPARATUS

FOR SOFTWARE FOR THE BUILDING AND THE UPDATING OF WEBSITES (U.S. CLS. 21, 23, 26, 36 AND 38).

CLASS 35—ADVERTISING AND BUSINESS

FOR COMPUTERIZED DATABASE MANAGEMENT (U.S. CLS. 100, 101 AND 102).

CLASS 38—COMMUNICATION

FOR PROVIDING ON-LINE CHAT ROOMS, ELECTRONIC BULLETIN BOARDS AND FORUMS FOR TRANSMISSION OF MESSAGES AMONG COMPUTER USERS CONCERNING TOPICS OF GENERAL INTEREST, ELECTRONIC MAIL SERVICES, TRANSMISSION OF NEWS, WEB MESSAGING, NAMELY, FORWARDING NEWS OF ALL KINDS TO WEB ADDRESSES (U.S. CLS. 100, 101 AND 104).

CLASS 42—SCIENTIFIC, COMPUTER AND LEGAL SERVICES

FOR CONSULTATION CONCERNING THE CREATION OF HOMEPAGES AND WEBSITES, DESIGN OF HOMEPAGES AND WEBSITES, SOFTWARE LICENSING, MANAGEMENT OF COMPUTER SERVERS OF OTHERS, HOSTING THE WEB SITES OF OTHERS ON A COMPUTER SERVER FOR A GLOBAL COMPUTER NETWORK, RENTAL OF COMPUTER SOFTWARE, RENTAL OF DATABASE SOFTWARE, RENTAL OF DATABASE SERVERS, WEB HOSTING SERVICES, NAMELY PROVIDING ELECTRONIC STORAGE CAPACITY ON THE INTERNET FOR EXTERNAL USE, CREATING AND MAINTAINING INTERNET PLATFORMS FOR OTHERS FEATURING WEB SITE LINKS TO MULTIPLE BUSINESS ENTITIES WITH E-COMMERCE FUNCTIONALITY, DESIGNING INTERNET PORTAL WEBSITES FOR OTHERS (U.S. CLS. 100 AND 101).

JAMES LOVELACE, EXAMINING ATTORNEY

SN 79-015,382. TRESPA INTERNATIONAL B.V., NL-6002 SM WEERT, NETHERLANDS, FILED 5-20-2005.



OWNER OF INTERNATIONAL REGISTRATION 0862292 DATED 5-20-2005, EXPIRES 5-20-2015.

OWNER OF U.S. REG. NO. 1,706,761.

NO CLAIM IS MADE TO THE EXCLUSIVE RIGHT TO USE "SURFACE TECHNOLOGY", APART FROM THE MARK AS SHOWN.

THE COLOR(S) YELLOW AND BLACK IS/ARE CLAIMED AS A FEATURE OF THE MARK.

THE MARK CONSISTS OF THE COLOR YELLOW APPEARING IN THE SHADED BOX AND THE COLOR BLACK APPEARING IN THE LETTERING AND LINES.

CLASS 17—RUBBER GOODS

FOR SEMI-FINISHED AND FINISHED THERMOPLASTIC PRODUCTS, EXCLUDING FLEXIBLE TUBING, HOSES, AND CLIPS THEREFORE AND EXCLUDING PACKAGE BANDING STRIPS, NAMELY DECORATION FOILS, BOARDS, AND LAMINATES FOR USE IN WALL BOARDS FOR WALL PANELLING, FACADES, WASH ROOMS, SANITARY AND OTHER DAMP ROOMS, DECORATIVE PANELS, WORKTOPS, AND PARTITIONS USED IN FURNITURE (U.S. CLS. 1, 5, 12, 13, 35 AND 50).

CLASS 19—NON-METALLIC BUILDING MATERIALS

FOR NON-METAL BOARDS, NAMELY, WALL BOARDS FOR WALL PANELLING, FACADES, WASH ROOMS, SANITARY AND OTHER DAMP ROOMS, BOARDS FOR PANELLING BALCONIES, DOORS, CEILING AND FLOORS (U.S. CLS. 1, 12, 33 AND 50).

CLASS 20—FURNITURE AND ARTICLES NOT OTHERWISE CLASSIFIED

FOR BOARDS, NAMELY DECORATIVE PANELS, WORKTOPS AND PARTITIONS USED IN FURNITURE (U.S. CLS. 2, 13, 22, 25, 32 AND 50).

EUGENIA MARTIN, EXAMINING ATTORNEY

SN 79-015,419. HENKEL KGAA, FED REP GERMANY, FILED 8-5-2005.

XIBIT

THE MARK CONSISTS OF STANDARD CHARACTERS WITHOUT CLAIM TO ANY PARTICULAR FONT, STYLE, SIZE, OR COLOR.

PRIORITY DATE OF 2-25-2005 IS CLAIMED.

OWNER OF INTERNATIONAL REGISTRATION 0862399 DATED 8-5-2005, EXPIRES 8-5-2015.

CLASS 16—PAPER GOODS AND PRINTED MATTER

FOR STATIONERY; ADHESIVES FOR STATIONERY OR HOUSEHOLD PURPOSES; PHOTOGRAPHS (U.S. CLS. 2, 5, 22, 23, 29, 37, 38 AND 50).

CLASS 20—FURNITURE AND ARTICLES NOT OTHERWISE CLASSIFIED

FOR PICTURE FRAMES NOT OF PRECIOUS METAL (U.S. CLS. 2, 13, 22, 25, 32 AND 50).

RON FAIRBANKS, EXAMINING ATTORNEY

SN 79-015,834. HTP EST, FRANCE, FILED 5-20-2005.



PRIORITY DATE OF 3-31-2005 IS CLAIMED.

OWNER OF INTERNATIONAL REGISTRATION 0863524 DATED 5-20-2005, EXPIRES 5-20-2015.

THE COLOR(S) LIGHT BROWN AND GRAY IS/ARE CLAIMED AS A FEATURE OF THE MARK.

THE COLOR LIGHT BROWN APPEARS IN THE WORDING 'LEA,' THE COLOR GRAY APPEARS IN THE CIRCULAR DESIGN PORTION.

CLASS 7—MACHINERY

FOR MACHINES FOR THE PRODUCTION OF BITUMINOUS COATINGS WORKED AT LOW TEMPERATURE FOR ROADS AND DRIVEWAYS; MACHINES FOR APPLICATION OF BITUMINOUS COATINGS WORKED AT LOW TEMPERATURE TO ROADS AND DRIVEWAYS, NAMELY ASPHALT PAVING MACHINES AND TAR SEALANT SPRAYING MACHINES (U.S. CLS. 13, 19, 21, 23, 31, 34 AND 35).

CLASS 19—NON-METALLIC BUILDING MATERIALS

FOR BITUMINOUS COATINGS FOR ROADS AND DRIVEWAYS WORKED AT LOW TEMPERATURE (U.S. CLS. 1, 12, 33 AND 50).

CLASS 37—CONSTRUCTION AND REPAIR

FOR THE APPLICATION OF BITUMINOUS COATINGS WORKED AT LOW TEMPERATURE TO ROADS AND DRIVEWAYS, NAMELY ROAD AND DRIVEWAY ASPHALT PAVING AND TAR SEALING SERVICES (U.S. CLS. 100, 103 AND 106).

SOPHIA S. KIM, EXAMINING ATTORNEY

CLASS 12—VEHICLES

FOR AUTOMOTIVE VEHICLE PARTS, NAMELY MECHANICAL, HYDROMECHANICAL, ELECTROMECHANICAL, ELECTROHYDRAULIC BRAKE SYSTEMS, SOLD SEPARATELY AND AS A UNIT WITH ELECTRONIC CONTROLS FOR BRAKE SYSTEMS, AND PARTS THEREOF, NAMELY ELECTRONIC PARKING BRAKES (EPB), ACTIVE PARKING BRAKES (APB) AND DRIVEWAY INTERLOCK BRAKE SYSTEMS, ANTI-LOCK BRAKE SYSTEMS (ABS), TRACTION CONTROL SYSTEMS (TCS), STABILITY MANAGEMENT SYSTEMS (ESP), ELECTRONIC AND MECHANICAL BRAKE FORCE DISTRIBUTORS (EBD), MECHANICAL, HYDROMECHANICAL, ELECTROMECHANICAL, ELECTROHYDRAULIC WHEEL BRAKE AND ACTUATING DEVICES AND PARTS THEREOF, NAMELY BRAKE DISCS, DRUM BRAKES, BRAKE SHOES, WHEEL CYLINDERS, BRAKE PADS, BRAKE CALIPERS FOR DISC BRAKES, BOOSTERS, PEDAL ASSEMBLIES, MASTER CYLINDERS, PUMPS FOR VEHICLES, AND CONNECTING WIRES, HOSES, AND LINKAGES FOR THE AFOREMENTIONED PARTS (U.S. CLS. 19, 21, 23, 31, 33 AND 44).

CLASS 37—CONSTRUCTION AND REPAIR

FOR REPAIR AND RESTORATION OF VEHICLES AND VEHICLE PARTS THEREOF SUCH AS BRAKE CALIPERS, BRAKE DISCS (U.S. CLS. 100, 103 AND 106).

JULIE WATSON, EXAMINING ATTORNEY

SN 79-016,022. CONTINENTAL TEVES AG & CO. OHG, FED REP GERMANY, FILED 3-31-2005.

RIXENBERG

THE MARK CONSISTS OF STANDARD CHARACTERS WITHOUT CLAIM TO ANY PARTICULAR FONT, STYLE, SIZE, OR COLOR.

OWNER OF INTERNATIONAL REGISTRATION 0804467 DATED 12-17-2002, EXPIRES 12-17-2012.

CLASS 8—HAND TOOLS

FOR MANUALLY OPERATED TOOLS FOR WORKING ON VEHICLE BRAKE CALIPERS AND BRAKE PADS, NAMELY BRAKE PAD WITHDRAWAL TOOLS, PISTON RETURN DEVICES, PISTON TURNING TOOLS, BRAKE CALIPER GUIDE FILES, SOCKET WRENCHES, BRAKE CALIPER WRENCHES, BUSH REMOVERS, PROTECTIVE CAP DRIVERS AND INSERTION TOOLS, WRENCHES, PLIERS, PISTON CLIPS, SPRING MOUNTING TOOLS, PIPE-FLARING TOOLS, PIPE CUTTERS, PIPE DEBURRING TOOLS, PIPE BENDING TOOLS, REAMERS, WHEEL HUB CLEANING SETS, CONSISTING PRIMARILY OF HAND OPERATED ABRADING TOOLS, AND DRUM BRAKE MOUNTING SETS, CONSISTING PRIMARILY OF ADJUSTMENT WRENCHES, SPRING MOUNTING TOOLS, AND ADJUSTING LEVERS (U.S. CLS. 23, 28 AND 44).

CLASS 9—ELECTRICAL AND SCIENTIFIC APPARATUS

FOR ELECTRONIC SENSORS FOR MEASURING VEHICLE PARAMETERS, ELECTRONIC CIRCUITS AND SWITCHES FOR DETERMINING AND EVALUATING VEHICLE PARAMETERS; ELECTRONIC SENSORS FOR VEHICLES FOR MEASURING TRAFFIC OR HAZARD INFORMATION EXTERNAL TO THE VEHICLE (U.S. CLS. 21, 23, 26, 36 AND 38).

SN 79-016,087. KERMEL, FRANCE, FILED 9-16-2005.



PRIORITY DATE OF 4-11-2005 IS CLAIMED.
OWNER OF INTERNATIONAL REGISTRATION 0864199 DATED 9-16-2005, EXPIRES 9-16-2015.

THE COLOR(S) RED, ORANGE, BLUE, WHITE AND GREEN IS/ARE CLAIMED AS A FEATURE OF THE MARK.

THE COLOR RED APPEARS IN THE LETTERING FOR HEROSKIN AND IN THE FLAMES; THE COLOR ORANGE APPEARS IN THE FLAMES; THE COLOR BLUE APPEARS IN THE CLOTHING OF THE PERSON IN PROTECTIVE CLOTHING, ON THE CURVED DESIGN AND SMALL STRIP TO THE LEFT OF THE WORDING KERMEL; THE COLOR WHITE APPEARS IN THE WORDING KERMEL AND ON THE HOOD AND JACKET OF THE PERSON IN PROTECTIVE CLOTHING; THE COLOR GREEN APPEARS ON THE STRIP AROUND THE WORD KERMEL.

CLASS 9—ELECTRICAL AND SCIENTIFIC APPARATUS

FOR CLOTHING TO BE WORN AT ALL TIMES OR FIRE ENTRY SUITS FOR PROTECTION AGAINST HEAT, FIRE AND FLAMES, NAMELY JACKETS, TROUSERS, OVER TROUSERS, COMBINATIONS, UNDERWEAR; FOOTWEAR AND BOOTS TO PROTECT AGAINST HEAT, FIRE AND FLAMES; HELMETS AND HOODS TO PROTECT AGAINST HEAT, FIRE AND FLAMES (U.S. CLS. 21, 23, 26, 36 AND 38).

CLASS 25—CLOTHING

FOR WORK CLOTHING, NAMELY WORKING OVERALLS AND WORK SHOES AND BOOTS; JACKETS; PARKAS; TROUSERS; UNIFORMS; UNDERWEAR; TEE-SHIRTS; SHIRTS; JUMPERS; PULLOVERS; SHOES; BOOTS; HOODS; SCARVES; CAPS; AND HATS (U.S. CLS. 22 AND 39).

ALEXANDER L. POWERS, EXAMINING ATTORNEY

CLASS 29—MEATS AND PROCESSED FOODS

FOR PRESERVED MEAT, POULTRY AND GAME; PRESERVED FISH; CANNED FRUITS; CANNED VEGETABLES; CANNED FISH; CANNED MEAT; PRESERVES, NAMELY JAMS; MEAT; FISH; POULTRY AND GAME; PRESERVED, DRIED AND COOKED FRUITS AND VEGETABLES; PICKLES; VEGETABLES IN VINEGAR; VEGETABLE STOCK FOR COOKING; PRESERVED POT HERBS; PRESERVED MUSHROOMS (U.S. CL. 46).

CLASS 30—STAPLE FOODS

FOR COFFEE, TEA, COCOA, SUGAR, RICE, TAPIOCA, SAGO, ARTIFICIAL COFFEE; FLOURS; PROCESSED CEREALS; BREAD; PASTRIES; CONFECTIONERIES, NAMELY CANDIES, CHOCOLATES, CHOCOLATE CANDIES, BUTTER CANDIES, CANDIES MADE WITH NUTS, CAKES, COOKIES, CROISSANTS, ECLAIRS, PIES, MUFFINS, AND SHERBETS; FROZEN CONFECTIONS; BISCUITS; EDIBLE ICES; HONEY, TREACLE; YEAST; BAKING POWDER; SALT; MUSTARD; VINEGAR; CONDIMENT SAUCES; SPICES; ICE (U.S. CL. 46).

CLASS 32—LIGHT BEVERAGES

FOR BEERS, MINERAL WATER, FRUIT DRINKS AND FRUIT JUICES; SYRUPS AND OTHER PREPARATIONS FOR MAKING FRUIT DRINKS, NON-ALCOHOLIC FRUIT EXTRACTS, SOFT DRINKS, AND NON-ALCOHOLIC COCKTAIL DRINKS; AND NON-ALCOHOLIC BEVERAGES, NAMELY, NON-ALCOHOLIC APERITIFS, NON-ALCOHOLIC BEER, PUNCH, COCKTAIL MIXES, AERATED WATER, VEGETABLE JUICE, WHEY BEVERAGES, ISOTONIC DRINKS, AND FRUIT JUICES (U.S. CLS. 45, 46 AND 48).

CLASS 33—WINES AND SPIRITS

FOR ALCOHOLIC BEVERAGES, EXCLUDING BEER, NAMELY WINE, DISTILLED SPIRITS, RUM, BRANDY, BITTERS, ALCOHOLIC APERITIFS, DIGESTERS BASED ON LIQUEURS, LIQUEURS, ALCOHOLIC FRUIT EXTRACTS, VODKA, WHISKEY, CURACAO, AND GIN (U.S. CLS. 47 AND 49).

AMEETA JORDAN, EXAMINING ATTORNEY

SN 79-016,089. HOLSET ENGINEERING COMPANY LIMITED, HUDDERSFIELD HD1 6RA, UNITED KINGDOM, FILED 5-13-2005.

COMMAND VALVE

PRIORITY DATE OF 4-1-2005 IS CLAIMED.
OWNER OF INTERNATIONAL REGISTRATION 0864201 DATED 5-13-2005, EXPIRES 5-13-2015.
NO CLAIM IS MADE TO THE EXCLUSIVE RIGHT TO USE "VALVE", APART FROM THE MARK AS SHOWN.

CLASS 7—MACHINERY

FOR TURBOCHARGERS, AIR COMPRESSORS AND WASTEGATES FOR MACHINERY AND FOR ENGINES; TURBINES AND TURBINE WHEELS; COMPRESSED AIR PUMPS; WHEELS BEING PARTS OF MACHINES; COMPRESSOR WHEELS; MOTORS FOR AIRPLANES; MOTORS FOR BOATS; ELECTRIC MOTORS FOR MACHINES; INDUSTRIAL MACHINE PRESSES; METAL WORKINGS MACHINES, NAMELY MACHINE CENTERS; REPLACEMENT PARTS FOR ALL THE AFORESAID GOODS INCLUDED IN THIS CLASS (U.S. CLS. 13, 19, 21, 23, 31, 34 AND 35).

CLASS 12—VEHICLES

FOR TURBOCHARGERS, AIR COMPRESSORS AND WASTEGATES, ALL FOR LAND VEHICLE PROPULSION; AND STRUCTURAL PARTS THEREFOR (U.S. CLS. 19, 21, 23, 31, 35 AND 44).

CLASS 37—CONSTRUCTION AND REPAIR

FOR MAINTENANCE, REPAIR AND SERVICING OF ENGINES AND OF PARTS THEREOF; MAINTENANCE, REPAIR AND SERVICING OF TURBOCHARGERS AND AIR COMPRESSORS AND PARTS AND FITTINGS THEREFOR (U.S. CLS. 100, 103 AND 106).

DANNEAN HETZEL, EXAMINING ATTORNEY

SN 79-016,519. ECHOSSENS, FRANCE, FILED 8-25-2005.

SN 79-016,405. F.URL & CO. GESELLSCHAFT M.B.H., AUSTRIA, FILED 10-13-2005.



OWNER OF INTERNATIONAL REGISTRATION 0856155 DATED 5-23-2005, EXPIRES 5-23-2015.

FIBROSCAN

THE MARK CONSISTS OF STANDARD CHARACTERS WITHOUT CLAIM TO ANY PARTICULAR FONT, STYLE, SIZE, OR COLOR.
OWNER OF INTERNATIONAL REGISTRATION 0865019 DATED 8-25-2005, EXPIRES 8-25-2015.

CLASS 9—ELECTRICAL AND SCIENTIFIC APPARATUS

FOR SCIENTIFIC APPARATUS AND INSTRUMENTS FOR OPTICAL WEIGHING AND MEASURING, NAMELY, ULTRASOUND APPARATUS FOR MEASURING THE HARDNESS AND ELASTICITY OF TISSUES AND ORGANS; SCIENTIFIC APPARATUS FOR RECORDING, TRANSMITTING, REPRODUCING SOUNDS AND IMAGES IN THE FIELD OF THE HARDNESS AND THE ELASTICITY OF TISSUES AND ORGANS; APPARATUS AND INSTRUMENTS FOR LABORATORY RESEARCH, NAMELY ULTRASOUND MACHINE FOR MEASURING LIVER FIBROSIS; PRE-RECORDED CD-ROM DISKS FOR THE INSTALLATION OF COMPUTER PROGRAMS IN THE FIELD OF MEDICINE (U.S. CLS. 21, 23, 26, 36 AND 38).

CLASS 10—MEDICAL APPARATUS

FOR ARTIFICIAL LIMBS, EYES AND TEETH; SUTURE MATERIALS; MEDICAL APPARATUS FOR MEASURING LIVER FIBROSIS (U.S. CLS. 26, 39 AND 44).

CLASS 42—SCIENTIFIC, COMPUTER AND LEGAL SERVICES

FOR SCIENTIFIC RESEARCH SERVICES FOR MEDICAL PURPOSES (U.S. CLS. 100 AND 101).
ODESSA BIBBINS, EXAMINING ATTORNEY

CLASS 10—MEDICAL APPARATUS

FOR SENSORS FOR MEASURING THE PRESSURE, TEMPERATURE AND FLOW OF INTRAVASCULAR CHARACTERISTICS, NAMELY GUIDE WIRE MOUNTED SENSORS; INSTRUMENTS FOR MANIPULATING MEASUREMENT OF DATA RELATED THERETO, NAMELY INTERFACES FOR GUIDE WIRE MOUNTED SENSORS; INSTRUMENTS FOR MANAGING HEMOSTATIS; INSTRUMENTS FOR APPLYING EXTERNAL COMPRESSION PRESSURE ON THE FEMORAL AND RADIAL ARTERIES, NAMELY FEMORAL COMPRESSORS AND RADIAL COMPRESSORS AND INSTRUMENTS ADAPTED FOR DELIVERING MECHANICAL SEALS OR HEMOSTATIC AGENTS IN A PUNCTUATION CANAL CREATED IN A CATHETERIZATION PROCEDURE, NAMELY ARTERY PUNCTURE CLOSURES; BIOPSY SYSTEMS COMPRISED OF POSITION INDICATORS FOR BIOPSY SAMPLING AND INSTRUMENTS FOR PERFORMING BIOPSIES AND NEPHROSTOMY OPERATIONS; INSTRUMENTS FOR ASSISTING IN PUNCTUATION OPERATIONS, NAMELY PUNCTURE GUIDES AND ADAPTERS DESIGNED TO TRANSFER POSITION INFORMATION FROM A COMPUTER GENERATED IMAGE TO A PATIENT'S SKIN (U.S. CLS. 26, 39 AND 44).
MATTHEW MCDOWELL, EXAMINING ATTORNEY

SN 79-016,737. YAMASA SHOYU KABUSHIKI KAISHA (ALSO TRADING AS YAMASA CORPORATION), JAPAN, FILED 1-18-2005.

ヤマサ

OWNER OF INTERNATIONAL REGISTRATION 0865902 DATED 1-18-2005, EXPIRES 1-18-2015.
OWNER OF U.S. REG. NO. 1,226,802.
THE NON-LATIN CHARACTERS IN THE MARK TRANSLITERATE TO "YAMASA," AND THIS HAS NO MEANING IN ENGLISH.

CLASS 29—MEATS AND PROCESSED FOODS

FOR SOUP STOCK; JAPANESE-STYLE SOUP STOCK, ALSO KNOWN AS DASHI, MADE FROM DRIED BONITO, ALSO KNOWN AS KATSUO-BUSHI, OR KELP, ALSO KNOWN AS KOMBU; SOUP BASE FOR NOODLES; INSTANT OR PRE-COOKED SOUP (U.S. CL. 46).

CLASS 30—STAPLE FOODS

FOR SOY SAUCE, SOY SAUCE MIXED WITH VINEGAR AND CITRUS JUICE, ALSO KNOWN AS PONZU SOY SAUCE, SAUCES, DIPPING SAUCE FOR NOODLES, SALAD DRESSINGS, SEASONINGS (U.S. CL. 46).
ANNE MADDEN, EXAMINING ATTORNEY

SN 79-016,524. RADI MEDICAL SYSTEMS AB, SWEDEN, FILED 11-19-2004.

RADI MEDICAL

OWNER OF INTERNATIONAL REGISTRATION 0865045 DATED 11-19-2004, EXPIRES 11-19-2014.
NO CLAIM IS MADE TO THE EXCLUSIVE RIGHT TO USE "MEDICAL", APART FROM THE MARK AS SHOWN.

CLASS 9—ELECTRICAL AND SCIENTIFIC APPARATUS

FOR SOFTWARE FOR DIGITAL TRANSFER OF PHYSIOLOGICAL RECORDINGS WITHIN THE FIELD OF MEDICAL DEVICES, DIAGNOSTICS AND TECHNOLOGIES; SOFTWARE FOR MANIPULATING DATA OBTAINED BY GUIDE WIRE MOUNTED SENSORS (U.S. CLS. 21, 23, 26, 36 AND 38).

SN 79-016,913. THERMATIS TECHNOLOGIES, F-26800 PORTES LES VALENCE, FRANCE, FILED 7-28-2005.

SOFATH

OWNER OF INTERNATIONAL REGISTRATION 0619835 DATED 5-10-1994, EXPIRES 5-10-2014.

CLASS 11—ENVIRONMENTAL CONTROL APPARATUS

FOR HEATING APPARATUS, NAMELY, GEOTHERMIC AND ELECTRIC HEATING APPARATUS FOR DOMESTIC USE, HEAT PUMPS, AIR CONDITIONING APPARATUS FOR DOMESTIC USE, REFRIGERATING MACHINES, HEAT EXCHANGERS NOT BEING PARTS OF MACHINES AND THEIR PARTS (U.S. CLS. 13, 21, 23, 31 AND 34).

CLASS 37—CONSTRUCTION AND REPAIR

FOR INSTALLATION AND REPAIR OF HEATING APPARATUS, HEAT PUMPS, AIR CONDITIONING APPARATUS, REFRIGERATING CIRCUITS, AND HEAT EXCHANGERS (U.S. CLS. 100, 103 AND 106).

TIMOTHY FINNEGAN, EXAMINING ATTORNEY

CLASS 16—PAPER GOODS AND PRINTED MATTER

FOR ARTICLES OF PAPER, CARDBOARD, AND OFFICE REQUISITES, NAMELY, INKSTANDS, PENS, PAINT BRUSHES, PENCILS, STATIONERY, DRAWING ARTICLES IN THE NATURE OF COLORED PENCILS, ART PAPER, GREETINGS CARDS; PRINTED MATTER, NAMELY, NEWSPAPERS, MAGAZINES, PERIODICALS, PAMPHLETS, BOOKS, INSTRUCTION MANUALS, REFERENCE GUIDES, AND CATALOGUES IN THE FIELDS OF ARCHITECTURE, INTERIOR AND EXTERIOR DESIGN, LANDSCAPING; DIARIES, POSTERS, CALENDARS, LITHOGRAPHS OR ENGRAVINGS, PHOTOGRAPHS, ADHESIVE LABELS (U.S. CLS. 2, 5, 22, 23, 29, 37, 38 AND 50).

CLASS 18—LEATHER GOODS

FOR GOODS MADE OF LEATHER, SKINS AND IMITATIONS OF LEATHER AND SKINS, NAMELY, LEATHER BAGS, HANDBAGS, SUITCASES, PURSES, BRIEFCASES, KEY-CASES OF LEATHER AND SKINS, UMBRELLAS, RAW SKINS (U.S. CLS. 1, 2, 3, 22 AND 41).

CLASS 25—CLOTHING

FOR CLOTHING FOR MEN, WOMEN AND CHILDREN, NAMELY, DRESSES, SKIRTS, TROUSERS, SHORTS, JACKETS AND GREATCOATS; WATERPROOF CLOTHING, NAMELY OVERCOATS; SHIRTS, T-SHIRTS, SPORTS JERSEYS, PULLOVERS, SWEAT-SHIRTS, SWIMSUITS, UNDERWEAR, BELTS, HATS, SCARVES, TIES, GLOVES, SHOES, SLIPPERS, BOOTS, SHOES FOR GYMNASTICS AND SPORTS (U.S. CLS. 22 AND 39).

CLASS 31—NATURAL AGRICULTURAL PRODUCTS

FOR AGRICULTURAL, HORTICULTURAL AND FORESTRY PRODUCTS, NAMELY, UNPROCESSED GRAINS, LIVE ANIMALS, FRESH FRUITS AND VEGETABLES; SEEDS, NATURAL PLANTS AND FLOWERS, DECORATIVE DRY PLANTS, FOODSTUFFS FOR ANIMALS (U.S. CLS. 1 AND 46).

CLASS 35—ADVERTISING AND BUSINESS

FOR ADVERTISING; OPERATING AND MANAGING A COMMERCIAL CONCERN FOR THIRD PARTIES; MANAGING THE AFFAIRS OR COMMERCIAL FUNCTIONS OF AN INDUSTRIAL OR COMMERCIAL CONCERN FOR THIRD PARTIES; DATABASE MANAGEMENT FOR THIRD PARTIES; TELEVISION ADVERTISING AND ADVERTISING VIA DATA TRANSMISSION AND COMPUTER NETWORKS; PREPARATION AND DISSEMINATION, VIA THE PRESS, RADIO, VIDEO, AND DATA TRANSMISSION, OF COMMUNICATIONS AND NOTICES TO THE PUBLIC OF AN ADVERTISING OR PROMOTIONAL NATURE RELATING TO GOODS OR SERVICES; GROUPING TOGETHER, DISPLAY AND PRESENTATION, INCLUDING VIA DATA TRANSMISSION NETWORKS, OF GOODS WITHOUT TRANSPORT SO THAT THE PUBLIC CAN SEE THEM AND PURCHASE THEM; ARRANGING AND CONDUCTING OF FAIRS AND EXHIBITIONS FOR BUSINESS AND ADVERTISING PURPOSES; MARKET RESEARCH (U.S. CLS. 100, 101 AND 102).

SN 79-016,973. ARNOLDO MONDADORI EDITORE S.P.A., I-20122 MILANO, ITALY, FILED 8-3-2004.

CASE NEL VERDE
VILLEGIARDINI

PRIORITY DATE OF 3-30-2004 IS CLAIMED.
OWNER OF INTERNATIONAL REGISTRATION 0866554
DATED 8-3-2004, EXPIRES 8-3-2014.

THE ENGLISH TRANSLATION OF "VILLEGIARDINI" IS "DETACHED GARDEN HOUSES" AND THE TRANSLATION OF "CASE NEL VERDE" IS "HOUSES SURROUNDED BY GREENERY".

CLASS 9—ELECTRICAL AND SCIENTIFIC APPARATUS

FOR DESKTOP AND PORTABLE COMPUTERS, PRINTERS, MODEMS, APPARATUS FOR RECORDING, TRANSMISSION OR REPRODUCTION OF SOUND, IMAGES AND SOFTWARE, SOFTWARE FOR THE MANAGEMENT, CONTROL, TROUBLE-SHOOTING AND ANALYSIS OF COMPUTERS AND COMPUTER NETWORKS, BLANK DISKS, CASSETTES, TAPES, CD-ROMS, DVDS, AND OTHER AUDIO AND VIDEO RECORDABLE MEDIA, PRE-RECORDED DISKS, CASSETTES, TAPES, CD-ROMS, DVDS, FEATURING ARCHITECTURE, INTERIOR AND EXTERIOR DESIGN, LANDSCAPING; APPARATUS FOR ELECTRONIC GAMES FOR USE WITH TELEVISION RECEIVERS, SPECTACLES AND ACCESSORIES FOR SPECTACLES, NAMELY, CASES, CHAINS AND HOLDERS (U.S. CLS. 21, 23, 26, 36 AND 38).

CLASS 11—ENVIRONMENTAL CONTROL APPARATUS

FOR APPARATUS FOR LIGHTING, HEATING, COOKING, VENTILATING, AIR CONDITIONING, NAMELY LIGHT DIFFUSERS, CHANDELIERS, ELECTRIC COOKING OVENS, POTS AND STOVES, AIR CONDITIONING UNITS; WATER FOUNTAINS (U.S. CLS. 13, 21, 23, 31 AND 34).

CLASS 38—COMMUNICATION

FOR TELECOMMUNICATIONS, RADIO AND TELEVISION BROADCASTING, IN PARTICULAR DIRECT SATELLITE RADIO BROADCASTING WHOSE SIGNAL CAN BE REBROADCAST FROM TELEVISION AERIALS VIA CABLE AND TERTIARY RADIO AND TELEVISION TRANSMITTERS OR BY MEANS OF ONLINE SERVICES VIA DATA TRANSMISSION OR COMPUTER NETWORKS; CELLULAR TELEPHONE COMMUNICATION; COMMUNICATIONS BY COMPUTER TERMINALS; COMPUTER-AIDED TRANSMISSION OF MESSAGES, INFORMATION AND IMAGES; ELECTRONIC MAIL; PROVIDING INFORMATION ABOUT TELECOMMUNICATIONS, PROVIDING ELECTRONIC BULLETIN BOARDS FOR THE TRANSMISSION OF MESSAGES CONCERNING ARCHITECTURE, INTERIOR AND EXTERIOR DESIGN, LANDSCAPING; ELECTRONIC TRANSMISSION OF DATA AND DOCUMENTS BY COMPUTER; TRANSMISSION OF DATA AND MAIL BY ELECTRONIC MEANS (U.S. CLS. 100, 101 AND 104).

CLASS 43—HOTEL AND RESTAURANT SERVICES

FOR PROVIDING FOOD AND DRINK; BARS AND RESTAURANTS, HOTEL BOOKING SERVICES, PROVIDING LODGING AT TOURIST VILLAGES (U.S. CLS. 100 AND 101).

KIMBERLY FRYE, EXAMINING ATTORNEY

SN 79-017,048, SEELE GMBH & CO. HOLDING KG, FED REP GERMANY, FILED 3-29-2005.

seele

PRIORITY DATE OF 10-8-2004 IS CLAIMED.
OWNER OF INTERNATIONAL REGISTRATION 0866732
DATED 3-29-2005, EXPIRES 3-29-2015.

CLASS 6—METAL GOODS

FOR GUTTER PIPES OF METAL; METAL HARDWARE, NAMELY ANCHOR PLATES; BUILDING MATERIALS AND BUILDING PARTS OF METAL, NAMELY WALL, CEILING, SUPPORT AND CLAMP PROFILES; BUILDING MATERIALS AND BUILDING PARTS OF METAL, NAMELY BLAST-RESISTANT FACADE PANELS; BUILDING PANELS OF METAL; PREFABRICATED BUILDINGS OF METAL; CLAMPS OF METAL; HEATABLE BUILDING PARTS OF METAL, NAMELY WALL PANELS AND FRAMEWORKS; BOLTS OF METAL; GUTTERS OF METAL; WINDOWS OF METAL, INCLUDING ALL ATTACHED PARTS; WINDOW FRAMES OF METAL; STEEL MASTS; WALL CLADDINGS OF METAL; FRAMES OF METAL FOR BUILDING; MOLDINGS OF METAL FOR CORNICES; PIPES OF METAL; LADDERS OF METAL; STEEL SHEETS; PREFABRICATED STEEL BUILDINGS; STEEL MASTS; STEEL PIPES; POLES OF METAL; LINTELS OF METAL; BUILDING MATERIALS, NAMELY PROPS OF METAL; WAINSCOTTING OF METAL; GIRDERS OF METAL; FRAMEWORK OF METAL FOR BUILDING, NAMELY SPACE STRUCTURES OF TUBE BARS, PROFILE BARS, LINKAGES, PLATE MEMBERS AND CONNECTION PIECES ON FLAT OR CURVED SURFACE AREAS IN TERMS OF ROOFS, CUPOLAS, CEILINGS, BUILDING WALLS, HALLS, HANGARS AND TOWERS; STAIRCASES OF METAL; STAIR TREADS OF METAL; PARTS OF STAIRCASES, NAMELY STRINGERS OF METAL; DOOR FRAMES OF METAL; LATCHES OF METAL; DOOR CONSTRUCTIONS AND PARTS OF METAL, INCLUDING ALL ATTACHED PARTS; CLADDING OF METAL FOR CONSTRUCTION AND BUILDING (U.S. CLS. 2, 12, 13, 14, 23, 25 AND 50).

CLASS 19—NON-METALLIC BUILDING MATERIALS

FOR BUILDING GLASS, NAMELY GLASS FINIS, GLASS PANES FOR BUILDING, GLASS BLOCKS FOR BUILDING; BUILDING MATERIALS AND BUILDING PARTS, NOT OF METAL, NAMELY BLAST-RESISTANT FACADE PANELS AND GLASS PANES; BUILDING PANELS, NOT OF METAL; PREFABRICATED BUILDINGS, NOT OF METAL; ROOFING, NOT OF METAL, NAMELY FILIGREE ROOF CONSTRUCTIONS OF GLASS; GUTTERS, NOT OF METAL; WINDOWS, NOT OF METAL, INCLUDING ALL ATTACHED PARTS; WINDOW FRAMES, NOT OF METAL; WINDOW GLASS, FOR BUILDING; PLATE GLASS FOR WINDOWS AND FOR BUILDING; INSULATING GLASS FOR BUILDING; ROOF FLASHING, NOT OF METAL; WALL CLADDINGS, NOT OF METAL, FOR BUILDING; CASEMENT WINDOWS, NOT OF METAL; BUILDING MATERIALS, NAMELY PROPS, NOT OF METAL; WAINSCOTTING, NOT OF METAL; BEAMS, NOT OF METAL; FRAMEWORK, NOT OF METAL, FOR BUILDING; STAIRCASES NOT OF METAL, NAMELY STAIRCASES OF GLASS; STAIR-TREADS, NOT OF METAL, NAMELY STAIR-TREADS OF GLASS; PARTS OF STAIRCASES NOT OF METAL, NAMELY STRINGERS OF GLASS; DOOR CONSTRUCTIONS AND PARTS NOT OF METAL, INCLUDING ALL ATTACHED PARTS; CLADDING, NOT OF METAL, FOR BUILDING; WALL LININGS, NOT OF METAL, FOR BUILDING (U.S. CLS. 1, 12, 33 AND 50).

CLASS 35—ADVERTISING AND BUSINESS

FOR SERVICES OF A PROPERTY DEVELOPER, NAMELY ORGANIZATIONAL PREPARATION OF BUILDING CONSTRUCTION PROJECTS (U.S. CLS. 100, 101 AND 102).

CLASS 36—INSURANCE AND FINANCIAL

FOR SERVICES OF A PROPERTY DEVELOPER, NAMELY FINANCIAL CONSULTANCY OF BUILDING CONSTRUCTION PROJECTS (U.S. CLS. 100, 101 AND 102).

CLASS 37—CONSTRUCTION AND REPAIR

FOR BUILDING OF FAIR STALLS AND SHOPS; BUILDING CONSTRUCTION SUPERVISION; SERVICES OF A PROPERTY DEVELOPER, NAMELY BUILDING CONSTRUCTION AND ITS SUPERVISION AND GENERAL CONSTRUCTION CONTRACTING; MAINTENANCE AND REPAIR OF BUILDINGS (U.S. CLS. 100, 103 AND 106).

CLASS 42—SCIENTIFIC, COMPUTER AND LEGAL SERVICES

FOR ARCHITECTURAL CONSULTATION; SERVICES OF A PROPERTY DEVELOPER, NAMELY TECHNICAL CONSULTATION REGARDING THE PREPARATION OF BUILDING CONSTRUCTION PROJECTS; RESEARCH AND DEVELOPMENT FOR OTHERS IN THE FIELD OF GLAZING, FACADE CONSTRUCTION, ROOF CONSTRUCTION AND STAIR CONSTRUCTION; CONSTRUCTION DRAFTING, IN PARTICULAR CONSTRUCTION DESIGN OF FRAMEWORKS MADE OF STEEL, ALUMINIUM AND GLASS; TECHNICAL CONSULTATION REGARDING FRAMEWORKS FOR BUILDINGS, ROOF CONSTRUCTIONS SPECIFICALLY MADE OF STEEL, ALUMINIUM AND GLASS AND STAIR CONSTRUCTIONS OF GLASS; TECHNICAL PROJECT STUDIES, NAMELY FEASIBILITY STUDIES FOR BUILDINGS, ROOF CONSTRUCTION AND STAIR CONSTRUCTION (U.S. CLS. 100 AND 101).

DAYNA BROWNE, EXAMINING ATTORNEY

SN 79-017,049. HERGETH, WILLIBALD, BERCHING-ERAS-BACH, FED REP GERMANY, FILED 5-26-2005.

TRANSpofix

OWNER OF INTERNATIONAL REGISTRATION 0866734 DATED 5-26-2005, EXPIRES 5-26-2015.

CLASS 6—METAL GOODS

FOR SMALL ITEMS OF METAL HARDWARE, NAMELY, SPRINGS AND NUTS; GOODS OF COMMON METAL INCLUDED IN THIS CLASS, NAMELY, METAL CRATES, CASINGS OF METAL, CONTAINERS AND PALLETS, NAMELY, BASKETS OF COMMON METALS, GENERAL PURPOSE METAL STORAGE BINS, GENERAL PURPOSE METAL STORAGE CONTAINERS, METAL BINS, METAL CONTAINERS FOR THE STORAGE AND TRANSPORTATION OF GOODS; INDUSTRIAL PACKAGING CONTAINERS OF METAL, METAL PALLETS; LOADING AND UNLOADING PALLETS OF METAL; STORAGE PALLETS OF METAL; FASTENING ELEMENTS FOR SECURING CARGO AND OBJECTS, NAMELY, BELTS OF METAL FOR HANDLING LOADS, CABLE CLAMPS OF METAL, CARGO SLINGS OF METAL CANTILEVERED BRACKETS OF METAL, FASTENERS, NAMELY, METAL BARS AND CHAINS, GIRDERS OF METAL, METAL BINDING STRIPS USED ON PACKAGING, METAL CABLE WIRE, METAL CHAINS, METAL CLAMPS, METAL CLOSURES FOR CONTAINERS, NON-ELECTRIC CABLES, SPACER BRACKETS OF METAL (U.S. CLS. 2, 12, 13, 14, 23, 25 AND 50).

CLASS 17—RUBBER GOODS

FOR NATURAL RUBBER; RAW OR SEMI-WORKED RUBBER; NATURAL RUBBER, NAMELY, GUTTA-PERCHA; ASBESTOS; AND MICA; GOODS MADE FROM THESE MATERIALS, NAMELY, COVERED RUBBER THREAD AND YARN NOT FOR TEXTILE USE, GENERAL PURPOSE SILICONE RUBBER SEALANT, INDUSTRIAL PACKAGING CONTAINERS OF RUBBER, PACKING PADDING OF RUBBER FOR SHIPPING CONTAINERS, PADDING MADE OF RUBBER FOR SHIPPING CONTAINERS, RUBBER BANDS FOR COMMERCIAL AND INDUSTRIAL USES, RUBBER BARS AND RODS, RUBBER CORDS AND LACES, RUBBER LIDS AND CAPS FOR INDUSTRIAL PACKAGING CONTAINERS, RUBBER PACKING FOR SHIPPING CONTAINERS, RUBBER PADDING FOR SHIPPING CONTAINERS, RUBBER SHEETS, RUBBER STOPPERS FOR INDUSTRIAL PACKAGING CONTAINERS, ACRYLIC RUBBER, ASBESTOS BOARDS, ASBESTOS CORDS AND STRINGS, ASBESTOS FELT, ASBESTOS PAPER, COVERED RUBBER THREAD AND YARN NOT FOR TEXTILE USE; GOODS OF PLASTIC AND THERMOPLASTIC, NAMELY, PACKING PADDING OF PLASTIC FOR SHIPPING CONTAINERS, PLASTIC FILM FOR INDUSTRIAL AND COMMERCIAL PACKING USE, PLASTIC PACKING FOR SHIPPING CONTAINERS, PLASTIC PADDING FOR SHIPPING CONTAINERS, PLASTIC RODS AND BARS, PLASTICS IN THE FORM OF SHEETS, FILMS, BLOCKS, RODS AND TUBES; PACKING, STOPPING, PADDING AND INSULATING MATERIALS, NAMELY, ADHESIVE PACKING TAPE FOR INDUSTRIAL OR COMMERCIAL USE, ADHESIVE TAPE FOR INDUSTRIAL OR COMMERCIAL PACKING USE, CELLULOSE ACETATE FILM USED AS AN INDUSTRIAL OR COMMERCIAL PACKING MATERIAL, CUSHIONING OF RUBBER AND CUSHIONING OF PLASTIC IN THE NATURE OF STUFFING, EXPANDED PLASTIC PELLETS FOR PACKAGING, LOW-DENSITY POLYURETHANE PACKAGING FOAM, MOLDABLE COMPOUNDS FOR USE IN JOINTING AND PACKING, MOLDED FOAM INSULATED CONTAINER PACKING FOR COMMERCIAL TRANSPORTATION, PACKING FOAM IN SHEET FORM, PACKING MATERIAL FOR FORMING SEALS, PACKING PADDING OF RUBBER FOR SHIPPING CONTAINERS, PLASTIC STUFFING FOR CARTONS AND BOXES, RUBBER PACKING FOR SHIPPING CONTAINERS, RUBBER PADDING FOR

SHIPPING CONTAINERS, STRAPPING TAPE, STUFFING OF PLASTIC, STUFFING OF RUBBER; FLEXIBLE PIPES, NOT OF METAL (U.S. CLS. 1, 5, 12, 13, 35 AND 50).

CLASS 19—NON-METALLIC BUILDING MATERIALS

FOR BUILDING SLABS, NAMELY, SLABS OF CEMENT, CONCRETE, CLAY, SLATE; BUILDING ELEMENTS, NAMELY, ATHLETIC FLOORING, PORTABLE FLOORS, RUBBER FLOOR TILES, RUBBER FLOORING, VENEER FOR FLOORS, FLOOR PANELS, FLOOR PATCHING MATERIALS, NAMELY, CONCRETE SEALERS, FLOORING UNDERLAYMENTS, FLOORING UNDERLAYMENT MADE OF CORK, FOOTING STONE, PLASTIC FLOORBOARDS, SYNTHETIC FLOORING MATERIALS OR WALL-CLADDINGS; COVERINGS, NAMELY NON-METAL ROOF COVERINGS, DRAINAGE CHANNELS, NAMELY TRENCH DRAINS, PLASTIC CONDUIT FOR DRAINAGE, SECONDARY MOISTURE DRAINAGE SYSTEM CONSISTING OF NON-METAL TROUGHS AND COLLECTION BOXES; THE AFORESAID GOODS IN PARTICULAR FOR GAMES AREAS, SPORTS FACILITIES AND RIDING GROUNDS; RIGID PIPES, NOT OF METAL; NON-METALLIC TRANSPORTABLE BUILDINGS; PREFABRICATED NON-METAL CABIN BUILDINGS; NON-METAL CLADDING FOR CONSTRUCTION AND BUILDING; PRE-FABRICATED NON-METAL HORSE STABLES; PRE-FABRICATED NON-METAL TRANSPORTABLE HORSE BOXES; TRANSPORTABLE BUILDINGS; OF PLASTIC, RUBBER, ASPHALT, PITCH AND BITUMEN, NAMELY, PRE-FABRICATED NON-METAL BUILDINGS; NON-METAL CLADDINGS FOR FLOORS AND WALLS (U.S. CLS. 1, 12, 33 AND 50).

CLASS 27—FLOOR COVERINGS

FOR CARPETS, RUGS, MATS AND MATTING, LINOLEUM FOR COVERING EXISTING FLOORS; NON-TEXTILE WALL HANGINGS; FLOOR COVERINGS; NON-TEXTILE WALL COVERINGS (U.S. CLS. 19, 20, 37, 42 AND 50).

INGRID C. EULIN, EXAMINING ATTORNEY

SN 79-017,648. WIELAND DENTAL + TECHNIK GMBH & CO. KG, FED REP GERMANY, FILED 7-8-2005.

ZIROX

THE MARK CONSISTS OF STANDARD CHARACTERS WITHOUT CLAIM TO ANY PARTICULAR FONT, STYLE, SIZE, OR COLOR.

PRIORITY DATE OF 1-20-2005 IS CLAIMED.
OWNER OF INTERNATIONAL REGISTRATION 0868208 DATED 7-8-2005, EXPIRES 7-8-2015.

CLASS 5—PHARMACEUTICALS

FOR MATERIALS FOR DENTAL PROSTHESIS, INCLUDED IN THIS CLASS, NAMELY, MATERIALS FOR CROWNS AND BRIDGES FOR DENTAL USE AND FOR ORAL PROPHYLAXIS; MATERIALS FOR FACING ARTIFICIAL TEETH AND TEETH PROSTHESIS, IN PARTICULAR METAL CERAMICS, DENTAL CERAMICS AND DENTAL RESTORATION COMPOUNDS OF PLASTIC; DENTAL RESTORATION COMPOUNDS OF METAL, PRECIOUS METALS AND DENTAL ALLOYS THEREOF AS WELL AS CERAMIC MASSES AND PLASTICS FOR DENTAL RESTORATION USE; DENTAL FILLERS FOR TEETH, DENTAL FILLING MATERIALS, MATERIALS FOR SEALING TEETH AND VENEERING MATERIALS FOR DENTAL USE, COMPOSITE MATERIALS FOR MODEL PREPARATION AND MODEL PROCESSING COMPOSITE MATERIALS FOR DENTAL USE; MODELING MATERIALS, IN PARTICULAR WAXES FOR DENTAL USE; INVESTMENT MATERIALS, NAMELY, MATERIALS FOR REPAIRING DENTAL CROWNS BRIDGES, AND FIXING MATERIALS FOR DENTAL USE, NAMELY, MATERIALS FOR REPAIRING TEETH (U.S. CLS. 6, 18, 44, 46, 51 AND 52).

CLASS 10—MEDICAL APPARATUS

FOR DENTAL APPARATUS AND INSTRUMENTS FOR THE HANDLING, APPLICATION AND USE OF DENTAL CERAMIC MASSES, NAMELY, PROSTHETIC INSTRUMENTS FOR DENTAL PURPOSES, AND DENTAL IMPLANTS; ARTIFICIAL TEETH, DENTURES, DENTAL CROWNS, DENTAL BRIDGES (U.S. CLS. 26, 39 AND 44).

ANDREA K. NADELMAN, EXAMINING ATTORNEY

SN 79-017,687. COMMEND LEASING GMBH, AUSTRIA, FILED 9-23-2005.

AUDIOCOM

THE MARK CONSISTS OF STANDARD CHARACTERS WITHOUT CLAIM TO ANY PARTICULAR FONT, STYLE, SIZE, OR COLOR.

OWNER OF INTERNATIONAL REGISTRATION 0868325 DATED 9-23-2005, EXPIRES 9-23-2015.

CLASS 9—ELECTRICAL AND SCIENTIFIC APPARATUS

FOR APPARATUS FOR RECORDING, TRANSMISSION OR REPRODUCTION OF SOUND OR IMAGES (U.S. CLS. 21, 23, 26, 36 AND 38).

CLASS 38—COMMUNICATION

FOR DIGITAL TRANSMISSION OF SPEECH, IMAGES, AND DATA ON A UNIFORM DIGITAL SYSTEM (U.S. CLS. 100, 101 AND 104).

DEBRA LEE, EXAMINING ATTORNEY

SN 79-017,766. 3U TELECOM AG, FED REP GERMANY, FILED 11-3-2005.

3U TELECOM



PRIORITY DATE OF 5-11-2005 IS CLAIMED.
OWNER OF INTERNATIONAL REGISTRATION 0868558 DATED 11-3-2005, EXPIRES 11-3-2015.
NO CLAIM IS MADE TO THE EXCLUSIVE RIGHT TO USE "TELECOM", APART FROM THE MARK AS SHOWN.

CLASS 36—INSURANCE AND FINANCIAL

FOR ARRANGING FINANCIAL INVESTMENTS IN THE INFORMATION TECHNOLOGY AND TELECOMMUNICATIONS SECTOR (U.S. CLS. 100, 101 AND 102).

CLASS 38—COMMUNICATION

FOR TELECOMMUNICATION SERVICES, IN PARTICULAR OPERATING TELECOMMUNICATIONS SYSTEMS EQUIPMENT AND NETWORKS AT HOME AND ABROAD, FOR OTHERS (U.S. CLS. 100, 101 AND 104).

CLASS 42—SCIENTIFIC, COMPUTER AND LEGAL SERVICES

FOR TECHNICAL CONSULTANCY AND TECHNICAL SUPPORT SERVICES, NAMELY, MONITORING OF NETWORK SYSTEMS, SUPPORT OF NETWORK SYSTEMS, NETWORK TROUBLESHOOTING, AND CUSTOMER CARE SERVICES IN THE INFORMATION TECHNOLOGY AND TELECOMMUNICATIONS SECTOR; LICENSING OF INTELLECTUAL PROPERTY IN THE INFORMATION AND TELECOMMUNICATIONS SECTOR; PRODUCT RESEARCH AND DEVELOPMENT, NAMELY, DEVELOPMENT OF TELECOMMUNICATIONS SERVICES (U.S. CLS. 100 AND 101).

RICHARD WHITE, EXAMINING ATTORNEY

SN 79-017,863. JENS LAUGESSEN, UNITED KINGDOM, FILED 10-6-2004.

JENS LAUGESSEN

THE MARK CONSISTS OF STANDARD CHARACTERS WITHOUT CLAIM TO ANY PARTICULAR FONT, STYLE, SIZE, OR COLOR.

OWNER OF INTERNATIONAL REGISTRATION 0868812 DATED 10-6-2004, EXPIRES 10-6-2014.

CLASS 3—COSMETICS AND CLEANING PREPARATIONS

FOR SOAPS; PERFUMES; NON-MEDICATED TOILET PREPARATIONS, NAMELY, TOILET SOAP, TOILET WATER; ESSENTIAL OILS; COSMETICS; PREPARATIONS FOR HAIR CARE AND SCALP CARE; SHAMPOOS; SALTS, OILS, LOTIONS, GELS, ALL BEING NON-MEDICATED PREPARATIONS FOR THE BATH; CREAMS AND LOTIONS, ALL FOR THE CARE OF THE SKIN AND THE BODY; COLOGNES; PRE-SHAVE AND AFTER-SHAVE PREPARATIONS, NAMELY, PRE-SHAVE AND AFTER-SHAVE GELS AND CREAMS; DEODORANTS FOR PERSONAL USE; BODY POWDERS; COSMETIC SUN-TANNING AND SUN-SCREENING PREPARATIONS (U.S. CLS. 1, 4, 6, 50, 51 AND 52).

CLASS 9—ELECTRICAL AND SCIENTIFIC APPARATUS

FOR SPECTACLES AND REPLACEMENT AND COMPONENT PARTS THEREFORE; SUNGLASSES AND REPLACEMENT AND COMPONENT PARTS THEREFORE; SPECTACLE AND SUNGLASS FRAMES; SPECTACLE AND SUNGLASS FRAMES PARTS AND FITTINGS INCLUDED IN THIS CLASS FOR ALL OF THE AFORESAID GOODS, NAMELY, SUNGLASS AND SPECTACLE LENSES, SUNGLASS AND SPECTACLE CHAINS, SUNGLASS AND SPECTACLE STRAPS, AND SUNGLASS AND SPECTACLE CASES (U.S. CLS. 21, 23, 26, 36 AND 38).

CLASS 14—JEWELRY

FOR BADGES OF PRECIOUS METAL; BELT BUCKLES OF PRECIOUS METAL FOR CLOTHING; BRACELETS; BROOCHES; CANDLE HOLDERS OF PRECIOUS METAL; CANDLE RINGS OF PRECIOUS METAL; CIGAR AND CIGARETTE BOXES OF PRECIOUS METAL; CIGARETTE LIGHTERS OF PRECIOUS METAL; CLOCKS; CUFF-LINKS; CUT DIAMONDS; EARRINGS; FIGURES OF PRECIOUS METAL; FIGURINES OF PRECIOUS METAL; FLOWER BOWLS OF PRECIOUS METAL; HOROLOGICAL AND CHRONOMETRIC INSTRUMENTS AND PARTS THEREOF; JEWELLERY; IMITATION JEWELLERY; JEWELLERY BOXES OF PRECIOUS METAL; JEWELLERY CASES OF PRECIOUS METAL; JEWELLERY CASKETS OF PRECIOUS METAL; KEY RINGS OF PRECIOUS METAL; NECKLACES; ORNAMENTAL PINS; RINGS BEING JEWELLERY; SHIRT STUDS; TIE BARS; TIE CLIPS; TIE FASTENERS; TIE PINS; TIE TACKS; WATCH BOXES; WATCH BRACELETS; WATCH CASES; WATCHES; WEDDING BANDS (U.S. CLS. 2, 27, 28 AND 50).

CLASS 18—LEATHER GOODS

FOR ARTICLES MADE WHOLLY OR PRINCIPALLY OF LEATHER OR OF IMITATION LEATHER, NAMELY, COSMETIC BAGS SOLD EMPTY, COSMETIC CASES SOLD EMPTY, HUNTING BAGS, HUNTING CROPS, KEY CASES, KEY CHAINS, LUGGAGE TAGS, SADDLERY; TRUNKS AND TRAVELLING BAGS; LUGGAGE; HANDBAGS, KEY CASES, WALLETS, PURSES, BRIEF-CASES; LEATHER SHOULDER BELTS; LUGGAGE, NAMELY, CARRIERS FOR SUITS AND DRESSES; ATTACHÉ CASES; CREDIT CARD HOLDERS MADE OF LEATHER; UMBRELLAS, PARASOLS; HOLDALLS FOR CLOTHING (U.S. CLS. 1, 2, 3, 22 AND 41).

CLASS 25—CLOTHING

FOR CLOTHING, NAMELY, SHIRTS, T-SHIRTS, UNDER SHIRTS, NIGHT SHIRTS, RUGBY SHIRTS, POLO SHIRTS, CARDIGANS, JERSEYS, UNIFORMS, PANTS, TROUSERS, SLACKS, JEANS, DENIM JEANS, CULOTTES, CARGO PANTS, OVERALLS, COVERALLS, JUMPERS, JUMP SUITS, SHORTS, BOXER SHORTS, TOPS, CROP TOPS, TANK TOPS, HALTER TOPS, SWEAT SHIRTS, SWEAT SHORTS, SWEAT PANTS, WRAPS, WARM-UP SUITS, JOGGING SUITS, TRACK SUITS, PLAY SUITS, FORMAL SUITS, BLOUSES, SKIRTS, DRESSES, GOWNS, SWEATERS, VESTS, FLEECE VESTS, PULLOVERS, SNOW SUITS, PARKAS, CAPES, ANORAKS, PONCHOS, JACKETS, REVERSIBLE JACKETS, FLEECE JACKETS, COATS, TURTLENECKS, CLOTH SKI BIBS, BEACHWEAR, TENNIS WEAR, SURF WEAR, SKI WEAR, LAYETTES, INFANTWEAR, INFANT SLEEPERS, BOOTIES, BABY BIBS NOT OF PAPER, CLOTH DIAPERS, CAPS, SWIM CAPS, BERETS, BEANIES, HATS, VISORS, HEADBANDS, WRIST BANDS, SWEAT BANDS, HEADWEAR, EAR MUFFS, APRONS, SCARVES, BANDANAS, BELTS, SUSPENDERS, NECKWEAR, NECKERCHIEFS, ASCOTS, UNDERWEAR, THERMAL UNDERWEAR, LONG UNDERWEAR, BRIEFS, SWIM AND BATHING TRUNKS, BRAS,

SPORTS BRAS, BRASSIERES, BUSTIERS, CORSETS, PANTIES, THONGS, GARTERS AND GARTER BELTS, TEDDIES, GIRDLES, FOUNDATION GARMENTS, SINGLET, LOUNGEWEAR, ROBES, SMOCKS, UNDERCLOTHES, PYJAMAS, SLEEPWEAR, NIGHT GOWNS, LINGERIE, CAMISOLES, NEGLIGÉES, CHEMISES, CHEMISETTES, SLIPS, SARONGS, LEG WARMERS, PANTYHOSE, BODY STOCKINGS, KNEE HIGHS, LEGGINGS, TIGHTS, LEOTARDS, BODY SUITS, UNITARDS, BODY SHAPERS, GLOVES, MITTENS, RAINWEAR, SNEAKERS, BOOTS, GALOSHES, SANDALS, FLIP-FLOPS, AND SLIPPERS (U.S. CLS. 22 AND 39).

ERNEST SHOSHO, EXAMINING ATTORNEY

SN 79-018,153. SNOWCAVE PTY. LTD., AUSTRALIA, FILED 11-8-2005.

Do It EVERY TIME

PRIORITY DATE OF 5-20-2005 IS CLAIMED.
OWNER OF INTERNATIONAL REGISTRATION 0869503
DATED 11-8-2005, EXPIRES 11-8-2015.

CLASS 16—PAPER GOODS AND PRINTED MATTER

FOR WRITING PAPER; CARDBOARD AND GOODS MADE FROM THESE MATERIALS, NAMELY GREETING CARDS; PHOTOGRAPHS; STATIONERY; ADHESIVES FOR STATIONERY OR HOUSEHOLD PURPOSES; PRINTED INSTRUCTIONAL AND TEACHING MATERIALS IN THE FIELDS OF DIET, MOTIVATION AND LIFESTYLE; PLASTIC MATERIALS FOR PACKAGING, NAMELY, PLASTIC BAGS AND PLASTIC BUBBLE PACKS (U.S. CLS. 2, 5, 22, 23, 29, 37, 38 AND 50).

CLASS 18—LEATHER GOODS

FOR LEATHER AND IMITATION LEATHER, AND GOODS MADE OF THESE MATERIALS, NAMELY BACK PACKS, SPORTS BAGS; TRUNKS AND TRAVELLING BAGS; UMBRELLAS, PARASOLS AND WALKING STICKS (U.S. CLS. 1, 2, 3, 22 AND 41).

CLASS 20—FURNITURE AND ARTICLES NOT OTHERWISE CLASSIFIED

FOR FURNITURE, MIRRORS, PICTURE FRAMES NOT OF PRECIOUS METAL; GOODS OF WOOD, CORK, REED, CANE, WICKER, HORN, BONE, SHELL, AMBER OR PLASTIC, NAMELY STATUETTES AND FIGURINES (U.S. CLS. 2, 13, 22, 25, 32 AND 50).

CLASS 21—HOUSEWARES AND GLASS

FOR CONTAINERS FOR HOUSEHOLD OR KITCHEN USE; HOUSEHOLD AND KITCHEN UTENSILS, NAMELY SPATULAS; BEVERAGE GLASSWARE; PORCELAIN AND EARTHENWARE IN THE NATURE OF CROCKERY, NAMELY DISHES, PLATES, BOWLS AND MUGS (U.S. CLS. 2, 13, 23, 29, 30, 33, 40 AND 50).

CLASS 22—CORDAGE AND FIBERS

FOR SACKS AND BAGS, NAMELY LAUNDRY BAGS, CLOTH BAGS FOR STORAGE AND SHOE BAGS FOR STORAGE (U.S. CLS. 1, 2, 7, 19, 22, 42 AND 50).

CLASS 25—CLOTHING

FOR CLOTHING, NAMELY SHIRTS, T-SHIRTS, POLO SHIRTS, SWEAT SHIRTS, PANTS, TRACK SUITS, DRESSES, APRONS; FOOTWEAR AND HEADWEAR (U.S. CLS. 22 AND 39).

SN 79-018,161. SIEMENS AKTIENGESELLSCHAFT, 80333 MÜNCHEN, FED REP GERMANY, FILED 7-20-2005.

SIPROC

CLASS 28—TOYS AND SPORTING GOODS

FOR GAMES AND PLAYTHINGS, NAMELY PLAYING CARDS, BOARD GAMES, BALLS, STUFFED ANIMALS; GYMNASIAC AND SPORTING ARTICLES, NAMELY HAND HELD WEIGHTS, SKIPPING ROPES (U.S. CLS. 22, 23, 38 AND 50).

THE MARK CONSISTS OF STANDARD CHARACTERS WITHOUT CLAIM TO ANY PARTICULAR FONT, STYLE, SIZE, OR COLOR.

PRIORITY DATE OF 1-31-2005 IS CLAIMED.

OWNER OF INTERNATIONAL REGISTRATION 0869543 DATED 7-20-2005, EXPIRES 7-20-2015.

CLASS 29—MEATS AND PROCESSED FOODS

FOR MEAT, FISH NOT LIVE, POULTRY AND GAME; MEAT EXTRACTS, PRESERVED, DRIED AND COOKED FRUITS AND VEGETABLES; JELLIES, JAMS, APPLE SAUCE AND CRANBERRY SAUCE; EGGS, MILK AND MILK PRODUCTS NAMELY YOGURT, CHEESE, CREAM CHEESE, CREAM; EDIBLE OILS AND FATS (U.S. CL. 46).

CLASS 9—ELECTRICAL AND SCIENTIFIC APPARATUS

FOR COMPUTER HARDWARE FOR USE IN MANUFACTURING; COMPUTER HARDWARE AND INTEGRATED SOFTWARE FOR MACHINE TO MACHINE COMMUNICATION (U.S. CLS. 21, 23, 26, 36 AND 38).

CLASS 30—STAPLE FOODS

FOR COFFEE, TEA, COCOA, SUGAR, RICE, TAPIOCA, SAGO, ARTIFICIAL COFFEE; FLOUR AND PREPARATIONS MADE FROM CEREALS, NAMELY, CEREAL BASE SNACK FOODS, BREAD, PASTRY AND CONFECTIONERY, NAMELY CANDY, FRUIT ICES, HONEY, TREACLE; YEAST, BAKING POWDER; SALT, MUSTARD; VINEGAR, SAUCES IN THE NATURE OF CONDIMENTS, NAMELY SALAD DRESSING AND MARINADES, KETCHUP; SPICES; ICE; FRUIT SAUCES EXCEPT APPLE SAUCE AND CRANBERRY SAUCE (U.S. CL. 46).

CLASS 38—COMMUNICATION

FOR WIRELESS EXCHANGE OF DATA BETWEEN COMPUTER HARDWARE AND COMPUTERS, MACHINES, TECHNICAL EQUIPMENT AND TRANSPORTATION VEHICLES; WIRELESS ELECTRONIC TRANSMISSION OF DATA (U.S. CLS. 100, 101 AND 104).

CLASS 31—NATURAL AGRICULTURAL PRODUCTS

FOR UNPROCESSED GRAINS; FRESH FRUITS AND FRESH VEGETABLES; FLOWER, FRUIT, PLANT AND GRASS SEEDS; MALT FOR BREWING AND DISTILLING (U.S. CLS. 1 AND 46).

CLASS 42—SCIENTIFIC, COMPUTER AND LEGAL SERVICES

FOR DEVELOPMENT OF COMPUTER DATA PROCESSING PROGRAMS FOR OTHERS (U.S. CLS. 100 AND 101).

SUSAN BILLHEIMER, EXAMINING ATTORNEY

CLASS 32—LIGHT BEVERAGES

FOR BEERS; MINERAL AND AERATED WATERS AND SOFT DRINKS; FRUIT DRINKS AND FRUIT JUICES; SYRUPS AND OTHER PREPARATIONS FOR MAKING SOFT DRINKS (U.S. CLS. 45, 46 AND 48).

SN 79-018,169. DR. KURT WOLFF GMBH & CO. KG, FED REP GERMANY, FILED 9-28-2005.

**CLASS 41—EDUCATION AND ENTERTAINMENT**

FOR EDUCATIONAL SERVICES, NAMELY COURSES, CLASSES, SEMINARS IN THE FIELDS OF DIET, MOTIVATION AND LIFESTYLE; PROVIDING TRAINING IN THE FIELDS OF PROPER NUTRITION AND MAINTAINING A HEALTHY LIFESTYLE; ENTERTAINMENT SERVICES, NAMELY ORGANIZING SPORTING AND CULTURAL EVENTS (U.S. CLS. 100, 101 AND 107).

RICHARD A. STRASER, EXAMINING ATTORNEY

OWNER OF INTERNATIONAL REGISTRATION 0869565 DATED 9-28-2005, EXPIRES 9-28-2015.

OWNER OF U.S. REG. NO. 1,083,767.

THE COLOR(S) RED AND WHITE IS/ARE CLAIMED AS A FEATURE OF THE MARK.

THE MARK CONSISTS OF WHITE LETTERS IN A RED DESIGN.

CLASS 3—COSMETICS AND CLEANING PREPARATIONS

FOR PERFUMERY, COSMETICS, TOILET SOAP, NON-MEDICAL HAIR CARE PREPARATIONS AND NON-MEDICAL HAIR TONIC (U.S. CLS. 1, 4, 6, 50, 51 AND 52).

CLASS 5—PHARMACEUTICALS

FOR MEDICAL HAIR CARE PREPARATIONS AND MEDICAL HAIR TONIC (U.S. CLS. 6, 18, 44, 46, 51 AND 52).

KRISTINA KLOIBER, EXAMINING ATTORNEY

SN 79-018,734. MARCOSERUSSI, FRANCE, FILED 9-6-2005.



PRIORITY DATE OF 3-9-2005 IS CLAIMED.
OWNER OF INTERNATIONAL REGISTRATION 0870840 DATED 9-6-2005, EXPIRES 9-6-2015.

NO CLAIM IS MADE TO THE EXCLUSIVE RIGHT TO USE "CAMICIA" IN CLASS 025, APART FROM THE MARK AS SHOWN.

CLASS 3—COSMETICS AND CLEANING PREPARATIONS

FOR SOAPS; PERFUMERY GOODS, NAMELY PERFUME, PERFUMED CREAMS, PERFUMED POWDERS; ESSENTIAL OILS; COSMETICS, HAIR LOTIONS, DENTIFRICES (U.S. CLS. 1, 4, 6, 50, 51 AND 52).

CLASS 18—LEATHER GOODS

FOR TRAVELLING BAGS, GARMENT BAGS FOR TRAVEL, TRUNKS, VALISES, LUGGAGE, UNFITTED VANITY CASES SOLD EMPTY, RUCKSACKS, HANDBAGS, BEACH BAGS, SHOPPING BAGS OF TEXTILE, LEATHER AND MESH, SHOULDER BAGS, WALLETS AND PURSES NOT OF PRECIOUS METAL, KEY CASES, BUSINESS CARD CASES; UMBRELLAS, PARASOLS, PERSONAL SUNSHADES, WALKING-STICKS AND WALKING-STICK SEATS (U.S. CLS. 1, 2, 3, 22 AND 41).

CLASS 25—CLOTHING

FOR CLOTHING, NAMELY, BRAS, BODY SUITS, SUSPENDERS, BASQUES, CORSETS, BRIEFS, G-STRINGS, BIKINIS, SHORTS, CAMISOLES, STOCKINGS, PANTYHOSE, SOCKS, GOWNS, SLIPS, CHEMISES, PAJAMAS, ROBES, BATHING SUITS, PAREOS, SKIRTS, DRESSES, SARONGS, SHIRTS, TOPS, PANTS, BLOUSES, BELTS, SCARVES, UNDERGARMENTS, FOOTWEAR EXCEPT ORTHOPEDIC FOOTWEAR AND FOOTWEAR FOR PROTECTION AGAINST IRRADIATION, FIRE OR ACCIDENTS, AND HEADGEAR (U.S. CLS. 22 AND 39).

MARIA-VICTORIA SUAREZ, EXAMINING ATTORNEY

SN 79-019,288. KEESING REFERENCE SYSTEMS B.V., NETHERLANDS, FILED 1-14-2005.

KEESING DOCUMENTSCAN

THE MARK CONSISTS OF STANDARD CHARACTERS WITHOUT CLAIM TO ANY PARTICULAR FONT, STYLE, SIZE, OR COLOR.

PRIORITY DATE OF 1-13-2005 IS CLAIMED.

OWNER OF INTERNATIONAL REGISTRATION 0872400 DATED 1-14-2005, EXPIRES 1-14-2015.

NO CLAIM IS MADE TO THE EXCLUSIVE RIGHT TO USE "DOCUMENT SCAN", APART FROM THE MARK AS SHOWN.

CLASS 35—ADVERTISING AND BUSINESS

FOR DATA PROCESSING SERVICES, NAMELY, SETTING UP DATA FILES AND MANAGING DATA FILES (U.S. CLS. 100, 101 AND 102).

CLASS 38—COMMUNICATION

FOR PROVISION OF ACCESS TO DATA OR DOCUMENTS STORED ELECTRONICALLY IN CENTRAL FILES FOR REMOTE CONSULTATION, NAMELY, PROVISION OF ACCESS TO ELECTRONICALLY STORED DATA FILES REGARDING THE VERIFICATION, IDENTIFICATION AND APPLICATION OF SECURITY MARKS IN OFFICIAL DOCUMENTS AND PRODUCTS, SUCH AS SECURITIES, PAPER CURRENCY, PASSPORTS AND OTHER TRAVEL DOCUMENTS AND PERSONAL IDENTITY DOCUMENTS (U.S. CLS. 100, 101 AND 104).

CLASS 42—SCIENTIFIC, COMPUTER AND LEGAL SERVICES

FOR INSPECTION SERVICES, NAMELY INSPECTIONS OF SECURITY MARKS IN OFFICIAL DOCUMENTS AND PRODUCTS SUCH AS SECURITIES, PAPER CURRENCY, PASSPORTS AND OTHER TRAVEL DOCUMENTS AND PERSONAL IDENTITY DOCUMENTS; QUALITY CONTROL FOR OTHERS; CONSULTATION AND INFORMATION REGARDING THE VERIFICATION, IDENTIFICATION AND APPLICATION OF SECURITY MARKS IN OFFICIAL DOCUMENTS AND PRODUCTS, SUCH AS SECURITIES, PAPER CURRENCY, PASSPORTS AND OTHER TRAVEL DOCUMENTS AND PERSONAL IDENTIFY DOCUMENTS (U.S. CLS. 100 AND 101).

ROBERT LAVACHE, EXAMINING ATTORNEY

SN 79-019,377. BEHR GMBH & CO. KG, 70469 STUTTGART, FED REP GERMANY, FILED 7-5-2004.

Flexiblock

THE MARK CONSISTS OF STANDARD CHARACTERS WITHOUT CLAIM TO ANY PARTICULAR FONT, STYLE, SIZE, OR COLOR.

PRIORITY DATE OF 2-11-2004 IS CLAIMED.

OWNER OF INTERNATIONAL REGISTRATION 0872628 DATED 7-5-2004, EXPIRES 7-5-2014.

CLASS 7—MACHINERY

FOR COOLING SYSTEMS FOR MOTOR VEHICLE COMBUSTION ENGINES AND THEIR PARTS AND COMPONENTS COMPRISED OF RADIATORS, REFRIGERANT CONDENSERS, CHARGE AIR COOLERS, OIL COOLERS, ELECTRONIC COOLERS TO BE USED IN VEHICLE ENGINES, BATTERY COOLERS, FUEL COOLERS, POWER STEERING OIL COOLERS, LOW TEMPERATURE COOLERS, BLOWERS, FANS AND FAN SHROUDS, FAN DRIVES, AND EXHAUST-GAS HEAT EXCHANGERS, EXHAUST-GAS RECIRCULATIONS, COOLANT PUMPS, HEAT EXCHANGERS, COOLANT PUMPS AND COOLANT COMPRESSORS; REFRIGERANT CONDENSERS (U.S. CLS. 13, 19, 21, 23, 31, 34 AND 35).

CLASS 37—CONSTRUCTION AND REPAIR

FOR MAINTENANCE AND REPAIR OF THE FOLLOWING GOODS, COOLING SYSTEMS FOR MOTOR VEHICLE COMBUSTION ENGINES AND ALTERNATIVE DRIVES AND THEIR PARTS AND COMPONENTS NAMELY, RADIATORS, REFRIGERANT CONDENSERS, CHARGE AIR COOLERS, OIL COOLERS, ELECTRONIC COOLERS, BATTERY COOLERS, FUEL COOLERS, POWER STEERING OIL COOLERS, LOW TEMPERATURE COOLERS, BLOWERS, FANS AND FAN SHROUDS, FAN DRIVES, AND EXHAUST-GAS HEAT EXCHANGERS, EXHAUST-GAS RECIRCULATIONS, COOLANT PUMPS, HEAT EXCHANGERS, COOLANT PUMPS AND COOLANT COMPRESSORS AND REFRIGERANT CONDENSERS (U.S. CLS. 100, 103 AND 106).

DAVID STERKIN, EXAMINING ATTORNEY

SN 79-019,713. HITACHI-OMRON TERMINAL SOLUTIONS, CORPORATION, JAPAN, FILED 9-21-2004.



The logo for Leadus features the word "Leadus" in a bold, italicized, sans-serif font. A thick, black, curved line sweeps underneath the letters, starting from the left and ending under the 's'.

PRIORITY DATE OF 9-16-2004 IS CLAIMED.
OWNER OF INTERNATIONAL REGISTRATION 0873548
DATED 9-21-2004, EXPIRES 9-21-2014.

CLASS 9—ELECTRICAL AND SCIENTIFIC APPARATUS

FOR CARD READERS FOR ATMS, CASH DISPENSERS, KIOSKS, VENDING MACHINES, POINT OF SALE TERMINALS, CREDIT AUTHORIZATION TERMINALS, ELECTRONIC PAYMENT TERMINALS, ELECTRONIC PARKING SYSTEM MACHINES, ELECTRONIC CAR WASH MACHINES, ELECTRONIC RAILWAY TICKET MACHINE, ELECTRONIC AIRPORT CHECK-IN MACHINES, ELECTRONIC ACCESS CONTROL MACHINES, ELECTRONIC HOTEL KEYS AND LOCK MECHANISMS, ELECTRONIC GAME MACHINES, AND CARD ENCODERS; PROCEEDS ACCEPTORS, NAMELY, AUTOMATED PAPER MONEY SORTING MACHINES; ELECTRONIC MACHINES, APPARATUS AND THEIR PARTS FOR HANDLING THE PROCEEDS, NAMELY AUTOMATED PAPER MONEY SORTING MACHINES AND THEIR PARTS; BILL/COIN HANDLING MODULES, NAMELY, COIN COUNTING OR SORTING MACHINES; MODULES FOR HANDLING MONEY, NAMELY, STRUCTURAL PARTS OF AUTOMATED TELLER MACHINES; MONEY CHANGING MACHINES; ELECTRONIC PASSBOOK/CERTIFICATE ISSUING MACHINES; AUTOMATED TELLER MACHINES; SELF-SERVICE CERTIFICATE ISSUING MACHINES, NAMELY, ELECTRONIC TICKET CANCELING MACHINES; PRINTERS; PRINTERS FOR USE WITH COMPUTERS; AUTOMATED CASH RECYCLING MODULES; COMPUTER SOFTWARE FOR OPERATING AUTOMATED TELLER MACHINES; COMPUTER SOFTWARE FOR CARD READERS FOR ATMS, CASH DISPENSERS, KIOSKS, VENDING MACHINES, AND ELECTRONIC TERMINALS; COMPUTER SOFTWARE FOR MONEY SORTING MACHINES, ELECTRONIC TICKET MACHINES, COMPUTER PRINTERS, ELECTRONIC MAIL SORTERS AND SCANNERS; SCANNERS; COIN COUNTING OR SORTING MACHINES; AUTOMATED BILLING MACHINES; VENDING MACHINES; TELECOMMUNICATION MACHINES AND APPARATUS, NAMELY, MICROPHONES, VIDEO PHONES, TELEPHONES, VIDEO CAMERAS, TELEVISIONS, NETWORK HUBS, NETWORK ROUTERS, SOFTWARE FOR VIDEO CONFERENCING, FACSIMILES, INTERACTIVE VOICE RESPONSE UNITS, DATA TRANSCIEVERS, WIRELESS NETWORKS, AND GATEWAYS FOR COLLECTION

AND MANAGEMENT OF DATA; ELECTRONIC MACHINES, APPARATUS AND THEIR PARTS, NAMELY, BIOMETRICS APPARATUS, NAMELY, FINGER VEIN AUTHENTICATION DEVICES. (U.S. CLS. 21, 23, 26, 36 AND 38).

CLASS 37—CONSTRUCTION AND REPAIR

FOR REPAIR OR MAINTENANCE OF CARD READERS FOR ATMS, CASH DISPENSERS, KIOSKS, VENDING MACHINES, AND ELECTRONIC TERMINALS; REPAIR OR MAINTENANCE OF PROCEEDS ACCEPTORS; REPAIR OR MAINTENANCE OF ELECTRONIC MACHINES, APPARATUS AND THEIR PARTS FOR HANDLING PROCEEDS; REPAIR OR MAINTENANCE OF BILL/COIN HANDLING MODULES; REPAIR OR MAINTENANCE OF MODULES FOR HANDLING MONEY, NAMELY, PARTS OF AUTOMATED TELLER MACHINES; REPAIR OR MAINTENANCE OF MONEY CHANGING MACHINES; REPAIR OR MAINTENANCE OF ELECTRONIC MACHINES, APPARATUS AND THEIR PARTS; REPAIR OR MAINTENANCE OF TELECOMMUNICATION MACHINES AND APPARATUS; REPAIR OR MAINTENANCE OF BILL/COIN HANDLING MACHINES; REPAIR OR MAINTENANCE OF PASSBOOK/CERTIFICATE ISSUING MACHINES; REPAIR OR MAINTENANCE OF AUTOMATED TELLER MACHINES; REPAIR OR MAINTENANCE OF SELF-SERVICE CERTIFICATE ISSUING MACHINES; REPAIR OR MAINTENANCE OF PRINTERS; REPAIR OR MAINTENANCE OF PRINTERS FOR USE WITH COMPUTERS; REPAIR OR MAINTENANCE OF CASH RECYCLING MODULES; REPAIR OR MAINTENANCE OF SCANNERS; REPAIR OR MAINTENANCE OF ELECTRONIC MACHINES AND APPARATUS, NAMELY, BIOMETRICS APPARATUS, NAMELY, FINGER VEIN AUTHENTICATION DEVICES; REPAIR OR MAINTENANCE OF TELECOMMUNICATION MACHINES AND APPARATUS, NAMELY, MICROPHONES, VIDEO PHONES, TELEPHONES, VIDEO CAMERAS, TELEVISIONS, NETWORK HUBS, NETWORK ROUTERS, SOFTWARE FOR VIDEO CONFERENCING, FACSIMILES, INTERACTIVE VOICE RESPONSE UNITS, DATA TRANSCIEVERS, WIRELESS NETWORKS, AND GATEWAYS FOR COLLECTION AND MANAGEMENT OF DATA; REPAIR OR MAINTENANCE OF VENDING MACHINES. (U.S. CLS. 100, 103 AND 106).

CLASS 42—SCIENTIFIC, COMPUTER AND LEGAL SERVICES

FOR QUALITY CONTROL FOR OTHERS; RESEARCH AND DEVELOPMENT OF NEW PRODUCTS FOR OTHERS IN THE FIELDS OF AUTOMATED TELLER MACHINES AND FINANCIAL SYSTEMS; DEVELOPMENT OF COMPUTERS; DESIGNING OF COMPUTERS; COMPUTER SOFTWARE DESIGN, COMPUTER PROGRAMMING, OR MAINTENANCE OF COMPUTER SOFTWARE; TECHNICAL ADVICE RELATING TO PERFORMANCE, OPERATION OF COMPUTERS, AUTOMOBILES AND OTHER MACHINES THAT REQUIRE HIGH LEVELS OF PERSONAL KNOWLEDGE, SKILL OR EXPERIENCE OF THE OPERATORS TO MEET THE REQUIRED ACCURACY IN OPERATING THEM; DESIGNING IN THE FIELDS OF AUTOMATED TELLER MACHINES AND FINANCIAL SYSTEMS; DESIGNING OF MACHINES, APPARATUS, INSTRUMENTS, AND THEIR PARTS, OR SYSTEMS COMPOSED OF SUCH MACHINES, APPARATUS AND INSTRUMENTS; TESTING OR RESEARCH ON MACHINES, APPARATUS AND INSTRUMENTS IN THE FIELDS OF AUTOMATED TELLER MACHINES AND FINANCIAL SYSTEMS; RENTAL OF COMPUTERS; RENTAL OF COMPUTER PROGRAMS, NAMELY, PROVIDING COMPUTER PROGRAMS IN A COMMUNICATIONS NETWORK; REPAIR OR MAINTENANCE OF COMPUTER SOFTWARE. (U.S. CLS. 100 AND 101).

ROBIN CHOSID, EXAMINING ATTORNEY

SN 79-019,714. HITACHI-OMRON TERMINAL SOLUTIONS, CORPORATION, JAPAN, FILED 9-21-2004.

LEADUS

PRIORITY DATE OF 9-16-2004 IS CLAIMED.
OWNER OF INTERNATIONAL REGISTRATION 0873549
DATED 9-21-2004, EXPIRES 9-21-2014.

CLASS 9—ELECTRICAL AND SCIENTIFIC APPARATUS

FOR CARD READERS FOR ATMS, CASH DISPENSERS, KIOSKS, VENDING MACHINES, POINT OF SALE TERMINALS, CREDIT AUTHORIZATION TERMINALS, ELECTRONIC PAYMENT TERMINALS, ELECTRONIC PARKING SYSTEM MACHINES, ELECTRONIC CAR WASH MACHINES, ELECTRONIC RAILWAY TICKET MACHINE, ELECTRONIC AIRPORT CHECK-IN MACHINES, ELECTRONIC ACCESS CONTROL MACHINES, ELECTRONIC HOTEL KEYS AND LOCK MECHANISMS, ELECTRONIC GAME MACHINES, AND CARD ENCODERS; PROCEEDS ACCEPTORS, NAMELY, AUTOMATED PAPER MONEY SORTING MACHINES; ELECTRONIC MACHINES, APPARATUS AND THEIR PARTS FOR HANDLING THE PROCEEDS, NAMELY AUTOMATED PAPER MONEY SORTING MACHINES AND THEIR PARTS; BILL/COIN HANDLING MODULES, NAMELY, COIN COUNTING OR SORTING MACHINES; MODULES FOR HANDLING MONEY, NAMELY, STRUCTURAL PARTS OF AUTOMATED TELLER MACHINES; MONEY CHANGING MACHINES; ELECTRONIC PASSBOOK/CERTIFICATE ISSUING MACHINES; AUTOMATED TELLER MACHINES; SELF-SERVICE CERTIFICATE ISSUING MACHINES, NAMELY, ELECTRONIC TICKET CANCELING MACHINES; PRINTERS; PRINTERS FOR USE WITH COMPUTERS; AUTOMATED CASH RECYCLING MODULES; COMPUTER SOFTWARE FOR OPERATING AUTOMATED TELLER MACHINES; COMPUTER SOFTWARE FOR CARD READERS FOR ATMS, CASH DISPENSERS, KIOSKS, VENDING MACHINES, AND ELECTRONIC TERMINALS; COMPUTER SOFTWARE FOR MONEY SORTING MACHINES, ELECTRONIC TICKET MACHINES, COMPUTER PRINTERS, ELECTRONIC MAIL SORTERS AND SCANNERS; SCANNERS; COIN COUNTING OR SORTING MACHINES; AUTOMATED BILLING MACHINES; VENDING MACHINES; TELECOMMUNICATION MACHINES AND APPARATUS, NAMELY, MICROPHONES, VIDEO PHONES, TELEPHONES, VIDEO CAMERAS, TELEVISIONS, NETWORK HUBS, NETWORK ROUTERS, SOFTWARE FOR VIDEO CONFERENCING, FACSIMILES, INTERACTIVE VOICE RESPONSE UNITS, DATA TRANSCEIVERS, WIRELESS NETWORKS, AND GATEWAYS FOR COLLECTION AND MANAGEMENT OF DATA; ELECTRONIC MACHINES, APPARATUS AND THEIR PARTS, NAMELY, BIOMETRICS APPARATUS, NAMELY, FINGER VEIN AUTHENTICATION DEVICES (U.S. CLS. 21, 23, 26, 36 AND 38).

CLASS 37—CONSTRUCTION AND REPAIR

FOR REPAIR OR MAINTENANCE OF CARD READERS FOR ATMS, CASH DISPENSERS, KIOSKS, VENDING MACHINES, AND ELECTRONIC TERMINALS; REPAIR OR MAINTENANCE OF PROCEEDS ACCEPTORS; REPAIR OR MAINTENANCE OF ELECTRONIC MACHINES, APPARATUS AND THEIR PARTS FOR HANDLING PROCEEDS; REPAIR OR MAINTENANCE OF BILL/COIN HANDLING MODULES; REPAIR OR MAINTENANCE OF MODULES FOR HANDLING MONEY, NAMELY, PARTS OF AUTOMATED TELLER MACHINES; REPAIR OR MAINTENANCE OF MONEY CHANGING MACHINES; REPAIR OR MAINTENANCE OF ELECTRONIC MACHINES, APPARATUS AND THEIR PARTS; REPAIR OR MAINTENANCE OF TELECOMMUNICATION MACHINES AND APPARATUS; REPAIR OR MAINTENANCE OF BILL/COIN HANDLING MACHINES; REPAIR OR MAINTENANCE OF PASSBOOK/CERTIFICATE ISSUING MACHINES; REPAIR OR MAINTENANCE OF AUTOMATED TELLER MA-

CHINES; REPAIR OR MAINTENANCE OF SELF-SERVICE CERTIFICATE ISSUING MACHINES; REPAIR OR MAINTENANCE OF PRINTERS; REPAIR OR MAINTENANCE OF PRINTERS FOR USE WITH COMPUTERS; REPAIR OR MAINTENANCE OF CASH RECYCLING MODULES; REPAIR OR MAINTENANCE OF SCANNERS; REPAIR OR MAINTENANCE OF ELECTRONIC MACHINES AND APPARATUS, NAMELY, BIOMETRICS APPARATUS, NAMELY, FINGER VEIN AUTHENTICATION DEVICES; REPAIR OR MAINTENANCE OF TELECOMMUNICATION MACHINES AND APPARATUS, NAMELY, MICROPHONES, VIDEO PHONES, TELEPHONES, VIDEO CAMERAS, TELEVISIONS, NETWORK HUBS, NETWORK ROUTERS, SOFTWARE FOR VIDEO CONFERENCING, FACSIMILES, INTERACTIVE VOICE RESPONSE UNITS, DATA TRANSCEIVERS, WIRELESS NETWORKS, AND GATEWAYS FOR COLLECTION AND MANAGEMENT OF DATA; REPAIR OR MAINTENANCE OF VENDING MACHINES (U.S. CLS. 100, 103 AND 106).

CLASS 42—SCIENTIFIC, COMPUTER AND LEGAL SERVICES

FOR QUALITY CONTROL FOR OTHERS; RESEARCH AND DEVELOPMENT OF NEW PRODUCTS FOR OTHERS IN THE FIELDS OF AUTOMATED TELLER MACHINES AND FINANCIAL SYSTEMS; DEVELOPMENT OF COMPUTERS; DESIGNING OF COMPUTERS; COMPUTER SOFTWARE DESIGN, COMPUTER PROGRAMMING, OR MAINTENANCE OF COMPUTER SOFTWARE; TECHNICAL ADVICE RELATING TO PERFORMANCE, OPERATION OF COMPUTERS, AUTOMOBILES AND OTHER MACHINES THAT REQUIRE HIGH LEVELS OF PERSONAL KNOWLEDGE, SKILL OR EXPERIENCE OF THE OPERATORS TO MEET THE REQUIRED ACCURACY IN OPERATING THEM; DESIGNING IN THE FIELDS OF AUTOMATED TELLER MACHINES AND FINANCIAL SYSTEMS; DESIGNING OF MACHINES, APPARATUS, INSTRUMENTS, AND THEIR PARTS, OR SYSTEMS COMPOSED OF SUCH MACHINES, APPARATUS AND INSTRUMENTS; TESTING OR RESEARCH ON MACHINES, APPARATUS AND INSTRUMENTS IN THE FIELDS OF AUTOMATED TELLER MACHINES AND FINANCIAL SYSTEMS; RENTAL OF COMPUTERS; RENTAL OF COMPUTER PROGRAMS, NAMELY, PROVIDING COMPUTER PROGRAMS IN A COMMUNICATIONS NETWORK; REPAIR OR MAINTENANCE OF COMPUTER SOFTWARE (U.S. CLS. 100 AND 101).

ROBIN CHOSID, EXAMINING ATTORNEY

SN 79-019,840. MANIFATTURA DI LEGNANO S.P.A., ITALY, FILED 6-6-2005.



OWNER OF INTERNATIONAL REGISTRATION 0841490
DATED 9-9-2004, EXPIRES 9-9-2014.

NO CLAIM IS MADE TO THE EXCLUSIVE RIGHT TO USE "LEGNANO" AND "TINTI", APART FROM THE MARK AS SHOWN.

THE COLORS BLACK, VIOLET, ORANGE AND GREEN ARE CLAIMED AS A FEATURE OF THE MARK.

LEGNANO TINTI IS IN BLACK; THE WAVY LINES ARE, FROM LEFT TO RIGHT, ORANGE, GREEN, AND VIOLET. TINTI TRANSLATES INTO ENGLISH AS DYED.

CLASS 23—YARNS AND THREADS

FOR YARNS FOR TEXTILE USE (U.S. CL. 43).

CLASS 24—FABRICS

FOR TEXTILES AND TEXTILES PRODUCTS NOT INCLUDED IN OTHER CLASSES NAMELY FABRICS FOR THE MANUFACTURE OF CLOTHING AND FURNISHING, CURTAINS, PILLOW CASES, BED SHEETS, BED SPREADS, BED BLANKETS, COMFORTERS FOR BEDS, TABLE CLOTHS NOT OF PAPER, TEXTILE NAPKINS, TOWELS, TEXTILE PLACE MATS (U.S. CLS. 42 AND 50).

CLASS 25—CLOTHING

FOR CLOTHING, NAMELY COATS, MANTLES, RAINCOATS, DRESSES, SUITS, SKIRTS, JACKETS, TROUSERS, JEANS, WAISTCOATS, SHIRTS, T-SHIRTS, BLOUSES, JERSEYS, SWEATERS, BLAZERS, CARDIGANS, STOCKINGS, SOCKS, UNDERWEAR, CORSETS, NIGHT-GOWNS, PAJAMAS, BATHROBES, BATHING SUITS, SUN SUITS, SPORT JACKETS, WIND-RESISTANT JACKETS, ANORAKS, SWEATSUITS, TIES, NECKTIES, SCARVES, SHAWLS, FOULARDS, CAPS, HATS, GLOVES, SASHES, BELTS; FOOTWEAR NAMELY BOOTS, SHOES AND SLIPPERS (U.S. CLS. 22 AND 39).
PAUL E. FAHRENKOPF, EXAMINING ATTORNEY

SN 79-020,190. HENKEL KGAA, FED REP GERMANY, FILED 6-25-2005.

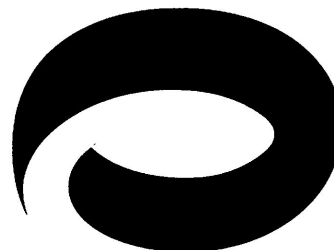

PRIORITY DATE OF 3-12-2005 IS CLAIMED.
OWNER OF INTERNATIONAL REGISTRATION 0874971
DATED 6-25-2005, EXPIRES 6-25-2015.

CLASS 1—CHEMICALS

FOR CHEMICALS FOR USE IN THE MANUFACTURE OF ADHESIVES AND SEALANTS, ADHESIVES OTHER THAN FOR STATIONERY OR HOUSEHOLD PURPOSES (U.S. CLS. 1, 5, 6, 10, 26 AND 46).

CLASS 16—PAPER GOODS AND PRINTED MATTER

FOR ADHESIVES FOR PAPER, STATIONERY, HOUSEHOLD AND DO-IT-YOURSELF PURPOSES (U.S. CLS. 2, 5, 22, 23, 29, 37, 38 AND 50).

CLASS 17—RUBBER GOODS

FOR STOPPING MATERIALS, NAMELY, ADHESIVE SEALANTS FOR GENERAL USE, SEALANTS FOR BUILDINGS (U.S. CLS. 1, 5, 12, 13, 35 AND 50).
MAUREEN DALL, EXAMINING ATTORNEY

SN 79-019,845. BROMMA PATENTER AB C/O CARGOTEC HOLDING SVERIGE AB, SWEDEN, FILED 7-25-2005.

CARGOTEC

OWNER OF INTERNATIONAL REGISTRATION 0850357
DATED 12-29-2004, EXPIRES 12-29-2014.

CLASS 12—VEHICLES

FOR MOTOR VEHICLES INCORPORATING LIFTING APPARATUS AND CRANES, NAMELY, PLATFORM TRUCKS, TRUCKS AND TRACTORS WITH MOUNTED WINCHES, HOISTS AND CRANES; FORK-LIFT TRUCKS; REPLACEABLE VEHICLE PLATFORMS FOR LOAD AND FREIGHT HANDLING, NAMELY, LOAD AND FREIGHT TRAILERS AND LOAD AND FREIGHT DEMOUNTABLE PLATFORMS; AUTOMOBILE CHASSIS (U.S. CLS. 19, 21, 23, 31, 35 AND 44).

CLASS 37—CONSTRUCTION AND REPAIR

FOR INSTALLATION, REPAIR AND MAINTENANCE OF MACHINES AND MACHINE TOOLS, MOTORS AND ENGINES, MACHINE BELTS AND COUPLINGS, LOADING AND LIFTING CRANES, HYDRAULIC LOADERS, LIFTING MACHINES AND APPARATUS, HAULING ENGINES AND APPARATUS, TRANSMISSION COMPONENTS, LOADERS FOR HARVESTERS, MOTOR VEHICLES, VEHICLES INCORPORATING LIFTING APPARATUS AND CRANES, FORK-LIFT TRUCKS, REPLACEABLE VEHICLE PLATFORMS, VEHICLE CHASSIS AND TRACTION VEHICLES (U.S. CLS. 100, 103 AND 106).
SUSAN BILLHEIMER, EXAMINING ATTORNEY

SN 79-020,192. HZPC HOLLAND B.V., NETHERLANDS, FILED 8-16-2005.

POMMONDE

THE MARK CONSISTS OF STANDARD CHARACTERS WITHOUT CLAIM TO ANY PARTICULAR FONT, STYLE, SIZE, OR COLOR.

PRIORITY DATE OF 7-8-2005 IS CLAIMED.
OWNER OF INTERNATIONAL REGISTRATION 0874976
DATED 8-16-2005, EXPIRES 8-16-2015.

CLASS 29—MEATS AND PROCESSED FOODS

FOR PROCESSED POTATOES, AND PRODUCTS MADE OF POTATOES, NAMELY MASHED POTATOES, FRIED POTATOES, POTATO CHIPS AND POTATO CRISPS (U.S. CL. 46).

CLASS 31—NATURAL AGRICULTURAL PRODUCTS

FOR AGRICULTURAL PRODUCTS, NAMELY UN-PROCESSED POTATOES (U.S. CLS. 1 AND 46).
DARRYL SPRUILL, EXAMINING ATTORNEY

SN 79-020,267. GREAT WAVES PTY LTD, AUSTRALIA,
FILED 2-21-2005.



OWNER OF INTERNATIONAL REGISTRATION 0875123
DATED 2-21-2005, EXPIRES 2-21-2015.

CLASS 25—CLOTHING

FOR CLOTHING, NAMELY HEADWEAR, BATHING SUITS, BATHING TRUNKS, BEACH WEAR, SWIMSUITS, CAPS, HEADWEAR, NAMELY, CAP PEAKS AND HATS, JACKETS, JERSEYS, JUMPERS, PANTS, SHIRTS, SINGLETS, SWEATERS, UNDERWEAR, WATERPROOF CLOTHING, NAMELY, WETSUITS, HEADWEAR, NAMELY, WIMPLES, SOCKS, VESTS, SWIM WEAR NAMELY, RASH VESTS FOR SURFING AND OTHER WATER SPORTS EXCLUDING SKI SAFETY VESTS (U.S. CLS. 22 AND 39).

CLASS 28—TOYS AND SPORTING GOODS

FOR SPORTING GOODS, NAMELY, SURFING EQUIPMENT, SURFING ACCESSORIES, AND SURFING FITTINGS, NAMELY, SURF FINS, SURFBOARD LEASHES AND SURFBOARD WAX; COVERS FOR SKIS; SNOWBOARDS; WAKEBOARDS; SAILBOARDS; BODYBOARDS; SURFBOARDS; BODYBOARDING ACCESSORIES, NAMELY, FINS AND RESTRAINT STRAPS; COVERS FOR SURFBOARDS AND BODYBOARDS; COMPONENT PARTS AND FITTINGS FOR SAILBOARDS, SURFBOARDS AND BODYBOARDS; WAX FOR SKIS AND SURFBOARDS; SURFBOARD DECK GRIP TAPES; SCUBA FLIPPERS; SURFBOARD LEASHES; BODYBOARD LEASHES; SAILBOARD ACCESSORIES, NAMELY FOOT RESTRAINTS, FOOT STRIPS, LEASHES AND MASTS; BAGS ESPECIALLY DESIGNED FOR SKIS AND SURFBOARDS; HARNESS FOR SAILBOARDS; LEG ROPES, NAMELY WATER SKI ROPES (U.S. CLS. 22, 23, 38 AND 50).

SOPHIA S. KIM, EXAMINING ATTORNEY

SN 79-020,346. REMEDENT, NAAMLOZE VENNOOTSCHAP,
B-9831 DEURLE, BELGIUM, FILED 9-6-2005.

MetaTray

THE MARK CONSISTS OF STANDARD CHARACTERS
WITHOUT CLAIM TO ANY PARTICULAR FONT, STYLE,
SIZE, OR COLOR.

PRIORITY DATE OF 3-23-2005 IS CLAIMED.
OWNER OF INTERNATIONAL REGISTRATION 0875307
DATED 9-6-2005, EXPIRES 9-6-2015.

CLASS 3—COSMETICS AND CLEANING PREPARATIONS

FOR TOOTHPASTE; TEETH CLEANING PREPARATIONS, DENTAL BRACES CLEANING PREPARATIONS AND DENTURE CLEANING PREPARATIONS; DENTAL BLEACHING GEL, WAX AND LIQUID; NON-MEDICATED MOUTHWASH AND RINSE (U.S. CLS. 1, 4, 6, 50, 51 AND 52).

CLASS 5—PHARMACEUTICALS

FOR MEDICATED MOUTH CARE AND TREATMENT PREPARATIONS, NAMELY, MOUTHWASH AND RINSE; TOOTH CEMENT, DENTAL IMPRESSION MATERIALS; MATERIALS FOR DENTAL FILLINGS AND FOR SEALING PURPOSES; MEDICATED MOUTH CARE AND TREATMENT PREPARATIONS, NAMELY, CLEANING AND BLEACHING PREPARATIONS USED FOR TEETH, DENTAL BRACES, DENTURES AND MEDICATED CHEWING GUM (U.S. CLS. 6, 18, 44, 46, 51 AND 52).

CLASS 10—MEDICAL APPARATUS

FOR TONGUE SCRAPERS; DENTAL APPARATUS, NAMELY, A KIT FOR BRIGHTENING TEETH INCLUDING FOAM STRIPS IMPREGNATED WITH TEETH WHITENING SOLUTION AND AN ELECTRICALLY POWERED MOUTHPIECE INCLUDING A HEATING ELEMENT, A CONNECTING CABLE AND A POWER SUPPLY INTO WHICH THE STRIPS ARE PLACED WHICH PULSES LIGHT INTO AND HEATS THE WHITENING FOAM STRIPS (U.S. CLS. 26, 39 AND 44).

KATHERINE STOIDES, EXAMINING ATTORNEY

SN 79-020,378. IFCO SYSTEMS GMBH, FED REP GERMANY, FILED 10-20-2004.

IFCO GREEN PLUS

THE MARK CONSISTS OF STANDARD CHARACTERS
WITHOUT CLAIM TO ANY PARTICULAR FONT, STYLE,
SIZE, OR COLOR.

PRIORITY DATE OF 4-22-2004 IS CLAIMED.

OWNER OF INTERNATIONAL REGISTRATION 0875402
DATED 10-20-2004, EXPIRES 10-20-2014.

OWNER OF U.S. REG. NO. 2,365,614.

NO CLAIM IS MADE TO THE EXCLUSIVE RIGHT TO
USE "GREEN", APART FROM THE MARK AS SHOWN.

CLASS 20—FURNITURE AND ARTICLES NOT OTHERWISE CLASSIFIED

FOR PACKAGING CONTAINERS AND CASES MADE OF PLASTIC FOR COMMERCIAL USE; IN PARTICULAR FOR TRANSPORTING FRUITS AND VEGETABLES (U.S. CLS. 2, 13, 22, 25, 32 AND 50).

CLASS 39—TRANSPORTATION AND STORAGE

FOR LEASING OF RETURNABLE PACKAGING AND RETURNABLE PACKAGING CONTAINERS (U.S. CLS. 100 AND 105).

SOPHIA S. KIM, EXAMINING ATTORNEY

SN 79-020,532. VOK DAMS GESELLSCHAFT FÜR KOMMUNIKATION MBH, FED REP GERMANY, FILED 11-4-2004.



OWNER OF INTERNATIONAL REGISTRATION 0875958 DATED 11-4-2004, EXPIRES 11-4-2014.

"THE NAME(S), PORTRAIT(S), AND/OR SIGNATURE(S) SHOWN IN THE MARK IDENTIFIES A PARTICULAR LIVING INDIVIDUAL, WHOSE CONSENT(S) TO REGISTER IS SUBMITTED".

THE COLOR(S) BLACK, WHITE AND RED IS/ARE CLAIMED AS A FEATURE OF THE MARK.

"THE MARK CONSISTS OF THE BACKGROUND OF THE MARK AND THE INTERIOR OF THE BLOCK MATRIX IN WHITE EXCEPT THAT THE LOWER LEFT BOX IN THE MATRIX IS RED. THE REMAINING ELEMENTS IN THE MARK ARE ALL BLACK".

CLASS 9—ELECTRICAL AND SCIENTIFIC APPARATUS

FOR MULTI-MEDIA PROGRAMS, NAMELY, EXPOSED OPTICAL DATA MEDIA, NAMELY, CD-ROMS, DVDS AND BLUE-RAY-DISKS, CONTAINING PRODUCT PRESENTATIONS, TRADE FAIR PERFORMANCES, VISUAL AND/OR MUSICAL PERFORMANCES, ENTERTAINMENT SHOWS, SOUND AND IMAGE SHOWS, COMPUTER ANIMATIONS, LIGHT AND LASER SHOWS, FOR USE BY DEALERS AND SALES REPRESENTATIVES FOR BUSINESS PRESENTATIONS AND SALES PROMOTIONS; SLIDES, POSITIVE TRANSPARENCIES, PRE-RECORDED AUDIO AND VIDEO TAPES AND VIDEO DISCS CONTAINING PRODUCT PRESENTATIONS, TRADE FAIR PERFORMANCES, VISUAL AND/OR MUSICAL PERFORMANCES, ENTERTAINMENT SHOWS, SOUND AND IMAGE SHOWS, COMPUTER ANIMATIONS, LIGHT AND LASER SHOWS, FOR USE BY DEALERS AND SALES REPRESENTATIVES FOR BUSINESS PRESENTATIONS AND SALES PROMOTIONS; MACHINE READABLE COMPUTER SOFTWARE CONTAINING TEXT, SOUND AND GRAPHICS FILES, AND VIDEO AND MUSIC CLIPS FOR USE IN TRAVEL AND GUEST MANAGEMENT; GRAPHIC PRESENTATIONS IN THE FIELD OF COMMUNICATIONS AND MARKETING. (U.S. CLS. 21, 23, 26, 36 AND 38).

CLASS 16—PAPER GOODS AND PRINTED MATTER

FOR WORKBOOKS DIRECTED TO THE FIELDS OF COMMUNICATION, ADVERTISING AND MARKETING; PRINTED MATTER, NAMELY, BOOKLETS AND FLYERS IN THE FIELD OF PRODUCT AND BUSINESS PRESENTATIONS, SALES PROMOTIONS; EXHIBITION EVENTS, ENTERTAINMENT SHOWS, TRADE FAIR PERFORMANCES, AND BUSINESS REPORTS. (U.S. CLS. 2, 5, 22, 23, 29, 37, 38 AND 50).

CLASS 35—ADVERTISING AND BUSINESS

FOR ORGANIZATION OF TRADE FAIRS TO INTRODUCE NEW PRODUCTS AND TO MOTIVATE AND ACTIVATE SELLING ON THE MARKET; DEVELOPMENT, ARRANGING AND PROVIDING SALES PROMOTION, FOR OTHERS; MARKETING CONSULTANCY, MARKETING STUDIES AND MARKET ANALYSIS; MANAGEMENT CONSULTING; ADVERTISING AND PUBLICITY SERVICES, NAMELY, PROMOTING THE GOODS, SERVICES, BRAND IDENTITY AND COMMERCIAL INFORMATION AND NEWS OF THIRD PARTIES THROUGH PRINT, AUDIO, VIDEO, DIGITAL AND ON-LINE MEDIA; ORGANIZING AND CONDUCTING OF EXHIBITIONS TO INTRODUCE NEW PRODUCTS; ARRANGING AND CONDUCTING OF EXHIBITIONS, IN PARTICULAR FOR PRODUCT PRESENTATIONS, DEALERS AND SALES REPRESENTATIVES; BUSINESS PRESENTATIONS, NAMELY, PREPARATION AND PRESENTATION OF BUSINESS PROSPECTUSES AND SALES PROMOTIONS; CONDUCTING EMPLOYEE INCENTIVE AWARD PROGRAMS FOR OTHERS TO PROMOTE INCREASED SALES; MARKET OPINION POLLING RELATING TO EXHIBITIONS, TRADE FAIRS OR SIMILAR EVENTS. (U.S. CLS. 100, 101 AND 102).

CLASS 39—TRANSPORTATION AND STORAGE

FOR ARRANGING TRAVEL TOURS AS A BONUS OR INCENTIVE PROGRAM FOR CUSTOMERS AND EMPLOYEES OF OTHERS. (U.S. CLS. 100 AND 105).

CLASS 41—EDUCATION AND ENTERTAINMENT

FOR PRODUCING, ARRANGING AND CONDUCTING OF ENTERTAINMENT SHOWS, SPECIAL EVENTS AND MULTI-MEDIA SHOWS, IN PARTICULAR TO OPTIMIZE SALES, PRODUCTS PRESENTATIONS, SALES PROMOTION AND FOR THE TRAINING OF DEALERS AND EMPLOYEES; CONSULTING FOR OTHERS ON SALES MOTIVATIONAL PROGRAMS; ARRANGING AND CONDUCTING WORKSHOPS AND PRACTICAL TRAINING FOR VENDORS AND DEALERS IN THE INSURANCE, AUTOMOBILE, BANKING, MEDIA, TELECOMMUNICATION AND PHARMACEUTICAL FIELDS; ARRANGING AND CONDUCTING OF MOTIVATION TRAINING PROGRAMS FOR EMPLOYEES AND COMPANIES; PRODUCTION AND PRESENTATION OF SOUND AND IMAGE SHOWS, MULTI VISION AND SLIDE SHOWS, MULTI-IMAGE PROGRAMS, VIDEO CLIPS, VIDEO DISC PROGRAMS, COMPUTER ANIMATIONS, LIGHT AND LASER SHOWS; ORGANIZATION AND CONDUCTING OF NEW FORMS OF INSTRUCTOR TRAINING AND SEMINARS FOR PRESENTERS AND PROJECT TEAMS; ARRANGING AND CONDUCTING OF EDUCATIONAL CONFERENCES AND SEMINARS REGARDING PRODUCT PRESENTATIONS, DEALERS AND SALES REPRESENTATIVES, BUSINESS PRESENTATIONS AND SALES PROMOTIONS; RENTAL OF PROJECTORS, STAGE AND AUDIO VISUAL EQUIPMENT, INCLUDING LIGHTING APPARATUS; ARRANGING AND CONDUCTING OF SALES COMPETITIONS. (U.S. CLS. 100, 101 AND 107).

CLASS 42—SCIENTIFIC, COMPUTER AND LEGAL SERVICES

FOR RESEARCH AND DEVELOPMENT IN THE FIELD OF HOLOGRAPHY FOR USE IN CONDUCTING ADVERTISING PROGRAMS TO PROJECT ADVERTISING MESSAGES. (U.S. CLS. 100 AND 101).

PAUL F. GAST, EXAMINING ATTORNEY

SN 79-020,554. COMFOOR B.V., DOETINCHEM, NETHERLANDS, FILED 11-9-2005.

COMFOOR

THE MARK CONSISTS OF STANDARD CHARACTERS WITHOUT CLAIM TO ANY PARTICULAR FONT, STYLE, SIZE, OR COLOR.

OWNER OF INTERNATIONAL REGISTRATION 0876020 DATED 11-9-2005, EXPIRES 11-9-2015.

CLASS 9—ELECTRICAL AND SCIENTIFIC APPARATUS

FOR PROTECTIVE EAR COVERINGS; AND EAR PLUGS NOT FOR MEDICAL PURPOSES (U.S. CLS. 21, 23, 26, 36 AND 38).

CLASS 10—MEDICAL APPARATUS

FOR HEARING AIDS; MEDICAL HEARING INSTRUMENT AND REPLACEMENT PARTS THEREFORE (U.S. CLS. 26, 39 AND 44).

MARC LEIPZIG, EXAMINING ATTORNEY

SN 79-021,157. LICHARZ GMBH TECHNISCHE KUNSTSTOFFE, FED REP GERMANY, FILED 11-29-2005.

OILAMID

OWNER OF INTERNATIONAL REGISTRATION 0877630 DATED 11-29-2005, EXPIRES 11-29-2015.

CLASS 7—MACHINERY

FOR PARTS MADE FROM RODS, PLATES AND TUBES MADE OF OIL CONTAINING POLYAMID, NAMELY CASTORS, GUIDE ROLLERS, SUPPORTING ROLLS, DIRECTING ROLLS, DIABOLO DISCS, CRANE CASTORS, ROPE PULLEYS, ROPE FEEDERS, ROPE DEFLECTION SHEAVES, WIRE GUIDE ROLLERS, CONVEYOR CASTORS, LATCH CHAIN ROLLERS, BANDAGES FOR ROLLERS, DEFLECTION SHEAVES, TAKE-OFF ROLLS, SMOOTHING ROLLS, PRESSURE ROLLS, BELT DISCS, DRIVEN ROLLS, IN-FEED-DISCS, GEAR WHEELS, TOOTHED RACKS; BEVEL WHEELS, SPIRAL GEARS, SPROCKET WHEELS, METERING DISCS, BOTTLE FEED TABLES, BEARING BUSHES, BUSHINGS, PEDESTALS, BEARING SEGMENTS, SLIDER STONES, GUIDE RAILS, SLIDER PADS, GUIDE STRIPS, PROTECTIVE STRIPS, CONVEYING SCREWS, CURVED DISCS, FEEDERS, CENTERING RINGS, SUPPORTING RINGS, SEALING RINGS, VALVE SEATS, POUNDER PLATES FOR COMPRESSORS, CUTTING PADS, PUNCH SUPPORTS, EJECTOR DRUMS, MOULDS FOR CONCRETE/CERAMICS FOR WOODWORKING MACHINES, FOR MACHINES FOR THE TEXTILE INDUSTRY, FOR PACKING AND FILLING MACHINES, FOR ROLLING MILLS, FOR BUILDING MACHINERIES AND FOR MACHINES FOR CONVEYING ENGINEERING (U.S. CLS. 13, 19, 21, 23, 31, 34 AND 35).

CLASS 17—RUBBER GOODS

FOR SEMI-FINISHED PRODUCTS, NAMELY, RODS, PLATES, TUBES MADE OF OIL CONTAINING POLYAMID FOR USE IN WOODWORKING MACHINES, FOR MACHINES FOR TEXTILE INDUSTRY, FOR PACKING AND FILLING MACHINES, FOR ROLLING MILLS, FOR BUILDING MACHINERIES AND FOR MACHINES FOR CONVEYING ENGINEERING (U.S. CLS. 1, 5, 12, 13, 35 AND 50).

EUGENIA MARTIN, EXAMINING ATTORNEY

SN 79-021,307. FUNDACION PARA LA INVESTIGACION Y DESARROLLO EN; AUTOMOCION (FUNDACION CIDAUT), SPAIN, FILED 10-26-2005.



OWNER OF INTERNATIONAL REGISTRATION 0878005 DATED 10-26-2005, EXPIRES 10-26-2015.

THE COLOR(S) BLUE, GREY IS/ARE CLAIMED AS A FEATURE OF THE MARK.

THE COLOR BLUE APPEARS IN THE REPRESENTATION OF THE AIRPLANE, THE COLOR GREY APPEARS IN THE WORD CIDAER.

CLASS 12—VEHICLES

FOR AIRPLANES (U.S. CLS. 19, 21, 23, 31, 35 AND 44).

CLASS 40—MATERIAL TREATMENT

FOR TREATMENT OF MATERIALS USED IN FURTHER MANUFACTURE, NAMELY TREATMENT OF PLASTIC MATERIALS BY RESIN TRANSFER MOLDING OF RESIN IN A MOLD, AUTOCLAVING, RESIN FILM INFUSION OF MATERIAL, SHEET MOLDING AND BULK MOLDING; TREATMENT OF METALLIC MATERIALS IN A METALLIC MATRIX OPTIONALLY REINFORCED WITH CERAMIC, BY MACHINING, CASTING, COATING, ANODIZING, PHYSICAL OR CHEMICAL DEPOSITING OF MATERIALS IN A VAPOR PHASE, ORGANIC COATING BY PAINTING AND ELECTRODE POSITING IN CLADDING, HEAT TREATMENT, SURFACE TREATMENT AND HARDENING (U.S. CLS. 100, 103 AND 106).

CLASS 42—SCIENTIFIC, COMPUTER AND LEGAL SERVICES

FOR LABORATORY ANALYSIS OF NEW MATERIALS OF PLASTIC, METAL, AND CERAMICS (U.S. CLS. 100 AND 101).

JULIE GUTTADAURO, EXAMINING ATTORNEY

SN 79-021,456. WILLY BOGNER - GMBH & CO. KG, FED REP GERMANY, FILED 10-31-2005.



OWNER OF INTERNATIONAL REGISTRATION 0655477 DATED 4-18-1996, EXPIRES 4-18-2016.

CLASS 18—LEATHER GOODS

FOR LEATHER OR IMITATION LEATHER GOODS, NAMELY, HANDBAGS, PURSES, CHANGE PURSES, CREDIT CARD CASES, WALLETS, AND KEY CASES; TRUNKS FOR TRAVELING, SUITCASES, CARRY-ALL BAGS, CARRY-ON BAGS, FANNY PACKS, BRIEF-CASES, BRIEFCASE-TYPE PORTFOLIOS, FOLDING BRIEFCASES, BUSINESS CASES, UMBRELLAS, PARASOLS AND CANES (U.S. CLS. 1, 2, 3, 22 AND 41).

CLASS 25—CLOTHING

FOR CLOTHING, NAMELY, PANTS, TROUSERS, RIDING PANTS, GOLF PANTS, DENIM PANTS, SPORTS JACKETS, JACKETS, DRESSES, COATS, SUITS, SKIRTS, BLOUSES, SHIRTS, PARKAS, SKI PANTS, SKI SUITS, OVERALLS, PULLOVERS, T-SHIRTS, STOCKINGS AND GLOVES, SHAWLS, SCARVES, HEADBANDS, SUSPENDERS, SHOES, BELTS MADE FROM LEATHER AND IMITATION LEATHER, SHOES, BOOTS AND HEADWEAR (U.S. CLS. 22 AND 39).

IRENE D. WILLIAMS, EXAMINING ATTORNEY

SN 79-021,984. R-BIOPHARM AG, 64293 DARMSTADT, FED REP GERMANY, FILED 10-5-2005.

PENTOCHECK

THE MARK CONSISTS OF STANDARD CHARACTERS WITHOUT CLAIM TO ANY PARTICULAR FONT, STYLE, SIZE, OR COLOR.

PRIORITY DATE OF 7-25-2005 IS CLAIMED.

OWNER OF INTERNATIONAL REGISTRATION 0879939 DATED 10-5-2005, EXPIRES 10-5-2015.

CLASS 5—PHARMACEUTICALS

FOR PHARMACEUTICAL PREPARATIONS USED IN THE DETECTION, MONITORING, DIAGNOSIS, PREVENTION AND TREATMENT OF CANCER AND OTHER IMMUNOMODULATORY DISEASES (U.S. CLS. 6, 18, 44, 46, 51 AND 52).

CLASS 42—SCIENTIFIC, COMPUTER AND LEGAL SERVICES

FOR SCIENTIFIC AND TECHNOLOGICAL RESEARCH AND DESIGN SERVICES IN THE FIELD OF DISEASE DETECTION, MONITORING, DIAGNOSIS AND PREVENTION (U.S. CLS. 100 AND 101).

CLASS 44—MEDICAL, BEAUTY AND AGRICULTURAL SERVICES

FOR MEDICAL SERVICES; VETERINARY SERVICES (U.S. CLS. 100 AND 101).

LEIGH LOWRY, EXAMINING ATTORNEY

SN 79-022,170. KRÜGER GMBH & CO KG, FED REP GERMANY, FILED 12-21-2005.



OWNER OF INTERNATIONAL REGISTRATION 0618321 DATED 4-15-1994, EXPIRES 4-15-2014.

CLASS 5—PHARMACEUTICALS

FOR FOOD FOR BABIES; DIETETIC FOODSTUFFS FOR MEDICAL USE (U.S. CLS. 6, 18, 44, 46, 51 AND 52).

CLASS 30—STAPLE FOODS

FOR COFFEE, TEA, COCOA, TEA BEVERAGES, COCOA BEVERAGES, CHOCOLATE-BASED BEVERAGES NOT BEING DAIRY-BASED OR VEGETABLE BASED; COFFEE OR COCOA PREPARATIONS FOR THE PRODUCTION OF ALCOHOLIC AND NON-ALCOHOLIC BEVERAGES, NAMELY, COCOA MIXES, COCOA EXTRACTS, COFFEE-FLAVORED SYRUPS, INSTANT COFFEE; PROCESSED CEREALS PREPARED FOR A HUMAN DIET, NAMELY, PROCESSED OAT FLAKES AND OTHER CEREAL GRAIN FLAKES, NAMELY, CORN FLAKES, RICE FLAKES, WHEAT FLAKES, AS WELL AS OTHER CEREAL PREPARATIONS, NAMELY, CEREAL-BASED SNACK FOOD, READY TO EAT, CEREAL DERIVED FOOD BARS; FLAVORINGS FOR FOODSTUFFS (U.S. CL. 46).

CLASS 32—LIGHT BEVERAGES

FOR NON ALCOHOLIC BEVERAGES, NAMELY, FRUIT BEVERAGES, MALT BEVERAGES, SOFT DRINKS; FRUIT DRINKS AND FRUIT JUICES, SYRUPS AND OTHER PREPARATIONS, NAMELY, FRUIT JUICE BASES AND POWDERS FOR MAKING FRUIT DRINKS (U.S. CLS. 45, 46 AND 48).

ALLISON SCHRODY, EXAMINING ATTORNEY

SN 79-022,410. UTTAM KUMAR, NEPAL, UNITED KINGDOM, FILED 9-26-2005.



PRIORITY DATE OF 4-12-2005 IS CLAIMED.
OWNER OF INTERNATIONAL REGISTRATION 0881099
DATED 9-26-2005, EXPIRES 9-26-2015.

NO CLAIM IS MADE TO THE EXCLUSIVE RIGHT TO USE "KIDS", APART FROM THE MARK AS SHOWN.

THE COLOR(S) SKY BLUE, YELLOW, RED, TURQUOISE AND NAVY BLUE IS/ARE CLAIMED AS A FEATURE OF THE MARK.

THE COLOR SKY BLUE APPEARS AS THE BACKGROUND TO THE MARK. THE COLOR YELLOW APPEARS AS THE CENTER OF THE FLOWER ON THE TOP LEFT OF THE MARK AND AS THE SURROUND OF THE FLOWER IN THE CENTER OF THE MARK AND AS THE SURROUND OF THE FLOWER ON THE BOTTOM LEFT OF THE MARK. THE COLOR RED APPEARS AS THE CENTER OF THE FLOWER ON THE BOTTOM LEFT OF THE MARK AND AS THE CENTER OF THE FLOWER IN THE CENTER OF THE MARK AND AS THE CENTER OF THE FLOWER ON THE TOP RIGHT OF THE MARK AND AS THE SURROUND OF THE FLOWER ON THE BOTTOM RIGHT OF THE MARK. THE COLOR TURQUOISE APPEARS AS THE SURROUND OF THE FLOWER ON THE TOP RIGHT OF THE MARK. THE COLOR NAVY BLUE APPEARS AS THE WORDS "UTTAM KIDS" IN THE MARK AND AS THE SHADOW EFFECT ON THE FLOWER IN THE CENTER OF THE MARK.

THE MARK CONSISTS OF THE WORDS UTTAM KIDS AND THE PICTURE OF THE FLOWERS. THE COLOR SKY BLUE APPEARS AS THE BACKGROUND TO THE MARK. THE COLOR YELLOW APPEARS AS THE CENTER OF THE FLOWER ON THE TOP LEFT OF THE MARK AND AS THE SURROUND OF THE FLOWER IN THE CENTER OF THE MARK AND AS THE SURROUND OF THE FLOWER ON THE BOTTOM LEFT OF THE MARK. THE COLOR RED APPEARS AS THE CENTER OF THE FLOWER ON THE BOTTOM LEFT OF THE MARK AND AS THE CENTER OF THE FLOWER IN THE CENTER OF THE MARK AND AS THE CENTER OF THE FLOWER ON THE TOP RIGHT OF THE MARK AND AS THE SURROUND OF THE FLOWER ON THE BOTTOM RIGHT OF THE MARK. THE COLOR TURQUOISE APPEARS AS THE SURROUND OF THE FLOWER ON THE TOP RIGHT OF THE MARK. THE COLOR NAVY BLUE APPEARS AS THE WORDS "UTTAM KIDS" IN THE MARK AND AS THE SHADOW EFFECT ON THE FLOWER IN THE CENTER OF THE MARK.

CLASS 16—PAPER GOODS AND PRINTED MATTER

FOR PAPER, CARDBOARD AND GOODS MADE OUT OF THESE MATERIALS, NAMELY, CALENDARS AND GARMENT TAGS; PRINTED MATTER AND PRINTED ADVERTISEMENTS, NAMELY, MAGAZINES, BROCHURES, LEAFLETS, PAMPHLETS, GUIDES, CHARTS, BOOKS, JOURNALS AND INSTRUCTION MANUALS IN THE FIELD OF CLOTHING AND THE FASHION INDUSTRY; CARDS, NAMELY GREETING CARDS; BUSINESS CARDS; ENVELOPES; POSTERS; PHOTOGRAPHS; STATIONERY; PRESENTATION PORTFOLIOS, NAMELY, DOCUMENT PORTFOLIOS AND PRESS RELEASES IN THE FIELD OF CLOTHING AND THE FASHION INDUSTRY; STATIONARY CASES; VISUAL TEACHING AIDS MADE OUT OF PAPER OR CARDBOARD, NAMELY, FLASH CARDS; STICKERS; PAPER BAGS; PLASTIC BAGS FOR HOUSEHOLD USE; WRAPPING MATERIAL MADE OUT OF PAPER OR PLASTIC, NAMELY, WRAPPING PAPER AND PLASTIC BUBBLE PACKS FOR WRAPPING AND PARTS AND FITTING FOR THE AFORESAID GOODS (U.S. CLS. 2, 5, 22, 23, 29, 37, 38 AND 50).

CLASS 18—LEATHER GOODS

FOR ARTICLES MADE OF LEATHER OR IMITATION LEATHER, NAMELY, HANDBAGS, LUGGAGE AND POCKET CASES; ARTICLES OF LUGGAGE, NAMELY, HANDBAG STRAPS, HANDBAG TAGS, LUGGAGE STRAPS AND LUGGAGE TAGS; TOTE BAGS; TRAVEL BAGS; SUITCASES; GRIPS FOR HANDBAGS AND LUGGAGE; HOLDALLS FOR SUITS, SHOES AND FASHION CLOTHING; TRUNKS AND VALISES; HANDBAGS; SHOULDER BAGS; ATTACHE CASES; BRIEFCASES; TEXTILE SHOPPING BAGS; PURSES; VANITY CASES SOLD EMPTY; POCKET WALLETS; WALLETS; SPORTS BAGS; SCHOOL BAGS; BACKPACKS; RUCKSACKS; POUCHES OF LEATHER FOR PACKAGING; UMBRELLAS AND PARASOLS; WALKING STICKS AND PARTS AND FILLINGS RELATED THERETO (U.S. CLS. 1, 2, 3, 22 AND 41).

CLASS 25—CLOTHING

FOR CLOTHING, NAMELY, TROUSERS, JEANS, PANTS, SHIRTS, T-SHIRTS, JUMPERS, CARDIGANS, COATS, SHORTS, DRESSES, SKIRTS, JACKETS, SCARVES, GLOVES, MITTENS; FOOTWEAR; HEADWEAR, NAMELY, HATS, CAPS AND BERETS; BELTS (U.S. CLS. 22 AND 39).

CLASS 42—SCIENTIFIC, COMPUTER AND LEGAL SERVICES

FOR DESIGN OF CLOTHING, HEADWEAR, FOOTWEAR, BAGS AND LEATHER ACCESSORIES FOR OTHERS (U.S. CLS. 100 AND 101).

MARLENE BELL, EXAMINING ATTORNEY

SN 79-022,601. FONTANA PELLETTIERE S.P.A., ITALY, FILED 1-30-2006.

FONTANA DI TREBBIA

THE MARK CONSISTS OF STANDARD CHARACTERS WITHOUT CLAIM TO ANY PARTICULAR FONT, STYLE, SIZE, OR COLOR.

PRIORITY DATE OF 10-21-2005 IS CLAIMED.

OWNER OF INTERNATIONAL REGISTRATION 0881647
DATED 1-30-2006, EXPIRES 1-30-2016.

THE ENGLISH TRANSLATION OF FONTANA IS "FOUNTAIN"; THE WORD DI MEANS "OF" AND TREBBIA MEANS "THRASHING".

CLASS 3—COSMETICS AND CLEANING PREPARATIONS

FOR PERFUMES, EAU DE PARFUM, COLOGNE, TOILET WATER, ESSENTIAL OILS, COLD CREAM, PERSONAL DEODORANTS, ANTIPERSPIRANTS, CLEANSING LOTIONS, SKIN MOISTURIZER, BODY OIL, SKIN EMOLLIENT, SOAPS, BATH SOAPS, BATH AND SHOWER GEL, BODY LOTIONS, SKIN LOTIONS (U.S. CLS. 1, 4, 6, 50, 51 AND 52).

CLASS 18—LEATHER GOODS

FOR BAGS NAMELY BOOK BAGS, BABY-CARRYING BAGS, GYM BAGS; HANDBAGS, SHOULDER BAGS, BRIEFCASES, DUFFLE BAGS, TOTE BAGS, CLUTCH BAGS, ATTACHÉ-CASES, SUITCASES, GARMENT BAGS FOR TRAVEL, RUCKSACKS, TRUNKS, TRAVELLING BAGS, WALLETS, PURSES, BUSINESS CARD CASES, CREDIT CARD CASES, KEYCASES, PASSPORT CASES, COSMETIC BAGS SOLD EMPTY, UMBRELLAS (U.S. CLS. 1, 2, 3, 22 AND 41).

CLASS 25—CLOTHING

FOR ARTICLES OF CLOTHING FOR MEN, WOMEN AND CHILDREN, NAMELY PULLOVERS, CARDIGANS, SWEATERS, JERSEYS, JUMPERS, JACKETS, SWEAT-SHIRTS, PARKAS, BATHING SUITS, BLOUSES, SHIRTS, TROUSERS, JEANS, WAISTCOATS, SKIRTS, SHORTS, T-SHIRTS, DRESSES, MEN'S SUITS, COATS, RAINCOATS, OVERCOATS, OVERALLS, UNDERWEAR, VESTS, HOSIERY AND PANTY-HOSES, BATHROBES, SHAWLS, SCARVES, NECKTIES, GLOVES, BELTS, SHOES, BOOTS, SANDALS, SLIPPERS, CLOGS, HATS AND CAPS (U.S. CLS. 22 AND 39).

LAURA KOVALSKY, EXAMINING ATTORNEY

SN 79-023,110. EMCOOLS - EMERGENCY MEDICAL; COOLING SYSTEMS AG, AUSTRIA, FILED 12-16-2005.

RESCUEFREEZE

THE MARK CONSISTS OF STANDARD CHARACTERS WITHOUT CLAIM TO ANY PARTICULAR FONT, STYLE, SIZE, OR COLOR.

PRIORITY DATE OF 6-20-2005 IS CLAIMED.
OWNER OF INTERNATIONAL REGISTRATION 0882930 DATED 12-16-2005, EXPIRES 12-16-2015.

CLASS 10—MEDICAL APPARATUS

FOR MATTRESSES FOR MEDICAL PURPOSES, INSULATING AND COOLING MATS AND MATTRESS OVERLAYS FOR MEDICAL PURPOSES (U.S. CLS. 26, 39 AND 44).

CLASS 27—FLOOR COVERINGS

FOR GYMNASTIC MATS AND PERSONAL SITTING MATS FOR NON-MEDICAL PURPOSES, INSULATING AND COOLING MATS AND MATTRESS OVERLAYS FOR NON-MEDICAL PURPOSES (U.S. CLS. 19, 20, 37, 42 AND 50).

KAELIE KUNG, EXAMINING ATTORNEY

SN 79-023,078. LYNSEY HAND LTD, LONDON N14 4ET, UNITED KINGDOM, FILED 9-29-2005.

MISS L FIRE

THE MARK CONSISTS OF STANDARD CHARACTERS WITHOUT CLAIM TO ANY PARTICULAR FONT, STYLE, SIZE, OR COLOR.

PRIORITY DATE OF 8-13-2005 IS CLAIMED.
OWNER OF INTERNATIONAL REGISTRATION 0882849 DATED 9-29-2005, EXPIRES 9-29-2015.

CLASS 18—LEATHER GOODS

FOR ARTICLES MADE OF LEATHER AND IMITATIONS OF LEATHER, NAMELY, HANDBAGS; PURSES; WALLETS; TOTE BAGS; BRIEF CASES; SATCHELS (U.S. CLS. 1, 2, 3, 22 AND 41).

CLASS 25—CLOTHING

FOR CLOTHING, NAMELY, DRESSES, SKIRTS, BLOUSES, SWEATERS, SOCKS, STOCKINGS, FOOTWEAR, HEADWEAR AND BELTS (U.S. CLS. 22 AND 39).

STEVEN PEREZ, EXAMINING ATTORNEY

SN 79-023,984. RASPRODZ (UK) LIMITED, KENNINGTON; ASHFORD, KENT TN25 4DU, UNITED KINGDOM, FILED 6-7-2005.

"SNAPSTER"

PRIORITY DATE OF 12-16-2004 IS CLAIMED.
OWNER OF INTERNATIONAL REGISTRATION 0885240 DATED 6-7-2005, EXPIRES 6-7-2015.

CLASS 9—ELECTRICAL AND SCIENTIFIC APPARATUS

FOR DATA PROCESSING EQUIPMENT, NAMELY, DATA PROCESSORS AND COMPUTERS FOR AN INTERACTIVE RADIO AND TELEVISION ON-AIR PROMOTION UTILIZING CUSTOMIZED COMPUTER SOFTWARE THAT DETECTS INCOMING DUAL TONE MULTI FREQUENCY (DTMF) VIA AN ANALOGUE OR DIGITAL TELEPHONE HYBRID WHICH INSTRUCTS APPLICATION SOFTWARE TO PERFORM VARIOUS FUNCTIONS, NAMELY, PLAYING A GAME, AND RESPONDS WITH AUDIO AND VISUAL PROMPTS, THE RESULTS OF WHICH ARE BROADCAST ON BY WAY OF AUDIO OR AUDIO AND VISUAL GRAPHICS (U.S. CLS. 21, 23, 26, 36 AND 38).

CLASS 38—COMMUNICATION

FOR BROADCASTING AND TRANSMISSION SERVICES NAMELY, BROADCASTING AND TRANSMISSION OF TELEVISION, RADIO, CABLE RADIO AND TELEVISION AND SATELLITE RADIO AND TELEVISION PROGRAMMES; ON-LINE VIDEO BROADCASTING; DATA TRANSMISSION AND DATA BROADCASTING OVER HIGH SPEED TELEPHONE, CABLE RADIO AND TELEVISION, SATELLITE RADIO AND TELEVISION AND RADIO FREQUENCY NETWORKS; AUDIO STREAMING IN THE NATURE OF STREAMING OF AUDIO AND MATERIAL OVER THE INTERNET; VIDEO STREAMING IN THE NATURE OF STREAMING VIDEO OVER THE INTERNET; BROADCASTING AND TRANSMISSION OF MESSAGES, TEXT, SOUND AND IMAGES BY TELEVISION, RADIO, CABLE RADIO AND TELEVISION AND SATELLITE RADIO AND TELEVISION; ELECTRONIC TRANSMISSION OF MESSAGES, TEXT, SOUND, IMAGES, INFORMATION, DATA AND RADIO AND TELEVISION PROGRAMMES; BROADCASTING AND TRANSMISSION OF DIGITAL INFORMATION BY MEANS OF RADIO, TELEPHONE, SATELLITE RADIO AND TELEVISION, CABLE RADIO AND TELEVISION AND COMPUTER; WIRELESS DIGITAL MESSAGING SERVICES IN THE NATURE OF RECEIVING AND EXCHANGING OF TEXT, MESSAGES, SOUND, IMAGES AND INFORMATION VIA TELEPHONES, CELLULAR PHONES, FACSIMILE MACHINES AND MODEMS; PROVIDING MULTIPLE USER ACCESS TO A GLOBAL COMPUTER INFORMATION NETWORK FEATURING ONLINE DATABASES; FACSIMILE TRANSMISSION SERVICES; WEB MESSAGING SERVICES IN THE NATURE OF SENDING MESSAGES AND INFORMATION ONLINE; INFORMATION SENDING SERVICES, NAMELY, TELEMATIC SENDING OF INFORMATION; ELECTRONIC MESSAGE SENDING SERVICES; ELECTRONIC MAIL SERVICES; ONLINE DISSEMINATION OF INFORMATION IN THE FIELD OF RADIO AND TELEVISION BROADCASTING; PROVISION OF TELECOMMUNICATIONS INFORMATION BY MEANS OF ELECTRONIC COMMUNICATIONS NETWORKS NAMELY THE INTERNET; CABLE TELEVISION BROADCASTING SERVICES IN THE NATURE OF RETRIEVAL AND DISPLAY OF INFORMATION ON COMPETITIONS AND QUIZZES (U.S. CLS. 100, 101 AND 104).

CLASS 41—EDUCATION AND ENTERTAINMENT

FOR ENTERTAINMENT, INSTRUCTION AND EDUCATION NAMELY, ORGANIZATION OF GAMES BROADCAST BY RADIO AND TELEVISION; PRODUCTION, DISTRIBUTION AND SYNDICATION OF INTERACTIVE ENTERTAINMENT IN THE NATURE OF COMPUTER GAMES BROADCAST ON RADIO AND TELEVISION FEATURING QUIZ/GAME SHOWS; MULTIMEDIA ENTERTAINMENT SOFTWARE PRODUCTION SERVICES; PRODUCTION, DISTRIBUTION AND SYNDICATION OF TELEVISION AND RADIO PROGRAMMES; GAMING NAMELY, CASINOS; GAMING SERVICES FOR ENTERTAINMENT PURPOSES, NAMELY, CONDUCTING AND PROVIDING FACILITIES FOR SPECIAL EVENTS FEATURING CASINO AND GAMING CONTESTS AND TOURNAMENTS; GAMING MACHINE ENTERTAINMENT SERVICES, NAMELY LEASING OF ELECTRONIC GAMING MACHINES; ON-LINE GAMING SERVICES FOR SINGLE OR MULTIPLE PLAYERS NAMELY, PROVIDING ON-LINE COMPUTER GAMES FEATURING A GAME OF SKILL; EDUCATIONAL AND ENTERTAINMENT SERVICES NAMELY CONDUCTING SEMINARS, WORKSHOPS AND CLASSES IN THE FIELD OF COMPUTER GAME PRODUCTION, RADIO AND TELEVISION PROGRAMMING, AND PROMOTIONAL ACTIVITY SERVICES PROVIDED FOR RADIO AND TELEVISION PROVIDED VIA ALL FORMS OF ELECTRONIC TRANSMISSION; PROVIDING ON-LINE AUDIO, VISUAL AND AUDIO-VISUAL INFORMATION IN THE FIELD OF ONLINE COMPUTER GAME ENTERTAINMENT, RADIO AND TELEVISION PROGRAMMING AND PROMOTIONS PRODUCTION AND INTERACTIVE GAMING AND QUIZ PRODUCTION; PUBLICATION OF NEWSLETTERS, BOOKS, STATISTICS AND REVIEWS FEATURING INFORMATION ON COMPUTER GAMES, RADIO AND TELEVISION PROGRAMMING AND PROMOTIONAL ACTIVITY AND INTERACTIVE GAMES

AND QUIZZES; ELECTRONIC PUBLISHING NAMELY, PUBLISHING OF WEB MAGAZINES; CONDUCTING SEMINARS AND WORKSHOPS RELATING TO EDUCATION, AND ENTERTAINMENT IN THE FIELD OF ONLINE COMPUTER GAME ENTERTAINMENT, RADIO AND TELEVISION PROGRAMMING AND PROMOTIONS PRODUCTION AND INTERACTIVE GAMING AND QUIZ PRODUCTION; PRODUCTION, ORGANIZATION AND PRESENTATION OF LIVE PERFORMANCES OF QUIZZES, AUDIENCE PARTICIPATION EVENTS IN THE NATURE OF QUIZZES AND QUIZ SHOWS, INTERACTIVE QUIZ CONTESTS, GAMES SHOWS; PROVISION OF INFORMATION IN THE FIELD OF COMPUTER GAMES, RADIO AND TELEVISION PROGRAMMING AND PROMOTIONS, INTERACTIVE GAMING AND QUIZZES (U.S. CLS. 100, 101 AND 107).

JILL C. ALT, EXAMINING ATTORNEY

SN 79-024,753. LEINWEBER GMBH & CO. KG, FED REP GERMANY, FILED 1-12-2006.

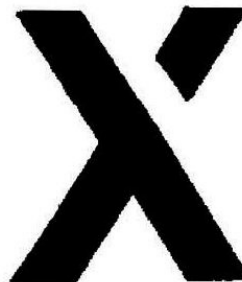

PRIORITY DATE OF 11-14-2005 IS CLAIMED.
OWNER OF INTERNATIONAL REGISTRATION 0887300
DATED 1-12-2006, EXPIRES 1-12-2016.

CLASS 3—COSMETICS AND CLEANING PREPARATIONS

FOR SOAPS, PERFUMERY, ESSENTIAL OILS, COSMETICS, HAIR LOTIONS, DEODORANTS, PERFUME SPRAY, INCLUDED IN THIS CLASS, EAU DE TOILETTE, SHAMPOOS, LOTIONS, NAMELY, BODY LOTION, SUN TANNING LOTION, HAIR-CARE PREPARATIONS, BATH SALTS. (U.S. CLS. 1, 4, 6, 50, 51 AND 52).

CLASS 14—JEWELRY

FOR JEWELLERY, PRECIOUS STONES; HOROLOGICAL AND CHRONOMETRIC INSTRUMENTS (U.S. CLS. 2, 27, 28 AND 50).

CLASS 18—LEATHER GOODS

FOR PRODUCTS OF LEATHER AND IMITATIONS OF LEATHER, NAMELY, SUITCASES, BAGS, GARMENT BAGS, ATTACHÉ CASES, BRIEFCASES, WALLETS, PURSES, RUCKSACKS (U.S. CLS. 1, 2, 3, 22 AND 41).

CLASS 25—CLOTHING

FOR ARTICLES OF CLOTHING, NAMELY, PANTS, SHORTS, SKIRTS, OVERALLS, DRESSES, SHIRTS, T-SHIRTS, PULLOVERS, SWEATERS, VESTS, JACKETS, COATS, UNDERGARMENTS, GLOVES, SCARVES, BANDANNAS, SOCKS, SHOES, BELTS, HATS AND CAPS. (U.S. CLS. 22 AND 39).

ROBIN CHOSID, EXAMINING ATTORNEY

SN 79-025,283. RIELDA S.R.L., ITALY, FILED 8-19-2005.

AOBA

THE MARK CONSISTS OF STANDARD CHARACTERS WITHOUT CLAIM TO ANY PARTICULAR FONT, STYLE, SIZE, OR COLOR.

PRIORITY DATE OF 7-1-2005 IS CLAIMED.
OWNER OF INTERNATIONAL REGISTRATION 0888644 DATED 8-19-2005, EXPIRES 8-19-2015.

CLASS 6—METAL GOODS

FOR METAL KEY LOCKS, MECHANICALLY REPROGRAMMABLE LOCKS, COMBINATION LOCKS AND CYLINDERS FOR LOCKS; METAL BOLTS; METAL KEY BLANKS; METAL PADLOCKS (U.S. CLS. 2, 12, 13, 14, 23, 25 AND 50).

CLASS 14—JEWELRY

FOR KEY RINGS OF NON-PRECIOUS METAL (U.S. CLS. 2, 27, 28 AND 50).
RICHARD WHITE, EXAMINING ATTORNEY

SN 79-025,409. ABOCA S.P.A., ITALY, FILED 5-5-2006.

FitoroiD

PRIORITY DATE OF 3-23-2006 IS CLAIMED.
OWNER OF INTERNATIONAL REGISTRATION 0889036 DATED 5-5-2006, EXPIRES 5-5-2016.
"FITOROID" THE FIRST AND LAST LETTERS OF WHICH ARE CAPITAL LETTERS AND LARGER.

CLASS 3—COSMETICS AND CLEANING PREPARATIONS

FOR CREAMS AND POMADES FOR COSMETIC PURPOSES (U.S. CLS. 1, 4, 6, 50, 51 AND 52).

CLASS 5—PHARMACEUTICALS

FOR CREAMS AND POMADES FOR MEDICAL PURPOSES, MINERAL AND/OR VEGETABLE FOOD SUPPLEMENTS FOR MEDICAL PURPOSES, OINTMENTS FOR PHARMACEUTICAL PURPOSES, ALL INTENDED FOR THE TREATMENT OF HAEMORRHOIDS AND NOT REQUIRING A PRESCRIPTION (U.S. CLS. 6, 18, 44, 46, 51 AND 52).
STANLEY I. OSBORNE, EXAMINING ATTORNEY

SN 79-025,501. SIDROGA AG, CH-4800 ZOFINGEN, SWITZERLAND, FILED 2-2-2006.

SIDROGA

OWNER OF INTERNATIONAL REGISTRATION 0774466 DATED 12-7-2001, EXPIRES 12-7-2011.
OWNER OF U.S. REG. NO. 2,483,361.

CLASS 5—PHARMACEUTICALS

FOR HERBAL TEAS FOR MEDICINAL PURPOSES; BIOLOGICAL PREPARATIONS FOR MEDICINAL PURPOSES (U.S. CLS. 6, 18, 44, 46, 51 AND 52).

CLASS 30—STAPLE FOODS

FOR TEA (U.S. CL. 46).
JAMES MACFARLANE, EXAMINING ATTORNEY

SN 79-026,120. WELLA AKTIENGESELLSCHAFT, FED REP GERMANY, FILED 4-27-2006.

TRILUXIV

THE MARK CONSISTS OF STANDARD CHARACTERS WITHOUT CLAIM TO ANY PARTICULAR FONT, STYLE, SIZE, OR COLOR.

PRIORITY DATE OF 11-4-2005 IS CLAIMED.
OWNER OF INTERNATIONAL REGISTRATION 0891067 DATED 4-27-2006, EXPIRES 4-27-2016.

CLASS 1—CHEMICALS

FOR CHEMICAL PREPARATIONS USED IN INDUSTRY FOR THE PRODUCTION OF COSMETIC PREPARATIONS, HAIR DYE PREPARATIONS, PERMANENT WARE PREPARATIONS AND CLEANING PREPARATIONS FOR THE BODY, NAMELY, SKIN CLEANSERS AND SHOWER GEL (U.S. CLS. 1, 5, 6, 10, 26 AND 46).

CLASS 3—COSMETICS AND CLEANING PREPARATIONS

FOR SOAPS, PERFUMERY, ESSENTIAL OILS FOR PERSONAL USE, COSMETICS, NAMELY SHAMPOOS AND HAIR CONDITIONERS; HAIR COLOR AND DYES, COLOR REMOVAL AND LIGHTENING PREPARATIONS AND HAIR BLEACHES; HAIR STYLING AND FINISHING PRODUCTS, NAMELY, HAIR SPRAYS, SPRAY GELS, GELS, MOUSSES, CREAMS, LOTIONS, POMADES AND HAIRWAXES; HAIR AND SCALP TREATMENTS, NAMELY, RESTRUCTURIZERS AND SCALP CONDITIONERS, HAIR LOTIONS, DENTIFRICES (U.S. CLS. 1, 4, 6, 50, 51 AND 52).
JENNIFER MARTIN, EXAMINING ATTORNE

SECTION 2.— INTERNATIONAL CLASSIFICATION

The short titles associated below with the international class numbers are terms designed merely for quick identification and are not an official part of the international classification. The full names of international classes are given in section 6.1 of the trademark rules of practice.

The designation "U.S. Cl." appearing in this section refers to the U.S. class in effect prior to Sep. 1, 1973 rather than the international class which applies to applications filed on or after that date. For adoption of international classification see notice in the OFFICIAL GAZETTE of Jun. 26, 1973 (911 O.G. TM 210).

Application in one class

CLASS 1—CHEMICALS

SN 76-623,309. E. BEGEROW GMBH & CO., 55450 LANGENLONSHEIM, FED REP GERMANY, FILED 12-6-2004.

CLASS 1—(Continued).

SN 78-411,505. JSR CORPORATION, TOKYO, JAPAN, FILED 4-30-2004.

BECO UltraPure

NO CLAIM IS MADE TO THE EXCLUSIVE RIGHT TO USE "ULTRAPURE", APART FROM THE MARK AS SHOWN.

FOR UNPROCESSED PLASTICS, CERAMIC PARTICLES, AND MINERAL SUBSTANCES IN THE NATURE OF FILTERING MATERIALS, NAMELY, CELLULOSE, PEARLITE AND KIESELGUHR FOR USE AS PLATE MATERIAL AND CLARIFYING AND DEGERMINATING LAYERS IN THE BEVERAGE, CHEMICAL, CHEMICAL-PHARMACEUTICAL, COSMETIC AND FOODSTUFF INDUSTRIES (U.S. CLS. 1, 5, 6, 10, 26 AND 46).

RONALD MCMORROW, EXAMINING ATTORNEY

JSR MES

SN 76-640,256. NEXTTEQ, L.L.C., TAMPA, FL. FILED 6-6-2005.

DERMTEST

THE MARK CONSISTS OF STANDARD CHARACTERS WITHOUT CLAIM TO ANY PARTICULAR FONT, STYLE, SIZE, OR COLOR.

FOR DISPOSABLE SURFACE WIPES IMPREGNATED WITH CHEMICALS, DISPOSABLE SURFACE WIPES IMPREGNATED WITH BIOLOGICAL MATERIALS, DISPOSABLE SKIN WIPES IMPREGNATED WITH CHEMICALS, AND DISPOSABLE SKIN WIPES IMPREGNATED WITH BIOLOGICAL MATERIALS, ALL FOR DETECTION AND QUANTIFICATION OF CONTAINMENTS, FOR SCIENTIFIC AND INDUSTRIAL USE (U.S. CLS. 1, 5, 6, 10, 26 AND 46).

FIRST USE 10-15-2004; IN COMMERCE 10-15-2004.

ARETHA SOMERVILLE, EXAMINING ATTORNEY

THE MARK CONSISTS OF STANDARD CHARACTERS WITHOUT CLAIM TO ANY PARTICULAR FONT, STYLE, SIZE, OR COLOR.

PRIORITY CLAIMED UNDER SEC. 44(D) ON JAPAN APPLICATION NO. 2004-27088, FILED 3-23-2004, REG. NO. 4965401, DATED 6-30-2006, EXPIRES 6-30-2016.

FOR PHOTORESISTS (U.S. CLS. 1, 5, 6, 10, 26 AND 46).
STANLEY I. OSBORNE, EXAMINING ATTORNEY

CLASS 1—(Continued).

SN 78-453,000. IVEY, GEORGE, CAMPBELL RIVER, B.C., CANADA, FILED 7-19-2004.

Selective Phase Transfer (SPT)

THE MARK CONSISTS OF STANDARD CHARACTERS WITHOUT CLAIM TO ANY PARTICULAR FONT, STYLE, SIZE, OR COLOR.

NO CLAIM IS MADE TO THE EXCLUSIVE RIGHT TO USE SELECTIVE PHASE TRANSFER, APART FROM THE MARK AS SHOWN.

FOR PATENTED NON-IONIC SURFACTANT MIXTURE, NAMELY, A SOLVENT USED TO DISSOLVE OIL AND HEAVY METALS (U.S. CLS. 1, 5, 6, 10, 26 AND 46).

STEPHANIE DAVIS, EXAMINING ATTORNEY

CLASS 1—(Continued).

SN 78-598,358. 20/20 GENESYSTEMS, INC., ROCKVILLE, MD. FILED 3-30-2005.

BIOCHECK

THE MARK CONSISTS OF STANDARD CHARACTERS WITHOUT CLAIM TO ANY PARTICULAR FONT, STYLE, SIZE, OR COLOR.

FOR CHEMICAL ANALYSIS KITS, COMPRISED OF A CHEMICAL REAGENT FOR DETERMINING THE PRESENCE OF PROTEIN AND PH, SWABS FOR PROTEIN DETECTION AND PH DETERMINATION, A CONTROL SWAB, AND AN INSTRUCTION SHEET FOR USE IN RAPID SCREENING FOR THE PRESENCE OF BIOHAZARDOUS MATERIAL USED AS BIOTERRORISM AGENTS (U.S. CLS. 1, 5, 6, 10, 26 AND 46).

FIRST USE 2-10-2003; IN COMMERCE 2-10-2003.
BARBARA A. GOLD, EXAMINING ATTORNEY

SN 78-578,662. NEWPAGE CORPORATION, DAYTON, OH. FILED 3-2-2005.

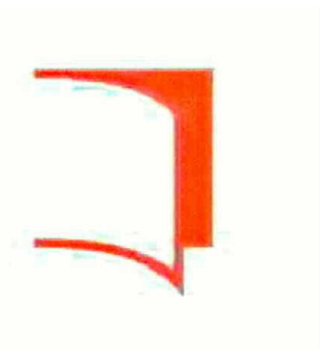

THE COLORS WHITE AND RED ARE CLAIMED AS A FEATURE OF THE MARK.

THE TOP PAGE OF THE DESIGN APPEARS IN WHITE WITH A RED BORDER. THE SECOND PAGE APPEARS IN THE COLOR RED.

THE MARK CONSISTS OF A STYLIZED "TURNING PAGE" DESIGN.

FOR CHEMICALS USED IN THE PAPER INDUSTRY, NAMELY WOOD PULP AND PAPER COATING CHEMICAL COMPOSITIONS FOR USE IN THE MANUFACTURE OF PAPER (U.S. CLS. 1, 5, 6, 10, 26 AND 46).

JILL PRATER, EXAMINING ATTORNEY

SN 78-629,138. WESTLAKE POLYMERS LP, HOUSTON, TX. FILED 5-12-2005.



OWNER OF U.S. REG. NOS. 1,607,903, 1,676,459 AND 2,151,862.

THE COLOR(S) LIGHT BLUE AND DARK BLUE IS/ARE CLAIMED AS A FEATURE OF THE MARK.

THE MARK CONSISTS OF A LIGHT BLUE SQUARE WITHIN WHICH IS A STYLIZED LETTER W, THE LEFT HALF OF WHICH IS LIGHT BLUE AND THE RIGHT HALF OF WHICH IS DARK BLUE.

FOR COMMODITY AND SPECIALITY CHEMICALS FOR INDUSTRIAL, COMMERCIAL, AND CONSUMER APPLICATIONS, NAMELY, UNPROCESSED ARTIFICIAL RESINS, POLYMERS, AND UNPROCESSED PLASTICS, ALL FOR GENERAL INDUSTRIAL USE (U.S. CLS. 1, 5, 6, 10, 26 AND 46).

FIRST USE 10-0-1987; IN COMMERCE 10-0-1987.
CHRISTOPHER OTT, EXAMINING ATTORNEY

CLASS 1—(Continued).

SN 78-651,868. CONSTRUCTION RESEARCH & TECHNOLOGY, GMBH, TROSTBERG, FED REP GERMANY, FILED 6-16-2005.

CLASS 1—(Continued).

SN 78-694,848. E F PRODUCTS, INC., DALLAS, TX. FILED 8-17-2005.

ENVIRO-BLOK

THE MARK CONSISTS OF STANDARD CHARACTERS WITHOUT CLAIM TO ANY PARTICULAR FONT, STYLE, SIZE, OR COLOR.

FOR CHEMICAL PREPARATIONS FOR CEMENTITIOUS COMPOSITIONS IN THE CONSTRUCTION INDUSTRY; CHEMICAL PREPARATIONS FOR USE IN THE CONSTRUCTION INDUSTRY, NAMELY, ADMIXTURES FOR CONCRETE, MORTAR OR GROUT WITH ANTI-MICROBIAL PROPERTIES (U.S. CLS. 1, 5, 6, 10, 26 AND 46).

DARRYL SPRUILL, EXAMINING ATTORNEY



SN 78-656,187. RUDIS, MARK A, WINTER PARK, CO. FILED 6-22-2005.

OOL Group

THE MARK CONSISTS OF STANDARD CHARACTERS WITHOUT CLAIM TO ANY PARTICULAR FONT, STYLE, SIZE, OR COLOR.

NO CLAIM IS MADE TO THE EXCLUSIVE RIGHT TO USE "GROUP", APART FROM THE MARK AS SHOWN.

FOR PROTEINS, PROTEINOIDS, AND PROTO-CELLS USED IN ORIGIN OF LIFE RESEARCH AND IN ANCILLARY BIOLOGICAL AND MEDICAL APPLICATIONS (U.S. CLS. 1, 5, 6, 10, 26 AND 46).

SALLY SHIH, EXAMINING ATTORNEY



SN 78-694,841. E F PRODUCTS, INC., DALLAS, TX. FILED 8-17-2005.

COOL DOWN

THE MARK CONSISTS OF STANDARD CHARACTERS WITHOUT CLAIM TO ANY PARTICULAR FONT, STYLE, SIZE, OR COLOR.

FOR VEHICLE AIR CONDITIONING SYSTEM ADDITIVES, NAMELY REFRIGERANTS MIXED WITH CHEMICAL ADDITIVES, THE MIXTURE BEING USED TO INCREASE PERFORMANCE OF VEHICLE AIR CONDITIONING SYSTEMS; PRESSURIZED CANS OF CHEMICAL ADDITIVES FOR VEHICLE AIR CONDITIONING SYSTEMS; CHEMICAL ADDITIVES FOR VEHICLE AIR CONDITIONING SYSTEMS FOR IMPROVING THE PERFORMANCE OF COMPRESSORS; CHEMICAL ADDITIVES FOR VEHICLE AIR CONDITIONING SYSTEMS FOR REDUCING FRICTION IN VEHICLE AIR CONDITIONING SYSTEMS (U.S. CLS. 1, 5, 6, 10, 26 AND 46).

FIRST USE 2-0-2001; IN COMMERCE 2-0-2001.

JOHN LINCOSKI, EXAMINING ATTORNEY

TOTAL TREATMENT

THE MARK CONSISTS OF STANDARD CHARACTERS WITHOUT CLAIM TO ANY PARTICULAR FONT, STYLE, SIZE, OR COLOR.

NO CLAIM IS MADE TO THE EXCLUSIVE RIGHT TO USE TREATMENT, APART FROM THE MARK AS SHOWN.

FOR CHEMICAL ADDITIVES FOR VEHICLE AIR CONDITIONING SYSTEMS, NAMELY REFRIGERANTS MIXED WITH CHEMICAL ADDITIVES, THE MIXTURE BEING USED TO INCREASE PERFORMANCE OF VEHICLE AIR CONDITIONING SYSTEMS; PRESSURIZED CANS OF CHEMICAL ADDITIVES FOR VEHICLE AIR CONDITIONING SYSTEMS; CHEMICAL ADDITIVES FOR VEHICLE AIR CONDITIONING SYSTEMS FOR REDUCING ENGINE DRAG; CHEMICAL ADDITIVES FOR VEHICLE AIR CONDITIONING SYSTEMS FOR EXTENDING COMPRESSOR LIFE; CHEMICAL ADDITIVES FOR VEHICLE AIR CONDITIONING SYSTEMS FOR REDUCING OR PREVENTING OXIDATION; AND CHEMICAL ADDITIVES FOR VEHICLE AIR CONDITIONING SYSTEMS FOR REDUCING OR PREVENTING SLUDGE FORMATION (U.S. CLS. 1, 5, 6, 10, 26 AND 46).

FIRST USE 2-0-2002; IN COMMERCE 2-0-2002.

JOHN LINCOSKI, EXAMINING ATTORNEY



SN 78-705,882. VELTEK ASSOCIATES, INC., MALVERN, PA. FILED 9-2-2005.

STERI-PEROX

THE MARK CONSISTS OF STANDARD CHARACTERS WITHOUT CLAIM TO ANY PARTICULAR FONT, STYLE, SIZE, OR COLOR.

FOR STERILE HYDROGEN PEROXIDE FOR USE IN CLEAN ROOMS (U.S. CLS. 1, 5, 6, 10, 26 AND 46).

FIRST USE 1-0-1994; IN COMMERCE 1-0-1994.

HOWARD B. LEVINE, EXAMINING ATTORNEY

CLASS 1—(Continued).

SN 78-711,867. SYSMEX CORPORATION, HYOGO, JAPAN,
FILED 9-13-2005.

PARTICLE SHEATH

THE MARK CONSISTS OF STANDARD CHARACTERS WITHOUT CLAIM TO ANY PARTICULAR FONT, STYLE, SIZE, OR COLOR.

SEC. 2(F).

FOR CHEMICALS FOR USE IN SCIENCE AND INDUSTRY; CHEMICAL REAGENTS, OTHER THAN FOR MEDICAL OR VETERINARY PURPOSES; CHEMICAL PREPARATIONS FOR SCIENTIFIC PURPOSES; CHEMICAL PRODUCTS FOR USE IN THE MANUFACTURE OF PHARMACEUTICALS; DIAGNOSTIC CHEMICALS PREPARATIONS FOR SCIENTIFIC OR RESEARCH USE; DIAGNOSTIC CHEMICAL PREPARATIONS, OTHER THAN FOR MEDICAL OR VETERINARY PURPOSES; REAGENTS FOR INDUSTRIAL USE, NAMELY, FOR USE IN PARTICLES OR PARTICLES IMAGE ANALYSIS, POWDERS ANALYSIS, BACTERIA ANALYSIS, VIRUS ANALYSIS, CELL ANALYSIS, AND POLYMER ANALYSIS; DIAGNOSTIC REAGENTS FOR SCIENTIFIC AND RESEARCH USE; CHEMICAL REAGENTS FOR NON-MEDICAL PURPOSES FOR USE IN PARTICLES IMAGE ANALYSIS, POWDERS ANALYSIS, MEASUREMENT OF PARTICLES; REAGENTS FOR SCIENTIFIC OR MEDICAL RESEARCH USE IN BACTERIA ANALYSIS, HEMATOLOGY ANALYSIS, BLOOD ANALYSIS; CHEMICALS, NAMELY, SHEATH SOLUTIONS OTHER THAN FOR MEDICAL OR VETERINARY PURPOSES; CHEMICALS, NAMELY, SHEATH SOLUTIONS USED IN SCIENCE, INDUSTRY AND LABORATORY ANALYSIS; CHEMICALS, NAMELY, SHEATH SOLUTIONS FOR PARTICLES OR PARTICLES IMAGE ANALYSIS; CHEMICALS, NAMELY, SHEATH SOLUTIONS FOR POWDERS ANALYSIS; CHEMICALS, NAMELY, SHEATH SOLUTIONS FOR MEASUREMENT OF PARTICLES; CHEMICALS, NAMELY, SHEATH SOLUTIONS FOR BACTERIA ANALYSIS; CHEMICALS, NAMELY, SHEATH SOLUTIONS FOR HEMATOLOGY ANALYSIS; SHEATH SOLUTIONS FOR BLOOD ANALYSIS; CHEMICALS, NAMELY, ELECTROLYTIC SHEATH SOLUTIONS USED IN SCIENCE, INDUSTRY AND LABORATORY ANALYSIS; CHEMICALS FOR USE IN INDUSTRY AND SCIENCE, NAMELY, DILUENTS OTHER THAN FOR MEDICAL OR VETERINARY PURPOSES (U.S. CLS. 1, 5, 6, 10, 26 AND 46).

FIRST USE 9-30-1995; IN COMMERCE 6-30-2000.

GEOFFREY FOSDICK, EXAMINING ATTORNEY

CLASS 1—(Continued).

SN 78-718,734. BALSAMO, LAWRENCE J., ROSELLE, IL.
FILED 9-22-2005.



NO CLAIM IS MADE TO THE EXCLUSIVE RIGHT TO USE "MPG", APART FROM THE MARK AS SHOWN.

THE MARK CONSISTS OF THE NUMBER THREE WITH THE LETTERS MPG SUPERIMPOSED ON THE NUMBER THREE.

FOR CHEMICAL ADDITIVES FOR ENHANCING THE PERFORMANCE OF LUBRICATING OILS, GREASES AND INTERNAL COMBUSTION ENGINE FUELS; CHEMICAL ADDITIVES FOR FUEL TREATMENT; CHEMICAL ADDITIVES FOR USE WITH INTERNAL COMBUSTION ENGINE FUELS; CHEMICAL ENGINE TREATMENTS AND ADDITIVES FOR ENGINE OILS, GASOLINE AND DIESEL FUELS, TRANSMISSION FLUIDS AND COOLING SYSTEMS; CHEMICAL GASOLINE ADDITIVES; CHEMICAL MOTOR OIL ADDITIVES; DETERGENT ADDITIVE FOR USE WITH MOTOR OIL; FUEL INJECTION CLEANER CHEMICAL ADDITIVE; OCTANE BOOSTER FUEL CHEMICAL ADDITIVE (U.S. CLS. 1, 5, 6, 10, 26 AND 46).

MARLENE BELL, EXAMINING ATTORNEY

SN 78-719,112. FERRO CORPORATION, CLEVELAND, OH.
FILED 9-23-2005.

LENSMAX

THE MARK CONSISTS OF STANDARD CHARACTERS WITHOUT CLAIM TO ANY PARTICULAR FONT, STYLE, SIZE, OR COLOR.

FOR GLASS POLISHING COMPOSITION FOR USE IN THE OPTICAL AND GLASS INDUSTRIES (U.S. CLS. 1, 5, 6, 10, 26 AND 46).

FIRST USE 1-1-1993; IN COMMERCE 1-1-1993.

ANNE FARRELL, EXAMINING ATTORNEY

CLASS 1—(Continued).

SN 78-719,267. NATIONAL RESEARCH LABORATORIES, LTD., CINCINNATI, OH. FILED 9-23-2005.

MCC

THE MARK CONSISTS OF STANDARD CHARACTERS WITHOUT CLAIM TO ANY PARTICULAR FONT, STYLE, SIZE, OR COLOR.

SEC. 2(F).

FOR CHEMICALS, NAMELY MONOMETAL COMPLEXES COMPRISED OF A MULTIVALENT HEAVY METAL ION AND A POLYFUNCTIONAL ORGANIC LIGAND IN A RATIO OF 1:1; FOR USE IN THE MANUFACTURE OF A VARIETY OF GOODS (U.S. CLS. 1, 5, 6, 10, 26 AND 46).

FIRST USE 7-0-1975; IN COMMERCE 7-0-1975.

CHRIS WELLS, EXAMINING ATTORNEY

SN 78-719,624. HERNON MANUFACTURING, INC, SANFORD, FL. FILED 9-23-2005.

DISSIPATOR

THE MARK CONSISTS OF STANDARD CHARACTERS WITHOUT CLAIM TO ANY PARTICULAR FONT, STYLE, SIZE, OR COLOR.

FOR ADHESIVES FOR GENERAL INDUSTRIAL USE (U.S. CLS. 1, 5, 6, 10, 26 AND 46).

FIRST USE 0-0-1990; IN COMMERCE 0-0-1990.

MELISSA VALLILLO, EXAMINING ATTORNEY

SN 78-758,008. BECKER-UNDERWOOD, INC., AMES, IA. FILED 11-21-2005.

RHIZO-FLO

THE MARK CONSISTS OF STANDARD CHARACTERS WITHOUT CLAIM TO ANY PARTICULAR FONT, STYLE, SIZE, OR COLOR.

OWNER OF U.S. REG. NOS. 1,790,009 AND 2,284,861.

FOR BIOLOGICAL AND CHEMICAL PREPARATIONS FOR USE IN AGRICULTURE, NAMELY INOCULANTS FOR USE IN THE TREATMENT OF AND APPLICATION WITH LEGUME SEEDS (U.S. CLS. 1, 5, 6, 10, 26 AND 46).

FIRST USE 2-28-2001; IN COMMERCE 2-28-2001.

TONI HICKEY, EXAMINING ATTORNEY

CLASS 1—(Continued).

SN 78-788,382. RUTHERFORD CHEMICALS LLC, BAYONNE, NJ. FILED 1-10-2006.

ZEPURE

THE MARK CONSISTS OF STANDARD CHARACTERS WITHOUT CLAIM TO ANY PARTICULAR FONT, STYLE, SIZE, OR COLOR.

FOR CHEMICALS, NAMELY, CETYL PYRIDINIUM CHLORIDE FOR USE AS AN ACTIVE PHARMACEUTICAL INGREDIENT, SURFACTANT, CHARGE MODIFIER, DONNING AGENT, PHASE TRANSFER AGENT, CATIONIC CONDITIONER, EMULSIFIER AND DETERGENT (U.S. CLS. 1, 5, 6, 10, 26 AND 46).

DOMINIC J. FERRAIUOLO, EXAMINING ATTORNEY

SN 78-791,120. L. BRUGGEMANN KG, D-74076 HEILBRONN, FED REP GERMANY, FILED 1-13-2006.

BruggemannChemical

THE MARK CONSISTS OF STANDARD CHARACTERS WITHOUT CLAIM TO ANY PARTICULAR FONT, STYLE, SIZE, OR COLOR.

OWNER OF U.S. REG. NO. 2,870,647.

SEC. 2(F).

FOR SPECIALTY CHEMICALS FOR USE IN THE MANUFACTURE OF A WIDE VARIETY OF GOODS (U.S. CLS. 1, 5, 6, 10, 26 AND 46).

FIRST USE 3-21-2001; IN COMMERCE 3-21-2001.

ALAIN LAPTEY, EXAMINING ATTORNEY

SN 78-831,205. DREXEL CHEMICAL COMPANY, MEMPHIS, TN. FILED 3-7-2006.



NO CLAIM IS MADE TO THE EXCLUSIVE RIGHT TO USE "BEAN OIL", APART FROM THE MARK AS SHOWN. THE COLORS GREEN AND YELLOW ARE CLAIMED AS FEATURES OF THE MARK.

THE MARK CONSISTS OF THE WORDS BEANOIL AND THE LETTER "O" IS IN THE DESIGN OF A BEAN. THE LETTERS "B", "E", "A", "N", "I", AND "L" ARE GREEN. THE BEAN DESIGN CONTAINS A GREEN CENTER SURROUNDED BY A YELLOW BACKGROUND AND BORDERED BY GREEN.

FOR SURFACTANTS FOR USE IN CONNECTION WITH AGRICULTURAL PESTICIDES (U.S. CLS. 1, 5, 6, 10, 26 AND 46).

FIRST USE 4-25-2006; IN COMMERCE 4-25-2006.

WENDY GOODMAN, EXAMINING ATTORNEY

CLASS 1—(Continued).

SN 78-832,673. ELKEM AS, OSLO, NORWAY, FILED 3-8-2006.

SIDISTAR

THE MARK CONSISTS OF STANDARD CHARACTERS WITHOUT CLAIM TO ANY PARTICULAR FONT, STYLE, SIZE, OR COLOR.

OWNER OF NORWAY REG. NO. 217238, DATED 1-16-2003, EXPIRES 7-16-2013.

FOR CHEMICALS, NAMELY, SILICA-BASED ADDITIVES FOR USE IN THE MANUFACTURE OF PAPER AND POLYMERS (U.S. CLS. 1, 5, 6, 10, 26 AND 46).

KATHERINE CONNOLLY, EXAMINING ATTORNEY

SN 78-836,698. AMERICAN GAS & CHEMICAL COMPANY, LTD., NORTHVALE, NJ. FILED 3-14-2006.

GAZ/TEC

THE MARK CONSISTS OF STANDARD CHARACTERS WITHOUT CLAIM TO ANY PARTICULAR FONT, STYLE, SIZE, OR COLOR.

OWNER OF U.S. REG. NO. 825,154, FOR LEAK DETECTION FLUID (U.S. CLS. 1, 5, 6, 10, 26 AND 46).

FIRST USE 0-0-1975; IN COMMERCE 0-0-1975.

SARAH WAYDA, EXAMINING ATTORNEY

SN 78-845,861. WANDELL INDUSTRIES, INC., CLINTON, WA. FILED 3-24-2006.

XR-88

THE MARK CONSISTS OF STANDARD CHARACTERS WITHOUT CLAIM TO ANY PARTICULAR FONT, STYLE, SIZE, OR COLOR.

FOR CHEMICALS FOR TREATING HAZARDOUS WASTE; CHEMICALS FOR USE IN THE DECONTAMINATION OF POLLUTED SITES; WASTE WATER TREATMENT CHEMICALS FOR INDUSTRIAL USE (U.S. CLS. 1, 5, 6, 10, 26 AND 46).

FRED CARL, EXAMINING ATTORNEY

CLASS 1—(Continued).

SN 78-850,525. ANGENIX LLC, CHICAGO, IL. FILED 3-30-2006.

ANGENIX

THE MARK CONSISTS OF STANDARD CHARACTERS WITHOUT CLAIM TO ANY PARTICULAR FONT, STYLE, SIZE, OR COLOR.

FOR CHEMICAL TEST KITS FOR DETECTION OF MICROBIOLOGICAL, VIRAL OR FUNGAL ORGANISMS FOR LABORATORY OR RESEARCH USE; CHEMICAL TEST PAPER; CHEMICALLY-TREATED NONMEDICAL TEST STRIPS FOR DETECTION OF MICROBIOLOGICAL, VIRAL OR FUNGAL ORGANISMS; TESTING KITS CONTAINING PEPTIDE SUBSTRATES USED IN ANALYZING AND DETECTING CERTAIN TOXINS FOR LABORATORY OR RESEARCH USE (U.S. CLS. 1, 5, 6, 10, 26 AND 46).

LA TONIA FISHER, EXAMINING ATTORNEY

SN 78-851,806. PHARMACHEM LABORATORIES, INC., KEARNY, NJ. FILED 3-31-2006.

SUPPRX

THE MARK CONSISTS OF STANDARD CHARACTERS WITHOUT CLAIM TO ANY PARTICULAR FONT, STYLE, SIZE, OR COLOR.

FOR CHEMICALS FOR USE IN THE MANUFACTURE OF NUTRITIONAL SUPPLEMENTS (U.S. CLS. 1, 5, 6, 10, 26 AND 46).

LANA PHAM, EXAMINING ATTORNEY

SN 78-853,846. RHODIA INC., CRANBURY, NJ. FILED 4-4-2006.

DERMALCARE

THE MARK CONSISTS OF STANDARD CHARACTERS WITHOUT CLAIM TO ANY PARTICULAR FONT, STYLE, SIZE, OR COLOR.

OWNER OF U.S. REG. NOS. 1,580,900 AND 2,338,368, FOR CHEMICALS AND CHEMICAL PREPARATIONS, NAMELY SURFACTANTS AND SURFACTANT COMBINATIONS EMPLOYED IN SHAMPOOS AND SKIN CLEANSERS (U.S. CLS. 1, 5, 6, 10, 26 AND 46).

FIRST USE 0-0-1984; IN COMMERCE 0-0-1984.

DOMINIC J. FERRAIUOLO, EXAMINING ATTORNEY

CLASS 1—(Continued).

SN 78-855,653. BAKER HUGHES INCORPORATED, HOUSTON, TX. FILED 4-6-2006.

DEEP SWEEP

THE MARK CONSISTS OF STANDARD CHARACTERS WITHOUT CLAIM TO ANY PARTICULAR FONT, STYLE, SIZE, OR COLOR.

FOR CHEMICAL ADDITIVES FOR WELL DRILLING FLUID, NAMELY, COARSE GROUND BARITE ADDITIVE FOR USE IN DRILLING FLUIDS (U.S. CLS. 1, 5, 6, 10, 26 AND 46).

FIRST USE 1-1-2004; IN COMMERCE 1-1-2004.
TINA BROWN, EXAMINING ATTORNEY

CLASS 1—(Continued).

SN 78-864,529. ROHM AND HAAS ELECTRONIC MATERIALS LLC, MARLBOROUGH, MA. FILED 4-19-2006.

ECOPOSIT

THE MARK CONSISTS OF STANDARD CHARACTERS WITHOUT CLAIM TO ANY PARTICULAR FONT, STYLE, SIZE, OR COLOR.

OWNER OF U.S. REG. NOS. 709,504, 2,730,526 AND OTHERS.

FOR CHEMICALS USED FOR METAL PLATING; CHEMICALS USED IN MANUFACTURE OF PRINTED CIRCUIT BOARDS, INTEGRATED CIRCUITS, SEMICONDUCTOR PACKAGES AND ELECTRONIC COMPONENTS (U.S. CLS. 1, 5, 6, 10, 26 AND 46).

FIRST USE 8-9-2005; IN COMMERCE 8-9-2005.
JASON BLAIR, EXAMINING ATTORNEY

SN 78-864,665. ROHM AND HAAS ELECTRONIC MATERIALS LLC, MARLBOROUGH, MA. FILED 4-19-2006.

CHROME GLEAM

THE MARK CONSISTS OF STANDARD CHARACTERS WITHOUT CLAIM TO ANY PARTICULAR FONT, STYLE, SIZE, OR COLOR.

OWNER OF U.S. REG. NO. 3,004,369.

NO CLAIM IS MADE TO THE EXCLUSIVE RIGHT TO USE "CHROME", APART FROM THE MARK AS SHOWN.

FOR CHEMICALS USED IN INDUSTRY; CHEMICALS USED IN MANUFACTURE OF PRINTED CIRCUIT BOARDS, INTEGRATED CIRCUITS, SEMICONDUCTOR PACKAGES AND ELECTRONIC COMPONENTS (U.S. CLS. 1, 5, 6, 10, 26 AND 46).

FIRST USE 5-3-2005; IN COMMERCE 5-3-2005.
JASON BLAIR, EXAMINING ATTORNEY

SN 78-864,679. ROHM AND HAAS ELECTRONIC MATERIALS LLC, MARLBOROUGH, MA. FILED 4-19-2006.

NICKEL GLEAM

THE MARK CONSISTS OF STANDARD CHARACTERS WITHOUT CLAIM TO ANY PARTICULAR FONT, STYLE, SIZE, OR COLOR.

OWNER OF U.S. REG. NO. 3,004,369.

NO CLAIM IS MADE TO THE EXCLUSIVE RIGHT TO USE "NICKEL", APART FROM THE MARK AS SHOWN.

FOR CHEMICALS USED IN INDUSTRY; CHEMICALS USED IN MANUFACTURE OF PRINTED CIRCUIT BOARDS, INTEGRATED CIRCUITS, SEMICONDUCTOR PACKAGES AND ELECTRONIC COMPONENTS (U.S. CLS. 1, 5, 6, 10, 26 AND 46).

FIRST USE 7-18-2002; IN COMMERCE 7-18-2002.
JASON BLAIR, EXAMINING ATTORNEY

SN 78-861,113. PLANT CARE SOLUTIONS, INC., LEBANON, PA. FILED 4-13-2006.

Spray N Bloom

THE MARK CONSISTS OF STANDARD CHARACTERS WITHOUT CLAIM TO ANY PARTICULAR FONT, STYLE, SIZE, OR COLOR.

FOR PLANT FOOD (U.S. CLS. 1, 5, 6, 10, 26 AND 46).
ROBERT STRUCK, EXAMINING ATTORNEY

SN 78-861,221. OSTARA NUTRIENT RECOVERY TECHNOLOGIES INC., VANCOUVER, B.C., CANADA, FILED 4-13-2006.

CRYSTAL GREEN

THE MARK CONSISTS OF STANDARD CHARACTERS WITHOUT CLAIM TO ANY PARTICULAR FONT, STYLE, SIZE, OR COLOR.

NO CLAIM IS MADE TO THE EXCLUSIVE RIGHT TO USE "CRYSTAL", APART FROM THE MARK AS SHOWN.
FOR FERTILIZERS (U.S. CLS. 1, 5, 6, 10, 26 AND 46).
JOHN GARTNER, EXAMINING ATTORNEY

CLASS 1—(Continued).

SN 78-864,812. PENFORD PRODUCTS CO., CEDAR RAPIDS, IA. FILED 4-19-2006.

PEN-BRITE

THE MARK CONSISTS OF STANDARD CHARACTERS WITHOUT CLAIM TO ANY PARTICULAR FONT, STYLE, SIZE, OR COLOR.

FOR CATIONIC STARCH ADDITIVE FOR USE IN THE MANUFACTURE OF PAPER AND PAPERBOARD (U.S. CLS. 1, 5, 6, 10, 26 AND 46).

TRACY CROSS, EXAMINING ATTORNEY

CLASS 1—(Continued).

SN 78-865,050. AGROFRESH INC., PHILADELPHIA, PA. FILED 4-19-2006.

LANDSPRING

THE MARK CONSISTS OF STANDARD CHARACTERS WITHOUT CLAIM TO ANY PARTICULAR FONT, STYLE, SIZE, OR COLOR.

FOR PLANT GROWTH REGULATING PREPARATIONS (U.S. CLS. 1, 5, 6, 10, 26 AND 46).

GINA FINK, EXAMINING ATTORNEY

SN 78-864,861. ADVANTIS TECHNOLOGIES, INC., ALPHARETTA, GA. FILED 4-19-2006.

Power Blast

THE MARK CONSISTS OF STANDARD CHARACTERS WITHOUT CLAIM TO ANY PARTICULAR FONT, STYLE, SIZE, OR COLOR.

FOR WATER TREATMENT CHEMICALS, NAMELY, A CHLORINE SHOCK FOR SWIMMING POOLS AND SPAS (U.S. CLS. 1, 5, 6, 10, 26 AND 46).

CIMMERIAN COLEMAN, EXAMINING ATTORNEY

SN 78-865,078. AGROFRESH INC., PHILADELPHIA, PA. FILED 4-19-2006.

HARVISTA

THE MARK CONSISTS OF STANDARD CHARACTERS WITHOUT CLAIM TO ANY PARTICULAR FONT, STYLE, SIZE, OR COLOR.

FOR PLANT GROWTH REGULATING PREPARATIONS (U.S. CLS. 1, 5, 6, 10, 26 AND 46).

GINA FINK, EXAMINING ATTORNEY

SN 78-865,040. AGROFRESH INC., PHILADELPHIA, PA. FILED 4-19-2006.

INVINSA

THE MARK CONSISTS OF STANDARD CHARACTERS WITHOUT CLAIM TO ANY PARTICULAR FONT, STYLE, SIZE, OR COLOR.

FOR PLANT GROWTH REGULATING PREPARATIONS (U.S. CLS. 1, 5, 6, 10, 26 AND 46).

GINA FINK, EXAMINING ATTORNEY

SN 78-865,186. AUTOICE, LLC, ARLINGTON, TX. FILED 4-19-2006.

AUTO ICE

THE MARK CONSISTS OF STANDARD CHARACTERS WITHOUT CLAIM TO ANY PARTICULAR FONT, STYLE, SIZE, OR COLOR.

FOR REFRIGERATION AND AIR CONDITIONING SYSTEM CHEMICAL ADDITIVES, NAMELY, REFRIGERANT COMPRESSOR OIL FOULING ELIMINATOR (U.S. CLS. 1, 5, 6, 10, 26 AND 46).

FIRST USE 3-15-2006; IN COMMERCE 3-15-2006.

DANIEL RUSSELL, EXAMINING ATTORNEY

CLASS 1—(Continued).

SN 78-865,254. SUN GRO HORTICULTURE CANADA LTD., SEBA BEACH, CANADA, FILED 4-19-2006.

TechniCote 

THE MARK CONSISTS OF THE WORD TECHNICOTE IN SCRIPT WITH THE SECOND "T" REPLACED BY A STYLIZED FLOWERPOT THAT CONTAINS A THREE LEAFED PLANT.

FOR CHEMICAL FERTILIZERS FOR AGRICULTURAL, DOMESTIC AND HORTICULTURAL USE (U.S. CLS. 1, 5, 6, 10, 26 AND 46).

FIRST USE 4-1-2004; IN COMMERCE 4-1-2004.
CIMMERIAN COLEMAN, EXAMINING ATTORNEY

CLASS 1—(Continued).

SN 78-869,970. LATTY, CATHY, THOUSAND OAKS, CA. FILED 4-26-2006.

FLEXFUEL BLENDING

THE MARK CONSISTS OF STANDARD CHARACTERS WITHOUT CLAIM TO ANY PARTICULAR FONT, STYLE, SIZE, OR COLOR.

FOR CHEMICAL ADDITIVES FOR FUEL TREATMENT; CHEMICAL ADDITIVES FOR USE WITH INTERNAL COMBUSTION ENGINE FUELS; CHEMICAL ENGINE TREATMENTS AND ADDITIVES FOR ENGINE OILS, GASOLINE AND DIESEL FUELS, TRANSMISSION FLUIDS AND COOLING SYSTEMS (U.S. CLS. 1, 5, 6, 10, 26 AND 46).

KEVON CHISOLM, EXAMINING ATTORNEY

SN 78-865,370. VISUAL ICE, INC., SAN CLEMENTE, CA. FILED 4-19-2006.

VISUAL ICE

THE MARK CONSISTS OF STANDARD CHARACTERS WITHOUT CLAIM TO ANY PARTICULAR FONT, STYLE, SIZE, OR COLOR.

FOR CHEMICAL COMPOSITIONS FOR CREATING GRAPHICS AND IMAGES ON GLASS AND OTHER TRANSPARENT SURFACES (U.S. CLS. 1, 5, 6, 10, 26 AND 46).

MARIA-VICTORIA SUAREZ, EXAMINING ATTORNEY

SN 78-870,324. SAN DIEGO INDUSTRIAL FLOORING, CHULA VISTA, CA. FILED 4-26-2006.

EuroCoat

THE MARK CONSISTS OF STANDARD CHARACTERS WITHOUT CLAIM TO ANY PARTICULAR FONT, STYLE, SIZE, OR COLOR.

FOR SYNTHETIC POLYMER MODIFIED RESIN COMPOUND FOR USE IN CEMENTITIOUS REPAIRS; SYNTHETIC RESINS THAT ARE USED TO REPAIR AND FILL HOLES AND CRACKS, ADHERE TO SURROUNDING MATERIALS AND SEAL SURFACES FOR USE IN HARSH ENVIRONMENTS; UNPROCESSED ACRYLIC RESINS FOR SURFACE COATING, RESTORATION, OR PROTECTION CONCRETE SLABS (U.S. CLS. 1, 5, 6, 10, 26 AND 46).

FIRST USE 3-6-2006; IN COMMERCE 3-6-2006.
JOANNA DUKOVIC, EXAMINING ATTORNEY

SN 78-866,028. SUN GRO HORTICULTURE CANADA LTD., SEBA BEACH ALBERTA T0E 2B0, CANADA, FILED 4-20-2006.

TECHNICOTE

THE MARK CONSISTS OF STANDARD CHARACTERS WITHOUT CLAIM TO ANY PARTICULAR FONT, STYLE, SIZE, OR COLOR.

FOR CHEMICAL FERTILIZERS FOR AGRICULTURAL, DOMESTIC AND HORTICULTURAL USE (U.S. CLS. 1, 5, 6, 10, 26 AND 46).

FIRST USE 4-1-2004; IN COMMERCE 4-1-2004.
CIMMERIAN COLEMAN, EXAMINING ATTORNEY

SN 78-890,166. BAKER HUGHES INCORPORATED, HOUSTON, TX. FILED 5-23-2006.

MILESTONE

THE MARK CONSISTS OF STANDARD CHARACTERS WITHOUT CLAIM TO ANY PARTICULAR FONT, STYLE, SIZE, OR COLOR.

FOR CHEMICALS AND CHEMICAL ADDITIVES USED TO CONTROL HEATER TUBE FOULING PROBLEMS IN REFINERY PROCESS UNITS (U.S. CLS. 1, 5, 6, 10, 26 AND 46).

TINA BROWN, EXAMINING ATTORNEY

CLASS 1—(Continued).

SN 78-911,581. SMARTPOOL INCORPORATED, LAKEWOOD, NJ. FILED 6-19-2006.

WINTERPILL

THE MARK CONSISTS OF STANDARD CHARACTERS WITHOUT CLAIM TO ANY PARTICULAR FONT, STYLE, SIZE, OR COLOR.

FOR WATER TREATMENT CHEMICALS FOR USE IN SWIMMING POOLS, SPAS AND HOT TUBS (U.S. CLS. 1, 5, 6, 10, 26 AND 46).

JIM RINGLE, EXAMINING ATTORNEY

SN 78-919,524. CIGARMONY LLC, POTOMAC FALLS, VA. FILED 6-29-2006.

Humidi-Beads

THE MARK CONSISTS OF STANDARD CHARACTERS WITHOUT CLAIM TO ANY PARTICULAR FONT, STYLE, SIZE, OR COLOR.

FOR COPOLYMER BEADS FOR USE IN MANUFACTURING; POLYMER BEADS FOR USE IN MANUFACTURING (U.S. CLS. 1, 5, 6, 10, 26 AND 46).

KATRINA EDGE, EXAMINING ATTORNEY

SN 78-921,329. SMARTPOOL INCORPORATED, LAKEWOOD, NJ. FILED 6-30-2006.

WinterBall

THE MARK CONSISTS OF STANDARD CHARACTERS WITHOUT CLAIM TO ANY PARTICULAR FONT, STYLE, SIZE, OR COLOR.

FOR WATER TREATMENT CHEMICALS FOR USE IN SWIMMING POOLS, SPAS AND HOT TUBS (U.S. CLS. 1, 5, 6, 10, 26 AND 46).

JIM RINGLE, EXAMINING ATTORNEY

CLASS 1—(Continued).

SN 78-921,334. SMARTPOOL INCORPORATED, LAKEWOOD, NJ. FILED 6-30-2006.

SpringBall

THE MARK CONSISTS OF STANDARD CHARACTERS WITHOUT CLAIM TO ANY PARTICULAR FONT, STYLE, SIZE, OR COLOR.

FOR WATER TREATMENT CHEMICALS FOR USE IN SWIMMING POOLS, SPAS AND HOT TUBS (U.S. CLS. 1, 5, 6, 10, 26 AND 46).

JIM RINGLE, EXAMINING ATTORNEY

SN 78-921,336. SMARTPOOL INCORPORATED, LAKEWOOD, NJ. FILED 6-30-2006.

SolarBall

THE MARK CONSISTS OF STANDARD CHARACTERS WITHOUT CLAIM TO ANY PARTICULAR FONT, STYLE, SIZE, OR COLOR.

FOR WATER TREATMENT CHEMICALS FOR USE IN SWIMMING POOLS, SPAS AND HOT TUBS (U.S. CLS. 1, 5, 6, 10, 26 AND 46).

JIM RINGLE, EXAMINING ATTORNEY

CLASS 2—PAINTS

SN 76-656,572. SPRAY NINE CORPORATION, JOHNSTOWN, NY. FILED 3-14-2006.

VINYL SHIELD

THE MARK CONSISTS OF STANDARD CHARACTERS WITHOUT CLAIM TO ANY PARTICULAR FONT, STYLE, SIZE, OR COLOR.

NO CLAIM IS MADE TO THE EXCLUSIVE RIGHT TO USE "VINYL", APART FROM THE MARK AS SHOWN.

FOR WATER REPELLANT SILICONE CREME PROTECTANT IN THE NATURE OF A COATING FOR RESTORING GLOSS TO VINYL, RUBBER, PLASTIC, LEATHER, WOOD AND ACRYLIC SURFACES (U.S. CLS. 6, 11 AND 16).

FIRST USE 9-13-1982; IN COMMERCE 9-21-1982.

KEVIN DINALLO, EXAMINING ATTORNEY

CLASS 2—(Continued).

SN 76-658,978. CIBA SPECIALTY CHEMICAL CORPORATION, TARRYTOWN, NY. FILED 4-18-2006.

FILAMID

THE MARK CONSISTS OF STANDARD CHARACTERS WITHOUT CLAIM TO ANY PARTICULAR FONT, STYLE, SIZE, OR COLOR.

FOR PIGMENTS FOR INDUSTRIAL USE (U.S. CLS. 6, 11 AND 16).

FIRST USE 2-7-1975; IN COMMERCE 2-7-1975.

JULIE GUTTADAURO, EXAMINING ATTORNEY

SN 78-452,131. RPM WOOD FINISHES GROUP INC., HICKORY, NC. FILED 7-16-2004.

DURACOAT

THE MARK CONSISTS OF STANDARD CHARACTERS WITHOUT CLAIM TO ANY PARTICULAR FONT, STYLE, SIZE, OR COLOR.

FOR WOOD FINISHING PRODUCTS, NAMELY TOP-COATS FOR USE AS SURFACE INTERIOR FINISHES FOR CABINETRY, ARCHITECTURAL MILLWORK AND FINE FURNITURE, NAMELY, SEALERS AND LACQUERS (U.S. CLS. 6, 11 AND 16).

FIRST USE 2-0-2004; IN COMMERCE 2-0-2004.

JERI J. FICKES, EXAMINING ATTORNEY

SN 78-624,708. ENVIRONMENTAL SPECIALITIES, INC., CHICAGO, IL. FILED 5-6-2005.

EFFECT VARNISH

THE MARK CONSISTS OF STANDARD CHARACTERS WITHOUT CLAIM TO ANY PARTICULAR FONT, STYLE, SIZE, OR COLOR.

NO CLAIM IS MADE TO THE EXCLUSIVE RIGHT TO USE "VARNISH", APART FROM THE MARK AS SHOWN.

FOR VARNISH (U.S. CLS. 6, 11 AND 16).

FIRST USE 10-2-2003; IN COMMERCE 10-2-2003.

AMY MCMENAMIN, EXAMINING ATTORNEY

CLASS 2—(Continued).

SN 78-718,670. LUPOWITZ, JULIUS, HICKSVILLE, NY. FILED 9-22-2005.

Hammerhead

THE MARK CONSISTS OF STANDARD CHARACTERS WITHOUT CLAIM TO ANY PARTICULAR FONT, STYLE, SIZE, OR COLOR.

FOR COATING PROTECTANT FOR VEHICLES, SPECIFICALLY, COATING TO FORM A LINING MATERIAL PRIMARILY USED AS TRUCK AND OTHER VEHICLE BED LINER; PROTECTIVE COATING FOR VARIOUS SURFACES, NAMELY, METAL, WOOD, CEMENT, CERAMIC, AND FIBERGLASS, FOR USE AS A MOISTURE BARRIER; PROTECTIVE COATING IN THE NATURE OF FINISHES FOR VARIOUS SURFACES, NAMELY, METAL, WOOD, CEMENT, CERAMIC, AND FIBERGLASS; NON-SLIP SURFACE COATING FOR VARIOUS INDOOR AND OUTDOOR SURFACES, NAMELY, METAL, WOOD, CEMENT, CERAMIC, AND FIBERGLASS (U.S. CLS. 6, 11 AND 16).

JOHN SCHUYLER YARD, EXAMINING ATTORNEY

SN 78-718,708. LUPOWITZ, JULIUS, HICKSVILLE, NY. FILED 9-22-2005.

Clearline

THE MARK CONSISTS OF STANDARD CHARACTERS WITHOUT CLAIM TO ANY PARTICULAR FONT, STYLE, SIZE, OR COLOR.

FOR COATINGS IN THE NATURE OF PROTECTIVE VEHICLE FINISHES FOR TRUCK AND VEHICLE BED LINERS; COATINGS IN THE NATURE OF NON-STICK STAINS AND CLEAR FINISHES; NON-SLIP SURFACE COATING FOR SLIP PROOFING OF INDOOR AND OUTDOOR SURFACES SUCH AS SHOP FLOORS, SIDEWALKS, WALKWAYS, LOADING DOCKS; PROTECTIVE COATING IN THE NATURE OF FINISHES FOR METAL, WOOD, CEMENT, CERAMIC, AND FIBERGLASS WHICH PROVIDES A DECORATIVE APPEARANCE (U.S. CLS. 6, 11 AND 16).

CHARLES L. JENKINS, EXAMINING ATTORNEY

CLASS 2—(Continued).

SN 78-733,662. SIGMA COATINGS B.V., AD UITHOORN, NETHERLANDS, FILED 10-14-2005.

SIGMAGLIDE

THE MARK CONSISTS OF STANDARD CHARACTERS WITHOUT CLAIM TO ANY PARTICULAR FONT, STYLE, SIZE, OR COLOR.

OWNER OF U.S. REG. NOS. 1,040,363, 3,020,892 AND OTHERS.

FOR ANTIFOULING PAINTS AND COATINGS, NAMELY, PAINTS AND COATINGS FOR PROTECTING BOATS AGAINST MINERAL, ANIMAL AND PLANT ORGANISMS AND MICRO-ORGANISMS; ANTIFOULING CONTROL PRIMER (U.S. CLS. 6, 11 AND 16).

FIRST USE 10-1-1998; IN COMMERCE 10-1-1998.

MICHAEL KEATING, EXAMINING ATTORNEY

CLASS 2—(Continued).

SN 78-856,869. AEGIS INDUSTRIES, INC., SANTA MARIA, CA. FILED 4-7-2006.



THE MARK CONSISTS OF TWO KOI FISH CIRCLING IN A BACKGROUND LOOSELY EVOKING A CLASSICAL GREEK SHIELD.

FOR PROTECTANT COATINGS USED FOR LINING INTERIOR SURFACES OF ARTIFICIAL SWIMMING POOLS, WADING POOLS, SPAS, PONDS, TANKS, FOUNTAINS, WATERFALLS AND OTHER WATER GARDENS (U.S. CLS. 6, 11 AND 16).

FIRST USE 3-1-2005; IN COMMERCE 3-1-2005.

MICHAEL WEBSTER, EXAMINING ATTORNEY

SN 78-761,286. ROLAND DG CORPORATION, SHIZUOKA-KEN, JAPAN, FILED 11-28-2005.

EcoXtreme

THE MARK CONSISTS OF STANDARD CHARACTERS WITHOUT CLAIM TO ANY PARTICULAR FONT, STYLE, SIZE, OR COLOR.

PRIORITY CLAIMED UNDER SEC. 44(D) ON JAPAN APPLICATION NO. 2005-104427, FILED 11-8-2005, REG. NO. 4959357, DATED 6-9-2006, EXPIRES 6-9-2016.

FOR INK JET PRINTER INK; INK JET CARTRIDGES FULL OF INK; AND PRINTERS' INK (U.S. CLS. 6, 11 AND 16).

ELLEN PERKINS, EXAMINING ATTORNEY

SN 78-862,480. METAL SALES MANUFACTURING CORPORATION, SELLERSBURG, IN. FILED 4-17-2006.

MS COLORFAST 45

SN 78-841,820. ZDYE, LLC, GALLATIN GATEWAY, MT. FILED 3-20-2006.

ZDYE

THE MARK CONSISTS OF STANDARD CHARACTERS WITHOUT CLAIM TO ANY PARTICULAR FONT, STYLE, SIZE, OR COLOR.

FOR CHEMICALLY SYNTHESIZED, FLUORESCENT DYES WITH PROPERTIES OPTIMIZED FOR PROTEIN DETECTION IN PROTEOMICS (U.S. CLS. 6, 11 AND 16).

KATHERINE STOIDES, EXAMINING ATTORNEY

THE MARK CONSISTS OF STANDARD CHARACTERS WITHOUT CLAIM TO ANY PARTICULAR FONT, STYLE, SIZE, OR COLOR.

NO CLAIM IS MADE TO THE EXCLUSIVE RIGHT TO USE "COLORFAST", APART FROM THE MARK AS SHOWN.

FOR COATINGS IN THE NATURE OF A PAINT FOR METAL BUILDING COMPONENTS, NAMELY ROOF AND WALL PANELS (U.S. CLS. 6, 11 AND 16).

FIRST USE 10-4-2005; IN COMMERCE 10-4-2005.

JENNIFER MARTIN, EXAMINING ATTORNEY

CLASS 2—(Continued).

SN 78-863,708. PETERS, STEVE L., BEND, OR. FILED 4-18-2006.

Anger Management for Printers

THE MARK CONSISTS OF STANDARD CHARACTERS WITHOUT CLAIM TO ANY PARTICULAR FONT, STYLE, SIZE, OR COLOR.

FOR INK JET PRINTER INK; METAL IN FOIL AND POWDER FORM FOR PAINTERS, DECORATORS, PRINTERS AND ARTISTS; METALS IN FOIL AND POWDER FORM FOR PAINTERS, DECORATORS, PRINTERS AND ARTISTS (U.S. CLS. 6, 11 AND 16).

FIRST USE 2-3-2006; IN COMMERCE 2-11-2006.

NORA BUCHANAN WILL, EXAMINING ATTORNEY

SN 78-867,079. DEGUSSA BUILDING SYSTEMS, INC., SHAKOPEE, MN. FILED 4-21-2006.

PARKCOAT

THE MARK CONSISTS OF STANDARD CHARACTERS WITHOUT CLAIM TO ANY PARTICULAR FONT, STYLE, SIZE, OR COLOR.

FOR ACRYLIC COATING WITH A HIGH LIGHT REFLECTANCE RATING FOR USE ON WALLS AND CEILINGS OF POORLY LIT AREAS FOR ADDED LIGHT AND SECURITY (U.S. CLS. 6, 11 AND 16).

FIRST USE 1-5-1995; IN COMMERCE 1-5-1995.

WENDY GOODMAN, EXAMINING ATTORNEY

SN 78-892,819. SHARP KABUSHIKI KAISHA, TA SHARP CORPORATION, OSAKA, JAPAN, FILED 5-25-2006.

MYCROSTONER-HG

THE MARK CONSISTS OF STANDARD CHARACTERS WITHOUT CLAIM TO ANY PARTICULAR FONT, STYLE, SIZE, OR COLOR.

FOR TONER AND TONER CARTRIDGES FOR COPYING MACHINES, PRINTERS, FACSIMILES AND COMBINATION OF SUCH PRODUCTS (U.S. CLS. 6, 11 AND 16).

SKYE YOUNG, EXAMINING ATTORNEY

CLASS 3—COSMETICS AND CLEANING PREPARATIONS

SN 76-617,465. LANCOME PARFUMS ET BEAUTE & CIE, PARIS, FRANCE, FILED 10-25-2004.

ROUGE CULTE

THE MARK CONSISTS OF STANDARD CHARACTERS WITHOUT CLAIM TO ANY PARTICULAR FONT, STYLE, SIZE, OR COLOR.

PRIORITY CLAIMED UNDER SEC. 44(D) ON ERPNCMNTY TM OFC APPLICATION NO. 4,064,937, FILED 10-13-2004, REG. NO. 4,064,937, DATED 1-16-2006, EXPIRES 10-13-2014.

NO CLAIM IS MADE TO THE EXCLUSIVE RIGHT TO USE "ROUGE", APART FROM THE MARK AS SHOWN.

THE FOREIGN WORDING IN THE MARK TRANSLATES INTO ENGLISH AS "CULT" OR "WORSHIP."

FOR LIPSTICKS (U.S. CLS. 1, 4, 6, 50, 51 AND 52).

TARAH HARDY, EXAMINING ATTORNEY

SN 76-617,684. ALLEGHANY PHARMACAL CORPORATION, GREAT NECK, NY. FILED 10-25-2004.

DIAMOND GIRL

THE MARK CONSISTS OF STANDARD CHARACTERS WITHOUT CLAIM TO ANY PARTICULAR FONT, STYLE, SIZE, OR COLOR.

FOR HAIR STYLING, CONDITIONING AND RELAXING PREPARATIONS FOR HUMAN HAIR (U.S. CLS. 1, 4, 6, 50, 51 AND 52).

FIRST USE 7-15-1997; IN COMMERCE 7-15-1997.

KAREN K. BUSH, EXAMINING ATTORNEY

SN 76-641,138. ROBERTS, JAMES D., NORTH VANCOUVER, BRITISH COLUMBIA, CANADA, FILED 6-14-2005.

NELLIE'S DRYERBALLS

NO CLAIM IS MADE TO THE EXCLUSIVE RIGHT TO USE "DRYERBALLS", APART FROM THE MARK AS SHOWN.

FOR FABRIC SOFTENERS FOR LAUNDRY USE (U.S. CLS. 1, 4, 6, 50, 51 AND 52).

FIRST USE 3-10-2005; IN COMMERCE 3-10-2005.

BARBARA A. GOLD, EXAMINING ATTORNEY

CLASS 3—(Continued).

SN 76-651,027. GABRIEL FIRST CORPORATION, EAST ROCHESTER, NY. FILED 11-29-2005.

COURT MATE

THE MARK CONSISTS OF STANDARD CHARACTERS WITHOUT CLAIM TO ANY PARTICULAR FONT, STYLE, SIZE, OR COLOR.

NO CLAIM IS MADE TO THE EXCLUSIVE RIGHT TO USE "COURT", APART FROM THE MARK AS SHOWN.

FOR FLOOR POLISH (U.S. CLS. 1, 4, 6, 50, 51 AND 52). FIRST USE 9-8-2004; IN COMMERCE 5-5-2005.

SHARI SHEFFIELD, EXAMINING ATTORNEY

SN 76-656,194. DBD DESIGN, INC., MANCHESTER CENTER, VT. FILED 3-7-2006.

izurelli

FOR ANTI-AGING AND SKIN CARE PRODUCTS, NAMELY, CLEANSING CREAMS, FACIAL SCRUBS, SOAPS, FACIAL MASKS, TONERS, CONDITIONERS, FACE POWDERS, LOTIONS FOR FACE, SKIN MOISTURIZERS AND BODY SCRUBS; MASSAGE CREAMS AND OILS, FACIAL WASH AND BEAUTY GELS, AND AROMATHERAPY OILS; SUNSCREENS AND SUN BLOCK PREPARATIONS; COSMETICS, NAMELY, MAKE-UP, SKIN CONCEALER, BLUSH, EYE LINER, EYE SHADOW, MASCARA, EYEBROW PENCIL AND FACE POWDER; FACE CARE PRODUCTS, NAMELY, BEAUTY MASKS, PRE-MOISTENED COSMETIC TOWELETTES, AND EYE PADS, NAMELY, EYE COMPRESSES FOR COSMETIC PURPOSES (U.S. CLS. 1, 4, 6, 50, 51 AND 52).

JESSICA A. POWERS, EXAMINING ATTORNEY

SN 76-657,574. BELLASKIN INC., BOCA RATON, FL. FILED 3-30-2006.

BELLASKIN'S COLLECTION

THE MARK CONSISTS OF STANDARD CHARACTERS WITHOUT CLAIM TO ANY PARTICULAR FONT, STYLE, SIZE, OR COLOR.

NO CLAIM IS MADE TO THE EXCLUSIVE RIGHT TO USE "COLLECTION", APART FROM THE MARK AS SHOWN.

FOR FACE LOTIONS; BODY LOTIONS; SKIN MOISTURIZERS; NON-MEDICATED SKIN GELS; AND SKIN-CARE PRODUCTS, NAMELY, NON-MEDICATED SKIN SERUMS (U.S. CLS. 1, 4, 6, 50, 51 AND 52).

FIRST USE 3-6-2006; IN COMMERCE 3-6-2006.

GILBERT SWIFT, EXAMINING ATTORNEY

CLASS 3—(Continued).

SN 76-658,194. HOFFMAN, LISA, LOS ANGELES, CA. FILED 4-11-2006.

**LISA HOFFMAN
NIGHT & DAY**

THE MARK CONSISTS OF STANDARD CHARACTERS WITHOUT CLAIM TO ANY PARTICULAR FONT, STYLE, SIZE, OR COLOR.

THE NAME LISA HOFFMAN IDENTIFIES A LIVING INDIVIDUAL WHOSE CONSENT IS MADE OF RECORD.

FOR NON-MEDICATED SKIN CARE PREPARATIONS; FACIAL CLEANSERS; TONERS; FACIAL MOISTURIZERS; FACE HYDRATORS; EYE CREAMS; LIP BALMS; LIP MOISTURIZERS; FACIAL SCRUBS; FACIAL MASKS; BODY CLEANSERS, BODY MOISTURIZERS; BODY OILS; BODY MISTS; BODY SPLASHES; HAND CREAMS; NON-MEDICATED BODY CARE PREPARATIONS; SHAMPOOS; HAIR CONDITIONERS; HAIR CARE PREPARATIONS; SHOWER GELS; BODY LOTIONS; BODY CREAMS; AND MAKEUP REMOVERS (U.S. CLS. 1, 4, 6, 50, 51 AND 52).

MICHAEL LEWIS, EXAMINING ATTORNEY

SN 78-215,125. AVON PRODUCTS, INC., NEW YORK, NY. FILED 2-14-2003.

HOOK UP

FOR COSMETICS, NAMELY, LIP GLOSS, MASCARA, CONCEALER, EYE LINER AND FACIAL POWDER (U.S. CLS. 1, 4, 6, 50, 51 AND 52).

CHERYL CLAYTON, EXAMINING ATTORNEY

SN 78-236,608. AWESOME KIDS, LLC, WHEATON, IL. FILED 4-11-2003.

AWESOME BOYS

NO CLAIM IS MADE TO THE EXCLUSIVE RIGHT TO USE "BOYS", APART FROM THE MARK AS SHOWN.

FOR COSMETICS AND SKIN CARE PREPARATIONS NAMELY, FACE, BODY, HAND AND FOOT MOISTURIZERS; FACE, BODY, HAND AND FOOT SCRUBS; FACE, BODY, HAND, AND FOOT TONERS; FACE, BODY, HAND, AND FOOT ASTRINGENTS; POWDERS FOR THE FACE, BODY AND HANDS; AFTER SHOWER SKIN LOTIONS; SKIN CLEANSERS, NAIL POLISH, NAIL POLISH REMOVER; HAND SOAP, BODY SOAP, FACE SOAP, PERFUME, COLOGNE, EAU DE TOILETTE; MASCARA, BLUSH, EYE SHADOW, LIP STICK, LIP GLOSS, MAKE-UP, MAKE-UP REMOVER, EYE CREAM, SHAVING CREAMS, SHAVING GELS, AFTER SHAVE LOTIONS AND GELS; DEODORANTS AND ANTIPERSPIRANTS FOR PERSONAL USE; SKIN LOTIONS; ESSENTIAL OILS FOR PERSONAL USE; SUN-TANNING PREPARATIONS, SUN SCREEN PREPARATIONS, SUN BLOCK PREPARATIONS; HAIR CARE AND STYLING PREPARATIONS NAMELY, SHAMPOOS, CONDITIONERS, SPRAYS, GELS, MOUSSES AND TONICS; BATH PRODUCTS NAMELY, BATH SALTS, BATH CRYSTALS, BATH OILS, BATH BEADS, BATH GELS, BUBBLE BATH (U.S. CLS. 1, 4, 6, 50, 51 AND 52).

NANCY CLARKE, EXAMINING ATTORNEY

CLASS 3—(Continued).

SN 78-242,885. YOUNG C. KANG, SPRINGFIELD, VA.
FILED 4-28-2003.

MOUNTAIN GINSENG

NO CLAIM IS MADE TO THE EXCLUSIVE RIGHT TO
USE GINSENG, APART FROM THE MARK AS SHOWN.
FOR COSMETICS (U.S. CLS. 1, 4, 6, 50, 51 AND 52).
FIRST USE 2-15-2004; IN COMMERCE 2-15-2004.
ANNE MADDEN, EXAMINING ATTORNEY

SN 78-418,775. BEAUTYBANK INC., NEW YORK, NY.
FILED 5-14-2004.

CREAM, PLEASE

THE MARK CONSISTS OF STANDARD CHARACTERS
WITHOUT CLAIM TO ANY PARTICULAR FONT, STYLE,
SIZE, OR COLOR.

NO CLAIM IS MADE TO THE EXCLUSIVE RIGHT TO
USE CREAM, APART FROM THE MARK AS SHOWN.

FOR COSMETICS; NON-MEDICATED SKINCARE
PREPARATIONS; HAIRCARE PREPARATIONS; TOILE-
TRIES, NAMELY BATH AND BODY SOAPS, FACIAL
AND SKIN CLEANSERS, BATH GELS, FACE AND
BODY LOTIONS, FACE AND BODY CREAMS AND
BODY SPRAYS; FRAGRANCES FOR PERSONAL USE;
NON-MEDICATED SUNCARE PREPARATIONS (U.S.
CLS. 1, 4, 6, 50, 51 AND 52).

FIRST USE 7-24-2005; IN COMMERCE 7-24-2005.
KATHLEEN M. VANSTON, EXAMINING ATTORNEY

SN 78-469,295. MEI-CHA INTERNATIONAL, INC., TUSTIN,
CA. FILED 8-18-2004.



THE PORTRAIT SHOWN IN THE MARK DEPICTS A
NON-LIVING INDIVIDUAL.

FOR COSMETICS, NAMELY, FOUNDATION, EYE-
SHADOWS, CHEEK BLUSH, LIPSTICKS, EYEBROW
PENCILS, AND SEMI-PERMANENT COSMETIC PENS
(U.S. CLS. 1, 4, 6, 50, 51 AND 52).

FIRST USE 4-1-1994; IN COMMERCE 4-1-1994.
STEVEN PEREZ, EXAMINING ATTORNEY

CLASS 3—(Continued).

SN 78-535,296. BEAUTY HOLDING COMPANY, INC., HA-
MILTON, BERMUDA, FILED 12-20-2004.

MAD MUD

THE MARK CONSISTS OF STANDARD CHARACTERS
WITHOUT CLAIM TO ANY PARTICULAR FONT, STYLE,
SIZE, OR COLOR.

NO CLAIM IS MADE TO THE EXCLUSIVE RIGHT TO
USE "MUD", APART FROM THE MARK AS SHOWN.

FOR HAIR CARE PREPARATIONS (U.S. CLS. 1, 4, 6,
50, 51 AND 52).

FIRST USE 11-0-2003; IN COMMERCE 11-0-2003.
NANCY CLARKE, EXAMINING ATTORNEY

SN 78-555,267. LORIS AZZARO B.V., 7336 AZ APELDOORN,
NETHERLANDS, FILED 1-27-2005.



OWNER OF U.S. REG. NOS. 1,472,770, 2,799,106 AND
OTHERS.

NO CLAIM IS MADE TO THE EXCLUSIVE RIGHT TO
USE POUR HOMME, APART FROM THE MARK AS
SHOWN.

THE ENGLISH TRANSLATION OF THE WORD POUR
HOMME IN THE MARK IS FOR MEN.

FOR PERFUME, PERFUME WATER, EAU DE TOIL-
LETTE, EAU DE COLOGNE, PRE-SHAVE LOTION, PRE-
SHAVE CREAM, PRE-SHAVE BALM, AFTERSHAVE
LOTION, AFTERSHAVE BALM, SHAVING FOAM,
SHAVING CREAM, SHAVING BALM, SHAVING GEL,
NON-MEDICAL BATH AND SHOWER PRODUCTS,
NAMELY BATH OIL AND BATH AND SHOWER FOAM
AND GEL, BATH SALT, BATH LOTION, SHOWER GEL;
HAIR AND BODY SHAMPOO; DEODORANTS FOR
PERSONAL USE; SKIN CREAM, PERFUMED SOAP,
BATH SOAP; PERFUMED TALCUM POWDER, PER-
FUMED CREAM, HAIR LOTION (U.S. CLS. 1, 4, 6, 50,
51 AND 52).

JENNIFER DIXON, EXAMINING ATTORNEY

CLASS 3—(Continued).

SN 78-611,721. LIN, HUI, SHENZHEN, CHINA, AND LIM, CHWON ANG, HONG KONG, HONG KONG, FILED 4-19-2005.

KOSMO

THE MARK CONSISTS OF STANDARD CHARACTERS WITHOUT CLAIM TO ANY PARTICULAR FONT, STYLE, SIZE, OR COLOR.

FOR COSMETICS; COSMETIC CREAMS; BODY LOTIONS; OILS FOR COSMETIC PURPOSES; COSMETIC PREPARATIONS FOR SKIN RENEWAL; SKIN WHITENING CREAMS; BEAUTY MASKS; MAKE-UP; MAKE-UP POWDERS; MAKE-UP REMOVING PREPARATIONS; COSMETIC SUN-TANNING PREPARATIONS; SUN-TANNING CREAMS AND OILS; SUNSCREEN PREPARATIONS; LIPSTICKS; EYEBROW COSMETICS; EYEBROW PENCILS; COSMETIC PENCILS; COSMETIC PREPARATIONS FOR SLIMMING PURPOSES, NAMELY CREAMS AND LOTIONS FOR CELLULITE REDUCTION; MASCARA; ESSENTIAL OILS FOR PERSONAL USE; PERFUMES; PERFUMERY; NON-MEDICATED TOILETRIES; HAIR COLORANTS, HAIR WAVING PREPARATIONS, HAIR SPRAYS; HAIR LOTIONS; ALL PURPOSE CLEANING PREPARATIONS; COSMETICS KITS CONTAINING BLUSHES AND BRUSHES; SOAPS; SHOWER GELS; DENTIFRICES; TOOTHPASTE AND MOUTH WASH (U.S. CLS. 1, 4, 6, 50, 51 AND 52).

COLLEEN KEARNEY, EXAMINING ATTORNEY

SN 78-652,000. ALICE AND LAW CO., LTD., HONG KONG, CHINA, FILED 6-16-2005.

LAUNDRY BALL

THE MARK CONSISTS OF STANDARD CHARACTERS WITHOUT CLAIM TO ANY PARTICULAR FONT, STYLE, SIZE, OR COLOR.

NO CLAIM IS MADE TO THE EXCLUSIVE RIGHT TO USE "LAUNDRY", APART FROM THE MARK AS SHOWN.

FOR SOAPS, BATH LOTIONS, BATH CREAM, BATH BEADS, BATH SALT, BATH OIL, AND LAUNDRY PREPARATIONS, NAMELY, BLEACHES, SOAPS AND DETERGENTS (U.S. CLS. 1, 4, 6, 50, 51 AND 52).

TIMOTHY FINNEGAN, EXAMINING ATTORNEY

CLASS 3—(Continued).

SN 78-660,465. BOYD'S MADISON AVENUE DEPT. STORE, INC., NEW YORK, NY. FILED 6-29-2005.

BOYD'S BABES

THE MARK CONSISTS OF STANDARD CHARACTERS WITHOUT CLAIM TO ANY PARTICULAR FONT, STYLE, SIZE, OR COLOR.

OWNER OF U.S. REG. NOS. 1,840,234 AND 1,843,285.

FOR DEODORANT SOAPS, SKIN BRONZING GEL FOR ACCELERATING, ENHANCING OR EXTENDING TANS, HERBAL EYE PADS FOR SOOTHING AND DECREASING SWELLING OF EYELIDS, GENERAL PURPOSE SCOURING POWDER, SKIN CREAM, ESSENTIAL OILS FOR PERSONAL USE, ESSENTIAL OILS FOR USE IN THE MANUFACTURING OF COSMETICS, PERSONAL DEODORANTS, DEODORANT ANTIPERSPIRANTS, ARTIFICIAL EYELASHES AND REMOVER SOLD AS A UNIT, LIPSTICK, LIP GLOSS, EYE LINER, EYE SHADOW, ROUGE, BODY POWDER, NON-MEDICATED BLEMISH COVER-UP CREAM, MASCARA, MASCARA REMOVER, EYE LINER LIQUID, EYE LINER SEALER, MOISTURIZER SKIN CREAM, EYEBROW PENCILS, BATH OILS, BODY OILS, HAIR LOTIONS (U.S. CLS. 1, 4, 6, 50, 51 AND 52).

MICHAEL LEWIS, EXAMINING ATTORNEY

SN 78-660,484. BOYD'S MADISON AVENUE DEPT. STORE, INC., NEW YORK, NY. FILED 6-29-2005.

OWNER OF U.S. REG. NOS. 1,840,234 AND 1,843,285.

THE MARK CONSISTS OF THE WORDS BOYD WITH A STYLIZED DEPICTION OF A PAINTBRUSH THAT REPRESENTS THE LETTER "Y" AND DIRECTLY BELOW IS THE STYLIZED WORD BABES.

FOR DEODORANT SOAPS, SKIN BRONZING GEL FOR ACCELERATING, ENHANCING OR EXTENDING TANS, HERBAL EYE PADS FOR SOOTHING AND DECREASING SWELLING OF EYELIDS, GENERAL PURPOSE SCOURING POWDER, SKIN CREAM, ESSENTIAL OILS FOR PERSONAL USE, ESSENTIAL OILS FOR USE IN THE MANUFACTURING OF COSMETICS, PERSONAL DEODORANTS, DEODORANT ANTIPERSPIRANTS, ARTIFICIAL EYELASHES AND REMOVER SOLD AS A UNIT, LIPSTICK, LIP GLOSS, EYE LINER, EYE SHADOW, ROUGE, BODY POWDER, NON-MEDICATED BLEMISH COVER-UP CREAM, MASCARA, MASCARA REMOVER, EYE LINER LIQUID, EYE LINER SEALER, MOISTURIZER SKIN CREAM, EYEBROW PENCILS, BATH OILS, BODY OILS, HAIR LOTIONS (U.S. CLS. 1, 4, 6, 50, 51 AND 52).

MICHAEL LEWIS, EXAMINING ATTORNEY

CLASS 3—(Continued).

SN 78-672,077. PYRAMID PUBLISHING & PRODUCTIONS, INC., CHICAGO, IL. FILED 7-17-2005.

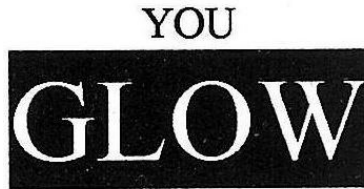

NO CLAIM IS MADE TO THE EXCLUSIVE RIGHT TO USE "GLOW", APART FROM THE MARK AS SHOWN.
FOR COSMETICS, NAMELY; NAIL POLISH, LIP-STICK, MASCARA, EYELINER, FOUNDATION, SKIN POWDER, HAIR SPRAY, PERFUME, LIP LINER, EYE PENCIL, BLUSH, LIP GLOSS, EYE SHADOW, ROUGE AND SKIN LOTION (U.S. CLS. 1, 4, 6, 50, 51 AND 52).
STEVEN R. FINE, EXAMINING ATTORNEY

SN 78-678,095. BLAKE, WAYNE, D, MIAMI, FL. FILED 7-26-2005.



NO CLAIM IS MADE TO THE EXCLUSIVE RIGHT TO USE "BOTANICAL", APART FROM THE MARK AS SHOWN.

THE COLOR(S) BLACK, WHITE, GREEN, YELLOW, AND RED IS/ARE CLAIMED AS A FEATURE OF THE MARK.

THE MARK CONSISTS OF A CIRCLE WITH BLACK BORDER AND GRADIENT STARTING IN LOWER RIGHT WITH RED, THEN YELLOW AND ENDING WITH GREEN IN UPPER LEFT. SUPERIMPOSED IS A SYMBOL IN BLACK, OUTLINED IN WHITE, OF TWO LIZARDS CROSSING TO FORM THE SHAPE OF A CROSS. BENEATH THE DESIGN IS THE WORDING BOTANICAL ROOTS - ONE MIND, ONE BODY, ONE SPIRIT - IN BLACK.

FOR SHAMPOOS, HAIR CONDITIONERS, SKIN LOTIONS, BODY SPRAYS, FACIAL CLEANSERS, BODY CREAMS, NON-MEDICATED SKIN CARE PREPARATIONS (U.S. CLS. 1, 4, 6, 50, 51 AND 52).

DEBRA LEE, EXAMINING ATTORNEY

CLASS 3—(Continued).

SN 78-678,774. LUSTER PRODUCTS, INC., CHICAGO, IL. FILED 7-26-2005.

REJUVA-SHINE POLISHER

THE MARK CONSISTS OF STANDARD CHARACTERS WITHOUT CLAIM TO ANY PARTICULAR FONT, STYLE, SIZE, OR COLOR.

OWNER OF U.S. REG. NO. 2,270,431.

NO CLAIM IS MADE TO THE EXCLUSIVE RIGHT TO USE 'POLISHER', APART FROM THE MARK AS SHOWN.

FOR NON-MEDICATED HAIR CARE PREPARATIONS (U.S. CLS. 1, 4, 6, 50, 51 AND 52).

TONI HICKEY, EXAMINING ATTORNEY

SN 78-681,699. AUSTRALIAN GOLD, INC., INDIANAPOLIS, IN. FILED 7-29-2005.

SMOOTH BRONZER

THE MARK CONSISTS OF STANDARD CHARACTERS WITHOUT CLAIM TO ANY PARTICULAR FONT, STYLE, SIZE, OR COLOR.

NO CLAIM IS MADE TO THE EXCLUSIVE RIGHT TO USE "BRONZER", APART FROM THE MARK AS SHOWN.

FOR PRE-MOISTENED TOWELETTES IMPREGNATED WITH SELF TANNING PREPARATIONS (U.S. CLS. 1, 4, 6, 50, 51 AND 52).

JOHN KELLY, EXAMINING ATTORNEY

SN 78-682,875. PERLIER S.R.L., MILANO, ITALY, FILED 8-1-2005.

PERLIER

THE MARK CONSISTS OF STANDARD CHARACTERS WITHOUT CLAIM TO ANY PARTICULAR FONT, STYLE, SIZE, OR COLOR.

OWNER OF ITALY REG. NO. 253247, DATED 8-8-1971, RENEWED AS REG. NO. 603710, DATED 8-24-1993, EXPIRES 7-1-2011.

FOR BLEACHING PREPARATIONS FOR HOUSEHOLD USE; OTHER SUBSTANCES FOR LAUNDRY USE IN THE NATURE OF LAUNDRY SOAP; GENERAL PURPOSE CLEANING, POLISHING, SCOURING AND ABRASIVE PREPARATIONS FOR HOUSEHOLD USE; SOAPS; PERFUMERY, ESSENTIAL OILS FOR PERSONAL USE, COSMETICS, HAIR LOTIONS; DENTIFRICES (U.S. CLS. 1, 4, 6, 50, 51 AND 52).

ANN E. SAPPENFIELD, EXAMINING ATTORNEY

CLASS 3—(Continued).

SN 78-682,876. PERLIER S.R.L., MILANO, ITALY, FILED 8-1-2005.

RICETTE NATURALI PERLIER

THE MARK CONSISTS OF STANDARD CHARACTERS WITHOUT CLAIM TO ANY PARTICULAR FONT, STYLE, SIZE, OR COLOR.

OWNER OF ITALY REG. NO. 317956, DATED 9-26-1979, RENEWED AS REG. NO. 317956, DATED 7-4-2002, EXPIRES 3-23-2009.

NO CLAIM IS MADE TO THE EXCLUSIVE RIGHT TO USE "NATURALI", APART FROM THE MARK AS SHOWN. THE ENGLISH TRANSLATION OF THE PHASE RICETTE NATURALI IN THE MARK IS NATURAL RECIPES.

FOR BLEACHING PREPARATIONS FOR HOUSEHOLD USE; OTHER SUBSTANCES FOR LAUNDRY USE IN THE NATURE OF LAUNDRY SOAP; GENERAL PURPOSE CLEANING, POLISHING, SCOURING AND ABRASIVE PREPARATIONS FOR HOUSEHOLD USE; SOAPS; PERFUMERY, ESSENTIAL OILS FOR PERSONAL USE, COSMETICS, HAIR LOTIONS; DENTIFRICES (U.S. CLS. 1, 4, 6, 50, 51 AND 52).

ANN E. SAPPENFIELD, EXAMINING ATTORNEY

SN 78-690,071. COSMETICOS MARYLIN LTDA, MEDELLIN, COLOMBIA, FILED 8-10-2005.



The logo for Marylin Cosmetics features the word "Marylin" in a large, elegant, cursive script font. Below it, the word "COSMETICS" is written in a smaller, bold, sans-serif font. The entire logo is enclosed within a thin, curved line that follows the shape of the cursive text.

NO CLAIM IS MADE TO THE EXCLUSIVE RIGHT TO USE "COSMETICS", APART FROM THE MARK AS SHOWN.

FOR NAIL ENAMEL, NAIL POLISH, NAIL CARE PREPARATIONS, COSMETICS, COSMETIC PREPARATIONS FOR BODY CARE, AND NON-MEDICATED SKIN CARE PREPARATIONS (U.S. CLS. 1, 4, 6, 50, 51 AND 52).

FIRST USE 1-4-2003; IN COMMERCE 1-4-2003.

TIMOTHY FINNEGAN, EXAMINING ATTORNEY

CLASS 3—(Continued).

SN 78-690,261. GOSMILE, INC., NEW YORK, NY. FILED 8-11-2005.

SMILE CANDY

THE MARK CONSISTS OF STANDARD CHARACTERS WITHOUT CLAIM TO ANY PARTICULAR FONT, STYLE, SIZE, OR COLOR.

FOR NON-MEDICATED ORAL SPRAYS, TOOTH-PASTE, NON-MEDICATED LIP PROTECTION BALMS AND CREAMS, LIPSTICK, TOOTH WHITENING PREPARATIONS AND TOOTH WHITENER MAINTENANCE PRODUCTS, NAMELY, TOOTH WHITENING GELS, CREAMS AND LIQUIDS (U.S. CLS. 1, 4, 6, 50, 51 AND 52).

JENNIFER KRISP, EXAMINING ATTORNEY

SN 78-698,231. MOUSSELLI, JOUMANA, SPRING, TX. FILED 8-23-2005.

Extend Your Beauty

THE MARK CONSISTS OF STANDARD CHARACTERS WITHOUT CLAIM TO ANY PARTICULAR FONT, STYLE, SIZE, OR COLOR.

FOR COSMETIC PRODUCTS INTENDED TO ENHANCE A PERSON'S APPEARANCE, NAMELY- EYELASH EXTENSIONS; ARTIFICIAL EYELASHES; KITS CONSISTING PRIMARILY OF ARTIFICIAL EYELASHES, BONDING AGENT, TWEEZERS, SCISSORS, ALCOHOL PADS, INSTRUCTIONAL AND PROMOTIONAL MANUAL(S), BROCHURE(S), AND DVD(S) OR VIDEO(S), MASCARA, MASCARA BRUSHES, TAPE, SPONGE, COTTON TIP APPLICATORS, LASH COATING AGENT FOR PROVIDING A WATER RESISTANT SEAL AROUND THE EYELASHES TO ENHANCE THE LIFE OF THE EYELASH EXTENSIONS AND APPLICATORS FOR THE COATING AGENT, AFTER CARE INSTRUCTIONS, AND HOLDING CASE, FOR USE IN THE APPLICATION OF EYELASH EXTENSIONS; REFILL KITS CONSISTING PRIMARILY OF ARTIFICIAL EYELASHES, BONDING AGENT, ALCOHOL PADS, AND MASCARA, FOR USE IN THE APPLICATION OF EYELASH EXTENSIONS; MASCARA; ADHESIVES FOR FALSE EYELASHES AND EYELASH EXTENSIONS (U.S. CLS. 1, 4, 6, 50, 51 AND 52).

VERNA BETH RIRIE, EXAMINING ATTORNEY

CLASS 3—(Continued).

SN 78-707,394. BATH & BODY WORKS, INC., REYNOLDSBURG, OH. FILED 9-6-2005.

GLOVE ME TENDER

THE MARK CONSISTS OF STANDARD CHARACTERS WITHOUT CLAIM TO ANY PARTICULAR FONT, STYLE, SIZE, OR COLOR.

FOR PERSONAL CARE PRODUCTS, NAMELY, AFTER SHAVE LOTION, AFTER SHAVE BALM, AGE SPOT LIGHTENER CREAM, ANTIPERSPIRANT, ASTRINGENT FOR THE FACE FOR COSMETIC PURPOSES, ASTRINGENT FOR THE SKIN FOR COSMETIC PURPOSES, BATH BEADS, BATH CREAM, BATH CUBES, BATH FIZZIES, NAMELY, BUBBLE BATH, BATH FOAM, BATH MILK, BATH OIL, BATH SALTS, NON-MEDICATED BATH SOAKS, BLEMISH CORRECTOR IN THE NATURE OF A CONCEALER, BODY BALM, BODY SOAP BAR, BODY BUTTER, BODY CREAM, BODY GEL, BODY GLITTER, BODY LOTION, BODY LUSTER, NAMELY, BODY LOTION, BODY MASK, BODY MIST SPRAYS, BODY OIL, BODY PAINT, BODY POWDER, BODY SCRUB, BODY SOAP, BODY SPLASH, BODY WASH, BUBBLE BATH, SKIN BUFFING SOAP BAR, COLOGNE, CREAM BODY WASH, CREAM CLEANSER, CUTICLE CREAM, CUTICLE CREAM STICK, CUTICLE OIL PEN, DEODORANT, ESSENTIAL OILS FOR PERSONAL USE, EXFOLIATOR FOR THE FEET, EYE CREAM, EYE GEL, GEL EYE MASK, EYE REPAIR CREAM, NON-MEDICATED EYE TREATMENT PREPARATION IN THE NATURE OF A LOTION, AFTER-SHAVE FACE BALM, SUN BLOCK FOR THE FACE, FACE CLEANSER, FACE CREAM, FACE GEL, FACE LOTION, FACIAL MASK, FACE MIST SPRAY, FACE MOISTURIZER, FACE POLISHER, NAMELY, FACE CREAM, FACE POWDER, FACE SCRUB, FACE SOAP, FACE WASH, FACIAL CLOTHS, NAMELY, PRE-MOISTENED COSMETIC WIPES, FOAM BATH, NON-MEDICATED FOOT CREAM, NON-MEDICATED FOOT LOTION, FOOT POWDER, NON-MEDICATED FOOT SCRUB, NON-MEDICATED FOOT SOAK, FOOT DEODORANT SPRAY, GEL FACE WASH, GLYCERIN SOAP, HAIR CONDITIONER, HAIR DETANGLER, HAIR DYE, HAIR GEL, HAIR GLITTER, HAIR INHIBITOR LOTION, HAIR MASCARA, HAIR MIST SPRAY, HAIR POMADE, HAIR RECONSTRUCTOR, NAMELY, HAIR CONDITIONER, HAIR REMOVING CREAM, NAMELY, DEPI-LATORY CREAM, HAIR REPAIR IN THE NATURE OF HAIR CONDITIONER, HAIR RINSE, HAIR SHAMPOO, HAIR SHINE SERUM, HAIR SPRAY, HAIR STRAIGHTENING PREPARATIONS, HAIR STYLING MOUSSE, HAND BALM, HAND CLEANSING SPRAY, HAND CREAM, HAND EXFOLIANT, HAND LOTION, HAND RENEWER PREPARATIONS, HAND SOAP, HAND WASH, LEG BRONZER CREAM, LEG REFRESHER SPRAY, NON-MEDICATED LINE PREVENTION CONCENTRATE, NON-MEDICATED LINE PREVENTION SERUM, NON-MEDICATED LINE REDUCING CONCENTRATE, NON-MEDICATED LINE REDUCING SERUM, LIP BALM, LIP SUN BLOCK, LIP GLOSS, LIP PAINT, NON-MEDICATED LIP PROTECTOR, LIP SHINE, LIP TINT, NON-MEDICATED LIP TREATMENT PREPARATION, MASSAGE CREAM, MASSAGE LOTION, MASSAGE OIL, MINERAL SALT IN THE NATURE OF BATH SALTS NOT FOR MEDICAL PURPOSES, MOOD ENHANCING MASSAGE OINTMENT, MOOD ENHANCING BODY MIST SPRAY, MOOD ENHANCING SKIN CREAM, NAIL CORRECTOR PEN CONTAINING NAIL POLISH, NAIL CREAM, NAIL POLISH, NAIL POLISH REMOVER, NAIL STENCILS, NIGHT EYE CREAM, NIGHT NOURISHING CREAM, OIL BLOT-TING SHEETS FOR THE SKIN, COSMETIC OIL SPRAY, PENETRATING RUB IN THE NATURE OF MASSAGE OIL, PERFUME, PERFUME OILS, SCENTED PILLOW MIST SPRAY, POST-SUNTANNING LOTION FOR THE BODY, POTPOURRI, POWDER FOR THE FEET, PRE-SUNTANNING LOTION FOR THE BODY, PULSE POINT SKIN CREAM, PULSE POINT THERAPY IN THE NATURE OF AROMATHERAPY OILS, PUMICE STONES

CLASS 3—(Continued).

FOR PERSONAL USE, REFILLS FOR ELECTRIC ROOM FRAGRANCE DISPENSERS, ROOM FRAGRANCE SPRAY, SACHETS, SALT BODY SCRUB, SEA SALT SKIN EXFOLIATOR, SELF TANNING PREPARATION, SHAVING CREAM, SHEA BUTTER HAND CREAM, NON-MEDICATED SHEA BUTTER SKIN TREATMENT STICK, SHOWER CREAM, SHOWER FOAM, SHOWER GEL, SHOWER BODY SCRUB, SKIN BRONZING CREAM, SKIN CLEANSING WIPES FOR COSMETIC PURPOSES, SKIN CREAM, SKIN EXFOLIANTS, SKIN LOTION, SKIN MATTIFIER CREAM, SKIN MOISTURIZER, SKIN POLISHER IN THE NATURE OF SKIN CREAM, SKIN SCRUB, NON-MEDICATED SKIN SERUM, SOAP, STYLING FOAM, SUGAR BODY SCRUB, SUN SCREEN, SUNBLOCK FOR THE BODY, SUNBLOCK FOR THE FACE, SUNLESS TANNING CREAM, SUNLESS TANNING LOTION FOR THE BODY, SUNLESS TANNING LOTION FOR THE FACE, SUNTAN LOTION FOR THE BODY, SUNTAN LOTION FOR THE FACE, TALCUM POWDER, AND UNDER EYE ENHANCER PATCHES (U.S. CLS. 1, 4, 6, 50, 51 AND 52).

WARREN L. OLANDRIA, EXAMINING ATTORNEY

SN 78-707,434. FRESH SQUEEZED LLC, BROOMFIELD, CO. FILED 9-6-2005.

SURF ANGEL

THE MARK CONSISTS OF STANDARD CHARACTERS WITHOUT CLAIM TO ANY PARTICULAR FONT, STYLE, SIZE, OR COLOR.

FOR HAIR CARE AND HAIR STYLING PRODUCTS, NAMELY, HAIR SHAMPOO, HAIR CONDITIONER, HAIR GEL, HAIR MOUSSES, HAIR POMADES, HAIR LACQUERS, HAIR MASCARA, HAIR RINSES, HAIR SPRAY, HAIR WAVING LOTION, HAIR STRAIGHTENING PREPARATIONS, HAIR COLOR, OILS FOR HAIR CONDITIONING; SUN CARE PRODUCTS, NAMELY, SUN CARE LOTIONS, SUNSCREEN, SUN BLOCK, SUN-TANNING PREPARATIONS, SELF-TANNING PREPARATIONS, AND AFTER-SUN LOTIONS; GROOMING AND BODY CARE PRODUCTS, NAMELY, NAMELY FACIAL WASHES, FACIAL SCRUBS AND FACIAL MASKS, FACE AND BODY CREAMS, GELS AND LOTIONS, SKIN TONERS, SHAVING PREPARATIONS, ANTIPERSPIRANTS AND PROBLEM SKIN TREATMENTS, NAMELY, NON-MEDICATED SKIN CREAMS, ANTI-AGING CREAMS, ANTI-FRECKLE CREAMS, NIGHT CREAM, WRINKLE REMOVING SKIN CARE PREPARATIONS; BATH AND BODY PRODUCTS, NAMELY, BEAUTY CREAMS FOR BODY CARE, BODY CREAMS, BODY LOTION, BODY EMULSIONS, BODY MASK CREAMS, BODY MILK, BODY OIL, BODY POWDER, BODY MILK, BODY SCRUB, BODY SPRAYS, BUBBLE BATH, BATH SALTS, BATH CRYSTALS, BATH

CLASS 3—(Continued).

OILS, BATH BEADS, BATH SOAPS IN LIQUID, SOLID OR GEL FORM, DUSTING POWDER, EXFOLIANT CREAMS, HAND CREAM, HAND LOTION, NON-MEDICATED FOOT CREAM, BATH LOTION, BATH MILKS, BODY POWDER, BODY OIL, BODY LOTION, BODY MILK, BODY SCRUB, SHOWER AND BATH GEL, MASSAGE OIL, BREATH FRESHENER, MOUTHWASH; SKIN CARE PRODUCTS, NAMELY, BEAUTY CREAMS, BEAUTY GELS, BEAUTY LOTIONS, BEAUTY MASKS, BEAUTY MILKS, BEAUTY SERUMS; COSMETICS; LIP CARE PRODUCTS, NAMELY, LIP CREAM, LIP GLOSS, LIP LINER, LIPSTICK, NON-MEDICATED LIP BALM; TOOTH CLEANING AND WHITENING PREPARATIONS; NAIL GROOMING PRODUCTS, NAMELY, NAIL TIPS, GLUE, LACQUER AND GLITTER, NAIL POLISH, NAIL ENAMEL, NAIL POLISH REMOVER, NAIL STRENGTHENERS; ESSENTIAL OILS; FRAGRANCES FOR PERSONAL USE; SCENTED BODY SPRAY, SCENTED LINEN SPRAY, ROOM FRAGRANCES, SCENTED ROOM SPRAY, SACHETS, INCENSE (U.S. CLS. 1, 4, 6, 50, 51 AND 52).

DOMINIC J. FERRAIUOLO, EXAMINING ATTORNEY

SN 78-708,315. EMLIN, BENSENVILLE, IL. FILED 9-7-2005.

SOFT AWAKENINGS

THE MARK CONSISTS OF STANDARD CHARACTERS WITHOUT CLAIM TO ANY PARTICULAR FONT, STYLE, SIZE, OR COLOR.

FOR BODY AND BEAUTY CARE COSMETICS; COSMETIC CREAMS FOR SKIN CARE; HAIR SHAMPOO; LIQUID SOAPS FOR HANDS, FACE AND BODY (U.S. CLS. 1, 4, 6, 50, 51 AND 52).

DAWN FELDMAN, EXAMINING ATTORNEY

SN 78-711,805. GIP.C.I., INC., MIAMI, FL. FILED 9-13-2005.

ST7

THE MARK CONSISTS OF STANDARD CHARACTERS WITHOUT CLAIM TO ANY PARTICULAR FONT, STYLE, SIZE, OR COLOR.

FOR BEAUTY GELS; COSMETIC CREAMS; COSMETIC SOAPS; FACE AND BODY CREAMS; SKIN LOTIONS (U.S. CLS. 1, 4, 6, 50, 51 AND 52).

FIRST USE 8-8-2005; IN COMMERCE 8-19-2005.

KATHLEEN M. VANSTON, EXAMINING ATTORNEY

CLASS 3—(Continued).

SN 78-719,459. THE PROCTER & GAMBLE COMPANY, CINCINNATI, OH. FILED 9-23-2005.



NO CLAIM IS MADE TO THE EXCLUSIVE RIGHT TO USE "COMPLEXE DE GLUCOSAMINE", APART FROM THE MARK AS SHOWN.

THE MARK CONSISTS OF A SERIES OF HEXAGONS WHERE THE "O" IS STYLIZED IN THE FORM OF A HEXAGON ALONG WITH A FANCIFUL ARRANGEMENT OF HEXAGONS.

THE FOREIGN WORDING IN THE MARK TRANSLATES INTO ENGLISH AS GLUCOSAMINE COMPLEX.

FOR NON-MEDICATED SKIN CARE PREPARATIONS, COSMETICS, AND BODY WASH, ALL CONTAINING GLUCOSAMINE (U.S. CLS. 1, 4, 6, 50, 51 AND 52).

MARTHA SANTOMARTINO, EXAMINING ATTORNEY

SN 78-739,931. JONATHAN PRODUCT LLC, LINTHICUM HEIGHTS, MD. FILED 10-25-2005.

HOT BABE HAIR

THE MARK CONSISTS OF STANDARD CHARACTERS WITHOUT CLAIM TO ANY PARTICULAR FONT, STYLE, SIZE, OR COLOR.

NO CLAIM IS MADE TO THE EXCLUSIVE RIGHT TO USE "HAIR", APART FROM THE MARK AS SHOWN.

FOR HAIR CARE PRODUCTS AND HAIR STYLING PREPARATIONS, NAMELY, SHAMPOOS, CONDITIONERS, GLOSSES, LEAVE-IN CONDITIONERS, WAXES, POMADES, MOUSSES, SERUMS, SPRAYS AND GELS (U.S. CLS. 1, 4, 6, 50, 51 AND 52).

WENDY GOODMAN, EXAMINING ATTORNEY

SN 78-757,737. SOGGY PAWS, INC., CHICAGO, IL. FILED 11-19-2005.

Soggy Paws

THE MARK CONSISTS OF STANDARD CHARACTERS WITHOUT CLAIM TO ANY PARTICULAR FONT, STYLE, SIZE, OR COLOR.

FOR NON-MEDICATED GROOMING PREPARATIONS FOR DOGS AND CATS, NAMELY, NON-RINSE SHAMPOOS, COAT CONDITIONERS, AND SCENTED SPRAYS (U.S. CLS. 1, 4, 6, 50, 51 AND 52).

FIRST USE 1-15-2004; IN COMMERCE 2-1-2004.

ANGELA M. MICHELI, EXAMINING ATTORNEY

CLASS 3—(Continued).

SN 78-758,609. L'OREAL, PARIS, FRANCE, FILED 11-21-2005.

PROTECTIONISTE C

THE MARK CONSISTS OF STANDARD CHARACTERS WITHOUT CLAIM TO ANY PARTICULAR FONT, STYLE, SIZE, OR COLOR.

NO CLAIM IS MADE TO THE EXCLUSIVE RIGHT TO USE "C", APART FROM THE MARK AS SHOWN.

FOR FACIAL MOISTURIZER (U.S. CLS. 1, 4, 6, 50, 51 AND 52).

BARBARA A. LOUGHRAN, EXAMINING ATTORNEY

SN 78-776,370. CYNTHIA A. BOXRUD, M.D., THE, SANTA MONICA, CA. FILED 12-19-2005.

EYETOPIA

THE MARK CONSISTS OF STANDARD CHARACTERS WITHOUT CLAIM TO ANY PARTICULAR FONT, STYLE, SIZE, OR COLOR.

FOR COSMETICS, NAMELY, NON-MEDICATED SKIN PREPARATIONS AND EYE CARE PREPARATIONS, NAMELY, EYE CREAMS, EYE SERUMS, EYE GELS, EYE CLEANSERS (U.S. CLS. 1, 4, 6, 50, 51 AND 52).

DEZMONA MIZELLE, EXAMINING ATTORNEY

SN 78-800,009. CREATION'S GARDEN NATURAL PRODUCTS, INC., VALENCIA, CA. FILED 1-26-2006.

**CIENNA JOLEIGH NATURAL
SKIN CARE**

THE MARK CONSISTS OF STANDARD CHARACTERS WITHOUT CLAIM TO ANY PARTICULAR FONT, STYLE, SIZE, OR COLOR.

NO CLAIM IS MADE TO THE EXCLUSIVE RIGHT TO USE "NATURAL SKIN CARE", APART FROM THE MARK AS SHOWN.

THE NAME CIENNA JOLEIGH IDENTIFIES A LIVING INDIVIDUAL WHOSE CONSENT IS OF RECORD.

FOR COSMETICS, HAND MOISTURIZERS, BODY MOISTURIZERS, FACE MOISTURIZERS, SKIN CLEANSERS, ANTI-AGING CREAMS, ANTI-WRINKLE CREAMS, BODY CREAMS, BODY OILS, AROMA THERAPY OILS, COLD CREAMS, EYE CREAMS, FACE CREAMS, NIGHT CREAMS, HAND CREAMS, BEAUTY MASKS (U.S. CLS. 1, 4, 6, 50, 51 AND 52).

FLORENTINA BLANDU, EXAMINING ATTORNEY

CLASS 3—(Continued).

SN 78-806,525. MEGUIAR'S, INC., IRVINE, CA. FILED 2-3-2006.

TECH WAX

THE MARK CONSISTS OF STANDARD CHARACTERS WITHOUT CLAIM TO ANY PARTICULAR FONT, STYLE, SIZE, OR COLOR.

NO CLAIM IS MADE TO THE EXCLUSIVE RIGHT TO USE "WAX", APART FROM THE MARK AS SHOWN.

FOR SURFACE CARE PRODUCTS FOR LAND AND MARINE VEHICLES, NAMELY, CLEANING, CONDITIONING, MAINTENANCE, WASHING, WAXING, PROTECTING AND POLISHING PREPARATIONS (U.S. CLS. 1, 4, 6, 50, 51 AND 52).

FIRST USE 12-1-2003; IN COMMERCE 12-1-2003.

KHANH LE, EXAMINING ATTORNEY

SN 78-814,936. IRVI INTERNATIONAL LLC, HALLANDALE BCH., FL. FILED 2-14-2006.

DUDUR

THE MARK CONSISTS OF STANDARD CHARACTERS WITHOUT CLAIM TO ANY PARTICULAR FONT, STYLE, SIZE, OR COLOR.

FOR COSMETIC CREAMS FOR SKIN CARE, NON-MEDICATED SKIN CARE PREPARATIONS, SKIN CARE PRODUCTS, NAMELY, NON-MEDICATED SKIN SERUM, WRINKLE REMOVING SKIN CARE PREPARATIONS, BEAUTY CREAMS FOR BODY CARE, BODY AND BEAUTY CARE COSMETICS, BODY AND BEAUTY CARE PREPARATIONS, COSMETIC PREPARATIONS FOR BODY CARE, DEODORANTS FOR BODY CARE, LOTIONS FOR FACE AND BODY CARE, SOAPS FOR BODY CARE, BATH GEL, BATH OIL, BATH SALTS, BATHING LOTIONS, BATH SOAPS IN LIQUID, SOLID OR GEL FORM, BEAUTY MASKS, BEAUTY MILKS, BEAUTY SERUMS, BODY CREAM, BODY EMULSIONS, BODY LOTION, BODY MASK CREAM, BODY MASK LOTION, BODY MASKS, BODY MILK, BODY OIL, BODY SCRUB, BODY SPRAY USED AS A PERSONAL DEODORANT AND AS FRAGRANCE, BODY SPRAYS, BUBBLE BATH, CREAMS FOR CELLULITE REDUCTION, DEODORANT FOR PERSONAL USE, DEODORANTS FOR BODY CARE, EXFOLIANT CREAMS, EYE CREAM, EYE GELS, FACE AND BODY BEAUTY CREAMS, FACE AND BODY CREAMS, FACE AND BODY LOTIONS, FACE AND BODY MILK, FACE CREAMS, FACIAL CLEANSERS, HAND CREAM, HAND LOTIONS, SHOWER AND BATH GEL, SHOWER GEL (U.S. CLS. 1, 4, 6, 50, 51 AND 52).

FIRST USE 10-9-2005; IN COMMERCE 10-9-2005.

DOMINIC FATHY, EXAMINING ATTORNEY

CLASS 3—(Continued).

SN 78-824,825. DEZEMBER, ANTHONY W., CHINO HILLS, CA. FILED 2-28-2006.



NO CLAIM IS MADE TO THE EXCLUSIVE RIGHT TO USE "AUTO/BOAT CLEANER", APART FROM THE MARK AS SHOWN.

FOR ALL PURPOSE CLEANERS AND RESTORERS; NAMELY, AUTOMOBILE, MARINE, AND VEHICLE UPHOLSTERY CLEANERS; LEATHER CLEANERS; VINYL CLEANERS; FABRIC CLEANERS; AND UPHOLSTERY CLEANERS; AND KITCHEN AND BATHROOM CLEANERS (U.S. CLS. 1, 4, 6, 50, 51 AND 52).

BARBARA BROWN, EXAMINING ATTORNEY

SN 78-825,307. INTERNATIONAL MASTER PRODUCTS CORPORATION, MONTAGUE, MI. FILED 2-28-2006.

SCENTSATIONAL BOUQUETS

THE MARK CONSISTS OF STANDARD CHARACTERS WITHOUT CLAIM TO ANY PARTICULAR FONT, STYLE, SIZE, OR COLOR.

NO CLAIM IS MADE TO THE EXCLUSIVE RIGHT TO USE "BOUQUETS", APART FROM THE MARK AS SHOWN. FOR STICK THAT ADDS SCENT TO A FLOWER BOUQUET OR FLOWERING POT PLANT (U.S. CLS. 1, 4, 6, 50, 51 AND 52).

GINA HAYES, EXAMINING ATTORNEY

SN 78-825,310. INTERNATIONAL MASTER PRODUCTS CORPORATION, MONTAGUE, MI. FILED 2-28-2006.

SCENTSATIONAL PLANTS

THE MARK CONSISTS OF STANDARD CHARACTERS WITHOUT CLAIM TO ANY PARTICULAR FONT, STYLE, SIZE, OR COLOR.

NO CLAIM IS MADE TO THE EXCLUSIVE RIGHT TO USE "PLANTS", APART FROM THE MARK AS SHOWN. FOR STICK THAT ADDS SCENT TO A FLOWER BOUQUET OR FLOWERING POT PLANT (U.S. CLS. 1, 4, 6, 50, 51 AND 52).

GINA HAYES, EXAMINING ATTORNEY

CLASS 3—(Continued).

SN 78-827,052. PELZER, MARY-JANE, SARATOGA SPRINGS, NY. FILED 3-2-2006.

Suds 'n' Stuff

THE MARK CONSISTS OF STANDARD CHARACTERS WITHOUT CLAIM TO ANY PARTICULAR FONT, STYLE, SIZE, OR COLOR.

FOR ALMOND SOAPS; BATH SOAPS IN LIQUID, SOLID OR GEL FORM; COSMETIC SOAPS; DETERGENT SOAP; HAND SOAPS; LAUNDRY SOAP; PERFUMED SOAP; PERFUMED SOAPS; SHAVING SOAP; SKIN SOAP; SOAPS FOR BODY CARE; SOAPS FOR HOUSEHOLD USE; SOAPS FOR PERSONAL USE (U.S. CLS. 1, 4, 6, 50, 51 AND 52).

FIRST USE 12-1-1972; IN COMMERCE 12-1-1972.

JEAN IM, EXAMINING ATTORNEY

SN 78-829,806. LANCOME PARFUMS ET BEAUTE & CIE, PARIS, FRANCE, FILED 3-6-2006.

ROSE DU SOIR

THE MARK CONSISTS OF STANDARD CHARACTERS WITHOUT CLAIM TO ANY PARTICULAR FONT, STYLE, SIZE, OR COLOR.

THE ENGLISH TRANSLATION OF THE WORD DU SOIR IN THE MARK IS OF THE EVENING.

FOR MAKEUP PREPARATIONS, NAMELY, EYE SHADOWS (U.S. CLS. 1, 4, 6, 50, 51 AND 52).

TONJA GASKINS, EXAMINING ATTORNEY

SN 78-830,525. THE BEAUTY MARKET, LTD., DBA GET FRESH, SANTA MONICA, CA. FILED 3-6-2006.

SILKY SOLES

THE MARK CONSISTS OF STANDARD CHARACTERS WITHOUT CLAIM TO ANY PARTICULAR FONT, STYLE, SIZE, OR COLOR.

NO CLAIM IS MADE TO THE EXCLUSIVE RIGHT TO USE "SOLES", APART FROM THE MARK AS SHOWN. SEC. 2(F).

FOR FOOT PRODUCT, NAMELY, NON-MEDICATED PRE-EXFOLIATING GEL (U.S. CLS. 1, 4, 6, 50, 51 AND 52).

FIRST USE 2-27-2006; IN COMMERCE 2-27-2006.

MICHAEL GAFFAR, EXAMINING ATTORNEY

CLASS 3—(Continued).

SN 78-835,598. AUSTRALIAN GOLD, INC., INDIANAPOLIS, IN. FILED 3-13-2006.

PRICELESS

THE MARK CONSISTS OF STANDARD CHARACTERS WITHOUT CLAIM TO ANY PARTICULAR FONT, STYLE, SIZE, OR COLOR.

FOR NON-MEDICATED INDOOR AND OUTDOOR TANNING PREPARATIONS DISTRIBUTED AND MARKETED FOR SALE AND USE IN INDOOR TANNING SALONS (U.S. CLS. 1, 4, 6, 50, 51 AND 52).
AMY ALFIERI, EXAMINING ATTORNEY

CLASS 3—(Continued).

SN 78-838,897. RECKITT BENCKISER INC., PARSIPPANY, NJ. FILED 3-16-2006.

PASSION BREEZE

THE MARK CONSISTS OF STANDARD CHARACTERS WITHOUT CLAIM TO ANY PARTICULAR FONT, STYLE, SIZE, OR COLOR.

FOR CLEANING AND POLISHING PREPARATIONS FOR GLASS, APPLIANCES AND CABINETS; GLASS CLEANER; ALL-PURPOSE SURFACE CLEANER (U.S. CLS. 1, 4, 6, 50, 51 AND 52).

BRENDAN REGAN, EXAMINING ATTORNEY

SN 78-846,495. CANDLE CORPORATION OF AMERICA, DES PLAINES, IL. FILED 3-27-2006.

COLONIAL CANDLE

THE MARK CONSISTS OF STANDARD CHARACTERS WITHOUT CLAIM TO ANY PARTICULAR FONT, STYLE, SIZE, OR COLOR.

OWNER OF U.S. REG. NO. 3,104,565.

NO CLAIM IS MADE TO THE EXCLUSIVE RIGHT TO USE "CANDLE", APART FROM THE MARK AS SHOWN.

FOR POTPOURRI, POTPOURRI REFRESHER OIL, ROOM FRAGRANCES, ROOM FRAGRANCE REFILLS FOR ELECTRIC FRAGRANCE DISPENSERS, SCENTED LINEN SPRAY (U.S. CLS. 1, 4, 6, 50, 51 AND 52).

FIRST USE 1-0-2004; IN COMMERCE 1-0-2004.

STEVEN R. FINE, EXAMINING ATTORNEY

SN 78-836,172. NAILA MALIK MD SKIN SYSTEMS INC, ARGYLE, TX. FILED 3-13-2006.



NO CLAIM IS MADE TO THE EXCLUSIVE RIGHT TO USE "SKIN SYSTEMS", APART FROM THE MARK AS SHOWN.

THE MARK CONSISTS OF THE LETTER "N" IN A BOX ABOVE THE WORDING "NAILA" AND "NAILA MALIK MD SKIN SYSTEMS".

FOR BATH OILS FOR COSMETIC PURPOSES; BODY AND BEAUTY CARE COSMETICS; COCOA BUTTER FOR COSMETIC PURPOSES; CONCEALERS; COSMETIC CREAMS; COSMETIC CREAMS FOR SKIN CARE; COSMETIC OILS; COSMETIC PADS; COSMETIC PREPARATIONS AGAINST SUNBURN; COSMETIC PREPARATIONS FOR BODY CARE; COSMETIC PREPARATIONS FOR EYE LASHES; COSMETIC PREPARATIONS FOR SKIN RENEWAL; COSMETIC ROUGES; COSMETIC SUN-PROTECTING PREPARATIONS; COSMETICS; FACIAL BEAUTY MASKS; FACIAL CLEANSERS; FACIAL CONCEALER; FACIAL CREAMS; FACIAL LOTION; FACIAL MASKS; FACIAL SCRUBS; FACIAL WASHES; MAKE-UP KITS COMPRISED OF FACIAL CREAMS; MOUSSE FOR FACE; PERFUME OILS FOR THE MANUFACTURE OF COSMETIC PREPARATIONS; PETROLEUM JELLY FOR COSMETIC PURPOSES; ROSE OIL FOR COSMETIC PURPOSES; TONERS (U.S. CLS. 1, 4, 6, 50, 51 AND 52).

FIRST USE 1-1-2006; IN COMMERCE 1-1-2006.

KEVIN DINALLO, EXAMINING ATTORNEY

SN 78-847,695. 25 MARKET SHARE, LLP, TEMPE, AZ. FILED 3-28-2006.

GOLDEN SLUMBER

THE MARK CONSISTS OF STANDARD CHARACTERS WITHOUT CLAIM TO ANY PARTICULAR FONT, STYLE, SIZE, OR COLOR.

FOR BODY CREAMS; BODY EMULSIONS; BODY LOTION; FACE AND BODY LOTIONS; SELF-TANNING PREPARATIONS; SKIN MOISTURIZER (U.S. CLS. 1, 4, 6, 50, 51 AND 52).

SETH A. RAPPAPORT, EXAMINING ATTORNEY

CLASS 3—(Continued).

SN 78-848,837. DOUBLE G ENTERPRISES, LLC, TEMPE, AZ.
FILED 3-29-2006.

CLASS 3—(Continued).

SN 78-854,893. MINDY BETH SCHWARTZ, CONCORD, NH.
FILED 4-5-2006.

ENAMOR

THE MARK CONSISTS OF STANDARD CHARACTERS WITHOUT CLAIM TO ANY PARTICULAR FONT, STYLE, SIZE, OR COLOR.

FOR COSMETIC SUN-TANNING PREPARATIONS; SELF-TANNING PREPARATIONS; SKIN GELS FOR ACCELERATING, ENHANCING OR EXTENDING TANS; TANNING CREAMS (U.S. CLS. 1, 4, 6, 50, 51 AND 52).

KYLE PEETE, EXAMINING ATTORNEY

GRAYSON'S
apothecary of beauty

THE WORD GRAYSON'S IS IN CAPITAL LETTERS THAT ARE ARCHED. UNDERNEATH IS THE WORDING, APOTHECARY OF BEAUTY, IN SCRIPT LETTERING WITH TWO MARKS ON EACH SIDE.

FOR BODY AND BEAUTY CARE COSMETICS (U.S. CLS. 1, 4, 6, 50, 51 AND 52).

FIRST USE 1-1-2006; IN COMMERCE 1-1-2006.

KATINA MISTER, EXAMINING ATTORNEY

SN 78-850,652. LAYLA K., FREMONT, CA. FILED 3-30-2006.

•madame *U*jour•

SN 78-855,135. MURCIELAGO, INC., COLORADO SPRINGS, CO. FILED 4-5-2006.

TENACIOUS

THE FOREIGN WORDING IN THE MARK TRANSLATES INTO ENGLISH AS LADY OF THE DAY.

FOR BATH, BODY, AND BEAUTY PRODUCTS, NAMELY, BODY BUTTERS, SOAPS, HAIR SHAMPOOS AND CONDITIONERS, BATH GELS, SCENTED BODY SPRAY, EXFOLIANTS FOR THE SKIN, BODY SCRUBS, BATH SALTS, NON-MEDICATED FOOT SOAKS AND CREAMS, BODY LOTIONS, SHAVING CREAMS (U.S. CLS. 1, 4, 6, 50, 51 AND 52).

FIRST USE 1-2-2006; IN COMMERCE 3-1-2006.

AMY ALFIERI, EXAMINING ATTORNEY

THE MARK CONSISTS OF STANDARD CHARACTERS WITHOUT CLAIM TO ANY PARTICULAR FONT, STYLE, SIZE, OR COLOR.

FOR PERFUME (U.S. CLS. 1, 4, 6, 50, 51 AND 52).

FIRST USE 1-10-2006; IN COMMERCE 1-10-2006.

DOMINICK J. SALEMI, EXAMINING ATTORNEY

CLASS 3—(Continued).

SN 78-855,555. MITCHELL, BILL, DBA L.A. CHRISTIAN BEAUTY SALON SUPPLY, LOS ANGELES, CA. AND MITCHELL, SYLVIA, DBA L.A. CHRISTIAN BEAUTY SALON SUPPLY, LOS ANGELES, CA. FILED 4-6-2006.

FROM B.L. MITCH WITH LOVE

THE MARK CONSISTS OF STANDARD CHARACTERS WITHOUT CLAIM TO ANY PARTICULAR FONT, STYLE, SIZE, OR COLOR.

THE NAME IN THE MARK REFERS TO A LIVING INDIVIDUAL WHOSE CONSENT IS OF RECORD.

FOR HAIR AND SKIN CARE PREPARATIONS, NAMELY, SHAMPOOS, COLOR SHAMPOO, SOAPS, CONDITIONERS, MOISTURIZERS, RINSES, NON-MEDICATED SKIN AND SCALP TREATMENT CREAMS AND LOTIONS, MISTS, THERMAL PROTECTIVE SPRAYS, SPRAY CONDITIONERS, HAIR GELS, SPRAY GELS, SCULPTING FOAM, LOTIONS, STYLING SPRAYS, STYLING GELS, STYLING LOTIONS, HAIR SPRAYS, POMADES, HAIR STYLING PREPARATIONS, SHINE SPRAYS, HAIR STRENGTHENING PREPARATIONS; SKIN CARE PRODUCTS, NAMELY SKIN CLEANSER, SKIN MOISTURIZER (U.S. CLS. 1, 4, 6, 50, 51 AND 52).

PAUL F. GAST, EXAMINING ATTORNEY

SN 78-856,326. PRESCRIPTIVES INC., NEW YORK, NY. FILED 4-7-2006.

FRESH PERFECTION

THE MARK CONSISTS OF STANDARD CHARACTERS WITHOUT CLAIM TO ANY PARTICULAR FONT, STYLE, SIZE, OR COLOR.

FOR COSMETICS; NON-MEDICATED SKIN CARE PREPARATIONS (U.S. CLS. 1, 4, 6, 50, 51 AND 52).

MATTHEW MCDOWELL, EXAMINING ATTORNEY

SN 78-857,922. SMITH, WILLIAM G., PORTLAND, OR. FILED 4-10-2006.



NO CLAIM IS MADE TO THE EXCLUSIVE RIGHT TO USE "BEAUTY", APART FROM THE MARK AS SHOWN.

THE COLOR RED IS CLAIMED AS A FEATURE OF THE MARK.

THE MARK CONSISTS OF STYLIZED RED LETTERS F A G U L O U S B E A U T Y.

FOR BEAUTY CREAMS, FACIAL MASKS, BODY SCRUBS AND EYE CREAMS FOR FACE AND BODY CARE; COSMETIC CREAMS, SCRUBS AND MASKS FOR SKIN CARE (U.S. CLS. 1, 4, 6, 50, 51 AND 52).

FIRST USE 2-1-2006; IN COMMERCE 4-1-2006.

KIMBERLY FRYE, EXAMINING ATTORNEY

CLASS 3—(Continued).

SN 78-859,024. H.S.A. - HAIR STYLING APPLICATIONS SPA, 21100 VARESE, ITALY, FILED 4-11-2006.

SILKY TECHNO BASIC

THE MARK CONSISTS OF STANDARD CHARACTERS WITHOUT CLAIM TO ANY PARTICULAR FONT, STYLE, SIZE, OR COLOR.

FOR HAIR CARE LOTIONS; HAIR COLOR; HAIR COLOR REMOVERS; HAIR SHAMPOO (U.S. CLS. 1, 4, 6, 50, 51 AND 52).

MARTHA FROMM, EXAMINING ATTORNEY

SN 78-859,218. PANTONE, INC., CARLSTADT, NJ. FILED 4-11-2006.

PANTONE UNIVERSE

THE MARK CONSISTS OF STANDARD CHARACTERS WITHOUT CLAIM TO ANY PARTICULAR FONT, STYLE, SIZE, OR COLOR.

OWNER OF U.S. REG. NOS. 1,674,917, 1,884,707 AND OTHERS.

FOR AFTER-SHAVE LOTIONS; BATH SOAPS IN LIQUID, SOLID OR GEL FORM; BLUSH; BODY LOTIONS; BODY SPRAYS; COLOGNE; COSMETICS; EAU DE TOILETTE; EYE LINER; EYE SHADOW; FACE CREAMS; FACE POWDER; FOUNDATION; HAND LOTIONS; LIP GLOSS; LIP LINER; LIPSTICK; MASCARA; PERFUMES; SKIN CREAMS; SKIN LOTIONS; SKIN MOISTURIZER (U.S. CLS. 1, 4, 6, 50, 51 AND 52).

TINA BROWN, EXAMINING ATTORNEY

SN 78-859,599. MANDELL, ALAN, MIAMI, FL. FILED 4-12-2006.

FemBurst

THE MARK CONSISTS OF STANDARD CHARACTERS WITHOUT CLAIM TO ANY PARTICULAR FONT, STYLE, SIZE, OR COLOR.

FOR SKIN CREAMS IN LIQUID AND SOLID FORM (U.S. CLS. 1, 4, 6, 50, 51 AND 52).

KRISTINA KLOIBER, EXAMINING ATTORNEY

CLASS 3—(Continued).

SN 78-860,941. SPARTAN CHEMICAL COMPANY, INC., MAUMEE, OH. FILED 4-13-2006.

EYE SHINE

THE MARK CONSISTS OF STANDARD CHARACTERS WITHOUT CLAIM TO ANY PARTICULAR FONT, STYLE, SIZE, OR COLOR.

FOR FLOOR FINISHING PREPARATION (U.S. CLS. 1, 4, 6, 50, 51 AND 52).
MARILYN IZZI, EXAMINING ATTORNEY

SN 78-861,229. NAILTIQUES COSMETIC CORP., MIAMI, FL. FILED 4-13-2006.

RETURN TO THE ORIGINAL

THE MARK CONSISTS OF STANDARD CHARACTERS WITHOUT CLAIM TO ANY PARTICULAR FONT, STYLE, SIZE, OR COLOR.

FOR FINGERNAIL CARE PRODUCTS, NAMELY CUTICLE AND NAIL CONDITIONING CREMES, LOTIONS, AND OILS; NAIL POLISH; NAIL PROTEIN POLISH; NAIL HARDENERS, NAIL STRENGTHENERS, NAIL POLISH REMOVER, NAIL BUFFING PREPARATIONS; NAIL POLISH BASE COAT; AND NAIL POLISH TOP COAT (U.S. CLS. 1, 4, 6, 50, 51 AND 52).

JOHN GARTNER, EXAMINING ATTORNEY

SN 78-861,324. UNIVERSAL CITY MEDICAL WELLNESS GROUP, LOS ANGELES, CA. FILED 4-13-2006.

green spa

THE MARK CONSISTS OF STANDARD CHARACTERS WITHOUT CLAIM TO ANY PARTICULAR FONT, STYLE, SIZE, OR COLOR.

NO CLAIM IS MADE TO THE EXCLUSIVE RIGHT TO USE "SPA", APART FROM THE MARK AS SHOWN.

FOR BODY AND BEAUTY CARE COSMETICS; COSMETICS; ANTI-STATIC DRYER SHEETS; AROMATHERAPY CREAMS; AROMATHERAPY LOTIONS; AROMATHERAPY OILS; AROMATHERAPY PILLOWS COMPRISING POTPOURRI IN FABRIC; BUBBLE BATH; ROOM FRAGRANCES; SACHETS; SACHET-LIKE EYE PILLOWS CONTAINING FRAGRANCES; SCENTED CERAMIC STONES; SCENTED LINEN SPRAYS; SCENTED LINEN WATER; SCENTED OILS USED TO PRODUCE AROMAS WHEN HEATED; SCENTED ROOM SPRAYS; SOAPS AND DETERGENTS; STAIN REMOVERS (U.S. CLS. 1, 4, 6, 50, 51 AND 52).

PATRICIA EVANKO, EXAMINING ATTORNEY

CLASS 3—(Continued).

SN 78-861,438. LUIKART, EILEEN J., SEVEN HILLS, OH. FILED 4-13-2006.

PsoriaSoap

THE MARK CONSISTS OF STANDARD CHARACTERS WITHOUT CLAIM TO ANY PARTICULAR FONT, STYLE, SIZE, OR COLOR.

FOR NON-MEDICATED BODY SOAP FOR PSORIASIS (U.S. CLS. 1, 4, 6, 50, 51 AND 52).

ELIZABETH J. WINTER, EXAMINING ATTORNEY

SN 78-861,486. GARCEAU, ARTHUR, DELRAY BEACH, FL. FILED 4-13-2006.

MISHA TRUSHAY

THE MARK CONSISTS OF STANDARD CHARACTERS WITHOUT CLAIM TO ANY PARTICULAR FONT, STYLE, SIZE, OR COLOR.

THE NAME MISHA TRUSHAY DOES NOT IDENTIFY A LIVING INDIVIDUAL.

FOR BEAUTY LOTIONS; BODY LOTION; COLOGNE; EAU DE COLOGNE; EAU DE PERFUME; FACE AND BODY LOTIONS; FACIAL LOTION; HAND LOTIONS; LOTIONS FOR FACE AND BODY CARE; PERFUME; PERFUME OILS; PERFUMED SOAP; PERFUMES; SKIN CLEANSING LOTION; SKIN LOTION; TONING LOTION, FOR THE FACE, BODY AND HANDS (U.S. CLS. 1, 4, 6, 50, 51 AND 52).

FIRST USE 6-13-2004; IN COMMERCE 6-13-2004.
COLLEEN KEARNEY, EXAMINING ATTORNEY

CLASS 3—(Continued).

SN 78-861,685. SKIN CONCEPT INC, FOREST HILLS, NY.
FILED 4-14-2006.

skin elements

THE MARK CONSISTS OF STANDARD CHARACTERS WITHOUT CLAIM TO ANY PARTICULAR FONT, STYLE, SIZE, OR COLOR.

NO CLAIM IS MADE TO THE EXCLUSIVE RIGHT TO USE "SKIN", APART FROM THE MARK AS SHOWN.

FOR BEAUTY CREAMS FOR BODY CARE; BODY AND BEAUTY CARE COSMETICS; BODY AND BEAUTY CARE PREPARATIONS; COSMETIC CREAMS FOR SKIN CARE; COSMETIC PREPARATIONS FOR BODY CARE; COSMETIC PREPARATIONS FOR SKIN RENEWAL; COSMETIC PRODUCTS IN THE FORM OF AEROSOLS FOR SKIN CARE; COSMETIC PRODUCTS IN THE FORM OF AEROSOLS FOR SKINCARE; EXFOLIANTS FOR SKIN; SKIN ABRASIVE PREPARATIONS; SKIN BRONZING CREAMS; SKIN CARE PRODUCTS, NAMELY, NON-MEDICATED SKIN SERUM; SKIN CLARIFIERS; SKIN CLEANSERS; SKIN CLEANSING CREAM; SKIN CLEANSING LOTION; SKIN CONDITIONERS; SKIN CREAM; SKIN CREAMS; SKIN CREAMS IN LIQUID AND IN SOLID FORM; SKIN CREAMS IN LIQUID AND SOLID; SKIN CREAMS IN LIQUID AND SOLID FORM; SKIN EMOLLIENTS; SKIN GELS FOR ACCELERATING, ENHANCING OR EXTENDING TANS; SKIN LIGHTENERS; SKIN LIGHTENING CREAMS; SKIN LOTION; SKIN LOTIONS; SKIN MASKS; SKIN MOISTURIZER; SKIN MOISTURIZER MASKS; SKIN POLISHING RICE BRAN (ARAI-NUKA); SKIN SOAP; SKIN TEXTURIZERS; SKIN TONERS; SKIN WHITENING CREAMS; SKIN WHITENING PREPARATIONS; SUN CARE LOTIONS; TOPICAL SKIN SPRAYS FOR COSMETIC PURPOSES; WRINKLE REMOVING SKIN CARE PREPARATIONS (U.S. CLS. 1, 4, 6, 50, 51 AND 52).

FIRST USE 3-1-2006; IN COMMERCE 3-1-2006.
DOMINIC J. FERRAIUOLO, EXAMINING ATTORNEY

SN 78-861,787. L'OREAL USA CREATIVE, INC., NEW YORK, NY. FILED 4-14-2006.

STYLE POWER

THE MARK CONSISTS OF STANDARD CHARACTERS WITHOUT CLAIM TO ANY PARTICULAR FONT, STYLE, SIZE, OR COLOR.

FOR HAIR CARE PREPARATION (U.S. CLS. 1, 4, 6, 50, 51 AND 52).

FIRST USE 4-0-2006; IN COMMERCE 4-0-2006.
LINDA M. KING, EXAMINING ATTORNEY

CLASS 3—(Continued).

SN 78-861,833. TREND SOURCE, INC., BIRCHRUNVILLE, PA. FILED 4-14-2006.

abeille

THE MARK CONSISTS OF STANDARD CHARACTERS WITHOUT CLAIM TO ANY PARTICULAR FONT, STYLE, SIZE, OR COLOR.

THE FOREIGN WORDING IN THE MARK TRANSLATES INTO ENGLISH AS BEE.

FOR BEAUTY CREAMS FOR BODY CARE; BODY AND BEAUTY CARE COSMETICS; COSMETIC CREAMS FOR SKIN CARE; DEODORANTS FOR BODY CARE; LIP BALM; LIP CREAM; LIP GLOSS; LOTIONS FOR FACE AND BODY CARE; NON-MEDICATED LIP CARE PREPARATIONS; NON-MEDICATED SKIN CARE PREPARATIONS; NON-MEDICATED SKIN CREAMS; NON-MEDICATED STIMULATING LOTIONS FOR THE SKIN; SKIN CARE PRODUCTS, NAMELY, NON-MEDICATED SKIN SERUM; SKIN CLARIFIERS; SKIN CLEANSERS; SKIN CLEANSING CREAM; SKIN CLEANSING LOTION; SKIN CONDITIONERS; SKIN CREAMS; SKIN CREAMS IN LIQUID AND SOLID; SKIN CREAMS IN LIQUID AND SOLID FORM; SKIN LOTIONS; SKIN MASKS; SKIN MOISTURIZER; SKIN SOAP (U.S. CLS. 1, 4, 6, 50, 51 AND 52).

WILLIAM P. SHANAHAN, EXAMINING ATTORNEY

SN 78-862,405. LYNCH, RAPHAEL, CHICAGO, IL. FILED 4-16-2006.



THE MARK CONSISTS OF CREST WITH A BANNER IN THE FOREFRONT, WREATHS ON BOTH SIDES OF THE CREST, SMALL BANNER FOREFRONT AT THE BOTTOM, CENTER OF CREST IS CROWNED LION HEAD, ACCOMPANIED BY SMALL SHIELD, TORCH AND GLOBE STAFF WITH SMALLER SHIELD ON BOTH SIDES.

FOR HAIR STYLING CONDITIONER (U.S. CLS. 1, 4, 6, 50, 51 AND 52).

JOHN DWYER, EXAMINING ATTORNEY

CLASS 3—(Continued).

SN 78-862,508. ALBERTO-CULVER COMPANY, MELROSE PARK, IL. FILED 4-17-2006.

AQUASCREEN

THE MARK CONSISTS OF STANDARD CHARACTERS WITHOUT CLAIM TO ANY PARTICULAR FONT, STYLE, SIZE, OR COLOR.

FOR HAIR CARE PREPARATIONS (U.S. CLS. 1, 4, 6, 50, 51 AND 52).

MATTHEW MCDOWELL, EXAMINING ATTORNEY

SN 78-862,979. IVORY SOAP WORKS LTD., MUMBAI, INDIA, FILED 4-17-2006.

CLEAR AURA

THE MARK CONSISTS OF STANDARD CHARACTERS WITHOUT CLAIM TO ANY PARTICULAR FONT, STYLE, SIZE, OR COLOR.

FOR ALMOND SOAPS; ANTIBACTERIAL SKIN SOAPS; ANTIBACTERIAL SOAP; BATH SOAPS IN LIQUID, SOLID OR GEL FORM; BODY CREAM SOAP; COSMETIC SOAPS; CREAM SOAPS; DEODORANT SOAP; DETERGENT SOAP; DISINFECTANT SOAPS; DISINFECTING PERFUMED SOAPS; GRANULATED SOAPS; HAND SOAPS; INDUSTRIAL SOAP; LAUNDRY SOAP; LIQUID BATH SOAPS; LIQUID SOAP; LIQUID SOAP USED IN FOOT BATH; LIQUID SOAPS FOR HANDS, FACE AND BODY; MEDICATED SOAPS; PERFUMED SOAPS; SADDLE SOAP; SHAVING SOAP; SKIN SOAP; SOAP POWDER; SOAPS AND DETERGENTS; SOAPS FOR BODY CARE; SOAPS FOR HOUSEHOLD USE; SOAPS FOR PERSONAL USE; SOAPS FOR TOILET PURPOSES; TOILET SOAP; TOILET SOAPS; WATERLESS SOAP (U.S. CLS. 1, 4, 6, 50, 51 AND 52).

JESSICA A. POWERS, EXAMINING ATTORNEY

CLASS 3—(Continued).

SN 78-863,013. RUBIO, ROBERT, GOLETA, CA. AND SAN-HUEZA, SOLANGE, GOLETA, CA. FILED 4-17-2006.

EBODY

THE MARK CONSISTS OF STANDARD CHARACTERS WITHOUT CLAIM TO ANY PARTICULAR FONT, STYLE, SIZE, OR COLOR.

FOR AFTER-SHAVE CREAMS, AFTER-SHAVE GELS, AFTER-SHAVE LOTIONS, AROMATHERAPY CREAMS, AROMATHERAPY LOTIONS, AROMATHERAPY OILS, BATH GELS, BATH LOTION, BATH OILS, BEAUTY CREAMS, BEAUTY GELS, BEAUTY LOTIONS, BODY CREAMS, BODY LOTIONS, BODY SPRAYS, BODY OILS, COLOGNE, COSMETIC CREAMS, COSMETIC OILS, COSMETIC PREPARATIONS FOR BODY CARE, DEPI-LATORIES, DEPI-LATORY CREAMS, EPILATORY STRIPS, FACE AND BODY CREAMS, FACE AND BODY LOTIONS, FRAGRANCES FOR PERSONAL USE, HAIR CARE CREAMS, HAIR CARE LOTIONS, HAIR CARE PREPARATIONS, HAIR CLEANSING PREPARATIONS, HAIR CONDITIONERS, HAIR MOUSSE, HAIR OILS, HAIR STYLING PREPARATIONS, LOTIONS FOR FACE AND BODY CARE, PERFUMES, SHOWER AND BATH FOAM, SHOWER AND BATH GEL, SKIN CLEANSERS, SKIN CREAMS, SKIN LOTIONS, SUN BLOCK PREPARATIONS, SUN CARE LOTIONS, SUN SCREEN PREPARATIONS, WAX STRIPS FOR REMOVING BODY HAIR (U.S. CLS. 1, 4, 6, 50, 51 AND 52).

FIRST USE 4-10-2006; IN COMMERCE 4-10-2006.
SEAN CROWLEY, EXAMINING ATTORNEY

SN 78-863,096. FORSYTHE COSMETIC GROUP, LTD., LAWRENCE, NY. FILED 4-17-2006.

Pokermania

THE MARK CONSISTS OF STANDARD CHARACTERS WITHOUT CLAIM TO ANY PARTICULAR FONT, STYLE, SIZE, OR COLOR.

FOR COSMETICS, NAMELY NAIL POLISH, NAIL ENAMELS, NAIL HARDENERS, AND NAIL LACQUERS (U.S. CLS. 1, 4, 6, 50, 51 AND 52).

CHERYL CLAYTON, EXAMINING ATTORNEY

SN 78-863,211. ALBERTO-CULVER COMPANY, MELROSE PARK, IL. FILED 4-17-2006.

HEALTHY LENGTHS

THE MARK CONSISTS OF STANDARD CHARACTERS WITHOUT CLAIM TO ANY PARTICULAR FONT, STYLE, SIZE, OR COLOR.

FOR HAIR CARE PREPARATIONS (U.S. CLS. 1, 4, 6, 50, 51 AND 52).

MATTHEW MCDOWELL, EXAMINING ATTORNEY

CLASS 3—(Continued).

SN 78-863,213. ALBERTO-CULVER COMPANY, MELROSE PARK, IL. FILED 4-17-2006.

STRONG STRANDS

THE MARK CONSISTS OF STANDARD CHARACTERS WITHOUT CLAIM TO ANY PARTICULAR FONT, STYLE, SIZE, OR COLOR.

FOR HAIR CARE PREPARATIONS (U.S. CLS. 1, 4, 6, 50, 51 AND 52).

MATTHEW MCDOWELL, EXAMINING ATTORNEY

SN 78-863,240. HIGHLAND LABORATORIES, INC., MOUNT ANGEL, OR. FILED 4-17-2006.

I SAY

THE MARK CONSISTS OF STANDARD CHARACTERS WITHOUT CLAIM TO ANY PARTICULAR FONT, STYLE, SIZE, OR COLOR.

FOR BODY CREAM, FACE CREAM, EYE CREAM, ANTI-AGING CREAM, BEAUTY CREAM, BODY LOTION, FACE LOTION, BEAUTY LOTION, BATHING LOTION, AFTER-SHAVE LOTION, EYE LOTION, SUN SCREEN LOTION, BATH GEL, HAIR GEL, HAIR STYLING GEL, SHAVING GEL, SHOWER GEL, TOOTH GEL, SUN SCREEN GEL, SOOTHING NON-MEDICATED FOOT GEL, SOOTHING EYE GEL, SUN SCREEN SPRAY, SOOTHING BODY SPRAY, DEODORANT FOR PERSONAL USE, NAIL CARE PREPARATIONS, BODY WASH, BODY GLITTER, NON-MEDICATED LIP CARE PREPARATIONS, NON-MEDICATED MOUTH WASH AND RINSE (U.S. CLS. 1, 4, 6, 50, 51 AND 52).

CAROL SPILS, EXAMINING ATTORNEY

SN 78-863,656. JOHNSON, LORI, PFEFFER, APEX, NC. FILED 4-18-2006.

Oh WoW!

THE MARK CONSISTS OF STANDARD CHARACTERS WITHOUT CLAIM TO ANY PARTICULAR FONT, STYLE, SIZE, OR COLOR.

FOR LIP BALM, LIP CREAM, NON-MEDICATED LIP CARE PREPARATIONS, NON-MEDICATED LIP PROTECTOR (U.S. CLS. 1, 4, 6, 50, 51 AND 52).

JENNY PARK, EXAMINING ATTORNEY

CLASS 3—(Continued).

SN 78-863,796. COTY US LLC, NEW YORK, NY. FILED 4-18-2006.

ALL OVER GLOW

THE MARK CONSISTS OF STANDARD CHARACTERS WITHOUT CLAIM TO ANY PARTICULAR FONT, STYLE, SIZE, OR COLOR.

FOR BEAUTY CREAMS; BODY CREAMS; COSMETIC CREAMS FOR SKIN CARE; COSMETIC SUN-TANNING PREPARATIONS; NON-MEDICATED SKIN CREAMS; SELF-TANNING PREPARATIONS; SKIN MOISTURIZER; SUN CREAMS; SUNTAN CREAMS (U.S. CLS. 1, 4, 6, 50, 51 AND 52).

JOHN GARTNER, EXAMINING ATTORNEY

SN 78-863,960. FRAGRANCE GALLERY, INC., HAUPAUGE, NY. FILED 4-18-2006.

APPRECIATE

THE MARK CONSISTS OF STANDARD CHARACTERS WITHOUT CLAIM TO ANY PARTICULAR FONT, STYLE, SIZE, OR COLOR.

FOR FRAGRANCES FOR PERSONAL USE AND COSMETICS (U.S. CLS. 1, 4, 6, 50, 51 AND 52).

TONJA GASKINS, EXAMINING ATTORNEY

SN 78-864,019. MALLYGIRL LLC, TOWSON, MD. FILED 4-18-2006.

MAKEUP MULTIPLIERS

THE MARK CONSISTS OF STANDARD CHARACTERS WITHOUT CLAIM TO ANY PARTICULAR FONT, STYLE, SIZE, OR COLOR.

NO CLAIM IS MADE TO THE EXCLUSIVE RIGHT TO USE "MAKEUP", APART FROM THE MARK AS SHOWN.

FOR COSMETICS AND MAKE UP (U.S. CLS. 1, 4, 6, 50, 51 AND 52).

TONI HICKEY, EXAMINING ATTORNEY

CLASS 3—(Continued).

SN 78-864,056. MALLYGIRL LLC, TOWSON, MD. FILED 4-18-2006.

SHINELINERS

THE MARK CONSISTS OF STANDARD CHARACTERS WITHOUT CLAIM TO ANY PARTICULAR FONT, STYLE, SIZE, OR COLOR.

FOR COSMETICS AND MAKE UP (U.S. CLS. 1, 4, 6, 50, 51 AND 52).
TONI HICKEY, EXAMINING ATTORNEY

CLASS 3—(Continued).

SN 78-866,386. PRAS, FREDERIC DF, ALBANY, CA. FILED 4-21-2006.



SN 78-865,096. MARSHA N COULTON, DBA CURL JUNKIE HAIR PRODUCTS, BROOKLYN, NY. FILED 4-19-2006.



NO CLAIM IS MADE TO THE EXCLUSIVE RIGHT TO USE "CURL", APART FROM THE MARK AS SHOWN.

THE MARK CONSISTS OF A STYLIZED, LARGER UPPER-CASE "C" FOLLOWED BY THE STYLIZED LOWER-CASE LETTERS "URL". THE SECOND LINE UNDERNEATH CONTAINS THE STYLIZED LETTERS "JUNKIE".

FOR HAIR CARE PREPARATIONS (U.S. CLS. 1, 4, 6, 50, 51 AND 52).

FIRST USE 12-25-2005; IN COMMERCE 2-1-2006.
GINA FINK, EXAMINING ATTORNEY

FOR SHOWER GELS, BATH SOAPS, BODY LOTIONS, FACIAL LOTIONS, LIQUID HAND SOAPS, HAND CREAMS, MASSAGE OILS, ESSENTIAL OILS USED IN PERSONAL CARE, BATH OILS, SCENTED BATH OILS, BATH SALTS, ROOM FRAGRANCES, NATURAL ROOM FRAGRANCES, NATURAL BODY FRAGRANCES, BODY FRAGRANCES, SCENTED BATH SALTS, AROMATIC ROOM SPRAYS (U.S. CLS. 1, 4, 6, 50, 51 AND 52).
JAMES GRIFFIN, EXAMINING ATTORNEY

SN 78-866,882. VICTORIA'S SECRET STORES BRAND MANAGEMENT, INC., REYNOLDSBURG, OH. FILED 4-21-2006.

LATTE LOVE

SN 78-866,337. NEW HORIZONS UNLIMITED, LLC, CARSON CITY, NV. FILED 4-20-2006.

NHU

THE MARK CONSISTS OF STANDARD CHARACTERS WITHOUT CLAIM TO ANY PARTICULAR FONT, STYLE, SIZE, OR COLOR.

FOR SUNSCREEN PREPARATIONS (U.S. CLS. 1, 4, 6, 50, 51 AND 52).

FIRST USE 1-31-2004; IN COMMERCE 8-5-2005.
GEORGE LORENZO, EXAMINING ATTORNEY

THE MARK CONSISTS OF STANDARD CHARACTERS WITHOUT CLAIM TO ANY PARTICULAR FONT, STYLE, SIZE, OR COLOR.

FOR 3-IN-1 HAIR SHAMPOOS; BATH BEADS; BATH FOAMS; BATH GELS; BATH LOTION; BATH OIL; BATH POWDER; BATH SALTS; BATHING LOTIONS; BEAUTY GELS; BODY AND BEAUTY CARE PREPARATIONS; BODY CREAM SOAP; BODY CREAMS; BODY LOTIONS; BODY POWDER; BODY SCRUB; BODY SPRAYS; BUBBLE BATH; COLOGNE; EAU DE PERFUME; FACE AND BODY CREAMS; FACE AND BODY LOTIONS; FACIAL WASHES; FOAM BATH; HAIR CONDITIONERS; HAIR GELS; HAIR SHAMPOO; HAIR SPRAY; HAIR STYLING GEL; HAIR STYLING SPRAY; HAND CREAMS; LIQUID SOAPS FOR HANDS, FACE AND BODY; LOTIONS FOR FACE AND BODY CARE; MASSAGE OILS; SCENTED BODY SPRAY; SHAMPOO-CONDITIONERS; SHAMPOOS; SHOWER AND BATH FOAM; SHOWER AND BATH GEL; SHOWER CREAMS; SHOWER GELS; SOAPS FOR BODY CARE (U.S. CLS. 1, 4, 6, 50, 51 AND 52).

SARAH WAYDA, EXAMINING ATTORNEY

CLASS 3—(Continued).

SN 78-867,286. DR. JAMES L. GEIGER, M.D., OILMD, P.C., GILBERT, AZ. FILED 4-21-2006.

ROMANTIC ENCOUNTERS

THE MARK CONSISTS OF STANDARD CHARACTERS WITHOUT CLAIM TO ANY PARTICULAR FONT, STYLE, SIZE, OR COLOR.

FOR AROMATHERAPY OILS; ESSENTIAL OILS; ESSENTIAL OILS FOR PERSONAL USE; ESSENTIAL OILS FOR USE IN MANUFACTURING OF PRODUCTS TO PROMOTE WELLNESS (U.S. CLS. 1, 4, 6, 50, 51 AND 52).

FIRST USE 11-14-2005; IN COMMERCE 11-14-2005.
DOMINIC FATHY, EXAMINING ATTORNEY

SN 78-867,310. DR. JAMES L. GEIGER, M.D., OILMD, P.C., GILBERT, AZ. FILED 4-21-2006.

MUSCLE WELLNESS

THE MARK CONSISTS OF STANDARD CHARACTERS WITHOUT CLAIM TO ANY PARTICULAR FONT, STYLE, SIZE, OR COLOR.

NO CLAIM IS MADE TO THE EXCLUSIVE RIGHT TO USE "MUSCLE", APART FROM THE MARK AS SHOWN.

FOR AROMATHERAPY OILS; ESSENTIAL OILS; ESSENTIAL OILS FOR PERSONAL USE; ESSENTIAL OILS FOR USE IN MANUFACTURING OF PRODUCTS TO PROMOTE MENTAL AND PHYSICAL WELL-BEING (U.S. CLS. 1, 4, 6, 50, 51 AND 52).

FIRST USE 11-14-2005; IN COMMERCE 11-14-2005.
DOMINIC FATHY, EXAMINING ATTORNEY

SN 78-867,536. KYLE, BRIAN K., DANA POINT, CA. FILED 4-23-2006.

Liquid Resolution

THE MARK CONSISTS OF STANDARD CHARACTERS WITHOUT CLAIM TO ANY PARTICULAR FONT, STYLE, SIZE, OR COLOR.

NO CLAIM IS MADE TO THE EXCLUSIVE RIGHT TO USE "LIQUID", APART FROM THE MARK AS SHOWN.

FOR CD AND DVD CLEANER AND ENHANCER, NAMELY, A FLUID CLEANER FOR USE ON COMPACT DISCS AND DVDS (U.S. CLS. 1, 4, 6, 50, 51 AND 52).

HANNO RITTNER, EXAMINING ATTORNEY

CLASS 3—(Continued).

SN 78-867,792. MIX-MASTERS, INC., DBA JBS INDUSTRIES, LEBANON, OH. FILED 4-24-2006.

REVOLUTION

THE MARK CONSISTS OF STANDARD CHARACTERS WITHOUT CLAIM TO ANY PARTICULAR FONT, STYLE, SIZE, OR COLOR.

FOR LIQUID AND POWDERED DETERGENTS FOR USE IN SELF SERVE AUTOMATIC AND FULL SERVICE CAR WASH APPLICATIONS AS WELL AS DETAILING CENTERS, NEW AND USED AUTO DEALERSHIPS, OTHER VEHICLE SALES/LEASE AND RENTAL COMPANIES; TIRE AND WHEEL CLEANERS; CLEANING PREPARATIONS FOR USE ON TRANSPORTATION VEHICLES OF ALL TYPES INCLUDING AUTOMOBILES, TRUCKS, VANS AND AIRPLANES; LAUNDRY PRE-SOAKS; SPECIALTY PREPARATIONS, NAMELY SURFACTANT BASED PREPARATIONS FOR CLEANING, SHINING AND PROTECTING ALL TRANSPORTATION VEHICLE EXTERIOR SURFACES; AUTOMOBILE SHINING PREPARATIONS (U.S. CLS. 1, 4, 6, 50, 51 AND 52).

FIRST USE 11-1-2005; IN COMMERCE 11-1-2005.
KELLY MCCOY, EXAMINING ATTORNEY

SN 78-868,092. ROCHESTER MIDLAND CORPORATION, ROCHESTER, NY. FILED 4-24-2006.

EnviroGuard

THE MARK CONSISTS OF STANDARD CHARACTERS WITHOUT CLAIM TO ANY PARTICULAR FONT, STYLE, SIZE, OR COLOR.

FOR CLEANING PREPARATIONS FOR USE IN FOOD PROCESSING PLANTS CONSISTING OF AN ACTIVATOR OF CONCENTRATED CITRIC ACID SOLUTION DESIGNED FOR MANUAL USE AND FOAM APPLICATION; DRAIN OPENER, NAMELY, A DRAIN TREATMENT OF LIVING, NON-PATHOGENIC BACTERIA THAT BREAKS DOWN AND LIQUEFIES SOLIDS SUCH AS FATS, PROTEINS, CARBOHYDRATES AND GREASE; AND AN ENVIRONMENTALLY FRIENDLY FLOOR AND GROUT CLEANER THAT UTILIZES BIO-ENZYMATIC ACTION TO PROVIDE IMMEDIATE CLEANING (U.S. CLS. 1, 4, 6, 50, 51 AND 52).

FIRST USE 7-19-2005; IN COMMERCE 2-0-2006.
TINA BROWN, EXAMINING ATTORNEY

CLASS 3—(Continued).

SN 78-868,176. PERFECT SMILE CORPORATION, WES-
TLAKE, OH. FILED 4-24-2006.

PERFECT SMILE

THE MARK CONSISTS OF STANDARD CHARACTERS
WITHOUT CLAIM TO ANY PARTICULAR FONT, STYLE,
SIZE, OR COLOR.

OWNER OF U.S. REG. NO. 2,375,570.
FOR TOOTHPASTE; MOUTH RINSE; DENTIFRICES
IN THE FORM OF CHEWING GUM; KIT CONSISTING
OF TOOTH WHITENING AND POLISHING PREPARA-
TION AND APPLICATOR (U.S. CLS. 1, 4, 6, 50, 51 AND
52).

FIRST USE 1-1-1993; IN COMMERCE 4-22-1993.
HEATHER SAPP, EXAMINING ATTORNEY

CLASS 3—(Continued).

SN 78-868,715. ROSENHAUS, STEVEN, NEW YORK, NY.
FILED 4-25-2006.

FADE TO BLACK

THE MARK CONSISTS OF STANDARD CHARACTERS
WITHOUT CLAIM TO ANY PARTICULAR FONT, STYLE,
SIZE, OR COLOR.

FOR WOMEN'S FRAGRANCES FOR PERSONAL USE,
MEN'S COLOGNES, SCENTED BODY SPRAYS; COS-
METICS, NAMELY, LIPSTICK, MASCARA, EYELINER,
EYE SHADOW, NAIL POLISH, MAKEUP FOUNDATION
AND BLUSH (U.S. CLS. 1, 4, 6, 50, 51 AND 52).

MARK T. MULLEN, EXAMINING ATTORNEY

SN 78-868,228. OVERBROOK ENTERTAINMENT, LLC, BEV-
ERLY HILLS, CA. FILED 4-24-2006.

HAIR FUEL

THE MARK CONSISTS OF STANDARD CHARACTERS
WITHOUT CLAIM TO ANY PARTICULAR FONT, STYLE,
SIZE, OR COLOR.

NO CLAIM IS MADE TO THE EXCLUSIVE RIGHT TO
USE "HAIR", APART FROM THE MARK AS SHOWN.

FOR HAIR SHAMPOO, HAIR CONDITIONER (U.S.
CLS. 1, 4, 6, 50, 51 AND 52).

EUGENIA MARTIN, EXAMINING ATTORNEY

SN 78-869,699. L'OREAL USA CREATIVE, INC., NEW YORK,
NY. FILED 4-26-2006.

IRON-IN CONTROL

THE MARK CONSISTS OF STANDARD CHARACTERS
WITHOUT CLAIM TO ANY PARTICULAR FONT, STYLE,
SIZE, OR COLOR.

FOR HAIR STYLING PREPARATION (U.S. CLS. 1, 4, 6,
50, 51 AND 52).

LINDA M. KING, EXAMINING ATTORNEY

SN 78-868,464. L'OREAL USA CREATIVE, INC., NEW YORK,
NY. FILED 4-24-2006.

EXPERT LASH

THE MARK CONSISTS OF STANDARD CHARACTERS
WITHOUT CLAIM TO ANY PARTICULAR FONT, STYLE,
SIZE, OR COLOR.

OWNER OF U.S. REG. NOS. 1,308,540, 1,745,014 AND
OTHERS.

NO CLAIM IS MADE TO THE EXCLUSIVE RIGHT TO
USE "LASH", APART FROM THE MARK AS SHOWN.

FOR FALSE EYELASHES (U.S. CLS. 1, 4, 6, 50, 51 AND
52).

LINDA M. KING, EXAMINING ATTORNEY

SN 78-869,703. L'OREAL USA CREATIVE, INC., NEW YORK,
NY. FILED 4-26-2006.

MATRIX

THE MARK CONSISTS OF STANDARD CHARACTERS
WITHOUT CLAIM TO ANY PARTICULAR FONT, STYLE,
SIZE, OR COLOR.

OWNER OF U.S. REG. NOS. 1,569,113, 2,529,847 AND
OTHERS.

FOR COSMETICS (U.S. CLS. 1, 4, 6, 50, 51 AND 52).

LINDA M. KING, EXAMINING ATTORNEY

CLASS 3—(Continued).

SN 78-869,762. L'OREAL USA CREATIVE, INC., NEW YORK, NY. FILED 4-26-2006.

VAVOOM

THE MARK CONSISTS OF STANDARD CHARACTERS WITHOUT CLAIM TO ANY PARTICULAR FONT, STYLE, SIZE, OR COLOR.

OWNER OF U.S. REG. NOS. 1,484,947 AND 1,782,350. FOR COSMETICS (U.S. CLS. 1, 4, 6, 50, 51 AND 52). LINDA M. KING, EXAMINING ATTORNEY

SN 78-869,956. MCCABE, ROBERT F., LAKE WORTH, FL. FILED 4-26-2006.

PALM BAY

THE MARK CONSISTS OF STANDARD CHARACTERS WITHOUT CLAIM TO ANY PARTICULAR FONT, STYLE, SIZE, OR COLOR.

FOR DEODORANT FOR PERSONAL USE; HAIR SPRAY; SHAVING PREPARATIONS; SKIN MOISTURIZER (U.S. CLS. 1, 4, 6, 50, 51 AND 52). WANDA KAY PRICE, EXAMINING ATTORNEY

SN 78-872,146. QUALCHEM CORPORATION, EAST RUTHERFORD, NJ. FILED 4-28-2006.

SHOWER RELIEF

THE MARK CONSISTS OF STANDARD CHARACTERS WITHOUT CLAIM TO ANY PARTICULAR FONT, STYLE, SIZE, OR COLOR.

NO CLAIM IS MADE TO THE EXCLUSIVE RIGHT TO USE "SHOWER", APART FROM THE MARK AS SHOWN. FOR TABLETS FOR DISPERSION OF SOOTHING VAPORS AND AROMA WHEN DISSOLVED IN WATER (U.S. CLS. 1, 4, 6, 50, 51 AND 52).

FRED CARL, EXAMINING ATTORNEY

CLASS 3—(Continued).

SN 78-872,279. KEY BRANDS INTERNATIONAL, LTD., IRVINDALE, CA. FILED 4-28-2006.

B-FUSION

THE MARK CONSISTS OF STANDARD CHARACTERS WITHOUT CLAIM TO ANY PARTICULAR FONT, STYLE, SIZE, OR COLOR.

FOR HAIR SHAMPOO (U.S. CLS. 1, 4, 6, 50, 51 AND 52).

FIRST USE 7-23-1985; IN COMMERCE 7-23-1985.

KELLEY WELLS, EXAMINING ATTORNEY

SN 78-872,590. MALLYGIRL LLC, TOWSON, MD. FILED 4-28-2006.

LIFT, SHAPE & GLOW

THE MARK CONSISTS OF STANDARD CHARACTERS WITHOUT CLAIM TO ANY PARTICULAR FONT, STYLE, SIZE, OR COLOR.

FOR COSMETICS; MAKEUP; FACE DEFINING SYSTEM, NAMELY, COMPACT MAKEUP POWDER KIT CONTAINING MAKEUP, BRUSHES, MIRROR AND INSTRUCTIONAL GUIDE (U.S. CLS. 1, 4, 6, 50, 51 AND 52).

TONI HICKEY, EXAMINING ATTORNEY

SN 78-872,673. SPERANCIA, LLC, ARLINGTON, TX. FILED 4-28-2006.

SPERANCIA

THE MARK CONSISTS OF STANDARD CHARACTERS WITHOUT CLAIM TO ANY PARTICULAR FONT, STYLE, SIZE, OR COLOR.

FOR AFTER-SHAVE CREAMS; AFTER-SHAVE LOTIONS; BATH CRYSTALS; BATH FOAM; BATH GELS; BATH LOTION; BATH OILS; BATH SALTS; BATH SOAPS IN LIQUID, SOLID OR GEL FORM; BEAUTY CREAMS FOR BODY CARE; BODY AND BEAUTY CARE COSMETICS; BODY CREAM SOAP; BODY CREAMS; BODY LOTION; BODY OIL; COSMETIC CREAMS; CREAM SOAPS; FACE CREAMS FOR COSMETIC USE; HAIR CARE CREAMS; HAIR CARE LOTIONS; HAIR CLEANING PREPARATIONS; LOTIONS FOR FACE AND BODY CARE; SCENTED BODY SPRAY; SHAVING BALM; SHAVING GEL; SHAVING LOTIONS; SHAVING SOAP; SKIN LOTIONS; SOAPS FOR BODY CARE (U.S. CLS. 1, 4, 6, 50, 51 AND 52).

FIRST USE 4-1-2006; IN COMMERCE 4-1-2006.

MATTHEW MCDOWELL, EXAMINING ATTORNEY

CLASS 3—(Continued).

SN 78-874,419. AVEDA CORPORATION, MINNEAPOLIS, MN. FILED 5-2-2006.

CREATIVITY

THE MARK CONSISTS OF STANDARD CHARACTERS WITHOUT CLAIM TO ANY PARTICULAR FONT, STYLE, SIZE, OR COLOR.

FOR BODY AND BEAUTY CARE PREPARATIONS; COLOGNE; NON-MEDICATED BATH PREPARATIONS; PERFUME (U.S. CLS. 1, 4, 6, 50, 51 AND 52).

FIRST USE 11-5-1997; IN COMMERCE 11-5-1997.
DOMINIC FATHY, EXAMINING ATTORNEY

CLASS 3—(Continued).

SN 78-878,567. COTY US LLC, NEW YORK, NY. FILED 5-8-2006.

TRIPLE POWER

THE MARK CONSISTS OF STANDARD CHARACTERS WITHOUT CLAIM TO ANY PARTICULAR FONT, STYLE, SIZE, OR COLOR.

FOR COSMETICS, BEAUTY AND BODY CARE PREPARATIONS, NAMELY, BODY, SKIN AND FACE LOTIONS, SERUMS, GELS, CREAMS AND MOISTURIZERS (U.S. CLS. 1, 4, 6, 50, 51 AND 52).

JOHN GARTNER, EXAMINING ATTORNEY

SN 78-875,382. AUSTRALIAN GOLD, INC., INDIANAPOLIS, IN. FILED 5-3-2006.

**BEAUTIFUL TAN...BEAUTIFUL
SKIN**

THE MARK CONSISTS OF STANDARD CHARACTERS WITHOUT CLAIM TO ANY PARTICULAR FONT, STYLE, SIZE, OR COLOR.

FOR NON-MEDICATED SKIN CARE PRODUCTS, NAMELY, INDOOR AND OUTDOOR TANNING PREPARATIONS (U.S. CLS. 1, 4, 6, 50, 51 AND 52).

FIRST USE 11-1-2004; IN COMMERCE 11-1-2004.
WON TEAK OH, EXAMINING ATTORNEY

SN 78-882,669. L'OREAL USA CREATIVE, INC., NEW YORK, NY. FILED 5-12-2006.

ENAMEL GEL

THE MARK CONSISTS OF STANDARD CHARACTERS WITHOUT CLAIM TO ANY PARTICULAR FONT, STYLE, SIZE, OR COLOR.

OWNER OF U.S. REG. NO. 2,445,154.
NO CLAIM IS MADE TO THE EXCLUSIVE RIGHT TO USE "GEL", APART FROM THE MARK AS SHOWN.

FOR HAIR STYLING PREPARATION (U.S. CLS. 1, 4, 6, 50, 51 AND 52).

VERNA BETH RIRIE, EXAMINING ATTORNEY

SN 78-878,496. COTY US LLC, NEW YORK, NY. FILED 5-8-2006.

DOUBLE POWER

THE MARK CONSISTS OF STANDARD CHARACTERS WITHOUT CLAIM TO ANY PARTICULAR FONT, STYLE, SIZE, OR COLOR.

FOR COSMETICS, BEAUTY AND BODY CARE PREPARATIONS, NAMELY, BODY, SKIN AND FACE LOTIONS, SERUMS, GELS, CREAMS AND MOISTURIZERS (U.S. CLS. 1, 4, 6, 50, 51 AND 52).

JOHN GARTNER, EXAMINING ATTORNEY

SN 78-883,306. COTY US LLC, NEW YORK, NY. FILED 5-15-2006.

GET JUIC'D

THE MARK CONSISTS OF STANDARD CHARACTERS WITHOUT CLAIM TO ANY PARTICULAR FONT, STYLE, SIZE, OR COLOR.

FOR BODY LOTIONS; BODY SPRAYS; COSMETICS (U.S. CLS. 1, 4, 6, 50, 51 AND 52).

JOHN GARTNER, EXAMINING ATTORNEY

CLASS 3—(Continued).

SN 78-890,090. L'OREAL USA CREATIVE, INC., NEW YORK, NY. FILED 5-23-2006.

CLASS 3—(Continued).

SN 78-896,683. MALLYGIRL LLC, TOWSON, MD. FILED 5-31-2006.

BUST OUT BODY

THE MARK CONSISTS OF STANDARD CHARACTERS WITHOUT CLAIM TO ANY PARTICULAR FONT, STYLE, SIZE, OR COLOR.
FOR HAIRCARE PREPARATIONS (U.S. CLS. 1, 4, 6, 50, 51 AND 52).
VERNA BETH RIRIE, EXAMINING ATTORNEY

MATTEWAND

THE MARK CONSISTS OF STANDARD CHARACTERS WITHOUT CLAIM TO ANY PARTICULAR FONT, STYLE, SIZE, OR COLOR.
FOR COSMETICS; EYE MAKEUP (U.S. CLS. 1, 4, 6, 50, 51 AND 52).
TONI HICKEY, EXAMINING ATTORNEY

SN 78-893,256. STEPHENS, SCOTT A., FAIRFAX, VA. FILED 5-25-2006.

SN 78-901,849. L'OREAL USA CREATIVE, INC., NEW YORK, NY. FILED 6-6-2006.

FrogSnot

THE MARK CONSISTS OF STANDARD CHARACTERS WITHOUT CLAIM TO ANY PARTICULAR FONT, STYLE, SIZE, OR COLOR.
FOR AFTER SUN CREAMS; LIP BALM (U.S. CLS. 1, 4, 6, 50, 51 AND 52).
YONG KIM, EXAMINING ATTORNEY

SLEEK OBEDIENCE

THE MARK CONSISTS OF STANDARD CHARACTERS WITHOUT CLAIM TO ANY PARTICULAR FONT, STYLE, SIZE, OR COLOR.
FOR HAIR CARE PREPARATION (U.S. CLS. 1, 4, 6, 50, 51 AND 52).
VERNA BETH RIRIE, EXAMINING ATTORNEY

SN 78-895,557. BONNE BELL, INC., LAKEWOOD, OH. FILED 5-30-2006.

SN 78-901,995. L'OREAL USA CREATIVE, INC., NEW YORK, NY. FILED 6-6-2006.

THE ORIGINAL FUN-FLAVORED LIP BALM

THE MARK CONSISTS OF STANDARD CHARACTERS WITHOUT CLAIM TO ANY PARTICULAR FONT, STYLE, SIZE, OR COLOR.
NO CLAIM IS MADE TO THE EXCLUSIVE RIGHT TO USE ORIGINAL AND LIP BALM, APART FROM THE MARK AS SHOWN.
FOR NON-MEDICATED LIP COSMETICS, NAMELY, COSMETIC PREPARATIONS FOR MOISTURIZING AND PROTECTING AGAINST SUNBURN AND CHAPPING, LIP BALM, LIPSTICK AND LIP GLOSS (U.S. CLS. 1, 4, 6, 50, 51 AND 52).
KATRINA EDGE, EXAMINING ATTORNEY

SUPERSTAY SILKY

THE MARK CONSISTS OF STANDARD CHARACTERS WITHOUT CLAIM TO ANY PARTICULAR FONT, STYLE, SIZE, OR COLOR.
FOR COSMETICS, NAMELY, FOUNDATION MAKEUP (U.S. CLS. 1, 4, 6, 50, 51 AND 52).
VERNA BETH RIRIE, EXAMINING ATTORNEY

CLASS 3—(Continued).

SN 78-903,816. 3M COMPANY, ST. PAUL, MN. FILED 6-8-2006.

ULTRAFINA

THE MARK CONSISTS OF STANDARD CHARACTERS WITHOUT CLAIM TO ANY PARTICULAR FONT, STYLE, SIZE, OR COLOR.

FOR COMPOUNDS FOR REMOVING SWIRL MARKS AND SCRATCHES IN AUTOMOTIVE PAINT FINISHES; LIQUIDS AND PREPARATIONS FOR CLEANING, SANDING, POLISHING, REFINISHING, BUFFING, GLAZING, WAXING, RESTORING OR PRESERVING FINISHED SURFACES OF MOTORIZED VEHICLES (U.S. CLS. 1, 4, 6, 50, 51 AND 52).

PAM WILLIS, EXAMINING ATTORNEY

SN 78-904,165. L'OREAL USA CREATIVE, INC., NEW YORK, NY. FILED 6-8-2006.

SHIMMERING DEFENSE

THE MARK CONSISTS OF STANDARD CHARACTERS WITHOUT CLAIM TO ANY PARTICULAR FONT, STYLE, SIZE, OR COLOR.

FOR HAIR TREATMENT PREPARATION (U.S. CLS. 1, 4, 6, 50, 51 AND 52).

VERNA BETH RIRIE, EXAMINING ATTORNEY

SN 78-904,882. CHURCH & DWIGHT CO., INC., PRINCETON, NJ. FILED 6-9-2006.

PURE PERFORMANCE

THE MARK CONSISTS OF STANDARD CHARACTERS WITHOUT CLAIM TO ANY PARTICULAR FONT, STYLE, SIZE, OR COLOR.

FOR FABRIC SOFTENERS; FABRIC SOFTENERS FOR LAUNDRY USE; LAUNDRY DETERGENT (U.S. CLS. 1, 4, 6, 50, 51 AND 52).

TANYA AMOS, EXAMINING ATTORNEY

CLASS 3—(Continued).

SN 78-905,592. VICTORIA'S SECRET STORES BRAND MANAGEMENT, INC., REYNOLDSBURG, OH. FILED 6-12-2006.

GIVE ME GLIMMER

THE MARK CONSISTS OF STANDARD CHARACTERS WITHOUT CLAIM TO ANY PARTICULAR FONT, STYLE, SIZE, OR COLOR.

FOR BODY LOTIONS (U.S. CLS. 1, 4, 6, 50, 51 AND 52).

SARAH WAYDA, EXAMINING ATTORNEY

SN 78-905,602. VICTORIA'S SECRET STORES BRAND MANAGEMENT, INC., REYNOLDSBURG, OH. FILED 6-12-2006.

I'M SO ILLUMINATING

THE MARK CONSISTS OF STANDARD CHARACTERS WITHOUT CLAIM TO ANY PARTICULAR FONT, STYLE, SIZE, OR COLOR.

FOR BODY LOTIONS (U.S. CLS. 1, 4, 6, 50, 51 AND 52).

SARAH WAYDA, EXAMINING ATTORNEY

SN 78-905,736. 3LAB, INC., ENGLEWOOD, NJ. FILED 6-12-2006.

Hydranox

THE MARK CONSISTS OF STANDARD CHARACTERS WITHOUT CLAIM TO ANY PARTICULAR FONT, STYLE, SIZE, OR COLOR.

FOR CHEMICAL ADDITIVES FOR USE AS INGREDIENTS IN COSMETICS, SOLD AS PART OF THE FINISHED COSMETIC PRODUCTS (U.S. CLS. 1, 4, 6, 50, 51 AND 52).

ELIZABETH HUGHITT, EXAMINING ATTORNEY

CLASS 3—(Continued).

SN 78-905,942. 3LAB, INC., ENGLEWOOD, NJ. FILED 6-12-2006.

Promatryx

THE MARK CONSISTS OF STANDARD CHARACTERS WITHOUT CLAIM TO ANY PARTICULAR FONT, STYLE, SIZE, OR COLOR.

FOR CHEMICAL ADDITIVES FOR USE AS INGREDIENTS IN COSMETICS, SOLD AS PART OF THE FINISHED COSMETIC PRODUCTS (U.S. CLS. 1, 4, 6, 50, 51 AND 52).

ELIZABETH HUGHITT, EXAMINING ATTORNEY

SN 78-907,735. FRAGRANCE GALLERY, INC., HAUPAUGE, NY. FILED 6-14-2006.

CASINO SPORT

THE MARK CONSISTS OF STANDARD CHARACTERS WITHOUT CLAIM TO ANY PARTICULAR FONT, STYLE, SIZE, OR COLOR.

NO CLAIM IS MADE TO THE EXCLUSIVE RIGHT TO USE SPORT, APART FROM THE MARK AS SHOWN.

FOR FRAGRANCES AND COSMETICS, NAMELY, EAU DE PARFUM, EAU DE TOILETTE, EAU DE COLOGNE, BODY LOTION, BATH AND SHOWER GEL, DUSTING POWDER, BODY SCENT AND PERSONAL DEODORANTS (U.S. CLS. 1, 4, 6, 50, 51 AND 52).

FIRST USE 3-21-2001; IN COMMERCE 3-21-2001.

TONJA GASKINS, EXAMINING ATTORNEY

SN 78-907,784. PRESCRIPTIVES INC., NEW YORK, NY. FILED 6-14-2006.

DIMENSIONAL OPTICS

THE MARK CONSISTS OF STANDARD CHARACTERS WITHOUT CLAIM TO ANY PARTICULAR FONT, STYLE, SIZE, OR COLOR.

FOR COSMETIC INGREDIENT COMPLEX SOLD AS AN INTEGRAL COMPONENT OF COSMETICS (U.S. CLS. 1, 4, 6, 50, 51 AND 52).

MATTHEW MCDOWELL, EXAMINING ATTORNEY

CLASS 3—(Continued).

SN 78-908,080. PRESCRIPTIVES INC., NEW YORK, NY. FILED 6-14-2006.

MULTI-LIFT POLYMER

THE MARK CONSISTS OF STANDARD CHARACTERS WITHOUT CLAIM TO ANY PARTICULAR FONT, STYLE, SIZE, OR COLOR.

NO CLAIM IS MADE TO THE EXCLUSIVE RIGHT TO USE "POLYMER", APART FROM THE MARK AS SHOWN.

FOR COSMETIC INGREDIENT COMPLEX SOLD AS AN INTEGRAL COMPONENT OF COSMETICS (U.S. CLS. 1, 4, 6, 50, 51 AND 52).

MATTHEW MCDOWELL, EXAMINING ATTORNEY

SN 78-908,092. L'OREAL USA CREATIVE, INC., NEW YORK, NY. FILED 6-14-2006.

SHINESEDUCTION

THE MARK CONSISTS OF STANDARD CHARACTERS WITHOUT CLAIM TO ANY PARTICULAR FONT, STYLE, SIZE, OR COLOR.

FOR LIP COLOR (U.S. CLS. 1, 4, 6, 50, 51 AND 52).

LINDA M. KING, EXAMINING ATTORNEY

SN 78-908,318. CHURCH & DWIGHT CO., INC., PRINCETON, NJ. FILED 6-14-2006.

HARNESSING THE POWER OF NATURE

THE MARK CONSISTS OF STANDARD CHARACTERS WITHOUT CLAIM TO ANY PARTICULAR FONT, STYLE, SIZE, OR COLOR.

FOR LAUNDRY DETERGENT (U.S. CLS. 1, 4, 6, 50, 51 AND 52).

TANYA AMOS, EXAMINING ATTORNEY

CLASS 3—(Continued).

SN 78-909,348. CHANEL, INC., NEW YORK, NY. FILED 6-15-2006.

SUBLIMAGE

THE MARK CONSISTS OF STANDARD CHARACTERS WITHOUT CLAIM TO ANY PARTICULAR FONT, STYLE, SIZE, OR COLOR.

FOR NON-MEDICATED SKIN CARE PREPARATIONS (U.S. CLS. 1, 4, 6, 50, 51 AND 52).

MARK SPARACINO, EXAMINING ATTORNEY

SN 78-922,462. DR PEPPER/SEVEN UP, INC., PLANO, TX. FILED 7-5-2006.

7UP

THE MARK CONSISTS OF STANDARD CHARACTERS WITHOUT CLAIM TO ANY PARTICULAR FONT, STYLE, SIZE, OR COLOR.

OWNER OF U.S. REG. NOS. 801,421, 3,055,510 AND OTHERS.

FOR COSMETIC PRODUCTS, NAMELY LIP BALM AND LIP GLOSS (U.S. CLS. 1, 4, 6, 50, 51 AND 52).

FIRST USE 8-10-1981; IN COMMERCE 8-10-1981.

ANTHONY RINKER, EXAMINING ATTORNEY

SN 78-922,578. DR PEPPER/SEVEN UP, INC., PLANO, TX. FILED 7-5-2006.

DR PEPPER

THE MARK CONSISTS OF STANDARD CHARACTERS WITHOUT CLAIM TO ANY PARTICULAR FONT, STYLE, SIZE, OR COLOR.

OWNER OF U.S. REG. NOS. 50,668, 2,975,776 AND OTHERS.

FOR COSMETIC PRODUCTS, NAMELY LIP BALM AND LIP GLOSS (U.S. CLS. 1, 4, 6, 50, 51 AND 52).

FIRST USE 8-10-1981; IN COMMERCE 8-10-1981.

ANTHONY RINKER, EXAMINING ATTORNEY

CLASS 3—(Continued).

SN 78-924,213. OVERRIDE COSMETICS, LLC, NEW YORK, NY. FILED 7-7-2006.

SKIN OVERRIDE COMPLEX

THE MARK CONSISTS OF STANDARD CHARACTERS WITHOUT CLAIM TO ANY PARTICULAR FONT, STYLE, SIZE, OR COLOR.

NO CLAIM IS MADE TO THE EXCLUSIVE RIGHT TO USE SKIN AND COMPLEX, APART FROM THE MARK AS SHOWN.

FOR COSMETICS (U.S. CLS. 1, 4, 6, 50, 51 AND 52).

KATHERINE STOIDES, EXAMINING ATTORNEY

SN 78-927,094. CHURCH & DWIGHT CO., INC., PRINCETON, NJ. FILED 7-11-2006.

SOFTENS THROUGH THE POWER OF NATURE

THE MARK CONSISTS OF STANDARD CHARACTERS WITHOUT CLAIM TO ANY PARTICULAR FONT, STYLE, SIZE, OR COLOR.

FOR ANTI-STATIC DRYER SHEETS; ANTI-STATIC SPRAY FOR CLOTHING; ESSENTIAL OILS AS PERFUME FOR LAUNDRY PURPOSES; FABRIC SOFTENERS; FABRIC SOFTENERS FOR LAUNDRY USE; LAUNDRY BLEACH; LAUNDRY DETERGENT; LAUNDRY PRE-SOAK; LAUNDRY SIZING; LAUNDRY SOAP; SOAPS AND DETERGENTS; SOAPS FOR HOUSEHOLD USE; SPOT REMOVER; STAIN REMOVERS; UPHOLSTERY CLEANERS (U.S. CLS. 1, 4, 6, 50, 51 AND 52).

TANYA AMOS, EXAMINING ATTORNEY

SN 78-928,155. DR PEPPER/SEVEN UP, INC., PLANO, TX. FILED 7-12-2006.



OWNER OF U.S. REG. NOS. 187,791, 2,418,266 AND OTHERS.

FOR COSMETIC PRODUCTS, NAMELY LIP BALM AND LIP GLOSS (U.S. CLS. 1, 4, 6, 50, 51 AND 52).

FIRST USE 8-10-1981; IN COMMERCE 8-10-1981.

ANTHONY RINKER, EXAMINING ATTORNEY

CLASS 3—(Continued).

SN 78-942,873. PRESCRIPTIVES INC., NEW YORK, NY.
FILED 8-2-2006.

PERFECT EVERY LINE

THE MARK CONSISTS OF STANDARD CHARACTERS
WITHOUT CLAIM TO ANY PARTICULAR FONT, STYLE,
SIZE, OR COLOR.
FOR COSMETICS (U.S. CLS. 1, 4, 6, 50, 51 AND 52).
MATTHEW MCDOWELL, EXAMINING ATTORNEY

SN 78-942,925. PRESCRIPTIVES INC., NEW YORK, NY.
FILED 8-2-2006.

VIRTUALLY FRESH

THE MARK CONSISTS OF STANDARD CHARACTERS
WITHOUT CLAIM TO ANY PARTICULAR FONT, STYLE,
SIZE, OR COLOR.
FOR COSMETICS (U.S. CLS. 1, 4, 6, 50, 51 AND 52).
MATTHEW MCDOWELL, EXAMINING ATTORNEY

SN 78-948,785. PRESCRIPTIVES INC., NEW YORK, NY.
FILED 8-9-2006.

SITE UNSEEN

THE MARK CONSISTS OF STANDARD CHARACTERS
WITHOUT CLAIM TO ANY PARTICULAR FONT, STYLE,
SIZE, OR COLOR.
FOR COSMETICS (U.S. CLS. 1, 4, 6, 50, 51 AND 52).
MATTHEW MCDOWELL, EXAMINING ATTORNEY

SN 78-948,805. PRESCRIPTIVES INC., NEW YORK, NY.
FILED 8-9-2006.

GOOD IN BED

THE MARK CONSISTS OF STANDARD CHARACTERS
WITHOUT CLAIM TO ANY PARTICULAR FONT, STYLE,
SIZE, OR COLOR.
FOR COSMETICS; NON-MEDICATED SKIN CARE
PREPARATIONS (U.S. CLS. 1, 4, 6, 50, 51 AND 52).
MATTHEW MCDOWELL, EXAMINING ATTORNEY

CLASS 3—(Continued).

SN 78-955,596. ARBONNE INTERNATIONAL, LLC, IRVINE,
CA. FILED 8-18-2006.

f.y.i. Arbonne

THE MARK CONSISTS OF STANDARD CHARACTERS
WITHOUT CLAIM TO ANY PARTICULAR FONT, STYLE,
SIZE, OR COLOR.
OWNER OF U.S. REG. NOS. 1,770,981, 2,096,008 AND
OTHERS.
FOR BODY CREAMS; BODY SPRAYS; EYESHADOWS;
LIP GLOSS; MAKE UP FOUNDATIONS; NON-MEDI-
CATED SKIN CARE PREPARATIONS; SOAPS FOR
BODY CARE (U.S. CLS. 1, 4, 6, 50, 51 AND 52).
KATHERINE STOIDES, EXAMINING ATTORNEY

SN 78-961,972. L'OREAL USA CREATIVE, INC., FLOOR 34,
NY. FILED 8-28-2006.

STYLETHERAPIE

THE MARK CONSISTS OF STANDARD CHARACTERS
WITHOUT CLAIM TO ANY PARTICULAR FONT, STYLE,
SIZE, OR COLOR.
OWNER OF U.S. REG. NOS. 2,968,797, 2,974,638 AND
3,071,959.
FOR HAIR STYLING PREPARATIONS (U.S. CLS. 1, 4,
6, 50, 51 AND 52).
LINDA M. KING, EXAMINING ATTORNEY

SN 79-016,284. SPACE NK LIMITED, UNITED KINGDOM,
FILED 8-11-2005.

COMPELLING

THE MARK CONSISTS OF STANDARD CHARACTERS
WITHOUT CLAIM TO ANY PARTICULAR FONT, STYLE,
SIZE, OR COLOR.
PRIORITY DATE OF 3-29-2005 IS CLAIMED.
OWNER OF INTERNATIONAL REGISTRATION 0864719
DATED 8-11-2005, EXPIRES 8-11-2015.
FOR BODY LOTION; HAND LOTION; SOAPS;
SHOWER AND BATH PREPARATIONS, NAMELY,
BODY WASH, BATH OILS AND BATH TABLETS; NON-
MEDICATED HANDWASH; PERFUMES, NAMELY, EAU
DE TOILETTE; DEODORANTS FOR PERSONAL USE
(U.S. CLS. 1, 4, 6, 50, 51 AND 52).
MARK RADEMACHER, EXAMINING ATTORNEY

CLASS 3—(Continued).

SN 79-019,818. DEBORAH GROUP B.V., NETHERLANDS, FILED 8-23-2005.

DEBORAH

OWNER OF INTERNATIONAL REGISTRATION 0446520 DATED 7-19-1979, EXPIRES 7-19-2009.

FOR SOAPS; PERFUMERY; ESSENTIAL OILS; BODY AND BEAUTY-CARE PREPARATIONS; HAIR LOTIONS; AND DENTIFRICES (U.S. CLS. 1, 4, 6, 50, 51 AND 52).
INGRID C. EULIN, EXAMINING ATTORNEY

SN 79-023,443. PARFUMS CHRISTIAN DIOR SA, FRANCE, FILED 3-15-2006.



PRIORITY DATE OF 9-27-2005 IS CLAIMED. OWNER OF INTERNATIONAL REGISTRATION 0883866 DATED 3-15-2006, EXPIRES 3-15-2016.

OWNER OF U.S. REG. NOS. 577,253 AND 3,085,164. NO CLAIM IS MADE TO THE EXCLUSIVE RIGHT TO USE "CREME", APART FROM THE MARK AS SHOWN.

THE ENGLISH TRANSLATION OF THE WORD CHERIE IN THE MARK IS DARLING OR DEAREST.

FOR PERFUMED CREAM FOR BODY CARE (U.S. CLS. 1, 4, 6, 50, 51 AND 52).
HEATHER THOMPSON, EXAMINING ATTORNEY

CLASS 4—LUBRICANTS AND FUELS

SN 76-655,616. SERVICES GROUP, INC., STOCKTON, CA, FILED 2-24-2006.



THE COLOR(S) RED, BLUE AND BLACK ARE CLAIMED AS FEATURES OF THE MARK IS/ARE CLAIMED AS A FEATURE OF THE MARK.

THE COLOR RED APPEARS IN THE HORIZONTAL LINE UNDER THE WORDING "KIVA ENERGY"; THE LETTERING KIVA APPEARS IN BLUE; AND THE WORDING ENERGY APPEARS IN BLACK.

FOR PROPANE GAS, AND PROPANE GAS SOLD IN CYLINDRICAL CONTAINERS FOR USE WITH COOKING GRILLS (U.S. CLS. 1, 6 AND 15).
TINA L. SNAPP, EXAMINING ATTORNEY

CLASS 4—(Continued).

SN 76-657,199. MUTUAL OIL CO., INC., BROCKTON, MA, FILED 3-23-2006.

MUTUAL OIL CO., INC.

THE MARK CONSISTS OF STANDARD CHARACTERS WITHOUT CLAIM TO ANY PARTICULAR FONT, STYLE, SIZE, OR COLOR.

NO CLAIM IS MADE TO THE EXCLUSIVE RIGHT TO USE "OIL CO., INC.", APART FROM THE MARK AS SHOWN.

FOR FUELS, OILS, PETROLEUM PRODUCTS AND DERIVATIVES - NAMELY, GASOLINE, HOME HEATING OIL, AND DIESEL FUEL (U.S. CLS. 1, 6 AND 15).

FIRST USE 6-6-1942; IN COMMERCE 10-7-1969.
TRACY CROSS, EXAMINING ATTORNEY

SN 76-659,728. DESERT WHALE JOJOBA COMPANY, INC., TUCSON, AZ, FILED 5-1-2006.

DESERT WHALE JOJOBA COMPANY

NO CLAIM IS MADE TO THE EXCLUSIVE RIGHT TO USE "JOJOBA COMPANY", APART FROM THE MARK AS SHOWN.

FOR OILS, WAXES, FATS AND LIPIDS FOR USE IN THE MANUFACTURE OF OTHER PRODUCTS (U.S. CLS. 1, 6 AND 15).

FIRST USE 7-30-1979; IN COMMERCE 7-30-1979.
IRA J. GOODSaid, EXAMINING ATTORNEY

SN 78-610,080. HENKEL KGAA, DUESSELDORF, FED REP GERMANY, FILED 4-15-2005.



OWNER OF U.S. REG. NOS. 981,467 AND 2,674,230. THE COLOR(S) RED AND WHITE IS/ARE CLAIMED AS A FEATURE OF THE MARK.

THE MARK CONSISTS OF THE WORD "HENKEL" SURROUNDED BY AN OVAL. THE COLOR RED IS USED FOR THE WORD "HENKEL" AND FOR THE OVAL. THE COLOR WHITE IS USED FOR THE INTERIOR OF THE OVAL.

FOR HOUSE MARK FOR A LINE OF INDUSTRIAL LUBRICANTS (U.S. CLS. 1, 6 AND 15).
SEAN CROWLEY, EXAMINING ATTORNEY

CLASS 4—(Continued).

SN 78-622,693. NGAS RESOURCES, INC., LEXINGTON, KY.
FILED 5-4-2005.



OWNER OF U.S. REG. NO. 2,800,210.
FOR CRUDE OIL AND NATURAL GAS (U.S. CLS. 1, 6
AND 15).
FIRST USE 5-20-2004; IN COMMERCE 5-20-2004.
CHRIS WELLS, EXAMINING ATTORNEY

SN 78-693,463. S. C. JOHNSON & SON, INC., RACINE, WI.
FILED 8-16-2005.

PRADERA DE LAVANDA

THE MARK CONSISTS OF STANDARD CHARACTERS
WITHOUT CLAIM TO ANY PARTICULAR FONT, STYLE,
SIZE, OR COLOR.

OWNER OF U.S. REG. NOS. 2,293,051, 2,953,529 AND
OTHERS.

NO CLAIM IS MADE TO THE EXCLUSIVE RIGHT TO
USE "LAVANDA", APART FROM THE MARK AS SHOWN.
THE FOREIGN WORDING IN THE MARK TRANSLATES
INTO ENGLISH AS LAVENDER MEADOW.

FOR CANDLES (U.S. CLS. 1, 6 AND 15).
FIRST USE 7-11-2005; IN COMMERCE 7-11-2005.
LINDA E. BLOHM, EXAMINING ATTORNEY

SN 78-805,471. COOK, HEIDI, GILROY, CA. FILED 2-2-2006.

Third Date

THE MARK CONSISTS OF STANDARD CHARACTERS
WITHOUT CLAIM TO ANY PARTICULAR FONT, STYLE,
SIZE, OR COLOR.

FOR SCENTED CANDLES (U.S. CLS. 1, 6 AND 15).
FIRST USE 8-4-2005; IN COMMERCE 8-4-2005.
ANDREA K. NADELMAN, EXAMINING ATTORNEY

CLASS 4—(Continued).

SN 78-832,570. CITGO PETROLEUM CORPORATION,
HOUSTON, TX. FILED 3-8-2006.

BLEND-KOTE

THE MARK CONSISTS OF STANDARD CHARACTERS
WITHOUT CLAIM TO ANY PARTICULAR FONT, STYLE,
SIZE, OR COLOR.

FOR WAX FOR USE IN INDUSTRIAL APPLICATIONS
(U.S. CLS. 1, 6 AND 15).

FIRST USE 9-1-1969; IN COMMERCE 9-1-1969.
TONJA GASKINS, EXAMINING ATTORNEY

SN 78-850,021. JOHNSON, THOMAS J., NEWMAN GROVE,
NE. FILED 3-30-2006.



THE APPLICANT CLAIMS COLOR AS A FEATURE OF
THE MARK, NAMELY, RED, YELLOW, ORANGE, WHITE
AND BLACK.

THE MARK CONSISTS OF THE WORDS FIRE AND
CORN APPEARING IN RED AND FORMING FLAMES,
AND A STYLIZED REPRESENTATION OF A PERSON IN
YELLOW, ORANGE, RED, WHITE AND BLACK RESEMBLING
A KERNEL OF CORN AND APPEARING BETWEEN
THE WORDS FIRE AND CORN.

FOR FUEL PELLETS (U.S. CLS. 1, 6 AND 15).
FIRST USE 11-18-2005; IN COMMERCE 11-18-2005.
KATHERINE CHANG, EXAMINING ATTORNEY

SN 78-854,690. OAK INTERNATIONAL, INC., STURGIS, MI.
FILED 4-5-2006.

OAK DRAW

THE MARK CONSISTS OF STANDARD CHARACTERS
WITHOUT CLAIM TO ANY PARTICULAR FONT, STYLE,
SIZE, OR COLOR.

FOR INDUSTRIAL LUBRICANTS, NAMELY, LUBRI-
CANTS USED IN METALWORKING (U.S. CLS. 1, 6 AND
15).

FIRST USE 7-30-1991; IN COMMERCE 7-30-1991.
GIANCARLO CASTRO, EXAMINING ATTORNEY

CLASS 4—(Continued).

SN 78-866,453. WICKED GOOD CHARCOAL, INC., WEST NEWFIELD, ME. FILED 4-21-2006.

Wicked Good Charcoal

THE MARK CONSISTS OF STANDARD CHARACTERS WITHOUT CLAIM TO ANY PARTICULAR FONT, STYLE, SIZE, OR COLOR.

NO CLAIM IS MADE TO THE EXCLUSIVE RIGHT TO USE "CHARCOAL", APART FROM THE MARK AS SHOWN.

FOR CHARCOAL BRIQUETTES (U.S. CLS. 1, 6 AND 15).

FIRST USE 7-1-1998; IN COMMERCE 7-1-1998.
KAREN BRACEY, EXAMINING ATTORNEY

SN 78-868,399. LYONDELL-CITGO REFINING LP, HOUSTON, TX. FILED 4-24-2006.

HONOL

THE MARK CONSISTS OF STANDARD CHARACTERS WITHOUT CLAIM TO ANY PARTICULAR FONT, STYLE, SIZE, OR COLOR.

OWNER OF U.S. REG. NO. 417,649.
FOR LIGHT, MEDIUM AND HEAVY COMPOUNDED OIL USED AS AN ENERGIZER FOR CUTTING OILS, A STRAIGHT CUTTING OIL AND A GRINDING OIL (U.S. CLS. 1, 6 AND 15).

FIRST USE 5-14-1945; IN COMMERCE 5-14-1945.
BRENDAN REGAN, EXAMINING ATTORNEY

SN 78-870,854. SMITH, JAMES TODD, NEW YORK, NY. FILED 4-27-2006.

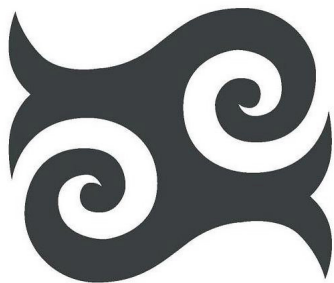

FOR CANDLES, SCENTED CANDLES, TAPERS, WICKS FOR OIL LAMPS, AND BEESWAX FOR USE IN THE MANUFACTURE OF CANDLES (U.S. CLS. 1, 6 AND 15).

MARY CRAWFORD, EXAMINING ATTORNEY

CLASS 4—(Continued).

SN 78-880,009. SPERANCIA, LLC, ARLINGTON, TX. FILED 5-9-2006.



THE MARK CONSISTS OF THE WORD SPERANCIA IN STYLIZED FONT, WITH AN OLIVE BRANCH OVER IT.

FOR CANDLES (U.S. CLS. 1, 6 AND 15).

FIRST USE 4-1-2006; IN COMMERCE 4-1-2006.

MATTHEW MCDOWELL, EXAMINING ATTORNEY

SN 78-882,439. GENERAL ELECTRIC COMPANY, SCHECTADY, NY. FILED 5-12-2006.

MOTIONITE

THE MARK CONSISTS OF STANDARD CHARACTERS WITHOUT CLAIM TO ANY PARTICULAR FONT, STYLE, SIZE, OR COLOR.

FOR ALL PURPOSE LUBRICANTS; LUBRICATING GREASES; LUBRICATING OILS (U.S. CLS. 1, 6 AND 15).
KATHERINE E. HALMEN, EXAMINING ATTORNEY

CLASS 5—PHARMACEUTICALS

SN 76-482,152. MED-GISTICS INC., MISSISSAUGA, ONTARIO L5C 4R3, CANADA, FILED 1-14-2003.

T.A.C.

FOR NON PRESCRIPTION, ANALGESIC CREAM, NAMELY, SKIN CREAM FOR THE TREATMENT OF ARTHRITIS (U.S. CLS. 6, 18, 44, 46, 51 AND 52).

KELLEY WELLS, EXAMINING ATTORNEY

SN 76-555,128. DIRECT MARKETING CONCEPTS, INC., BEVERLY, MA. FILED 10-29-2003.

CORALCAL DAILY

NO CLAIM IS MADE TO THE EXCLUSIVE RIGHT TO USE DAILY, APART FROM THE MARK AS SHOWN.

FOR DIETARY SUPPLEMENTS (U.S. CLS. 6, 18, 44, 46, 51 AND 52).

FIRST USE 6-25-2002; IN COMMERCE 7-15-2002.

NAKWAMA ANKRAH, EXAMINING ATTORNEY

CLASS 5—(Continued).

SN 76-655,535. WEB PRODUCTS, INC., KANSAS CITY, MO.
FILED 2-23-2006.

TROPICAL BAY

THE MARK CONSISTS OF STANDARD CHARACTERS WITHOUT CLAIM TO ANY PARTICULAR FONT, STYLE, SIZE, OR COLOR.

FOR AIR FRESHENERS IN THE FORM OF PADS FOR ATTACHMENT TO FURNACE FILTERS (U.S. CLS. 6, 18, 44, 46, 51 AND 52).

DAWN HAN, EXAMINING ATTORNEY

CLASS 5—(Continued).

SN 76-658,638. LUEN WAH (H.K.) MEDICINE LIMITED,
CHAIWAN, HONG KONG, FILED 4-18-2006.



THE CHINESE CHARACTERS IN THE MARK TRANSLITERATE TO IMADA, AND THIS MEANS "TO FOLLOW"; "HORSE"; "TO STRIKE" IN ENGLISH.

FOR MEDICINAL OILS FOR EXTERNAL USE FOR THE TREATMENT OF MINOR MUSCLE PAIN, FOR THE REDUCTION OF STIFFNESS AND SORENESS, AND FOR THE RELIEF OF HEADACHES AND PAIN ASSOCIATED WITH BACKACHES, ARTHRITIS, STRAINS AND SPRAINS (U.S. CLS. 6, 18, 44, 46, 51 AND 52).

FIRST USE 9-0-1996; IN COMMERCE 9-0-1996.

MARY ROSSMAN, EXAMINING ATTORNEY

SN 76-655,536. WEB PRODUCTS, INC., KANSAS CITY, MO.
FILED 2-23-2006.

LAVENDER BLOOM

THE MARK CONSISTS OF STANDARD CHARACTERS WITHOUT CLAIM TO ANY PARTICULAR FONT, STYLE, SIZE, OR COLOR.

NO CLAIM IS MADE TO THE EXCLUSIVE RIGHT TO USE "LAVENDER", APART FROM THE MARK AS SHOWN.

FOR AIR FRESHENERS IN THE FORM OF PADS FOR ATTACHMENT TO FURNACE FILTERS (U.S. CLS. 6, 18, 44, 46, 51 AND 52).

DAWN HAN, EXAMINING ATTORNEY

SN 78-463,202. PED-MED LTD., TORONTO, ONTARIO,
CANADA, FILED 8-6-2004.

SPRINKLES

SN 76-655,538. WEB PRODUCTS, INC., KANSAS CITY, MO.
FILED 2-23-2006.

MELON ICE

THE MARK CONSISTS OF STANDARD CHARACTERS WITHOUT CLAIM TO ANY PARTICULAR FONT, STYLE, SIZE, OR COLOR.

NO CLAIM IS MADE TO THE EXCLUSIVE RIGHT TO USE "MELON", APART FROM THE MARK AS SHOWN.

FOR AIR FRESHENERS IN THE FORM OF PADS FOR ATTACHMENT TO FURNACE FILTERS (U.S. CLS. 6, 18, 44, 46, 51 AND 52).

DAWN HAN, EXAMINING ATTORNEY

THE MARK CONSISTS OF STANDARD CHARACTERS WITHOUT CLAIM TO ANY PARTICULAR FONT, STYLE, SIZE, OR COLOR.

FOR NUTRITIONAL SUPPLEMENTS AND DIETARY SUPPLEMENTS, NAMELY MINERAL AND VITAMIN SUPPLEMENTS (U.S. CLS. 6, 18, 44, 46, 51 AND 52).

FIRST USE 10-1-2004; IN COMMERCE 10-1-2004.

TIMOTHY FINNEGAN, EXAMINING ATTORNEY

CLASS 5—(Continued).

SN 78-464,196. HAUGH, WILLIAM P, LA PALMA, CA. FILED 8-9-2004.

CLASS 5—(Continued).

SN 78-558,226. ECONET, INC., LACEY, WA. FILED 2-1-2005.

Dr. Smoothie The Complete Meal

THE MARK CONSISTS OF STANDARD CHARACTERS WITHOUT CLAIM TO ANY PARTICULAR FONT, STYLE, SIZE, OR COLOR.

OWNER OF U.S. REG. NOS. 2,216,470 AND 2,581,173. NO CLAIM IS MADE TO THE EXCLUSIVE RIGHT TO USE "SMOOTHIE" AND "COMPLETE MEAL", APART FROM THE MARK AS SHOWN.

FOR WHOLE FOOD SUPPLEMENT (U.S. CLS. 6, 18, 44, 46, 51 AND 52).

FIRST USE 1-2-2004; IN COMMERCE 1-9-2004.

KATHLEEN M. VANSTON, EXAMINING ATTORNEY

BRINGING THE BEST OF NATURE TO MANKIND

THE MARK CONSISTS OF STANDARD CHARACTERS WITHOUT CLAIM TO ANY PARTICULAR FONT, STYLE, SIZE, OR COLOR.

FOR DIETARY AND NUTRITIONAL SUPPLEMENTS, PHARMACEUTICALS, OVER-THE-COUNTER NUTRICEUTICALS, NUTRICEUTICALS AND COSMETICS WITH PHARMACEUTICAL PROPERTIES, NAMELY, MEDICATED SKIN CLEANSER, MEDICATED SKIN PROTECTANT, MEDICATED SKIN MOISTURIZER, MEDICATED SKIN WHITENER, MEDICATED POST SUN EXPOSURE LOTION, ANTI-OXIDANT AND ANTI-AGING PREPARATIONS, ENERGY, ANTI-FATIGUE AND ENDURANCE ENHANCING PREPARATIONS, JOINT FLEXIBILITY AND PAIN RELIEF PREPARATIONS, PHARMACEUTICAL RESPIRATORY SUPPORT PREPARATIONS, PHARMACEUTICAL LIVER PROTECTION PREPARATIONS, DIETARY SUPPLEMENT STRESS RELIEF PREPARATIONS, DIETARY SUPPLEMENT VASCULAR SUPPORT PREPARATIONS, VETERINARY DIETARY SUPPLEMENTS, MEDICATED TRANSDERMAL PATCHES FOR ADMINISTERING MOISTURIZER, WOUND DRESSING AND ANTI-INFLAMMATORY MEDICATIONS, ANTISEPTICS, MEDICATION INFUSED DISPOSABLE INCONTINENCE PADS FOR ADMINISTERING MOISTURIZER, WOUND DRESSING AND ANTI-INFLAMMATORY MEDICATIONS, MEDICATION INFUSED DISPOSABLE DIAPERS FOR ADMINISTERING MOISTURIZER, WOUND DRESSING AND ANTI-INFLAMMATORY MEDICATIONS, MEDICATION INFUSED FACIAL TISSUE FOR ADMINISTERING MOISTURIZER, WOUND DRESSING AND ANTI-INFLAMMATORY MEDICATIONS, MEDICATION INFUSED TOILET PAPER FOR ADMINISTERING MOISTURIZER, WOUND DRESSING AND ANTI-INFLAMMATORY MEDICATIONS AND MEDICATION INFUSED VETERINARY TOPICAL LOTIONS (U.S. CLS. 6, 18, 44, 46, 51 AND 52).

INGRID C. EULIN, EXAMINING ATTORNEY

SN 78-527,899. NATURAL GLO SPECIALTY PRODUCTS, WILLOWS, CA. FILED 12-6-2004.

SandBuster

THE MARK CONSISTS OF STANDARD CHARACTERS WITHOUT CLAIM TO ANY PARTICULAR FONT, STYLE, SIZE, OR COLOR.

FOR PELLETTED EQUINE FEED SUPPLEMENT FOR USE IN TREATING THE INGESTION OF SAND IN THE HORSES SYSTEM (U.S. CLS. 6, 18, 44, 46, 51 AND 52).

FIRST USE 8-0-2005; IN COMMERCE 8-0-2005.

SALLY SHIH, EXAMINING ATTORNEY

CLASS 5—(Continued).

SN 78-574,629. VARSITYPLAZA LLC, OAK HILL, VA. FILED 2-24-2005.

HOODIAULTRA

THE MARK CONSISTS OF STANDARD CHARACTERS WITHOUT CLAIM TO ANY PARTICULAR FONT, STYLE, SIZE, OR COLOR.

FOR DIET SUPPLEMENT CONTAINING HOODIA GORDONII APPETITE SUPPRESSANT (U.S. CLS. 6, 18, 44, 46, 51 AND 52).

FIRST USE 2-1-2005; IN COMMERCE 2-1-2005.
MELVIN AXILBUND, EXAMINING ATTORNEY

SN 78-608,870. BIONICHE LIFE SCIENCES INC., BELLEVILLE, CANADA, FILED 4-14-2005.

SYNGRO

THE MARK CONSISTS OF STANDARD CHARACTERS WITHOUT CLAIM TO ANY PARTICULAR FONT, STYLE, SIZE, OR COLOR.

PRIORITY CLAIMED UNDER SEC. 44(D) ON CANADA APPLICATION NO. 1,252,861, FILED 4-4-2005, REG. NO. TMA660,892, DATED 3-16-2006, EXPIRES 3-16-2021.

FOR SYNTHETIC MEDIA USED IN THE TRANSFER OF ANIMAL EMBRYOS (U.S. CLS. 6, 18, 44, 46, 51 AND 52).

LINDA ESTRADA, EXAMINING ATTORNEY

CLASS 5—(Continued).

SN 78-609,566. OMEGA ALPHA PHARMACEUTICALS INC., SCARBOROUGH, ONTARIO, CANADA, FILED 4-15-2005.



OWNER OF CANADA REG. NO. 1067078, DATED 3-4-2003, EXPIRES 3-4-2018.

NO CLAIM IS MADE TO THE EXCLUSIVE RIGHT TO USE "SCIENCE LABORATORIES", APART FROM THE MARK AS SHOWN.

FOR DIETARY AND/OR HERBAL SUPPLEMENTS, NAMELY, GINSENG FOR MEDICINAL USE, ECHINACEA, DONG QUAI, GOLDENSEAL AND ECHINACEA, NONI, CAT'S CLAW, GLUCOSAMINE SULPHATE, CREATINE MONOHYDRATE, SAINT JOHN'S WORT, VALERIAN, TRIBULUS TERRISTRIS, GINKGO BILOBA, CHITOSAN, PSYLLIUM, STINGING NETTLE, AND KAVA; DIGESTIVE ENZYMES FOR USE WITH FOOD ALLERGIES, AS A NUTRITIONAL SUPPLEMENT, AND AS A DIGESTIVE AID; ANTI-PARASITE FORMULA HERBAL SUPPLEMENTS COMPRISING BETEL NUT, POLYPORUS MYLITAE, GARLIC, PUMPKIN SEED, WORMWOOD, CLOVES, RHIZOME RHEI, JUGLANS NIGRA, MINT AND CELLULOSE; HERBAL PREPARATIONS FOR IRRITABLE BOWEL; HERBAL PREPARATIONS FOR PARASITE INFECTIONS; HERBAL PREPARATIONS FOR JOINT PAIN; HERBAL PREPARATIONS FOR SORE MUSCLES, SPRAINS AND BRUISES; HERBAL PREPARATIONS FOR ARTHRITIS; HERBAL PREPARATIONS FOR EYE FATIGUE; HERBAL PREPARATIONS FOR VISION; HERBAL PREPARATIONS FOR REDUCTION OF NIGHT BLINDNESS; HERBAL PREPARATIONS FOR RETARDING MACULAR DEGENERATION; HERBAL PREPARATIONS FOR CATARACT FORMATION; HEALTH FOOD SUPPLEMENTS IN CAPSULE, TABLET AND LIQUID FORMS CONSISTING OF D-GLUCOSAMINE SULPHATE, CURCUMIN, GINGER, CAT'S CLAW, YUCCA AND CELLULOSE; HERBAL SUPPLEMENTS COMBINING METHYLSULFONYLMETHANE AND GLUCOSAMINE SULPHATE (U.S. CLS. 6, 18, 44, 46, 51 AND 52).

BRIAN PINO, EXAMINING ATTORNEY

SN 78-640,261. AMERICAN BIOTECH LABS, LLC, ALPINE, UT. FILED 5-31-2005.

AMERICAN BIOTECH LABS

THE MARK CONSISTS OF STANDARD CHARACTERS WITHOUT CLAIM TO ANY PARTICULAR FONT, STYLE, SIZE, OR COLOR.

NO CLAIM IS MADE TO THE EXCLUSIVE RIGHT TO USE "AMERICAN" AND "LABS", APART FROM THE MARK AS SHOWN.

FOR DISINFECTANTS, NAMELY DISINFECTANTS FOR SANITARY PURPOSES (U.S. CLS. 6, 18, 44, 46, 51 AND 52).

FIRST USE 9-6-2006; IN COMMERCE 9-6-2006.
KATRINA EDGE, EXAMINING ATTORNEY

CLASS 5—(Continued).

SN 78-645,346. WYETH, MADISON, NJ. FILED 6-7-2005.

FROM THE COUGH EXPERTS

THE MARK CONSISTS OF STANDARD CHARACTERS WITHOUT CLAIM TO ANY PARTICULAR FONT, STYLE, SIZE, OR COLOR.

OWNER OF U.S. REG. NO. 1,786,443.
FOR PHARMACEUTICAL PREPARATION; NAMELY, A COUGH SUPPRESSANT (U.S. CLS. 6, 18, 44, 46, 51 AND 52).

HEATHER SAPP, EXAMINING ATTORNEY

SN 78-662,479. ADVANCED NUTRITIONAL BIOSYSTEMS, INC., ORLANDO, FL. FILED 7-1-2005.

NR-PEAK

THE MARK CONSISTS OF STANDARD CHARACTERS WITHOUT CLAIM TO ANY PARTICULAR FONT, STYLE, SIZE, OR COLOR.

FOR VITAMINS AND NUTRITIONAL SUPPLEMENTS (U.S. CLS. 6, 18, 44, 46, 51 AND 52).

JOSETTE BEVERLY, EXAMINING ATTORNEY

SN 78-670,244. NOVARTIS AG, BASEL, SWITZERLAND, FILED 7-14-2005.

PALEDIO

THE MARK CONSISTS OF STANDARD CHARACTERS WITHOUT CLAIM TO ANY PARTICULAR FONT, STYLE, SIZE, OR COLOR.

PRIORITY CLAIMED UNDER SEC. 44(D) ON SWITZERLAND APPLICATION NO. 535273, FILED 6-23-2005, REG. NO. 535273, DATED 7-1-2005, EXPIRES 6-23-2015.

FOR PHARMACEUTICAL PREPARATIONS FOR THE PREVENTION AND TREATMENT OF DISORDERS OF THE NERVOUS SYSTEM, THE IMMUNE SYSTEM, THE CARDIO-VASCULAR SYSTEM, THE RESPIRATORY SYSTEM, THE MUSCULO-SKELETAL SYSTEM, AND THE GENITOURINARY SYSTEM; PHARMACEUTICAL PREPARATIONS FOR THE TREATMENT OF INFLAMMATORY DISORDERS; PHARMACEUTICAL PREPARATIONS FOR USE IN DERMATOLOGY, ONCOLOGY, HEMATOLOGY, TRANSPLANTATION, AND OPHTHALMOLOGY; PHARMACEUTICAL PREPARATIONS FOR USE IN THE GASTROENTEROLOGICAL AREA AND FOR THE PREVENTION AND TREATMENT OF OCULAR DISORDERS OR DISEASES; ANTI-INFECTIVES; PHARMACEUTICAL PREPARATIONS FOR THE TREATMENT OF BACTERIA-BASED DISEASES; ANTIVIRALS; ANTI-BIOTICS; ANTI-FUNGALS (U.S. CLS. 6, 18, 44, 46, 51 AND 52).

DAHLIA GEORGE, EXAMINING ATTORNEY

CLASS 5—(Continued).

SN 78-670,764. NOVARTIS AG, BASEL, SWITZERLAND, FILED 7-14-2005.

VLIARO

THE MARK CONSISTS OF STANDARD CHARACTERS WITHOUT CLAIM TO ANY PARTICULAR FONT, STYLE, SIZE, OR COLOR.

PRIORITY CLAIMED UNDER SEC. 44(D) ON SWITZERLAND APPLICATION NO. 535280, FILED 7-4-2005, REG. NO. 535280, DATED 7-4-2005, EXPIRES 6-27-2015.

FOR PHARMACEUTICAL PREPARATIONS FOR THE PREVENTION AND TREATMENT OF DISORDERS OF THE NERVOUS SYSTEM, THE IMMUNE SYSTEM, THE CARDIO-VASCULAR SYSTEM, THE RESPIRATORY SYSTEM, THE MUSCULO-SKELETAL SYSTEM, THE GENITOURINARY SYSTEM, FOR THE TREATMENT OF INFLAMMATORY DISORDERS, FOR USE IN DERMATOLOGY, IN ONCOLOGY, IN HEMATOLOGY, IN TRANSPLANTATION, IN OPHTHALMOLOGY, FOR USE IN THE GASTROENTEROLOGICAL AREA AND THE PREVENTION AND TREATMENT OF OCULAR DISORDERS OR DISEASES; ANTI-INFECTIVES, PHARMACEUTICAL PREPARATIONS TREATING BACTERIA-BASED DISEASES, ANTIVIRALS, ANTI-BIOTICS, ANTI-FUNGALS (U.S. CLS. 6, 18, 44, 46, 51 AND 52).

NAAKWAMA ANKRAH, EXAMINING ATTORNEY

SN 78-676,231. ANCIENT SUN NUTRITION, INC., ASHEVILLE, NC. FILED 7-22-2005.

CYANOMIN

THE MARK CONSISTS OF STANDARD CHARACTERS WITHOUT CLAIM TO ANY PARTICULAR FONT, STYLE, SIZE, OR COLOR.

FOR NUTRITIONAL AND DIETARY SUPPLEMENTS (U.S. CLS. 6, 18, 44, 46, 51 AND 52).

ANDREA EVANS, EXAMINING ATTORNEY

SN 78-688,985. CALIFORNIA COSMETICS, INC., CALABASAS, CA. FILED 8-9-2005.

BIOHEXOL

THE MARK CONSISTS OF STANDARD CHARACTERS WITHOUT CLAIM TO ANY PARTICULAR FONT, STYLE, SIZE, OR COLOR.

FOR HOMEOPATHIC MEDICINES FOR USE IN THE TREATMENT OF DRY SKIN (U.S. CLS. 6, 18, 44, 46, 51 AND 52).

SCOTT SISUN, EXAMINING ATTORNEY

CLASS 5—(Continued).

SN 78-689,038. BIONUMERIK PHARMACEUTICALS, INC.,
SAN ANTONIO, TX. FILED 8-9-2005.

TAVOCEPT

THE MARK CONSISTS OF STANDARD CHARACTERS WITHOUT CLAIM TO ANY PARTICULAR FONT, STYLE, SIZE, OR COLOR.

FOR PHARMACEUTICAL, NAMELY MEDICATIONS USED IN CHEMOTHERAPEUTIC REGIMENS FOR THE TREATMENT OF CANCER (U.S. CLS. 6, 18, 44, 46, 51 AND 52).

MATTHEW PAPPAS, EXAMINING ATTORNEY

CLASS 5—(Continued).

SN 78-700,262. EARTH CHEMICAL COMPANY LIMITED,
TOKYO, JAPAN, FILED 8-25-2005.

SN 78-689,090. FBK HOLDINGS, LLC, NEW YORK, NY.
FILED 8-9-2005.

FRESHN' PRO

THE MARK CONSISTS OF STANDARD CHARACTERS WITHOUT CLAIM TO ANY PARTICULAR FONT, STYLE, SIZE, OR COLOR.

FOR AIR DEODORIZER; CAR DEODORIZER; CAR-PET DEODORIZER; SHOE DEODORIZER; HOUSEHOLD DEODORIZER; DEODORIZER FOR GARBAGE DISPOSALS AND OTHER KITCHEN APPLIANCES; DEODORIZER FOR HOUSEHOLD PET LITTER BOXES; FABRIC DEODORIZER; DEODORIZER FOR HARD SURFACES; AIR FRESHENERS (U.S. CLS. 6, 18, 44, 46, 51 AND 52).

MARY CRAWFORD, EXAMINING ATTORNEY

NO CLAIM IS MADE TO THE EXCLUSIVE RIGHT TO USE THE NON-LATIN CHARACTERS THAT MEAN "MEDICATED", APART FROM THE MARK AS SHOWN.

THE MARK CONSISTS OF JAPANESE CHARACTERS. THE NON-LATIN CHARACTER(S) IN THE MARK TRANSLITERATES INTO YAKUSEN MEGURI, AND THIS MEANS "WITH A PILGRIMAGE OF A MEDICATED SPRING" IN ENGLISH.

FOR MEDICATED BATH PREPARATIONS (U.S. CLS. 6, 18, 44, 46, 51 AND 52).

FIRST USE 9-1-1999; IN COMMERCE 2-1-2002.

KATHERINE STOIDES, EXAMINING ATTORNEY

SN 78-691,190. IDEXX LABORATORIES, INC., WEST-BROOK, ME. FILED 8-12-2005.

SPEC CPL

THE MARK CONSISTS OF STANDARD CHARACTERS WITHOUT CLAIM TO ANY PARTICULAR FONT, STYLE, SIZE, OR COLOR.

FOR TEST FOR PANCREATIC LIPASE TO DETECT PANCREATITIS IN DOGS, COMPRISED OF MICROWELL PLATES, REAGENTS, CALIBRATORS, AND/OR WASH SOLUTION FOR VETERINARY DIAGNOSTIC PURPOSES (U.S. CLS. 6, 18, 44, 46, 51 AND 52).

FIRST USE 10-31-2005; IN COMMERCE 10-31-2005.

ERNEST SHOSHO, EXAMINING ATTORNEY

SN 78-700,278. EARTH CHEMICAL COMPANY LIMITED,
TOKYO, JAPAN, FILED 8-25-2005.

THE MARK CONSISTS OF JAPANESE CHARACTERS. THE NON-LATIN CHARACTER(S) IN THE MARK TRANSLITERATES INTO ONSENGO MEGURI, AND THIS MEANS "WITH A PILGRIMAGE OF A HOT SPRING IN THE VILLAGE" IN ENGLISH.

FOR MEDICATED BATH PREPARATIONS (U.S. CLS. 6, 18, 44, 46, 51 AND 52).

FIRST USE 9-1-2001; IN COMMERCE 9-1-2003.

KATHERINE STOIDES, EXAMINING ATTORNEY

CLASS 5—(Continued).

SN 78-700,291. EARTH CHEMICAL COMPANY LIMITED,
TOKYO, JAPAN, FILED 8-25-2005.

THE MARK CONSISTS OF JAPANESE CHARACTERS.
THE NON-LATIN CHARACTER(S) IN THE MARK
TRANSLITERATES INTO ROTENYU MEGURI, AND THIS
MEANS "WITH A PILGRIMAGE OF A HOT SPRING IN THE
OPEN" IN ENGLISH.

FOR MEDICATED BATH PREPARATIONS (U.S. CLS.
6, 18, 44, 46, 51 AND 52).

FIRST USE 9-1-1990; IN COMMERCE 5-1-1994.

KATHERINE STOIDES, EXAMINING ATTORNEY

SN 78-700,304. EARTH CHEMICAL COMPANY LIMITED,
TOKYO, JAPAN, FILED 8-25-2005.

THE MARK CONSISTS OF JAPANESE CHARACTERS.
THE NON-LATIN CHARACTER(S) IN THE MARK
TRANSLITERATES INTO HITOH MEGURI, AND THIS
MEANS "WITH A PILGRIMAGE OF A HOT SPRING" IN
ENGLISH.

FOR MEDICATED BATH PREPARATIONS (U.S. CLS.
6, 18, 44, 46, 51 AND 52).

FIRST USE 9-1-2003; IN COMMERCE 8-1-2004.

KATHERINE STOIDES, EXAMINING ATTORNEY

CLASS 5—(Continued).

SN 78-700,318. EARTH CHEMICAL COMPANY LIMITED,
TOKYO, JAPAN, FILED 8-25-2005.

NO CLAIM IS MADE TO THE EXCLUSIVE RIGHT TO
USE THE NON-LATIN CHARACTERS THAT MEAN
"MEDICATED", APART FROM THE MARK AS SHOWN.
THE MARK CONSISTS OF JAPANESE CHARACTERS.

THE NON-LATIN CHARACTER(S) IN THE MARK
TRANSLITERATES INTO YAKUSEN, AND THIS MEANS
"WITH A MEDICATED SPRING" IN ENGLISH.

FOR MEDICATED BATH PREPARATIONS (U.S. CLS.
6, 18, 44, 46, 51 AND 52).

FIRST USE 9-1-1995; IN COMMERCE 10-1-1999.

KATHERINE STOIDES, EXAMINING ATTORNEY

SN 78-701,404. AQUA PHARMACEUTICALS, LLC, MAL-
VERN, PA. FILED 8-26-2005.

AQUA PHARMACEUTICALS, LLC

THE MARK CONSISTS OF STANDARD CHARACTERS
WITHOUT CLAIM TO ANY PARTICULAR FONT, STYLE,
SIZE, OR COLOR.

NO CLAIM IS MADE TO THE EXCLUSIVE RIGHT TO
USE PHARMACEUTICALS, LLC, APART FROM THE
MARK AS SHOWN.

FOR PRESCRIPTION DRUGS, NAMELY, MEDI-
CATED SKIN CARE PREPARATIONS AND PHARMA-
CEUTICAL PREPARATIONS FOR THE TREATMENT OF
ACNE AND SKIN DISEASES, EXCLUDING ORAL CARE
PREPARATIONS (U.S. CLS. 6, 18, 44, 46, 51 AND 52).

DAWN HAN, EXAMINING ATTORNEY

CLASS 5—(Continued).

SN 78-714,027. SCHERING-PLOUGH ANIMAL HEALTH CORPORATION, SUMMIT, NJ. FILED 9-15-2005.

RHUSIGEN

THE MARK CONSISTS OF STANDARD CHARACTERS WITHOUT CLAIM TO ANY PARTICULAR FONT, STYLE, SIZE, OR COLOR.

OWNER OF U.S. REG. NO. 3,083,679.
FOR VETERINARY VACCINE FOR SWINE (U.S. CLS. 6, 18, 44, 46, 51 AND 52).
JOHN SCHUYLER YARD, EXAMINING ATTORNEY

SN 78-714,895. ENIVA CORPORATION, MINNEAPOLIS, MN.
FILED 9-16-2005.

BIOLOGICS FOR LIFE

THE MARK CONSISTS OF STANDARD CHARACTERS WITHOUT CLAIM TO ANY PARTICULAR FONT, STYLE, SIZE, OR COLOR.

NO CLAIM IS MADE TO THE EXCLUSIVE RIGHT TO USE "BIOLOGICS", APART FROM THE MARK AS SHOWN.
FOR BLENDED LIQUID MINERAL DIETARY SUPPLEMENTS AND NUTRITIONAL DIETARY SUPPLEMENTS (U.S. CLS. 6, 18, 44, 46, 51 AND 52).
FIRST USE 2-1-2002; IN COMMERCE 2-1-2002.
JERI J. FICKES, EXAMINING ATTORNEY

SN 78-716,567. FLEN PHARMA N.V., ZOERSEL, BELGIUM,
FILED 9-20-2005.

FLAMINAL

THE MARK CONSISTS OF STANDARD CHARACTERS WITHOUT CLAIM TO ANY PARTICULAR FONT, STYLE, SIZE, OR COLOR.

OWNER OF ERPN CMNTY TM OFC REG. NO. 2,257,293,
DATED 6-18-2003, EXPIRES 6-13-2011.

FOR PHARMACEUTICAL AND MEDICAL PREPARATIONS FOR TOPICAL TREATMENT OF ACUTE WOUNDS, ACUTE POST OPERATIVE WOUNDS, CHRONIC WOUNDS AND SKIN DISEASES RESULTING FROM ACUTE OR CHRONIC WOUNDS, NAMELY, ANTI-MICROBIAL AND WOUND HEALING PROMOTING GELS, CREAMS AND OINTMENTS (U.S. CLS. 6, 18, 44, 46, 51 AND 52).

LYDIA BELZER, EXAMINING ATTORNEY

CLASS 5—(Continued).

SN 78-717,698. KING PHARMACEUTICALS RESEARCH AND DEVELOPMENT, INC., BRISTOL, TN. FILED 9-21-2005.

FIEROS

THE MARK CONSISTS OF STANDARD CHARACTERS WITHOUT CLAIM TO ANY PARTICULAR FONT, STYLE, SIZE, OR COLOR.

THE FOREIGN WORDING IN THE MARK TRANSLATES INTO ENGLISH AS FIERCE.

FOR PHARMACEUTICAL PREPARATIONS FOR THE TREATMENT OF SEXUAL DYSFUNCTION (U.S. CLS. 6, 18, 44, 46, 51 AND 52).

ROBERT STRUCK, EXAMINING ATTORNEY

SN 78-717,720. KING PHARMACEUTICALS RESEARCH AND DEVELOPMENT, INC., BRISTOL, TN. FILED 9-21-2005.

AZALTA

THE MARK CONSISTS OF STANDARD CHARACTERS WITHOUT CLAIM TO ANY PARTICULAR FONT, STYLE, SIZE, OR COLOR.

FOR PHARMACEUTICAL PREPARATIONS FOR THE TREATMENT OF SEXUAL DYSFUNCTION (U.S. CLS. 6, 18, 44, 46, 51 AND 52).

BILL DAWE, EXAMINING ATTORNEY

SN 78-717,728. KING PHARMACEUTICALS RESEARCH AND DEVELOPMENT, INC., BRISTOL, TN. FILED 9-21-2005.

FIARUS

THE MARK CONSISTS OF STANDARD CHARACTERS WITHOUT CLAIM TO ANY PARTICULAR FONT, STYLE, SIZE, OR COLOR.

FOR PHARMACEUTICAL PREPARATIONS FOR THE TREATMENT OF SEXUAL DYSFUNCTION (U.S. CLS. 6, 18, 44, 46, 51 AND 52).

KRISTINA KLOIBER, EXAMINING ATTORNEY

CLASS 5—(Continued).

SN 78-718,510. RUBIMED AG, CH-6052 HERGISWIL, SWITZERLAND, FILED 9-22-2005.

ANXIOVITA

THE MARK CONSISTS OF STANDARD CHARACTERS WITHOUT CLAIM TO ANY PARTICULAR FONT, STYLE, SIZE, OR COLOR.

OWNER OF U.S. REG. NOS. 2,383,985, 2,386,307 AND 2,402,584.

FOR PHARMACEUTICALS, COMPLEX HOMEOPATHIC SUBSTANCES AND PREPARATIONS FOR THE TREATMENT OF PSYCHOSOMATIC DISORDERS (U.S. CLS. 6, 18, 44, 46, 51 AND 52).

FIRST USE 1-1-2005; IN COMMERCE 1-1-2005.
DARRYL SPRUILL, EXAMINING ATTORNEY

CLASS 5—(Continued).

SN 78-718,612. RUBIMED AG, CH-6052 HERGISWIL, SWITZERLAND, FILED 9-22-2005.

PARAVITA

THE MARK CONSISTS OF STANDARD CHARACTERS WITHOUT CLAIM TO ANY PARTICULAR FONT, STYLE, SIZE, OR COLOR.

OWNER OF U.S. REG. NOS. 2,383,985, 2,386,307 AND 2,402,584.

FOR PHARMACEUTICALS, COMPLEX HOMEOPATHIC SUBSTANCES AND PREPARATIONS FOR THE TREATMENT OF PSYCHOSOMATIC DISORDERS (U.S. CLS. 6, 18, 44, 46, 51 AND 52).

FIRST USE 1-1-2005; IN COMMERCE 1-1-2005.
DARRYL SPRUILL, EXAMINING ATTORNEY

SN 78-718,539. RUBIMED AG, CH-6052 HERGISWIL, SWITZERLAND, FILED 9-22-2005.

NEUROVITA

THE MARK CONSISTS OF STANDARD CHARACTERS WITHOUT CLAIM TO ANY PARTICULAR FONT, STYLE, SIZE, OR COLOR.

OWNER OF U.S. REG. NOS. 2,383,985, 2,386,307 AND 2,402,584.

FOR PHARMACEUTICALS, COMPLEX HOMEOPATHIC SUBSTANCES AND PREPARATIONS FOR THE TREATMENT OF PSYCHOSOMATIC DISORDERS (U.S. CLS. 6, 18, 44, 46, 51 AND 52).

FIRST USE 1-1-2005; IN COMMERCE 1-1-2005.
DARRYL SPRUILL, EXAMINING ATTORNEY

SN 78-718,809. SIGMACON GROUP INC., TORONTO, ONTARIO, CANADA, FILED 9-22-2005.

SIGMASHIELD

THE MARK CONSISTS OF STANDARD CHARACTERS WITHOUT CLAIM TO ANY PARTICULAR FONT, STYLE, SIZE, OR COLOR.

FOR ANTISEPTIC MEDICAL GEL (U.S. CLS. 6, 18, 44, 46, 51 AND 52).

GINA FINK, EXAMINING ATTORNEY

SN 78-718,579. RUBIMED AG, CH-6052 HERGISWIL, SWITZERLAND, FILED 9-22-2005.

SIMVITA

THE MARK CONSISTS OF STANDARD CHARACTERS WITHOUT CLAIM TO ANY PARTICULAR FONT, STYLE, SIZE, OR COLOR.

OWNER OF U.S. REG. NOS. 2,383,985, 2,386,307 AND 2,402,584.

FOR PHARMACEUTICALS, COMPLEX HOMEOPATHIC SUBSTANCES AND PREPARATIONS FOR THE TREATMENT OF PSYCHOSOMATIC DISORDERS (U.S. CLS. 6, 18, 44, 46, 51 AND 52).

FIRST USE 1-1-2005; IN COMMERCE 1-1-2005.
DARRYL SPRUILL, EXAMINING ATTORNEY

SN 78-720,173. NOVARTIS AG, BASEL, SWITZERLAND, FILED 9-26-2005.

GAS-X THIN STRIPS

THE MARK CONSISTS OF STANDARD CHARACTERS WITHOUT CLAIM TO ANY PARTICULAR FONT, STYLE, SIZE, OR COLOR.

OWNER OF U.S. REG. NO. 1,086,798.

NO CLAIM IS MADE TO THE EXCLUSIVE RIGHT TO USE "THIN STRIPS", APART FROM THE MARK AS SHOWN.

FOR PHARMACEUTICAL PREPARATIONS, NAMELY, ANTI-FLATULENT PREPARATIONS (U.S. CLS. 6, 18, 44, 46, 51 AND 52).

CIMMERIAN COLEMAN, EXAMINING ATTORNEY

CLASS 5—(Continued).

SN 78-720,740. DYNAX TECHNOLOGIES CORPORATION, BERKELEY, CA. FILED 9-26-2005.

HEPGAR

THE MARK CONSISTS OF STANDARD CHARACTERS WITHOUT CLAIM TO ANY PARTICULAR FONT, STYLE, SIZE, OR COLOR.

FOR VACCINES (U.S. CLS. 6, 18, 44, 46, 51 AND 52).
ELIZABETH J. WINTER, EXAMINING ATTORNEY

SN 78-727,783. ABBOTT LABORATORIES, ABBOTT PARK, IL. FILED 10-6-2005.

REBUILDING MUSCLES. REBUILDING LIVES

THE MARK CONSISTS OF STANDARD CHARACTERS WITHOUT CLAIM TO ANY PARTICULAR FONT, STYLE, SIZE, OR COLOR.

FOR DIETARY SUPPLEMENTS (U.S. CLS. 6, 18, 44, 46, 51 AND 52).

FIRST USE 10-17-2003; IN COMMERCE 10-17-2003.
MICHAEL KAZAZIAN, EXAMINING ATTORNEY

SN 78-728,087. LUNA FERTILITY INDICATOR INC., RICHMOND, CANADA, FILED 10-6-2005.

BABY STEPS

THE MARK CONSISTS OF STANDARD CHARACTERS WITHOUT CLAIM TO ANY PARTICULAR FONT, STYLE, SIZE, OR COLOR.

PRIORITY CLAIMED UNDER SEC. 44(D) ON CANADA APPLICATION NO. 1274511, FILED 10-4-2005, REG. NO. TMA670112, DATED 8-17-2006, EXPIRES 8-17-2021.

NO CLAIM IS MADE TO THE EXCLUSIVE RIGHT TO USE "BABY", APART FROM THE MARK AS SHOWN.

FOR FERTILITY INDICATORS, NAMELY IN-VITRO OVULATION PREDICTION TEST KITS FOR HOME USE; PREGNANCY TEST KITS FOR HOME USE (U.S. CLS. 6, 18, 44, 46, 51 AND 52).

SHANNON TWOHIG, EXAMINING ATTORNEY

CLASS 5—(Continued).

SN 78-729,275. TITAN PHARMACEUTICALS INC., SOUTH SAN FRANCISCO, CA. FILED 10-7-2005.

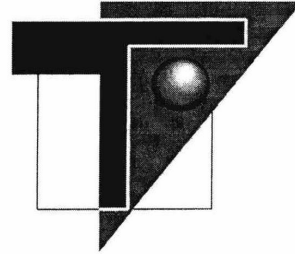

THE MARK CONSISTS OF THE LETTER T WITH A TRIANGLE LOGO.

FOR HOUSEMARK FOR PHARMACEUTICAL COMPONENTS; PHARMACEUTICALS, NAMELY, TREATMENT FOR CENTRAL NERVOUS DISORDERS, CANCER, HEMATOLOGICAL DISORDERS, ENDOCRINE DISORDERS, METABOLIC DISORDERS, INFLAMMATORY DISORDERS, GASTROINTESTINAL DISORDERS, LIVER DISEASE, HEART DISORDERS, LUNG AND BRONCHIAL DISEASE, BLOOD CARDIOVASCULAR DISEASES, CIRCULATORY SYSTEM DISEASE, INTESTINAL DISORDERS, BONE DISEASE, AUTOIMMUNE DISORDERS AND DISORDERS OF THE IMMUNE SYSTEMS, INFECTIOUS DISEASE AND ENZYME DEFICIENCY DISEASE; IMPLANTABLE DELIVERY SYSTEMS COMPRISED OF SUSTAINABLE RELEASE DRUGS FOR TREATMENT FOR CENTRAL NERVOUS DISORDERS, CANCER, HEMATOLOGICAL DISORDERS, ENDOCRINE DISORDERS, METABOLIC DISORDERS, INFLAMMATORY DISORDERS, GASTROINTESTINAL DISORDERS, LIVER DISEASE, HEART DISORDERS, LUNG AND BRONCHIAL DISEASE, BLOOD CARDIOVASCULAR DISEASES, CIRCULATORY SYSTEM DISEASE, INTESTINAL DISORDERS, BONE DISEASE, AUTOIMMUNE DISORDERS AND DISORDERS OF THE IMMUNE SYSTEMS, INFECTIOUS DISEASE AND ENZYME DEFICIENCY DISEASE; AND ANTI-CANCER VACCINES (U.S. CLS. 6, 18, 44, 46, 51 AND 52).

MONIQUE MILLER, EXAMINING ATTORNEY

SN 78-729,430. UPSHER-SMITH LABORATORIES, INC., MAPLE GROVE, MN. FILED 10-8-2005.

FOLGARD RX

THE MARK CONSISTS OF STANDARD CHARACTERS WITHOUT CLAIM TO ANY PARTICULAR FONT, STYLE, SIZE, OR COLOR.

OWNER OF U.S. REG. NOS. 2,441,142 AND 2,636,622.
NO CLAIM IS MADE TO THE EXCLUSIVE RIGHT TO USE "RX", APART FROM THE MARK AS SHOWN.

FOR PRESCRIPTION VITAMINS (U.S. CLS. 6, 18, 44, 46, 51 AND 52).

FIRST USE 10-17-2005; IN COMMERCE 10-17-2005.
GENE MACIOL, EXAMINING ATTORNEY

CLASS 5—(Continued).

SN 78-730,857. VICURON PHARMACEUTICALS INC., KING OF PRUSSIA, PA. FILED 10-11-2005.

DALBAK

THE MARK CONSISTS OF STANDARD CHARACTERS WITHOUT CLAIM TO ANY PARTICULAR FONT, STYLE, SIZE, OR COLOR.

FOR ANTIBIOTIC PREPARATIONS (U.S. CLS. 6, 18, 44, 46, 51 AND 52).

STANLEY I. OSBORNE, EXAMINING ATTORNEY

SN 78-740,269. MISSION PHARMACAL COMPANY, SAN ANTONIO, TX. FILED 10-25-2005.

ULTRAFINE

THE MARK CONSISTS OF STANDARD CHARACTERS WITHOUT CLAIM TO ANY PARTICULAR FONT, STYLE, SIZE, OR COLOR.

FOR DIETARY SUPPLEMENTS INCLUSIVE OF CALCIUM SALT (U.S. CLS. 6, 18, 44, 46, 51 AND 52).

DAVID MILLER, EXAMINING ATTORNEY

SN 78-744,112. IBA INC., MILLBURY, MA. FILED 10-31-2005.

Derma Soft n' Dry

THE MARK CONSISTS OF STANDARD CHARACTERS WITHOUT CLAIM TO ANY PARTICULAR FONT, STYLE, SIZE, OR COLOR.

NO CLAIM IS MADE TO THE EXCLUSIVE RIGHT TO USE "DERMA" AND "DRY", APART FROM THE MARK AS SHOWN.

FOR POWDERED SANITIZING TEAT DIP FOR APPLICATION TO TEATS OF DAIRY COWS (U.S. CLS. 6, 18, 44, 46, 51 AND 52).

FIRST USE 10-31-2002; IN COMMERCE 10-31-2002.

RUSS HERMAN, EXAMINING ATTORNEY

CLASS 5—(Continued).

SN 78-754,146. WEB-AWAY, INC, EL JEBEL, CO. FILED 11-15-2005.

WEB-AWAY

THE MARK CONSISTS OF STANDARD CHARACTERS WITHOUT CLAIM TO ANY PARTICULAR FONT, STYLE, SIZE, OR COLOR.

FOR INSECT REPELLENTS, NAMELY, ALL-NATURAL, NON-TOXIC SPRAYS USED TO REPEL ANTS, ROACHES, BEES, WASPS AND OTHER INSECTS AND DISCOURAGE THEM FROM RETURNING TO AREAS TREATED (U.S. CLS. 6, 18, 44, 46, 51 AND 52).

FIRST USE 7-17-1990; IN COMMERCE 7-17-1990.

STEVEN R. FINE, EXAMINING ATTORNEY

SN 78-772,300. BROOKSIDE AGRA, L.C., HIGHLAND, IL. FILED 12-13-2005.



NO CLAIM IS MADE TO THE EXCLUSIVE RIGHT TO USE "BIOSYSTEMS", APART FROM THE MARK AS SHOWN.

THE COLOR(S) RED, BLACK AND WHITE IS/ARE CLAIMED AS A FEATURE OF THE MARK.

THE MARK CONSISTS OF A STYLIZED, RED, CAPITAL B, WITH THE NAME BROOKSIDE BIOSYSTEMS AND THE RECTANGULAR BACKGROUND DESIGN APPEARING IN THE COLOR BLACK AND THE OVAL BACKGROUND DESIGN APPEARS IN THE COLOR WHITE.

THE MARK CONSISTS OF A STYLIZED, RED, CAPITAL B, CIRCLED IN RED, WITH THE NAME BROOKSIDE BIOSYSTEMS INTERSECTING THE "B" AT THE BOTTOM. FOR ANIMAL WASTE ADDITIVE FOR PURPOSES OF PREVENTING PNEUMONIA, ELIMINATING ODOR, AND DEGRADING ORGANIC MATERIALS (U.S. CLS. 6, 18, 44, 46, 51 AND 52).

FIRST USE 9-15-2004; IN COMMERCE 9-15-2004.

KIMBERLY PERRY, EXAMINING ATTORNEY

CLASS 5—(Continued).

SN 78-779,729. SANOFI-AVENTIS, 75013 PARIS, FRANCE, FILED 12-22-2005.

ZIMULTI

THE MARK CONSISTS OF STANDARD CHARACTERS WITHOUT CLAIM TO ANY PARTICULAR FONT, STYLE, SIZE, OR COLOR.

OWNER OF FRANCE REG. NO. 033221977, DATED 4-23-2003, EXPIRES 4-23-2013.

OWNER OF U.S. REG. NO. 2,987,239.

FOR PHARMACEUTICAL PREPARATIONS FOR THE PREVENTION OF CARDIOVASCULAR DISEASES, FOR SMOKING CESSATION, AND FOR THE TREATMENT OF OBESITY (U.S. CLS. 6, 18, 44, 46, 51 AND 52).

FRED CARL, EXAMINING ATTORNEY

CLASS 5—(Continued).

SN 78-791,602. CAMPBELL, TAMERA, KLAMATH FALLS, OR. AND SAIBER, MICHAEL, KLAMATH FALLS, OR. FILED 1-13-2006.

Phenalmin

THE MARK CONSISTS OF STANDARD CHARACTERS WITHOUT CLAIM TO ANY PARTICULAR FONT, STYLE, SIZE, OR COLOR.

FOR DIETARY SUPPLEMENTS, NAMELY, AN EXTRACT FROM THE BLUE-GREEN ALGAE, APHANIZOMENON FLOS-AQUAE, THAT CONTAINS A SIGNIFICANT CONCENTRATION OF PHENYLETHYLAMINE (U.S. CLS. 6, 18, 44, 46, 51 AND 52).

FIRST USE 1-1-2006; IN COMMERCE 1-1-2006.

JOHN SCHUYLER YARD, EXAMINING ATTORNEY

SN 78-787,750. NDS NUTRITIONAL PRODUCTS, INC., OMAHA, NE. FILED 1-9-2006.

PROFESSIONAL MUSCULAR DEVELOPMENT PMD

THE MARK CONSISTS OF STANDARD CHARACTERS WITHOUT CLAIM TO ANY PARTICULAR FONT, STYLE, SIZE, OR COLOR.

NO CLAIM IS MADE TO THE EXCLUSIVE RIGHT TO USE "PROFESSIONAL MUSCULAR DEVELOPMENT", APART FROM THE MARK AS SHOWN.

FOR NUTRITIONAL AND DIETARY SUPPLEMENTS (U.S. CLS. 6, 18, 44, 46, 51 AND 52).

FIRST USE 7-0-2005; IN COMMERCE 7-0-2005.

TIMOTHY FINNEGAN, EXAMINING ATTORNEY

SN 78-804,138. TASKER PRODUCTS IP HOLDINGS CORP., DANBURY, CT. FILED 2-1-2006.

TASKER PACIFIC BLUE

THE MARK CONSISTS OF STANDARD CHARACTERS WITHOUT CLAIM TO ANY PARTICULAR FONT, STYLE, SIZE, OR COLOR.

FOR ANTIMICROBIAL PREPARATIONS IN THE FORM OF A WASH FOR USE ON SEAFOOD TO INHIBIT ODOR AND MICROBIAL GROWTH (U.S. CLS. 6, 18, 44, 46, 51 AND 52).

ELLEN PERKINS, EXAMINING ATTORNEY

SN 78-791,581. CAMPBELL, TAMERA, KLAMATH FALLS, OR. AND SAIBER, MICHAEL, KLAMATH FALLS, OR. FILED 1-13-2006.

AFAMend

THE MARK CONSISTS OF STANDARD CHARACTERS WITHOUT CLAIM TO ANY PARTICULAR FONT, STYLE, SIZE, OR COLOR.

FOR DIETARY SUPPLEMENTS, NAMELY, A CYANOPHYTA EXTRACT THAT CONTAINS A SIGNIFICANT CONCENTRATION OF THE BLUE PIGMENT PHYCOCYANIN WHICH IS FROM APHANIZOMENON FLOS-AQUAE, A TYPE OF BLUE-GREEN ALGAE (U.S. CLS. 6, 18, 44, 46, 51 AND 52).

FIRST USE 1-1-2006; IN COMMERCE 1-1-2006.

JOHN SCHUYLER YARD, EXAMINING ATTORNEY

SN 78-813,550. DESIGNING HEALTH, INC., VALENCIA, CA. FILED 2-13-2006.



GUARANTEED NO HARM to seals, fish or other animal sources of Omega 3

NO CLAIM IS MADE TO THE EXCLUSIVE RIGHT TO USE "GUARANTEED NO HARM" AND "GUARANTEED NO HARM TO SEALS, FISH OR OTHER ANIMAL SOURCES OF OMEGA 3", APART FROM THE MARK AS SHOWN.

THE COLOR(S) YELLOW, GREEN, DARK GREEN, BLUE, LIGHT BLUE, AND WHITE IS/ARE CLAIMED AS A FEATURE OF THE MARK.

THE MARK CONSISTS OF TWO BLUE MARINE MAMMALS SET ON A LIGHT BLUE BACKGROUND WITH A

CLASS 5—(Continued).

DARK GREEN LINE THROUGH THE MARINE MAMMALS, ALL WITHIN A DARK GREEN INNER CIRCLE SURROUNDED BY A WHITE OUTER CIRCLE AND A YELLOW WIDER RING WITH A PLURALITY OF YELLOW SPIKES SURROUNDING THE WHITE OUTER CIRCLE. THE WORDS "GUARANTEED NO HARM" WITHIN THE YELLOW WIDER RING ARE IN WHITE AND THE WORDS "GUARANTEED NO HARM TO SEALS, FISH OR OTHER ANIMAL SOURCES OF OMEGA 3" APART FROM THE WIDER RING ARE IN YELLOW.

FOR DIETARY SUPPLEMENTS (U.S. CLS. 6, 18, 44, 46, 51 AND 52).

FIRST USE 8-1-2004; IN COMMERCE 10-1-2004.
MARK T. MULLEN, EXAMINING ATTORNEY

SN 78-814,932. CHAU'S INC., SAN FRANCISCO, CA. FILED 2-14-2006.



NO CLAIM IS MADE TO THE EXCLUSIVE RIGHT TO USE "INC.", APART FROM THE MARK AS SHOWN.

THERE ARE TWO SETS OF NON-LATIN CHARACTERS, (I) THE THREE CHINESE CHARACTERS WITHIN THE CIRCLE JUST BELOW "CHAU'S INC." AND (II) THE FOUR CHINESE CHARACTERS BELOW THE FIRST SET. FOR FIRST SET, THE NON-LATIN CHARACTERS IN THE MARK TRANSLITERATE TO "(YERNG WOH TONG)" AND THIS MEANS "(HOUSE OF HARMONY)" IN ENGLISH. FOR THE SECOND SET, THE NON-LATIN CHARACTERS IN THE MARK TRANSLITERATE TO "(ZHOU SHUI GOM ZHAI)" AND THIS MEANS "(MR. CHAU SHU PRODUCER)" IN ENGLISH.

FOR LIQUID COMPOSITION CONTAINING HERBS FOR EXTERNAL USE FOR PAIN RELIEF (U.S. CLS. 6, 18, 44, 46, 51 AND 52).

FIRST USE 4-28-2004; IN COMMERCE 4-28-2004.
DOMINIC FATHY, EXAMINING ATTORNEY

CLASS 5—(Continued).

SN 78-823,912. PEROS SYSTÈMES TECHNOLOGIES INC., MONTREAL, CANADA, FILED 2-27-2006.

ORALJECT

THE MARK CONSISTS OF STANDARD CHARACTERS WITHOUT CLAIM TO ANY PARTICULAR FONT, STYLE, SIZE, OR COLOR.

OWNER OF CANADA REG. NO. TMA617360, DATED 8-24-2004, EXPIRES 8-24-2019.

FOR (BASED ON INTENT TO USE) PHARMACEUTICAL AND VETERINARIAN BIO NUTRITIONAL PRODUCTS AND DELIVERY SYSTEMS FOR THE ORAL ADMINISTRATION OF BIOACTIVE COMPOUNDS, HORMONES AND ANTIBODIES TO MONOGASTRIC LIVING SPECIES INCLUDING HUMAN BEINGS; (BASED ON INTENT TO USE) (BASED ON 44(E)) PHARMACEUTICAL AND VETERINARIAN BIO NUTRITIONAL PRODUCTS, NAMELY AN ORAL INOCULATION SYSTEM OF BIOACTIVE COMPOUNDS, HORMONES AND ANTIBODIES IN THE FORM OF SOLID OR LIQUID MIXES AND COMPOUNDS THAT ARE ORALLY DIGESTED BY MONOGASTRIC LIVING SPECIES (U.S. CLS. 6, 18, 44, 46, 51 AND 52).

DAVID MILLER, EXAMINING ATTORNEY

SN 78-824,908. ULTIMATE NUTRITION, INC., FARMINGTON, CT. FILED 2-28-2006.

PERFECT DIET

THE MARK CONSISTS OF STANDARD CHARACTERS WITHOUT CLAIM TO ANY PARTICULAR FONT, STYLE, SIZE, OR COLOR.

NO CLAIM IS MADE TO THE EXCLUSIVE RIGHT TO USE "DIET", APART FROM THE MARK AS SHOWN.

FOR VITAMINS AND NUTRITIONAL FOOD SUPPLEMENTS (U.S. CLS. 6, 18, 44, 46, 51 AND 52).

JIM RINGLE, EXAMINING ATTORNEY

CLASS 5—(Continued).

SN 78-825,168. GUNA INC., ALBUQUERQUE, NM. FILED 2-28-2006.



ANTI AGE STRESS



NO CLAIM IS MADE TO THE EXCLUSIVE RIGHT TO USE "ANTI AGE STRESS", APART FROM THE MARK AS SHOWN.

THE MARK CONSISTS OF THE WORD ANTI AGE STRESS IS FRAMED BETWEEN 2 LINES.

FOR PHARMACEUTICAL PREPARATIONS FOR THE TREATMENT OF DISORDERS DUE TO STRESS (U.S. CLS. 6, 18, 44, 46, 51 AND 52).

FIRST USE 0-0-1995; IN COMMERCE 2-28-2006.
SAMUEL E. SHARPER JR., EXAMINING ATTORNEY

CLASS 5—(Continued).

SN 78-837,652. PURETEK CORPORATION, SAN FERNANDO, CA. FILED 3-15-2006.

GERM ARREST

THE MARK CONSISTS OF STANDARD CHARACTERS WITHOUT CLAIM TO ANY PARTICULAR FONT, STYLE, SIZE, OR COLOR.

NO CLAIM IS MADE TO THE EXCLUSIVE RIGHT TO USE "GERM", APART FROM THE MARK AS SHOWN.

FOR DIETARY SUPPLEMENTS (U.S. CLS. 6, 18, 44, 46, 51 AND 52).

STEVEN PEREZ, EXAMINING ATTORNEY

SN 78-827,511. ACTELION PHARMACEUTICALS, LTD., ALLSCHWIL, SWITZERLAND, FILED 3-2-2006.



THE MARK MAY BE VIEWED AS A REPRESENTATION OF A HUMAN OR ANIMAL BLOOD VESSEL. THE MARK CONSISTS OF AN ARC, WITH THE INITIATING END WIDER THAN THE TERMINATING END. BELOW THE ARC AND BEGINNING IN THE MIDDLE OF THE ARC, A SERIES OF DOTS FOLLOWS THE CURVE OF THE ARC AND TERMINATES AT THE SAME POINT AS THE TERMINATING END.

FOR MEDICAL AND PHARMACEUTICAL PREPARATIONS FOR USE IN CONNECTION WITH PULMONARY, INFLAMMATORY, CARDIOVASCULAR AND GLYCOLIPID STORAGE DISORDERS AND DISEASES (U.S. CLS. 6, 18, 44, 46, 51 AND 52).

FIRST USE 1-15-2002; IN COMMERCE 1-15-2002.
TRACY WHITAKER-BOWN, EXAMINING ATTORNEY

SN 78-841,827. ACLEARIUM INCORPORATED, WESTFORD, MA. FILED 3-20-2006.

BeneKoi

THE MARK CONSISTS OF STANDARD CHARACTERS WITHOUT CLAIM TO ANY PARTICULAR FONT, STYLE, SIZE, OR COLOR.

FOR KOI GOLDFISH POND MICROBIAL AID, NAMELY, A NATURAL BACTERIAL PRODUCT THAT CLEANS POND SLUDGE AND THAT IS A PROBIOTIC THAT STIMULATES FISH HEALTH (U.S. CLS. 6, 18, 44, 46, 51 AND 52).

FIRST USE 1-1-2006; IN COMMERCE 1-1-2006.
KATHERINE STOIDES, EXAMINING ATTORNEY

SN 78-827,984. VENTRIA BIOSCIENCE, SACRAMENTO, CA. FILED 3-2-2006.

CURAVIVE

THE MARK CONSISTS OF STANDARD CHARACTERS WITHOUT CLAIM TO ANY PARTICULAR FONT, STYLE, SIZE, OR COLOR.

FOR PREPARATIONS FOR THE PREVENTION AND TREATMENT OF ZOONOTIC DISEASES (U.S. CLS. 6, 18, 44, 46, 51 AND 52).

MATTHEW PAPPAS, EXAMINING ATTORNEY

SN 78-843,973. XOTOPO, LLC, PUNTA GORDA, FL. FILED 3-23-2006.

XOTOPO

THE MARK CONSISTS OF STANDARD CHARACTERS WITHOUT CLAIM TO ANY PARTICULAR FONT, STYLE, SIZE, OR COLOR.

FOR OVER THE COUNTER HEALTH AND BEAUTY AID TOPICAL PRODUCT IN PATCH FORM FOR TEMPORARY RELIEF OF MINOR ACHES AND PAINS (U.S. CLS. 6, 18, 44, 46, 51 AND 52).

DANIEL RUSSELL, EXAMINING ATTORNEY

CLASS 5—(Continued).

SN 78-844,217. MEDLINE INDUSTRIES, INC., MUNDELEIN, IL. FILED 3-23-2006.

PURACOL

THE MARK CONSISTS OF STANDARD CHARACTERS WITHOUT CLAIM TO ANY PARTICULAR FONT, STYLE, SIZE, OR COLOR.

FOR WOUND CARE DRESSINGS (U.S. CLS. 6, 18, 44, 46, 51 AND 52).

JUSTINE D. PARKER, EXAMINING ATTORNEY

SN 78-845,050. E-NEMA GMBH, RAISDORF, FED REP GERMANY, FILED 3-24-2006.

nemycel

THE MARK CONSISTS OF STANDARD CHARACTERS WITHOUT CLAIM TO ANY PARTICULAR FONT, STYLE, SIZE, OR COLOR.

FOR ENTOMOPATHOGENIC NEMATODES FOR DESTROYING INSECT PESTS AND VERMIN FOR USE IN THE MUSHROOM INDUSTRY (U.S. CLS. 6, 18, 44, 46, 51 AND 52).

FIRST USE 3-1-2006; IN COMMERCE 3-1-2006.

TRAVIS WHEATLEY, EXAMINING ATTORNEY

SN 78-848,682. J. MORITA USA, INC., IRVINE, CA. FILED 3-29-2006.

foundation

THE MARK CONSISTS OF STANDARD CHARACTERS WITHOUT CLAIM TO ANY PARTICULAR FONT, STYLE, SIZE, OR COLOR.

FOR BONE AUGMENTATION MATERIAL FOR USE AFTER TOOTH EXTRACTION (U.S. CLS. 6, 18, 44, 46, 51 AND 52).

FIRST USE 3-24-2006; IN COMMERCE 3-24-2006.

BARBARA RUTLAND, EXAMINING ATTORNEY

CLASS 5—(Continued).

SN 78-849,114. CYTOSPORT, INC., BENICIA, CA. FILED 3-29-2006.

FUNCTION YOU CAN FEEL

THE MARK CONSISTS OF STANDARD CHARACTERS WITHOUT CLAIM TO ANY PARTICULAR FONT, STYLE, SIZE, OR COLOR.

FOR DIETARY AND NUTRITIONAL SUPPLEMENTS (U.S. CLS. 6, 18, 44, 46, 51 AND 52).

SANI KHOURI, EXAMINING ATTORNEY

SN 78-849,943. SCHERING CORPORATION, KENILWORTH, NJ. FILED 3-30-2006.

THE 1 WEEK KILLER CURE

THE MARK CONSISTS OF STANDARD CHARACTERS WITHOUT CLAIM TO ANY PARTICULAR FONT, STYLE, SIZE, OR COLOR.

OWNER OF U.S. REG. NO. 2,433,491.
FOR ANTIFUNGAL PREPARATION FOR PERSONAL USE (U.S. CLS. 6, 18, 44, 46, 51 AND 52).

AMY MCMENAMIN, EXAMINING ATTORNEY

SN 78-849,988. ULTRA KLEAN INC., ORO VALLEY, AZ. FILED 3-30-2006.



THE COLOR(S) BLACK, WHITE, ORANGE, YELLOW IS/ ARE CLAIMED AS A FEATURE OF THE MARK.

THE MARK CONSISTS OF AN OVAL CONSISTING OF YELLOW AND ORANGE FOUNTAIN FILL WITH A BLACK BORDER, THE WORDS "ULTRA MASK" CONTAINED INSIDE THE OVAL COLORED WITH YELLOW AND ORANGE FOUNTAIN FILL AND BLACK BORDER AND BLACK SHADOW, WITH A BLACK MASK FEATURING WITH EYES AND WHITE MOUTH IN THE MIDDLE BETWEEN THE WORDS "ULTRA" AND "MASK".

FOR DIETARY AND NUTRITIONAL SUPPLEMENTS; VITAMIN FORTIFIED BEVERAGES (U.S. CLS. 6, 18, 44, 46, 51 AND 52).

FIRST USE 10-1-2001; IN COMMERCE 5-1-2002.

SAMUEL E. SHARPER JR., EXAMINING ATTORNEY

CLASS 5—(Continued).

SN 78-850,915. ZOOROB, GEORGE K., COLORADO SPRINGS, CO. FILED 3-31-2006.

CLASS 5—(Continued).

SN 78-854,762. RISE ABOVE NUTRITION, INC., WILLOW-BROOK, IL. FILED 4-5-2006.

MENSTREX

THE MARK CONSISTS OF STANDARD CHARACTERS WITHOUT CLAIM TO ANY PARTICULAR FONT, STYLE, SIZE, OR COLOR.

FOR VITAMINS AND DIETARY SUPPLEMENTS (U.S. CLS. 6, 18, 44, 46, 51 AND 52).

FIRST USE 2-14-2002; IN COMMERCE 12-2-2003.

DAVID ELTON, EXAMINING ATTORNEY

Myodrate 90:90

SN 78-850,919. ZOOROB, GEORGE K., COLORADO SPRINGS, CO. FILED 3-31-2006.

ARTHRILIFE

THE MARK CONSISTS OF STANDARD CHARACTERS WITHOUT CLAIM TO ANY PARTICULAR FONT, STYLE, SIZE, OR COLOR.

FOR VITAMINS AND DIETARY SUPPLEMENTS (U.S. CLS. 6, 18, 44, 46, 51 AND 52).

FIRST USE 2-14-2002; IN COMMERCE 12-2-2003.

DAVID ELTON, EXAMINING ATTORNEY

THE MARK CONSISTS OF STANDARD CHARACTERS WITHOUT CLAIM TO ANY PARTICULAR FONT, STYLE, SIZE, OR COLOR.

FOR AMINO ACIDS FOR MEDICAL OR VETERINARY PURPOSES; DIETARY AND NUTRITIONAL SUPPLEMENTS; DIETARY DRINK MIX FOR USE AS A MEAL REPLACEMENT; DIETARY SUPPLEMENTAL DRINKS; DIETARY SUPPLEMENTS FOR HUMAN CONSUMPTION; MEAL REPLACEMENT AND DIETARY SUPPLEMENT DRINK MIXES; MEAL REPLACEMENT DRINKS; MEAL REPLACEMENT POWDERS; MEAL REPLACEMENT SHAKES; MINERAL NUTRITIONAL SUPPLEMENTS; MINERAL SUPPLEMENTS; MIXED VITAMIN PREPARATIONS; MULTI-VITAMIN PREPARATIONS; NUTRITIONAL DRINK MIX FOR USE AS A MEAL REPLACEMENT; NUTRITIONAL SHAKES FOR USE AS A MEAL SUBSTITUTE; NUTRITIONAL SUPPLEMENTS; POWDERED NUTRITIONAL SUPPLEMENT DRINK MIX; VITAMIN AND MINERAL FORMED AND PACKAGED AS BARS; VITAMIN AND MINERAL PREPARATIONS FOR MEDICAL USE; VITAMIN AND MINERAL PREPARATIONS FOR USE AS INGREDIENTS IN THE FOOD AND PHARMACEUTICAL INDUSTRY; VITAMIN AND MINERAL SUPPLEMENTS; VITAMIN B PREPARATIONS; VITAMIN C PREPARATIONS; VITAMIN D PREPARATIONS; VITAMIN ENRICHED WATER; VITAMIN FORTIFIED BEVERAGES; VITAMIN PREPARATIONS; VITAMIN SUPPLEMENT IN TABLET FORM FOR USE IN MAKING AN EFFERESCENT BEVERAGE WHEN ADDED TO WATER; VITAMIN SUPPLEMENTS; VITAMIN TABLETS; VITAMINS (U.S. CLS. 6, 18, 44, 46, 51 AND 52).

FIRST USE 4-5-2006; IN COMMERCE 4-5-2006.

ATTIYA MALIK, EXAMINING ATTORNEY

SN 78-850,927. ZOOROB, GEORGE K., COLORADO SPRINGS, CO. FILED 3-31-2006.

MENSTRUALIFE

THE MARK CONSISTS OF STANDARD CHARACTERS WITHOUT CLAIM TO ANY PARTICULAR FONT, STYLE, SIZE, OR COLOR.

FOR VITAMINS AND DIETARY SUPPLEMENTS (U.S. CLS. 6, 18, 44, 46, 51 AND 52).

FIRST USE 2-14-2002; IN COMMERCE 12-2-2003.

DAVID ELTON, EXAMINING ATTORNEY

CLASS 5—(Continued).

SN 78-854,799. RISE ABOVE NUTRITION, INC., WILLOW-BROOK, IL. FILED 4-5-2006.

PRIMER 40:14

THE MARK CONSISTS OF STANDARD CHARACTERS WITHOUT CLAIM TO ANY PARTICULAR FONT, STYLE, SIZE, OR COLOR.

FOR AMINO ACIDS FOR MEDICAL OR VETERINARY PURPOSES; DIETARY AND NUTRITIONAL SUPPLEMENTS; DIETARY DRINK MIX FOR USE AS A MEAL REPLACEMENT; DIETARY FIBER AS AN ADDITIVE FOR FOOD PRODUCTS; DIETARY FOOD SUPPLEMENTS; DIETARY SUPPLEMENTAL DRINKS; DIETARY SUPPLEMENTS; DIETARY SUPPLEMENTS FOR HUMAN CONSUMPTION; MEAL REPLACEMENT AND DIETARY SUPPLEMENT DRINK MIXES; MEAL REPLACEMENT BARS; MEAL REPLACEMENT DRINKS; MEAL REPLACEMENT POWDERS; MEAL REPLACEMENT SHAKES; MINERAL NUTRITIONAL SUPPLEMENTS; MIXED VITAMIN PREPARATIONS; MULTI-VITAMIN PREPARATIONS; NUTRITIONAL ADDITIVES FOR USE IN FOODS AND DIETARY SUPPLEMENTS FOR HUMAN CONSUMPTION; NUTRITIONAL DRINK MIX FOR USE AS A MEAL REPLACEMENT; NUTRITIONAL SHAKES FOR USE AS A MEAL SUBSTITUTE; NUTRITIONAL SUPPLEMENTS; POWDERED NUTRITIONAL SUPPLEMENT DRINK MIX; VITAMIN AND MINERAL FORMED AND PACKAGED AS BARS; VITAMIN AND MINERAL PREPARATIONS FOR MEDICAL USE; VITAMIN AND MINERAL SUPPLEMENTS; VITAMIN B PREPARATIONS; VITAMIN C PREPARATIONS; VITAMIN D PREPARATIONS; VITAMIN ENRICHED WATER; VITAMIN FORTIFIED BEVERAGES; VITAMIN SUPPLEMENTS; VITAMIN TABLETS; VITAMINS (U.S. CLS. 6, 18, 44, 46, 51 AND 52).

FIRST USE 4-5-2006; IN COMMERCE 4-5-2006.
ATTIYA MALIK, EXAMINING ATTORNEY

SN 78-855,090. TAYLOR, BRANDON DENE, SCOTTSDALE, AZ. FILED 4-5-2006.



NO CLAIM IS MADE TO THE EXCLUSIVE RIGHT TO USE "CPR" AND "FIRST AID SUPPLY", APART FROM THE MARK AS SHOWN.

FOR FIRST AID KITS (U.S. CLS. 6, 18, 44, 46, 51 AND 52).

FIRST USE 3-16-2003; IN COMMERCE 3-16-2003.
JEFFERY COWARD, EXAMINING ATTORNEY

CLASS 5—(Continued).

SN 78-855,435. 3M COMPANY, ST. PAUL, MN. FILED 4-6-2006.

MAXAIR

THE MARK CONSISTS OF STANDARD CHARACTERS WITHOUT CLAIM TO ANY PARTICULAR FONT, STYLE, SIZE, OR COLOR.

OWNER OF U.S. REG. NO. 1,523,151.

FOR PHARMACEUTICAL PREPARATIONS, NAMELY, BRONCHODILATORS FOR TREATING RESPIRATORY CONDITIONS SUCH AS BRONCHOSPASM AND ASTHMA (U.S. CLS. 6, 18, 44, 46, 51 AND 52).

FIRST USE 1-31-1990; IN COMMERCE 1-31-1990.

PAM WILLIS, EXAMINING ATTORNEY

SN 78-855,455. 3M COMPANY, ST. PAUL, MN. FILED 4-6-2006.

AUTOHALER

THE MARK CONSISTS OF STANDARD CHARACTERS WITHOUT CLAIM TO ANY PARTICULAR FONT, STYLE, SIZE, OR COLOR.

OWNER OF U.S. REG. NO. 856,085.

FOR INHALERS FILLED WITH BRONCHODILATORS FOR TREATING RESPIRATORY CONDITIONS SUCH AS BRONCHOSPASM AND ASTHMA (U.S. CLS. 6, 18, 44, 46, 51 AND 52).

FIRST USE 6-30-1993; IN COMMERCE 6-30-1993.

PAM WILLIS, EXAMINING ATTORNEY

SN 78-856,561. JACOBS, RANDY J., MURRIETA, CA. FILED 4-7-2006.



THE MARK CONSISTS OF STANDARD CHARACTERS WITHOUT CLAIM TO ANY PARTICULAR FONT, STYLE, SIZE, OR COLOR.

NO CLAIM IS MADE TO THE EXCLUSIVE RIGHT TO USE "ACNE", APART FROM THE MARK AS SHOWN.

FOR ACNE SKIN CARE PREPARATION FOR PERSONAL USE (U.S. CLS. 6, 18, 44, 46, 51 AND 52).

BRIAN PINO, EXAMINING ATTORNEY

CLASS 5—(Continued).

SN 78-856,885. PHOENIX FOOD INDUSTRIES, PHOENIX, AZ. FILED 4-7-2006.

INSUL OPT

THE MARK CONSISTS OF STANDARD CHARACTERS WITHOUT CLAIM TO ANY PARTICULAR FONT, STYLE, SIZE, OR COLOR.

FOR DIETARY AND NUTRITIONAL SUPPLEMENTS (U.S. CLS. 6, 18, 44, 46, 51 AND 52).

FIRST USE 3-1-2006; IN COMMERCE 3-1-2006.
ANNE MADDEN, EXAMINING ATTORNEY

SN 78-857,369. DAVGLO MULTI MEDIA, SANDPOINT, ID. FILED 4-9-2006.

ColonSweep

THE MARK CONSISTS OF STANDARD CHARACTERS WITHOUT CLAIM TO ANY PARTICULAR FONT, STYLE, SIZE, OR COLOR.

FOR DIETARY AND NUTRITIONAL SUPPLEMENTS; DIETARY FOOD SUPPLEMENTS; DIETARY SUPPLEMENTS; DIETARY SUPPLEMENTS FOR HUMAN CONSUMPTION; FOOD SUPPLEMENTS; HERBAL SUPPLEMENTS; HOMEOPATHIC SUPPLEMENTS; MINERAL NUTRITIONAL SUPPLEMENTS; MINERAL SUPPLEMENTS; NUTRACEUTICALS FOR USE AS A DIETARY SUPPLEMENT; NUTRITIONAL SHAKES FOR USE AS A MEAL SUBSTITUTE; NUTRITIONAL SUPPLEMENTS; VITAMIN AND MINERAL SUPPLEMENTS; VITAMIN SUPPLEMENTS (U.S. CLS. 6, 18, 44, 46, 51 AND 52).

BRENDAN REGAN, EXAMINING ATTORNEY

SN 78-857,653. BLUE CALIFORNIA CO., RANCHO SANTA MARGARITA, CA. FILED 4-10-2006.

Astapure

THE MARK CONSISTS OF STANDARD CHARACTERS WITHOUT CLAIM TO ANY PARTICULAR FONT, STYLE, SIZE, OR COLOR.

FOR NUTRITIONAL SUPPLEMENTS (U.S. CLS. 6, 18, 44, 46, 51 AND 52).

WENDY GOODMAN, EXAMINING ATTORNEY

CLASS 5—(Continued).

SN 78-857,664. FREELIFE INTERNATIONAL, LLC, MILFORD, CT. FILED 4-10-2006.



OWNER OF U.S. REG. NOS. 2,904,019 AND 2,942,083.
NO CLAIM IS MADE TO THE EXCLUSIVE RIGHT TO USE HIMALAYAN GOJI JUICE, APART FROM THE MARK AS SHOWN.

THE MARK CONSISTS OF A RECTANGULAR BLACK BACKGROUND CONTAINING THE WORDS "HIMALAYAN GOJI JUICE", A WAVY LINE AND A BERRY DESIGN.

FOR NUTRITIONALLY FORTIFIED FRUIT-BASED BEVERAGES (U.S. CLS. 6, 18, 44, 46, 51 AND 52).

FIRST USE 10-10-2003; IN COMMERCE 10-10-2003.
MONIQUE MILLER, EXAMINING ATTORNEY

SN 78-857,681. BERKELEY PREMIUM NUTRACEUTICALS, INC., CINCINNATI, OH. FILED 4-10-2006.

THE VERY BEST. FOR LIFE.

THE MARK CONSISTS OF STANDARD CHARACTERS WITHOUT CLAIM TO ANY PARTICULAR FONT, STYLE, SIZE, OR COLOR.

NO CLAIM IS MADE TO THE EXCLUSIVE RIGHT TO USE "THE VERY BEST", APART FROM THE MARK AS SHOWN.

FOR DIETARY SUPPLEMENTS (U.S. CLS. 6, 18, 44, 46, 51 AND 52).

LAURA KOVALSKY, EXAMINING ATTORNEY

CLASS 5—(Continued).

SN 78-857,686. WATERSAVR GLOBAL SOLUTIONS, INC., VICTORIA, CANADA, FILED 4-10-2006.

WS-BTI

THE MARK CONSISTS OF STANDARD CHARACTERS WITHOUT CLAIM TO ANY PARTICULAR FONT, STYLE, SIZE, OR COLOR.

FOR PESTICIDES, NAMELY, A DRY POWDER THAT SPREADS BTI BACTERIA ACROSS THE SURFACE OF WATER FOR THE PURPOSE OF KILLING MOSQUITO LARVAE (U.S. CLS. 6, 18, 44, 46, 51 AND 52).

FIRST USE 10-1-2004; IN COMMERCE 12-1-2005.
LINDA LAVACHE, EXAMINING ATTORNEY

SN 78-857,890. VERUS PHARMACEUTICALS, INC., SAN DIEGO, CA. FILED 4-10-2006.

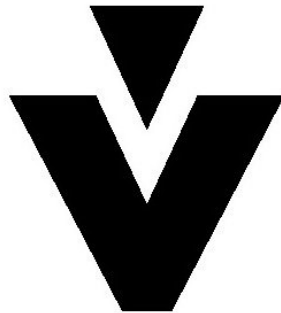

THE MARK CONSISTS OF A V WITH AN INVERTED TRIANGLE IN AND ABOVE THE MIDDLE OF THE V.

FOR PHARMACEUTICAL PRODUCTS PRIMARILY INTENDED FOR PEDIATRIC USE FOR TREATING ASTHMA, ALLERGIES AND RELATED RESPIRATORY AND ALLERGY BASED DISEASES AND CONDITIONS (U.S. CLS. 6, 18, 44, 46, 51 AND 52).

KATHLEEN M. VANSTON, EXAMINING ATTORNEY

SN 78-857,951. QCE, INC., WOODSTOCK, GA. FILED 4-10-2006.

Anēma●Vite

Comprehensive Anemia Supplement

NO CLAIM IS MADE TO THE EXCLUSIVE RIGHT TO USE "COMPREHENSIVE ANEMIA SUPPLEMENT", APART FROM THE MARK AS SHOWN.

THE COLOR(S) WHITE RED AND BLUE IS/ARE CLAIMED AS A FEATURE OF THE MARK.

THE MARK CONSISTS OF THE WORD "ANEMA" FOLLOWED BY A CIRCLE AND THEN THE WORD "VITE". THE WORD "ANEMA" HAS AN ACCENT MARK OVER THE LETTER "E" INDICATING THE PHONETIC PRONUNCIATION OF A LONG "EE" SOUND. THE WORD "ANEMA",

CLASS 5—(Continued).

THE CIRCLE, AND THE WORD "VITE" ARE ALL OUTLINED IN BLUE. THE FILL COLOR FOR THE WORD "ANEMA" (INCLUDING THE ACCENT MARK OVER THE LETTER "E") IS WHITE BEGINNING ON THE LETTER "A" AND THEN RADIATES ACROSS THE WORD TOWARD THE RIGHT UNTIL IT BECOMES SOLID RED ON THE ENDING LETTER "A". THE CIRCLE IS FILLED WITH THE CENTER OF THE CIRCLE BEING WHITE RADIATING OUTWARD UNTIL IT BECOMES SOLID RED. THE WORD "VITE" IS FILLED WITH SOLID RED. THE PHRASE "COMPREHENSIVE ANEMIA SUPPLEMENT" IS BLUE.

FOR VITAMIN AND MINERAL PREPARATIONS FOR MEDICAL USE (U.S. CLS. 6, 18, 44, 46, 51 AND 52).

FIRST USE 10-1-2005; IN COMMERCE 12-15-2005.
KRISTINA KLOIBER, EXAMINING ATTORNEY

SN 78-858,395. COLORSTAR HOLDING B.V., AMSTERDAM 1059 CE, NETHERLANDS, FILED 4-11-2006.

AquaMio

THE MARK CONSISTS OF STANDARD CHARACTERS WITHOUT CLAIM TO ANY PARTICULAR FONT, STYLE, SIZE, OR COLOR.

FOR MINERAL SUPPLEMENTS (U.S. CLS. 6, 18, 44, 46, 51 AND 52).

JASON LOTT, EXAMINING ATTORNEY

SN 78-858,461. SPECIALTY NUTRITION GROUP, INC., BOCA RATON, FL. FILED 4-11-2006.

SOLAR DEFENSE

THE MARK CONSISTS OF STANDARD CHARACTERS WITHOUT CLAIM TO ANY PARTICULAR FONT, STYLE, SIZE, OR COLOR.

FOR DIETARY SUPPLEMENTS; FOOD SUPPLEMENTS; HERBAL SUPPLEMENTS; MINERAL SUPPLEMENTS; NUTRITIONAL SUPPLEMENTS; VITAMIN SUPPLEMENTS (U.S. CLS. 6, 18, 44, 46, 51 AND 52).

MARILYN IZZI, EXAMINING ATTORNEY

CLASS 5—(Continued).

SN 78-858,553. KRAMER LABORATORIES, INC., MIAMI, FL. FILED 4-11-2006.

MI ANGELITO NARICITA

THE MARK CONSISTS OF STANDARD CHARACTERS WITHOUT CLAIM TO ANY PARTICULAR FONT, STYLE, SIZE, OR COLOR.

NO CLAIM IS MADE TO THE EXCLUSIVE RIGHT TO USE "NARICITA", APART FROM THE MARK AS SHOWN. THE FOREIGN WORDING IN THE MARK TRANSLATES INTO ENGLISH AS MI ANGELITO MEANS "MY LITTLE ANGEL" AND NARICITA MEANS "LITTLE NOSE".

FOR NATURAL DECONGESTANT NASAL SPRAY RELIEF FOR DRY AND STUFFY NOSES (U.S. CLS. 6, 18, 44, 46, 51 AND 52).

ALICE BENMAMAN, EXAMINING ATTORNEY



SN 78-859,639. TANGO ADVANCED NUTRITION, INC., SAN FRANCISCO, CA. FILED 4-12-2006.

VITAL CELL

THE MARK CONSISTS OF STANDARD CHARACTERS WITHOUT CLAIM TO ANY PARTICULAR FONT, STYLE, SIZE, OR COLOR.

FOR DIETARY, HERBAL AND NUTRITIONAL SUPPLEMENTS (U.S. CLS. 6, 18, 44, 46, 51 AND 52).

FIRST USE 6-6-2005; IN COMMERCE 6-8-2005.

WILLIAM P. SHANAHAN, EXAMINING ATTORNEY



SN 78-859,765. ULTIMATE NUTRITION, INC., FARMINGTON, CT. FILED 4-12-2006.

WHEYFER

THE MARK CONSISTS OF STANDARD CHARACTERS WITHOUT CLAIM TO ANY PARTICULAR FONT, STYLE, SIZE, OR COLOR.

FOR NUTRITIONAL PRODUCTS, NAMELY DIETARY SUPPLEMENTS (U.S. CLS. 6, 18, 44, 46, 51 AND 52).

SALLY SHIH, EXAMINING ATTORNEY

CLASS 5—(Continued).

SN 78-859,902. MAKHTESHIM-AGAN INDUSTRIES LTD., BEER-SHEVA, ISRAEL, FILED 4-12-2006.

ADJOURN

THE MARK CONSISTS OF STANDARD CHARACTERS WITHOUT CLAIM TO ANY PARTICULAR FONT, STYLE, SIZE, OR COLOR.

FOR INSECTICIDES FOR AGRICULTURAL USE (U.S. CLS. 6, 18, 44, 46, 51 AND 52).

DAVID MILLER, EXAMINING ATTORNEY



SN 78-860,775. SHEFRIN, DAVID K., WILSONVILLE, OR. FILED 4-13-2006.

HepaGlycyrrhizic

THE MARK CONSISTS OF STANDARD CHARACTERS WITHOUT CLAIM TO ANY PARTICULAR FONT, STYLE, SIZE, OR COLOR.

FOR DIETARY SUPPLEMENTS; FOOD SUPPLEMENTS; HERBAL SUPPLEMENTS; NUTRITIONAL SUPPLEMENTS (U.S. CLS. 6, 18, 44, 46, 51 AND 52).

FIRST USE 12-1-1993; IN COMMERCE 12-1-1993.

CARYN GLASSER, EXAMINING ATTORNEY



SN 78-861,106. EBY, GEORGE ANDREW III, AUSTIN, TX. FILED 4-13-2006.

AsthMag

THE MARK CONSISTS OF STANDARD CHARACTERS WITHOUT CLAIM TO ANY PARTICULAR FONT, STYLE, SIZE, OR COLOR.

FOR PHARMACEUTICAL PREPARATIONS FOR TREATING ALLERGIC RHINITIS AND ASTHMA (U.S. CLS. 6, 18, 44, 46, 51 AND 52).

FIRST USE 3-6-2006; IN COMMERCE 4-2-2006.

CYNTHIA SLOAN, EXAMINING ATTORNEY

CLASS 5—(Continued).

SN 78-861,413. IMAGENETIX, SAN DIEGO, CA. FILED 4-13-2006.

INFLAME AWAY

THE MARK CONSISTS OF STANDARD CHARACTERS WITHOUT CLAIM TO ANY PARTICULAR FONT, STYLE, SIZE, OR COLOR.

NO CLAIM IS MADE TO THE EXCLUSIVE RIGHT TO USE "INFLAME", APART FROM THE MARK AS SHOWN. FOR DIETARY SUPPLEMENTS; TOPICAL ANALGESICS (U.S. CLS. 6, 18, 44, 46, 51 AND 52).

KELLY BOULTON, EXAMINING ATTORNEY

SN 78-861,416. IMAGENETIX, SAN DIEGO, CA. FILED 4-13-2006.

EXFLAMMATION

THE MARK CONSISTS OF STANDARD CHARACTERS WITHOUT CLAIM TO ANY PARTICULAR FONT, STYLE, SIZE, OR COLOR.

FOR DIETARY SUPPLEMENTS; TOPICAL ANALGESICS (U.S. CLS. 6, 18, 44, 46, 51 AND 52).

KELLY BOULTON, EXAMINING ATTORNEY

SN 78-862,017. XND TECHNOLOGIES, INC., SCOTTSDALE, AZ. FILED 4-14-2006.

Nu20

THE MARK CONSISTS OF STANDARD CHARACTERS WITHOUT CLAIM TO ANY PARTICULAR FONT, STYLE, SIZE, OR COLOR.

FOR NUTRITIONALLY FORTIFIED WATER (U.S. CLS. 6, 18, 44, 46, 51 AND 52).

JOANNA DUKOVIC, EXAMINING ATTORNEY

CLASS 5—(Continued).

SN 78-862,323. HOUSTON, DEVIN B, SILOAM SPRINGS, AR. FILED 4-15-2006.

Houston enzymes

THE MARK CONSISTS OF STANDARD CHARACTERS WITHOUT CLAIM TO ANY PARTICULAR FONT, STYLE, SIZE, OR COLOR.

NO CLAIM IS MADE TO THE EXCLUSIVE RIGHT TO USE "ENZYMES", APART FROM THE MARK AS SHOWN. FOR NUTRACEUTICALS FOR USE AS A DIETARY SUPPLEMENT (U.S. CLS. 6, 18, 44, 46, 51 AND 52).

JENNIFER VASQUEZ, EXAMINING ATTORNEY

SN 78-862,546. MEDIGENE AG, MARTINSRIED, FED REP GERMANY, FILED 4-17-2006.

VEREGEN

THE MARK CONSISTS OF STANDARD CHARACTERS WITHOUT CLAIM TO ANY PARTICULAR FONT, STYLE, SIZE, OR COLOR.

FOR PHARMACEUTICAL PRODUCTS FOR TOPICAL, INTRA-VAGINAL AND/OR INTRA-ANAL APPLICATION, NAMELY, PHARMACEUTICAL PREPARATIONS FOR USE IN TREATING THE SKIN DISEASES OF WARTS, VERRUCA VULGARIS, VERRUCA PLANTARIS, VERRUCA PLANA, FLAT CONDYLOMATA, MOSAIC-TYPE WARTS, BUTCHER'S WARTS, ANOGENITAL WARTS, CONDYLOMATA ACCUMINATA, HYPERPLASIA OF THE EPIDERMIS, RECALCITRANT CUTANEOUS WARTS, HERPES INFECTION, GENITAL AND ANAL HERPES INFECTION, SHINGLES, MOLLUSCUM CONTAGIOSUM, MYCOSIS, MYCOSIS FUNGOIDES, TINEA, TINEA PEDIS, PIGMENTATION DISORDERS, HYPERPIGMENTATION, HYPOPIGMENTATION, VITILIGO, MELASMA, ATYPICAL/DISPLASTIC/MELANOCYTIC NEVI, SUN-DAMAGED SKIN, REMOVAL OF TATTOOS, PSORIASIS, NEURODERMITIS, DERMATITIS, ATOPIC DERMATITIS, CUTANEOUS ATOPY, ECZEMA, LICHEN PLANUS, CUTANEOUS LUPUS ERYTHEMATOSUS, SKIN ULCERS, ROSACEA, PRECANCEROUS AND CANCEROUS LESIONS, INCREASED PROLIFERATION OF SKIN CELLS, ACTINIC KERATOSIS, ACTINIC CHEILITIS, KELOIDS, LENTIGO, HEMANGIOMA, EPIDERMODYSPLASIA VERRUIFORMIS, BOWEN'S DISEASE, BOWENOID PAPULOSIS, BASAL CELL CARCINOMA, INTRAEPITHELIAL SQUAMOUS CELL CARCINOMA, MELANOMA, AND OTHER SKIN CANCERS, NEOPLASIAS, CERVICAL DYSPLASIA, CERVICAL INTRAEPITHELIAL NEOPLASIAS, ANAL INTRAEPITHELIAL NEOPLASIAS, VULVAR INTRAEPITHELIAL NEOPLASIA, PENILE CANCER, VULVOVAGINAL CANCER, ANAL CARCINOMA, CERVICAL CARCINOMA, CUTANEOUS T-CELL LYMPHOMA, ALOPECIA, VULVODYNIA, KELOID AND HYPERTROPHIC SCARS, POST SURGICAL EXCISION ON SCAR COSMESIS, HYPERKERATOSIS, SEBORRHEA, DARIER'S DISEASE, POROKERATOSIS OF MIBELLI, ICHTHYOSIS, XEROSIS, DARTROUD DISTHESIS, ACNE, NASAL PAPILLOMA, ORAL PAPILLOMA, FOCAL EPITHELIAL HYPERPLASIA, LARYNGEAL PAPILLOMA, CURRENT RESPIRATORY PAPILLOMATOSIS AND CONJUNCTIVAL PAPILLOMA (U.S. CLS. 6, 18, 44, 46, 51 AND 52).

CAROLINE WEIMER, EXAMINING ATTORNEY

CLASS 5—(Continued).

SN 78-862,547. MEDIGENE AG, MARTINSRIED, FED REP GERMANY, FILED 4-17-2006.

LOMILIN

THE MARK CONSISTS OF STANDARD CHARACTERS WITHOUT CLAIM TO ANY PARTICULAR FONT, STYLE, SIZE, OR COLOR.

FOR PHARMACEUTICAL PRODUCTS FOR TOPICAL, INTRA-VAGINAL AND/OR INTRA-ANAL APPLICATION, NAMELY, PHARMACEUTICAL PREPARATIONS FOR USE IN TREATING THE SKIN DISEASES OF WARTS, VERRUCA VULGARIS, VERRUCA PLAN-TARIS, VERRUCA PLANA, FLAT CONDYLOMATA, MOSAIC-TYPE WARTS, BUTCHER'S WARTS, ANOGEN-ITAL WARTS, CONDYLOMATA ACCUMINATA, HY-PERPLASIA OF THE EPIDERMIS, RECALCITRANT CUTANEOUS WARTS, HERPES INFECTION, GENITAL AND ANAL HERPES INFECTION, SHINGLES, MOL-USCUM CONTAGIOSUM, MYCOSIS, MYCOSIS FUN-GOIDES, TINEA, TINEA PEDIS, PIGMENTATION DISORDERS, HYPERPIGMENTATION, HYPOPIGMENTATION, VITILIGO, MELASMA, ATYPICAL/DISPLAS-TIC/MELANOCYTIC NEVI, SUN-DAMAGED SKIN, REMOVAL OF TATTOOS, PSORIASIS, NEURODERMI-TIS, DERMATITIS, ATOPIC DERMATITIS, CUTANEOUS ATOPY, ECZEMA, LICHEN PLANUS, CUTANEOUS LUPUS ERYTHEMATOSUS, SKIN ULCERS, ROSACEA, PRECANCEROUS AND CANCEROUS LESIONS, IN-CREASED PROLIFERATION OF SKIN CELLS, ACTINIC KERATOSIS, ACTINIC CHEILITIS, KELOIDS, LENTIGO, HEMANGIOMA, EPIDERMODYSPLASIA VERRUCI-FORMIS, BOWEN'S DISEASE, BOWENOID PAPULOSIS, BASAL CELL CARCINOMA, INTRAEPITHELIAL SQUA-MOUS CELL CARCINOMA, MELANOMA, AND OTHER SKIN CANCERS, NEOPLASIAS, CERVICAL DYSPLASIA, CERVICAL INTRAEPITHELIAL NEOPLASIAS, ANAL INTRAEPITHELIAL NEOPLASIAS, VULVAR INTRAEP-ITHELIAL NEOPLASIA, PENILE CANCER, VULVOVA-GINAL CANCER, ANAL CARCINOMA, CERVICAL CARCINOMA, CUTANEOUS T-CELL LYMPHOMA, ALOPECIA, VULVODYNIA, KELOID AND HYPER-TROPHIC SCARS, POST SURGICAL EXCISION ON SCAR COSMESIS, HYPERKERATOSIS, SEBORRHEA, DARIER'S DISEASE, POROKERATOSIS OF MIBELLI, ICHTHYOSIS, XEROSIS, DARTROUD DISTHESIS, ACNE, NASAL PAPILLOMA, ORAL PAPILLOMA, FO-CAL EPITHELIAL HYPERPLASIA, LARYNGEAL PAPI-LOMA, R E C U R R E N T R E S P I R A T O R Y P A P I L L O M A T O S I S A N D C O N J U N C T I V A L P A P I L L O M A (U.S. CLS. 6, 18, 44, 46, 51 AND 52).

CAROLINE WEIMER, EXAMINING ATTORNEY

SN 78-862,694. DESTON THERAPEUTICS, INC., DURHAM, NC. FILED 4-17-2006.

HISTADEC

THE MARK CONSISTS OF STANDARD CHARACTERS WITHOUT CLAIM TO ANY PARTICULAR FONT, STYLE, SIZE, OR COLOR.

FOR PHARMACEUTICAL PREPARATIONS FOR THE TREATMENT OF COUGHS AND COLDS (U.S. CLS. 6, 18, 44, 46, 51 AND 52).

KRISTINA KLOIBER, EXAMINING ATTORNEY

CLASS 5—(Continued).

SN 78-862,806. ZYMA, LLC, EXTON, PA. FILED 4-17-2006.

RHEOGEN

THE MARK CONSISTS OF STANDARD CHARACTERS WITHOUT CLAIM TO ANY PARTICULAR FONT, STYLE, SIZE, OR COLOR.

FOR NUTRITIONAL AND DIETARY SUPPLEMENTS; FOOD SUPPLEMENTS; NUTRITIONAL ADDITIVES FOR USE IN FOODS AND DIETARY SUPPLEMENTS FOR HUMAN CONSUMPTION (U.S. CLS. 6, 18, 44, 46, 51 AND 52).

FIRST USE 4-2-2006; IN COMMERCE 4-10-2006.
KATHY DE JONGE, EXAMINING ATTORNEY

SN 78-862,842. SALUGEN, INC., SAN DIEGO, CA. FILED 4-17-2006.



THE MARK CONSISTS OF A WORD DESIGN INCLUD-ING A DOUBLE HELIX WITHIN THE LETTER "U".

FOR DIETARY SUPPLEMENTS (U.S. CLS. 6, 18, 44, 46, 51 AND 52).

MARIA-VICTORIA SUAREZ, EXAMINING ATTORNEY

SN 78-862,854. SALUGEN, INC., SAN DIEGO, CA. FILED 4-17-2006.

SALUGEN

THE MARK CONSISTS OF STANDARD CHARACTERS WITHOUT CLAIM TO ANY PARTICULAR FONT, STYLE, SIZE, OR COLOR.

FOR DIETARY SUPPLEMENTS (U.S. CLS. 6, 18, 44, 46, 51 AND 52).

MARIA-VICTORIA SUAREZ, EXAMINING ATTORNEY

CLASS 5—(Continued).

SN 78-862,856. HUNTLEY, DOUGLAS B., HENDERSON-VILLE, NC. FILED 4-17-2006.

UR-AID

THE MARK CONSISTS OF STANDARD CHARACTERS WITHOUT CLAIM TO ANY PARTICULAR FONT, STYLE, SIZE, OR COLOR.
FOR NUTRITIONAL SUPPLEMENTS (U.S. CLS. 6, 18, 44, 46, 51 AND 52).
FIRST USE 3-1-2004; IN COMMERCE 3-1-2004.
ROBERT STRUCK, EXAMINING ATTORNEY

SN 78-862,877. HUNTLEY, DOUGLAS B., HENDERSON-VILLE, NC. FILED 4-17-2006.

ADVANCE METABOLIC BLITZ

THE MARK CONSISTS OF STANDARD CHARACTERS WITHOUT CLAIM TO ANY PARTICULAR FONT, STYLE, SIZE, OR COLOR.
NO CLAIM IS MADE TO THE EXCLUSIVE RIGHT TO USE "METABOLIC", APART FROM THE MARK AS SHOWN.
FOR VITAMIN AND MINERAL SUPPLEMENTS (U.S. CLS. 6, 18, 44, 46, 51 AND 52).
FIRST USE 2-1-2006; IN COMMERCE 2-1-2006.
ROBERT STRUCK, EXAMINING ATTORNEY

SN 78-862,880. SALUGEN, INC., SAN DIEGO, CA. FILED 4-17-2006.

GENOFLEX

THE MARK CONSISTS OF STANDARD CHARACTERS WITHOUT CLAIM TO ANY PARTICULAR FONT, STYLE, SIZE, OR COLOR.
FOR DIETARY SUPPLEMENTS (U.S. CLS. 6, 18, 44, 46, 51 AND 52).
MARIA-VICTORIA SUAREZ, EXAMINING ATTORNEY

CLASS 5—(Continued).

SN 78-862,903. SALUGEN, INC., SAN DIEGO, CA. FILED 4-17-2006.

GENOTRIM

THE MARK CONSISTS OF STANDARD CHARACTERS WITHOUT CLAIM TO ANY PARTICULAR FONT, STYLE, SIZE, OR COLOR.
FOR DIETARY SUPPLEMENTS (U.S. CLS. 6, 18, 44, 46, 51 AND 52).
MARIA-VICTORIA SUAREZ, EXAMINING ATTORNEY

SN 78-862,970. SALUGEN, INC., SAN DIEGO, CA. FILED 4-17-2006.

SPAGEN

THE MARK CONSISTS OF STANDARD CHARACTERS WITHOUT CLAIM TO ANY PARTICULAR FONT, STYLE, SIZE, OR COLOR.
FOR DIETARY SUPPLEMENTS (U.S. CLS. 6, 18, 44, 46, 51 AND 52).
MARIA-VICTORIA SUAREZ, EXAMINING ATTORNEY

SN 78-863,020. REPLIKINS, LTD., NEW YORK, NY. FILED 4-17-2006.



THE MARK CONSISTS OF THE WORDING REPLIKINS SUPERIMPOSED ON A STYLIZED R.
FOR BIOCHEMICAL PREPARATIONS FOR MEDICAL USE, NAMELY, NUCLEIC ACIDS, PEPTIDES, AND PROTEINS ASSOCIATED WITH RAPID REPLICATION OF BIOLOGICAL ENTITIES, NAMELY, CELLS, TISSUES, AND ORGANS, FOR USE IN THE DIAGNOSIS, PREVENTION, AND TREATMENT OF CANCER AND INFECTIOUS DISEASES AND FOR USE AS A GROWTH STIMULANT (U.S. CLS. 6, 18, 44, 46, 51 AND 52).
KEVIN CORWIN, EXAMINING ATTORNEY

CLASS 5—(Continued).

SN 78-863,064. OMS INVESTMENTS, INC., LOS ANGELES, CA. FILED 4-17-2006.

TOTALKILL

THE MARK CONSISTS OF STANDARD CHARACTERS WITHOUT CLAIM TO ANY PARTICULAR FONT, STYLE, SIZE, OR COLOR.
FOR INSECTICIDES, PESTICIDES, AND HERBICIDES FOR DOMESTIC USE (U.S. CLS. 6, 18, 44, 46, 51 AND 52).
COLLEEN KEARNEY, EXAMINING ATTORNEY

SN 78-863,068. OMS INVESTMENTS, INC., LOS ANGELES, CA. FILED 4-17-2006.

TRUEKILL

THE MARK CONSISTS OF STANDARD CHARACTERS WITHOUT CLAIM TO ANY PARTICULAR FONT, STYLE, SIZE, OR COLOR.
FOR INSECTICIDES, PESTICIDES, AND HERBICIDES FOR DOMESTIC USE (U.S. CLS. 6, 18, 44, 46, 51 AND 52).
COLLEEN KEARNEY, EXAMINING ATTORNEY

SN 78-863,117. DOW PHARMACEUTICAL SCIENCES, INC., PETALUMA, CA. FILED 4-17-2006.

Hydrogel

FOR TOPICAL GEL FOR MEDICAL AND THERAPEUTIC USE FOR THE TREATMENT OF SKIN CONDITIONS AND SKIN DISEASES (U.S. CLS. 6, 18, 44, 46, 51 AND 52).
ALICE BENMAMAN, EXAMINING ATTORNEY

CLASS 5—(Continued).

SN 78-863,215. DAVGLO MULTI MEDIA, SOUTH PASADENA, CA. FILED 4-17-2006.

EliminAid

THE MARK CONSISTS OF STANDARD CHARACTERS WITHOUT CLAIM TO ANY PARTICULAR FONT, STYLE, SIZE, OR COLOR.
FOR NUTRITIONAL HEALTH SUPPLEMENTS (U.S. CLS. 6, 18, 44, 46, 51 AND 52).
BRENDAN REGAN, EXAMINING ATTORNEY

SN 78-863,498. RICECO LLC, MEMPHIS, TN. FILED 4-18-2006.

RICE-GRO

THE MARK CONSISTS OF STANDARD CHARACTERS WITHOUT CLAIM TO ANY PARTICULAR FONT, STYLE, SIZE, OR COLOR.
OWNER OF U.S. REG. NOS. 2,691,280, 3,047,832 AND OTHERS.
FOR HERBICIDES, INSECTICIDES, PESTICIDES AND FUNGICIDES FOR AGRICULTURAL USE (U.S. CLS. 6, 18, 44, 46, 51 AND 52).
TINA BROWN, EXAMINING ATTORNEY

SN 78-863,676. SHIRE HUMAN GENETIC THERAPIES, INC., BOSTON, MA. FILED 4-18-2006.

IPRALASE

THE MARK CONSISTS OF STANDARD CHARACTERS WITHOUT CLAIM TO ANY PARTICULAR FONT, STYLE, SIZE, OR COLOR.
FOR PHARMACEUTICAL PREPARATIONS FOR THE TREATMENT OF ENZYME DEFICIENCIES; PHARMACEUTICAL PREPARATIONS FOR THE TREATMENT OF METABOLIC DISORDERS; PHARMACEUTICAL PREPARATIONS FOR THE TREATMENT OF HUNTER'S SYNDROME (U.S. CLS. 6, 18, 44, 46, 51 AND 52).
DEZMONA MIZELLE, EXAMINING ATTORNEY

CLASS 5—(Continued).

SN 78-863,685. SHIRE HUMAN GENETIC THERAPIES, INC.,
BOSTON, MA. FILED 4-18-2006.

IROSETE

THE MARK CONSISTS OF STANDARD CHARACTERS
WITHOUT CLAIM TO ANY PARTICULAR FONT, STYLE,
SIZE, OR COLOR.

FOR PHARMACEUTICAL PREPARATIONS FOR THE
TREATMENT OF ENZYME DEFICIENCIES; PHARMA-
CEUTICAL PREPARATIONS FOR THE TREATMENT OF
METABOLIC DISORDERS; PHARMACEUTICAL PRE-
PARATIONS FOR THE TREATMENT OF HUNTER'S
SYNDROME (U.S. CLS. 6, 18, 44, 46, 51 AND 52).
DEZMONA MIZELLE, EXAMINING ATTORNEY

SN 78-863,712. WALCO INTERNATIONAL, INC., WES-
TLAKE, TX. FILED 4-18-2006.

LAST FLIGHT

THE MARK CONSISTS OF STANDARD CHARACTERS
WITHOUT CLAIM TO ANY PARTICULAR FONT, STYLE,
SIZE, OR COLOR.

FOR FLY REPELLENT FOR EQUINES (U.S. CLS. 6, 18,
44, 46, 51 AND 52).
SAMUEL E. SHARPER JR., EXAMINING ATTORNEY

SN 78-863,884. ABBOTT LABORATORIES, ABBOTT PARK,
IL. FILED 4-18-2006.

ASSURA

THE MARK CONSISTS OF STANDARD CHARACTERS
WITHOUT CLAIM TO ANY PARTICULAR FONT, STYLE,
SIZE, OR COLOR.

FOR NUTRITIONAL SUPPLEMENTS (U.S. CLS. 6, 18,
44, 46, 51 AND 52).
TINA BROWN, EXAMINING ATTORNEY

CLASS 5—(Continued).

SN 78-863,899. ABBOTT LABORATORIES, ABBOTT PARK,
IL. FILED 4-18-2006.

STEADY CONTROL

THE MARK CONSISTS OF STANDARD CHARACTERS
WITHOUT CLAIM TO ANY PARTICULAR FONT, STYLE,
SIZE, OR COLOR.

FOR NUTRITIONAL SUPPLEMENT (U.S. CLS. 6, 18,
44, 46, 51 AND 52).
TINA BROWN, EXAMINING ATTORNEY

SN 78-863,912. INO THERAPEUTICS, LLC, CLINTON, NJ.
FILED 4-18-2006.

COVOX

THE MARK CONSISTS OF STANDARD CHARACTERS
WITHOUT CLAIM TO ANY PARTICULAR FONT, STYLE,
SIZE, OR COLOR.

FOR PHARMACEUTICAL PREPARATION, NAMELY,
CARBON MONOXIDE FOR INHALATION (U.S. CLS. 6,
18, 44, 46, 51 AND 52).

SONYA STEPHENS, EXAMINING ATTORNEY

SN 78-863,924. COLEY PHARMACEUTICAL GROUP, INC.,
WELLESLEY, MA. FILED 4-18-2006.

ACTILON

THE MARK CONSISTS OF STANDARD CHARACTERS
WITHOUT CLAIM TO ANY PARTICULAR FONT, STYLE,
SIZE, OR COLOR.

FOR PHARMACEUTICAL PREPARATIONS FOR THE
TREATMENT OF CANCER, HEPATITIS C, AND OTHER
INFECTIOUS DISEASES, NAMELY, PARASITIC, FUN-
GAL, VIRAL AND BACTERIAL INFECTIOUS DISEASES
(U.S. CLS. 6, 18, 44, 46, 51 AND 52).

FIRST USE 4-26-2005; IN COMMERCE 4-26-2005.
CHRISTOPHER BUONGIORNO, EXAMINING ATTOR-
NEY

CLASS 5—(Continued).

SN 78-864,378. SCHERING CORPORATION, KENILWORTH, NJ. FILED 4-19-2006.

Coricidin HBP

OWNER OF U.S. REG. NOS. 533,777, 1,002,530 AND 2,202,268.

NO CLAIM IS MADE TO THE EXCLUSIVE RIGHT TO USE "HBP", APART FROM THE MARK AS SHOWN.

FOR ANTIHISTAMINE, ANTITUSSIVE, ANALGESIC AND ANTIPYRETIC PREPARATIONS (U.S. CLS. 6, 18, 44, 46, 51 AND 52).

AMY MCMENAMIN, EXAMINING ATTORNEY

CLASS 5—(Continued).

SN 78-864,851. KREMER, REINER G., FRANKTOWN, CO. FILED 4-19-2006.

NATURE'S DOCTORS

THE MARK CONSISTS OF STANDARD CHARACTERS WITHOUT CLAIM TO ANY PARTICULAR FONT, STYLE, SIZE, OR COLOR.

FOR DIETARY FOOD SUPPLEMENTS; HERBAL SUPPLEMENTS; MINERAL SUPPLEMENTS; VITAMINS (U.S. CLS. 6, 18, 44, 46, 51 AND 52).

FIRST USE 4-16-2006; IN COMMERCE 4-16-2006.

MARTHA SANTOMARTINO, EXAMINING ATTORNEY

SN 78-864,426. ALCON MANUFACTURING, LTD., FORT WORTH, TX. FILED 4-19-2006.

PROFENAL

THE MARK CONSISTS OF STANDARD CHARACTERS WITHOUT CLAIM TO ANY PARTICULAR FONT, STYLE, SIZE, OR COLOR.

OWNER OF U.S. REG. NO. 1,437,694.

FOR OPHTHALMIC PHARMACEUTICAL PREPARATIONS FOR THE TREATMENT OF INFLAMMATION (U.S. CLS. 6, 18, 44, 46, 51 AND 52).

JOHN KELLY, EXAMINING ATTORNEY

SN 78-865,476. CARMEL DIAGNOSTICS, NAPLES, FL. FILED 4-20-2006.

F.Y.I.

THE MARK CONSISTS OF STANDARD CHARACTERS WITHOUT CLAIM TO ANY PARTICULAR FONT, STYLE, SIZE, OR COLOR.

FOR DIAGNOSTIC PREPARATIONS FOR MEDICAL AND VETERINARY USE; DIAGNOSTIC REAGENTS FOR CLINICAL OR MEDICAL LABORATORY USE; MEDICAL DIAGNOSTIC REAGENTS AND ASSAYS FOR TESTING OF BODY FLUIDS; PREGNANCY TEST KITS FOR HOME USE (U.S. CLS. 6, 18, 44, 46, 51 AND 52).

BARBARA GAYNOR, EXAMINING ATTORNEY

SN 78-864,621. QUANTUM, INC., EUGENE, OR. FILED 4-19-2006.

QUANTUM DERMA

THE MARK CONSISTS OF STANDARD CHARACTERS WITHOUT CLAIM TO ANY PARTICULAR FONT, STYLE, SIZE, OR COLOR.

OWNER OF U.S. REG. NOS. 1,929,540 AND 3,115,631.

NO CLAIM IS MADE TO THE EXCLUSIVE RIGHT TO USE "DERMA", APART FROM THE MARK AS SHOWN.

FOR HERB CONTAINING SKIN CARE TREATMENTS, NAMELY, OINTMENTS FOR TREATING BURNS AND CUTS, CREAMS FOR TREATING SCARS AND STRETCH MARKS, CREAMS FOR TREATING CRACKED SKIN AND MASK FORMING CREAMS FOR TREATING ATHLETE'S FOOT (U.S. CLS. 6, 18, 44, 46, 51 AND 52).

FIRST USE 11-30-2005; IN COMMERCE 11-30-2005.

DOMINIC FATHY, EXAMINING ATTORNEY

SN 78-865,698. KRAMER, JOSEPH, COPIAGUE, NY. FILED 4-20-2006.

TEST-UP

THE MARK CONSISTS OF STANDARD CHARACTERS WITHOUT CLAIM TO ANY PARTICULAR FONT, STYLE, SIZE, OR COLOR.

FOR DIETARY SUPPLEMENTS, NUTRITIONAL SUPPLEMENTS, NUTRITIONAL FOOD SUPPLEMENTS AND BEVERAGES (U.S. CLS. 6, 18, 44, 46, 51 AND 52).

FIRST USE 3-2-2006; IN COMMERCE 3-2-2006.

CAROLINE WEIMER, EXAMINING ATTORNEY

CLASS 5—(Continued).

SN 78-865,718. KRAMER, JOSEPH, COPIAGUE, NY. FILED 4-20-2006.

PRO-FIT

THE MARK CONSISTS OF STANDARD CHARACTERS WITHOUT CLAIM TO ANY PARTICULAR FONT, STYLE, SIZE, OR COLOR.

FOR DIETARY SUPPLEMENTS, NUTRITIONAL SUPPLEMENTS, NUTRITIONAL FOOD SUPPLEMENTS AND BEVERAGES (U.S. CLS. 6, 18, 44, 46, 51 AND 52).

FIRST USE 3-2-2006; IN COMMERCE 3-2-2006.
CAROLINE WEIMER, EXAMINING ATTORNEY

SN 78-865,720. QUANTUM, INC., EUGENE, OR. FILED 4-20-2006.

BUZZ AWAY EXTREME

THE MARK CONSISTS OF STANDARD CHARACTERS WITHOUT CLAIM TO ANY PARTICULAR FONT, STYLE, SIZE, OR COLOR.

OWNER OF U.S. REG. NO. 1,929,540.
FOR INSECT REPELLENT (U.S. CLS. 6, 18, 44, 46, 51 AND 52).

FIRST USE 4-11-2006; IN COMMERCE 4-11-2006.
DOMINIC FATHY, EXAMINING ATTORNEY

SN 78-866,023. ROMO HERMANAS, S.A. DE C.V., C.P.11509, MEXICO D.F., MEXICO, FILED 4-20-2006.

BLUBOOST

THE MARK CONSISTS OF STANDARD CHARACTERS WITHOUT CLAIM TO ANY PARTICULAR FONT, STYLE, SIZE, OR COLOR.

FOR NUTRITIONALLY FORTIFIED BEVERAGES (U.S. CLS. 6, 18, 44, 46, 51 AND 52).

GINA HAYES, EXAMINING ATTORNEY

CLASS 5—(Continued).

SN 78-866,827. TRANSCON TRADING CO., INC., IRMO, SC. FILED 4-21-2006.

VITA BUTE

THE MARK CONSISTS OF STANDARD CHARACTERS WITHOUT CLAIM TO ANY PARTICULAR FONT, STYLE, SIZE, OR COLOR.

FOR DIETARY SUPPLEMENTS FOR ANIMALS; NUTRITIONAL ADDITIVES FOR LIVESTOCK FEED FOR MEDICAL PURPOSES; NUTRITIONAL SUPPLEMENTS; VITAMIN SUPPLEMENTS (U.S. CLS. 6, 18, 44, 46, 51 AND 52).

FIRST USE 7-1-2004; IN COMMERCE 7-1-2004.
TINA L. SNAPP, EXAMINING ATTORNEY

SN 78-867,061. BLISTEX INC., OAK BROOK, IL. FILED 4-21-2006.

COOLING SPLASH

THE MARK CONSISTS OF STANDARD CHARACTERS WITHOUT CLAIM TO ANY PARTICULAR FONT, STYLE, SIZE, OR COLOR.

FOR MEDICATED TOPICAL PREPARATIONS FOR HUMAN USE FOR THE LIPS AND SKIN; MEDICATED TOPICAL PREPARATIONS FOR HUMAN USE TO PREVENT AND ALLEVIATE DRYNESS, BURNING, ITCHING AND COLD SORES, FOR MOISTURIZATION, AND FOR LIP AND SKIN CARE PROTECTION; MEDICATED LIP, HAND, BODY, AND FACE CREAMS, LOTIONS, GELS, BALMS AND/OR OINTMENTS; TOPICAL ANALGESIC PREPARATIONS; TOPICAL ANTIBIOTIC PREPARATIONS; AND MEDICATED SUNSCREEN PREPARATIONS (U.S. CLS. 6, 18, 44, 46, 51 AND 52).

JOHN LINCOSKI, EXAMINING ATTORNEY

CLASS 5—(Continued).

SN 78-867,064. BLISTEX INC., OAK BROOK, IL. FILED 4-21-2006.

COOL SPLASH

THE MARK CONSISTS OF STANDARD CHARACTERS WITHOUT CLAIM TO ANY PARTICULAR FONT, STYLE, SIZE, OR COLOR.

FOR MEDICATED TOPICAL PREPARATIONS FOR HUMAN USE FOR THE LIPS AND SKIN; MEDICATED TOPICAL PREPARATIONS FOR HUMAN USE TO PREVENT AND ALLEVIATE DRYNESS, BURNING, ITCHING AND COLD SORES, FOR MOISTURIZATION, AND FOR LIP AND SKIN CARE PROTECTION; MEDICATED LIP, HAND, BODY, AND FACE CREAMS, LOTIONS, GELS, BALMS AND/OR OINTMENTS; TOPICAL ANALGESIC PREPARATIONS; TOPICAL ANTIBIOTIC PREPARATIONS; AND MEDICATED SUNSCREEN PREPARATIONS (U.S. CLS. 6, 18, 44, 46, 51 AND 52).

JOHN LINCOSKI, EXAMINING ATTORNEY

SN 78-867,069. BLISTEX INC., OAK BROOK, IL. FILED 4-21-2006.

RELAXING SPLASH

THE MARK CONSISTS OF STANDARD CHARACTERS WITHOUT CLAIM TO ANY PARTICULAR FONT, STYLE, SIZE, OR COLOR.

FOR MEDICATED TOPICAL PREPARATIONS FOR HUMAN USE FOR THE LIPS AND SKIN; MEDICATED TOPICAL PREPARATIONS FOR HUMAN USE TO PREVENT AND ALLEVIATE DRYNESS, BURNING, ITCHING AND COLD SORES, FOR MOISTURIZATION, AND FOR LIP AND SKIN CARE PROTECTION; MEDICATED LIP, HAND, BODY, AND FACE CREAMS, LOTIONS, GELS, BALMS AND/OR OINTMENTS; TOPICAL ANALGESIC PREPARATIONS; TOPICAL ANTIBIOTIC PREPARATIONS; AND MEDICATED SUNSCREEN PREPARATIONS (U.S. CLS. 6, 18, 44, 46, 51 AND 52).

JOHN LINCOSKI, EXAMINING ATTORNEY

SN 78-867,690. RIDLEY BLOCK OPERATIONS, INC., MAN-KATO, MN. FILED 4-24-2006.

FLEX-AID

THE MARK CONSISTS OF STANDARD CHARACTERS WITHOUT CLAIM TO ANY PARTICULAR FONT, STYLE, SIZE, OR COLOR.

FOR ANIMAL FEED SUPPLEMENTS (U.S. CLS. 6, 18, 44, 46, 51 AND 52).

JAMES MACFARLANE, EXAMINING ATTORNEY

CLASS 5—(Continued).

SN 78-867,937. MOR-NUTECH, INC., WEST LAFAYETTE, IN. FILED 4-24-2006.

CAPSIVIROL-T

THE MARK CONSISTS OF STANDARD CHARACTERS WITHOUT CLAIM TO ANY PARTICULAR FONT, STYLE, SIZE, OR COLOR.

FOR NUTRITIONAL SUPPLEMENTS (U.S. CLS. 6, 18, 44, 46, 51 AND 52).

WENDY JUN, EXAMINING ATTORNEY

SN 78-867,959. MOR-NUTECH, INC., WEST LAFAYETTE, IN. FILED 4-24-2006.

VIROL-T

THE MARK CONSISTS OF STANDARD CHARACTERS WITHOUT CLAIM TO ANY PARTICULAR FONT, STYLE, SIZE, OR COLOR.

FOR NUTRITIONAL SUPPLEMENTS (U.S. CLS. 6, 18, 44, 46, 51 AND 52).

WENDY JUN, EXAMINING ATTORNEY

SN 78-868,275. ST. PAUL PHARMACEUTICALS, INC., GARDEN GROVE, CA. FILED 4-24-2006.

AsperDrink

THE MARK CONSISTS OF STANDARD CHARACTERS WITHOUT CLAIM TO ANY PARTICULAR FONT, STYLE, SIZE, OR COLOR.

FOR ASPIRIN (U.S. CLS. 6, 18, 44, 46, 51 AND 52).

CHARLES L. JENKINS, EXAMINING ATTORNEY

CLASS 5—(Continued).

SN 78-868,278. ST. PAUL PHARMACEUTICALS, INC., GARDEN GROVE, CA. FILED 4-24-2006.

AcetaDrink

THE MARK CONSISTS OF STANDARD CHARACTERS WITHOUT CLAIM TO ANY PARTICULAR FONT, STYLE, SIZE, OR COLOR.
FOR PHARMACEUTICAL PREPARATIONS, NAMELY, ACETAMINOPHEN (U.S. CLS. 6, 18, 44, 46, 51 AND 52).
CHARLES L. JENKINS, EXAMINING ATTORNEY

SN 78-868,311. NATIONAL BIOSCIENCE CORPORATION, CHESTER, NY. FILED 4-24-2006.

Xanthigen

THE MARK CONSISTS OF STANDARD CHARACTERS WITHOUT CLAIM TO ANY PARTICULAR FONT, STYLE, SIZE, OR COLOR.
FOR DIETARY SUPPLEMENTS (U.S. CLS. 6, 18, 44, 46, 51 AND 52).
ROBIN CHOSID, EXAMINING ATTORNEY

SN 78-868,473. BHELLIOM ENTERPRISES CORP, BOCA RATON, FL. FILED 4-24-2006.

**PLEASURE PILL ULTIMATE
SEXUAL ENHANCER**

THE MARK CONSISTS OF STANDARD CHARACTERS WITHOUT CLAIM TO ANY PARTICULAR FONT, STYLE, SIZE, OR COLOR.
NO CLAIM IS MADE TO THE EXCLUSIVE RIGHT TO USE "PILL" AND "ULTIMATE SEXUAL ENHANCER", APART FROM THE MARK AS SHOWN.
FOR DIETARY AND NUTRITIONAL SUPPLEMENTS (U.S. CLS. 6, 18, 44, 46, 51 AND 52).
FIRST USE 2-1-2003; IN COMMERCE 5-1-2003.
KAELIE KUNG, EXAMINING ATTORNEY

CLASS 5—(Continued).

SN 78-868,712. TRANSCON TRADING CO., INC., IRMO, SC. FILED 4-25-2006.



THE MARK CONSISTS OF A GRAPHIC DEPICTION OF A HORSE HEAD.
FOR DIETARY SUPPLEMENTS FOR ANIMALS; NUTRITIONAL ADDITIVES FOR LIVESTOCK FEED FOR MEDICAL PURPOSES; NUTRITIONAL SUPPLEMENTS; VITAMIN SUPPLEMENTS (U.S. CLS. 6, 18, 44, 46, 51 AND 52).
FIRST USE 4-1-2004; IN COMMERCE 4-1-2004.
TINA L. SNAPP, EXAMINING ATTORNEY

SN 78-868,718. WHITMIRE MICRO-GEN RESEARCH LABORATORIES, INC., ST. LOUIS, MO. FILED 4-25-2006.

INSPECTOR

THE MARK CONSISTS OF STANDARD CHARACTERS WITHOUT CLAIM TO ANY PARTICULAR FONT, STYLE, SIZE, OR COLOR.
FOR INSECTICIDES FOR THE STRUCTURAL PEST CONTROL MARKET (U.S. CLS. 6, 18, 44, 46, 51 AND 52).
CHERYL CLAYTON, EXAMINING ATTORNEY

SN 78-868,867. MOUNTAIN PEAK NUTRITIONALS, LLC, PORTLAND, OR. FILED 4-25-2006.

MOUNTAIN PEAK NUTRITIONALS

THE MARK CONSISTS OF STANDARD CHARACTERS WITHOUT CLAIM TO ANY PARTICULAR FONT, STYLE, SIZE, OR COLOR.
NO CLAIM IS MADE TO THE EXCLUSIVE RIGHT TO USE NUTRITIONALS, APART FROM THE MARK AS SHOWN.
FOR DIETARY AND NUTRITIONAL SUPPLEMENTS (U.S. CLS. 6, 18, 44, 46, 51 AND 52).
FIRST USE 8-1-1996; IN COMMERCE 10-1-1996.
JOHN HWANG, EXAMINING ATTORNEY

CLASS 5—(Continued).

SN 78-869,409. GRÜNENTHAL GMBH, 52078 AACHEN, FED REP GERMANY, FILED 4-25-2006.

ZENTIRA

THE MARK CONSISTS OF STANDARD CHARACTERS WITHOUT CLAIM TO ANY PARTICULAR FONT, STYLE, SIZE, OR COLOR.

PRIORITY CLAIMED UNDER SEC. 44(D) ON FED REP GERMANY APPLICATION NO. 30619092.3, FILED 3-24-2006, REG. NO. 30619092, DATED 6-12-2006, EXPIRES 3-31-2016.

FOR PHARMACEUTICAL PREPARATIONS, NAMELY ANALGESICS FOR HUMAN USE (U.S. CLS. 6, 18, 44, 46, 51 AND 52).

JOHN SCHUYLER YARD, EXAMINING ATTORNEY

CLASS 5—(Continued).

SN 78-869,515. DEFENSE NUTRITION, LLC, WOODLAND HILLS, CA. FILED 4-25-2006.

DEFENSE NUTRITION

THE MARK CONSISTS OF STANDARD CHARACTERS WITHOUT CLAIM TO ANY PARTICULAR FONT, STYLE, SIZE, OR COLOR.

NO CLAIM IS MADE TO THE EXCLUSIVE RIGHT TO USE "NUTRITION", APART FROM THE MARK AS SHOWN.

FOR NUTRITIONAL SUPPLEMENTS (U.S. CLS. 6, 18, 44, 46, 51 AND 52).

DAVID YONTEF, EXAMINING ATTORNEY

SN 78-869,434. BIOMARIN PHARMACEUTICAL INC., NOVATO, CA. FILED 4-25-2006.

KUVAN

THE MARK CONSISTS OF STANDARD CHARACTERS WITHOUT CLAIM TO ANY PARTICULAR FONT, STYLE, SIZE, OR COLOR.

FOR PHARMACEUTICAL PREPARATIONS, NAMELY PHARMACEUTICALS COMPRISING TETRAHYDROBIOPTERIN (BH4) AND RELATED COMPOUNDS FOR TREATMENT OF PHENYLKETONURIA (U.S. CLS. 6, 18, 44, 46, 51 AND 52).

KATHERINE E. HALMEN, EXAMINING ATTORNEY

SN 78-869,586. VAN DUZER, BETH A., MOUNTAIN VIEW, CA. FILED 4-26-2006.

Knotty Rub

THE MARK CONSISTS OF STANDARD CHARACTERS WITHOUT CLAIM TO ANY PARTICULAR FONT, STYLE, SIZE, OR COLOR.

FOR TOPICAL ANALGESICS (U.S. CLS. 6, 18, 44, 46, 51 AND 52).

FIRST USE 6-15-2005; IN COMMERCE 1-1-2006.

DAVID COLLIER, EXAMINING ATTORNEY

SN 78-869,446. BIOMARIN PHARMACEUTICAL INC., NOVATO, CA. FILED 4-25-2006.

ZENIDA

THE MARK CONSISTS OF STANDARD CHARACTERS WITHOUT CLAIM TO ANY PARTICULAR FONT, STYLE, SIZE, OR COLOR.

FOR PHARMACEUTICAL PREPARATIONS, NAMELY PHARMACEUTICALS COMPRISING TETRAHYDROBIOPTERIN (BH4) AND RELATED COMPOUNDS FOR TREATMENT OF PHENYLKETONURIA (U.S. CLS. 6, 18, 44, 46, 51 AND 52).

KATHERINE E. HALMEN, EXAMINING ATTORNEY

SN 78-869,753. ARBONNE INTERNATIONAL, LLC, IRVINE, CA. FILED 4-26-2006.

ARBONNE MEN'S GENDER SPECIFIC BLEND

THE MARK CONSISTS OF STANDARD CHARACTERS WITHOUT CLAIM TO ANY PARTICULAR FONT, STYLE, SIZE, OR COLOR.

OWNER OF U.S. REG. NOS. 1,770,981, 2,096,008 AND OTHERS.

NO CLAIM IS MADE TO THE EXCLUSIVE RIGHT TO USE MEN'S GENDER SPECIFIC BLEND, APART FROM THE MARK AS SHOWN.

FOR HERBAL SUPPLEMENTS (U.S. CLS. 6, 18, 44, 46, 51 AND 52).

FIRST USE 4-20-2006; IN COMMERCE 4-20-2006.

KATHERINE STOIDES, EXAMINING ATTORNEY

CLASS 5—(Continued).

SN 78-869,781. ARBONNE INTERNATIONAL, LLC, IRVINE, CA. FILED 4-26-2006.

ARBONNE WOMEN'S GENDER SPECIFIC BLEND

THE MARK CONSISTS OF STANDARD CHARACTERS WITHOUT CLAIM TO ANY PARTICULAR FONT, STYLE, SIZE, OR COLOR.

OWNER OF U.S. REG. NOS. 1,770,981, 2,096,008 AND OTHERS.

NO CLAIM IS MADE TO THE EXCLUSIVE RIGHT TO USE WOMEN'S GENDER SPECIFIC BLEND, APART FROM THE MARK AS SHOWN.

FOR FOOD SUPPLEMENTS; HERBAL SUPPLEMENTS (U.S. CLS. 6, 18, 44, 46, 51 AND 52).

FIRST USE 4-20-2006; IN COMMERCE 4-20-2006.
KATHERINE STOIDES, EXAMINING ATTORNEY

CLASS 5—(Continued).

SN 78-870,137. PURDUE PRODUCTS L.P., STAMFORD, CT. FILED 4-26-2006.

RIGHTSTYLE

THE MARK CONSISTS OF STANDARD CHARACTERS WITHOUT CLAIM TO ANY PARTICULAR FONT, STYLE, SIZE, OR COLOR.

FOR DIETARY SUPPLEMENTS (U.S. CLS. 6, 18, 44, 46, 51 AND 52).

SHARI SHEFFIELD, EXAMINING ATTORNEY

SN 78-869,881. KMCH NATURAL FOODS, INC., ALGONQUIN, IL. FILED 4-26-2006.

MOTHER'S CUPBOARD

THE MARK CONSISTS OF STANDARD CHARACTERS WITHOUT CLAIM TO ANY PARTICULAR FONT, STYLE, SIZE, OR COLOR.

FOR BABY AND INFANT FOOD (U.S. CLS. 6, 18, 44, 46, 51 AND 52).

LINDA ESTRADA, EXAMINING ATTORNEY

SN 78-870,264. THE PROCTER & GAMBLE COMPANY, CINCINNATI, OH. FILED 4-26-2006.

SPRAY ON, FRESHNESS LOVERS, SPRAY

THE MARK CONSISTS OF STANDARD CHARACTERS WITHOUT CLAIM TO ANY PARTICULAR FONT, STYLE, SIZE, OR COLOR.

FOR DEODORIZERS FOR FABRICS, UPHOLSTERY AND CARPETS; AIR FRESHENERS (U.S. CLS. 6, 18, 44, 46, 51 AND 52).

JOHN SCHUYLER YARD, EXAMINING ATTORNEY

SN 78-870,134. PURDUE PRODUCTS L.P., STAMFORD, CT. FILED 4-26-2006.

FULLCARE

THE MARK CONSISTS OF STANDARD CHARACTERS WITHOUT CLAIM TO ANY PARTICULAR FONT, STYLE, SIZE, OR COLOR.

FOR DIETARY SUPPLEMENTS (U.S. CLS. 6, 18, 44, 46, 51 AND 52).

SHARI SHEFFIELD, EXAMINING ATTORNEY

SN 78-870,990. CUNNINGHAM, ERIC L, CHARLOTTE, NC. FILED 4-27-2006.

Munchie Mist

THE MARK CONSISTS OF STANDARD CHARACTERS WITHOUT CLAIM TO ANY PARTICULAR FONT, STYLE, SIZE, OR COLOR.

FOR AIR FRESHENER (U.S. CLS. 6, 18, 44, 46, 51 AND 52).

DAVID COLLIER, EXAMINING ATTORNEY

CLASS 5—(Continued).

SN 78-871,468. MISSION PHARMACAL COMPANY, SAN ANTONIO, TX. FILED 4-27-2006.

CLASS 5—(Continued).

SN 78-872,310. PURDUE PRODUCTS L.P., STAMFORD, CT. FILED 4-28-2006.

EVERY AGE EVERY GENERATION

BETASOFT

THE MARK CONSISTS OF STANDARD CHARACTERS WITHOUT CLAIM TO ANY PARTICULAR FONT, STYLE, SIZE, OR COLOR.
FOR DIETARY SUPPLEMENTS INCLUSIVE OF CALCIUM SALT (U.S. CLS. 6, 18, 44, 46, 51 AND 52).
JEAN IM, EXAMINING ATTORNEY

THE MARK CONSISTS OF STANDARD CHARACTERS WITHOUT CLAIM TO ANY PARTICULAR FONT, STYLE, SIZE, OR COLOR.
FOR ANTISEPTIC PREPARATIONS; GERMICIDES (U.S. CLS. 6, 18, 44, 46, 51 AND 52).
SHARI SHEFFIELD, EXAMINING ATTORNEY

SN 78-872,262. TANGO ADVANCED NUTRITION, INC., SAN FRANCISCO, CA. FILED 4-28-2006.

SN 78-872,405. GRÜNENTHAL GMBH, 52078 AACHEN, FED REP GERMANY, FILED 4-28-2006.

METAPHASE

SENTROS

THE MARK CONSISTS OF STANDARD CHARACTERS WITHOUT CLAIM TO ANY PARTICULAR FONT, STYLE, SIZE, OR COLOR.
FOR DIETARY, HERBAL AND NUTRITIONAL SUPPLEMENTS (U.S. CLS. 6, 18, 44, 46, 51 AND 52).
FIRST USE 1-24-2006; IN COMMERCE 1-24-2006.
WILLIAM P. SHANAHAN, EXAMINING ATTORNEY

THE MARK CONSISTS OF STANDARD CHARACTERS WITHOUT CLAIM TO ANY PARTICULAR FONT, STYLE, SIZE, OR COLOR.
FOR ANALGESICS FOR HUMAN USE, EXCLUDING TRANQUILIZERS (U.S. CLS. 6, 18, 44, 46, 51 AND 52).
JOHN SCHUYLER YARD, EXAMINING ATTORNEY

SN 78-872,305. PURDUE PRODUCTS L.P., STAMFORD, CT. FILED 4-28-2006.

SN 78-872,423. GRÜNENTHAL GMBH, 52078 AACHEN, FED REP GERMANY, FILED 4-28-2006.

BETAPREP

SENTRIA

THE MARK CONSISTS OF STANDARD CHARACTERS WITHOUT CLAIM TO ANY PARTICULAR FONT, STYLE, SIZE, OR COLOR.
FOR ANTISEPTIC PREPARATIONS; GERMICIDES (U.S. CLS. 6, 18, 44, 46, 51 AND 52).
SHARI SHEFFIELD, EXAMINING ATTORNEY

THE MARK CONSISTS OF STANDARD CHARACTERS WITHOUT CLAIM TO ANY PARTICULAR FONT, STYLE, SIZE, OR COLOR.
FOR ANALGESICS FOR HUMAN USE, EXCLUDING TRANQUILIZERS (U.S. CLS. 6, 18, 44, 46, 51 AND 52).
JOHN SCHUYLER YARD, EXAMINING ATTORNEY

CLASS 5—(Continued).

SN 78-872,485. HOSPIRA, INC., LAKE FOREST, IL. FILED 4-28-2006.

VISIV

THE MARK CONSISTS OF STANDARD CHARACTERS WITHOUT CLAIM TO ANY PARTICULAR FONT, STYLE, SIZE, OR COLOR.

FOR INTRAVENOUS BAGS SOLD FILLED WITH INJECTABLE PHARMACEUTICAL PREPARATIONS, NAMELY ANESTHETICS, CONTRAST AGENTS FOR ULTRASOUND, CT, AND MRI DIAGNOSTIC IMAGING PROCEDURES, SEDATIVES, ANTI-INFECTIVES, CARDIOVASCULAR PHARMACEUTICALS, AND ANTI-EMETICS, AND DILUENTS FOR MEDICAL PURPOSES (U.S. CLS. 6, 18, 44, 46, 51 AND 52).

CARRIE ACHEN, EXAMINING ATTORNEY

SN 78-872,644. HOSPIRA, INC., LAKE FOREST, IL. FILED 4-28-2006.

IPUSH

THE MARK CONSISTS OF STANDARD CHARACTERS WITHOUT CLAIM TO ANY PARTICULAR FONT, STYLE, SIZE, OR COLOR.

FOR PRE-FILLED SYRINGES SOLD FILLED WITH PHARMACEUTICAL PREPARATIONS, NAMELY ANESTHETICS, CONTRAST AGENTS FOR ULTRASOUND, CT, AND MRI DIAGNOSTIC IMAGING PROCEDURES, SEDATIVES, ANTI-INFECTIVES, CARDIOVASCULAR PHARMACEUTICALS, AND ANTI-EMETICS, AND DILUENTS (U.S. CLS. 6, 18, 44, 46, 51 AND 52).

CARRIE ACHEN, EXAMINING ATTORNEY

SN 78-872,809. THOUGHT, LLC, PASO ROBLES, CA. FILED 4-29-2006.

Thought - a source of hope

THE MARK CONSISTS OF STANDARD CHARACTERS WITHOUT CLAIM TO ANY PARTICULAR FONT, STYLE, SIZE, OR COLOR.

FOR DIETARY AND NUTRITIONAL SUPPLEMENTS; DIETARY FOOD SUPPLEMENTS; DIETARY SUPPLEMENTS; DIETARY SUPPLEMENTS FOR HUMAN CONSUMPTION; FOOD SUPPLEMENTS (U.S. CLS. 6, 18, 44, 46, 51 AND 52).

FIRST USE 8-5-2005; IN COMMERCE 12-6-2005.

HOWARD B. LEVINE, EXAMINING ATTORNEY

CLASS 5—(Continued).

SN 78-872,875. GROWMAX INVESTMENTS LIMITED, ROAD TOWN, BR.VIRGIN ISLANDS, FILED 4-29-2006.

ORAFIX

THE MARK CONSISTS OF STANDARD CHARACTERS WITHOUT CLAIM TO ANY PARTICULAR FONT, STYLE, SIZE, OR COLOR.

FOR DENTAL WAXES; DENTURE ADHESIVES; EMBEDDING MATERIAL FOR DENTAL AND DENTAL TECHNICAL PURPOSES; FISSURE SEALANT FOR DENTAL AND DENTAL TECHNICAL PURPOSES; FIXING MATERIALS FOR DENTAL PURPOSES; MATERIAL FOR REPAIRING TEETH AND FOR DENTAL CROWNS AND BRIDGES; MATERIAL FOR TOOTH CROWNS AND TOOTH BRIDGES FOR DENTAL AND DENTAL TECHNICAL PURPOSES; MATERIALS FOR DENTAL FILLINGS AND FOR SEALING PURPOSES; MATERIALS FOR MAKING DENTAL IMPRESSIONS; MEDICATED DENTAL FLOSS; SEALING AGENTS FOR DENTAL PURPOSES (U.S. CLS. 6, 18, 44, 46, 51 AND 52).

FIRST USE 3-22-2006; IN COMMERCE 3-22-2006.
BARNEY CHARLON, EXAMINING ATTORNEY

SN 78-874,222. THE PROCTER & GAMBLE COMPANY, CINCINNATI, OH. FILED 5-2-2006.

IT'S JUST WHAT YOU'VE BEEN MISSING

THE MARK CONSISTS OF STANDARD CHARACTERS WITHOUT CLAIM TO ANY PARTICULAR FONT, STYLE, SIZE, OR COLOR.

FOR DIETARY AND NUTRITIONAL SUPPLEMENTS (U.S. CLS. 6, 18, 44, 46, 51 AND 52).

JOHN SCHUYLER YARD, EXAMINING ATTORNEY

SN 78-874,628. GRÜNENTHAL GMBH, 52078 AACHEN, FED REP GERMANY, FILED 5-2-2006.

APACS

THE MARK CONSISTS OF STANDARD CHARACTERS WITHOUT CLAIM TO ANY PARTICULAR FONT, STYLE, SIZE, OR COLOR.

PRIORITY CLAIMED UNDER SEC. 44(D) ON FED REP GERMANY APPLICATION NO. 30601220.0, FILED 1-9-2006, REG. NO. 30601220, DATED 5-4-2006, EXPIRES 1-31-2016.

FOR PHARMACEUTICAL PREPARATIONS FOR HUMAN USE, NAMELY ANTI-INFECTIVES, ANALGESICS, AND HORMONAL PREPARATIONS, EXCLUDING PREPARATIONS FOR THE TREATMENT OF GASTROINTESTINAL DISEASES (U.S. CLS. 6, 18, 44, 46, 51 AND 52).

JOHN SCHUYLER YARD, EXAMINING ATTORNEY

CLASS 5—(Continued).

SN 78-875,730. MERCK & CO., INC., WHITEHOUSE STATION, NJ. FILED 5-3-2006.

EMIVEND

THE MARK CONSISTS OF STANDARD CHARACTERS WITHOUT CLAIM TO ANY PARTICULAR FONT, STYLE, SIZE, OR COLOR.
FOR ANTIEMETIC PREPARATIONS (U.S. CLS. 6, 18, 44, 46, 51 AND 52).
JEFF DEFORD, EXAMINING ATTORNEY

SN 78-877,599. MERCK & CO., INC., WHITEHOUSE STATION, NJ. FILED 5-5-2006.

CLASS 5—(Continued).

SN 78-878,080. BLUE CALIFORNIA CO., RANCHO SANTA MARGARITA, CA. FILED 5-5-2006.

GinkgoPure

THE MARK CONSISTS OF STANDARD CHARACTERS WITHOUT CLAIM TO ANY PARTICULAR FONT, STYLE, SIZE, OR COLOR.
FOR DIETARY AND NUTRITIONAL SUPPLEMENTS (U.S. CLS. 6, 18, 44, 46, 51 AND 52).
WENDY GOODMAN, EXAMINING ATTORNEY

SN 78-881,205. RISE ABOVE NUTRITION, INC., WILLOW-BROOK, IL. FILED 5-11-2006.

Rise Above 150 x 40

ZOSTAVAX

OWNER OF U.S. REG. NO. 3,042,193.
THE MARK CONSISTS OF ZOSTAVAX WITH A STYLIZED "V".
FOR HUMAN VACCINE PREPARATIONS (U.S. CLS. 6, 18, 44, 46, 51 AND 52).
JEFF DEFORD, EXAMINING ATTORNEY

THE MARK CONSISTS OF STANDARD CHARACTERS WITHOUT CLAIM TO ANY PARTICULAR FONT, STYLE, SIZE, OR COLOR.
FOR MINERAL NUTRITIONAL SUPPLEMENTS; MINERAL SUPPLEMENTS; MIXED VITAMIN PREPARATIONS; MULTI-VITAMIN PREPARATIONS; NUTRITIONAL ADDITIVES FOR USE IN FOODS AND DIETARY SUPPLEMENTS FOR HUMAN CONSUMPTION; NUTRITIONAL DRINK MIX FOR USE AS A MEAL REPLACEMENT; NUTRITIONAL SHAKES FOR USE AS A MEAL SUBSTITUTE; NUTRITIONAL SUPPLEMENTS; VITAMIN AND MINERAL FORMED AND PACKAGED AS BARS; VITAMIN AND MINERAL SUPPLEMENTS; VITAMIN B PREPARATIONS; VITAMIN C PREPARATIONS; VITAMIN D PREPARATIONS; VITAMIN DROPS; VITAMIN ENRICHED WATER; VITAMIN PREPARATIONS; VITAMIN SUPPLEMENTS; VITAMIN TABLETS; VITAMINS (U.S. CLS. 6, 18, 44, 46, 51 AND 52).
ATTIYA MALIK, EXAMINING ATTORNEY

SN 78-883,800. HEALTHSIMPLE TOOLS, LLC, MINNEAPOLIS, MN. FILED 5-15-2006.

SN 78-878,075. BLUE CALIFORNIA CO., RANCHO SANTA MARGARITA, CA. FILED 5-5-2006.

BilobaPure

THE MARK CONSISTS OF STANDARD CHARACTERS WITHOUT CLAIM TO ANY PARTICULAR FONT, STYLE, SIZE, OR COLOR.
FOR DIETARY AND NUTRITIONAL SUPPLEMENTS (U.S. CLS. 6, 18, 44, 46, 51 AND 52).
WENDY GOODMAN, EXAMINING ATTORNEY

HEALTHSIMPLE

THE MARK CONSISTS OF STANDARD CHARACTERS WITHOUT CLAIM TO ANY PARTICULAR FONT, STYLE, SIZE, OR COLOR.
FOR NUTRITIONAL AND DIETARY SUPPLEMENTS; VITAMIN, MINERAL AND NUTRIENT FORTIFIED DRINKS; VITAMIN, MINERAL AND NUTRIENT FORTIFIED DRINKS MIXES (U.S. CLS. 6, 18, 44, 46, 51 AND 52).
RUDY R. SINGLETON, EXAMINING ATTORNEY

CLASS 5—(Continued).

SN 78-885,080. NEXT PROTEINS, INC., CARLSBAD, CA.
FILED 5-16-2006.

MUSCLEshock

THE MARK CONSISTS OF STANDARD CHARACTERS
WITHOUT CLAIM TO ANY PARTICULAR FONT, STYLE,
SIZE, OR COLOR.

FOR DIETARY AND NUTRITIONAL SUPPLEMENTS,
NAMELY DRINK POWDER MIXES CONSISTING OF
PROTEIN AND PEPTIDES (U.S. CLS. 6, 18, 44, 46, 51
AND 52).

NICHOLAS ALTREE, EXAMINING ATTORNEY

CLASS 5—(Continued).

SN 78-896,385. OMS INVESTMENTS, INC., LOS ANGELES,
CA. FILED 5-30-2006.

WEED DEADLY, LAWN FRIENDLY

THE MARK CONSISTS OF STANDARD CHARACTERS
WITHOUT CLAIM TO ANY PARTICULAR FONT, STYLE,
SIZE, OR COLOR.

FOR HERBICIDES FOR DOMESTIC USE (U.S. CLS. 6,
18, 44, 46, 51 AND 52).

FIRST USE 12-1-2004; IN COMMERCE 12-1-2004.
COLLEEN KEARNEY, EXAMINING ATTORNEY

SN 78-885,768. HUNTLEY, DOUGLAS B., HENDERSON-
VILLE, NC. FILED 5-17-2006.

PROS-CARE

THE MARK CONSISTS OF STANDARD CHARACTERS
WITHOUT CLAIM TO ANY PARTICULAR FONT, STYLE,
SIZE, OR COLOR.

FOR NUTRITIONAL SUPPLEMENTS (U.S. CLS. 6, 18,
44, 46, 51 AND 52).

FIRST USE 2-1-2004; IN COMMERCE 2-1-2004.
ROBERT STRUCK, EXAMINING ATTORNEY

SN 78-886,133. TITAN NUTRITION, INC., DBA KOLOSEUM
NUTRITIONAL SCIENCES, BREA, CA. FILED 5-17-2006.

**KOLOSEUM NUTRITIONAL
SCIENCES**

THE MARK CONSISTS OF STANDARD CHARACTERS
WITHOUT CLAIM TO ANY PARTICULAR FONT, STYLE,
SIZE, OR COLOR.

NO CLAIM IS MADE TO THE EXCLUSIVE RIGHT TO
USE "NUTRITIONAL SCIENCES", APART FROM THE
MARK AS SHOWN.

THE ENGLISH TRANSLATION OF KOLOSEUM IS "CO-
LOSSEUM."

FOR NUTRITIONAL SUPPLEMENTS (U.S. CLS. 6, 18,
44, 46, 51 AND 52).

ALLISON SCHRODY, EXAMINING ATTORNEY

SN 78-898,038. OMS INVESTMENTS, INC., LOS ANGELES,
CA. FILED 6-1-2006.

DEER-B-GON

THE MARK CONSISTS OF STANDARD CHARACTERS
WITHOUT CLAIM TO ANY PARTICULAR FONT, STYLE,
SIZE, OR COLOR.

OWNER OF U.S. REG. NOS. 1,995,777, 2,646,066 AND
OTHERS.

FOR ANIMAL REPELLANT USED TO REPEL DEER
AND OTHER RUMINANT ANIMALS AND RABBITS
(U.S. CLS. 6, 18, 44, 46, 51 AND 52).

COLLEEN KEARNEY, EXAMINING ATTORNEY

SN 78-898,497. WHITMIRE MICRO-GEN RESEARCH LA-
BORATORIES, INC., ST. LOUIS, MO. FILED 6-1-2006.

FASTOUT

THE MARK CONSISTS OF STANDARD CHARACTERS
WITHOUT CLAIM TO ANY PARTICULAR FONT, STYLE,
SIZE, OR COLOR.

FOR INSECTICIDES FOR THE STRUCTURAL PEST
CONTROL MARKET (U.S. CLS. 6, 18, 44, 46, 51 AND 52).

CHERYL CLAYTON, EXAMINING ATTORNEY

CLASS 5—(Continued).

SN 78-899,574. PLATINUM PERFORMANCE INC., BUELLTON, CA. FILED 6-2-2006.

CLASS 5—(Continued).

SN 78-911,204. RIDLEY BLOCK OPERATIONS, INC., MAN-KATO, MN. FILED 6-19-2006.

EATING FOR THE FUTURE

**THE POWER OF CONTINUOUS
NUTRIENT AVAILABILITY**

THE MARK CONSISTS OF STANDARD CHARACTERS WITHOUT CLAIM TO ANY PARTICULAR FONT, STYLE, SIZE, OR COLOR.
FOR NUTRITIONAL SUPPLEMENTS (U.S. CLS. 6, 18, 44, 46, 51 AND 52).
TOBY BULLOFF, EXAMINING ATTORNEY

THE MARK CONSISTS OF STANDARD CHARACTERS WITHOUT CLAIM TO ANY PARTICULAR FONT, STYLE, SIZE, OR COLOR.
OWNER OF U.S. REG. NO. 2,015,863.
FOR ANIMAL FEED SUPPLEMENTS (U.S. CLS. 6, 18, 44, 46, 51 AND 52).
FIRST USE 6-29-2000; IN COMMERCE 6-29-2000.
JAMES MACFARLANE, EXAMINING ATTORNEY

SN 78-902,247. NEXT PROTEINS, INC., CARLBAD, CA. FILED 6-6-2006.

SN 78-914,004. SALUGEN, INC., SAN DIEGO, CA. FILED 6-22-2006.

JenksJuice

SWEET TOOTH GENE

THE MARK CONSISTS OF STANDARD CHARACTERS WITHOUT CLAIM TO ANY PARTICULAR FONT, STYLE, SIZE, OR COLOR.
FOR DIETARY AND NUTRITIONAL SUPPLEMENT, NAMELY POWDER DRINK MIXES AND LIQUID JUICE CONSISTING OF WHEY PROTEIN (U.S. CLS. 6, 18, 44, 46, 51 AND 52).
NICHOLAS ALTREE, EXAMINING ATTORNEY

THE MARK CONSISTS OF STANDARD CHARACTERS WITHOUT CLAIM TO ANY PARTICULAR FONT, STYLE, SIZE, OR COLOR.
FOR DIETARY SUPPLEMENTS (U.S. CLS. 6, 18, 44, 46, 51 AND 52).
MARIA-VICTORIA SUAREZ, EXAMINING ATTORNEY

SN 78-903,864. WALCO INTERNATIONAL, INC., WES- TLAKE, TX. FILED 6-8-2006.

SN 78-914,013. SALUGEN, INC., SAN DIEGO, CA. FILED 6-22-2006.

EQUI-SPONGE

NERVOUS EATING GENE

THE MARK CONSISTS OF STANDARD CHARACTERS WITHOUT CLAIM TO ANY PARTICULAR FONT, STYLE, SIZE, OR COLOR.
FOR NUTRITIONAL SUPPLEMENT AND FODDER ADDITIVES IN POWDER FORM INTENDED FOR THE ABSORPTION OF INTESTINAL TOXIN IN HORSES (U.S. CLS. 6, 18, 44, 46, 51 AND 52).
SAMUEL E. SHARPER JR., EXAMINING ATTORNEY

THE MARK CONSISTS OF STANDARD CHARACTERS WITHOUT CLAIM TO ANY PARTICULAR FONT, STYLE, SIZE, OR COLOR.
FOR DIETARY SUPPLEMENTS (U.S. CLS. 6, 18, 44, 46, 51 AND 52).
MARIA-VICTORIA SUAREZ, EXAMINING ATTORNEY

CLASS 5—(Continued).

SN 78-914,019. SALUGEN, INC., SAN DIEGO, CA. FILED 6-22-2006.

FAT REGULATOR GENE

THE MARK CONSISTS OF STANDARD CHARACTERS WITHOUT CLAIM TO ANY PARTICULAR FONT, STYLE, SIZE, OR COLOR.
FOR DIETARY SUPPLEMENTS (U.S. CLS. 6, 18, 44, 46, 51 AND 52).
MARIA-VICTORIA SUAREZ, EXAMINING ATTORNEY

SN 78-914,022. SALUGEN, INC., SAN DIEGO, CA. FILED 6-22-2006.

NEW CELL GENE

THE MARK CONSISTS OF STANDARD CHARACTERS WITHOUT CLAIM TO ANY PARTICULAR FONT, STYLE, SIZE, OR COLOR.
FOR DIETARY SUPPLEMENTS (U.S. CLS. 6, 18, 44, 46, 51 AND 52).
MARIA-VICTORIA SUAREZ, EXAMINING ATTORNEY

SN 78-914,023. SALUGEN, INC., SAN DIEGO, CA. FILED 6-22-2006.

OBESITY RISK GENE

THE MARK CONSISTS OF STANDARD CHARACTERS WITHOUT CLAIM TO ANY PARTICULAR FONT, STYLE, SIZE, OR COLOR.
FOR DIETARY SUPPLEMENTS (U.S. CLS. 6, 18, 44, 46, 51 AND 52).
MARIA-VICTORIA SUAREZ, EXAMINING ATTORNEY

CLASS 5—(Continued).

SN 78-915,941. MET- RX SUBSTRATE TECHNOLOGY, INC., BOHEMIA, NY. FILED 6-23-2006.

DEEP CUTS

THE MARK CONSISTS OF STANDARD CHARACTERS WITHOUT CLAIM TO ANY PARTICULAR FONT, STYLE, SIZE, OR COLOR.
FOR NUTRITIONAL SUPPLEMENTS IN THE FORM OF CAPSULES, TABLETS, AND DRINKS (U.S. CLS. 6, 18, 44, 46, 51 AND 52).
KATHERINE STOIDES, EXAMINING ATTORNEY

SN 78-924,575. OMS INVESTMENTS, INC., LOS ANGELES, CA. FILED 7-7-2006.

OH2

THE MARK CONSISTS OF STANDARD CHARACTERS WITHOUT CLAIM TO ANY PARTICULAR FONT, STYLE, SIZE, OR COLOR.
OWNER OF U.S. REG. NO. 2,239,674.
FOR HERBICIDES (U.S. CLS. 6, 18, 44, 46, 51 AND 52).
FIRST USE 4-8-1998; IN COMMERCE 4-8-1998.
KATRINA EDGE, EXAMINING ATTORNEY

SN 78-924,730. OMS INVESTMENTS, INC., LOS ANGELES, CA. FILED 7-7-2006.

ROUT

THE MARK CONSISTS OF STANDARD CHARACTERS WITHOUT CLAIM TO ANY PARTICULAR FONT, STYLE, SIZE, OR COLOR.
OWNER OF U.S. REG. NO. 1,774,886.
FOR HERBICIDES (U.S. CLS. 6, 18, 44, 46, 51 AND 52).
FIRST USE 10-10-1984; IN COMMERCE 10-10-1984.
KATRINA EDGE, EXAMINING ATTORNEY

CLASS 5—(Continued).

SN 78-924,742. OMS INVESTMENTS, INC., LOS ANGELES, CA. FILED 7-7-2006.

CORRAL

THE MARK CONSISTS OF STANDARD CHARACTERS WITHOUT CLAIM TO ANY PARTICULAR FONT, STYLE, SIZE, OR COLOR.

OWNER OF U.S. REG. NO. 2,438,242.
FOR HERBICIDES (U.S. CLS. 6, 18, 44, 46, 51 AND 52).
FIRST USE 2-1-1999; IN COMMERCE 2-1-1999.
KATRINA EDGE, EXAMINING ATTORNEY

CLASS 5—(Continued).

SN 78-955,031. HUNTLEY, DOUGLAS B., HENDERSONVILLE, NC. FILED 8-18-2006.

DAILY ADVANCE

THE MARK CONSISTS OF STANDARD CHARACTERS WITHOUT CLAIM TO ANY PARTICULAR FONT, STYLE, SIZE, OR COLOR.

NO CLAIM IS MADE TO THE EXCLUSIVE RIGHT TO USE "DAILY", APART FROM THE MARK AS SHOWN.
FOR VITAMIN AND MINERAL SUPPLEMENTS (U.S. CLS. 6, 18, 44, 46, 51 AND 52).
FIRST USE 3-1-2004; IN COMMERCE 3-1-2004.
ROBERT STRUCK, EXAMINING ATTORNEY

SN 78-933,631. MEAD JOHNSON & COMPANY, EVANSVILLE, IN. FILED 7-20-2006.

INCREDIJUICE

THE MARK CONSISTS OF STANDARD CHARACTERS WITHOUT CLAIM TO ANY PARTICULAR FONT, STYLE, SIZE, OR COLOR.

FOR NUTRITIONALLY ENHANCED FRUIT JUICE (U.S. CLS. 6, 18, 44, 46, 51 AND 52).
MATTHEW MCDOWELL, EXAMINING ATTORNEY

SN 78-968,715. GENERAL MARKS, INC., CLEARWATER, FL. FILED 9-7-2006.

PAIN CLEAR

SN 78-955,018. HUNTLEY, DOUGLAS B., HENDERSONVILLE, NC. FILED 8-18-2006.

GYN-AID

THE MARK CONSISTS OF STANDARD CHARACTERS WITHOUT CLAIM TO ANY PARTICULAR FONT, STYLE, SIZE, OR COLOR.

FOR NUTRITIONAL SUPPLEMENTS (U.S. CLS. 6, 18, 44, 46, 51 AND 52).
FIRST USE 3-1-2004; IN COMMERCE 3-1-2004.
ROBERT STRUCK, EXAMINING ATTORNEY

THE MARK CONSISTS OF STANDARD CHARACTERS WITHOUT CLAIM TO ANY PARTICULAR FONT, STYLE, SIZE, OR COLOR.

NO CLAIM IS MADE TO THE EXCLUSIVE RIGHT TO USE "PAIN", APART FROM THE MARK AS SHOWN.
FOR SPRAYS, GELS AND CREAMS THAT CONTAIN HERBS AND VITAMINS TO HELP RELIEVE PAIN (U.S. CLS. 6, 18, 44, 46, 51 AND 52).
FIRST USE 9-6-2006; IN COMMERCE 9-6-2006.
BARBARA GAYNOR, EXAMINING ATTORNEY

CLASS 5—(Continued).

SN 79-010,224. RICHTER & HOFFMANN HARVARD DENTAL GESELLSCHAFT MBH & CO. KG, 83209 PRIEN/CHIEMSEE, FED REP GERMANY, FILED 3-30-2005.

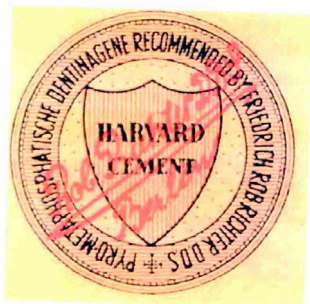

OWNER OF INTERNATIONAL REGISTRATION 0295572 DATED 3-29-1965, EXPIRES 3-29-2015.

NO CLAIM IS MADE TO THE EXCLUSIVE RIGHT TO USE "CEMENT", "RECOMMENDED BY", "PYRO-METAPHOSPHATISCHE DENTINAGENE" AND "BERLIN", APART FROM THE MARK AS SHOWN.

THE NAME "FRIEDRICH ROB RICHTER, D.D.S." DOES NOT IDENTIFY A LIVING INDIVIDUAL.

THE COLOR(S) BLACK, YELLOW AND RED IS/ARE CLAIMED AS A FEATURE OF THE MARK.

THE COLOR BLACK APPEARS AS THE OUTLINING FOR THE THREE CONCENTRIC CIRCLES, THE CREST, ALL OF THE WORDING EXCLUDING "ROB RICHTER D.D.S." AND "BERLIN", AND THE DECORATIVE LINES, DOTS AND BORDERS. THE COLOR YELLOW SERVES AS THE BACKGROUND FOR THE ENTIRE MARK AND THE COLOR RED APPEARS IN THE WORDING "ROB RICHTER D.D.S." AND "BERLIN", WHICH RUNS DIAGONALLY ACROSS THE CENTER OF THE MARK.

THE ENGLISH TRANSLATION OF PYRO-METAPHOSPHATISCHE DENTINAGENE IS PYRO-METAPHOSPHATIC DENTINE SUPPLEMENT.

FOR DENTAL CEMENT (U.S. CLS. 6, 18, 44, 46, 51 AND 52).

JULIE GUTTADAURO, EXAMINING ATTORNEY

SN 79-019,168. INTERVET INTERNATIONAL B.V., BOXMEER, NETHERLANDS, FILED 12-1-2005.

LEVENTA

THE MARK CONSISTS OF STANDARD CHARACTERS WITHOUT CLAIM TO ANY PARTICULAR FONT, STYLE, SIZE, OR COLOR.

PRIORITY DATE OF 9-14-2005 IS CLAIMED.

OWNER OF INTERNATIONAL REGISTRATION 0872043 DATED 12-1-2005, EXPIRES 12-1-2015.

FOR PHARMACEUTICAL PREPARATIONS FOR VETERINARY USE, NAMELY HORMONE PREPARATIONS FOR DOGS (U.S. CLS. 6, 18, 44, 46, 51 AND 52).

TINA BROWN, EXAMINING ATTORNEY

CLASS 5—(Continued).

SN 79-019,334. INTERVET INTERNATIONAL B.V., AN BOXMEER BOXMEER, NETHERLANDS, FILED 12-1-2005.

VIDALTA

THE MARK CONSISTS OF STANDARD CHARACTERS WITHOUT CLAIM TO ANY PARTICULAR FONT, STYLE, SIZE, OR COLOR.

PRIORITY DATE OF 9-14-2005 IS CLAIMED.

OWNER OF INTERNATIONAL REGISTRATION 0872498 DATED 12-1-2005, EXPIRES 12-1-2015.

FOR PHARMACEUTICAL PREPARATIONS FOR VETERINARY USE, NAMELY HORMONE PREPARATIONS FOR DOGS (U.S. CLS. 6, 18, 44, 46, 51 AND 52).

TINA BROWN, EXAMINING ATTORNEY

SN 79-022,577. TOPOTARGET A/S, DENMARK, FILED 2-16-2006.

SAVICOL

PRIORITY DATE OF 8-18-2005 IS CLAIMED.

OWNER OF INTERNATIONAL REGISTRATION 0881569 DATED 2-16-2006, EXPIRES 2-16-2016.

FOR PHARMACEUTICALS, NAMELY PHARMACEUTICALS FOR THE DIAGNOSIS, PROPHYLAXIS AND TREATMENT OF CANCERS, FAMILIAL ADENOMATOUS POLYPOSIS AND HYPERPROLIFERATIVE AND INFLAMMATORY GASTROINTESTINAL DISORDERS AND DISEASES (U.S. CLS. 6, 18, 44, 46, 51 AND 52).

VERNA BETH RIRIE, EXAMINING ATTORNEY

SN 79-023,029. ORTHOMOL PHARMAZEUTISCHE; VERTRIEBS GMBH, 40764 LANGENFELD, FED REP GERMANY, FILED 2-16-2006.

ORTHOMOL

THE MARK CONSISTS OF STANDARD CHARACTERS WITHOUT CLAIM TO ANY PARTICULAR FONT, STYLE, SIZE, OR COLOR.

OWNER OF INTERNATIONAL REGISTRATION 0882519 DATED 2-16-2006, EXPIRES 2-16-2016.

FOR PHARMACEUTICAL PREPARATIONS CONTAINING MINERALS, TRACE ELEMENTS, AND VITAMINS FOR THE TREATMENT OF GASTROINTESTINAL PROBLEMS; PHARMACEUTICAL PREPARATIONS FOR IMPROVING IMMUNE SYSTEM PERFORMANCE; DIETIC FOODS ADAPTED FOR MEDICAL USE; AND VITAMINS IN THE FORM OF GRANULATES, POWDERS, EMULSIONS, DRAGÉES, CAPSULES, JUICES, CANDIES, AND DROPS (U.S. CLS. 6, 18, 44, 46, 51 AND 52).

VERNA BETH RIRIE, EXAMINING ATTORNEY

CLASS 6—METAL GOODS

CLASS 6—(Continued).

SN 76-646,836. QUALBUILT, INC, IRVINE, CA. FILED 9-15-2005.

SN 78-456,134. BLACK & DECKER CORPORATION, THE, TOWSON, MD. FILED 7-24-2004.

Q BUILT

FASHION DOORWARE

THE MARK CONSISTS OF STANDARD CHARACTERS WITHOUT CLAIM TO ANY PARTICULAR FONT, STYLE, SIZE, OR COLOR.

FOR HUBLESS CAST IRON SOIL PIPE AND FITTINGS FOR SANITARY AND STORM DRAIN, WASTE, AND VENT APPLICATIONS (U.S. CLS. 2, 12, 13, 14, 23, 25 AND 50).

FIRST USE 8-1-2005; IN COMMERCE 8-1-2005.
WANDA KAY PRICE, EXAMINING ATTORNEY

THE MARK CONSISTS OF STANDARD CHARACTERS WITHOUT CLAIM TO ANY PARTICULAR FONT, STYLE, SIZE, OR COLOR.

NO CLAIM IS MADE TO THE EXCLUSIVE RIGHT TO USE "DOORWARE", APART FROM THE MARK AS SHOWN.

FOR METAL DOOR HARDWARE FOR RESIDENTIAL DOORS, NAMELY KEYS AND KEY CYLINDERS, KNOBS, LEVERS, HINGES, KICKPLATES AND HANDLESETS COMPRISING AT LEAST ONE ESCUTCHEON, A GRIP AND A THUMB OPERATED ACTUATING MECHANISM (U.S. CLS. 2, 12, 13, 14, 23, 25 AND 50).
BARBARA BROWN, EXAMINING ATTORNEY

SN 78-421,793. TRUTH HARDWARE CORPORATION, OWATONNA, MN. FILED 5-19-2004.

SN 78-556,774. G-3 ENTERPRISES, MODESTO, CA. FILED 1-31-2005.

ENCORE

ROYAL 90

THE MARK CONSISTS OF STANDARD CHARACTERS WITHOUT CLAIM TO ANY PARTICULAR FONT, STYLE, SIZE, OR COLOR.

FOR WINDOW HARDWARE MADE PRIMARILY OF METAL, NAMELY, BRACKETS, TRACKS, LATCHES, LOCKS, KNOBS, HANDLES, HINGES, OPERATORS, AND LEVERSETS, SOLD EXCLUSIVELY TO MANUFACTURERS (U.S. CLS. 2, 12, 13, 14, 23, 25 AND 50).
JOHN DWYER, EXAMINING ATTORNEY

THE MARK CONSISTS OF STANDARD CHARACTERS WITHOUT CLAIM TO ANY PARTICULAR FONT, STYLE, SIZE, OR COLOR.

FOR BOTTLE CLOSURES MADE OF METAL (U.S. CLS. 2, 12, 13, 14, 23, 25 AND 50).
FIRST USE 4-15-2004; IN COMMERCE 4-15-2004.
RUDY R. SINGLETON, EXAMINING ATTORNEY

CLASS 6—(Continued).

SN 78-646,754. COOPER TECHNOLOGIES COMPANY, HOUSTON, TX. FILED 6-8-2005.

KWIKPAK

THE MARK CONSISTS OF STANDARD CHARACTERS WITHOUT CLAIM TO ANY PARTICULAR FONT, STYLE, SIZE, OR COLOR.

FOR METAL CABLE SUPPORTS FOR LIGHTING, ELECTRICAL, MECHANICAL, AND HVAC SUPPORTS MADE OF METAL, CONDUIT SUPPORTS MADE OF METAL, CABLE TRAY SUPPORTS MADE OF METAL, PIPING SUPPORTS MADE OF METAL, DUCT SUPPORTS MADE OF METAL; WIRE ROPE, WIRE SUPPORTS MADE OF METAL AND STRANDED WIRE (U.S. CLS. 2, 12, 13, 14, 23, 25 AND 50).

STEPHANIE DAVIS, EXAMINING ATTORNEY

SN 78-681,194. UNISON HARDWARE, INC., DBA UNISON ARCHITECTURAL HARDWARE, SACRAMENTO, CA. FILED 7-29-2005.

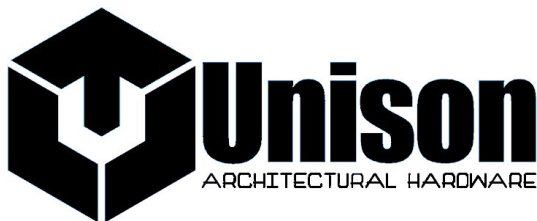

NO CLAIM IS MADE TO THE EXCLUSIVE RIGHT TO USE ARCHITECTURAL HARDWARE, OR UNISON AS TO "METAL DOOR HARDWARE, NAMELY WINDOW LOCKS, METAL WINDOW STOPS, METAL WINDOW HANDLES, METAL SASH LOCKS AND METAL STOPS", APART FROM THE MARK AS SHOWN.

FOR METAL DOOR HARDWARE, NAMELY METAL DOOR KNOBS, METAL DOOR LEVERS, METAL DOOR OPENERS, METAL DOOR CLOSERS, METAL DEAD BOLTS, METAL ENTRY LOCKSETS, METAL CHAIN GUARD, METAL KEYED LOCKS, METAL DOOR HINGES, METAL RIM LATCHES, METAL MORTISE LOCKS; METAL DOOR STOPS, METAL DOOR HOLDERS, METAL DOOR KICKPLATES, METAL DOOR PUSH PLATES, METAL DOOR PULLS, METAL DOOR KNOCKERS, METAL DOOR DUSTPROOF STRIKERS; METAL DOOR HARDWARE ACCESSORIES, NAMELY METAL NON-ELECTRIC METAL AND DOORBELLS, METAL DOORBELL BUTTONS, THEREFORE METAL DOOR VIEWERS, METAL ROSETTES, METAL MAIL SLOTS, METAL MAIL BOXES, METAL ADDRESS PLATES, METAL SIGN PLATES, METAL DOOR EMERGENCY EXIT RELEASING UNITS, METAL KEY BLANKS, METAL KEYS, METAL DOOR HARDWARE, NAMELY WINDOW LOCKS, METAL WINDOW STOPS, METAL WINDOW HANDLES, METAL SASH LOCKS AND METAL STOPS, METAL DOOR GUARDS, METAL LOCK SECURITY CYLINDERS, AND RIM CYLINDERS, METAL BATHTUB AND METAL SHOWER GRAB BAR, METAL CABINET CATCHES, METAL CABINET LOCKS; METAL SHELF BRACKETS, METAL HOOKS (U.S. CLS. 2, 12, 13, 14, 23, 25 AND 50).

STEVEN R. FINE, EXAMINING ATTORNEY

CLASS 6—(Continued).

SN 78-697,947. MICRO DRIVE, INC., RHINO MOUNTS DIVISION, NASHVILLE, TN. FILED 8-22-2005.



FOR METAL AUDIO, VIDEO AND COMPUTER WALL AND CEILING MOUNTS (U.S. CLS. 2, 12, 13, 14, 23, 25 AND 50).

FIRST USE 12-1-2003; IN COMMERCE 9-1-2004.
CHERYL CLAYTON, EXAMINING ATTORNEY

SN 78-705,258. MILLENNIUM TILES LLC, BARRINGTON, IL. FILED 9-1-2005.

CHORR-TWELF USA

THE MARK CONSISTS OF STANDARD CHARACTERS WITHOUT CLAIM TO ANY PARTICULAR FONT, STYLE, SIZE, OR COLOR.

NO CLAIM IS MADE TO THE EXCLUSIVE RIGHT TO USE USA, APART FROM THE MARK AS SHOWN.

FOR METAL ROOF SHINGLES AND METAL EXTERIOR WALL PANELS (U.S. CLS. 2, 12, 13, 14, 23, 25 AND 50).

HEATHER THOMPSON, EXAMINING ATTORNEY

SN 78-740,206. IRATHANE SYSTEMS, INC., HIBBING, MN. FILED 10-25-2005.

IRACOUPLING

THE MARK CONSISTS OF STANDARD CHARACTERS WITHOUT CLAIM TO ANY PARTICULAR FONT, STYLE, SIZE, OR COLOR.

FOR METAL PIPE END CONNECTORS FOR SLURRY TRANSPORTATION (U.S. CLS. 2, 12, 13, 14, 23, 25 AND 50).

FIRST USE 10-12-2005; IN COMMERCE 10-12-2005.
HOWARD B. LEVINE, EXAMINING ATTORNEY

CLASS 6—(Continued).

SN 78-765,937. ZHEJIANG ZHAPU INDUSTRIAL CO.LTD, JIAXING, CHINA, FILED 12-2-2005.



FOR METAL NUTS & BOLTS (U.S. CLS. 2, 12, 13, 14, 23, 25 AND 50).
JENNIFER MARTIN, EXAMINING ATTORNEY

CLASS 6—(Continued).

SN 78-848,253. FLASHCO MANUFACTURING, INC., SEBAS-
TOPOL, CA. FILED 3-28-2006.

FLASHCO

THE MARK CONSISTS OF STANDARD CHARACTERS WITHOUT CLAIM TO ANY PARTICULAR FONT, STYLE, SIZE, OR COLOR.
FOR METAL ROOF FLASHING; SHEET LEAD (U.S. CLS. 2, 12, 13, 14, 23, 25 AND 50).
FIRST USE 9-15-2000; IN COMMERCE 9-0-2001.
ALICIA COLLINS, EXAMINING ATTORNEY

SN 78-796,939. SONES, MICHAEL, ATLANTIC BEACH, FL. FILED 1-23-2006.

IN GOD WE TRUST

THE MARK CONSISTS OF STANDARD CHARACTERS WITHOUT CLAIM TO ANY PARTICULAR FONT, STYLE, SIZE, OR COLOR.
FOR METAL DOG TAGS (U.S. CLS. 2, 12, 13, 14, 23, 25 AND 50).
JOHN GARTNER, EXAMINING ATTORNEY

SN 78-850,363. TRIANGLE FASTENER CORPORATION, PITTSBURGH, PA. FILED 3-30-2006.

PANEL-TITE

THE MARK CONSISTS OF STANDARD CHARACTERS WITHOUT CLAIM TO ANY PARTICULAR FONT, STYLE, SIZE, OR COLOR.
FOR METAL SELF-TAPPING AND SELF-DRILLING METAL-TO-WOOD FASTENERS, NAMELY, SCREWS (U.S. CLS. 2, 12, 13, 14, 23, 25 AND 50).
FIRST USE 12-10-1999; IN COMMERCE 12-10-1999.
DAVID TAYLOR, EXAMINING ATTORNEY

SN 78-824,969. CRESCENT MANUFACTURING HOLDINGS, LLC, BURLINGTON, CT. FILED 2-28-2006.

KWIK-THRED

THE MARK CONSISTS OF STANDARD CHARACTERS WITHOUT CLAIM TO ANY PARTICULAR FONT, STYLE, SIZE, OR COLOR.
FOR METAL THREADED FASTENERS FOR USE IN SHEET METAL (U.S. CLS. 2, 12, 13, 14, 23, 25 AND 50).
FIRST USE 8-25-1972; IN COMMERCE 5-24-1973.
DAVID TAYLOR, EXAMINING ATTORNEY

SN 78-854,909. WORLD BOTTLING CAP, L.L.C., BROOK-
LINE, MA. FILED 4-5-2006.

WORLD BOTTLING CAP

THE MARK CONSISTS OF STANDARD CHARACTERS WITHOUT CLAIM TO ANY PARTICULAR FONT, STYLE, SIZE, OR COLOR.
NO CLAIM IS MADE TO THE EXCLUSIVE RIGHT TO USE "BOTTLING CAP", APART FROM THE MARK AS SHOWN.
FOR BOTTLE CLOSURES OF METAL; METAL BOT-
TLE CAPS; METAL CAPS FOR BOTTLES (U.S. CLS. 2, 12, 13, 14, 23, 25 AND 50).
CHARISMA HAMPTON, EXAMINING ATTORNEY

CLASS 6—(Continued).

SN 78-859,235. RIGID BUILDING SYSTEMS, LTD., HOUSTON, TX. FILED 4-11-2006.

StuccoLite

THE MARK CONSISTS OF STANDARD CHARACTERS WITHOUT CLAIM TO ANY PARTICULAR FONT, STYLE, SIZE, OR COLOR.

FOR BUILDING MATERIALS FOR PRE-ENGINEERED BUILDINGS, NAMELY, METAL SUBSTRATES WITH A BAKED ON STUCCO FINISH (U.S. CLS. 2, 12, 13, 14, 23, 25 AND 50).

TINA BROWN, EXAMINING ATTORNEY

SN 78-862,782. CANARD, RICHARD E., LAUREL, MD. FILED 4-17-2006.

Postal Concepts

THE MARK CONSISTS OF STANDARD CHARACTERS WITHOUT CLAIM TO ANY PARTICULAR FONT, STYLE, SIZE, OR COLOR.

NO CLAIM IS MADE TO THE EXCLUSIVE RIGHT TO USE "POSTAL", APART FROM THE MARK AS SHOWN.

FOR METAL MAIL BOXES (U.S. CLS. 2, 12, 13, 14, 23, 25 AND 50).

MEGAN WHITNEY, EXAMINING ATTORNEY

SN 78-864,768. CORPORATE EXPRESS DOCUMENT & PRINT MANAGEMENT, INC., BROOMFIELD, CO. FILED 4-19-2006.

SCOT-TAGS

THE MARK CONSISTS OF STANDARD CHARACTERS WITHOUT CLAIM TO ANY PARTICULAR FONT, STYLE, SIZE, OR COLOR.

OWNER OF U.S. REG. NO. 1,418,141.

FOR ALUMINUM MARKING TAGS; ENGRAVABLE ALUMINUM TAGS; WRITE ON ALUMINUM TAGS (U.S. CLS. 2, 12, 13, 14, 23, 25 AND 50).

FIRST USE 0-0-1978, THE MARK WAS FIRST USED ANYWHERE IN A DIFFERENT FORM OTHER THAN THAT SOUGHT TO BE REGISTERED ON 00/00/1961.; IN COMMERCE 0-0-1978, THE MARK WAS FIRST USED IN COMMERCE IN A DIFFERENT FORM OTHER THAN THAT SOUGHT TO BE REGISTERED ON 00/00/1961..

JOHN SCHUYLER YARD, EXAMINING ATTORNEY

CLASS 6—(Continued).

SN 78-865,317. DEUTSCH ENGINEERED CONNECTING DEVICES, INC., HEMET, CA. FILED 4-19-2006.

DEUTSCHLITE

THE MARK CONSISTS OF STANDARD CHARACTERS WITHOUT CLAIM TO ANY PARTICULAR FONT, STYLE, SIZE, OR COLOR.

FOR SWAGABLE METAL TUBE FITTINGS (U.S. CLS. 2, 12, 13, 14, 23, 25 AND 50).

RÜSS HERMAN, EXAMINING ATTORNEY

SN 78-866,373. HIATT-THOMPSON, CORPORATION, BEDFORD PARK, IL. FILED 4-20-2006.

COLORCODR

THE MARK CONSISTS OF STANDARD CHARACTERS WITHOUT CLAIM TO ANY PARTICULAR FONT, STYLE, SIZE, OR COLOR.

FOR HANDCUFFS (U.S. CLS. 2, 12, 13, 14, 23, 25 AND 50).

FIRST USE 4-11-2006; IN COMMERCE 4-11-2006.

GEORGE LORENZO, EXAMINING ATTORNEY

SN 78-867,043. FORT WAYNE METALS RESEARCH PRODUCTS CORP., FORT WAYNE, IN. FILED 4-21-2006.

SLT

THE MARK CONSISTS OF STANDARD CHARACTERS WITHOUT CLAIM TO ANY PARTICULAR FONT, STYLE, SIZE, OR COLOR.

FOR WIRE (U.S. CLS. 2, 12, 13, 14, 23, 25 AND 50).

TONJA GASKINS, EXAMINING ATTORNEY

CLASS 6—(Continued).

SN 78-869,830. ACTION INDUSTRIES, LTD., CLEVELAND, OH. FILED 4-26-2006.

EXCALIBUR

THE MARK CONSISTS OF STANDARD CHARACTERS WITHOUT CLAIM TO ANY PARTICULAR FONT, STYLE, SIZE, OR COLOR.

FOR METAL THRESHOLDS (U.S. CLS. 2, 12, 13, 14, 23, 25 AND 50).

DARRYL SPRUILL, EXAMINING ATTORNEY

SN 79-019,065. OTKRYTOE AKTSIONERNOE OBCHTCH-ESTVO "OSKOL'SKIY ELEKTROMETALLURGICHESKIY KOMBINAT", RUSSIAN FED., FILED 11-10-2004.



OWNER OF INTERNATIONAL REGISTRATION 0871831 DATED 11-10-2004, EXPIRES 11-10-2014.

THE NON-LATIN CHARACTER(S) IN THE MARK TRANSLITERATES INTO OEMK, AND THIS MEANS NOTHING IN ENGLISH.

FOR COMMON METALS AND THEIR ALLOYS; BUILDING MATERIALS OF METAL, NAMELY, SOFFITS, FASCIA, CLADDING; PREFABRICATED BUILDINGS AND TRANSPORTABLE BUILDINGS ALL OF METAL; MATERIAL OF METAL FOR RAILWAY CONSTRUCTION; NON-ELECTRIC CABLES AND IRON WIRE OF METAL; KEY PRODUCTS, NAMELY, HOLDERS, FOBS, RINGS, BLANKS; PIPES OF METAL; METAL SAFES; ORES, NAMELY, IRON, TIN, COPPER; ALUMINUM, NAMELY, INGOTS, SIDING, ALLOY; ANCHORS; FITTINGS OF METAL FOR COMPRESSED AIR DUCTS; FITTINGS OF METAL FOR BUILDING; BUILDING MATERIALS, NAMELY, WHITE METAL; NON-LUMINOUS BEACONS OF METAL; VATS OF METAL; GIRDERS OF METAL; JOISTS OF METAL; BOTTLES, NAMELY, METAL CONTAINERS FOR COMPRESSED GAS OR LIQUID AIR; PRESERVE TINS AND PRESERVING BOXES BOTH OF METAL; NON-MECHANICAL REELS OF METAL FOR FLEXIBLE HOSES; METAL STRUCTURES, NAMELY, SWIMMING POOLS; GLUCINIUM, NAMELY, BERYLLIUM; SHINE LEAD ORE; STEEL BLOOMS FOR METALLURGY PURPOSES; INGOTS OF COMMON METAL; INgot STEEL USED IN METALLURGY; BOLTS OF METAL; EYE BOLTS; CASKS OF METAL; MOORING BUOYS OF METAL; BARRELS OF METAL; IDENTIFICATION BRACELETS OF METAL FOR HOSPITALS; CASTINGS, FOILS, POWDER, AND ROLLED, DRAWN OR EXTRUDED SEMI-FINISHED ARTICLES OF BONZE OR ITS ALLOYS; METAL BELLS; METAL BELLS FOR ANIMALS; LETTERS AND NUMERALS OF COMMON METAL EXCEPT TYPE; SILOS OF METAL; BUSTS OF COMMON METAL; NON-FERROUS METALS AND ALLOYS, NAMELY, VANADIUM; STRUCTURES OF METAL, NAMELY, BIRD BATHS; VICE BENCHES OF METAL; REVOLVING OBJECTS NOT AUTOMATIC, NAMELY, REVOLVING DOORS OF METAL; SCREWS OF METAL; STRUCTURES, NAMELY, AVIARIES OF METAL; TUNGSTEN ORES; NON-MECHANICAL HOPPERS OF METAL; GATES OF METAL; HARDWARE, NAMELY METAL SLEEVES; SIGNBOARDS OF METAL; DIVING BOARDS OF METAL; LOADING GAUGE RODS, OF METAL, FOR RAILWAY WAGONS; NUTS OF METAL; GALENA ORE; NON-

CLASS 6—(Continued).

FERROUS METALS AND ALLOYS, NAMELY, CELTIUM AND HAFNIUM; NAILS; METAL BRADS AND TACKS NAILS; METAL HORSESHOE NAILS; NON-FERROUS METALS AND ALLOYS, NAMELY, GERMANIUM; TOMBS OF METAL; VICE CLAWS OF METAL; DOORS OF METAL; CHIMNEY COWLS OF METAL; MEMORIAL PLAQUES, OF METAL; TOMBSTONE PLAQUES OF METAL; CHIMNEY SHAFTS OF METAL; INDUSTRIAL PACKAGING CONTAINERS OF METAL; CONTAINERS OF METAL FOR STORING ACIDS; TINS OF METAL; JALOUSIES OF METAL; BROWN IRON ORES; UNWROUGHT OR SEMI-WROUGHT IRON; GUTTERS OF METAL; TINPLATE; JETS OF METAL; BUNGS OF METAL; LATCH BARS OF METAL; WINDOW FASTENERS OF METAL; CRAMPS, NAMELY, CRAMPONS OF METAL FOR CLIMBING; MONEY CLIPS OF COMMON METAL; BINDING SCREWS OF METAL FOR CABLES; BOOTS, NAMELY, METAL WHEEL CLAMPS; RIVETS OF METAL; METAL PADLOCKS; LOCKS OF METAL FOR VEHICLES; METAL LOCKS; LOCKS OF METAL FOR BAGS; METAL SPRING LOCKS; BOX FASTENERS OF METAL; MACHINE BELT FASTENERS OF METAL; METAL DOOR BOLTS; BOTTLE CLOSURES OF METAL; CLOSURES OF METAL FOR CONTAINERS; METAL BOLTS; NON-ELECTRIC WALL PLUGS OF METAL; LATCHES OF METAL; METAL HARDWARE, NAMELY, TENSION LINKS; STRETCHERS FOR METAL BANDS IN THE NATURE OF TENSION LINKS; METAL HARDWARE, NAMELY, WIRE STRETCHERS IN THE NATURE OF TENSION LINKS; STRETCHERS FOR IRON BANDS IN THE NATURE OF TENSION LINKS; COUPLINGS OF METAL FOR CHAINS; NON-ELECTRIC METAL DOOR BELLS; NON-LUMINOUS AND NON-MECHANICAL METAL SIGNS FOR ROADS; NON-LUMINOUS AND NON-MECHANICAL METAL SIGNS; NUMBER PLATES OF METAL; BRONZE WORKS OF ART, NAMELY, SCULPTURES AND STATUES; WORKS OF ART OF COMMON METAL, NAMELY, SCULPTURES AND STATUES; NON-FERROUS METALS AND ALLOYS, NAMELY, INDIUM; CABANAS OF METAL; TELEPHONE BOOTHS OF METAL; NON-FERROUS METALS AND ALLOYS, NAMELY, CADMIUM; BOOTHS OF METAL FOR SPRAYING PAINT; ROPES OF METAL; NON-ELECTRIC METAL TELPHER CABLES; GREENHOUSE FRAMES OF METAL; FRAMEWORK OF METAL FOR BUILDING; CORNICES OF METAL; CERMENTS COMPOSED PRIMARILY OF METAL FOR FURTHER MANUFACTURING; DRAIN TRAPS VALVES OF METAL; METAL KEYS; WINDING KEYS OF METAL; KNOBS OF METAL; RAW COBALT FOR FURTHER MANUFACTURE AS BUILDING MATERIALS; FOUNDRY CHILL-MOLDS; ELBOWS OF METAL FOR PIPES; BED CASTERS OF METAL; FURNITURE CASTERS OF METAL; MANIFOLDS OF METAL FOR PIPELINES; PILLARS OF METAL FOR BUILDINGS; SEALING CAPS OF METAL; BOTTLE CAPS OF METAL; TENT PEGS OF METAL; RINGS OF COMMON METAL FOR KEYS; FERRULES OF METAL; FERRULES OF METAL FOR HANDLES; METAL RING COLLARS FOR FASTENING DOWNSPOUTS; DOOR FITTINGS, OF METAL; FITTINGS OF METAL FOR WINDOWS; STEEL BUILDINGS, BUILDINGS OF METAL; GUARD RAILS OF METAL; BASKETS OF METAL; MONEY BOXES OF METAL; BOXES OF COMMON METALS; DOOR CASES OF METAL; STRINGERS AS PARTS OF STAIRCASES OF METAL; METAL TAPS FOR CASKS; TUBING OF METAL; CASINGS OF METAL FOR OIL WELLS; ROOFING OF METAL; BRACKETS OF METAL FOR BUILDINGS; METAL RAILWAY TURN-TABLES; MANHOLE COVERS OF METAL; MOUNTAINING EQUIPMENT, NAMELY, PITONS OF METAL; HARDWARE, NAMELY, METAL HOOKS; POT HOOKS OF METAL; METAL HARDWARE, NAMELY, HOOKS FOR SLATE; HOOKS OF METAL FOR CLOTHES RAILS; CLOTHES HOOKS OF METAL; CHICKEN HOUSES OF METAL; UNWROUGHT OR SEMI-WROUGHT BRASS; BANDS OF METAL FOR TYING-UP PURPOSES; SCAFOLDING OF METAL; STAIRCASES OF METAL; LADDERS OF METAL; LIMONITE FOR FURTHER MANUFACTURE AS BUILDING MATERIALS; STEEL SHEETS; METAL FOUNDRY FORMS FOR SHAPE CASTING; CAST STEEL; TRAPS FOR WILD ANIMALS; MAGNESIUM AND ITS ALLOYS; MANGANESE ORES; REINFORCING MATERIALS OF METAL FOR CONCRETE; REINFORCING MATERIALS OF METAL FOR MACHINE BELTS; REINFORCING MATERIALS OF METAL FOR PIPES; REINFORCING MATERIALS OF

CLASS 6—(Continued).

METAL FOR BUILDING; MATERIALS OF METAL FOR FUNICULAR RAILWAY PERMANENT TRACKS; MATERIALS OF METAL FOR RAILWAY CONSTRUCTION; MATERIALS CERAMIC-METAL; MASTS OF METAL FOR BUILDING PURPOSES; MASTS FOR ELECTRIC MAINS; STEEL MASTS IN THE NATURE OF POLES; UNWROUGHT OR SEMI-WROUGHT COPPER; SHEETS AND PLATES OF METAL; UNWROUGHT OR SEMI-WROUGHT COMMON METALS; MOLYBDENUM ORES; METAL DOOR KNOCKERS; MONUMENTS OF NON-PRECIOUS METAL; PIPE MUFFS OF METAL; BUILDING PORCHES OF METAL; MONUMENTS OF METAL FOR TOMBS; BRONZES FOR TOMBSTONES; ROOF FLASHING OF METAL; METAL RAILS, NAMELY, FISH PLATES; FLASHING OF METAL, FOR BUILDING; ANVILS; PORTABLE ANVILS; METAL BEAK-IRONS OR BICK-IRONS; FERRULES OF METAL FOR WALKING STICKS; ROPE THIMBLES OF METAL; HAND-CUFFS; DUCK BOARDS OF METAL; FLOORINGS FROM METAL BARS; GERMAN SILVER; NICKEL AND ITS ALLOYS; NIOBIUM AND ITS ALLOYS; METAL GREASE NIPPLES; THREAD OF METAL FOR TYING-UP PURPOSES; BINDING THREAD OF METAL FOR AGRICULTURAL PURPOSES; NON-LUMINOUS HOUSE NUMBERS OF METAL; BRACES OF METAL FOR HANDLING LOADS, HARNESS OF METAL FOR HANDLING LOADS; BUILDING WALL CLADDINGS OF METAL; BUILDING WALL LININGS OF METAL; CLADDING OF METAL FOR CONSTRUCTION AND BUILDING; MOLDINGS OF METAL FOR CORNICES; LATHS OF METAL; BARREL HOOPS OF METAL; PALINGS OF METAL; TREE PROTECTORS OF METAL; CRASH BARRIERS OF METAL FOR ROADS; LATTICEWORK OF METAL, NAMELY, METAL LATTICES; IRONWORK FOR DOORS, NAMELY, CAST IRON AND WROUGHT IRON DECORATIVE ARTWORK; IRONWORK FOR WINDOWS, CAST IRON AND WROUGHT IRON DECORATIVE ARTWORK; WINDOWS OF METAL; CASEMENT WINDOWS OF METAL; SHUTTERING OF METAL FOR CONCRETE; FILINGS OF METAL; CASK STANDS OF METAL; POLES OF METAL FOR ELECTRIC LINES; PORTABLE GREENHOUSES OF METAL; CASTING STEEL; WAINSCOTINGS OF METAL; NON-LUMINOUS AND NON-MECHANICAL SIGNALING PANELS OF METAL; BRANCHING PIPES OF METAL; PARTITIONS OF METAL; LINTELS OF METAL; STRAP-HINGES OF METAL; METAL SHIMS; ROCKET LAUNCHING PLATFORMS OF METAL; PREFABRICATED PLATFORMS OF METAL; TRANSPORT PALLETS OF METAL; FLOOR TILES OF METAL; TILES OF METAL FOR BUILDING; ANCHOR PLATES; GRAVESTONE SLABS OF METAL; IRON SLABS; LEAD SEALS; HANDLING PALLETS OF METAL; HORSESHOES OF METAL; PROPS OF METAL; FIRE-DOGS (ANDIRONS); ROOF COVERINGS OF METAL; FLOORS FROM METAL BARS; FLOORS OF METAL; WINDOW SILLS OF METAL; METAL BUILDING PORTICOES; CEILING PANELS OF METAL; GOLD SOLDER; SILVER SOLDER; MANUALLY OPERATED VALVES OF METAL OTHER THAN PARTS OF MACHINES; COLLARS OF METAL FOR FASTENING PIPES, WALL HOOKS OF METAL FOR PIPES, CLIPS OF METAL FOR CABLES AND PIPES; WATER PIPE VALVES OF METAL; FLOATING DOCKS OF METAL FOR MOORING BOATS; IRON WIRE; ALUMINUM WIRE; WIRE FOR AERIALS; SOLDERING WIRE OF METAL; WIRE OF COMMON METAL; WIRE OF COMMON METAL ALLOYS EXCEPT FUSE WIRE; BARBED WIRE; COPPER WIRE NOT INSULATED; STEEL WIRE; METAL HARDWARE, NAMELY, WASHERS; METAL HARDWARE, NAMELY, SPRINGS; METAL DOOR SPRINGS NOT ELECTRIC; RODS OF METAL FOR WELDING; RODS OF METAL FOR BRAZING; METAL DOOR FRAMES; ENCLOSURES OF METAL FOR TOMBS; METAL FRAMES FOR GREENHOUSES AND HOTHOUSES; WINDOW FRAMES OF METAL; FRAMES OF METAL FOR BUILDING; FLUID STORAGE TANKS OF METAL; CONTAINERS OF METAL FOR GENERAL STORAGE AND TRANSPORT; CONTAINERS OF METAL FOR THE STORAGE AND TRANSPORT OF LIQUID FUEL; CONTAINERS OF METAL FOR COMPRESSED GAS OR LIQUID AIR; RAILS OF METAL; BELTS OF METAL FOR HANDLING LOADS; GRATINGS OF METAL; METAL FURNACE FIREGUARDS; PULLEYS OF METAL OTHER THAN FOR MACHINES; RUNNERS OF METAL FOR SLIDING DOORS; METAL WINDOW SASH PULLEYS; IRON ORES; ORES OF METAL; CHROME IRON ORES; TOOL

CLASS 6—(Continued).

HANDLES OF METAL; DOOR HANDLES OF METAL; SCYTHE HANDLES OF METAL; BROOM HANDLES OF METAL; KNIFE HANDLES OF METAL; PILINGS OF METAL; UNWROUGHT OR SEMI-WROUGHT LEAD; METAL SAFES AND STRONG BOXES; STEEL REINFORCING GRIDS FOR USE IN PAVING PROCESSES; BURIAL VAULTS OF METAL; DOOR SCRAPERS, FOOT SCRAPERS, INGOTS FROM COMMON METAL; NON-ELECTRIC CABLE JOINTS OF METAL; JUNCTIONS OF METAL FOR PIPES; NOZZLES OF METAL; ANTI-FRICTION METAL FOR FURTHER MANUFACTURE AS BUILDING MATERIALS; SILVER PLATED TIN ALLOY; NICKEL-SILVER FOR FURTHER MANUFACTURE AS BUILDING MATERIALS; BINDINGS OF METAL; SHEAF BINDERS OF METAL; SHUTTERS OF METAL; EXTERIOR BLINDS OF METAL; STEEL ALLOYS; HOOP IRON; HOOP STEEL; UNWROUGHT OR SEMI-WROUGHT STEEL; TIN FOIL; STATUES OF COMMON METAL; FIGURINES AND STATUETTES OF COMMON METAL; TOMBSTONE STELAE OF METAL; PEGS OF METAL; BARS FOR METAL RAILINGS; POSTS OF METAL; ADVERTISEMENT COLUMNS OF METAL; TELEGRAPH POSTS OF METAL; METAL RAILWAY POINTS; LADDER STEPS OF METAL; SLINGS OF METAL FOR HANDLING LOADS; IDENTITY PLATES OF METAL; TROUGHS OF METAL FOR MIXING MORTAR; METAL GREENHOUSES; TITANIUM AND ITS ALLOYS; WIRE CLOTH; TOMBAC; METAL MOBILE BOARDING STAIRS FOR PASSENGERS; NON-ELECTRIC CABLES OF METAL; WIRE ROPE; PIPE WORK OF METAL; DUCTS OF METAL FOR VENTILATING AND AIR CONDITIONING INSTALLATIONS; PEN-STOCK PIPES OF METAL; PIPES OF METAL; GUTTER PIPES OF METAL; DRAIN PIPES OF METAL; CHIMNEYS OF METAL; WATER PIPES OF METAL; STEEL PIPES; DUCTS AND PIPES OF METAL FOR CENTRAL HEATING INSTALLATIONS; MOORING BOLLARDS OF METAL; NON-AUTOMATIC TURNSTILES; METAL BUILDING MATERIALS, NAMELY, ANGLE IRONS; TINPLATE PACKINGS; DOOR STOPS OF METAL; SASH FASTENERS OF METAL FOR WINDOWS; BICYCLE PARKING INSTALLATIONS OF METAL; NON-ELECTRIC DEVICES OF METAL FOR CLOSING AND OPENING OF DOORS; FIXED TOWEL DISPENSERS OF METAL; TUNGSTEN IRON ORES; MOLYBDENUM IRON ORES; SILICON IRON ORES; FERROTITANIUM; CHROME IRON ORES; DOOR PANELS OF METAL; COLLARS, NAMELY, FLANGES OF METAL; WEATHER OR WIND VANES OF METAL; ALUMINUM FOIL; FOILS OF METAL FOR WRAPPING AND PACKAGING; ICE MOULDS OF METAL; FITTINGS OF METAL FOR COFFINS; FITTINGS OF METAL FOR BEDS; FITTINGS OF METAL FOR FURNITURE; BUILDING OR FURNITURE FITTINGS OF NICKEL-SILVER; STIRRUPS OF METAL; CHROMIUM; METAL CHAINS FOR RESTRAINING CATTLE; SAFETY CHAINS OF METAL; CHAINS OF METAL; ZINC AND ITS ALLOYS; ZIRCONIUM; TILES OF METAL; UNWROUGHT OR SEMI-WROUGHT CAST IRON; BALLS OF STEEL; HINGES OF METAL; POLES OF METAL; CRAMPONS (CLIMBING IRONS); CASH BOXES OF METAL; METAL SAFETY CASH BOXES; METAL PULLEYS EXCEPT FOR PARTS OF MACHINES; BELT STRETCHERS OF METAL; RAILROAD TIES OF METAL; WINDOW CASEMENT METAL BOLTS; COTTER PINS; SPURS; EXTERIOR ROLLER BLINDS OF STEEL; BUILDING BOARDS OF METAL; INSECT SCREENS OF METAL; BADGES OF METAL FOR VEHICLES; LOCK BOLTS; BINS OF METAL; TOOL BOXES OF METAL SOLD EMPTY; CHESTS OF METAL FOR FOOD; BOXES OF COMMON METAL; LETTER BOXES OF METAL (U.S. CLS. 2, 12, 13, 14, 23, 25 AND 50).

DARRYL SPRUILL, EXAMINING ATTORNEY

CLASS 7—MACHINERY

SN 76-594,984. DIAMOND TOOL COATING, LLC, NORTH TONAWANDA, NY. FILED 6-1-2004.

DIATIGER

THE MARK CONSISTS OF STANDARD CHARACTERS WITHOUT CLAIM TO ANY PARTICULAR FONT, STYLE, SIZE, OR COLOR.

FOR SURFACE HARDENED PROTECTIVE FINISHING COATINGS SOLD AS AN INTEGRAL FEATURE OF CARBIDE AND OTHER PRE-MANUFACTURED MACHINE CUTTING TOOLS (U.S. CLS. 13, 19, 21, 23, 31, 34 AND 35).

ELIZABETH J. WINTER, EXAMINING ATTORNEY

CLASS 7—(Continued).

SN 76-643,411. ATRUMP MACHINERY INC., POMONA, CA. FILED 7-25-2005.

A ONE

THE MARK CONSISTS OF STANDARD CHARACTERS WITHOUT CLAIM TO ANY PARTICULAR FONT, STYLE, SIZE, OR COLOR.

FOR MACHINERY NAMELY, CNC LATHES, MANUAL LATHES, CNC MILLING MACHINES, MANUAL MILLING MACHINES, AND MACHINERY CENTER (U.S. CLS. 13, 19, 21, 23, 31, 34 AND 35).

ODESSA BIBBINS, EXAMINING ATTORNEY

SN 76-651,569. HINSILBLON, LTD., FORT MYERS, FL. FILED 12-7-2005.

ROBINE

THE MARK CONSISTS OF STANDARD CHARACTERS WITHOUT CLAIM TO ANY PARTICULAR FONT, STYLE, SIZE, OR COLOR.

FOR WIND DRIVEN ODOR NEUTRALIZING SYSTEM CONSISTING OF WINDMILLS, PUMPS, HOSES AND HOLDING TANKS FOR THE STORAGE AND DISTRIBUTION OF ODOR NEUTRALIZING PREPARATIONS, NOT FOR AGRICULTURAL USE (U.S. CLS. 13, 19, 21, 23, 31, 34 AND 35).

DANIEL RUSSELL, EXAMINING ATTORNEY

SN 76-625,900. KOENIG & BAUER AKTIENGESELLSCHAFT, 97080 WUZBURG, FED REP GERMANY, FILED 12-29-2004.

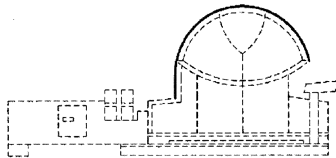

THE MARK IS A THREE-DIMENSIONAL MARK CONSISTING OF A TRADE DRESS APPLIED TO THE PRODUCT CONFIGURATION FOR A PRINTING PRESS; NAMELY THE CONFIGURATION OF A SEMI-CIRCULAR SIDE WALL SEGMENT TERMINATING IN A TOP SURFACE DEFINING THE CYLINDRICAL WALL SEGMENT. THE SEMI-CIRCULAR SIDE WALL SEGMENT AND TOP CYLINDRICAL WALL SEGMENT DOMINATE THE PRODUCT CONFIGURATION AND ARE FEATURES OF THE MARK. THE DOTTED LINES SHOW THE POSITION OF THE MARK ON THE GOODS AND ARE NOT A FEATURE OF THE MARK.

SEC. 2(F).

FOR PRINTING PRESSES AND THEIR STRUCTURAL AND REPLACEMENT PARTS; GRAPHIC ARTS FLEXOGRAPHIC PRINTING MACHINES AND THEIR STRUCTURAL AND REPLACEMENT PARTS; PRINT CONVERTING MACHINES AND THEIR STRUCTURAL AND REPLACEMENT PARTS; ACCESSORIES FOR PRINTING PRESSES, GRAPHIC ARTS MACHINES AND PRINT CONVERTING MACHINES, NAMELY, MECHANICAL TRANSPORT SYSTEMS COMPRISED OF CONVEYORS AND CONVEYOR BELTS, PRINTING COUPLES, INKING UNITS, DAMPENERS, POWER OPERATED FOLDING MACHINES, REEL STANDS (U.S. CLS. 13, 19, 21, 23, 31, 34 AND 35).

FIRST USE 1-1-2001; IN COMMERCE 1-1-2001.

ELISSA GARBER KON, EXAMINING ATTORNEY

SN 76-658,311. UNEX CORPORATION, MAHWAH, NJ. FILED 4-12-2006.

QUADRAULIC

THE MARK CONSISTS OF STANDARD CHARACTERS WITHOUT CLAIM TO ANY PARTICULAR FONT, STYLE, SIZE, OR COLOR.

OWNER OF U.S. REG. NO. 2,384,121. FOR HYDRAULIC PUMPS (U.S. CLS. 13, 19, 21, 23, 31, 34 AND 35).

FIRST USE 8-0-2003; IN COMMERCE 8-0-2003.

KRISTINA KLOIBER, EXAMINING ATTORNEY

CLASS 7—(Continued).

SN 76-658,610. RIVERA ENGINEERING, INC., WHITTIER, CA. FILED 4-17-2006.

THE SMOOTHIE

THE MARK CONSISTS OF STANDARD CHARACTERS WITHOUT CLAIM TO ANY PARTICULAR FONT, STYLE, SIZE, OR COLOR.

FOR MOTORCYCLE ENGINE PARTS, NAMELY, AIR CLEANERS (U.S. CLS. 13, 19, 21, 23, 31, 34 AND 35).

FIRST USE 12-28-1993; IN COMMERCE 12-28-1993.
GEOFFREY FOSDICK, EXAMINING ATTORNEY

SN 76-658,822. ERGOTECH, INC., DANBURY, CT. FILED 4-21-2006.

ERGO-ROLL

THE MARK CONSISTS OF STANDARD CHARACTERS WITHOUT CLAIM TO ANY PARTICULAR FONT, STYLE, SIZE, OR COLOR.

FOR ROLLERS FOR INDUSTRIAL CONVEYORS (U.S. CLS. 13, 19, 21, 23, 31, 34 AND 35).

FIRST USE 12-0-2003; IN COMMERCE 12-0-2003.
JAMES GRIFFIN, EXAMINING ATTORNEY

SN 76-659,177. HAPPY VALLEY RANCH, INC., PAOLA, KS. FILED 4-27-2006.

JAFFREY

THE MARK CONSISTS OF STANDARD CHARACTERS WITHOUT CLAIM TO ANY PARTICULAR FONT, STYLE, SIZE, OR COLOR.

FOR CIDER AND WINE PRESS (U.S. CLS. 13, 19, 21, 23, 31, 34 AND 35).

FIRST USE 9-11-1984; IN COMMERCE 9-11-1984.
PETER B. BROMAGHIM, EXAMINING ATTORNEY

CLASS 7—(Continued).

SN 78-153,016. R&G GROUP INTERNATIONAL, INC., PARAMOUNT, CA. FILED 8-10-2002.



OWNER OF U.S. REG. NO. 2,509,288.
FOR CRAWLER TRACKS, TIRE CHAINS AND OVER-THE-TIRE TRACK SYSTEMS FOR SKID-STEER LOADERS AND OTHER CONSTRUCTION MACHINERY (U.S. CLS. 13, 19, 21, 23, 31, 34 AND 35).

FIRST USE 7-30-2002; IN COMMERCE 7-30-2002.
KATHERINE STOIDES, EXAMINING ATTORNEY

SN 78-455,535. MCGUIRE BEARING COMPANY, PORTLAND, OR. FILED 7-23-2004.

AXIS

THE MARK CONSISTS OF STANDARD CHARACTERS WITHOUT CLAIM TO ANY PARTICULAR FONT, STYLE, SIZE, OR COLOR.

FOR MACHINE PARTS, NAMELY, BEARINGS, BUSHINGS, AND POWER TRANSMISSION COMPONENTS, NAMELY BELTS, SHEAVES, PULLEYS, CHAINS, SPROCKETS, SHAFT COLLARS, HUBS, COUPLINGS, TIGHTENERS, IDLERS, GEARS, GEAR BOXES, SPEED REDUCERS, KEYSTOCK, ROLLER CHAINS, AND CONVEYOR BELTS (U.S. CLS. 13, 19, 21, 23, 31, 34 AND 35).

TANYA AMOS, EXAMINING ATTORNEY

CLASS 7—(Continued).

SN 78-459,776. FLEXICON CORPORATION, BETHLEHEM, PA. FILED 7-30-2004.

CLASS 7—(Continued).

SN 78-598,802. A. L. LEE CORPORATION, LESTER, WV. FILED 3-31-2005.

FLOW-FLEXER

THE MARK CONSISTS OF STANDARD CHARACTERS WITHOUT CLAIM TO ANY PARTICULAR FONT, STYLE, SIZE, OR COLOR.

FOR MACHINERY, NAMELY, BULK BAG DISCHARGE MACHINES COMPRISED OF PLATES THAT RAISE AND LOWER THE EDGES OF BULK BAGS TO PROMOTE THE UNLOADING OF BULK BAGS (U.S. CLS. 13, 19, 21, 23, 31, 34 AND 35).

FIRST USE 1-1-1992; IN COMMERCE 1-1-1992.
DAVID TAYLOR, EXAMINING ATTORNEY

CRAWLER-VEYOR

THE MARK CONSISTS OF STANDARD CHARACTERS WITHOUT CLAIM TO ANY PARTICULAR FONT, STYLE, SIZE, OR COLOR.

FOR CONTINUOUS HAULAGE SYSTEMS COMPRISED OF MOBILE MATERIALS HANDLING, CONVEYING AND TRAMMING EQUIPMENT FOR USE IN UNDERGROUND AND SURFACE MINING OPERATIONS, NAMELY, PORTABLE MACHINES FOR CONVEYING COAL, ORE AND SOLIDS (U.S. CLS. 13, 19, 21, 23, 31, 34 AND 35).

SUNG IN, EXAMINING ATTORNEY

SN 78-489,748. BSH BOSCH UND SIEMENS HAUSGERAETE GMBH, MUNICH, FED REP GERMANY, FILED 9-27-2004.

SN 78-613,643. CARDINAL SAWS & BLADES, INC., CON-SHOHOCKEN, PA. FILED 4-21-2005.

cruiser-iq

THE MARK CONSISTS OF STANDARD CHARACTERS WITHOUT CLAIM TO ANY PARTICULAR FONT, STYLE, SIZE, OR COLOR.

PRIORITY CLAIMED UNDER SEC. 44(D) ON FED REP GERMANY APPLICATION NO. 30422781107, FILED 4-22-2004, REG. NO. 30422781, DATED 5-17-2004, EXPIRES 4-30-2014.

FOR VACUUM CLEANERS, NAMELY, ROBOTIC VACUUM CLEANERS, AND PARTS THEREFOR, NAMELY, VACUUM CLEANER HOSES, PIPES, DUST FILTERS AND DUST FILTER BAGS (U.S. CLS. 13, 19, 21, 23, 31, 34 AND 35).

MARLENE BELL, EXAMINING ATTORNEY

CARDINAL

THE MARK CONSISTS OF STANDARD CHARACTERS WITHOUT CLAIM TO ANY PARTICULAR FONT, STYLE, SIZE, OR COLOR.

FOR DIAMOND ABRASIVE WHEELS FOR CUTTING AND SHAPING STRESS RELIEF GROOVES IN POURED CONCRETE (U.S. CLS. 13, 19, 21, 23, 31, 34 AND 35).

FIRST USE 1-1-2003; IN COMMERCE 1-1-2003.

JILL C. ALT, EXAMINING ATTORNEY

CLASS 7—(Continued).

SN 78-642,993. COSTEX CORPORATION, MIAMI, FL. FILED 6-3-2005.

Quality with Value Guaranteed

THE MARK CONSISTS OF STANDARD CHARACTERS WITHOUT CLAIM TO ANY PARTICULAR FONT, STYLE, SIZE, OR COLOR.

FOR REPLACEMENT PARTS FOR HEAVY CONSTRUCTION EQUIPMENT, NAMELY, ENGINE CAMSHAFTS, DIESEL ENGINE HEATING PLUGS, ENGINE BEARINGS, ENGINE MUFFLERS, ENGINE PARTS, NAMELY, CONTACT POINTS, ENGINE RODS, ENGINE TIMING COMPONENTS, NAMELY CAM SPROCKETS AND CHAINS, FUEL FILTERS, GASKETS FOR INTERNAL COMBUSTION ENGINES, INTERNAL COMBUSTION ENGINE PARTS, NAMELY PISTONS, PISTON RINGS, CONNECTING RODS AND CYLINDER LINERS, MACHINE PARTS NAMELY, BEARINGS AND BUSHINGS, ROLLER BEARINGS, FUEL INJECTOR NOZZLES, MECHANICAL SEALS, VALVES BEING PARTS OF HEAVY CONSTRUCTION MACHINES, TURBOCHARGERS FOR MACHINES, OIL FILTERS FOR MOTORS AND ENGINES, AND AIR FILTERS FOR MECHANICAL PURPOSES (U.S. CLS. 13, 19, 21, 23, 31, 34 AND 35).

FIRST USE 1-1-1998; IN COMMERCE 1-28-1998.
AMY HELLA, EXAMINING ATTORNEY

SN 78-665,720. MKR GROUP, LLC, RICHLAND, MI. FILED 7-7-2005.

QuickTime Trimmer

THE MARK CONSISTS OF STANDARD CHARACTERS WITHOUT CLAIM TO ANY PARTICULAR FONT, STYLE, SIZE, OR COLOR.

NO CLAIM IS MADE TO THE EXCLUSIVE RIGHT TO USE "TRIMMER", APART FROM THE MARK AS SHOWN. FOR POWER OPERATED GRASS / WEED TRIMMER (U.S. CLS. 13, 19, 21, 23, 31, 34 AND 35).

FIRST USE 7-6-2005; IN COMMERCE 7-6-2005.
ANNE FARRELL, EXAMINING ATTORNEY

CLASS 7—(Continued).

SN 78-666,521. EAGLE CRUSHER COMPANY, INCORPORATED, GALION, OH. FILED 7-8-2005.

EAGLE

THE MARK CONSISTS OF STANDARD CHARACTERS WITHOUT CLAIM TO ANY PARTICULAR FONT, STYLE, SIZE, OR COLOR.

FOR QUARRY, MINING AND MINERAL PROCESSING MACHINERY FOR USE IN SIZE REDUCTION OF ASPHALT, STEEL-REINFORCED CONCRETE, STONE AND CONSTRUCTION AND DEMOLITION DEBRIS, NAMELY, CRUSHERS, PULVERIZERS, IMPACT BREAKERS, HAMMERMILLS, DISINTEGRATING MILLS, VIBRATING AND REVOLVING SCREENS AND CONVEYORS (U.S. CLS. 13, 19, 21, 23, 31, 34 AND 35).

FIRST USE 9-28-1965; IN COMMERCE 9-28-1965.
ATTIYA MALIK, EXAMINING ATTORNEY

SN 78-683,761. LASERCUT, INC., BRANFORD, CT. FILED 8-2-2005.

LASERCUT

THE MARK CONSISTS OF STANDARD CHARACTERS WITHOUT CLAIM TO ANY PARTICULAR FONT, STYLE, SIZE, OR COLOR.

OWNER OF U.S. REG. NO. 1,358,618.
SEC. 2(F).

FOR PROCESSING MACHINE TOOLS USED IN DRILLING, ETCHING, SCRIBING, MARKING, ABRADING, PUNCTURING, PERFORATING, WELDING, ENGRAVING, CLEANING AND MACHINING A VARIETY OF MATERIALS, AND PARTS USED IN SUCH MACHINE TOOLS, NAMELY, POSITIONERS, PALLET CHANGERS/SERVERS, CONTROL BOXES, CHILLERS, ENCLOSURES AND EXHAUST SYSTEMS (U.S. CLS. 13, 19, 21, 23, 31, 34 AND 35).

FIRST USE 10-16-1981; IN COMMERCE 7-14-1983.
MATTHEW MCDOWELL, EXAMINING ATTORNEY

SN 78-689,077. DOALL COMPANY, DES PLAINES, IL. FILED 8-9-2005.

IMPERIAL

THE MARK CONSISTS OF STANDARD CHARACTERS WITHOUT CLAIM TO ANY PARTICULAR FONT, STYLE, SIZE, OR COLOR.

FOR BAND SAW BLADES (U.S. CLS. 13, 19, 21, 23, 31, 34 AND 35).

FIRST USE 0-0-1965; IN COMMERCE 0-0-1965.
MARC LEIPZIG, EXAMINING ATTORNEY

CLASS 7—(Continued).

SN 78-701,269. HAMILTON SAFE COMPANY, FAIRFIELD, OH. FILED 8-26-2005.

HAMILTON AIR

THE MARK CONSISTS OF STANDARD CHARACTERS WITHOUT CLAIM TO ANY PARTICULAR FONT, STYLE, SIZE, OR COLOR.

NO CLAIM IS MADE TO THE EXCLUSIVE RIGHT TO USE "AIR", APART FROM THE MARK AS SHOWN.

FOR PNEUMATIC TUBE SYSTEM CONSISTING OF CARRIER TERMINAL STATIONS, PNEUMATIC INTERCONNECTING TUBING, PNEUMATIC ENGINES, CARRIERS, AND ELECTRONIC CONTROLS THEREFORE FOR TRANSPORTING HEAVY LOADS AND VALUABLES; PNEUMATIC TUBE DRIVE UP SYSTEMS CONSISTING OF CARRIER TERMINAL STATIONS, PNEUMATIC INTERCONNECTING TUBING, PNEUMATIC ENGINES, CARRIERS, AND ELECTRONIC CONTROLS THEREFORE; PNEUMATIC TUBE COURIER SYSTEMS CONSISTING OF CARRIER TERMINAL STATIONS, PNEUMATIC INTERCONNECTING TUBING, PNEUMATIC ENGINES, CARRIERS, AND ELECTRONIC CONTROLS THEREFORE; PNEUMATIC TRANSPORTERS CONSISTING OF CARRIER TERMINAL STATIONS, PNEUMATIC INTERCONNECTING TUBING, PNEUMATIC ENGINES, CARRIERS, AND ELECTRONIC CONTROLS THEREFORE; PNEUMATIC TUBE COURIERS CONSISTING OF CARRIER TERMINAL STATIONS, PNEUMATIC INTERCONNECTING TUBING, PNEUMATIC ENGINES, CARRIERS, AND ELECTRONIC CONTROLS THEREFORE FOR USE IN BANKS, FINANCIAL INSTITUTIONS, PHARMACIES, STORES, CASINOS, RACE TRACKS, FACTORIES, OFFICES, HOSPITALS, BROKERAGE FIRMS, MEDICAL LABS AND WAREHOUSES; AND PNEUMATIC ENGINES (U.S. CLS. 13, 19, 21, 23, 31, 34 AND 35).
FIRST USE 5-0-1972; IN COMMERCE 5-0-1972.
CHRIS WELLS, EXAMINING ATTORNEY

SN 78-703,635. EBARA CORPORATION, TOKYO, JAPAN, FILED 8-30-2005.



OWNER OF JAPAN REG. NO. 4056183, DATED 9-12-1997, EXPIRES 9-12-2017.
OWNER OF U.S. REG. NO. 2,267,988.
FOR ELECTRIC PUMPS (U.S. CLS. 13, 19, 21, 23, 31, 34 AND 35).
CIMMERIAN COLEMAN, EXAMINING ATTORNEY

CLASS 7—(Continued).

SN 78-705,018. ACTION SUPER ABRASIVE PRODUCTS, INC., BRIMFIELD, OH. FILED 9-1-2005.



THE MARK CONSISTS OF ASA DIAMOND SHAPE.
FOR ABRASIVE DISKS FOR POWER-OPERATED GRINDERS; ABRASIVE WHEELS FOR POWER-OPERATED GRINDERS; POWER-OPERATED GRINDING WHEELS (U.S. CLS. 13, 19, 21, 23, 31, 34 AND 35).
FIRST USE 6-1-1985; IN COMMERCE 6-1-1985.
TOBY BULLOFF, EXAMINING ATTORNEY

SN 78-707,498. WORLDWIDE ELECTRIC CORPORATION, PITTSFORD, NY. FILED 9-6-2005.

The Gear Zone

THE MARK CONSISTS OF STANDARD CHARACTERS WITHOUT CLAIM TO ANY PARTICULAR FONT, STYLE, SIZE, OR COLOR.

NO CLAIM IS MADE TO THE EXCLUSIVE RIGHT TO USE "GEAR", APART FROM THE MARK AS SHOWN.

FOR ENCLOSED DRIVES FOR INDUSTRIAL MACHINERY; MACHINE PARTS, NAMELY BUSHINGS, MOTOR MOUNTS, AND MOUNTING BASES FOR MACHINES, MOTORS AND ENGINES USED IN INDUSTRIAL APPLICATIONS; BACK STOPS, NAMELY CLUTCHES USED ON GEAR DRIVES FOR MOTORS AND ENGINES USED IN INDUSTRIAL APPLICATIONS; AND TORQUE ARMS NAMELY STABILIZERS FOR GEARS USED IN INDUSTRIAL APPLICATIONS (U.S. CLS. 13, 19, 21, 23, 31, 34 AND 35).
ANDREA K. NADELMAN, EXAMINING ATTORNEY

CLASS 7—(Continued).

SN 78-714,447. WAGNER SPRAY TECH CORPORATION, PLYMOUTH, MN. FILED 9-16-2005.



FOR TOOL-LESS INTERLOCK SOLD AS A FEATURE OF PAINT SPRAYERS (U.S. CLS. 13, 19, 21, 23, 31, 34 AND 35).

FIRST USE 1-1-2005; IN COMMERCE 1-1-2004.
TONI HICKEY, EXAMINING ATTORNEY

SN 78-730,970. TAKWA COMPANY, RIYADH, SAUDI ARABIA, FILED 10-11-2005.



OWNER OF U.S. REG. NO. 3,049,302.
NO CLAIM IS MADE TO THE EXCLUSIVE RIGHT TO USE "US POINT", APART FROM THE MARK AS SHOWN. THE COLOR(S) GRAY, BLACK, GREEN AND WHITE IS/ARE CLAIMED AS A FEATURE OF THE MARK.

THE LETTERS US APPEAR IN GRAY SUPERIMPOSED OVER A GREEN CIRCLE WITH WHITE HIGHLIGHTING. THE WORD POINT IS IN BLACK.

FOR OIL, GAS AND AIR FILTERS FOR MOTORS AND ENGINES; OIL PUMPS FOR USE IN ENGINES AND MOTORS; PUMPS FOR COOLING ENGINES; WATER PUMPS FOR USE IN MOTORS AND ENGINES; COOLING RADIATORS FOR MOTORS AND ENGINES; DYNAMOS; STARTERS FOR MOTORS AND ENGINES; IGNITION DEVICES FOR INTERNAL COMBUSTION ENGINES; FUEL INJECTORS FOR LAND VEHICLE ENGINES AND REPLACEMENT PARTS THEREFOR; INTERNAL COMBUSTION ENGINE PARTS, NAMELY, CYLINDERS (U.S. CLS. 13, 19, 21, 23, 31, 34 AND 35).

STEVEN PEREZ, EXAMINING ATTORNEY

CLASS 7—(Continued).

SN 78-732,540. DR. SCHNABEL GMBH & CO. KG, D-65549 LIMBURG/LAHN, FED REP GERMANY, FILED 10-13-2005.

FLUROSIC

THE MARK CONSISTS OF STANDARD CHARACTERS WITHOUT CLAIM TO ANY PARTICULAR FONT, STYLE, SIZE, OR COLOR.

FOR HEAT EXCHANGERS BEING PARTS OF MACHINES (U.S. CLS. 13, 19, 21, 23, 31, 34 AND 35).

FIRST USE 1-11-2000; IN COMMERCE 1-11-2000.
FRED CARL, EXAMINING ATTORNEY

SN 78-746,034. FARADYNE MOTORS LLC, NEWARK, NY. FILED 11-3-2005.

FARADYNE MOTORS

THE MARK CONSISTS OF STANDARD CHARACTERS WITHOUT CLAIM TO ANY PARTICULAR FONT, STYLE, SIZE, OR COLOR.

NO CLAIM IS MADE TO THE EXCLUSIVE RIGHT TO USE "MOTORS", APART FROM THE MARK AS SHOWN.

FOR ELECTRIC MOTORS FOR PUMPS AND SUBMERSIBLE ELECTRIC MOTORS FOR MACHINES (U.S. CLS. 13, 19, 21, 23, 31, 34 AND 35).

GINA FINK, EXAMINING ATTORNEY

SN 78-751,974. BISSELL HOMECARE, INC., GRAND RAPIDS, MI. FILED 11-11-2005.

TOTAL FLOORS

THE MARK CONSISTS OF STANDARD CHARACTERS WITHOUT CLAIM TO ANY PARTICULAR FONT, STYLE, SIZE, OR COLOR.

NO CLAIM IS MADE TO THE EXCLUSIVE RIGHT TO USE "FLOORS", APART FROM THE MARK AS SHOWN.

FOR VACUUM CLEANERS (U.S. CLS. 13, 19, 21, 23, 31, 34 AND 35).

AMEETA JORDAN, EXAMINING ATTORNEY

CLASS 7—(Continued).

SN 78-753,433. CARLISLE INTANGIBLE COMPANY, SYRACUSE, NY. FILED 11-14-2005.

CARLISLE

THE MARK CONSISTS OF STANDARD CHARACTERS WITHOUT CLAIM TO ANY PARTICULAR FONT, STYLE, SIZE, OR COLOR.

OWNER OF U.S. REG. NOS. 1,090,880, 2,348,300 AND OTHERS.

FOR POWER TRANSMISSION BELTS FOR MACHINES, MOTORS AND ENGINES USED IN INDUSTRIAL APPLICATIONS (U.S. CLS. 13, 19, 21, 23, 31, 34 AND 35).

FIRST USE 8-0-2001; IN COMMERCE 8-0-2001.
DAVID YONTEF, EXAMINING ATTORNEY

CLASS 7—(Continued).

SN 78-809,623. RBC BEARINGS INC., OXFORD, CT. FILED 2-8-2006.

SPHERCO

THE MARK CONSISTS OF STANDARD CHARACTERS WITHOUT CLAIM TO ANY PARTICULAR FONT, STYLE, SIZE, OR COLOR.

FOR SELF-ALIGNING SPHERICAL BEARINGS AND SELF-ALIGNING SPHERICAL ROD-END BEARINGS FOR MACHINES (U.S. CLS. 13, 19, 21, 23, 31, 34 AND 35).

FIRST USE 4-27-1953; IN COMMERCE 5-11-1953.
KAREN K. BUSH, EXAMINING ATTORNEY

SN 78-780,913. SCHRAMM, INC., WEST CHESTER, PA. FILED 12-27-2005.

I-CONTROL

THE MARK CONSISTS OF STANDARD CHARACTERS WITHOUT CLAIM TO ANY PARTICULAR FONT, STYLE, SIZE, OR COLOR.

FOR ELECTRONIC CONTROLS AND MONITORS FOR CONTROLLING AND MONITORING THE OPERATION AND PERFORMANCE OF DRILL RIGS, SOLD AS COMPONENTS OF DRILL RIGS FOR EARTH DRILLING (U.S. CLS. 13, 19, 21, 23, 31, 34 AND 35).

MARLENE BELL, EXAMINING ATTORNEY

SN 78-809,872. CRICKET PRODUCTIONS INC., MARLBORO, MA. FILED 2-8-2006.

ONE TOUCH CAN OPENER

THE MARK CONSISTS OF STANDARD CHARACTERS WITHOUT CLAIM TO ANY PARTICULAR FONT, STYLE, SIZE, OR COLOR.

NO CLAIM IS MADE TO THE EXCLUSIVE RIGHT TO USE "CAN OPENER", APART FROM THE MARK AS SHOWN.

FOR HANDS FREE BATTERY OPERATED CAN OPENER (U.S. CLS. 13, 19, 21, 23, 31, 34 AND 35).

JENNIFER KRISP, EXAMINING ATTORNEY

SN 78-787,391. CYCLO TOOLMAKERS, INC., LONGMONT, CO. FILED 1-9-2006.



NO CLAIM IS MADE TO THE EXCLUSIVE RIGHT TO USE "TOOLMAKERS INCORPORATED", APART FROM THE MARK AS SHOWN.

THE MARK CONSISTS OF TWO OVALS WITH THE WORDS THEREIN.

FOR ELECTRIC AND AIR POWERED POLISHERS AND ACCESSORIES THEREFOR, NAMELY, FOAM PADS, WOOL PADS, FAST CUT PADS, PAD COVERS AND BRUSHES (U.S. CLS. 13, 19, 21, 23, 31, 34 AND 35).

FIRST USE 1-1-2003; IN COMMERCE 1-1-2003.
AMY MCMENAMIN, EXAMINING ATTORNEY

SN 78-810,756. MCKAY ACQUISITION, INC., BETTENDORF, IA. FILED 2-9-2006.

JANCY

THE MARK CONSISTS OF STANDARD CHARACTERS WITHOUT CLAIM TO ANY PARTICULAR FONT, STYLE, SIZE, OR COLOR.

OWNER OF U.S. REG. NOS. 2,332,108 AND 2,706,732.

FOR MACHINERY, NAMELY, MAGNETIC STAND DRILLS, METAL CUTTING SAWS, PIPE AND TUBE BENDERS, PIPE AND TUBE NOTCHERS, BELT GRINDERS, BAND SAWS, COLD SAWS, SHEARS, WELDING POSITIONERS, PUNCHES, ANNULAR CUTTERS, AND SHEET METAL CUTTERS (U.S. CLS. 13, 19, 21, 23, 31, 34 AND 35).

FIRST USE 0-0-1977; IN COMMERCE 0-0-1977.
ELLEN PERKINS, EXAMINING ATTORNEY

CLASS 7—(Continued).

SN 78-818,929. FINISH THOMPSON, INC., ERIE, PA. FILED 2-20-2006.

Finish Thompson

THE MARK CONSISTS OF STANDARD CHARACTERS WITHOUT CLAIM TO ANY PARTICULAR FONT, STYLE, SIZE, OR COLOR.

FOR CENTRIFUGAL PUMPS; COMPRESSED AIR PUMPS; ELECTRIC PUMPS (U.S. CLS. 13, 19, 21, 23, 31, 34 AND 35).

FIRST USE 9-1-1990; IN COMMERCE 10-1-1990.
JAY BESCH, EXAMINING ATTORNEY

CLASS 7—(Continued).

SN 78-844,780. MANSFIELD POWER TOOLS A/S, ROENDE, DENMARK, FILED 3-23-2006.

Dual-Drill

THE MARK CONSISTS OF STANDARD CHARACTERS WITHOUT CLAIM TO ANY PARTICULAR FONT, STYLE, SIZE, OR COLOR.

FOR ELECTRIC POWER TOOLS, NAMELY, POWER DRILLS (U.S. CLS. 13, 19, 21, 23, 31, 34 AND 35).

FIRST USE 10-0-2005; IN COMMERCE 10-0-2005.
FRED CARL, EXAMINING ATTORNEY

SN 78-829,100. VELOCITY TOOLS, INC., GRAND RAPIDS, MI. FILED 3-3-2006.

**VELOCITY
VELOCITY**
HI-PERFORMANCE TOOLING

NO CLAIM IS MADE TO THE EXCLUSIVE RIGHT TO USE "HI-PERFORMANCE TOOLING", APART FROM THE MARK AS SHOWN.

FOR POWER-OPERATED CUTTING TOOLS FOR INDUSTRIAL USE (U.S. CLS. 13, 19, 21, 23, 31, 34 AND 35).

FIRST USE 10-0-1999; IN COMMERCE 10-0-1999.
KIMBERLY FRYE, EXAMINING ATTORNEY

SN 78-846,480. CRANE PUMPS & SYSTEMS, INC., PIQUA, OH. FILED 3-27-2006.

burks pumps

NO CLAIM IS MADE TO THE EXCLUSIVE RIGHT TO USE "PUMPS", APART FROM THE MARK AS SHOWN.

THE MARK CONSISTS OF THE LETTERS B AND P MERGED TOGETHER AND THE WORDS BURKS PUMPS. FOR CENTRIFUGAL PUMPS; ELECTRIC PUMPS (U.S. CLS. 13, 19, 21, 23, 31, 34 AND 35).

FIRST USE 1-1-1970; IN COMMERCE 1-1-1970.
ALLISON SCHRODY, EXAMINING ATTORNEY

SN 78-841,479. ATMAX EQUIPMENT CO., WIMAUMA, FL. FILED 3-20-2006.

BUMPERBUDDY

THE MARK CONSISTS OF STANDARD CHARACTERS WITHOUT CLAIM TO ANY PARTICULAR FONT, STYLE, SIZE, OR COLOR.

FOR POWER-OPERATED LIFTING AND MOVING EQUIPMENT, NAMELY, FORK LIFTS WHICH ARE TRUCK MOUNTED (U.S. CLS. 13, 19, 21, 23, 31, 34 AND 35).

FIRST USE 1-10-2006; IN COMMERCE 1-10-2006.
SANI KHOURI, EXAMINING ATTORNEY

SN 78-846,660. ELECTRIC MOBILITY CORPORATION, SEWELL, NJ. FILED 3-27-2006.

Rack 'N Roll

THE MARK CONSISTS OF STANDARD CHARACTERS WITHOUT CLAIM TO ANY PARTICULAR FONT, STYLE, SIZE, OR COLOR.

FOR POWER-OPERATED LIFTS FOR MOVING, PARKING AND STORING WHEELCHAIRS, POWER CHAIRS AND MOTORIZED SCOOTERS (U.S. CLS. 13, 19, 21, 23, 31, 34 AND 35).

FIRST USE 2-10-1986; IN COMMERCE 2-10-1986.
KATHERINE STOIDES, EXAMINING ATTORNEY

CLASS 7—(Continued).

SN 78-852,564. YAMADA MANUFACTURING CO., LTD., KIRYU-SHI, JAPAN, FILED 4-3-2006.



THE MARK CONSISTS OF THE LETTERS YNA. FOR CENTRIFUGAL PUMPS, ROTARY PUMPS (U.S. CLS. 13, 19, 21, 23, 31, 34 AND 35). FIRST USE 10-9-2003; IN COMMERCE 10-9-2003. THEODORE MCBRIDE, EXAMINING ATTORNEY

SN 78-854,264. LANOIE, RUSSELL H., CONWAY, NH. FILED 4-5-2006.

FRONT RUNNER

THE MARK CONSISTS OF STANDARD CHARACTERS WITHOUT CLAIM TO ANY PARTICULAR FONT, STYLE, SIZE, OR COLOR.

FOR ATTACHMENTS FOR POWERED LAND VEHICLES, NAMELY, UNPOWERED RAKES (U.S. CLS. 13, 19, 21, 23, 31, 34 AND 35).

FIRST USE 3-28-1990; IN COMMERCE 3-28-1990. CHRISTOPHER OTT, EXAMINING ATTORNEY

SN 78-854,849. RC IMPORTS, SAN JOSE, CA. FILED 4-5-2006.

Team Line

THE MARK CONSISTS OF STANDARD CHARACTERS WITHOUT CLAIM TO ANY PARTICULAR FONT, STYLE, SIZE, OR COLOR.

NO CLAIM IS MADE TO THE EXCLUSIVE RIGHT TO USE "LINE", APART FROM THE MARK AS SHOWN.

FOR INTERNAL COMBUSTION ENGINES FOR REMOTE CONTROLLED CARS (U.S. CLS. 13, 19, 21, 23, 31, 34 AND 35).

MICHAEL WIENER, EXAMINING ATTORNEY

CLASS 7—(Continued).

SN 78-855,295. INVISION PRODUCTS, LLC, FALL RIVER, MA. FILED 4-6-2006.

FRESHSTATION

THE MARK CONSISTS OF STANDARD CHARACTERS WITHOUT CLAIM TO ANY PARTICULAR FONT, STYLE, SIZE, OR COLOR.

FOR VACUUM PACKAGING MACHINE AND PARTS THEREFORE (U.S. CLS. 13, 19, 21, 23, 31, 34 AND 35).

SANI KHOURI, EXAMINING ATTORNEY

SN 78-858,197. ERMAKSAN MAKINA SANAYI VE TICARET LIMITED SIRKETI, BURSA, TURKEY, FILED 4-10-2006.



THE COLOR(S) RED AND BLUE IS/ARE CLAIMED AS A FEATURE OF THE MARK.

THE MARK CONSISTS OF THE COLOR RED APPEARING IN THE TRIANGLE. THE COLOR BLUE APPEARS IN THE WORDING ERMAK.

FOR HYDRAULIC PRESSES FOR METALWORKING, MECHANICAL PRESSES FOR METALWORKING, METAL EXTRUSION PRESSES, PUNCHING PRESSES FOR METALWORKING, INDUSTRIAL MACHINE PRESSES, CUTTING MACHINES FOR METALWORKING, GEAR CUTTING AND FINISHING MACHINES, BENDING MACHINES FOR METALWORKING, MILLING MACHINES FOR METALWORKING, GRINDING MACHINES FOR METALWORKING, DRILLING MACHINES FOR METALWORKING, ELECTRIC WELDING MACHINES, GAS-OPERATED WELDING MACHINES; MACHINES AND MACHINE TOOLS FOR THE CUTTING AND FORMING OF MATERIALS, NAMELY, WIRE FORMING MACHINES, RUBBER FORMING MACHINES, INJECTION PLASTIC MOLDING MACHINES; ELECTRIC LATHES, ELECTRIC PLANERS, CHAIN SAWS, ELECTRIC CIRCULAR SAWS, ELECTRIC SANDERS (U.S. CLS. 13, 19, 21, 23, 31, 34 AND 35).

FIRST USE 11-14-1997; IN COMMERCE 2-5-1999.

KATHERINE CONNOLLY, EXAMINING ATTORNEY

CLASS 7—(Continued).

SN 78-860,431. GALE BANKS ENGINEERING, AZUSA, CA.
FILED 4-12-2006.

POWER ELBOW

THE MARK CONSISTS OF STANDARD CHARACTERS WITHOUT CLAIM TO ANY PARTICULAR FONT, STYLE, SIZE, OR COLOR.

NO CLAIM IS MADE TO THE EXCLUSIVE RIGHT TO USE "ELBOW", APART FROM THE MARK AS SHOWN, FOR EXHAUST ELBOWS FOR LAND VEHICLES (U.S. CLS. 13, 19, 21, 23, 31, 34 AND 35).

FIRST USE 8-31-2002; IN COMMERCE 9-30-2002.
GEOFFREY FOSDICK, EXAMINING ATTORNEY

SN 78-860,584. PRO-TECH MANUFACTURING AND DISTRIBUTION, INC., ROCHESTER, NY. FILED 4-13-2006.

SWITCHBLADE

THE MARK CONSISTS OF STANDARD CHARACTERS WITHOUT CLAIM TO ANY PARTICULAR FONT, STYLE, SIZE, OR COLOR.

FOR PLOWS, SNOW PLOWS, AND PLOW BLADES (U.S. CLS. 13, 19, 21, 23, 31, 34 AND 35).

JOHN LINCOSKI, EXAMINING ATTORNEY

SN 78-860,597. PRO-TECH MANUFACTURING AND DISTRIBUTION, INC., ROCHESTER, NY. FILED 4-13-2006.

IST

THE MARK CONSISTS OF STANDARD CHARACTERS WITHOUT CLAIM TO ANY PARTICULAR FONT, STYLE, SIZE, OR COLOR.

FOR PLOWS, SNOW PLOWS, AND PLOW BLADES (U.S. CLS. 13, 19, 21, 23, 31, 34 AND 35).

JOHN LINCOSKI, EXAMINING ATTORNEY

CLASS 7—(Continued).

SN 78-860,738. HANDI QUILTER, LLC, BOUNTIFUL, UT.
FILED 4-13-2006.

SIMPLY-SIXTEEN

THE MARK CONSISTS OF STANDARD CHARACTERS WITHOUT CLAIM TO ANY PARTICULAR FONT, STYLE, SIZE, OR COLOR.

FOR PORTABLE SEWING MACHINE DESIGNED FOR QUILTING (U.S. CLS. 13, 19, 21, 23, 31, 34 AND 35).

SALLY SHIH, EXAMINING ATTORNEY

SN 78-861,226. CONTAINER HANDLING SOLUTIONS, INC., ROCHELLE, IL. FILED 4-13-2006.

SWING THRU

THE MARK CONSISTS OF STANDARD CHARACTERS WITHOUT CLAIM TO ANY PARTICULAR FONT, STYLE, SIZE, OR COLOR.

FOR CONTAINER HANDLING SYSTEMS FOR VEHICLES, COMPRISING HYDRAULIC RAMS AND A LIFT BOOM FOR LOADING AND UNLOADING LARGE FREIGHT CONTAINERS ON AND OFF VEHICLES; AND STRUCTURAL PARTS THEREOF (U.S. CLS. 13, 19, 21, 23, 31, 34 AND 35).

FIRST USE 9-16-1998; IN COMMERCE 9-29-2000.

GILBERT SWIFT, EXAMINING ATTORNEY

SN 78-862,991. PER-FIL INDUSTRIES, INC., RIVERSIDE, NJ.
FILED 4-17-2006.

ROTARY-RECHARGER

THE MARK CONSISTS OF STANDARD CHARACTERS WITHOUT CLAIM TO ANY PARTICULAR FONT, STYLE, SIZE, OR COLOR.

OWNER OF U.S. REG. NO. 2,392,387.
SEC. 2(F).
FOR INK CARTRIDGE CLEANING AND FILLING MACHINES (U.S. CLS. 13, 19, 21, 23, 31, 34 AND 35).

FIRST USE 9-22-1997; IN COMMERCE 9-22-1997.

KAREN BRACEY, EXAMINING ATTORNEY

CLASS 7—(Continued).

SN 78-864,491. TENNANT COMPANY, MINNEAPOLIS, MN. FILED 4-19-2006.

STRIVE

THE MARK CONSISTS OF STANDARD CHARACTERS WITHOUT CLAIM TO ANY PARTICULAR FONT, STYLE, SIZE, OR COLOR.

FOR FLOOR MAINTENANCE EQUIPMENT, NAMELY, CARPET CLEANING MACHINES (U.S. CLS. 13, 19, 21, 23, 31, 34 AND 35).

FIRST USE 8-23-2004; IN COMMERCE 8-23-2004.
CAROLYN CATALDO, EXAMINING ATTORNEY

SN 78-865,564. TOWNLEY ENGINEERING AND MANUFACTURING COMPANY, INC., CANDLER, FL. FILED 4-20-2006.

PEAK-FLO

THE MARK CONSISTS OF STANDARD CHARACTERS WITHOUT CLAIM TO ANY PARTICULAR FONT, STYLE, SIZE, OR COLOR.

FOR PUMPS, VALVES, COUPLINGS, PIPES, PUMP LINERS, PUMP SUCTION PORTS, IMPELLERS, VANES AND REPLACEMENT PARTS THEREOF, ALL OF THE ABOVE BEING PARTS OF MACHINES USED FOR MINERAL PROCESSING AND THE HYDRO-TRANSPORT OF SLURRY (U.S. CLS. 13, 19, 21, 23, 31, 34 AND 35).

MARY MUNSON, EXAMINING ATTORNEY

SN 78-865,614. TOWNLEY ENGINEERING AND MANUFACTURING COMPANY, INC., CANDLER, FL. FILED 4-20-2006.

MAXPEAK

THE MARK CONSISTS OF STANDARD CHARACTERS WITHOUT CLAIM TO ANY PARTICULAR FONT, STYLE, SIZE, OR COLOR.

FOR PUMPS, VALVES, COUPLINGS, PIPES, PUMP LINERS, PUMP SUCTION PORTS, IMPELLERS, VANES AND REPLACEMENT PARTS THEREOF, ALL OF THE ABOVE BEING PARTS OF MACHINES USED FOR MINERAL PROCESSING AND THE HYDRO-TRANSPORT OF SLURRY (U.S. CLS. 13, 19, 21, 23, 31, 34 AND 35).

MARY MUNSON, EXAMINING ATTORNEY

CLASS 7—(Continued).

SN 78-865,639. TOWNLEY ENGINEERING AND MANUFACTURING COMPANY, INC., CANDLER, FL. FILED 4-20-2006.

TOWNIMAX

THE MARK CONSISTS OF STANDARD CHARACTERS WITHOUT CLAIM TO ANY PARTICULAR FONT, STYLE, SIZE, OR COLOR.

OWNER OF U.S. REG. NO. 2,228,272.

FOR PUMPS, VALVES, COUPLINGS, PIPES, PUMP LINERS, PUMP SUCTION PORTS, IMPELLERS, VANES AND REPLACEMENT PARTS THEREOF, ALL OF THE ABOVE BEING PARTS OF MACHINES USED FOR MINERAL PROCESSING AND THE HYDRO-TRANSPORT OF SLURRY (U.S. CLS. 13, 19, 21, 23, 31, 34 AND 35).

MARY MUNSON, EXAMINING ATTORNEY

SN 78-865,715. TOWNLEY ENGINEERING AND MANUFACTURING COMPANY, INC., CANDLER, FL. FILED 4-20-2006.

TOWNIFLOW

THE MARK CONSISTS OF STANDARD CHARACTERS WITHOUT CLAIM TO ANY PARTICULAR FONT, STYLE, SIZE, OR COLOR.

OWNER OF U.S. REG. NO. 2,228,272.

FOR PUMPS, VALVES, COUPLINGS, PIPES, PUMP LINERS, PUMP SUCTION PORTS, IMPELLERS, VANES AND REPLACEMENT PARTS THEREOF, ALL OF THE ABOVE BEING PARTS OF MACHINES USED FOR MINERAL PROCESSING AND THE HYDRO-TRANSPORT OF SLURRY (U.S. CLS. 13, 19, 21, 23, 31, 34 AND 35).

MARY MUNSON, EXAMINING ATTORNEY

SN 78-865,745. TOWNLEY ENGINEERING AND MANUFACTURING COMPANY, INC., CANDLER, FL. FILED 4-20-2006.

TOWNIJET

THE MARK CONSISTS OF STANDARD CHARACTERS WITHOUT CLAIM TO ANY PARTICULAR FONT, STYLE, SIZE, OR COLOR.

OWNER OF U.S. REG. NO. 2,228,272.

FOR PUMPS, VALVES, COUPLINGS, PIPES, PUMP LINERS, PUMP SUCTION PORTS, IMPELLERS, VANES AND REPLACEMENT PARTS THEREOF, ALL OF THE ABOVE BEING PARTS OF MACHINES USED FOR MINERAL PROCESSING AND THE HYDRO-TRANSPORT OF SLURRY (U.S. CLS. 13, 19, 21, 23, 31, 34 AND 35).

MARY MUNSON, EXAMINING ATTORNEY

CLASS 7—(Continued).

SN 78-867,709. EMERSON POWER TRANSMISSION ITHACA, INC., ITHACA, NY. FILED 4-24-2006.

ROLLWAY

THE MARK CONSISTS OF STANDARD CHARACTERS WITHOUT CLAIM TO ANY PARTICULAR FONT, STYLE, SIZE, OR COLOR.

OWNER OF U.S. REG. NO. 618,610. FOR MACHINE PARTS, NAMELY, BEARINGS, AND ROLLER BEARINGS (U.S. CLS. 13, 19, 21, 23, 31, 34 AND 35).

FIRST USE 0-0-1908; IN COMMERCE 0-0-1908. JIM RINGLE, EXAMINING ATTORNEY

SN 78-867,765. UNITED ABRASIVES, INC., WILLIMANTIC, CT. FILED 4-24-2006.

OVATION

THE MARK CONSISTS OF STANDARD CHARACTERS WITHOUT CLAIM TO ANY PARTICULAR FONT, STYLE, SIZE, OR COLOR.

FOR HIGH DENSITY ABRASIVE FLAP DISC FOR FERROUS AND NON-FERROUS METALS, FOR GRINDING, BLENDING AND FINISHING, INCLUDING EDGE-BREAKING, DEBURRING AND CONTOURING (U.S. CLS. 13, 19, 21, 23, 31, 34 AND 35).

ANDREA EVANS, EXAMINING ATTORNEY

SN 78-867,820. CRAFFORD-LASERSTAR TECHNOLOGIES CORPORATION, RIVERSIDE, RI. FILED 4-24-2006.



OWNER OF U.S. REG. NOS. 2,311,666 AND 2,617,163. FOR LASER WELDING AND LASER MARKING AND ENGRAVING MACHINES FOR USE IN THE JEWELRY, DENTAL, MEDICAL, MICRO-INDUSTRIAL, TOOL AND DIE, AND INDUSTRIAL TRADES (U.S. CLS. 13, 19, 21, 23, 31, 34 AND 35).

FIRST USE 5-0-2003; IN COMMERCE 5-3-2003. CHRISTOPHER BUONGIORNO, EXAMINING ATTORNEY

CLASS 7—(Continued).

SN 78-867,971. CRAFFORD-LASERSTAR TECHNOLOGIES CORPORATION, RIVERSIDE, RI. FILED 4-24-2006.



OWNER OF U.S. REG. NOS. 2,311,666 AND 2,617,163. FOR LASER WELDING AND LASER MARKING AND ENGRAVING MACHINES FOR USE IN THE JEWELRY, DENTAL, MEDICAL, MICRO-INDUSTRIAL, TOOL AND DIE, AND INDUSTRIAL TRADES (U.S. CLS. 13, 19, 21, 23, 31, 34 AND 35).

FIRST USE 1-0-2006; IN COMMERCE 1-0-2006. CHRISTOPHER BUONGIORNO, EXAMINING ATTORNEY

SN 78-868,027. CRAFFORD-LASERSTAR TECHNOLOGIES CORPORATION, RIVERSIDE, RI. FILED 4-24-2006.



OWNER OF U.S. REG. NOS. 2,311,666 AND 2,617,163. FOR LASER WELDING AND LASER MARKING AND ENGRAVING MACHINES FOR USE IN THE JEWELRY, DENTAL, MEDICAL, MICRO-INDUSTRIAL, TOOL AND DIE, AND INDUSTRIAL TRADES (U.S. CLS. 13, 19, 21, 23, 31, 34 AND 35).

FIRST USE 1-0-2006; IN COMMERCE 1-0-2006. CHRISTOPHER BUONGIORNO, EXAMINING ATTORNEY

SN 78-868,905. MOGAS INDUSTRIES, INC., HOUSTON, TX. FILED 4-25-2006.

FLEXSTREAM

THE MARK CONSISTS OF STANDARD CHARACTERS WITHOUT CLAIM TO ANY PARTICULAR FONT, STYLE, SIZE, OR COLOR.

FOR BALL VALVES USED FOR POWER, PETROLEUM AND CHEMICAL MACHINERY (U.S. CLS. 13, 19, 21, 23, 31, 34 AND 35).

ANNE E. GUSTASON, EXAMINING ATTORNEY

CLASS 7—(Continued).

SN 78-868,977. PARCO, DANIELLE M, FLUSHING, NY.
FILED 4-25-2006.

danigirl

THE MARK CONSISTS OF STANDARD CHARACTERS WITHOUT CLAIM TO ANY PARTICULAR FONT, STYLE, SIZE, OR COLOR.

FOR CLOTHES WASHING MACHINES (U.S. CLS. 13, 19, 21, 23, 31, 34 AND 35).
NAKIA HENRY, EXAMINING ATTORNEY

CLASS 7—(Continued).

SN 78-877,213. CONAIR CORPORATION, STAMFORD, CT.
FILED 5-5-2006.

EXPRESS PREP

THE MARK CONSISTS OF STANDARD CHARACTERS WITHOUT CLAIM TO ANY PARTICULAR FONT, STYLE, SIZE, OR COLOR.

FOR ELECTRIC FOOD BLENDERS; ELECTRIC FOOD CHOPPERS; ELECTRIC FOOD PROCESSORS; ELECTRIC FOOD SLICERS (U.S. CLS. 13, 19, 21, 23, 31, 34 AND 35).
SCOTT SISUN, EXAMINING ATTORNEY

SN 78-874,588. HYDRA-PRO, INC., SEATTLE, WA. FILED 5-2-2006.

HYDRA PRO

THE MARK CONSISTS OF STANDARD CHARACTERS WITHOUT CLAIM TO ANY PARTICULAR FONT, STYLE, SIZE, OR COLOR.

FOR CRANES, MARINE CRANES AND PARTS THEREFOR (U.S. CLS. 13, 19, 21, 23, 31, 34 AND 35).
FIRST USE 0-0-1992; IN COMMERCE 0-0-1992.
KIMBERLY PERRY, EXAMINING ATTORNEY

SN 78-880,032. HOMELAND HOUSEWARES, LLC, SHERMAN OAKS, CA. FILED 5-9-2006.

Blender To Go

THE MARK CONSISTS OF STANDARD CHARACTERS WITHOUT CLAIM TO ANY PARTICULAR FONT, STYLE, SIZE, OR COLOR.

NO CLAIM IS MADE TO THE EXCLUSIVE RIGHT TO USE "BLENDER", APART FROM THE MARK AS SHOWN.
FOR ELECTRONIC APPLIANCES, NAMELY, KITCHEN FOOD PROCESSORS AND BLENDERS (U.S. CLS. 13, 19, 21, 23, 31, 34 AND 35).
DEZMONA MIZELLE, EXAMINING ATTORNEY

SN 78-874,841. CUSTOM HYDRAULIC AND MACHINE, INC., KENT, WA. FILED 5-2-2006.

CMC

THE MARK CONSISTS OF STANDARD CHARACTERS WITHOUT CLAIM TO ANY PARTICULAR FONT, STYLE, SIZE, OR COLOR.

FOR MACHINE PARTS, NAMELY HYDRAULIC FITTINGS AND HOSE ASSEMBLIES (U.S. CLS. 13, 19, 21, 23, 31, 34 AND 35).
FIRST USE 12-31-1967; IN COMMERCE 12-31-1967.
GEORGE LORENZO, EXAMINING ATTORNEY

SN 78-884,432. HORIZON HOBBY, INC., CHAMPAIGN, IL.
FILED 5-16-2006.

MACH

THE MARK CONSISTS OF STANDARD CHARACTERS WITHOUT CLAIM TO ANY PARTICULAR FONT, STYLE, SIZE, OR COLOR.

FOR ENGINES FOR MODEL VEHICLES AND PARTS THEREOF (U.S. CLS. 13, 19, 21, 23, 31, 34 AND 35).
FIRST USE 9-20-2002; IN COMMERCE 9-20-2002.
AMY HELLA, EXAMINING ATTORNEY

CLASS 7—(Continued).

SN 78-897,294. CONAIR CORPORATION, STAMFORD, CT.
FILED 5-31-2006.

PREP EXPRESS

THE MARK CONSISTS OF STANDARD CHARACTERS WITHOUT CLAIM TO ANY PARTICULAR FONT, STYLE, SIZE, OR COLOR.

FOR ELECTRIC FOOD BLENDERS; ELECTRIC FOOD CHOPPERS; ELECTRIC FOOD PROCESSORS; ELECTRIC FOOD SLICERS (U.S. CLS. 13, 19, 21, 23, 31, 34 AND 35).
SCOTT SISUN, EXAMINING ATTORNEY

SN 78-900,428. BSH BOSCH UND SIEMENS HAUSGERATE GMBH, MUNICH, FED REP GERMANY, FILED 6-5-2006.

AQUASECURE

THE MARK CONSISTS OF STANDARD CHARACTERS WITHOUT CLAIM TO ANY PARTICULAR FONT, STYLE, SIZE, OR COLOR.

FOR HOUSEHOLD AND KITCHEN MACHINES AND EQUIPMENT, NAMELY, ELECTRIC MACHINES AND APPLIANCES FOR TREATING LAUNDRY AND CLOTHING, NAMELY, WASHING MACHINES; AND REPLACEMENT PARTS THEREFOR (U.S. CLS. 13, 19, 21, 23, 31, 34 AND 35).
COLLEEN DOMBROW, EXAMINING ATTORNEY

SN 79-012,909. NINGBO FREE TRADE ZONE HENGDA BEARINGS CO., LTD., CHINA, FILED 5-27-2005.

ACCOR

OWNER OF INTERNATIONAL REGISTRATION 0855531 DATED 5-27-2005, EXPIRES 5-27-2015.

FOR BALL BEARINGS FOR ELECTRIC MOTOR; MACHINE PARTS, NAMELY BEARINGS; ENGINES NOT FOR LAND VEHICLES; BEARINGS FOR TRANSMISSION SHAFTS, BEING PARTS OF MACHINES; ROLLER BEARINGS FOR MACHINES; UNIVERSAL JOINTS FOR MACHINES; UNIVERSAL JOINTS, OTHER THAN FOR LAND VEHICLES; EXHAUST MANIFOLD FOR ENGINES; AIR FILTERS FOR MOTORS AND ENGINES (U.S. CLS. 13, 19, 21, 23, 31, 34 AND 35).
MICHAEL GAAFAR, EXAMINING ATTORNEY

CLASS 7—(Continued).

SN 79-016,001. MAN TURBO AG, FED REP GERMANY,
FILED 9-22-2005.

HOFIM Sealed

THE MARK CONSISTS OF STANDARD CHARACTERS WITHOUT CLAIM TO ANY PARTICULAR FONT, STYLE, SIZE, OR COLOR.

PRIORITY DATE OF 6-27-2005 IS CLAIMED.
OWNER OF INTERNATIONAL REGISTRATION 0864001 DATED 9-22-2005, EXPIRES 9-22-2015.

NO CLAIM IS MADE TO THE EXCLUSIVE RIGHT TO USE "SEALED", APART FROM THE MARK AS SHOWN.
FOR COMPRESSORS AS MACHINES, CONSISTING OF INTEGRAL ELECTRIC MOTOR WITH COMPRESSOR AND FREQUENCY CONVERTER (U.S. CLS. 13, 19, 21, 23, 31, 34 AND 35).

PETER B. BROMAGHIM, EXAMINING ATTORNEY

SN 79-016,002. MAN TURBO AG, FED REP GERMANY,
FILED 9-22-2005.

HOFIM

THE MARK CONSISTS OF STANDARD CHARACTERS WITHOUT CLAIM TO ANY PARTICULAR FONT, STYLE, SIZE, OR COLOR.

PRIORITY DATE OF 6-27-2005 IS CLAIMED.
OWNER OF INTERNATIONAL REGISTRATION 0864002 DATED 9-22-2005, EXPIRES 9-22-2015.

FOR COMPRESSORS AS MACHINES, CONSISTING OF INTEGRAL ELECTRIC MOTOR WITH COMPRESSOR AND FREQUENCY CONVERTER (U.S. CLS. 13, 19, 21, 23, 31, 34 AND 35).

PETER B. BROMAGHIM, EXAMINING ATTORNEY

CLASS 7—(Continued).

SN 79-020,804. INDESIT COMPANY SPA, ITALY, FILED 9-2-2005.

AQUALTIS

THE MARK CONSISTS OF STANDARD CHARACTERS WITHOUT CLAIM TO ANY PARTICULAR FONT, STYLE, SIZE, OR COLOR.

PRIORITY DATE OF 3-4-2005 IS CLAIMED.

OWNER OF INTERNATIONAL REGISTRATION 0876430 DATED 9-2-2005, EXPIRES 9-2-2015.

FOR MACHINE AND MACHINE TOOLS, NAMELY CANNING MACHINES, CARPET CLEANING MACHINES, BROACHES FOR MACHINES, CHASERS, MOTORS FOR REFRIGERATORS AND FREEZERS; HOUSEHOLD APPLIANCE, NAMELY, DISHWASHING MACHINES, LAUNDRY WASHING AND DRYING MACHINES, MIXERS, ELECTRIC FOOD GRINDERS FOR DOMESTIC USE, ELECTRIC COFFEE-GRINDERS, AND PART AND FITTINGS THEREFOR; ELECTRIC HOUSEHOLD MACHINES, NAMELY, VACUUM CLEANERS, FLOOR POLISHERS AND ELECTRIC CARPET SWEEPERS, PARTS AND FITTINGS THEREFOR (U.S. CLS. 13, 19, 21, 23, 31, 34 AND 35).

COLLEEN KEARNEY, EXAMINING ATTORNEY

SN 79-021,588. NIPPON BEARING CO., LTD., JAPAN, FILED 9-15-2005.



OWNER OF INTERNATIONAL REGISTRATION 0878881 DATED 9-15-2005, EXPIRES 9-15-2015.

FOR SHAFTS, AXLES, SPINDLES AND BEARINGS FOR MACHINE TOOLS (U.S. CLS. 13, 19, 21, 23, 31, 34 AND 35).

DAVID YONTEF, EXAMINING ATTORNEY

SN 79-023,524. SANWA KAGAKU KENKYUSHO CO., LTD., JAPAN, FILED 2-8-2006.

OSDRC

PRIORITY DATE OF 12-9-2005 IS CLAIMED.

OWNER OF INTERNATIONAL REGISTRATION 0884128 DATED 2-8-2006, EXPIRES 2-8-2016.

FOR TABLET MAKING MACHINES FOR PROCESSING POWDER MATERIALS INTO A TABLET FORM (U.S. CLS. 13, 19, 21, 23, 31, 34 AND 35).

TINA BROWN, EXAMINING ATTORNEY

CLASS 7—(Continued).

SN 79-023,761. WUXI HUADA ELECTROMOTOR CO., LTD, CHINA, FILED 3-1-2006.

HWADA

OWNER OF INTERNATIONAL REGISTRATION 0884618 DATED 3-1-2006, EXPIRES 3-1-2016.

FOR 3-PHASE ASYNCHRONOUS ELECTRIC MOTORS FOR MACHINES (U.S. CLS. 13, 19, 21, 23, 31, 34 AND 35).

KATHERINE E. HALMEN, EXAMINING ATTORNEY

SN 79-024,248. NINGBO JIUCHANG ELECTRICAL EQUIPMENT CO., LTD (NINGBO: JIUCHANG DIANQI YOUXIAN GONGSI), CHINA, FILED 3-1-2006.



OWNER OF INTERNATIONAL REGISTRATION 0885950 DATED 3-1-2006, EXPIRES 3-1-2016.

THE FIRST CHINESE CHARACTERS IS TRANSLATED AS "LONG", THE SECOND CHINESE CHARACTERS IS TRANSLATED AS "FLOURISHING", BUT THE WHOLE WORDS IN MEANINGLESS AND CREATED BY APPLICANT.

THE FIRST CHINESE CHARACTERS IS TRANSLITERATED AS "JIU", THE SECOND CHINESE CHARACTERS IS TRANSLITERATED AS "CHANG".

FOR VACUUM CLEANERS (U.S. CLS. 13, 19, 21, 23, 31, 34 AND 35).

KATHERINE E. HALMEN, EXAMINING ATTORNEY

CLASS 8—HAND TOOLS

SN 76-626,294. HELEN OF TROY LIMITED, ST. MICHAEL, BARBADOS, FILED 12-30-2004.

THE SHARK

THE MARK CONSISTS OF STANDARD CHARACTERS WITHOUT CLAIM TO ANY PARTICULAR FONT, STYLE, SIZE, OR COLOR.

FOR ELECTRIC HAND-HELD HAIR CLIPPERS AND ELECTRIC HAND-HELD RAZORS (U.S. CLS. 23, 28 AND 44).

FIRST USE 6-1-2005; IN COMMERCE 6-1-2005.

MARY BOAGNI, EXAMINING ATTORNEY

CLASS 8—(Continued).

SN 76-633,802. HAYS, BILL J., BANDON, OR. FILED 3-21-2005.



THE MARK CONSISTS OF A DESIGN WITH THE WORDING LIFT TOP.
FOR MANUAL TOOL TO OPEN CANS WITH PULL TAB CLOSURES (U.S. CLS. 23, 28 AND 44).
FIRST USE 12-14-2005; IN COMMERCE 12-14-2005.
DAVID ELTON, EXAMINING ATTORNEY

SN 76-645,478. ARMSTRONG ENTERPRISES, KAYCEE, WY.
FILED 8-22-2005.

KAYCEE CUTTER

THE MARK CONSISTS OF STANDARD CHARACTERS WITHOUT CLAIM TO ANY PARTICULAR FONT, STYLE, SIZE, OR COLOR.

NO CLAIM IS MADE TO THE EXCLUSIVE RIGHT TO USE "CUTTER", APART FROM THE MARK AS SHOWN.

FOR HAND TOOLS AND INSTRUMENTS, NAMELY CUTTERS FOR TWINE, THREAD, ROPE, STRING, CORDAGE, BELTS, TEXTILE FIBERS, AND PLASTIC NETTING THAT ARE SECURED, WRAPPED, BALED, AND BOUND TO HAY, FORAGE, GRASSES, AND STRAW (U.S. CLS. 23, 28 AND 44).

FIRST USE 8-0-2003; IN COMMERCE 2-0-2004.
CARRIE ACHEN, EXAMINING ATTORNEY

SN 78-664,447. KOLLER ENTERPRISES, INC., FENTON, MO.
FILED 7-6-2005.

DEPUTY DOO DOO

THE MARK CONSISTS OF STANDARD CHARACTERS WITHOUT CLAIM TO ANY PARTICULAR FONT, STYLE, SIZE, OR COLOR.

FOR RAKES AND GRABBERS, NAMELY, CLAW TONGS, FOR COLLECTING AND DISPOSING OF PET WASTE (U.S. CLS. 23, 28 AND 44).

MICHAEL LEWIS, EXAMINING ATTORNEY

CLASS 8—(Continued).

SN 78-693,043. RE-SOURCE INDUSTRIES, INC., FORT WORTH, TX. FILED 8-15-2005.

TorquePro

THE MARK CONSISTS OF STANDARD CHARACTERS WITHOUT CLAIM TO ANY PARTICULAR FONT, STYLE, SIZE, OR COLOR.

FOR HAND TOOLS NAMELY, SPRING WINDING TOOL FOR WINDING GARAGE DOOR TORSION SPRINGS (U.S. CLS. 23, 28 AND 44).

FIRST USE 5-2-2005; IN COMMERCE 5-2-2005.
INGA ERVIN, EXAMINING ATTORNEY

SN 78-713,086. CONTRACTOR PRO, LLC, SANDY, UT.
FILED 9-14-2005.

GATORBACK

THE MARK CONSISTS OF STANDARD CHARACTERS WITHOUT CLAIM TO ANY PARTICULAR FONT, STYLE, SIZE, OR COLOR.

FOR TOOL BELTS (U.S. CLS. 23, 28 AND 44).
KATINA MISTER, EXAMINING ATTORNEY

SN 78-781,630. SHOP-TEK INDUSTRIAL CORP., ROWLAND HEIGHTS, CA. FILED 12-28-2005.

SHOP-TEK

THE MARK CONSISTS OF STANDARD CHARACTERS WITHOUT CLAIM TO ANY PARTICULAR FONT, STYLE, SIZE, OR COLOR.

FOR HAND-HELD HAND TOOLS, NAMELY, CHISELS, HAMMERS, PLIERS, DRILLS AND DRILL BITS FOR HAND DRILLS, FILES, SPANNERS, HAND-GRINDERS, BOLT CUTTERS, KNIVES AND HOUSEHOLD KNIFE BLADES, SAWS AND SAW BLADES, SCISSORS, TITLE CUTTERS, TIN SNIPS, PUNCHES, CLAMPS, SHOVELS, AXE, PUTTY KNIFE, METAL VISES, WRENCHES, SOCKET SETS, SOCKET WRENCHES, SCREWDRIVERS, TROWELS (U.S. CLS. 23, 28 AND 44).

FIRST USE 6-19-1997; IN COMMERCE 8-1-1997.
GINA FINK, EXAMINING ATTORNEY

CLASS 8—(Continued).

SN 78-802,158. ELLISON EDUCATIONAL EQUIPMENT, INC., LAKE FOREST, CA. FILED 1-30-2006.

ELLISON DESIGN

THE MARK CONSISTS OF STANDARD CHARACTERS WITHOUT CLAIM TO ANY PARTICULAR FONT, STYLE, SIZE, OR COLOR.

OWNER OF U.S. REG. NOS. 2,168,762, 2,174,225 AND OTHERS.

NO CLAIM IS MADE TO THE EXCLUSIVE RIGHT TO USE "DESIGN", APART FROM THE MARK AS SHOWN.

FOR HAND OPERATED DIE AND PLATE CUTTERS, EMBOSSERS, AND STAMPERS AND PARTS THEREFOR, NAMELY STEEL RULE AND CHEMICAL-ETCHED DIES (U.S. CLS. 23, 28 AND 44).

FIRST USE 10-10-2005; IN COMMERCE 10-10-2005.

SETH A. RAPPAPORT, EXAMINING ATTORNEY

SN 78-823,356. HOFF, CARL TIMOTHY, CORONA, CA. FILED 2-25-2006.

SAFE TUK

THE MARK CONSISTS OF STANDARD CHARACTERS WITHOUT CLAIM TO ANY PARTICULAR FONT, STYLE, SIZE, OR COLOR.

SEC. 2(F).

FOR HAND TOOL, NAMELY, CARPET TUCKER (U.S. CLS. 23, 28 AND 44).

FIRST USE 2-1-1993; IN COMMERCE 2-6-1993.

TEJBIR SINGH, EXAMINING ATTORNEY

SN 78-836,440. 01 INC., NEW YORK, NY. FILED 3-14-2006.

GRAMERCY TOOLS

THE MARK CONSISTS OF STANDARD CHARACTERS WITHOUT CLAIM TO ANY PARTICULAR FONT, STYLE, SIZE, OR COLOR.

NO CLAIM IS MADE TO THE EXCLUSIVE RIGHT TO USE TOOLS, APART FROM THE MARK AS SHOWN.

FOR HAND TOOLS FOR WOODWORKING, NAMELY ADZES, AUGERS, AWLS, CLAMPS, DRILLS, FILES, HAMMERS, MANUALLY-OPERATED SHARPENING WHEELS, PLANES, RASPS, SAWS, SCRAPERS, SCREWDRIVERS, SQUARES, MITER BOXES, HATCHETS, VICES, KNIVES, SCREWDRIVERS, CAN OPENERS, AND PLIERS (U.S. CLS. 23, 28 AND 44).

FIRST USE 3-1-2005; IN COMMERCE 3-1-2005.

SUE LAWRENCE, EXAMINING ATTORNEY

CLASS 8—(Continued).

SN 78-846,889. ARMAMENT SYSTEMS AND PROCEDURES, INC., APPLETON, WI. FILED 3-27-2006.

DRAGON

THE MARK CONSISTS OF STANDARD CHARACTERS WITHOUT CLAIM TO ANY PARTICULAR FONT, STYLE, SIZE, OR COLOR.

FOR POLICE BATON EQUIPPED WITH A FLASHLIGHT (U.S. CLS. 23, 28 AND 44).

FRED CARL, EXAMINING ATTORNEY

SN 78-852,376. BOHLMAN, BARBARA, SHERMAN OAKS, CA. AND CARR, CAMILLE, SHERMAN OAKS, CA. FILED 4-3-2006.



THE MARK CONSISTS OF A STYLIZED DESIGN OF A ROSE.

FOR GARDENING SHEARS AND SCISSORS; HAND-OPERATED SHEARS; PRUNING SHEARS (U.S. CLS. 23, 28 AND 44).

JEFF DEFORD, EXAMINING ATTORNEY

CLASS 8—(Continued).

SN 78-853,922. HY CITE CORPORATION, MADISON, WI.
FILED 4-4-2006.



OWNER OF U.S. REG. NOS. 1,292,937 AND 2,995,091.
FOR CUTLERY NAMELY, KNIVES WITH STAINLESS
STEEL BLADES AND WOODEN HANDLES AND FLAT-
WARE NAMELY STAINLESS STEEL FORKS, KNIVES,
SPOONS AND SERVING SPOONS (U.S. CLS. 23, 28 AND
44).

FIRST USE 12-31-1980; IN COMMERCE 12-31-1980.
JOHN E. MICHOS, EXAMINING ATTORNEY

SN 78-855,564. CHANG, LISA M. L., HONOLULU, HI. FILED
4-6-2006.

CHOP TONG

THE MARK CONSISTS OF STANDARD CHARACTERS
WITHOUT CLAIM TO ANY PARTICULAR FONT, STYLE,
SIZE, OR COLOR.

FOR ASSISTIVE MANUAL IMPLEMENTS, NAMELY,
SPOONS, FORKS, AND KNIVES (U.S. CLS. 23, 28 AND
44).

MELVIN AXILBUND, EXAMINING ATTORNEY

SN 78-857,674. THE ONTARIO KNIFE COMPANY, FRANK-
LINVILLE, NY. FILED 4-10-2006.

M7-B

THE MARK CONSISTS OF STANDARD CHARACTERS
WITHOUT CLAIM TO ANY PARTICULAR FONT, STYLE,
SIZE, OR COLOR.

OWNER OF U.S. REG. NO. 2,565,008.

FOR KNIVES USED FOR HUNTING, SPORT, MILI-
TARY, LAW ENFORCEMENT, EMERGENCY SERVICES,
FOOD PREPARATION AND HOUSEHOLD USE (U.S.
CLS. 23, 28 AND 44).

FIRST USE 2-1-2005; IN COMMERCE 2-1-2005.

JAMES MACFARLANE, EXAMINING ATTORNEY

CLASS 8—(Continued).

SN 78-859,216. EASCO HAND TOOLS, INC., SIMSBURY, CT.
FILED 4-11-2006.

MasterForge

OWNER OF U.S. REG. NO. 2,072,529.
FOR HAND TOOLS, NAMELY PLIERS, HAMMERS,
WRENCHES, SCREWDRIVERS, LOCKING PLIERS, AD-
JUSTABLE WRENCHES, SOCKETS, AND RATCHETING
WRENCHES (U.S. CLS. 23, 28 AND 44).
FIRST USE 0-0-1997; IN COMMERCE 0-0-1997.
TANYA AMOS, EXAMINING ATTORNEY

SN 78-859,253. EASCO HAND TOOLS, INC., SIMSBURY, CT.
FILED 4-11-2006.

MASTERFORGE

THE MARK CONSISTS OF STANDARD CHARACTERS
WITHOUT CLAIM TO ANY PARTICULAR FONT, STYLE,
SIZE, OR COLOR.

OWNER OF U.S. REG. NO. 2,072,529.

FOR HAND TOOLS, NAMELY PLIERS, HAMMERS,
WRENCHES, SCREWDRIVERS, LOCKING PLIERS, AD-
JUSTABLE WRENCHES, SOCKETS, AND RATCHETING
WRENCHES (U.S. CLS. 23, 28 AND 44).

FIRST USE 0-0-1997; IN COMMERCE 0-0-1997.

TANYA AMOS, EXAMINING ATTORNEY

SN 78-859,741. BARENTHAL NORTH AMERICA, INC.,
RUTHERFORD, NJ. FILED 4-12-2006.

KITCHENTREND

THE MARK CONSISTS OF STANDARD CHARACTERS
WITHOUT CLAIM TO ANY PARTICULAR FONT, STYLE,
SIZE, OR COLOR.

FOR CUTLERY AND FLATWARE (U.S. CLS. 23, 28
AND 44).

JESSICA A. POWERS, EXAMINING ATTORNEY

CLASS 8—(Continued).

SN 78-863,817. MAZUR, ROBERT G., CANTON, MI. FILED 4-18-2006.

DogGone Opener

THE MARK CONSISTS OF STANDARD CHARACTERS WITHOUT CLAIM TO ANY PARTICULAR FONT, STYLE, SIZE, OR COLOR.

NO CLAIM IS MADE TO THE EXCLUSIVE RIGHT TO USE "OPENER", APART FROM THE MARK AS SHOWN. FOR MANUALLY OPERATED CONTAINER OPENER FOR HOUSEHOLD OR DOMESTIC USE (U.S. CLS. 23, 28 AND 44).

FIRST USE 6-1-2004; IN COMMERCE 10-14-2005.
CATHERINE FAINT, EXAMINING ATTORNEY

SN 78-864,919. INNOVATION BARGAIN, LLC, MANHASSET, NY. FILED 4-19-2006.

iPack

THE MARK CONSISTS OF STANDARD CHARACTERS WITHOUT CLAIM TO ANY PARTICULAR FONT, STYLE, SIZE, OR COLOR.

FOR PLASTIC CUTLERY (U.S. CLS. 23, 28 AND 44).
FIRST USE 3-1-2005; IN COMMERCE 3-1-2005.
CIMMERIAN COLEMAN, EXAMINING ATTORNEY

SN 78-867,345. CALICO BRANDS, INC., ONTARIO, CA. FILED 4-21-2006.

CALICO

THE MARK CONSISTS OF STANDARD CHARACTERS WITHOUT CLAIM TO ANY PARTICULAR FONT, STYLE, SIZE, OR COLOR.

FOR RAZORS (U.S. CLS. 23, 28 AND 44).
GEORGE LORENZO, EXAMINING ATTORNEY

CLASS 8—(Continued).

SN 78-870,037. FAITH INTERNATIONAL ENTERPRISE LIMITED, SHATIN, HONG KONG, FILED 4-26-2006.

Speedy-Change

THE MARK CONSISTS OF STANDARD CHARACTERS WITHOUT CLAIM TO ANY PARTICULAR FONT, STYLE, SIZE, OR COLOR.

FOR HAND TOOLS, NAMELY KNIVES, UTILITY KNIVES, CARPET KNIVES, FOLDING KNIVES, KNIFE SHEATHS (U.S. CLS. 23, 28 AND 44).

DOMINIC J. FERRAIUOLO, EXAMINING ATTORNEY

SN 78-870,105. WASSCO CORPORATION, TULSA, OK. FILED 4-26-2006.

TOYZ TOOL

THE MARK CONSISTS OF STANDARD CHARACTERS WITHOUT CLAIM TO ANY PARTICULAR FONT, STYLE, SIZE, OR COLOR.

NO CLAIM IS MADE TO THE EXCLUSIVE RIGHT TO USE "TOOL", APART FROM THE MARK AS SHOWN.

FOR HAND TOOLS, NAMELY, WIRE CUTTERS; SCISSORS; SCISSORS FOR HOUSEHOLD USE (U.S. CLS. 23, 28 AND 44).

KATINA MISTER, EXAMINING ATTORNEY

SN 78-872,088. 5.11, INC., MODESTO, CA. FILED 4-28-2006.

FLATFOOT

THE MARK CONSISTS OF STANDARD CHARACTERS WITHOUT CLAIM TO ANY PARTICULAR FONT, STYLE, SIZE, OR COLOR.

FOR KNIVES; UTILITY KNIVES (U.S. CLS. 23, 28 AND 44).

CAROLYN CATALDO, EXAMINING ATTORNEY

CLASS 8—(Continued).

SN 78-885,008. WALLBOARD TOOL CO., INC., LONG BEACH, CA. FILED 5-16-2006.

TUFF-LOCK

THE MARK CONSISTS OF STANDARD CHARACTERS WITHOUT CLAIM TO ANY PARTICULAR FONT, STYLE, SIZE, OR COLOR.
FOR HAND TOOLS, NAMELY, HAND SANDERS, POLE SANDERS (U.S. CLS. 23, 28 AND 44).
ANNE MADDEN, EXAMINING ATTORNEY

SN 78-893,806. SUNCAST CORPORATION, BATAVIA, IL. FILED 5-26-2006.

FLEX-CORE

THE MARK CONSISTS OF STANDARD CHARACTERS WITHOUT CLAIM TO ANY PARTICULAR FONT, STYLE, SIZE, OR COLOR.
OWNER OF U.S. REG. NOS. 2,218,110 AND 2,344,092.
FOR SHOVELS, SNOW PUSHERS, HAND OPERATED TOOLS, NAMELY SNOW SCOOPS; ICE SCRAPERS (U.S. CLS. 23, 28 AND 44).
LINDA LAVACHE, EXAMINING ATTORNEY

SN 78-893,824. SUNCAST CORPORATION, BATAVIA, IL. FILED 5-26-2006.

SUNCAST POWERBLADE

THE MARK CONSISTS OF STANDARD CHARACTERS WITHOUT CLAIM TO ANY PARTICULAR FONT, STYLE, SIZE, OR COLOR.
OWNER OF U.S. REG. NOS. 1,399,201, 2,232,821 AND OTHERS.
FOR SHOVELS, SNOW PUSHERS, HAND OPERATED TOOLS, NAMELY SNOW SCOOPS; ICE SCRAPERS (U.S. CLS. 23, 28 AND 44).
LINDA LAVACHE, EXAMINING ATTORNEY

CLASS 8—(Continued).

SN 78-907,681. BARENTHAL NORTH AMERICA, INC., RUTHERFORD, NJ. FILED 6-14-2006.

GOURMET BUFFET

THE MARK CONSISTS OF STANDARD CHARACTERS WITHOUT CLAIM TO ANY PARTICULAR FONT, STYLE, SIZE, OR COLOR.
FOR CUTLERY AND FLATWARE (U.S. CLS. 23, 28 AND 44).
JESSICA A. POWERS, EXAMINING ATTORNEY

SN 78-919,610. HEB GROCERY COMPANY, LP, SAN ANTONIO, TX. FILED 6-29-2006.

LONE STAR STATEMENTS

THE MARK CONSISTS OF STANDARD CHARACTERS WITHOUT CLAIM TO ANY PARTICULAR FONT, STYLE, SIZE, OR COLOR.
FOR FLATWARE, NAMELY, FORKS, KNIVES AND SPOONS; CUTLERY (U.S. CLS. 23, 28 AND 44).
EUGENIA MARTIN, EXAMINING ATTORNEY

CLASS 9—ELECTRICAL AND SCIENTIFIC APPARATUS

SN 75-629,575. PLANET-INTRA.COM LTD., MOUNTAIN VIEW, CA. FILED 1-26-1999.

PLANET-INTRA

FOR COMPUTER SOFTWARE FOR USE WITH PROPRIETARY ELECTRONIC COMMUNICATIONS NETWORKS, NAMELY, COMPUTER SOFTWARE FOR CREATING, IMPLEMENTING AND INSTALLING PROPRIETARY ELECTRONIC COMMUNICATIONS NETWORKS, SEARCH ENGINE SOFTWARE AND COMPUTER SOFTWARE FOR EDITING AND DISTRIBUTING INFORMATION ON PROPRIETARY ELECTRONIC COMMUNICATIONS NETWORKS (U.S. CLS. 21, 23, 26, 36 AND 38).
MELVIN AXILBUND, EXAMINING ATTORNEY

CLASS 9—(Continued).

SN 75-629,578. PLANET-INTRA.COM LTD., MOUNTAIN VIEW, CA. FILED 1-26-1999.

PLANET-INTRA.COM

FOR COMPUTER SOFTWARE FOR USE WITH PROPRIETARY ELECTRONIC COMMUNICATIONS NETWORKS, NAMELY, COMPUTER SOFTWARE FOR CREATING, IMPLEMENTING AND INSTALLING PROPRIETARY ELECTRONIC COMMUNICATIONS NETWORKS, SEARCH ENGINE SOFTWARE AND COMPUTER SOFTWARE FOR EDITING AND DISTRIBUTING INFORMATION ON PROPRIETARY ELECTRONIC COMMUNICATIONS NETWORKS (U.S. CLS. 21, 23, 26, 36 AND 38).

MELVIN AXILBUND, EXAMINING ATTORNEY

SN 76-062,901. TELESOFT DESIGN, LTD., MILTON ABBAS, DORSET, UNITED KINGDOM, FILED 6-2-2000.

IPAC

FOR VOICE RESPONSE UNITS FOR TELEPHONE SYSTEMS (U.S. CLS. 21, 23, 26, 36 AND 38).

RONALD AIKENS, EXAMINING ATTORNEY

SN 76-127,652. KOI, INC., FRAMINGHAM, MA. FILED 9-13-2000.

TVWOW

FOR AUDIO SPEAKERS AND AUDIO EQUIPMENT, NAMELY, HI-FI AUDIO SPEAKERS, AUDIO SPEAKERS FOR PUBLIC SPEAKING EVENTS, TELEVISION SPEAKERS, PERSONAL COMPUTER SPEAKERS, AND SPEAKERS FOR PORTABLE RADIOS, CASSETTE PLAYERS, COMPACT DISC PLAYERS, AND DIGITAL VIDEO DISC PLAYERS (U.S. CLS. 21, 23, 26, 36 AND 38).

FIRST USE 12-27-1999; IN COMMERCE 12-27-1999.
RONALD AIKENS, EXAMINING ATTORNEY

SN 76-313,741. TREBIA NETWORKS INCORPORATED, ACTON, MA. FILED 9-17-2001.

PIONEERING THE STORAGE NETWORK PROCESSOR

FOR SEMICONDUCTOR DEVICES (U.S. CLS. 21, 23, 26, 36 AND 38).

RONALD AIKENS, EXAMINING ATTORNEY

CLASS 9—(Continued).

SN 76-458,586. VIRGIN MOBILE USA, LLC, WARREN, NJ. FILED 10-16-2002.

THE SUPER MODEL

FOR MOBILE TELEPHONES; TELEPHONES; MODEMS; BATTERIES; BATTERY CHARGERS; AND MOBILE TELEPHONE ACCESSORIES, NAMELY CIGARETTE LIGHTER ADAPTERS, DASHBOARD MOUNTS, HANDS-FREE HEADSETS, CARRYING CASES, AND BELT CLIPS (U.S. CLS. 21, 23, 26, 36 AND 38).

FIRST USE 7-1-2002; IN COMMERCE 7-1-2002.
JOHN DWYER, EXAMINING ATTORNEY

SN 76-460,413. ARISTOCRAT TECHNOLOGIES AUSTRALIA PTY LIMITED, LANE COVE, NEW SOUTH WALES 2066, AUSTRALIA, FILED 10-22-2002.

LUCKY BALLS

OWNER OF AUSTRALIA REG. NO. 894047, DATED 11-5-2001, EXPIRES 11-5-2011.

NO CLAIM IS MADE TO THE EXCLUSIVE RIGHT TO USE "BALLS", APART FROM THE MARK AS SHOWN.

FOR GAMING DEVICES, NAMELY, GAMING MACHINES (U.S. CLS. 21, 23, 26, 36 AND 38).

SONYA STEPHENS, EXAMINING ATTORNEY

SN 76-464,559. ARISTOCRAT TECHNOLOGIES AUSTRALIA PTY LIMITED, LANE COVE, NEW SOUTH WALES 2066, AUSTRALIA, FILED 10-29-2002.

COLD HARD CASH

OWNER OF AUSTRALIA REG. NO. 892784, DATED 10-22-2001, EXPIRES 10-22-2011.

NO CLAIM IS MADE TO THE EXCLUSIVE RIGHT TO USE "CASH", APART FROM THE MARK AS SHOWN.

FOR GAMING DEVICES, NAMELY, GAMING MACHINES (U.S. CLS. 21, 23, 26, 36 AND 38).

SONYA STEPHENS, EXAMINING ATTORNEY

CLASS 9—(Continued).

SN 76-568,722. AMERICA ACTION, INC., POMONA, CA. FILED 12-29-2003.



AXION AND DESIGN, COMPRISES THE WORD "AXION" INCORPORATED WITH AN "X" DESIGN, WHEREIN THE "X" DESIGN COMPRISES AN "X" DEFINING FOUR TRIANGLES AND A DIAMOND PLACED IN THE INTERSECTION OF THE "X", AND A HORIZONTAL BAR DISPOSED BELOW THE "X" DESIGN.

FOR RADIOS, AUDIO-CASSETTE RECORDERS, TELEVISIONS, VIDEO RECORDERS, MONITORS, HOME-THEATER SYSTEM, NAMELY, RECEIVER, SPEAKER, SUBWOOFER, REMOTE CONTROL, AND PLAYERS FOR VCR, DVD, VCD, MP3, CD-R, AND DVD-R; HEADSETS, PERSONAL VIDEO RECORDER/PLAYER, FLASH MEMORY CARD READER, DIGITAL CAMERA, MP3/MP4 PLAYER/RECORDER, PHONES, PERSONAL DIGITAL ASSISTANT, PDA, TABLE PC, ELECTRIC AND ELECTRONIC VIDEO SURVEILLANCE MONITORING SYSTEMS, CARRYING CASES FOR ELECTRONIC AND COMPUTER RELATED GOODS, RECHARGEABLE BATTERY PACKS, CAR BATTERY CORDS, ANTENNAS, WIRED AND WIRELESS MICROPHONES, ELECTRIC-COMMUNICATING APPARATUS, NAMELY, TELEPHONES WITH TWO WAY VIDEO TRANSMITTERS, VIDEO CAMERAS, COMPACT DISC PLAYERS, TRANSCIEVERS, HEADPHONES, PERSONAL STEREOs, TUNERS, SPEAKERS, TELEVISION TUBES, COMPUTER MONITORS, REMOTE CONTROL UNITS FOR TELEVISION RECEIVERS, TELEVISION MONITORS WITH AND WITHOUT TELEVISION TUNERS, VIDEO CAMERAS COMBINED WITH VIDEO TAPE RECORDERS, VIDEO CAMERA CONTROL POWER UNIT, VIDEO CAMERA ACCESSORIES, NAMELY, OPTICAL FIBER LINKS, VIDEO CAMERA CABLE (U.S. CLS. 21, 23, 26, 36 AND 38).

FIRST USE 10-31-2003; IN COMMERCE 10-31-2003.
PAULA MAYS, EXAMINING ATTORNEY

SN 76-589,270. KING TECHNOLOGY GROUP, LLC, ALISO VIEJO, CA. FILED S.R. 4-29-2004; AM. P.R. 4-29-2004.

MORTGAGE IQ

THE MARK CONSISTS OF STANDARD CHARACTERS WITHOUT CLAIM TO ANY PARTICULAR FONT, STYLE, SIZE, OR COLOR.

NO CLAIM IS MADE TO THE EXCLUSIVE RIGHT TO USE "MORTGAGE", APART FROM THE MARK AS SHOWN.

FOR COMPUTER SOFTWARE FOR APPLICATION AND DATABASE INTEGRATION BY INTERFACING VIEWS, SCREENS, TABS, LIST VIEWS, DOCUMENT TEMPLATES, REPORTS, INTEGRATION, INTEGRATION SCRIPTS, DATABASE TABLES, FIELDS, BUSINESS RULES, BUSINESS ALERTS AND NOTIFICATIONS WITH OTHER FINANCIAL AND MORTGAGE COMPUTER SOFTWARE ALL FOR PROVIDING MORTGAGE BROKERS, LOAN OFFICERS AND PROCESSORS WITH A HOLISTIC VIEW OF A BORROWER AND FOR USE BY THE MORTGAGE BANKING AND MORTGAGE BROKER INDUSTRIES (U.S. CLS. 21, 23, 26, 36 AND 38).

FIRST USE 8-0-2002; IN COMMERCE 8-0-2002.
LINDA ESTRADA, EXAMINING ATTORNEY

CLASS 9—(Continued).

SN 76-606,569. ISMART INTERNATIONAL LIMITED, MUMBAI 400 093 MH, INDIA, FILED 8-9-2004.

ISMART

THE MARK CONSISTS OF STANDARD CHARACTERS WITHOUT CLAIM TO ANY PARTICULAR FONT, STYLE, SIZE, OR COLOR.

FOR COMPUTER SOFTWARE FOR COMPUTER NETWORK SECURITY (U.S. CLS. 21, 23, 26, 36 AND 38).

FIRST USE 3-0-2004; IN COMMERCE 3-0-2004.
JENNY PARK, EXAMINING ATTORNEY

SN 76-612,305. CLARK, BRENT ANDERSON, PROVO, UT. FILED 9-16-2004.

R.E.D.S.

THE MARK CONSISTS OF STANDARD CHARACTERS WITHOUT CLAIM TO ANY PARTICULAR FONT, STYLE, SIZE, OR COLOR.

FOR EMERGENCY WARNING DEVICE SYSTEMS, NAMELY, DEPLOYMENT SYSTEM FOR TRAFFIC SAFETY MARKERS COMPRISED OF HIGHWAY SAFETY CONES AND WARNING LIGHTS; TRAFFIC SAFETY MARKERS, HIGHWAY SAFETY CONES AND WARNING LIGHTS (U.S. CLS. 21, 23, 26, 36 AND 38).

FIRST USE 6-12-2004; IN COMMERCE 6-12-2004.
JOHN SCHUYLER YARD, EXAMINING ATTORNEY

SN 76-616,385. GENIUS PRODUCTS, INC., SOLANA BEACH, CA. FILED 10-18-2004.

PET TUNES

THE MARK CONSISTS OF STANDARD CHARACTERS WITHOUT CLAIM TO ANY PARTICULAR FONT, STYLE, SIZE, OR COLOR.

NO CLAIM IS MADE TO THE EXCLUSIVE RIGHT TO USE "TUNES", APART FROM THE MARK AS SHOWN. SEC. 2(F).

FOR PRERECORDED AUDIO CASSETTES, COMPACT DISCS, VIDEO CASSETTES, LASER DISCS, AND DIGITAL VIDEO DISCS, ALL FEATURING MUSIC (U.S. CLS. 21, 23, 26, 36 AND 38).

FIRST USE 10-28-1999; IN COMMERCE 10-28-1999.
MARIAM MAHMOUDI, EXAMINING ATTORNEY

CLASS 9—(Continued).

SN 76-616,916. COLEMAN CABLE, INC., WAUKEGAN, IL.
FILED 10-20-2004.

CROWN SERIES

THE MARK CONSISTS OF STANDARD CHARACTERS WITHOUT CLAIM TO ANY PARTICULAR FONT, STYLE, SIZE, OR COLOR.

NO CLAIM IS MADE TO THE EXCLUSIVE RIGHT TO USE "SERIES", APART FROM THE MARK AS SHOWN.

FOR BULK AND NON-BULK PORTABLE ELECTRICAL CORDS, ELECTRICAL COMMUNICATION CABLE, POWER CABLES, WELDING CABLE, METAL COVERED ELECTRICAL CABLES, JUMPER CABLES, POWER STRIPS, VOICE AND DATA CABLE, ELECTRICAL AND ELECTRONIC AUTOMOTIVE CABLES AND WIRES, ELECTRICAL AND ELECTRONIC MARINE CABLES AND WIRES, SYNTHETIC AND RUBBER WIRE COVERINGS, ELECTRICAL CONDUIT AND CABLE, ELECTRICAL EXTENSION CORDS, ELECTRICAL POWER CORDS, AND ELECTRONIC CABLES AND WIRES (U.S. CLS. 21, 23, 26, 36 AND 38).

FIRST USE 2-1-2004; IN COMMERCE 4-1-2004.
SALLY SHIH, EXAMINING ATTORNEY

SN 76-617,649. IMV CORPORATION, KITA-KU, OSAKA,
JAPAN, FILED 10-25-2004.

IMV

THE MARK CONSISTS OF STANDARD CHARACTERS WITHOUT CLAIM TO ANY PARTICULAR FONT, STYLE, SIZE, OR COLOR.

FOR RESISTANCE MEASURING INSTRUMENTS; IMPEDANCE MEASURING INSTRUMENTS, NAMELY, IMPEDANCE MEASURING METERS; REMOTE CONTROL TELEMETERING MACHINES AND APPARATUS; ENVIRONMENTAL TEST CHAMBERS, NAMELY, TEMPERATURE SIMULATION EQUIPMENT, HUMIDITY SIMULATION EQUIPMENT, ATMOSPHERIC PRESSURE SIMULATION EQUIPMENT, RAINFALL SIMULATION EQUIPMENT, WATER IMMERSION SIMULATION EQUIPMENT, ISOLATION SIMULATION EQUIPMENT, ATOMIZED SALTWATER SIMULATION EQUIPMENT, AND SAND AND DUST SIMULATION EQUIPMENT; VIBRATION TESTING EQUIPMENT, NAMELY, ELECTROMAGNETIC VIBRATORS AND PARTS AND ACCESSORIES THEREFOR, NAMELY, VIBRATOR TABLES, VIBRATION CONTROLLERS, AND VIBRATOR COOLING UNITS; VIBRATION METERS; AND SEISMOMETERS (U.S. CLS. 21, 23, 26, 36 AND 38).

FIRST USE 4-17-1957; IN COMMERCE 1-0-1988.
JENNY PARK, EXAMINING ATTORNEY

CLASS 9—(Continued).

SN 76-634,365. GENTEX CORPORATION, ZEELAND, MI.
FILED 3-25-2005.

FIREBYRD

THE MARK CONSISTS OF STANDARD CHARACTERS WITHOUT CLAIM TO ANY PARTICULAR FONT, STYLE, SIZE, OR COLOR.

FOR SMOKE DETECTORS, NAMELY, SMOKE DETECTION DEVICES AND ALARMS, EXCLUDING APPLICATIONS FOR USE IN OR RELATED TO AIRCRAFT, MISSILE, SATELLITES AND AERONAUTICAL APPLICATIONS (U.S. CLS. 21, 23, 26, 36 AND 38).

ANDREW RHIM, EXAMINING ATTORNEY

SN 76-636,327. ADVENTURE LIGHTS INC., QUEBEC H7L
5A1, CANADA, FILED 4-18-2005.

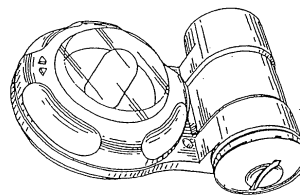

THE MARK CONSISTS OF A DESIGN CONFIGURATION OF A THREE-DIMENSIONAL SAFETY LIGHT. THE VARIOUS LINES IN THE SHOWN IN THE DRAWING IS FOR SHADING PURPOSES AND DOES NOT INDICATE COLOR. SEC. 2(F).

FOR SAFETY EQUIPMENT, NAMELY, BEACON LIGHTS AND DISTRESS BEACONS FOR USE IN HAZARDOUS OR POTENTIALLY HAZARDOUS SITUATIONS, SEARCH AND RESCUE OPERATIONS, OFFSHORE OPERATIONS, UNDERGROUND MINING OPERATIONS, ACCIDENT CONTROL, TRAFFIC CONTROL, FOR POSITIVE VISUAL IDENTIFICATION AND ILLUMINATION OF INDIVIDUALS, PETS AND OBJECTS (U.S. CLS. 21, 23, 26, 36 AND 38).

FIRST USE 0-0-1995; IN COMMERCE 0-0-1995.
IRENE D. WILLIAMS, EXAMINING ATTORNEY

SN 76-642,422. SENSATRONICS, LLC, BOW, NH. FILED 7-7-
2005.

SensaTronics

FOR ENVIRONMENTAL MONITORING EQUIPMENT, NAMELY, ELECTRONIC EQUIPMENT FOR MEASURING AND MONITORING ENVIRONMENTAL CONDITIONS IN A COMPUTER DATA CENTER HOUSING COMPUTERS AND SERVERS (U.S. CLS. 21, 23, 26, 36 AND 38).

FIRST USE 8-15-2001; IN COMMERCE 8-15-2001.
SANI KHOURI, EXAMINING ATTORNEY

CLASS 9—(Continued).

SN 76-643,843. DINERO FAM, LLC, SHIRLEY, NY. FILED 7-29-2005.

DINERO FAM

THE MARK CONSISTS OF STANDARD CHARACTERS WITHOUT CLAIM TO ANY PARTICULAR FONT, STYLE, SIZE, OR COLOR.

FOR MUSICAL SOUND RECORDINGS, NAMELY RECORDS, COMPACT DISCS, CASSETTES, VIDEO TAPES, DIGITAL VIDEO DISCS AND DIGITAL DOWNLOADS, AUDIO VISUAL RECORDINGS, NAMELY MUSIC RECORDED ON COMPACT DISCS, CASSETTES, VIDEOTAPES, DIGITAL VIDEO DISCS AND DIGITAL DOWNLOADS (U.S. CLS. 21, 23, 26, 36 AND 38).

FIRST USE 8-0-2002; IN COMMERCE 8-0-2002.
AMEETA JORDAN, EXAMINING ATTORNEY

CLASS 9—(Continued).

SN 76-647,088. TENSOLITE COMPANY, ST. AUGUSTINE, FL. FILED 9-20-2005.

HDRFI

THE MARK CONSISTS OF STANDARD CHARACTERS WITHOUT CLAIM TO ANY PARTICULAR FONT, STYLE, SIZE, OR COLOR.

OWNER OF U.S. REG. NO. 2,407,191.
FOR CONNECTION SYSTEMS, NAMELY, ELECTRICAL CONNECTORS, ELECTRICAL CONNECTOR ASSEMBLIES, INTERCONNECTS AND CABLES, AND CABLE ASSEMBLIES (U.S. CLS. 21, 23, 26, 36 AND 38).
AISHA CLARKE, EXAMINING ATTORNEY

SN 76-644,880. REALTEK SEMICONDUCTOR CORP., HSINCHU 300, TAIWAN, FILED 8-16-2005.

PIXEL COMPOSER

THE MARK CONSISTS OF STANDARD CHARACTERS WITHOUT CLAIM TO ANY PARTICULAR FONT, STYLE, SIZE, OR COLOR.

FOR TELEVISION SETS; MONITORS, NAMELY COMPUTER MONITORS, LIQUID CRYSTAL DISPLAY MONITORS, PLASMA DISPLAY MONITORS; SATELLITE NAVIGATIONAL SYSTEMS, NAMELY, GLOBAL POSITIONING SYSTEMS; CELLULAR TELEPHONES; VIDEO CASSETTE RECORDERS; LIQUID CRYSTAL DISPLAY PROJECTORS; VIDEO GAME MACHINES FOR USE WITH TELEVISIONS; CAR TELEVISIONS; AND PORTABLE MULTIMEDIA PLAYERS, NAMELY, PORTABLE MEDIA PLAYERS (U.S. CLS. 21, 23, 26, 36 AND 38).

FIRST USE 7-0-2004; IN COMMERCE 1-0-2005.
JENNIFER MCROBBIE, EXAMINING ATTORNEY

SN 76-647,128. ELECTRONIC CONTROLS COMPANY, BOISE, ID. FILED 9-20-2005.

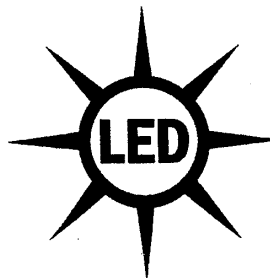

NO CLAIM IS MADE TO THE EXCLUSIVE RIGHT TO USE "LED", APART FROM THE MARK AS SHOWN.
FOR EMERGENCY WARNING LIGHTS FOR USE ON EQUIPMENT OR VEHICLES (U.S. CLS. 21, 23, 26, 36 AND 38).

FIRST USE 1-17-2005; IN COMMERCE 1-17-2005.
STEVEN JACKSON, EXAMINING ATTORNEY

CLASS 9—(Continued).

SN 76-648,373. NMT CORPORATION, LA CROSSE, WI.
FILED 10-4-2005.

NDLS

THE MARK CONSISTS OF STANDARD CHARACTERS WITHOUT CLAIM TO ANY PARTICULAR FONT, STYLE, SIZE, OR COLOR.

FOR COMPUTER SOFTWARE FOR USE IN SEARCHING, RETRIEVING, VIEWING AND PRINTING ARCHIVED RECORDS FROM MULTIPLE DIGITAL COLLECTIONS (U.S. CLS. 21, 23, 26, 36 AND 38).

FIRST USE 3-22-2005; IN COMMERCE 3-22-2005.
ANTHONY RINKER, EXAMINING ATTORNEY

SN 76-648,530. MING-TSUNG CHOU, SUNG-SAN DISTRICT,
TAIPEI, TAIWAN, FILED 10-14-2005.



NO CLAIM IS MADE TO THE EXCLUSIVE RIGHT TO USE "METER RACING", APART FROM THE MARK AS SHOWN.

FOR SPEEDOMETERS; AUTOMOTIVE MEASURING INSTRUMENTS, NAMELY, WATER TEMPERATURE GAUGES, OIL PRESSURE GAUGES, OIL TEMPERATURE GAUGES, VOLTMETER GAUGES, AMMETER GAUGES, AIR FUEL RATIO GAUGES, BOOST GAUGES, VACUUM GAUGES; FUEL LEVEL GAUGES; FUEL PRESSURE GAUGES; TACHOMETERS; TEMPERATURE INDICATORS AND SPEED INDICATORS (U.S. CLS. 21, 23, 26, 36 AND 38).

TEJBIR SINGH, EXAMINING ATTORNEY

SN 76-650,381. CENTRAL LAKE ARMOR EXPRESS, INC.,
CENTRAL LAKE, MI. FILED 11-14-2005.

ARMOR EXPRESS

THE MARK CONSISTS OF STANDARD CHARACTERS WITHOUT CLAIM TO ANY PARTICULAR FONT, STYLE, SIZE, OR COLOR.

NO CLAIM IS MADE TO THE EXCLUSIVE RIGHT TO USE "ARMOR", APART FROM THE MARK AS SHOWN.

FOR PROTECTIVE CLOTHING, NAMELY CONCEALED BODY ARMOR FOR USE BY LAW ENFORCEMENT (U.S. CLS. 21, 23, 26, 36 AND 38).

FIRST USE 8-8-2005; IN COMMERCE 8-8-2005.
LOURDES AYALA, EXAMINING ATTORNEY

CLASS 9—(Continued).

SN 76-651,046. TOLTEC ENGINEERING CO., LTD., MIAO LI
HSIANG, TAIWAN, FILED 11-18-2005.



FOR LENGTH MEASURING GAUGES; LEVEL GAUGES; PRESSURE GAUGES; SURVEYING MACHINES AND INSTRUMENTS; CENTRAL PROCESSING UNITS FOR PROCESSING INFORMATION, DATA, SOUND AND IMAGES; COMPUTER CHIP SETS FOR USE IN TRANSMITTING DATA TO AND FROM A CENTRAL PROCESSING UNIT; INTERFACE CARDS FOR DATA PROCESSING EQUIPMENT IN THE FORM OF PRINTED CIRCUITS; OPTICAL LENSES; COMPUTER DATA LOG DEVICES USED FOR MEASURING PURPOSES; INSTRUMENTS CONTAINING EYEPieces, NAMELY MICROSCOPES, GAUGES, SURVEYING MACHINES AND SURVEYING INSTRUMENTS; OPTICAL INSPECTION APPARATUSES FOR INDUSTRIAL USE; PHYSICAL SAFETY INSPECTION APPARATUSES FOR INDUSTRIAL USE, NAMELY SMOKE DETECTORS, MOTION SENSORS AND RADIATION MEASURING INSTRUMENT; SOUND MEASURING INSTRUMENTS FOR LABORATORIES AND INDUSTRIAL WORK PLACES; MICRO-MEASURING DEVICES FOR USE IN SCIENTIFIC MEASUREMENTS AND IN MANUFACTURER OF MINUTE ELECTRONIC COMPONENTS (U.S. CLS. 21, 23, 26, 36 AND 38).

HOWARD B. LEVINE, EXAMINING ATTORNEY

SN 76-651,590. AMPHIBIOUS ZOO ENTERTAINMENT
GROUP, LLC, DRAPER, UT. FILED 12-5-2005.

AMPHIBIOUS ZOO MUSIC

THE MARK CONSISTS OF STANDARD CHARACTERS WITHOUT CLAIM TO ANY PARTICULAR FONT, STYLE, SIZE, OR COLOR.

NO CLAIM IS MADE TO THE EXCLUSIVE RIGHT TO USE "MUSIC", APART FROM THE MARK AS SHOWN.

FOR AUDIO, VIDEO, AND SOUND RECORDINGS FEATURING MUSIC (U.S. CLS. 21, 23, 26, 36 AND 38).
KEVON CHISOLM, EXAMINING ATTORNEY

SN 76-651,725. AMPHIBIOUS ZOO ENTERTAINMENT
GROUP, LLC, DRAPER, UT. FILED 12-5-2005.

AMPHIBIOUS ZOO ENTERTAINMENT

THE MARK CONSISTS OF STANDARD CHARACTERS WITHOUT CLAIM TO ANY PARTICULAR FONT, STYLE, SIZE, OR COLOR.

NO CLAIM IS MADE TO THE EXCLUSIVE RIGHT TO USE "ENTERTAINMENT", APART FROM THE MARK AS SHOWN.

FOR AUDIO, VIDEO, AND SOUND RECORDINGS FEATURING MUSIC (U.S. CLS. 21, 23, 26, 36 AND 38).
KEVON CHISOLM, EXAMINING ATTORNEY

CLASS 9—(Continued).

SN 76-651,850. LAICHANG TECHNOLOGY INC., TAIPEI, TAIWAN, FILED 12-14-2005.



THE MARK CONSISTS OF A CURVING ROAD WITH A SUN RISING AT THE END OF THE ROAD ON THE RIGHT, BELOW THAT IS THE WORD "LAICHANG" WITH THE "A" BEING FORMED BY A CAR.

FOR TACHOMETER; SPEEDOMETER; PYROMETER; TEMPERATURE GAUGE; PRESSURE GAUGE; FUEL GAUGE; AMMETER AND VOLTMETER; VACUUM GAUGE; ENGINE REVOLUTION COUNTER HOUR-METER; SENDER, NAMELY A DETECTOR THAT COLLECTS INSTANT INFORMATION AND TRANSMITS SAME TO A GAUGE INDICATOR OR OTHER DEVICE FOR FURTHER PROCESSING (U.S. CLS. 21, 23, 26, 36 AND 38).

JESSICA A. POWERS, EXAMINING ATTORNEY

SN 76-651,851. LAICHANG TECHNOLOGY INC., TAIPEI, TAIWAN, FILED 12-14-2005.



THE MARK CONSISTS OF THE WORD "LAICHANG" WITH THE "A" BEING FORMED BY A CAR.

FOR TACHOMETER; SPEEDOMETER; PYROMETER; TEMPERATURE GAUGE; PRESSURE GAUGE; FUEL GAUGE; AMMETER AND VOLTMETER; VACUUM GAUGE; ENGINE REVOLUTION COUNTER HOUR-METER; SENDER, NAMELY A DETECTOR THAT COLLECTS INSTANT INFORMATION AND TRANSMITS SAME TO A GAUGE INDICATOR OR OTHER DEVICE FOR FURTHER PROCESSING (U.S. CLS. 21, 23, 26, 36 AND 38).

JESSICA A. POWERS, EXAMINING ATTORNEY

SN 76-652,648. GOCHA, ALAN, FRANKLIN, MI. FILED 12-29-2005.

CAPTURING THE REAL YOU

THE MARK CONSISTS OF STANDARD CHARACTERS WITHOUT CLAIM TO ANY PARTICULAR FONT, STYLE, SIZE, OR COLOR.

FOR COMPACT DISKS, DVD'S, VIDEOTAPES, AUDIO RECORDINGS, SOUND RECORDINGS, LASER DISKS, DOWNLOADABLE VIDEO RECORDINGS, FEATURING INTERVIEWS OF OTHERS (U.S. CLS. 21, 23, 26, 36 AND 38).

TONI HICKEY, EXAMINING ATTORNEY

CLASS 9—(Continued).

SN 76-653,243. AMBIENT CONTROL SYSTEMS, INC., EL CAJON, CA. FILED 1-11-2006.

LEIT

THE MARK CONSISTS OF STANDARD CHARACTERS WITHOUT CLAIM TO ANY PARTICULAR FONT, STYLE, SIZE, OR COLOR.

FOR LIGHT ENERGIZED ELECTRONIC SYSTEMS CONSISTING OF CONTROLLERS, ACTUATORS, COMPUTERS, AND SENSORS FOR MONITORING, REPORTING, AND CONTROLLING ENVIRONMENTAL CONDITIONS RELATING TO THE NATURE OF IRRIGATION (U.S. CLS. 21, 23, 26, 36 AND 38).

FIRST USE 6-1-1992; IN COMMERCE 6-1-1992.

KATHERINE E. HALMEN, EXAMINING ATTORNEY

SN 76-656,188. RIMTEC, INC., SCOTTSDALE, AZ. FILED 3-7-2006.

FIREAPPS

THE MARK CONSISTS OF STANDARD CHARACTERS WITHOUT CLAIM TO ANY PARTICULAR FONT, STYLE, SIZE, OR COLOR.

FOR FINANCIAL RISK MANAGEMENT SOFTWARE (U.S. CLS. 21, 23, 26, 36 AND 38).

NICHOLAS ALTREE, EXAMINING ATTORNEY

CLASS 9—(Continued).

SN 76-657,328. MAGS ENTERTAINMENT, LLC, GREENWOOD, SC. FILED 3-24-2006.

**BEARSHEBA J. BEAR
BJ'S TEDDY BEAR CLUB
AND BIBLE STORIES**

THE MARK CONSISTS OF STANDARD CHARACTERS WITHOUT CLAIM TO ANY PARTICULAR FONT, STYLE, SIZE, OR COLOR.

NO CLAIM IS MADE TO THE EXCLUSIVE RIGHT TO USE "BIBLE STORIES", APART FROM THE MARK AS SHOWN.

THE NAME BEARSHEBA J. BEAR DOES NOT IDENTIFY A LIVING INDIVIDUAL.

FOR PRERECORDED VIDEO TAPES, DVD'S, AUDIO CASSETTES AND COMPACT DISCS PREDOMINANTLY FOR USE BY CHILDREN FEATURING ANIMATION, MUSIC, BIBLE TEACHINGS, CHILDREN'S STORIES, EDUCATIONAL MATERIALS, ACTION-ADVENTURE, COMEDY, GAMES AND FUN ACTIVITIES FOR CHILDREN; MUSICAL SOUND RECORDINGS; COMPUTER SOFTWARE GAMES; INTERACTIVE VIDEO GAME PROGRAMS; COMPUTER SOFTWARE, MULTIMEDIA SOFTWARE AND INTERACTIVE SOFTWARE PREDOMINANTLY FOR USE BY CHILDREN FEATURING ANIMATION, MUSIC, BIBLE TEACHINGS, CHILDREN'S STORIES, EDUCATIONAL MATERIALS, ACTION-ADVENTURE, COMEDY, GAMES AND FUN ACTIVITIES FOR CHILDREN; COMPUTER AND VIDEO GAME CARTRIDGES (U.S. CLS. 21, 23, 26, 36 AND 38).

KATHERINE E. HALMEN, EXAMINING ATTORNEY

SN 76-657,727. AQUA COMMUNICATIONS, INC., WALTHAM, MA. FILED 4-3-2006.

ENERGYBOX

THE MARK CONSISTS OF STANDARD CHARACTERS WITHOUT CLAIM TO ANY PARTICULAR FONT, STYLE, SIZE, OR COLOR.

FOR POWER SUPPLY ASSEMBLY IN THE NATURE OF A BOX COMPRISED OF BATTERY, ELECTRIC PLUGS, CABLE CONNECTORS, ELECTRONIC CONTROLS FOR ADJUSTING POWER SUPPLY TO ACCOMMODATE DIVERSE ELECTRICAL APPLIANCES (U.S. CLS. 21, 23, 26, 36 AND 38).

KATHERINE STOIDES, EXAMINING ATTORNEY

CLASS 9—(Continued).

SN 76-658,296. VENTURE MEASUREMENT COMPANY, LLC, SPARTANBURG, SC. FILED 4-12-2006.

ROTO-BIN-DICATOR

THE MARK CONSISTS OF STANDARD CHARACTERS WITHOUT CLAIM TO ANY PARTICULAR FONT, STYLE, SIZE, OR COLOR.

OWNER OF U.S. REG. NO. 625,300.

FOR BIN OR TANK LEVEL INDICATORS AND BIN OR TANK LEVEL CONTROLS (U.S. CLS. 21, 23, 26, 36 AND 38).

FIRST USE 7-8-1955; IN COMMERCE 7-8-1955.

ANDREA EVANS, EXAMINING ATTORNEY

SN 76-658,404. AVORA HOLDINGS, LTD., NEWARK, DE. FILED 4-12-2006.

SALESFOLDER

THE MARK CONSISTS OF STANDARD CHARACTERS WITHOUT CLAIM TO ANY PARTICULAR FONT, STYLE, SIZE, OR COLOR.

FOR COMPUTER PROGRAMS FOR USE IN SYNCHRONIZING AND RECORDING PROPOSALS, CONTRACTS, CALL AND MEETING AGENDAS, CALL AND MEETING MINUTES AND E-MAILS AND INSTANT MESSAGING LOGS (U.S. CLS. 21, 23, 26, 36 AND 38).

PAMELA HIRSCHMAN, EXAMINING ATTORNEY

SN 76-658,419. TIMERWELL COMPUTER LIMITED, NEW TERRITORY HONG KONG, CHINA, FILED 4-13-2006.

AVIXE

THE MARK CONSISTS OF STANDARD CHARACTERS WITHOUT CLAIM TO ANY PARTICULAR FONT, STYLE, SIZE, OR COLOR.

FOR ELECTRONIC LUMINESCENT DISPLAY PANELS; COMPUTER MONITORS; VIDEO MONITORS; VIDEO CAMERAS; COMPUTER HARDWARE; COMPUTER CABLES; COAXIAL CABLES; COMPUTER DOCKING STATIONS; COMPUTERS; COMPUTER CARRYING CASES; FLAT PANEL COMPUTER DISPLAY SCREENS; PERSONAL COMPUTER MONITORS; COMPACT KEYBOARDS; TELEVISION SETS; TELEVISION ANTENNA; FILTERS FOR TELEVISION AND MOTION PICTURE FILM CAMERAS AND PROGRAMMABLE DIGITAL TELEVISION RECORDERS (U.S. CLS. 21, 23, 26, 36 AND 38).

ELLEN PERKINS, EXAMINING ATTORNEY

CLASS 9—(Continued).

SN 76-658,651. PRAVATA, GEORGE, BROOKLYN, NY. AND PRAVATA, LOURDES, BROOKLYN, NY. FILED 4-18-2006.

SILLY BOYZ

THE MARK CONSISTS OF STANDARD CHARACTERS WITHOUT CLAIM TO ANY PARTICULAR FONT, STYLE, SIZE, OR COLOR.

FOR PRESSURE GAUGES AND PRESSURE SWITCHES FOR CALIBRATING PAINT BALL GUNS (U.S. CLS. 21, 23, 26, 36 AND 38).

MAUREEN DALL, EXAMINING ATTORNEY

CLASS 9—(Continued).

SN 78-163,715. XCHANGE NETWORK, LLC., ANN ARBOR, MI. FILED 9-13-2002.

XCHANGE NETWORK

NO CLAIM IS MADE TO THE EXCLUSIVE RIGHT TO USE "NETWORK", APART FROM THE MARK AS SHOWN. FOR COMPUTER SOFTWARE; NAMELY COLLABORATION SOFTWARE, WHICH PROVIDES FOR THE COLLABORATION OF ELECTRONIC FILES, CALENDAR, CONTACT, AND TASK DATA (U.S. CLS. 21, 23, 26, 36 AND 38).

CHERYL CLAYTON, EXAMINING ATTORNEY

SN 78-245,750. JOHN M. FLOYD & ASSOCIATES, INC., BAYTOWN, TX. FILED 5-5-2003.

PRIVILEGE MANAGER CRM

NO CLAIM IS MADE TO THE EXCLUSIVE RIGHT TO USE CRM, APART FROM THE MARK AS SHOWN.

FOR COMPUTER SOFTWARE FOR USE IN PROVIDING MANAGEMENT REPORTS, CUSTOM REPORTS AND ACCOUNT HOLDER COMMUNICATIONS FOR FINANCIAL INSTITUTIONS IN CONNECTION WITH THEIR OVERDRAFT PRIVILEGE PROGRAMS AND THE SUPERVISION OF OVERDRAWN ACCOUNTS AND THE CUSTOMER RELATIONS (U.S. CLS. 21, 23, 26, 36 AND 38).

FIRST USE 5-1-2004; IN COMMERCE 5-1-2004.
TONI HICKEY, EXAMINING ATTORNEY

SN 76-658,839. TISSUE GROWTH TECHNOLOGIES CORPORATION, MINNETONKA, MN. FILED 4-20-2006.

DYNAGEN

THE MARK CONSISTS OF STANDARD CHARACTERS WITHOUT CLAIM TO ANY PARTICULAR FONT, STYLE, SIZE, OR COLOR.

FOR LABORATORY EQUIPMENT FOR STIMULATING THE GROWTH OF LIVE TISSUE (U.S. CLS. 21, 23, 26, 36 AND 38).

FIRST USE 3-19-2006; IN COMMERCE 3-19-2006.
DAVID COLLIER, EXAMINING ATTORNEY

SN 78-395,110. HUANG, TAI-TUNG, SAN DIEGO, CA. FILED 4-1-2004.



SN 76-658,840. TISSUE GROWTH TECHNOLOGIES CORPORATION, MINNETONKA, MN. FILED 4-20-2006.

GROWTHWORKS

THE MARK CONSISTS OF STANDARD CHARACTERS WITHOUT CLAIM TO ANY PARTICULAR FONT, STYLE, SIZE, OR COLOR.

FOR AUTOMATED PROCESS CONTROL SYSTEM, NAMELY, MICRO-PROCESSOR BASED SOFTWARE USED TO CONTROL LABORATORY EQUIPMENT THAT STIMULATES THE GROWTH OF LIVE TISSUE (U.S. CLS. 21, 23, 26, 36 AND 38).

FIRST USE 3-19-2006; IN COMMERCE 3-19-2006.
DAVID COLLIER, EXAMINING ATTORNEY

THE COLOR(S) RED, YELLOW AND BLUE IS/ARE CLAIMED AS A FEATURE OF THE MARK.

THE LETTERS GRS ARE BLUE, THE FLAME THAT APPEARS ABOVE THE LETTERING IS RED WITH A YELLOW CENTER.

FOR GAS DETECTORS FOR DETECTING THE PRESENCE OF GAS (U.S. CLS. 21, 23, 26, 36 AND 38).
FIRST USE 1-1-2004; IN COMMERCE 1-1-2004.
JENNY PARK, EXAMINING ATTORNEY

CLASS 9—(Continued).

SN 78-401,427. PLESCON LIMITED, IPSWICH, SUFFOLK IPI 5AP, UNITED KINGDOM, FILED 4-14-2004.

CLASS 9—(Continued).

SN 78-479,665. SEARFOSS, THURSTON, POWNAL, ME. FILED 9-7-2004.

BOTTLELOX

LOST ADMIRAL

THE MARK CONSISTS OF STANDARD CHARACTERS WITHOUT CLAIM TO ANY PARTICULAR FONT, STYLE, SIZE, OR COLOR.

PRIORITY CLAIMED UNDER SEC. 44(D) ON ERPN CMNTY TM OFC APPLICATION NO. 003601242, FILED 1-22-2004, REG. NO. 003601242, DATED 5-25-2005, EXPIRES 1-22-2014.

FOR ANTI-THEFT SECURITY DEVICES AND ACCESS RESTRICTING DEVICES FOR USE WITH CONTAINERS AND BOTTLES, NAMELY, AN ELECTRONIC TRIGGERING DEVICE FOR PROTECTING AND SECURING CONTAINERS AND BOTTLES FROM THEFT AND RELEASE DEVICES FOR USE THEREWITH (U.S. CLS. 21, 23, 26, 36 AND 38).

JENNY PARK, EXAMINING ATTORNEY

THE MARK CONSISTS OF STANDARD CHARACTERS WITHOUT CLAIM TO ANY PARTICULAR FONT, STYLE, SIZE, OR COLOR.

FOR COMPUTER GAME SOFTWARE, NAMELY, GAME SOFTWARE DESIGNED TO RUN ON PERSONAL COMPUTERS AND INVOLVING NAVAL BATTLES AND STRATEGY (U.S. CLS. 21, 23, 26, 36 AND 38).

FIRST USE 6-30-2003; IN COMMERCE 6-30-2003.

ELISSA GARBER KON, EXAMINING ATTORNEY

SN 78-449,933. I3DVR INTERNATIONAL, SCARBOROUGH, ONTARIO, ONTARIO, FILED 7-13-2004.

SN 78-479,856. ANIMATED EARTH LLC, SILVER SPRING, MD. FILED 9-7-2004.

PAC DM

Earth Today

THE MARK CONSISTS OF STANDARD CHARACTERS WITHOUT CLAIM TO ANY PARTICULAR FONT, STYLE, SIZE, OR COLOR.

NO CLAIM IS MADE TO THE EXCLUSIVE RIGHT TO USE "DM", APART FROM THE MARK AS SHOWN.

FOR COMPUTER APPLICATION SOFTWARE FOR POINT OF SALE SYSTEM, ATM SYSTEMS, CARD ACCESS SYSTEMS, AND DATA MANAGEMENT SYSTEMS (U.S. CLS. 21, 23, 26, 36 AND 38).

JENNY PARK, EXAMINING ATTORNEY

THE MARK CONSISTS OF STANDARD CHARACTERS WITHOUT CLAIM TO ANY PARTICULAR FONT, STYLE, SIZE, OR COLOR.

NO CLAIM IS MADE TO THE EXCLUSIVE RIGHT TO USE "EARTH", APART FROM THE MARK AS SHOWN.

FOR ELECTRONIC LCD EDUCATIONAL DISPLAY UNIT WITH MULTI-NETWORKING (TCP/IP) CAPABILITIES ALLOWING TOUCH SCREEN ACCESS TO INFORMATION WITHIN ITS DATABASE WHICH CAN BE DISPLAYED THROUGH A VARIETY OF VIEWING SYSTEMS (U.S. CLS. 21, 23, 26, 36 AND 38).

DAVID TAYLOR, EXAMINING ATTORNEY

CLASS 9—(Continued).

SN 78-481,433. NEW FRONTIER ELECTRONICS, INC.,
PIPERSVILLE, PA. FILED 9-10-2004.

CLASS 9—(Continued).

SN 78-527,111. KINDRED INC, ALBANY, NY. FILED 12-4-
2004.

TRUE SERIES MODE

THE MARK CONSISTS OF STANDARD CHARACTERS
WITHOUT CLAIM TO ANY PARTICULAR FONT, STYLE,
SIZE, OR COLOR.

OWNER OF U.S. REG. NO. 3,141,190.
SEC. 2(F) AS TO "SERIES MODE".
FOR POWER LINE SURGE SUPPRESSORS (U.S. CLS.
21, 23, 26, 36 AND 38).
KELLY BOULTON, EXAMINING ATTORNEY

PIPE DREAM

THE MARK CONSISTS OF STANDARD CHARACTERS
WITHOUT CLAIM TO ANY PARTICULAR FONT, STYLE,
SIZE, OR COLOR.

FOR VIDEO GAME SOFTWARE (U.S. CLS. 21, 23, 26,
36 AND 38).
KELLEY WELLS, EXAMINING ATTORNEY

SN 78-488,169. THE SECRETARY OF STATE FOR DEFENCE,
LONDON, UNITED KINGDOM, FILED 9-23-2004.

SN 78-536,826. LARCAN INC., MISSISSAUGA, ONTARIO,
CANADA, FILED 12-22-2004.

TOTALTIDE

THE MARK CONSISTS OF STANDARD CHARACTERS
WITHOUT CLAIM TO ANY PARTICULAR FONT, STYLE,
SIZE, OR COLOR.

FOR COMPUTER SOFTWARE FOR USE IN NAVIGA-
TION; COMPUTER SOFTWARE FOR PREDICTING
TIDES AND CURRENTS; COMPUTER SOFTWARE FOR
REPRESENTING HYDROGRAPHIC OCEANOGRAPHIC
AND NAVIGATIONAL DATA IN THE FORM OF AN
ELECTRONICALLY-PRODUCED IMAGE; ELECTRONIC
DATABASES RECORDED ON COMPUTER MEDIA FEAT-
URING HYDROGRAPHIC OCEANOGRAPHIC AND
NAVIGATIONAL DATA (U.S. CLS. 21, 23, 26, 36 AND 38).
FIRST USE 5-1-2001; IN COMMERCE 10-22-2001.
SUNG IN, EXAMINING ATTORNEY

MD SERIES

THE MARK CONSISTS OF STANDARD CHARACTERS
WITHOUT CLAIM TO ANY PARTICULAR FONT, STYLE,
SIZE, OR COLOR.

PRIORITY CLAIMED UNDER SEC. 44(D) ON CANADA
APPLICATION NO. 1222133, FILED 6-29-2004, REG. NO.
TMA658193, DATED 2-7-2006, EXPIRES 2-7-2021.
FOR DIGITAL VHF TV TRANSMITTER (U.S. CLS. 21,
23, 26, 36 AND 38).
JEAN IM, EXAMINING ATTORNEY

CLASS 9—(Continued).

SN 78-544,769. FILESX, INC., SOUTHBOROUGH, MA. FILED 1-10-2005.

CLASS 9—(Continued).

SN 78-556,910. TIDAL SOFTWARE, INC., PALO ALTO, CA. FILED 1-31-2005.

FILESX TAPELESS BRANCHES

Expert-in-a-Box

THE MARK CONSISTS OF STANDARD CHARACTERS WITHOUT CLAIM TO ANY PARTICULAR FONT, STYLE, SIZE, OR COLOR.

NO CLAIM IS MADE TO THE EXCLUSIVE RIGHT TO USE "TAPELESS BRANCHES", APART FROM THE MARK AS SHOWN.

FOR COMPUTER PROGRAMS THAT ENABLE THE BACKUP AND RESTORATION OF COMPUTER SYSTEMS, DATA AND APPLICATION DATA IN MULTIPLE FORMATS AND PROVIDE CENTRAL MANAGEMENT OF MULTIPLE COMPUTER STORAGE LOCATIONS TO PIN-POINT RETRIEVAL OF COMPUTER SYSTEMS, DATA AND APPLICATION DATA FROM A SINGLE PROCESS (U.S. CLS. 21, 23, 26, 36 AND 38).

STEVEN R. FINE, EXAMINING ATTORNEY

THE MARK CONSISTS OF STANDARD CHARACTERS WITHOUT CLAIM TO ANY PARTICULAR FONT, STYLE, SIZE, OR COLOR.

FOR COMPUTER SOFTWARE FOR MANAGING AND AUTOMATING ENTERPRISE COMPUTING SYSTEMS AND BUSINESS APPLICATIONS THEREIN IN THE FIELD OF AUTOMATION (U.S. CLS. 21, 23, 26, 36 AND 38).

SANI KHOURI, EXAMINING ATTORNEY

SN 78-556,025. FAROUK SYSTEMS, INC., HOUSTON, TX. FILED 1-28-2005.

SN 78-557,990. MINE SAFETY APPLIANCES COMPANY, PITTSBURGH, PA. FILED 2-1-2005.

CHE

SAFE ESCAPE

THE MARK CONSISTS OF STANDARD CHARACTERS WITHOUT CLAIM TO ANY PARTICULAR FONT, STYLE, SIZE, OR COLOR.

FOR ELECTRIC HAIR CURLING IRONS (U.S. CLS. 21, 23, 26, 36 AND 38).

THEODORE MCBRIDE, EXAMINING ATTORNEY

THE MARK CONSISTS OF STANDARD CHARACTERS WITHOUT CLAIM TO ANY PARTICULAR FONT, STYLE, SIZE, OR COLOR.

NO CLAIM IS MADE TO THE EXCLUSIVE RIGHT TO USE "ESCAPE", APART FROM THE MARK AS SHOWN.

FOR PERSONAL SAFETY EQUIPMENT, NAMELY, RESPIRATORS, INCLUDING A HOOD AND A CANISTER, FOR USE IN EMERGENCY AND ESCAPE SITUATIONS TO PROVIDE RESPIRATORY PROTECTION AGAINST CHEMICAL AND BIOLOGICAL AGENTS (U.S. CLS. 21, 23, 26, 36 AND 38).

DAVID TAYLOR, EXAMINING ATTORNEY

CLASS 9—(Continued).

SN 78-558,595. HARMAN INTERNATIONAL INDUSTRIES, INCORPORATED, NORTHRIDGE, CA. FILED 2-2-2005.

HARMAN/KARDON INFOTAINMENT

THE MARK CONSISTS OF STANDARD CHARACTERS WITHOUT CLAIM TO ANY PARTICULAR FONT, STYLE, SIZE, OR COLOR.

FOR NAVIGATION APPARATUS FOR LAND VEHICLES IN THE NATURE OF ON-BOARD COMPUTERS; INTERACTIVE MULTIMEDIA COMPUTER PROGRAMS USED TO OPERATE GLOBAL POSITIONING SYSTEMS AND WIRELESS CELLULAR COMMUNICATIONS; LOUDSPEAKERS, ACOUSTIC TRANSDUCERS, AMPLIFIERS AND PREAMPLIFIERS, VIDEO SCREENS; AND WIRELESS INTERNET DEVICES WHICH PROVIDE TELEMATIC SERVICES AND HAVE A CELLULAR PHONE FUNCTION (U.S. CLS. 21, 23, 26, 36 AND 38).

DAVID C. REIHNER, EXAMINING ATTORNEY

SN 78-559,246. KASABIAN, LONDON, UNITED KINGDOM, FILED 2-2-2005.

KASABIAN

THE MARK CONSISTS OF STANDARD CHARACTERS WITHOUT CLAIM TO ANY PARTICULAR FONT, STYLE, SIZE, OR COLOR.

PRIORITY CLAIMED UNDER SEC. 44(D) ON ERP CMNTY TM OFC APPLICATION NO. 004259032, FILED 1-24-2005, REG. NO. 004259032, DATED 3-21-2006, EXPIRES 1-24-2015.

FOR MUSICAL SOUND AND VIDEO RECORDINGS; DOWNLOADABLE MUSICAL SOUND AND VIDEO RECORDINGS (U.S. CLS. 21, 23, 26, 36 AND 38).

JULIE GUTTADAURO, EXAMINING ATTORNEY

CLASS 9—(Continued).

SN 78-569,037. SUN MICROSYSTEMS, INC., SANTA CLARA, CA. FILED 2-16-2005.

STREAMSTAR

THE MARK CONSISTS OF STANDARD CHARACTERS WITHOUT CLAIM TO ANY PARTICULAR FONT, STYLE, SIZE, OR COLOR.

FOR COMPUTER HARDWARE; COMPUTER PERIPHERALS; COMPUTERS; COMPUTER OPERATING SYSTEMS; HAND-HELD COMPUTERS; MAINFRAME-CLASS COMPUTERS; COMPUTER WORKSTATIONS; VIDEO MONITORS, VIDEO SCREENS, AND FLAT PANEL DISPLAY SCREENS; KEYBOARDS; COMPUTER MONITORS; COMPUTER HARDWARE, NAMELY COMMUNICATIONS SERVERS, FILE SERVERS, WEB SERVERS, AND NETWORK ACCESS SERVER HARDWARE; DISC DRIVES; COMPUTER DATA STORAGE DEVICES, NAMELY TAPE LIBRARIES, DISK ARRAYS, AND STORAGE ARRAYS; INTEGRATED CIRCUITS; COMPUTER INTERFACE BOARDS; MODEMS; COMPUTER MOUSE POINTING DEVICES; MOUSE PADS; PRINTERS AND PRINTER PERIPHERALS; PRINTED CIRCUIT BOARDS CONTAINING ELECTRICAL COMPONENTS AND SOCKETS; COMPUTER PROCESSING UNITS AND COMPUTER MEMORIES; BLANK MAGNETIC DATA CARRIERS; AUDIO CASSETTE RECORDERS; AUDIO CASSETTE PLAYERS; COMPACT DISC PLAYERS; COMPACT DISC RECORDERS; BLANK COMPUTER RECORDING DISCS; CASH REGISTERS; CALCULATORS; COMPUTER CHIPS; COMPUTER DISK DRIVES; BLANK COMPUTER DISCS; DATA PROCESSORS; DIGITAL CAMERAS; DIGITAL VIDEO RECORDERS; ELECTRONIC ENCRYPTION UNITS; FACSIMILE MACHINES; GLOBAL POSITIONING SYSTEM TRANSMITTERS AND RECEIVERS; INTERNET TELEVISION HARDWARE; MICROPROCESSORS; MICROCOMPUTERS; MINICOMPUTERS; MOTION PICTURE CAMERAS; OPTICAL SCANNERS; OSCILLOSCOPES; PEDOMETERS; PHOTOCOPYING MACHINES; PERSONAL DIGITAL ASSISTANTS; PHOTOGRAPHIC CAMERAS; PHOTOGRAPHIC PROJECTORS; SLIDE PROJECTORS; RADIO PAGERS; RADIOS, AUTOMATIC VENDING MACHINES; SCANNERS; BLANK SMART CARDS, ENCODED SMART CARDS CONTAINING PROGRAMMING USED TO ACCESS COMPUTER NETWORKS, AND PROGRAMMABLE SMART CARDS; SMART CARD READERS; TELEPHONES; TELEPHONE ANSWERING MACHINES; TELEVISION SETS; TELEVISION SET TOP BOXES; THERMOSTATS; VIDEO CAMERAS; VIDEO CASSETTE RECORDERS; VIDEO MONITORS; VIDEO TAPE RECORDERS; VOICE MESSAGING SYSTEMS COMPRISED OF COMPUTER HARDWARE AND SOFTWARE FOR USE IN OPERATING VOICE MAIL AND VOICE MESSAGING; VOTING MACHINES; WEB TELEPHONES; WIRELESS DATA COMMUNICATIONS HARDWARE; COMPUTER PROGRAMS FOR TESTING COMPATIBILITY OF COMPUTER PROGRAMS; COMPUTER PROGRAMS FOR USE IN COMPUTER NETWORKING; COMPUTER PROGRAMS FOR USE IN COMPUTER EMULATION; COMPUTER PROGRAMS FOR USE IN ELECTRONIC MAIL; COMPUTER PROGRAMS FOR CREATING GRAPHICAL INTERFACES; COMPUTER PROGRAMS FOR USE IN DATABASE MANAGEMENT; COMPUTER PROGRAMS FOR DOCUMENT PROCESSING; COMPUTER PROGRAMS FOR WORD PROCESSING; COMPUTER PROGRAMS FOR PREPARING SPREADSHEETS; COMPUTER PROGRAMS FOR USE IN COMPUTER SECURITY; COMPUTER PROGRAMS FOR USE IN THE DEVELOPMENT OF COMPUTER PROGRAMS, PROGRAMMING LANGUAGES, TOOL KITS AND COMPILERS; COMPUTER PROGRAMS FOR USE IN DEVELOPING, COMPILING AND EXECUTING OTHER COMPUTER PROGRAMS ON COMPUTERS, COMPUTER NETWORKS, AND GLOBAL COMMUNICATIONS NETWORKS; COMPUTER PROGRAMS FOR USE IN NAVIGATING, BROWSING, TRANSFERRING INFORMATION, AND DISTRIBUTING AND VIEWING OTHER COMPUTER PROGRAMS ON COMPUTERS, COMPUTER NETWORKS AND GLOBAL COMMUNICATIONS NETWORKS; COMPUTER PROGRAMS FOR RECORDING, PROCESSING, RECEIVING, REPRODUCING, TRANSMITTING, MODIFYING,

CLASS 9—(Continued).

COMPRESSING, DECOMPRESSING, BROADCASTING, MERGING, AND/OR ENHANCING SOUND, VIDEO, IMAGES, GRAPHICS, AND/OR DATA; COMPUTER OPERATING SYSTEM PROGRAMS; COMPUTER UTILITY PROGRAMS; COMPUTER PROGRAMS FOR TRANSMITTING DATA AND IMAGES FOR USE WITH COMPUTER SERVERS; COMPUTER TELEPHONY SOFTWARE FOR ENABLING TELEPHONE ACTIVITIES TO BE PERFORMED BY A COMPUTER; COMPUTER PROGRAMS USED IN ACCESSING DATABASES; COMPUTER GAME PROGRAMS; COMPUTER PROGRAMS FOR THE STORAGE OF DATA AND INFORMATION DOWNLOADABLE FROM GLOBAL COMPUTER NETWORKS; AND INSTRUCTIONAL MANUALS SOLD THEREWITH; DOWNLOADABLE ELECTRONIC PUBLICATIONS IN THE NATURE OF MANUALS, MAGAZINES AND BOOKS IN THE FIELDS OF COMPUTING, COMPUTER NETWORKING, INFORMATION TECHNOLOGY AND DIGITAL VIDEO AND AUDIO TECHNOLOGY (U.S. CLS. 21, 23, 26, 36 AND 38).

MICHELE SWAIN, EXAMINING ATTORNEY

SN 78-570,917. BS&B SAFETY SYSTEMS LIMITED, RAHEEN COUNTY, IRELAND, FILED 2-18-2005.

BURST ALERT

THE MARK CONSISTS OF STANDARD CHARACTERS WITHOUT CLAIM TO ANY PARTICULAR FONT, STYLE, SIZE, OR COLOR.

OWNER OF U.S. REG. NO. 2,490,159.

NO CLAIM IS MADE TO THE EXCLUSIVE RIGHT TO USE "ALERT", APART FROM THE MARK AS SHOWN.

FOR ELECTRONICALLY OPERATED SENSORS TO SIGNAL RUPTURE DISK ACTIVATION (U.S. CLS. 21, 23, 26, 36 AND 38).

FIRST USE 5-15-1990; IN COMMERCE 5-15-1990.

SEAN CROWLEY, EXAMINING ATTORNEY

CLASS 9—(Continued).

SN 78-577,887. INFOCUS CORPORATION, WILSONVILLE, OR. FILED 3-1-2005.

X SERIES

THE MARK CONSISTS OF STANDARD CHARACTERS WITHOUT CLAIM TO ANY PARTICULAR FONT, STYLE, SIZE, OR COLOR.

NO CLAIM IS MADE TO THE EXCLUSIVE RIGHT TO USE "SERIES", APART FROM THE MARK AS SHOWN.

FOR MULTIMEDIA PROJECTORS; VIDEO PROJECTORS; PICTURE PROJECTORS; PHOTOGRAPHIC PROJECTORS; PRESENTATION MULTIMEDIA PROJECTORS FOR BUSINESS AND EDUCATION USE; HOME THEATER MULTIMEDIA PROJECTORS FOR DISPLAY OF VIDEOS AND MOVIES; LIQUID CRYSTAL DISPLAY (LCD) PROJECTORS; COMPUTER SOFTWARE FOR THE PROJECTION, PROCESSING, ADMINISTRATION, AND DISPLAY OF IMAGES, GRAPHICS AND TEXT; ACCESSORIES AND COMPONENTS FOR PROJECTORS, NAMELY CASES FOR PROJECTORS, NAMELY CARRYING CASES, HARD CASES, SOFT CASES; CABLES AND ADAPTERS FOR PROJECTORS, NAMELY MULTIMEDIA ADAPTERS AND CABLES, VIDEO ADAPTERS AND CABLES, AUDIO ADAPTERS AND CABLES; MOUNTS FOR PROJECTORS, NAMELY CEILING AND WALL MOUNTS; REMOTE CONTROL UNITS FOR PROJECTORS; WIRELESS NETWORKING REMOTE CONTROL UNITS FOR PROJECTORS (U.S. CLS. 21, 23, 26, 36 AND 38).

SOPHIA S. KIM, EXAMINING ATTORNEY

SN 78-581,322. SONY KABUSHIKI KAISHA, TA SONY CORPORATION, TOKYO, JAPAN, FILED 3-7-2005.

Compact Vault

THE MARK CONSISTS OF STANDARD CHARACTERS WITHOUT CLAIM TO ANY PARTICULAR FONT, STYLE, SIZE, OR COLOR.

OWNER OF U.S. REG. NOS. 2,798,607 AND 2,900,351.

FOR COMPUTER HARD DISK DRIVES (U.S. CLS. 21, 23, 26, 36 AND 38).

KHANH LE, EXAMINING ATTORNEY

CLASS 9—(Continued).

SN 78-583,192. LISHON, SUZANNE, WOODLAND HILLS, CA. FILED 3-8-2005.



THE COLOR(S) BLACK, WHITE, YELLOW, BLUE, ORANGE, RED, LIGHT GREEN, GREEN, TEAL, PINK, BLUE, DARK BLUE AND PURPLE IS/ARE CLAIMED AS A FEATURE OF THE MARK.

THE MARK CONSISTS OF THE WORDS STORY ORBS ENCLOSED WITHIN A YELLOW RECTANGLE OUTLINED IN BLUE. THE LETTER S IN STORY IS ORANGE, OUTLINED IN BLACK, AND IS SUPERIMPOSED OVER A BLUE STAR. THE LETTER T IN STORY IS YELLOW AND OUTLINED IN BLACK, THE LETTER O IN STORY CONSISTS OF A RED CIRCLE WITH A WHITE HIGHLIGHT IN THE UPPER LEFT QUADRANT AND A BLACK SHADOW, THE LETTER R IN STORY FADES FROM LIGHT GREEN TO GREEN FROM LEFT TO RIGHT AND IS OUTLINED IN BLACK, THE LETTER Y IN STORY IS TEAL AND OUTLINED IN BLACK. THE LETTER O IN ORBS CONSISTS OF A GREEN CIRCLE WITH A BLACK SHADOW AND A WHITE HIGHLIGHT IN THE UPPER LEFT QUADRANT OF THE SPHERE, SUPERIMPOSED OVER A PINK STAR, THE LETTER R IN ORBS FADES FROM BLUE TO DARK BLUE FROM LEFT TO RIGHT AND IS OUTLINED IN BLACK, THE LETTER B IN ORBS FADES FROM DARK BLUE TO PURPLE FROM LEFT TO RIGHT AND IS OUTLINED IN BLACK, AND THE LETTER S IN ORBS FADES FROM PURPLE TO PINK FROM LEFT TO RIGHT AND IS OUTLINED IN BLACK.

FOR AUDIO PLAY BACK MACHINE THAT USES ELECTRONIC MEMORY TO STORE AUDIO (U.S. CLS. 21, 23, 26, 36 AND 38).

MICHELLE DUBOIS, EXAMINING ATTORNEY

SN 78-583,906. SYSTEM INNOVATORS, INC., JACKSONVILLE, FL. FILED 3-9-2005.

INOVAH

THE MARK CONSISTS OF STANDARD CHARACTERS WITHOUT CLAIM TO ANY PARTICULAR FONT, STYLE, SIZE, OR COLOR.

FOR DATABASE MANAGEMENT SOFTWARE FOR PUBLIC UTILITIES AND GOVERNMENT ENTITIES IN THE AREAS OF TRANSACTIONAL DATA FOR COLLECTIONS, PAYMENTS AND DEPOSITS (U.S. CLS. 21, 23, 26, 36 AND 38).

FIRST USE 7-5-2005; IN COMMERCE 7-5-2005.
MICHAEL GAAFAR, EXAMINING ATTORNEY

CLASS 9—(Continued).

SN 78-585,836. NFS HOSPITALITY CORPORATION, HERTFORDSHIRE, UNITED KINGDOM, FILED 3-11-2005.



NO CLAIM IS MADE TO THE EXCLUSIVE RIGHT TO USE HOSPITALITY AND IT SOLUTIONS, APART FROM THE MARK AS SHOWN.

"THE COLOR(S) BLUE, GOLD, BROWN AND WHITE IS/ARE CLAIMED AS A FEATURE OF THE MARK."

THE MARK CONSISTS OF THE LETTERS NFS IN SPECIAL FORM IN BLUE APPEARING WITHIN A WHITE CIRCLE WITH A GOLD AND BROWN DESIGN AROUND THE CIRCLE, THE WORD HOSPITALITY WITH DOTS APPEARING UNDERNEATH, THE WORDS IT SOLUTIONS APPEARING UNDER THE DOTS IN GOLD, ALL APPEARING ON A BLUE BACKGROUND.

FOR BUSINESS MANAGEMENT SOFTWARE FOR THE HOSPITALITY INDUSTRY (U.S. CLS. 21, 23, 26, 36 AND 38).

SCOTT SISUN, EXAMINING ATTORNEY

SN 78-585,991. SYSTEM INNOVATORS, INC., JACKSONVILLE, FL. FILED 3-12-2005.



THE MARK CONSISTS OF THE TERM INOVAH PRECEDED BY A FIVE-POINT STAR.

FOR DATABASE MANAGEMENT SOFTWARE FOR PUBLIC UTILITIES AND GOVERNMENT ENTITIES IN THE AREAS OF TRANSACTIONAL DATA FOR COLLECTIONS, PAYMENTS AND DEPOSITS (U.S. CLS. 21, 23, 26, 36 AND 38).

FIRST USE 7-5-2005; IN COMMERCE 7-5-2005.
MICHAEL GAAFAR, EXAMINING ATTORNEY

CLASS 9—(Continued).

SN 78-593,532. V.I.O. INC., MARQUETTE, MI. FILED 3-23-2005.

RELIVE THE RIDE

THE MARK CONSISTS OF STANDARD CHARACTERS WITHOUT CLAIM TO ANY PARTICULAR FONT, STYLE, SIZE, OR COLOR.

FOR ELECTRONIC PRODUCTS AND PERIPHERALS; NAMELY, VIDEO OBSERVATION, COLLECTION, AND RECORDATION SYSTEMS COMPRISING A PORTABLE, TRANSPORTABLE, AND WEARABLE CAMERA, MOUNTING HARDWARE, COMPUTER PERIPHERALS AND SOFTWARE TO RECORD, STORE, ACCESS, REPRODUCE, TRANSMIT, MONITOR, AND DISSEMINATE IMAGES, EVENTS, GRAPHICAL DATA, SPECTRAL DATA, VISUAL AND AUDIOVISUAL CONTENT (U.S. CLS. 21, 23, 26, 36 AND 38).

DAWN FELDMAN, EXAMINING ATTORNEY

SN 78-599,246. COMPROD COMMUNICATIONS LTÉE, BOUCHERVILLE J4B 2X7, CANADA, FILED 3-31-2005.

XTC

THE MARK CONSISTS OF STANDARD CHARACTERS WITHOUT CLAIM TO ANY PARTICULAR FONT, STYLE, SIZE, OR COLOR.

PRIORITY CLAIMED UNDER SEC. 44(D) ON CANADA APPLICATION NO. 1238454, FILED 11-24-2004, REG. NO. TMA668140, DATED 7-18-2006, EXPIRES 7-18-2021.

FOR RADIO FREQUENCY SYSTEMS THAT PERFORM THE FUNCTION OF FILTERING SIGNALS WHICH TRANSMIT FROM ONE RADIO, COMPRISED PRIMARILY OF TRANSMITTERS FOR FILTERING WIRELESS TRANSMISSIONS, USED TO COMBINE MORE THAN ONE RADIO TRANSMITTER ONTO AN ANTENNA SYSTEM (U.S. CLS. 21, 23, 26, 36 AND 38).

PAM WILLIS, EXAMINING ATTORNEY

CLASS 9—(Continued).

SN 78-610,077. ARISTOCRAT TECHNOLOGIES AUSTRALIA PTY LTD, LANE COVE, NEW SOUTH WALES, AUSTRALIA, FILED 4-15-2005.

BAVARIAN BONUS

THE MARK CONSISTS OF STANDARD CHARACTERS WITHOUT CLAIM TO ANY PARTICULAR FONT, STYLE, SIZE, OR COLOR.

NO CLAIM IS MADE TO THE EXCLUSIVE RIGHT TO USE "BONUS", APART FROM THE MARK AS SHOWN.

FOR GAMING DEVICES, NAMELY, GAMING MACHINES AND COMPUTER SOFTWARE USED THEREWITH TO ENABLE THE GAMING MACHINE TO RUN (U.S. CLS. 21, 23, 26, 36 AND 38).

SEAN CROWLEY, EXAMINING ATTORNEY

SN 78-613,524. BECKWITH ELECTRIC CO., INC., LARGO, FL. FILED 4-21-2005.

ISSCOM

THE MARK CONSISTS OF STANDARD CHARACTERS WITHOUT CLAIM TO ANY PARTICULAR FONT, STYLE, SIZE, OR COLOR.

FOR COMPUTER PROGRAMS FOR USE IN THE COMMUNICATIONS FIELD THAT MONITORS ELECTRICAL POWER SYSTEMS PARAMETERS AND CHANGES THE SET POINTS OF ASSOCIATED SYNCHRONIZING SYSTEMS IN THE ELECTRIC UTILITY INDUSTRY (U.S. CLS. 21, 23, 26, 36 AND 38).

JOHN DALIER, EXAMINING ATTORNEY

SN 78-616,529. BELKIN CORPORATION, COMPTON, CA. FILED 4-25-2005.

MY ESSENTIALS

THE MARK CONSISTS OF STANDARD CHARACTERS WITHOUT CLAIM TO ANY PARTICULAR FONT, STYLE, SIZE, OR COLOR.

FOR COMPUTER, CELL PHONE AND CONSUMER ELECTRONICS ACCESSORIES, NAMELY, SPLITTERS, BAND SEPARATORS, ANTENNA SWITCHES, AMPLIFIERS, TRANSFORMERS, COUPLERS, AND CABLE CONNECTORS; VIDEO CASSETTE REWINDERS; AUDIO AND VIDEO POWER CONSOLES; AUDIO AND VIDEO POWER AND SIGNAL FILTERS; ELECTRONIC SWITCHING CONSOLES; AMPLIFIERS; SIGNAL BOOSTERS; COMPUTER HARDWARE ROUTERS, HUBS AND SWITCHES; COMPUTER NETWORK HUBS, ROUTERS AND SWITCHES; ELECTRICAL AND ELECTRONIC CONNECTORS; CONNECTION CABLES; ELECTRONIC CABLES; POWER WIRES; TELEPHONE WIRES; DIGITAL TRANSMISSION WIRES AND CABLES; ELECTRICAL AND ELECTRONIC PLUGS; CONVERTERS;

CLASS 9—(Continued).

ELECTRIC, CURRENT AND FREQUENCY CONVERTERS; TELEVISION AND VIDEO CONVERTERS; CABLE ADAPTERS AND SWITCHES; VIDEO TRANSMITTERS, RECEIVERS AND REMOTE CONTROLLERS; JOYSTICK ACCESSORIES, NAMELY, POWER ADAPTERS AND WIRELESS PLUGS AND CONNECTORS; TELEVISION/COMPUTER/VIDEO GAME SWITCHES; TELEPHONE, MOBILE PHONE AND CELL PHONE ACCESSORIES, NAMELY, SHOULDER RESTS, NOISE SUPPRESSORS, CONVERSION KITS COMPRISING ADAPTORS, CONNECTORS AND WIRES; MODULAR ELECTRICAL, ELECTRONIC AND TELEPHONE WIRES; MODULAR ELECTRICAL, ELECTRONIC AND TELEPHONE PLUGS; JACK BLOCKS; TELEPHONE EXTENSION SYSTEMS, COMPRISING CLAMP-ON JACKS AND WIRE WITH MODULAR PLUGS; TELEPHONE LINE TESTERS; TELEPHONE WALL OUTLETS; TELEPHONE STANDS; TELEPHONE SURFACE MOUNT JACKS; DUST COVERS FOR VIDEO CASSETTE RECORDERS; HEAD CLEANER TAPES FOR AUDIO AND VIDEO RECORDERS; COMPACT DISC STORAGE CASES; COAXIAL CABLE, CABLE ADAPTER PLUGS; CABLE SPLITTERS; TRANSFORMERS; CABLE CONNECTORS; ELECTRICAL POWER GROUND BLOCKS; ELECTRONIC SWITCHES; ELECTRICAL SWITCHES; SURGE PROTECTORS AND FREQUENCY CONVERTERS; ANTENNA CONTROLLERS AND CONVERTERS; COMPUTER CABLES; COMPUTER CABLE PLUGS AND CONNECTORS; ELECTRICAL VOLTAGE SUPPRESSORS; RIBBON EXTENSION CABLES; COMPUTER COOLING FANS; TELEVISION/COMPUTER SWITCHES; MODEMS AND MODEM CONNECTORS, HUBS AND ADAPTORS; AUDIO/STEREO ACCESSORIES, NAMELY, CASSETTE STORAGE CASES AND CABINETS, STEREO CABLES, AND SPEAKERS; EAR PADS FOR USE WITH AUDIO AND AUDIO/VIDEO DEVICES; HEADPHONES; HEADPHONE EXTENSIONS; STEREO PLUGS AND ADAPTERS; STEREO/MONO ADAPTER CABLES; TELEPHONE RECORDING PICK UP COILS; RADIO FREQUENCY FILTERS; STEREO HEADPHONE CORDS; MICROPHONES; PILLOW SPEAKERS; EARPHONES; ALTERNATING CURRENT ADAPTERS AND CONVERTERS; DIRECT CURRENT ADAPTERS AND CONVERTERS; STEREO SOUND SIMULATORS; BATTERY TESTERS; AUDIO CABLES; SPEAKER WIRES AND SPEAKER CABLES; ELECTRICITY CONVERTERS AND PLUGS; LIGHT SENSORS AND SECURITY LAMP CONTROLS; DATA TRANSFER SWITCH BOXES; COMPUTER PERIPHERAL SHARING DEVICES FOR ENABLING A PLURALITY OF COMPUTERS TO HAVE SHARED ACCESS TO AN ACCESSORY DEVICE OR DEVICES SUCH AS A PRINTER; COMPUTER PERIPHERAL SHARING DEVICES FOR ENABLING A SINGLE COMPUTER TO SIMULTANEOUSLY DISPLAY OUTPUT ON MULTIPLE MONITORS; ELECTRICAL SURGE PROTECTORS; COMPUTER PRINTER STANDS; MOUSE PADS; COMPUTER WRIST RESTS; COMPUTER MOUSE WRIST RESTS; COMPUTER PERIPHERAL DEVICES FOR PERMITTING WIRELESS TRANSMISSION OF DATA FROM COMPUTERS TO PERIPHERAL DEVICES AND FROM COMPUTER TO COMPUTE; CARRYING CASES FOR STORING AND TRANSPORTING PORTABLE COMPUTERS AND PERSONAL DATA ASSISTANTS; PERIPHERAL COMPONENT INTERCONNECT CARDS; NETWORK INTERFACE CARDS; UNIVERSAL SERIAL BUS AND ETHERNET ADAPTERS, CONNECTORS, CONTROLLERS, SWITCHES, TRANSCEIVERS, CABLES AND PLUGS; EXTENSION CORDS; EXTENSION CABLES; MOBILE POWER CORDS; MOBILE PHONE AND CELL PHONE CASES; KEYBOARDS; KEYPADS; PLUG ADAPTERS; PLUG CONNECTORS; PLUG-IN CONNECTORS; PORTABLE LISTENING DEVICES; PORTABLE MEDIA PLAYERS; POWER CONTROLLERS; POWER LINE CONDITIONERS; POWER SWITCHES; POWER TRANSFORMERS FOR AMPLIFICATION; POWER LINE TRANSMISSION MACHINES AND APPARATUS; PRINTED CIRCUITS; PRINTER CABLES; PRINTER HUBS; RACKS AND ENCLOSURES FOR COMPUTER HARDWARE, AMPLIFIERS AND SPEAKERS; COMPUTER GAME JOYSTICKS, CONTROLLERS, AND COMPUTER GAME MOUSE; BATTERIES AND RECHARGERS FOR PORTABLE DIGITAL LISTENING DEVICES, PORTABLE MEDIA PLAYERS, COMPUTERS, LAPTOPS, CELLULAR PHONES AND MOBILE PHONES; CORDLESS PHONES, WIRELESS TRANSMITTERS AND COMPUTER PERIPHERALS UNINTERRUPTIBLE POWER SUPPLIES; REMOTE CONTROLS FOR COMPU-

CLASS 9—(Continued).

TERS, TELEVISIONS, STEREOS, AMPLIFIERS, SPEAKERS, RECEIVERS, TUNERS AND RADIO, TELEVISION AND TELECOMMUNICATIONS TRANSMITTERS; STEREO TUNERS; RADIO FREQUENCY TRANSMITTERS; TELECOMMUNICATIONS TRANSMITTERS; TELEPHONE HEADSETS; TELEVISION TRANSMITTERS; TELEVISION APPARATUS FOR PROJECTION PURPOSES; UNIVERSAL PERIPHERAL INTERFACE HARDWARE; UNIVERSAL PERIPHERAL INTERFACE SOFTWARE; INFORMATION TECHNOLOGY SYSTEMS BRIDGE COMPUTER HARDWARE; UNIVERSAL SERIAL BUS OPERATING SOFTWARE; VIDEO CAPTURE CARDS; VIDEO PROCESSORS; VIDEO GRAPHICS CONTROLLER; VIDEO TRANSMISSION APPARATUS; VOLTAGE REGULATORS; VOLTAGE STABILIZERS; VOLTAGE STABILIZING POWER SUPPLIES; VIRTUAL PRIVATE NETWORK HARDWARE AND OPERATING SOFTWARE; WIDE AREA NETWORK HARDWARE AND OPERATING SOFTWARE; LOCAL AREA NETWORK HARDWARE AND OPERATING SOFTWARE; WIRELESS POINT OF SERVICE DEVICES; WIRELESS TELEPHONY APPARATUS; INTERNET TELEPHONY APPARATUS; WRIST RESTS FOR USE WITH COMPUTERS; CABLES AND FIBERS FOR THE TRANSMISSION OF SOUNDS AND IMAGES; CABLES FOR ELECTRICAL OR OPTICAL SIGNAL TRANSMISSION; CARD READING EQUIPMENT; COMPUTER CURSOR CONTROL DEVICES, NAMELY, COMPUTER MOUSE, DIGITIZER TABLETS, LIGHT PENS, STYLUS PENS, TOUCH PADS, TRACKBALLS; COMPUTER STYLUS; CONVERTERS; COMPUTER PERIPHERALS; COMPUTER NETWORKING HUBS AND SWITCHES; COMPUTER HARDWARE; WIRELESS AMPLIFIERS; COMPUTER MEMORIES; COMPUTER MEMORY HARDWARE; DISC MEMORIES; ELECTRONIC MEMORIES; MEMORY CARDS; MEMORY BOARDS; MEMORY EXPANSION MODULES (U.S. CLS. 21, 23, 26, 36 AND 38).

DOMINICK J. SALEMI, EXAMINING ATTORNEY

SN 78-617,816. TRAXI TECHNOLOGIES, LLC, NEW YORK CITY, NY. FILED 4-27-2005.

Volcrum

THE MARK CONSISTS OF STANDARD CHARACTERS WITHOUT CLAIM TO ANY PARTICULAR FONT, STYLE, SIZE, OR COLOR.

FOR COMPUTER SOFTWARE, NAMELY, NON-DOWNLOADABLE SOFTWARE USED TO MANAGE, INTEGRATE, CONTROL AND ADMINISTER VOICE OVER INTERNET PROTOCOL (VOIP) PHONE SYSTEMS, WITH INFORMATION TECHNOLOGY SYSTEMS IN THE FIELDS OF TELECOMMUNICATIONS, INTERNET PROTOCOL COMMUNICATIONS, ENTERPRISE COMMUNICATIONS AND INFORMATION TECHNOLOGY (U.S. CLS. 21, 23, 26, 36 AND 38).

FIRST USE 4-25-2005; IN COMMERCE 4-25-2005.

JOHN DALIER, EXAMINING ATTORNEY

CLASS 9—(Continued).

SN 78-622,653. SAR COMMUNICATIONS, LLC, FAYETTEVILLE, NC. FILED 5-4-2005.

Stryker

THE MARK CONSISTS OF STANDARD CHARACTERS WITHOUT CLAIM TO ANY PARTICULAR FONT, STYLE, SIZE, OR COLOR.

FOR AMATEUR RADIOS, CITIZEN BAND RADIOS AND ACCESSORIES, NAMELY MICROPHONES, FREQUENCY COUNTERS AND ECHO BOARDS, FOR AMATEUR AND CITIZEN BAND RADIOS (U.S. CLS. 21, 23, 26, 36 AND 38).

FIRST USE 7-19-2005; IN COMMERCE 8-22-2005.
CHERYL CLAYTON, EXAMINING ATTORNEY

CLASS 9—(Continued).

SN 78-637,434. RAZORGATOR INTERACTIVE GROUP, INC., BEVERLY HILLS, CA. FILED 5-25-2005.

TICKET TRADER

THE MARK CONSISTS OF STANDARD CHARACTERS WITHOUT CLAIM TO ANY PARTICULAR FONT, STYLE, SIZE, OR COLOR.

NO CLAIM IS MADE TO THE EXCLUSIVE RIGHT TO USE "TICKET", APART FROM THE MARK AS SHOWN. SEC. 2(F).

FOR COMPUTER SOFTWARE FOR TICKET BROKERAGE AND TICKET AGENCY SERVICES OVER A GLOBAL COMPUTER NETWORK (U.S. CLS. 21, 23, 26, 36 AND 38).

FIRST USE 7-11-1988; IN COMMERCE 1-17-1990.
MELISSA VALLILLO, EXAMINING ATTORNEY

SN 78-646,467. MALLYA, VENKAT V, LIVONIA, MI. FILED 6-8-2005.



THE COLOR(S) MAROON, RED AND GREY IS/ARE CLAIMED AS A FEATURE OF THE MARK.

THE WORDING AND OBJECTS EMBEDDED IN THE WORDING APPEAR IN THE COLOR MAROON. THE WELL BETWEEN THE WORD "WELL" AND THE WORD "DREAMS" IS IN THE COLORS RED AND GRAY.

FOR COMPUTER SOFTWARE FOR USE IN THE WATER WELL DRILLING INDUSTRY TO AUTOMATE BUSINESS FUNCTIONS, NAMELY, CUSTOMER INFORMATION AND HISTORY, JOB QUOTATIONS, PREPARE AND SEND INVOICES, JOB SCHEDULING AND TRACKING, SEARCH WELL LOGS, PREPARE AND SEND REPORTS TO GOVERNMENTAL ENTITIES, PREPARE CUSTOMIZED BUSINESS REPORTS, FINANCIAL ACCOUNTING, INVENTORY MANAGEMENT, EQUIPMENT MANAGEMENT, AUTOMATE PROCUREMENT AND AUTOMATE HUMAN RESOURCES MANAGEMENT (U.S. CLS. 21, 23, 26, 36 AND 38).

FIRST USE 9-1-2004; IN COMMERCE 10-1-2004.
MARY ROSSMAN, EXAMINING ATTORNEY

SN 78-634,080. THAT CORPORATION, MILFORD, MA. FILED 5-20-2005.

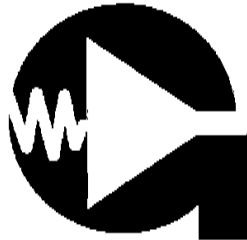

SN 78-654,450. 20Q.NET INC., OTTAWA, ONTARIO, CANADA, FILED 6-20-2005.

20Q

FOR ELECTRONIC APPARATUS, NAMELY, BALANCED LINE RECEIVERS, LINE NOISE REDUCERS, AND AUDIO INPUT DEVICES FOR USE IN AUDIO EQUIPMENT TO REDUCE LINE NOISE AND IMPROVE SOUND QUALITY (U.S. CLS. 21, 23, 26, 36 AND 38).

ARETHA SOMERVILLE, EXAMINING ATTORNEY

THE MARK CONSISTS OF STANDARD CHARACTERS WITHOUT CLAIM TO ANY PARTICULAR FONT, STYLE, SIZE, OR COLOR.

FOR HAND-HELD WIRELESS DEVICES, NAMELY, CELLULAR TELEPHONES AND PERSONAL DIGITAL ASSISTANTS (PDA) (U.S. CLS. 21, 23, 26, 36 AND 38).

MYRIAH HABEEB, EXAMINING ATTORNEY

CLASS 9—(Continued).

SN 78-654,458. 20Q.NET INC., OTTAWA, ONTARIO, CANADA, FILED 6-20-2005.



FOR HAND-HELD WIRELESS DEVICES, NAMELY, CELLULAR TELEPHONES AND PERSONAL DIGITAL ASSISTANTS (PDA) (U.S. CLS. 21, 23, 26, 36 AND 38).
MYRIAH HABEEB, EXAMINING ATTORNEY

CLASS 9—(Continued).

SN 78-670,856. HERMES AUDIO S.A. DE C.V., MEXICO D.F., MEXICO, FILED 7-14-2005.



OWNER OF ENGLAND REG. NO. 925673, DATED 3-27-2006, EXPIRES 3-27-2016.

NO CLAIM IS MADE TO THE EXCLUSIVE RIGHT TO USE SOUND, APART FROM THE MARK AS SHOWN.

THE STIPPLING SHOWN IN THE DRAWING IS DUE TO THE POOR QUALITY OF THE JPG IMAGE FILED WITH THE ORIGINAL APPLICATION. THE STIPPLING IS NOT A FEATURE OF THE MARK AND IS NOT INTENDED TO INDICATE COLOR.

FOR AUDIO AND VIDEO EQUIPMENT, NAMELY, CABINETS AND CABINET STANDS FOR LOUDSPEAKERS, DJ MIXERS, POWERED MIXERS, AUDIO MIXERS, SOUND MIXERS, PORTABLE AUDIO SYSTEMS COMPRISING CD PLAYERS, TAPE DECKS, MICROPHONES, CABINETS, AND CABLES, CD PLAYERS, TURNTABLES, LIGHTING APPARATUS FOR CONTROLLING DIMMERS, MICROPHONES, AUDIO PROCESSORS, AMPLIFIERS, SPEAKERS (U.S. CLS. 21, 23, 26, 36 AND 38).

DEZMONA MIZELLE, EXAMINING ATTORNEY

SN 78-660,267. BANANA REPUBLIC (APPAREL) LLC, SAN FRANCISCO, CA. FILED 6-28-2005.

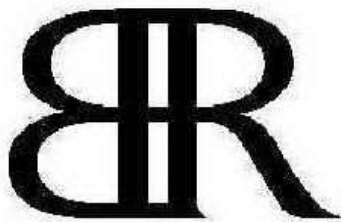

THE MARK CONSISTS OF A BACKWARDS "B" INTERLOCKED WITH A FORWARD-FACING "R".

FOR MAGNETICALLY ENCODED CARDS THAT TRACK CUSTOMER PURCHASES FOR REWARD PURPOSES AND CARDS CONTAINING AN INTEGRATED CIRCUIT CHIP, NAMELY, SMART CARDS CONTAINING PROGRAMMING USED TO PURCHASE MERCHANDISE AND SERVICES; SUNGLASSES AND PRE-RECORDED COMPACT DISCS FEATURING MUSIC (U.S. CLS. 21, 23, 26, 36 AND 38).

LEIGH LOWRY, EXAMINING ATTORNEY

SN 78-670,943. JACENT TECHNOLOGIES, INC., SANTA CLARA, CA. FILED 7-14-2005.

ProfitTalk

THE MARK CONSISTS OF STANDARD CHARACTERS WITHOUT CLAIM TO ANY PARTICULAR FONT, STYLE, SIZE, OR COLOR.

FOR COMPUTER HARDWARE; A BUSINESS COMMUNICATIONS SYSTEM, CONSISTING PRIMARILY OF TELEPHONE EQUIPMENT, COMPUTER HARDWARE AND COMPUTER SOFTWARE, FOR MANAGING A BUSINESS TELEPHONE SYSTEM, ANSWERING INCOMING TELEPHONE CALLS, DIRECTING AND ROUTING INCOMING CALLS, HOLDING CALLERS ON A CALL QUEUE, AND PLAYING MUSIC OR MESSAGES FOR CALLERS ON HOLD (U.S. CLS. 21, 23, 26, 36 AND 38).

SHANNON TWOHIG, EXAMINING ATTORNEY

CLASS 9—(Continued).

SN 78-673,267. E-FRONTIER AMERICA INC., SCOTTS VALLEY, CA. FILED 7-19-2005.

WHAT WILL YOU CREATE?

THE MARK CONSISTS OF STANDARD CHARACTERS WITHOUT CLAIM TO ANY PARTICULAR FONT, STYLE, SIZE, OR COLOR.

FOR COMPUTER SOFTWARE FOR CREATING DIGITAL ANIMATION, SOUND, GRAPHICS, PRESENTATIONS, AND ILLUSTRATIONS (U.S. CLS. 21, 23, 26, 36 AND 38).

FIRST USE 1-1-2005; IN COMMERCE 1-1-2005.
ELIZABETH BEYER, EXAMINING ATTORNEY

SN 78-674,363. RLW ANALYTICS, SONOMA, CA. FILED 7-20-2005.

Visualize-IT

THE MARK CONSISTS OF STANDARD CHARACTERS WITHOUT CLAIM TO ANY PARTICULAR FONT, STYLE, SIZE, OR COLOR.

FOR COMPUTER SOFTWARE DESIGNED TO EXPLORE, SUMMARIZE AND ANALYZE TIME SERIES INTERVAL DATA; THE SOFTWARE HAS BEEN DEVELOPED SPECIFICALLY FOR ELECTRIC AND GAS LOAD DATA, BUT IT IS EQUALLY USEFUL AS A GENERAL PURPOSE DATA VISUALIZATION TOOL FOR OTHER TIME SERIES MEASUREMENTS SUCH AS WEATHER, INDUSTRIAL PROCESS CONTROL, AND WATER QUALITY (U.S. CLS. 21, 23, 26, 36 AND 38).

FIRST USE 1-1-1995; IN COMMERCE 1-1-1995.
GINA FINK, EXAMINING ATTORNEY

SN 78-675,994. MEDQUIST IP CORP., MOUNT LAUREL, NJ. FILED 7-22-2005.

DocQroute

THE MARK CONSISTS OF STANDARD CHARACTERS WITHOUT CLAIM TO ANY PARTICULAR FONT, STYLE, SIZE, OR COLOR.

FOR COMPUTER SOFTWARE MODULE THAT EDITS AND TRANSMITS MEDICAL INFORMATION (U.S. CLS. 21, 23, 26, 36 AND 38).

FIRST USE 12-1-2004; IN COMMERCE 12-1-2004.
TINA BROWN, EXAMINING ATTORNEY

CLASS 9—(Continued).

SN 78-677,484. ALL BY MYSELF, INC., SANTA CLARA, CA. FILED 7-25-2005.

YOU CAN DO IT! JUST STICK TO IT!

THE MARK CONSISTS OF STANDARD CHARACTERS WITHOUT CLAIM TO ANY PARTICULAR FONT, STYLE, SIZE, OR COLOR.

FOR PRE-RECORDED CD-ROMS, VIDEO TAPES, INTERACTIVE VIDEO GAMES, FOR EDUCATING AND ENTERTAINING PRESCHOOLERS IN THE AREA OF SELF EMPOWERMENT AND PERFORMING EVERYDAY TASKS BY THEMSELVES (U.S. CLS. 21, 23, 26, 36 AND 38).

FIRST USE 5-1-2002; IN COMMERCE 5-1-2002.
CAROLINE WOOD, EXAMINING ATTORNEY

SN 78-677,672. CONSENDA, INC., NY, NY. FILED 7-25-2005.

NewsPoint

THE MARK CONSISTS OF STANDARD CHARACTERS WITHOUT CLAIM TO ANY PARTICULAR FONT, STYLE, SIZE, OR COLOR.

FOR COMPUTER SOFTWARE FOR DOWNLOADING, DISPLAYING, INTERFACING, ACCESSING, BROWSING, AND ORGANIZING DATA AND LINKS FROM CONTENT PROVIDERS AND OTHER DATA SOURCES PROVIDED VIA A COMMUNICATIONS NETWORK IN THE FIELD AS DETERMINED BY THE USER (U.S. CLS. 21, 23, 26, 36 AND 38).

SUSAN STIGLITZ, EXAMINING ATTORNEY

SN 78-677,920. CONNER, GLEN C., ROSEVILLE, CA. FILED 7-25-2005.

TOD-A-LIGHT

THE MARK CONSISTS OF STANDARD CHARACTERS WITHOUT CLAIM TO ANY PARTICULAR FONT, STYLE, SIZE, OR COLOR.

FOR DECORATIVE ELECTRIC LIGHT SWITCH COVERS WITH AN EXTENSION FOR OPERATING THE SWITCH (U.S. CLS. 21, 23, 26, 36 AND 38).

FIRST USE 11-21-1995; IN COMMERCE 1-1-2005.
HOWARD B. LEVINE, EXAMINING ATTORNEY

CLASS 9—(Continued).

SN 78-678,455. AUDIO DESIGN ASSOCIATES, INC., WHITE PLAINS, NY. FILED 7-26-2005.

iBase

THE MARK CONSISTS OF STANDARD CHARACTERS WITHOUT CLAIM TO ANY PARTICULAR FONT, STYLE, SIZE, OR COLOR.

FOR ELECTRONIC DEVICE WHICH PERMITS CONNECTION BETWEEN PORTABLE DIGITAL ELECTRONIC DEVICES AND CONVENTIONAL STATIONARY AND/OR PORTABLE COMPUTERS AND/OR MORE TRADITIONAL STEREO EQUIPMENT, INCLUDING RECEIVERS, TUNERS, EQUALIZERS, AMPLIFIERS, PRE-AMPLIFIERS, SPEAKERS, VIDEO DEVICES, AND DEVICES THAT SOURCE MEDIA (U.S. CLS. 21, 23, 26, 36 AND 38).

SANI KHOURI, EXAMINING ATTORNEY

SN 78-679,831. XEROX CORPORATION, STAMFORD, CT. FILED 7-27-2005.

6400

THE MARK CONSISTS OF STANDARD CHARACTERS WITHOUT CLAIM TO ANY PARTICULAR FONT, STYLE, SIZE, OR COLOR.

FOR OPTICAL CHARACTER RECOGNITION SCANNERS, SCANNER OPERATING SOFTWARE, PARTS THEREOF (U.S. CLS. 21, 23, 26, 36 AND 38).

FIRST USE 8-13-2004; IN COMMERCE 8-13-2004.
CAROLINE WOOD, EXAMINING ATTORNEY

SN 78-679,940. NORMENT SECURITY GROUP, INC., MONTGOMERY, AL. FILED 7-27-2005.

NORSHIELD

THE MARK CONSISTS OF STANDARD CHARACTERS WITHOUT CLAIM TO ANY PARTICULAR FONT, STYLE, SIZE, OR COLOR.

FOR BULLET, BLAST AND ATTACK RESISTANT DOORS AND WINDOWS; BALLISTIC ENCLOSURES AND SYSTEMS COMPRISED OF PANELS, DRAWERS AND FRAMING THEREFOR; BULLET RESISTANT ARMOR TRANSPARENCIES, NAMELY, TRANSPARENT FILM FOR PLACING OVER GLASS TO PREVENT SHATTERING; BULLET RESISTANT DRAWERS AND PASS THRU; SECURITY BARRIERS AND BOLLARDS (U.S. CLS. 21, 23, 26, 36 AND 38).

FIRST USE 9-1-1982; IN COMMERCE 9-1-1982.
CAROLINE WEIMER, EXAMINING ATTORNEY

CLASS 9—(Continued).

SN 78-680,206. GLENPORT INC., RALEIGH, NC. FILED 7-28-2005.

REVARTIS

THE MARK CONSISTS OF STANDARD CHARACTERS WITHOUT CLAIM TO ANY PARTICULAR FONT, STYLE, SIZE, OR COLOR.

FOR COMPUTER E-COMMERCE SOFTWARE TO ALLOW USERS TO PERFORM ELECTRONIC BUSINESS TRANSACTIONS VIA A GLOBAL COMPUTER NETWORK; COMPUTER SOFTWARE FOR ACCESSING INFORMATION DIRECTORIES THAT MAY BE DOWNLOADED FROM THE GLOBAL COMPUTER NETWORK; GRAPHICAL USER INTERFACE SOFTWARE (U.S. CLS. 21, 23, 26, 36 AND 38).

JOHN DWYER, EXAMINING ATTORNEY

SN 78-680,222. HON HAI PRECISION INDUSTRY CO., LTD., TU-CHENG CITY, TAIPEI HSIEN, TAIWAN, FILED 7-28-2005.

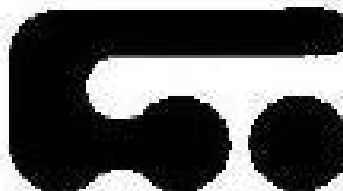

THE MARK CONSISTS OF THE STYLIZED LETTERS "HI".

FOR MP3 PLAYER; MP4 PLAYER; SATELLITE RADIOS; TELEVISION SETS, NAMELY LCD (LIQUID CRYSTAL DISPLAY) TELEVISION SETS, PDP (PLASMA DISPLAY PANEL) TELEVISION SETS, SATELLITE TELEVISION SETS; MOBILE PHONES; PERSONAL DIGITAL ASSISTANT (PDA); ELECTRONIC BOOK (E-BOOK) READER; COMPUTER MONITORS, MOBILE PHONE MONITORS, TELEVISION SET MONITORS, AND LCD (LIQUID CRYSTAL DISPLAY) MONITORS (U.S. CLS. 21, 23, 26, 36 AND 38).

COLLEEN DOMBROW, EXAMINING ATTORNEY

SN 78-680,668. QUANTUM OPTICS, INC., SMITHFIELD, RI. FILED 7-28-2005.

ANGEL

THE MARK CONSISTS OF STANDARD CHARACTERS WITHOUT CLAIM TO ANY PARTICULAR FONT, STYLE, SIZE, OR COLOR.

OWNER OF U.S. REG. NO. 2,582,474.
FOR SUNGLASSES, EYEGLASSES, EYEGGLASS CASES, EYEGGLASS CHAINS, EYEGGLASS CORDS, EYEGGLASS FRAMES AND LENSES FOR EYEGGLASSES (U.S. CLS. 21, 23, 26, 36 AND 38).

FIRST USE 1-1-1996; IN COMMERCE 1-1-1996.
DAWN HAN, EXAMINING ATTORNEY

CLASS 9—(Continued).

SN 78-681,314. TRI-PEN TRAVELMASTER TECHNOLOGIES, LLC, CARSON CITY, NV. FILED 7-29-2005.

ConferenceCommander

THE MARK CONSISTS OF STANDARD CHARACTERS WITHOUT CLAIM TO ANY PARTICULAR FONT, STYLE, SIZE, OR COLOR.

FOR VOICE OVER IP DESKTOP APPLICATION SHARING SOFTWARE FOR WEB-BASED CONFERENCES, VIDEO CONFERENCES, AND AUDIO CONFERENCES, NAMELY, SOFTWARE FOR WEB CONFERENCING (U.S. CLS. 21, 23, 26, 36 AND 38).

FIRST USE 6-1-2005; IN COMMERCE 6-1-2005.
ELI HELLMAN, EXAMINING ATTORNEY

CLASS 9—(Continued).

SN 78-681,911. ABB AB, VÄSTERÅS, SWEDEN, FILED 7-29-2005.

TORDUCTOR

THE MARK CONSISTS OF STANDARD CHARACTERS WITHOUT CLAIM TO ANY PARTICULAR FONT, STYLE, SIZE, OR COLOR.

FOR APPARATUS AND INSTRUMENTS FOR MEASUREMENT, NAMELY, TENSIONMETERS, THRUST GAUGES, PRESSURE GAUGES, TORQUE METERS, STRAIN GAUGES, SHEAR STRESS GAUGES, AND SCALES (U.S. CLS. 21, 23, 26, 36 AND 38).

COLLEEN KEARNEY, EXAMINING ATTORNEY

SN 78-681,605. GUERRIERI, RICHARD P., NAPLES, FL. FILED 7-29-2005.

LENS LAVE

THE MARK CONSISTS OF STANDARD CHARACTERS WITHOUT CLAIM TO ANY PARTICULAR FONT, STYLE, SIZE, OR COLOR.

NO CLAIM IS MADE TO THE EXCLUSIVE RIGHT TO USE "LENS", APART FROM THE MARK AS SHOWN.

FOR CONTACT LENS STORAGE KITS CONSISTING OF CONTACT LENS CASES, CONTAINER RECEPTACLES FOR HOLDING A CONTACT LENS FOR TREATING THE LENS WITH EYE SOLUTIONS, AND EYE DROPPERS THAT DISPENSE SOLUTIONS FOR THE EYES AND/OR CONTACTS, THESE KITS BEING FOR USE IN STORING AND TREATING CONTACT LENSES WITH SOLUTIONS AS WELL AS DELIVERING SOLUTIONS TO THE EYE (U.S. CLS. 21, 23, 26, 36 AND 38).

ANDREW RHIM, EXAMINING ATTORNEY

SN 78-681,640. CALYPTO DESIGN SYSTEMS, INC., SANTA CLARA, CA. FILED 7-29-2005.

SLEC

THE MARK CONSISTS OF STANDARD CHARACTERS WITHOUT CLAIM TO ANY PARTICULAR FONT, STYLE, SIZE, OR COLOR.

FOR COMPUTER PROGRAMS AND SOFTWARE FOR DESIGNING INTEGRATED CIRCUITS (U.S. CLS. 21, 23, 26, 36 AND 38).

PRISCILLA MILTON, EXAMINING ATTORNEY

SN 78-682,310. DREBEN, RON N., WASHINGTON, DC. FILED 7-31-2005.

SUICIDE SENIORS

THE MARK CONSISTS OF STANDARD CHARACTERS WITHOUT CLAIM TO ANY PARTICULAR FONT, STYLE, SIZE, OR COLOR.

FOR COMPUTER GAMES SOFTWARE AND COMPUTER GAME PROGRAMS; VIDEO GAMES PRERECORDED ON DIGITAL MEDIA FOR USE IN FREESTANDING VIDEO GAME MACHINES; AND COMPUTER PRODUCTS, NAMELY, GAME CARTRIDGES FOR COMPUTER VIDEO GAMES AND VIDEO OUTPUT GAME MACHINES AND INSTRUCTIONAL MATERIALS SOLD AS A UNIT (U.S. CLS. 21, 23, 26, 36 AND 38).

KRISTINA KLOIBER, EXAMINING ATTORNEY

SN 78-684,991. MOTOROLA, INC., SCHAUMBURG, IL. FILED 8-3-2005.

TRUSCEND

THE MARK CONSISTS OF STANDARD CHARACTERS WITHOUT CLAIM TO ANY PARTICULAR FONT, STYLE, SIZE, OR COLOR.

FOR TWO-WAY RADIOS, RADIO NETWORK EQUIPMENT, NAMELY BASE STATIONS, CONTROLLERS, CONSOLES, NETWORK MANAGEMENT SOFTWARE (U.S. CLS. 21, 23, 26, 36 AND 38).

AMY ALFIERI, EXAMINING ATTORNEY

CLASS 9—(Continued).

SN 78-685,728. SMITH & NEPHEW, INC., MEMPHIS, TN.
FILED 8-4-2005.

WOUNDNET

THE MARK CONSISTS OF STANDARD CHARACTERS
WITHOUT CLAIM TO ANY PARTICULAR FONT, STYLE,
SIZE, OR COLOR.

OWNER OF U.S. REG. NO. 2,296,778.
FOR COMPUTER SOFTWARE PROGRAM FOR USE
IN MONITORING WOUND MANAGEMENT OUT-
COMES AND TRACKING COSTS ASSOCIATED WITH
TREATMENT (U.S. CLS. 21, 23, 26, 36 AND 38).
VIVIAN MICZNIK FIRST, EXAMINING ATTORNEY

SN 78-685,865. GOLDEN, STEPHEN L, PEMBROKE, MA.
FILED 8-4-2005.

Xpressions

THE MARK CONSISTS OF STANDARD CHARACTERS
WITHOUT CLAIM TO ANY PARTICULAR FONT, STYLE,
SIZE, OR COLOR.

FOR DIGITAL AUDIO PLAYERS (U.S. CLS. 21, 23, 26,
36 AND 38).
MELVIN AXILBUND, EXAMINING ATTORNEY

SN 78-686,951. MOMREADY, LLC, ENCINO, CA. FILED 8-5-
2005.



FOR ELECTRONIC PUBLICATIONS, NAMELY MA-
GAZINES FEATURING TIPS AND TOPICS FOR PAR-
ENTS (U.S. CLS. 21, 23, 26, 36 AND 38).
FIRST USE 7-1-2005; IN COMMERCE 7-21-2005.
MICHAEL LEWIS, EXAMINING ATTORNEY

CLASS 9—(Continued).

SN 78-689,112. DIVERSIFIED MULTIMEDIA, LLC, DALLAS,
TX. FILED 8-9-2005.

VIDEO VAULT

THE MARK CONSISTS OF STANDARD CHARACTERS
WITHOUT CLAIM TO ANY PARTICULAR FONT, STYLE,
SIZE, OR COLOR.

NO CLAIM IS MADE TO THE EXCLUSIVE RIGHT TO
USE "VIDEO", APART FROM THE MARK AS SHOWN.

FOR COMPUTER SOFTWARE FOR MANAGEMENT,
EDITING, STORAGE AND DELIVERY OF AUDIO,
VIDEO AND IMAGE CONTENT (U.S. CLS. 21, 23, 26, 36
AND 38).

FIRST USE 11-30-2004; IN COMMERCE 11-30-2004.
TANYA AMOS, EXAMINING ATTORNEY

SN 78-690,454. AJT SYSTEMS, INC., FORT LAUDERDALE,
FL. FILED 8-11-2005.

CAMINO

THE MARK CONSISTS OF STANDARD CHARACTERS
WITHOUT CLAIM TO ANY PARTICULAR FONT, STYLE,
SIZE, OR COLOR.

THE ENGLISH TRANSLATION OF THE WORD "CAMI-
NO" IS "ROAD" IN SPANISH AND "FIREPLACE" IN
ITALIAN.

FOR COMPUTER SOFTWARE FOR GENERATION OF
BROADCAST VIDEO GRAPHICS, NAMELY ANIMA-
TION, COMPOSITING, AND CHARACTER GENERA-
TION IN VIDEO FORMAT, FOR USE BY
PROFESSIONALS IN THE TELEVISION BROADCAST
INDUSTRY (U.S. CLS. 21, 23, 26, 36 AND 38).

FIRST USE 4-1-2004; IN COMMERCE 4-1-2004.
JENNIFER KRISP, EXAMINING ATTORNEY

CLASS 9—(Continued).

SN 78-690,691. COMMUNITY DIGITAL UTILITIES GROUP, INC., ASHBURN, VA. FILED 8-11-2005.

DIGITAL UTILITIES

THE MARK CONSISTS OF STANDARD CHARACTERS WITHOUT CLAIM TO ANY PARTICULAR FONT, STYLE, SIZE, OR COLOR.

NO CLAIM IS MADE TO THE EXCLUSIVE RIGHT TO USE "DIGITAL", APART FROM THE MARK AS SHOWN.

FOR COMPUTER PROGRAMS FOR USE IN THE EDUCATIONAL AND INFORMATION FIELDS, NAMELY, A CUSTOMIZABLE, REMOTELY ACCESSIBLE COMPUTER SOFTWARE OPERATING SYSTEM USED TO MAINTAIN EDUCATIONAL MATERIALS AND ADMINISTRATIVE RECORDS AND FOR OPERATING TRAINING PROGRAMS, NOT INCLUDING UTILITY PROGRAMS; PRE-RECORDED VIDEO EDUCATIONAL TAPES IN THE FIELDS OF FOREIGN LANGUAGE, LITERATURE, GRAMMAR, NATURAL SCIENCE, COMPUTER SCIENCE, HISTORY, GEOGRAPHY, MATHEMATICS, PHILOSOPHY, AND GENERAL INTEREST PROGRAMS ON A WIDE VARIETY OF TOPICS, NAMELY, ENVIRONMENT, AGRICULTURE, HEALTH CARE, TEACHING, SMALL BUSINESS EDUCATION RELATED TRAINING, ENTERTAINMENT, COMPUTER GAMES, GAME SIMULATIONS AND ECONOMIC DEVELOPMENT, NOT INCLUDING UTILITY PROGRAMS (U.S. CLS. 21, 23, 26, 36 AND 38).

TRICIA SONNEBORN, EXAMINING ATTORNEY

SN 78-691,066. 9 SQUARED, INC., DENVER, CO. FILED 8-11-2005.

THE IN CROWD

THE MARK CONSISTS OF STANDARD CHARACTERS WITHOUT CLAIM TO ANY PARTICULAR FONT, STYLE, SIZE, OR COLOR.

FOR DOWNLOADABLE RING TONES, GRAPHICS, IMAGES, AUDIO AND VIDEO FEATURING MUSIC AND VOICE RECORDINGS, VIDEO GAMES AND MUSICAL SOUND RECORDINGS FOR USE WITH WIRELESS DEVICES AND HANDHELD COMPUTERS (U.S. CLS. 21, 23, 26, 36 AND 38).

MICHAEL WEBSTER, EXAMINING ATTORNEY

CLASS 9—(Continued).

SN 78-691,559. MADAHCOM, SARASOTA, FL. FILED 8-12-2005.



NO CLAIM IS MADE TO THE EXCLUSIVE RIGHT TO USE "GIANT VOICE", APART FROM THE MARK AS SHOWN.

THE COLOR(S) BLUE, GREEN, ORANGE, AND YELLOW IS/ARE CLAIMED AS A FEATURE OF THE MARK.

THE MARK CONSISTS OF TWO RING COLOR RAINBOW TO THE RIGHT OF THE GIANT VOICE LITERAL ELEMENT. THE OUTER RING IS BLUE FADING TO GREEN; THE INNER RING IS ORANGE FADING TO YELLOW.

FOR DEVICE OR NETWORK OF SUCH DEVICES CONSISTING OF A LOUDSPEAKER, DRIVERS, AND AN ELECTRONIC CONTROLLER FOR PRODUCING HIGH OUTPUT VOICE, TONES AND/OR SIREN WAILES USED FOR OUTDOOR PUBLIC ADDRESSING (U.S. CLS. 21, 23, 26, 36 AND 38).

KATHERINE STOIDES, EXAMINING ATTORNEY

SN 78-691,736. ACCESSDATA CORP., LINDON, UT. FILED 8-12-2005.

PASSWORD RECOVERY TOOLKIT

THE MARK CONSISTS OF STANDARD CHARACTERS WITHOUT CLAIM TO ANY PARTICULAR FONT, STYLE, SIZE, OR COLOR.

NO CLAIM IS MADE TO THE EXCLUSIVE RIGHT TO USE "TOOLKIT", APART FROM THE MARK AS SHOWN. SEC. 2(F).

FOR COMPUTER SOFTWARE, NAMELY SOFTWARE FOR DECRYPTING PASSWORDS AND GAINING ENTRY TO COMPUTER FILES AND DATA (U.S. CLS. 21, 23, 26, 36 AND 38).

FIRST USE 1-31-1987; IN COMMERCE 1-31-1987.
ALICE BENMAMAN, EXAMINING ATTORNEY

CLASS 9—(Continued).

SN 78-693,187. ZHE, WANG, WENZHOU CITY, ZHEJIANG PROVINCE, CHINA, FILED 8-16-2005.

CAPEVISTA

THE MARK CONSISTS OF STANDARD CHARACTERS WITHOUT CLAIM TO ANY PARTICULAR FONT, STYLE, SIZE, OR COLOR.

FOR PINCE-NEZ; SPECTACLES; SUNGLASSES; SPECTACLE FRAMES; PINCE-NEZ MOUNTINGS; SPECTACLE CASES (U.S. CLS. 21, 23, 26, 36 AND 38).

FIRST USE 6-0-2005; IN COMMERCE 6-0-2005.

STEVEN R. FINE, EXAMINING ATTORNEY

SN 78-694,149. ADS CORPORATION, HUNTSVILLE, AL. FILED 8-17-2005.

ADS Environmental Services

THE MARK CONSISTS OF STANDARD CHARACTERS WITHOUT CLAIM TO ANY PARTICULAR FONT, STYLE, SIZE, OR COLOR.

NO CLAIM IS MADE TO THE EXCLUSIVE RIGHT TO USE "ENVIRONMENTAL SERVICES", APART FROM THE MARK AS SHOWN.

FOR MONITORING DEVICES COMPRISING ELECTRONIC SENSORS, DATA LOGGERS, AND ACCOMPANYING SOFTWARE AND SERVICES FOR MEASURING FLOW RATES IN WATER AND WASTEWATER SYSTEMS (U.S. CLS. 21, 23, 26, 36 AND 38).

FIRST USE 10-1-1986; IN COMMERCE 11-1-1986.

JOHN E. MICHOS, EXAMINING ATTORNEY

SN 78-695,506. ATTAP TECHNOLOGIES, INC., NEW YORK, NY. FILED 8-18-2005.

LIFEIO

THE MARK CONSISTS OF STANDARD CHARACTERS WITHOUT CLAIM TO ANY PARTICULAR FONT, STYLE, SIZE, OR COLOR.

FOR COMPUTER SOFTWARE FOR ORGANIZING PERSONAL INFORMATION, BRAND PREFERENCES, AND PAST PURCHASE INFORMATION ON CUSTOMERS FOR RETAIL STORES AND COMPUTER ECOMMERCE SOFTWARE THAT ALLOWS USERS TO PERFORM ELECTRONIC BUSINESS TRANSACTIONS VIA A GLOBAL COMPUTER NETWORK (U.S. CLS. 21, 23, 26, 36 AND 38).

DAWN FELDMAN, EXAMINING ATTORNEY

CLASS 9—(Continued).

SN 78-696,137. ENVISION GAMING TECHNOLOGIES INCORPORATED, JENKS, OK. FILED 8-19-2005.

IMAGINATION IN GAMING

THE MARK CONSISTS OF STANDARD CHARACTERS WITHOUT CLAIM TO ANY PARTICULAR FONT, STYLE, SIZE, OR COLOR.

FOR ELECTRONIC GAMING MACHINES, NAMELY, MACHINES FOR PLAYING GAMES OF CHANCE (U.S. CLS. 21, 23, 26, 36 AND 38).

KYLE PEETE, EXAMINING ATTORNEY

SN 78-696,362. SALGADO, RAPHAEL, EDISON, NJ. FILED 8-19-2005.

KUNG FU LOUIE

NO CLAIM IS MADE TO THE EXCLUSIVE RIGHT TO USE "KUNG FU", APART FROM THE MARK AS SHOWN.

FOR VIDEO GAME PROGRAMS AND VIDEO GAME SOFTWARE (U.S. CLS. 21, 23, 26, 36 AND 38).

SCOTT SISUN, EXAMINING ATTORNEY

CLASS 9—(Continued).

SN 78-696,928. OMNIMOUNT SYSTEMS, INC., PHOENIX, AZ. FILED 8-20-2005.



OWNER OF U.S. REG. NOS. 1,271,496, 2,564,259 AND 2,774,773.

NO CLAIM IS MADE TO THE EXCLUSIVE RIGHT TO USE "MOUNT", APART FROM THE MARK AS SHOWN.

FOR MOUNTING ASSEMBLIES FOR AUDIO/VISUAL EQUIPMENT, NAMELY SPEAKER STANDS, C-CLAMPS, SAFETY CABLES, CEILING AND WALL VIBRATION ISOLATION ADAPTORS, MOUNTING PLATES, PIPE ADAPTORS, THREAD COUPLERS, STRUT MEMBER KITS CONSISTING OF TWO STEEL STRUCTURAL BRACKETS AND TWO U-CLIPS TO ALLOW MOUNTING ACROSS UP TO THREE STUDS, AND HANDLE KITS CONSISTING OF KNOB, SPACER AND TENSIONING BOLT FOR REPOSITIONING SPEAKERS, FOR USE IN FIXED POSITION, TILTING AND PIVOTING MOUNTINGS FOR AUDIO/VISUAL EQUIPMENT, INCLUDING AUDIO SPEAKERS, MICROPHONES, PERSONAL STEREOS, VIDEO PLAYERS, DVD PLAYERS, AUDIO PLAYERS, AMPLIFIERS, SOUND MIXERS, FREQUENCY TUNERS, SURROUND PROCESSORS, DIGITAL SOUND SIGNAL SYNTHESIZERS, STEREOS AND STEREO PARTS, TELEVISIONS, LIQUID CRYSTAL DISPLAY AND PLASMA MONITORS, LOUDSPEAKERS, COMPUTER PERIPHERALS, AND PROJECTORS (U.S. CLS. 21, 23, 26, 36 AND 38).

FIRST USE 4-1-2002; IN COMMERCE 4-1-2002.

IRENE D. WILLIAMS, EXAMINING ATTORNEY

SN 78-697,677. ALLURENT, INC., CAMBRIDGE, MA. FILED 8-22-2005.

ALLURENT

THE MARK CONSISTS OF STANDARD CHARACTERS WITHOUT CLAIM TO ANY PARTICULAR FONT, STYLE, SIZE, OR COLOR.

FOR COMPUTER E-COMMERCE SOFTWARE TO ALLOW USERS TO PERFORM ELECTRONIC BUSINESS TRANSACTIONS VIA A GLOBAL COMPUTER NETWORK (U.S. CLS. 21, 23, 26, 36 AND 38).

CHARLOTTE CORWIN, EXAMINING ATTORNEY

CLASS 9—(Continued).

SN 78-698,603. MATTEL, INC., EL SEGUNDO, CA. FILED 8-23-2005.

WAND OF LIGHT

THE MARK CONSISTS OF STANDARD CHARACTERS WITHOUT CLAIM TO ANY PARTICULAR FONT, STYLE, SIZE, OR COLOR.

FOR COMPUTER GAME SOFTWARE, NAMELY, VIDEO GAME CARTRIDGES, INTERACTIVE VIDEO GAME PROGRAMS, INTERACTIVE MULTIMEDIA COMPUTER GAME PROGRAMS, COMPUTER GAME CARTRIDGES; PRERECORDED COMPUTER STORYTELLING SOFTWARE; COMPUTER SOFTWARE, COMPUTER PROGRAMS AND CD-ROMS ALL FEATURING ACTIVITIES, EDUCATIONAL INFORMATION, STORIES, GAMES, AND THE LIKE FOR CHILDREN AND YOUNG ADULTS (U.S. CLS. 21, 23, 26, 36 AND 38).

FIRST USE 0-0-2005; IN COMMERCE 0-0-2005.

KATHERINE STOIDES, EXAMINING ATTORNEY

SN 78-703,687. QUINTESSENCE PUBLISHING CO. INC., HANOVER PARK, IL. FILED 8-30-2005.

DENTAL EXPLORER

THE MARK CONSISTS OF STANDARD CHARACTERS WITHOUT CLAIM TO ANY PARTICULAR FONT, STYLE, SIZE, OR COLOR.

NO CLAIM IS MADE TO THE EXCLUSIVE RIGHT TO USE "DENTAL", APART FROM THE MARK AS SHOWN.

FOR COMPUTER SOFTWARE FOR USE IN THE DENTAL FIELD TO MODEL A PATIENT'S CONDITION AND DEMONSTRATE TREATMENT OPTIONS (U.S. CLS. 21, 23, 26, 36 AND 38).

FIRST USE 0-0-1998; IN COMMERCE 0-0-1998.

KRISTIN DAHLING, EXAMINING ATTORNEY

SN 78-704,220. BROCADE COMMUNICATIONS SYSTEMS, INC., SAN JOSE, CA. FILED 8-31-2005.

TAPESTRY

THE MARK CONSISTS OF STANDARD CHARACTERS WITHOUT CLAIM TO ANY PARTICULAR FONT, STYLE, SIZE, OR COLOR.

FOR COMPUTER HARDWARE; NAMELY, STORAGE AREA NETWORK SYSTEMS COMPRISED OF NETWORK STORAGE DRIVES, SERVERS, HUBS AND ROUTERS; COMPUTER SOFTWARE; NAMELY, SOFTWARE USED TO MONITOR, ALLOCATE, AND MANAGE STORAGE AREA NETWORK HARDWARE AND SOFTWARE RESOURCES, AND TO IMPROVE NETWORK PERFORMANCE (U.S. CLS. 21, 23, 26, 36 AND 38).

FIRST USE 6-7-2005; IN COMMERCE 6-7-2005.

KATHERINE STOIDES, EXAMINING ATTORNEY

CLASS 9—(Continued).

SN 78-705,165. GREAT AMERICAN INSURANCE CO., CINCINNATI, OH. FILED 9-1-2005.

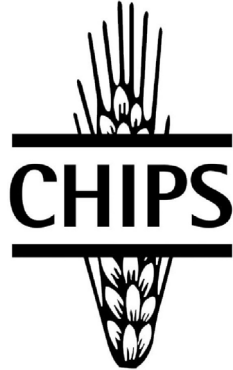

FOR WEB BASED PROCESSING SYSTEM COMPRISED OF COMPUTER SOFTWARE FOR QUOTING, DATA ENTRY AND ACCOUNT REVIEW FOR USE INTERNALLY AND BY INSURANCE PRODUCERS IN UNDERWRITING CROP INSURANCE (U.S. CLS. 21, 23, 26, 36 AND 38).

KATHERINE STOIDES, EXAMINING ATTORNEY

SN 78-705,887. VELTEK ASSOCIATES, INC., MALVERN, PA. FILED 9-2-2005.

SMA

THE MARK CONSISTS OF STANDARD CHARACTERS WITHOUT CLAIM TO ANY PARTICULAR FONT, STYLE, SIZE, OR COLOR.

FOR ELECTRONIC TESTING DEVICE, NAMELY, AN AIR MONITOR FOR PERFORMING MICROBIAL SAMPLING ANALYSIS OF THE AIR IN CLEAN ROOMS (U.S. CLS. 21, 23, 26, 36 AND 38).

FIRST USE 1-0-1987; IN COMMERCE 1-0-1987.

JENNIFER VASQUEZ, EXAMINING ATTORNEY

SN 78-706,729. VERINI, NICHOLAS A., LAFAYETTE, CO. FILED 9-4-2005.

INFLATION CARD

THE MARK CONSISTS OF STANDARD CHARACTERS WITHOUT CLAIM TO ANY PARTICULAR FONT, STYLE, SIZE, OR COLOR.

NO CLAIM IS MADE TO THE EXCLUSIVE RIGHT TO USE "CARD", APART FROM THE MARK AS SHOWN.

FOR PREPAID VENDING CARD, NAMELY, AN ENCODED SMART CARD CONTAINING PROGRAMMING USED TO PURCHASE AIR OR NITROGEN FROM A VENDING MACHINE (U.S. CLS. 21, 23, 26, 36 AND 38).

ELIZABETH J. WINTER, EXAMINING ATTORNEY

CLASS 9—(Continued).

SN 78-708,934. CORPORATE EXPRESS, INC., BROOMFIELD, CO. FILED 9-8-2005.

SMARTPARTS

THE MARK CONSISTS OF STANDARD CHARACTERS WITHOUT CLAIM TO ANY PARTICULAR FONT, STYLE, SIZE, OR COLOR.

FOR LASER PRINTER, FAX MACHINE, MULTI-FUNCTION PRINTER REPLACEMENT PARTS AND INSTALLATION INSTRUCTIONS PROVIDED THEREWITH; COMPONENTS AND REPLACEMENT PARTS FOR USE IN LASER PRINTERS, FAX MACHINES, MULTI-FUNCTION PRINTERS AND BAR CODING PRINTERS, NAMELY, FUSER TRANSFER UNITS, FUSER, FUSER ASSEMBLY, SEPARATION ROLLERS, TRANSFER ROLLERS, PAPER FEED ROLLERS, CHARGE ROLLERS, PICK UP ROLLERS, SEPARATION PAD, CLEANING BRUSH AND INSTALLATION INSTRUCTIONS SOLD AS A UNIT IN CONJUNCTION THEREWITH (U.S. CLS. 21, 23, 26, 36 AND 38).

KAELIE KUNG, EXAMINING ATTORNEY

SN 78-710,339. INNOVATIVE COMPUTER SYSTEMS, EDEN PRAIRIE, MN. FILED 9-9-2005.

TREATWARE

THE MARK CONSISTS OF STANDARD CHARACTERS WITHOUT CLAIM TO ANY PARTICULAR FONT, STYLE, SIZE, OR COLOR.

FOR COMPUTER SOFTWARE FOR USE IN POINT-OF-SALE DATA MANAGEMENT FOR THE RETAIL FOOD SERVICE INDUSTRY AND RELATED INSTRUCTIONS AND USER MANUALS SOLD AS A UNIT (U.S. CLS. 21, 23, 26, 36 AND 38).

SCOTT SISUN, EXAMINING ATTORNEY

SN 78-710,349. INNOVATIVE COMPUTER SYSTEMS, EDEN PRAIRIE, MN. FILED 9-9-2005.

TREATWARE POS

THE MARK CONSISTS OF STANDARD CHARACTERS WITHOUT CLAIM TO ANY PARTICULAR FONT, STYLE, SIZE, OR COLOR.

NO CLAIM IS MADE TO THE EXCLUSIVE RIGHT TO USE "POS", APART FROM THE MARK AS SHOWN.

FOR POINT-OF-SALE COMPUTER SOFTWARE FOR USE IN DATA MANAGEMENT FOR THE RETAIL FOOD SERVICE INDUSTRY AND RELATED USER MANUALS SOLD AS A UNIT (U.S. CLS. 21, 23, 26, 36 AND 38).

SCOTT SISUN, EXAMINING ATTORNEY

CLASS 9—(Continued).

SN 78-711,104. SEIKO EPSON KABUSHIKI KAISHA, TA SEIKO EPSON CORPORATION, TOKYO, JAPAN, FILED 9-12-2005.

SBSI

THE MARK CONSISTS OF STANDARD CHARACTERS WITHOUT CLAIM TO ANY PARTICULAR FONT, STYLE, SIZE, OR COLOR.

PRIORITY CLAIMED UNDER SEC. 44(D) ON JAPAN APPLICATION NO. 200575937, FILED 8-12-2005, REG. NO. 4972058, DATED 7-21-2006, EXPIRES 7-21-2016.

FOR SILICON WAFERS; SILICON WAFERS HAVING INSULATING LAYERS; INTEGRATED CIRCUITS FOR COMPUTERS; INTEGRATED CIRCUITS FOR CELLULAR PHONES; DIGITAL CONSUMER DEVICES, NAMELY, DIGITAL CAMERAS, DIGITAL AUDIO PLAYERS, DIGITAL VIDEO CAMERAS, TELEVISION SETS, DIGITAL VIDEO DISK RECORDERS, DIGITAL VIDEO DISK PLAYERS, INK JET PRINTERS, SCANNERS, LIQUID CRYSTAL DISPLAY PROJECTORS, PERSONAL DIGITAL ASSISTANCES (PDAS), PERSONAL COMPUTERS (U.S. CLS. 21, 23, 26, 36 AND 38).

LAURA KOVALSKY, EXAMINING ATTORNEY

SN 78-712,100. AKTIEBOLAGET ELECTROLUX, SE-105 45 STOCKHOLM, SWEDEN, FILED 9-13-2005.

CMIS

THE MARK CONSISTS OF STANDARD CHARACTERS WITHOUT CLAIM TO ANY PARTICULAR FONT, STYLE, SIZE, OR COLOR.

FOR ELECTRONIC MANAGEMENT SYSTEM COMPRISED OF COMPUTER SOFTWARE WHICH MONITORS PROFESSIONAL LAUNDRY PROCESSES, NAMELY, TIME OF USE, WASH PROGRAMS, CHEMISTRY, MAINTENANCE AND WASH HISTORY (U.S. CLS. 21, 23, 26, 36 AND 38).

WENDY GOODMAN, EXAMINING ATTORNEY

SN 78-712,621. ENO SPORTS LTD, WANCHAI, HONG KONG, FILED 9-14-2005.

ENO

THE MARK CONSISTS OF STANDARD CHARACTERS WITHOUT CLAIM TO ANY PARTICULAR FONT, STYLE, SIZE, OR COLOR.

THE FOREIGN WORDING IN THE MARK TRANSLATES INTO ENGLISH AS "UNCLE."

FOR EYEGLASS FRAMES; SUNGLASSES; GLASSES CASES; GLASSES CHAINS; MAGNETS; SPORTS HELMETS; BICYCLE HELMETS; PROTECTIVE SPORTS GOGGLES (U.S. CLS. 21, 23, 26, 36 AND 38).

KEVON CHISOLM, EXAMINING ATTORNEY

CLASS 9—(Continued).

SN 78-712,675. SCOTT & SCOTT, LLC, COWLESVILLE, NY, FILED 9-14-2005.

Scotbox

THE MARK CONSISTS OF STANDARD CHARACTERS WITHOUT CLAIM TO ANY PARTICULAR FONT, STYLE, SIZE, OR COLOR.

FOR APPARATUS FOR CONNECTING ELECTRICAL WIRES, NAMELY AN ELECTRIC JUNCTION BOX (U.S. CLS. 21, 23, 26, 36 AND 38).

ELLEN BURNS, EXAMINING ATTORNEY

SN 78-714,979. EVANS & SUTHERLAND COMPUTER CORPORATION, SALT LAKE CITY, UT, FILED 9-16-2005.

TARGETVIEW

THE MARK CONSISTS OF STANDARD CHARACTERS WITHOUT CLAIM TO ANY PARTICULAR FONT, STYLE, SIZE, OR COLOR.

FOR IMAGE PROJECTION SYSTEMS COMPRISED OF PROJECTORS AND GRAPHIC IMAGE GENERATORS FOR USE IN FLIGHT AND AIR COMBAT SIMULATION (U.S. CLS. 21, 23, 26, 36 AND 38).

JOHN SCHUYLER YARD, EXAMINING ATTORNEY

SN 78-715,565. BOOKLOCKER.COM, INC., BANGOR, ME, FILED 9-19-2005.

Writers Weekly

THE MARK CONSISTS OF STANDARD CHARACTERS WITHOUT CLAIM TO ANY PARTICULAR FONT, STYLE, SIZE, OR COLOR.

SEC. 2(F).

FOR ELECTRONIC PUBLICATIONS, NAMELY, INTERNET-BASED PERIODICAL FEATURING ARTICLES, MARKETS, AND JOB LISTINGS AIMED AT WRITERS AND RECORDED ON COMPUTER MEDIA (U.S. CLS. 21, 23, 26, 36 AND 38).

FIRST USE 6-1-1997; IN COMMERCE 6-1-1997.

LAURA HAMMEL, EXAMINING ATTORNEY

CLASS 9—(Continued).

SN 78-715,645. CULLEN, MARY A., ATLANTA, GA. FILED 9-19-2005.

Magnify your print....Magnify your profits

THE MARK CONSISTS OF STANDARD CHARACTERS WITHOUT CLAIM TO ANY PARTICULAR FONT, STYLE, SIZE, OR COLOR.

FOR MAGNIFYING LENSES FOR USE IN READING SMALL PRINT (U.S. CLS. 21, 23, 26, 36 AND 38).
MARY MUNSON, EXAMINING ATTORNEY

SN 78-716,147. EXECUTIVE POWERTOOLS, LLC, SAN JOSE, CA. FILED 9-19-2005.

THOUGHTSTYLES

THE MARK CONSISTS OF STANDARD CHARACTERS WITHOUT CLAIM TO ANY PARTICULAR FONT, STYLE, SIZE, OR COLOR.

FOR PRE-RECORDED DVD'S, CD'S, AUDIO AND VIDEO TAPES, LASER DISKS, INTERACTIVE ELECTRONIC BOOKS AND DOWNLOADABLE ELECTRONIC BOOKS ALL RECORDED ON COMPUTER MEDIA AND EACH FEATURING INFORMATION ON ORGANIZATIONAL AND PROFESSIONAL DEVELOPMENT AND MANAGEMENT OF COMMERCIAL ENTERPRISES, BUSINESS LEADERSHIP, CAREER SUCCESS, FINANCIAL ACHIEVEMENT AND OPPORTUNITY ENHANCEMENT FOR INDIVIDUALS; INTERACTIVE COMPUTER GAME SOFTWARE AND DOWNLOADABLE COMPUTER SOFTWARE FOR ONLINE LEARNING FEATURING INFORMATION ON ORGANIZATIONAL AND PROFESSIONAL DEVELOPMENT AND MANAGEMENT OF COMMERCIAL ENTERPRISES, BUSINESS LEADERSHIP, CAREER SUCCESS, FINANCIAL ACHIEVEMENT AND OPPORTUNITY ENHANCEMENT FOR INDIVIDUALS (U.S. CLS. 21, 23, 26, 36 AND 38).
LINDA E. BLOHM, EXAMINING ATTORNEY

CLASS 9—(Continued).

SN 78-717,614. MG INTERNATIONAL (MGI), LA CIOTAT, FRANCE, FILED 9-21-2005.

SENSORESPIO

THE MARK CONSISTS OF STANDARD CHARACTERS WITHOUT CLAIM TO ANY PARTICULAR FONT, STYLE, SIZE, OR COLOR.

FOR CHECKING AND LIFE-SAVING APPARATUS AND INSTRUMENTS IN THE NAUTICAL FIELD, NAMELY, ANTI-INTRUSION ALARM FOR SWIMMING POOLS; LASER OR ULTRASONIC FALL DETECTOR FOR SWIMMING POOLS; ACCESS CONTROL AND ALARM MONITORING SAFETY SYSTEM FOR SWIMMING POOLS; LASER OR ULTRASONIC IMMERSION DETECTOR; STANDARDIZED SAFETY DEVICE FOR SWIMMING POOLS, NAMELY, IMMERSION ALARM SYSTEM FOR SWIMMING POOLS (U.S. CLS. 21, 23, 26, 36 AND 38).

CHRIS WELLS, EXAMINING ATTORNEY

SN 78-717,817. INFORMATICS, INC., A DELAWARE CORPORATION, USING THE MARK THROUGH ITS OPERATING DIVISION, WASP TECHNOLOGIES, PLANO, TX. FILED 9-21-2005.

WASP COUNTIT

THE MARK CONSISTS OF STANDARD CHARACTERS WITHOUT CLAIM TO ANY PARTICULAR FONT, STYLE, SIZE, OR COLOR.

OWNER OF U.S. REG. NOS. 2,367,143, 2,594,508 AND OTHERS.

FOR COMPUTER SOFTWARE FOR USE IN INVENTORY ACCOUNTING (U.S. CLS. 21, 23, 26, 36 AND 38).
LAURIE KAUFMAN, EXAMINING ATTORNEY

SN 78-718,311. GAYDAR INC., TORONTO, ONTARIO, CANADA, FILED 9-22-2005.

GAYDARXXX

THE MARK CONSISTS OF STANDARD CHARACTERS WITHOUT CLAIM TO ANY PARTICULAR FONT, STYLE, SIZE, OR COLOR.

OWNER OF U.S. REG. NO. 2,613,823.
FOR DVDS FEATURING ADULT ORIENTED ENTERTAINMENT (U.S. CLS. 21, 23, 26, 36 AND 38).
CHARLES L. JENKINS, EXAMINING ATTORNEY

CLASS 9—(Continued).

SN 78-719,256. PURESHARE INC., OTTAWA, ON, CANADA, FILED 9-23-2005.

Now You Know

THE MARK CONSISTS OF STANDARD CHARACTERS WITHOUT CLAIM TO ANY PARTICULAR FONT, STYLE, SIZE, OR COLOR.

FOR COMPUTER SOFTWARE FOR USE IN MONITORING BUSINESS OPERATIONS AND TO CAPTURE AND DISSEMINATE BUSINESS INFORMATION ON GLOBAL AND INTERNAL COMPUTER NETWORKS FOR USE BY BUSINESS ORGANIZATIONS AS IT RELATES TO THE MANAGEMENT OF A BUSINESS (U.S. CLS. 21, 23, 26, 36 AND 38).

CHRIS WELLS, EXAMINING ATTORNEY

CLASS 9—(Continued).

SN 78-720,842. THE ORPHANAGE, INC., SAN FRANCISCO, CA. FILED 9-26-2005.

ORPHANAGE ANIMATION STUDIOS

SN 78-719,409. HDM CORPORATION, OMAHA, NE. FILED 9-23-2005.

DISCOVERING HIPAA

THE MARK CONSISTS OF STANDARD CHARACTERS WITHOUT CLAIM TO ANY PARTICULAR FONT, STYLE, SIZE, OR COLOR.

OWNER OF U.S. REG. NO. 2,758,744.

NO CLAIM IS MADE TO THE EXCLUSIVE RIGHT TO USE "HIPAA", APART FROM THE MARK AS SHOWN.

FOR COMPUTER SOFTWARE FOR USER'S USE IN ASSURING COMPLIANCE WITH THE HEALTH INSURANCE PORTABILITY AND ACCOUNTABILITY ACT (U.S. CLS. 21, 23, 26, 36 AND 38).

FIRST USE 9-15-2005; IN COMMERCE 9-15-2005.

KIMBERLY FRYE, EXAMINING ATTORNEY

THE MARK CONSISTS OF STANDARD CHARACTERS WITHOUT CLAIM TO ANY PARTICULAR FONT, STYLE, SIZE, OR COLOR.

OWNER OF U.S. REG. NO. 2,683,844.

NO CLAIM IS MADE TO THE EXCLUSIVE RIGHT TO USE "ANIMATION STUDIOS", APART FROM THE MARK AS SHOWN.

FOR ELECTRICAL AND SCIENTIFIC APPARATUS, NAMELY, MOTION PICTURE FILMS FEATURING MUSIC, ANIMATED AND LIVE-ACTION PERFORMANCES, FICTION, NON-FICTION, SCIENCE FICTION, MYSTERY, FAIRY TALES, ROMANCE, COMEDY, DRAMA, MUSICALS AND FANTASY; PRE-RECORDED VIDEO AND AUDIO CASSETTES, VIDEO AND AUDIO TAPES, VIDEO AND AUDIO DISCS, CD ROMS, COMPACT DISCS, DIGITAL VERSATILE DISCS, DIGITAL FILES, FLASH CARDS, MUSICAL VIDEO RECORDINGS, MUSICAL SOUND RECORDINGS AND PHONOGRAPH RECORDS ALL FEATURING MUSIC, ANIMATED AND LIVE-ACTION PERFORMANCES, FICTION, NON-FICTION, SCIENCE FICTION, MYSTERY, FAIRY TALES, ROMANCE, COMEDY, DRAMA, MUSICALS AND FANTASY; SOFTWARE AND MANUALS SOLD AS A UNIT FOR ENTERTAINMENT AND FOR USE AS SOFTWARE FOR CREATING CALENDARS, SOFTWARE FOR MANAGING INFORMATION AND SCREEN SAVER SOFTWARE; COMPUTER, MOBILE PHONE AND WIRELESS DEVICE GAME SOFTWARE; DECORATIVE REFRIGERATOR MAGNETS; ELECTRIC SWITCH PLATES; EYEGLASSES, EYEGLOSS CASES, SUNGLASSES AND SUNGLASS CASES; COMPUTER, MOBILE PHONE AND WIRELESS DEVICE AND VIDEO-GAME CASSETTES, CARTRIDGES, DISCS AND PROGRAMS; VIDEO GAME MACHINES FOR USE WITH TELEVISION RECEIVERS; DOWNLOADABLE GAME SOFTWARE; DOWNLOADABLE COMPUTER, MOBILE PHONE AND WIRELESS DEVICE GAMES; DOWNLOADABLE PUBLICATIONS IN THE NATURE OF CHILDREN'S BOOKS, NOVELS, GRAPHIC NOVELS AND COMIC BOOKS IN THE FIELDS OF ANIMATED AND LIVE-ACTION ENTERTAINMENT, FICTION, NON-FICTION, SCIENCE FICTION, MYSTERY, FAIRY TALES, ROMANCE, COMEDY, DRAMA, MUSICALS, FANTASY, REALITY, UNSCRIPTED, SPORTS, NEWS, TALK SHOWS, VARIETY, TRAVEL, DOCUMENTARIES, MOVIE REVIEWS, PSYCHOLOGY, EDUCATION, INSTRUCTIONAL, RECREATION, LIVE PERFORMANCES, INDIVIDUAL ENTERTAINERS, CULTURES AND CULTURAL EVENTS, AND MUSIC; SWIM MASKS; SWIM GOGGLES AND SNORKELS (U.S. CLS. 21, 23, 26, 36 AND 38).

JENNIFER KRISP, EXAMINING ATTORNEY

SN 78-719,428. TUNEBOOKS, LLC, NEW YORK, NY. FILED 9-23-2005.

TUNEBOOKS

THE MARK CONSISTS OF STANDARD CHARACTERS WITHOUT CLAIM TO ANY PARTICULAR FONT, STYLE, SIZE, OR COLOR.

FOR ELECTRONIC PUBLICATIONS, NAMELY, ALBUM COVER ART, LINER NOTES AND BOOKLETS FEATURING LITERATURE, IMAGERY, AND INTERACTIVE ELEMENTS FEATURING INFORMATION ON A MUSIC RECORDED ON COMPUTER MEDIA (U.S. CLS. 21, 23, 26, 36 AND 38).

MARIA-VICTORIA SUAREZ, EXAMINING ATTORNEY

CLASS 9—(Continued).

SN 78-721,912. REAL BUSINESS SOLUTIONS, INC., ORLAND PARK, IL. FILED 9-28-2005.

W2 Mate

THE MARK CONSISTS OF STANDARD CHARACTERS WITHOUT CLAIM TO ANY PARTICULAR FONT, STYLE, SIZE, OR COLOR.

NO CLAIM IS MADE TO THE EXCLUSIVE RIGHT TO USE "W2", APART FROM THE MARK AS SHOWN.

FOR DOWNLOADABLE COMPUTER SOFTWARE FOR FILLING OUT, EDITING, SAVING AND PRINTING W-2, 1099-MISC, W-3, AND 1096 FORMS REQUIRED BY THE IRS AND SSA THAT SUPPORTS PRINTING BOTH ON GOVERNMENT PRE-PRINTED FORMS AND ON BLANK PAPER (U.S. CLS. 21, 23, 26, 36 AND 38).

DOMINIC J. FERRAIUOLO, EXAMINING ATTORNEY

SN 78-722,659. XTREME ACCESSORIES LLC, DBA XTREMEMAC, FT. LAUDERDALE, FL. FILED 9-28-2005.

SMARTTUNE

THE MARK CONSISTS OF STANDARD CHARACTERS WITHOUT CLAIM TO ANY PARTICULAR FONT, STYLE, SIZE, OR COLOR.

FOR DIGITAL MEDIA PLAYER ACCESSORIES, NAMELY, FM TRANSMITTERS HAVING AUTOMATIC SEARCHING CAPABILITIES FOR SEARCHING FOR UNUSED RADIO FREQUENCIES AND TRANSMITTING AUDIO/VISUAL SIGNALS FROM DIGITAL MEDIA PLAYERS TO SUCH UNUSED FREQUENCIES (U.S. CLS. 21, 23, 26, 36 AND 38).

RONALD AIKENS, EXAMINING ATTORNEY

SN 78-732,538. MYMAGNET INC., DILLON, CO. FILED 10-13-2005.

word

THE MARK CONSISTS OF STANDARD CHARACTERS WITHOUT CLAIM TO ANY PARTICULAR FONT, STYLE, SIZE, OR COLOR.

FOR REFRIGERATOR MAGNETS EACH HAVING A PLURALITY OF WORDS, NAMELY A PHRASE OR SENTENCE, PRINTED THEREON (U.S. CLS. 21, 23, 26, 36 AND 38).

FIRST USE 8-11-2006; IN COMMERCE 8-11-2006.

FRED CARL, EXAMINING ATTORNEY

CLASS 9—(Continued).

SN 78-735,232. OMRON CORPORATION, KYOTO, JAPAN, FILED 10-18-2005.

CombiJog

THE MARK CONSISTS OF STANDARD CHARACTERS WITHOUT CLAIM TO ANY PARTICULAR FONT, STYLE, SIZE, OR COLOR.

PRIORITY CLAIMED UNDER SEC. 44(D) ON JAPAN APPLICATION NO. JP2005-9451, FILED 10-11-2005, REG. NO. 4955339, DATED 5-26-2006, EXPIRES 5-26-2016.

FOR ROTARY CONVERTERS; PHASE MODIFIERS; SWITCHES, NAMELY, CUT-OUT SWITCHES, DIFFERENTIAL SWITCHES, ETHERNET SWITCHES, CONTROL SWITCHES, PRESSURE SWITCHES, ELECTRIC SWITCHES; TELECOMMUNICATION MACHINES AND APPARATUS, AND THEIR PARTS AND ACCESSORIES, NAMELY, TELEPHONES, MODEMS, ROUTERS, PDAS, CORDLESS TELEPHONES, CELL PHONES, PORTABLE TELEPHONES, TRANSFORMERS FOR MODEMS, PERSONAL COMMUNICATION SERVICES "PCS" TELEPHONE HANDSETS, TRANSCEIVERS, INTERCOMS, TELEPHONE HANDSETS; DIGITAL AUDIO PLAYERS; MP3 PLAYERS; TOUCH TYPE INPUT DEVICES FOR ELECTRONIC COMMUNICATION MACHINES AND APPARATUS, NAMELY, TOUCH PANELS, TOUCH SCREENS, TOUCH PADS, TOUCH TABLETS; ROTARY AND PUSH-DOWN TYPE INPUT BUTTONS AND SWITCHES FOR ELECTRONIC COMMUNICATION MACHINES AND APPARATUS; PORTABLE DISPLAYS FOR ELECTRONIC PUBLICATIONS, NAMELY, LIQUID CRYSTAL DISPLAYS; TOUCH TYPE INPUT DEVICES FOR ELECTRONIC MACHINES AND APPARATUS, NAMELY, TOUCH PANELS, TOUCH SCREENS, TOUCH PADS, TOUCH TABLETS; ROTARY AND PUSH-DOWN TYPE INPUT BUTTONS AND SWITCHES FOR ELECTRONIC MACHINES AND APPARATUS; LAPTOP PERSONAL COMPUTERS (U.S. CLS. 21, 23, 26, 36 AND 38).

DARRYL SPRUILL, EXAMINING ATTORNEY

CLASS 9—(Continued).

SN 78-735,242. OMRON CORPORATION, KYOTO, JAPAN,
FILED 10-18-2005.

CombinationJog

THE MARK CONSISTS OF STANDARD CHARACTERS WITHOUT CLAIM TO ANY PARTICULAR FONT, STYLE, SIZE, OR COLOR.

PRIORITY CLAIMED UNDER SEC. 44(D) ON JAPAN APPLICATION NO. JP2005-9452, FILED 10-11-2005, REG. NO. 4955340, DATED 5-26-2006, EXPIRES 5-26-2016.

FOR ROTARY CONVERTERS; PHASE MODIFIERS; SWITCHES, NAMELY, CUT-OUT SWITCHES, DIFFERENTIAL SWITCHES, ETHERNET SWITCHES, CONTROL SWITCHES, PRESSURE SWITCHES, ELECTRIC SWITCHES; TELECOMMUNICATION MACHINES AND APPARATUS, AND THEIR PARTS AND ACCESSORIES, NAMELY, TELEPHONES, MODEMS, ROUTERS, PDAS, CORDLESS TELEPHONES, CELL PHONES, PORTABLE TELEPHONES, TRANSFORMERS FOR MODEMS, PERSONAL COMMUNICATION SERVICES "PCS" TELEPHONE HANDSETS, TRANSCEIVERS, INTERCOMS, TELEPHONE HANDSETS; DIGITAL AUDIO PLAYERS; MP3 PLAYERS; TOUCH TYPE INPUT DEVICES FOR ELECTRONIC COMMUNICATION MACHINES AND APPARATUS, NAMELY, TOUCH PANELS, TOUCH SCREENS, TOUCH PADS, TOUCH TABLETS; ROTARY AND PUSH-DOWN TYPE INPUT BUTTONS AND SWITCHES FOR ELECTRONIC COMMUNICATION MACHINES AND APPARATUS; PORTABLE DISPLAYS FOR ELECTRONIC PUBLICATIONS, NAMELY, LIQUID CRYSTAL DISPLAYS; TOUCH TYPE INPUT DEVICES FOR ELECTRONIC MACHINES AND APPARATUS, NAMELY, TOUCH PANELS, TOUCH SCREENS, TOUCH PADS, TOUCH TABLETS; ROTARY AND PUSH-DOWN TYPE INPUT BUTTONS AND SWITCHES FOR ELECTRONIC MACHINES AND APPARATUS; LAPTOP PERSONAL COMPUTERS (U.S. CLS. 21, 23, 26, 36 AND 38).
DARRYL SPRULL, EXAMINING ATTORNEY

SN 78-740,059. COLE, WES A., TULSA, OK. FILED 10-25-2005.

HABITUAL HEALTH

THE MARK CONSISTS OF STANDARD CHARACTERS WITHOUT CLAIM TO ANY PARTICULAR FONT, STYLE, SIZE, OR COLOR.

NO CLAIM IS MADE TO THE EXCLUSIVE RIGHT TO USE "HEALTH", APART FROM THE MARK AS SHOWN.

FOR AUDIO TAPE FEATURING SELF HELP PROGRAM REGARDING NUTRITION AND FITNESS AND ACCOMPANYING WRITTEN MATERIAL SOLD AS A UNIT (U.S. CLS. 21, 23, 26, 36 AND 38).

FIRST USE 10-25-2005; IN COMMERCE 10-25-2005.
JAMES A. RAUEN, EXAMINING ATTORNEY

CLASS 9—(Continued).

SN 78-747,782. MSTATION CORPORATION, EL MONTE, CA.
FILED 11-4-2005.

MSTATION ORB

THE MARK CONSISTS OF STANDARD CHARACTERS WITHOUT CLAIM TO ANY PARTICULAR FONT, STYLE, SIZE, OR COLOR.

NO CLAIM IS MADE TO THE EXCLUSIVE RIGHT TO USE "ORB", APART FROM THE MARK AS SHOWN.

FOR AUDIO SPEAKERS; LOUD SPEAKERS; STEREO SYSTEMS COMPRISED OF AUDIO SPEAKERS, STEREO DRIVERS, SUBWOOFER DRIVERS, STEREO AMPLIFIERS, AND SUBWOOFER AMPLIFIERS INCORPORATING DOCKING STATIONS OR INTERFACES FOR USE WITH AUDIO DEVICES, INCLUDING, PORTABLE AUDIO DEVICES, PERSONAL AUDIO DEVICES; HOME ENTERTAINMENT SYSTEMS COMPRISED OF AUDIO SPEAKERS INCORPORATING DOCKING STATIONS OR INTERFACES FOR USE WITH AUDIO DEVICES, INCLUDING, PORTABLE AUDIO DEVICES, PERSONAL AUDIO DEVICES; AND AUDIO EQUIPMENT FOR VEHICLES, NAMELY, SPEAKERS, AMPLIFIERS, EQUALIZERS, SPEAKER HOUSING, AND SUBWOOFERS; AUDIO SPEAKERS, LOUD SPEAKERS, AND STEREO SYSTEMS COMPRISED OF AUDIO SPEAKERS, STEREO RECEIVERS, STEREO TUNERS INCORPORATING DOCKING STATIONS OR INTERFACES FOR USE WITH AUDIO DEVICES, INCLUDING, PORTABLE AUDIO DEVICES, PERSONAL AUDIO DEVICES, AND HOME ENTERTAINMENT SYSTEMS; AUDIO EQUIPMENT FOR VEHICLES, NAMELY, STEREOS, SPEAKERS, AMPLIFIERS, SPEAKER HOUSINGS AND SUBWOOFERS INCORPORATING DOCKING STATIONS OR INTERFACES FOR USE WITH AUDIO DEVICES, INCLUDING, PORTABLE AUDIO DEVICES, PERSONAL AUDIO DEVICES; REMOTE CONTROLS FOR AUDIO SPEAKERS, STEREOS, HOME ENTERTAINMENT SYSTEMS, AUDIO EQUIPMENT FOR VEHICLES, AND VIDEO SYSTEMS; VIDEO GAME ACCESSORIES, NAMELY, VIDEO GAME JOYSTICKS, VIDEO GAME INTERACTIVE REMOTE CONTROL UNITS, AND AUDIO SPEAKERS; AND BATTERIES (U.S. CLS. 21, 23, 26, 36 AND 38).
TINA BROWN, EXAMINING ATTORNEY

CLASS 9—(Continued).

SN 78-752,460. MATSUSHITA ELECTRIC INDUSTRIAL CO., LTD., OSAKA, JAPAN, FILED 11-11-2005.

UNIPHIER

THE MARK CONSISTS OF STANDARD CHARACTERS WITHOUT CLAIM TO ANY PARTICULAR FONT, STYLE, SIZE, OR COLOR.

OWNER OF JAPAN REG. NO. 4810847, DATED 10-15-2004, EXPIRES 10-15-2014.

FOR DIGITAL CONSUMER ELECTRONICS, NAMELY, HDD AUDIO PLAYERS AND/OR RECORDERS, HDD VIDEO PLAYERS AND/OR RECORDERS, IC MEMORY AUDIO PLAYERS AND/OR RECORDERS, IC MEMORY VIDEO PLAYERS AND/OR RECORDERS, OPTICAL DISC AUDIO PLAYERS AND/OR RECORDERS, OPTICAL DISC VIDEO PLAYERS AND/OR RECORDERS, TELEVISIONS, CAMERAS, CAMCORDERS, MOBILE TELEPHONES, ELECTRONIC HANDHELD UNITS FOR THE WIRELESS RECEIPT AND/OR TRANSMISSION OF DATA, PERSONAL COMPUTERS, IN-CAR NAVIGATION AND/OR ROUTE GUIDANCE DEVICES; INTEGRATED CIRCUITS AND SOFTWARE FOR USE IN THE AFOREMENTIONED DIGITAL CONSUMER ELECTRONICS (U.S. CLS. 21, 23, 26, 36 AND 38).

HOWARD B. LEVINE, EXAMINING ATTORNEY

SN 78-756,221. TELTRONICS, INC., SARASOTA, FL. FILED 11-17-2005.

NET-PATH

THE MARK CONSISTS OF STANDARD CHARACTERS WITHOUT CLAIM TO ANY PARTICULAR FONT, STYLE, SIZE, OR COLOR.

OWNER OF U.S. REG. NO. 1,909,194.

FOR COMPUTER PROGRAM FOR INTERFACING WITH REMOTE COMPUTER STORAGE AND UPLOADING FILES THEREFROM AND MICROCOMPUTER CONTROLLED HARDWARE WITH OPERATING SOFTWARE AND CUSTOMER PROGRAMMABLE LOGIC, THAT PERFORMS AS A REMOTE, INDEPENDENT AGENT USED TO DETECT AND REPORT ENVIRONMENTAL CONDITIONS; TO DETECT AND REPORT FAULTS, PROCESS AND FORWARD DATA, MONITOR AND REPORT PERFORMANCE PARAMETERS, EXECUTE CORRECTIVE ACTIONS, AND EXECUTE SYSTEM CONFIGURATION PROCEDURES FOR TELECOMMUNICATIONS, DATA-COMMUNICATIONS AND OTHER PRODUCTS THAT CAN BE MONITORED FOR STATUS CONDITIONS OR CONFIGURED THROUGH A MANAGEMENT INTERFACE (U.S. CLS. 21, 23, 26, 36 AND 38).

FIRST USE 1-31-2005; IN COMMERCE 1-31-2005.
TRAVIS WHEATLEY, EXAMINING ATTORNEY

CLASS 9—(Continued).

SN 78-756,370. TELTRONICS, INC., SARASOTA, FL. FILED 11-17-2005.

NET-PATHm

THE MARK CONSISTS OF STANDARD CHARACTERS WITHOUT CLAIM TO ANY PARTICULAR FONT, STYLE, SIZE, OR COLOR.

OWNER OF U.S. REG. NO. 1,909,194.

FOR COMPUTER PROGRAM FOR INTERFACING WITH REMOTE COMPUTER STORAGE AND UPLOADING FILES THEREFROM AND MICROCOMPUTER CONTROLLED HARDWARE WITH OPERATING SOFTWARE AND CUSTOMER PROGRAMMABLE LOGIC, THAT PERFORMS AS A REMOTE, INDEPENDENT AGENT USED TO DETECT AND REPORT ENVIRONMENTAL CONDITIONS; TO DETECT AND REPORT FAULTS, PROCESS AND FORWARD DATA, MONITOR AND REPORT PERFORMANCE PARAMETERS, EXECUTE CORRECTIVE ACTIONS, AND EXECUTE SYSTEM CONFIGURATION PROCEDURES FOR TELECOMMUNICATIONS, DATA-COMMUNICATIONS AND OTHER PRODUCTS THAT CAN BE MONITORED FOR STATUS CONDITIONS OR CONFIGURED THROUGH A MANAGEMENT INTERFACE (U.S. CLS. 21, 23, 26, 36 AND 38).

FIRST USE 3-8-2005; IN COMMERCE 3-8-2005.

TRAVIS WHEATLEY, EXAMINING ATTORNEY

SN 78-756,386. TRACTIVITY INC., HOUSTON, TX. FILED 11-17-2005.

TRACTIVITY

THE MARK CONSISTS OF STANDARD CHARACTERS WITHOUT CLAIM TO ANY PARTICULAR FONT, STYLE, SIZE, OR COLOR.

FOR COMPUTER SOFTWARE AND HARDWARE USED TO PROVIDE INTEGRATED TIME TRACKING AND BUSINESS ANALYSIS SOLUTIONS (U.S. CLS. 21, 23, 26, 36 AND 38).

FIRST USE 11-1-1999; IN COMMERCE 11-1-1999.

SUSAN LESLIE DUBOIS, EXAMINING ATTORNEY

CLASS 9—(Continued).

SN 78-762,030. PROGRESSIVE GAMING INTERNATIONAL CORPORATION, LAS VEGAS, NV. FILED 11-28-2005.



NO CLAIM IS MADE TO THE EXCLUSIVE RIGHT TO USE "TEXAS HOLD 'EM LIVE", APART FROM THE MARK AS SHOWN.

FOR GAMING EQUIPMENT, NAMELY, GAMING MACHINES AND GAME SOFTWARE USED THEREWITH (U.S. CLS. 21, 23, 26, 36 AND 38).

FIRST USE 9-13-2005; IN COMMERCE 9-13-2005.
MARY MUNSON, EXAMINING ATTORNEY

CLASS 9—(Continued).

SN 78-764,266. TELTRONICS, INC., SARASOTA, FL. FILED 12-1-2005.

NET-PATH Plus

THE MARK CONSISTS OF STANDARD CHARACTERS WITHOUT CLAIM TO ANY PARTICULAR FONT, STYLE, SIZE, OR COLOR.

OWNER OF U.S. REG. NO. 1,909,194.

FOR COMPUTER PROGRAM FOR INTERFACING WITH REMOTE COMPUTER STORAGE AND UPLOADING FILES THEREFROM AND MICROCOMPUTER CONTROLLED HARDWARE WITH OPERATING SOFTWARE AND CUSTOMER PROGRAMMABLE LOGIC, THAT PERFORMS AS A REMOTE, INDEPENDENT AGENT USED TO DETECT AND REPORT ENVIRONMENTAL CONDITIONS; TO DETECT AND REPORT FAULTS, PROCESS AND FORWARD DATA, MONITOR AND REPORT PERFORMANCE PARAMETERS, EXECUTE CORRECTIVE ACTIONS, AND EXECUTE SYSTEM CONFIGURATION PROCEDURES FOR TELECOMMUNICATIONS, DATA-COMMUNICATIONS AND OTHER PRODUCTS THAT CAN BE MONITORED FOR STATUS CONDITIONS OR CONFIGURED THROUGH A MANAGEMENT INTERFACE, WITH FIREWALL PROTECTION, NAMELY COMPUTER SECURITY FILTERS TO RESTRICT ACCESS TO AND BY COMPUTER NETWORKS TO AND OF UNDESIRABLE WEB SITES, MEDIA AND INDIVIDUALS AND FACILITIES (U.S. CLS. 21, 23, 26, 36 AND 38).

FIRST USE 11-22-2005; IN COMMERCE 11-22-2005.
TRAVIS WHEATLEY, EXAMINING ATTORNEY

SN 78-762,227. MODERA CONSULTING LLC, TALLINN, ESTONIA, FILED 11-29-2005.



NO CLAIM IS MADE TO THE EXCLUSIVE RIGHT TO USE "NET", APART FROM THE MARK AS SHOWN.

FOR COMPUTER SOFTWARE PLATFORMS FOR CREATING, BUILDING AND OPERATING BUSINESS INTRANETS AND EXTRANETS (U.S. CLS. 21, 23, 26, 36 AND 38).

FIRST USE 1-9-2006; IN COMMERCE 1-9-2006.
SUE LAWRENCE, EXAMINING ATTORNEY

SN 78-764,508. WIRELESS CONNECTION, INC., OMAHA, NE. FILED 12-1-2005.

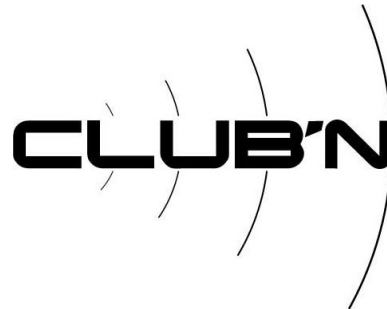

SN 78-762,242. MODERA CONSULTING LLC, TALLINN, ESTONIA, FILED 11-29-2005.



THE MARK CONSISTS OF STANDARD CHARACTERS WITHOUT CLAIM TO ANY PARTICULAR FONT, STYLE, SIZE, OR COLOR.

FOR COMPUTER SOFTWARE PLATFORMS FOR CREATING, BUILDING AND OPERATING BUSINESS INTRANETS AND EXTRANETS (U.S. CLS. 21, 23, 26, 36 AND 38).

FIRST USE 1-9-2006; IN COMMERCE 1-9-2006.
SUE LAWRENCE, EXAMINING ATTORNEY

THE MARK CONSISTS OF THE WORD "CLUB'N". FOR CELLULAR TELEPHONE ACCESSORIES; NAMELY, DECORATIVE CHARMS FOR CELLULAR TELEPHONES AND SPECIALTY PURSES, TOTES AND CASES FOR CARRYING CELLULAR TELEPHONES (U.S. CLS. 21, 23, 26, 36 AND 38).

FIRST USE 9-1-2005; IN COMMERCE 9-1-2005.
STEVEN R. FINE, EXAMINING ATTORNEY

CLASS 9—(Continued).

SN 78-764,856. O2MICRO, INC., SANTA CLARA, CA. FILED 12-1-2005.

SIFOWORKS

THE MARK CONSISTS OF STANDARD CHARACTERS WITHOUT CLAIM TO ANY PARTICULAR FONT, STYLE, SIZE, OR COLOR.

FOR NETWORK SECURITY SYSTEM COMPOSED OF COMPUTER HARDWARE AND COMPUTER SOFTWARE FOR THE SECURE ENABLING OF ACCESS TO COMPUTER NETWORKS (U.S. CLS. 21, 23, 26, 36 AND 38).

FIRST USE 2-14-2006; IN COMMERCE 2-14-2006.
VERNA BETH RIRIE, EXAMINING ATTORNEY

SN 78-765,308. WIRELESS CONNECTION, INC., OMAHA, NE. FILED 12-2-2005.



THE MARK CONSISTS OF THE WORD "GRIZZLY" AND A DRAWING OF A GRIZZLY BEAR.

FOR CELLULAR TELEPHONE ACCESSORIES; NAMELY, SPECIALTY CASES AND POUCHES FOR CARRYING CELLULAR TELEPHONES (U.S. CLS. 21, 23, 26, 36 AND 38).

FIRST USE 9-1-2005; IN COMMERCE 9-1-2005.
STEVEN R. FINE, EXAMINING ATTORNEY

SN 78-770,311. SPREADSHEETGEAR, LLC, LENEXA, KS. FILED 12-9-2005.

SPREADSHEETGEAR

THE MARK CONSISTS OF STANDARD CHARACTERS WITHOUT CLAIM TO ANY PARTICULAR FONT, STYLE, SIZE, OR COLOR.

FOR COMPUTER SOFTWARE FOR USE AS A SPREADSHEET (U.S. CLS. 21, 23, 26, 36 AND 38).

FIRST USE 3-1-2005; IN COMMERCE 9-1-2005.
KATHERINE STOIDES, EXAMINING ATTORNEY

CLASS 9—(Continued).

SN 78-780,109. CREDIT SUISSE SECURITIES (USA) LLC, NEW YORK, NY. FILED 12-23-2005.

VALUESEARCH

THE MARK CONSISTS OF STANDARD CHARACTERS WITHOUT CLAIM TO ANY PARTICULAR FONT, STYLE, SIZE, OR COLOR.

SEC. 2(F).

FOR COMPUTER SOFTWARE AND SOFTWARE RECORDED ON CD-ROMS IN THE FIELD OF FINANCIAL SERVICES THAT COMBINES A DATABASE OF PUBLICLY TRADED COMPANIES WITH ANALYTIC TOOLS AND A CALCULATION ENGINE FOR THE PURPOSE OF EVALUATING AND DETERMINING INVESTMENT OPPORTUNITIES, AND CREATING REPORTS AND CHARTS OF SUCH INVESTMENT OPPORTUNITIES (U.S. CLS. 21, 23, 26, 36 AND 38).

FIRST USE 0-0-1996; IN COMMERCE 0-0-1996.
KELLY BOULTON, EXAMINING ATTORNEY

SN 78-781,212. TOUCH MEDIX, LLC, WOODLAND HILLS, CA. FILED 12-27-2005.

TOUCH MEDIX

THE MARK CONSISTS OF STANDARD CHARACTERS WITHOUT CLAIM TO ANY PARTICULAR FONT, STYLE, SIZE, OR COLOR.

FOR COMPUTER SOFTWARE FOR DOCUMENT GENERATION AND DOCUMENT MANAGEMENT FOR MEDICAL APPLICATIONS (U.S. CLS. 21, 23, 26, 36 AND 38).

FIRST USE 9-1-2005; IN COMMERCE 9-1-2005.
SHARI SHEFFIELD, EXAMINING ATTORNEY

SN 78-781,233. TOUCH MEDIX, LLC, WOODLAND HILLS, CA. FILED 12-27-2005.

TOUCH ED

THE MARK CONSISTS OF STANDARD CHARACTERS WITHOUT CLAIM TO ANY PARTICULAR FONT, STYLE, SIZE, OR COLOR.

NO CLAIM IS MADE TO THE EXCLUSIVE RIGHT TO USE "ED", APART FROM THE MARK AS SHOWN.

FOR COMPUTER SOFTWARE FOR DOCUMENT GENERATION AND DOCUMENT MANAGEMENT FOR MEDICAL APPLICATIONS (U.S. CLS. 21, 23, 26, 36 AND 38).

FIRST USE 9-1-2005; IN COMMERCE 9-1-2005.
SHARI SHEFFIELD, EXAMINING ATTORNEY

CLASS 9—(Continued).

SN 78-781,251. TOUCH MEDIX, LLC, WOODLAND HILLS, CA. FILED 12-27-2005.

KEEPING IN TOUCH WITH YOUR MEDICAL DOCUMENTATION

THE MARK CONSISTS OF STANDARD CHARACTERS WITHOUT CLAIM TO ANY PARTICULAR FONT, STYLE, SIZE, OR COLOR.

FOR COMPUTER SOFTWARE FOR DOCUMENT GENERATION AND DOCUMENT MANAGEMENT FOR MEDICAL APPLICATIONS (U.S. CLS. 21, 23, 26, 36 AND 38).

FIRST USE 9-1-2005; IN COMMERCE 9-1-2005.
SHARI SHEFFIELD, EXAMINING ATTORNEY

SN 78-781,628. KRAWCYKOWSKI, BRIAN T. CALABASAS, CA. AND NIXON, QUINTON C, NEWBURY PARK, CA. FILED 12-28-2005.

Auratone

THE MARK CONSISTS OF STANDARD CHARACTERS WITHOUT CLAIM TO ANY PARTICULAR FONT, STYLE, SIZE, OR COLOR.

FOR AUDIO CIRCUIT BOARDS; CABINETS FOR LOUDSPEAKERS; ELECTRIC AUDIO PLAYBACK UNITS WITH LIGHTS AND SPEAKERS; ELECTRONIC EFFECT PEDALS FOR USE WITH SOUND AMPLIFIERS; GUITAR AMPLIFIERS; GUITAR CABLES; MICROPHONE CABLES; MUSICAL INSTRUMENT AMPLIFIERS (U.S. CLS. 21, 23, 26, 36 AND 38).

GINA FINK, EXAMINING ATTORNEY

SN 78-782,898. CARE CENTERS MANAGEMENT GROUP, INC., JOHNSON CITY, TN. FILED 12-30-2005.

SETTING REALISTIC EXPECTATIONS

THE MARK CONSISTS OF STANDARD CHARACTERS WITHOUT CLAIM TO ANY PARTICULAR FONT, STYLE, SIZE, OR COLOR.

FOR EDUCATIONAL AND RISK MANAGEMENT VIDEO CASSETTES AND DISCS FOR THOSE IN THE HEALTHCARE AND LONG TERM CARE INDUSTRY (U.S. CLS. 21, 23, 26, 36 AND 38).

FIRST USE 4-0-2001; IN COMMERCE 4-0-2001.
ELIZABETH PIGNATELLO, EXAMINING ATTORNEY

CLASS 9—(Continued).

SN 78-783,273. QILINSOFT, LLC, MENLO PARK, CA. FILED 12-30-2005.

QILINSOFT

THE MARK CONSISTS OF STANDARD CHARACTERS WITHOUT CLAIM TO ANY PARTICULAR FONT, STYLE, SIZE, OR COLOR.

FOR COMPUTER SOFTWARE FOR USE IN THE MANAGEMENT OF COMPUTER NETWORKS AND TRANSMISSION OF DATA OVER NETWORKS; COMPUTER SOFTWARE FOR STRUCTURING AND MANAGING DATA FOR INFORMATION EXCHANGE; COMPUTER SOFTWARE FOR THE COLLECTION, EDITING, ORGANIZING, MODIFYING, ANALYZING, DISPLAYING, TRANSMISSION, STORAGE AND SHARING OF DATA AND INFORMATION; COMPUTER SOFTWARE FOR CREATING SEARCHABLE DATABASES OF INFORMATION AND DATA (U.S. CLS. 21, 23, 26, 36 AND 38).

AMY GEARIN, EXAMINING ATTORNEY

SN 78-783,277. QILINSOFT, LLC, MENLO PARK, CA. FILED 12-30-2005.

BUSINESSMONITOR

THE MARK CONSISTS OF STANDARD CHARACTERS WITHOUT CLAIM TO ANY PARTICULAR FONT, STYLE, SIZE, OR COLOR.

FOR COMPUTER SOFTWARE FOR THE COLLECTION, EDITING, ORGANIZING, MODIFYING, ANALYZING, DISPLAYING, TRANSMISSION, STORAGE AND SHARING OF DATA AND INFORMATION; COMPUTER SOFTWARE FOR CREATING SEARCHABLE DATABASES OF INFORMATION AND DATA (U.S. CLS. 21, 23, 26, 36 AND 38).

AMY GEARIN, EXAMINING ATTORNEY

SN 78-783,284. QILINSOFT, LLC, MENLO PARK, CA. FILED 12-30-2005.

OPERATIONAL INSIGHT

THE MARK CONSISTS OF STANDARD CHARACTERS WITHOUT CLAIM TO ANY PARTICULAR FONT, STYLE, SIZE, OR COLOR.

FOR COMPUTER SOFTWARE FOR THE COLLECTION, EDITING, ORGANIZING, MODIFYING, ANALYZING, DISPLAYING, TRANSMISSION, STORAGE AND SHARING OF DATA AND INFORMATION; COMPUTER SOFTWARE FOR CREATING SEARCHABLE DATABASES OF INFORMATION AND DATA (U.S. CLS. 21, 23, 26, 36 AND 38).

AMY GEARIN, EXAMINING ATTORNEY

CLASS 9—(Continued).

SN 78-789,163. ILS TECHNOLOGY, LLC, BOCA RATON, FL. FILED 1-11-2006.

QCOUPLER

THE MARK CONSISTS OF STANDARD CHARACTERS WITHOUT CLAIM TO ANY PARTICULAR FONT, STYLE, SIZE, OR COLOR.

FOR HARDWARE WITH EMBEDDED SOFTWARE FOR USE IN COLLECTING, ANALYZING AND TRANSPORTING PRODUCTION DATA COLLECTED FROM LOW-LEVEL PRODUCTION DEVICES TO APPLICATIONS AND DATABASES AT THE ENTERPRISE LEVEL (U.S. CLS. 21, 23, 26, 36 AND 38).

CAROLYN GRAY, EXAMINING ATTORNEY

SN 78-789,284. ILS TECHNOLOGY, LLC, BOCA RATON, FL. FILED 1-11-2006.

NANOWISE

THE MARK CONSISTS OF STANDARD CHARACTERS WITHOUT CLAIM TO ANY PARTICULAR FONT, STYLE, SIZE, OR COLOR.

FOR HARDWARE WITH EMBEDDED SOFTWARE FOR USE IN STORING AND TRANSPORTING OF MESSAGES BETWEEN LOW-LEVEL PRODUCTION DEVICES AND APPLICATIONS AND DATABASES AT THE ENTERPRISE LEVEL, USING A TOPIC-BASED SUBSCRIBE AND PUBLISH SCHEME (U.S. CLS. 21, 23, 26, 36 AND 38).

CAROLYN GRAY, EXAMINING ATTORNEY

SN 78-790,417. ILS TECHNOLOGY, LLC, BOCA RATON, FL. FILED 1-12-2006.

NANOBROKER

THE MARK CONSISTS OF STANDARD CHARACTERS WITHOUT CLAIM TO ANY PARTICULAR FONT, STYLE, SIZE, OR COLOR.

FOR SOFTWARE, NAMELY EMBEDDED APPLICATIONS FACILITATING THE STORAGE AND TRANSPORT OF MESSAGES FROM LOW-LEVEL PRODUCTION DEVICES TO HIGHER-LEVEL SOFTWARE APPLICATIONS USING A TOPIC-BASED SUBSCRIBE AND PUBLISH SCHEME, AND PROVIDING A COMMUNICATION INFRASTRUCTURE FOR FACILITATING COMMUNICATIONS BETWEEN LOCALLY-EXECUTING SERVICES AND SERVICES EXECUTING ON OTHER PLATFORMS (U.S. CLS. 21, 23, 26, 36 AND 38).

CAROLYN GRAY, EXAMINING ATTORNEY

CLASS 9—(Continued).

SN 78-790,757. EMBEDDED BITWISE SYSTEMS, GOLETA, CA. FILED 1-12-2006.

PROHUB

THE MARK CONSISTS OF STANDARD CHARACTERS WITHOUT CLAIM TO ANY PARTICULAR FONT, STYLE, SIZE, OR COLOR.

FOR COMPUTER HUB DEVICES, NAMELY, COMMUNICATION HUBS SPECIFICALLY DESIGNED TO CONNECT LARGE NUMBERS OF USB DEVICES TO A HOST COMPUTER (U.S. CLS. 21, 23, 26, 36 AND 38).

BARBARA BROWN, EXAMINING ATTORNEY

SN 78-793,916. COMPUMIND, INC., SMYRNA, GA. FILED 1-18-2006.

COMPUMIND

THE MARK CONSISTS OF STANDARD CHARACTERS WITHOUT CLAIM TO ANY PARTICULAR FONT, STYLE, SIZE, OR COLOR.

FOR COMPUTER SOFTWARE FOR TESTING, SCORING, AND IMPROVING SPIRITUALITY AND PERSONAL EMPOWERMENT IN THE FIELD OF SELF-HELP; COMPUTER SOFTWARE FOR TESTING, SCORING, AND IMPROVING SPIRITUALITY AND PERSONAL EMPOWERMENT IN THE FIELD OF SELF-HELP THAT MAY BE DOWNLOADED FROM A GLOBAL COMPUTER NETWORK (U.S. CLS. 21, 23, 26, 36 AND 38).

FIRST USE 11-1-1995; IN COMMERCE 3-5-1996.

COLLEEN DOMBROW, EXAMINING ATTORNEY

SN 78-794,272. D-BLOCCRECORDS, LAS VEGAS, NV. FILED 1-18-2006.



NO CLAIM IS MADE TO THE EXCLUSIVE RIGHT TO USE RECORDS, APART FROM THE MARK AS SHOWN.

FOR PRE-RECORDED DVDS AND CDS FEATURING MUSIC (U.S. CLS. 21, 23, 26, 36 AND 38).

STEVEN R. FINE, EXAMINING ATTORNEY

CLASS 9—(Continued).

SN 78-794,870. ECHEF, LLC, LINCOLN, NE. FILED 1-19-2006.

eCHEF

THE MARK CONSISTS OF STANDARD CHARACTERS WITHOUT CLAIM TO ANY PARTICULAR FONT, STYLE, SIZE, OR COLOR.

FOR COMPUTER SOFTWARE FOR CREATING SEARCHABLE DATABASES OF INFORMATION AND DATA; COMPUTER SOFTWARE FOR THE COLLECTION, EDITING, ORGANIZING, MODIFYING, BOOK MARKING, TRANSMISSION, STORAGE AND SHARING OF DATA AND INFORMATION; COMPUTER SOFTWARE FOR RECIPE MANAGEMENT AND A RECIPE DATABASE (U.S. CLS. 21, 23, 26, 36 AND 38).

PRISCILLA MILTON, EXAMINING ATTORNEY

SN 78-795,808. GIANNULLI, THOMAS, C, BEVERLY HILLS, CA. FILED 1-20-2006.



NO CLAIM IS MADE TO THE EXCLUSIVE RIGHT TO USE "INFLIGHT POWER", APART FROM THE MARK AS SHOWN.

"THE COLOR(S) GRAY, BLACK AND WHITE IS/ARE CLAIMED AS A FEATURE OF THE MARK."

"THE MARK CONSISTS OF THE COLOR GRAY AS IT APPEARS IN THE AIRCRAFT DESIGN, THE COLOR BLACK APPEARS IN THE REMAINING DESIGN FEATURE AND THE WORDING, AND THE COLOR WHITE APPEARS AS THE BACKGROUND."

FOR MOBILE DEVICE POWER CABLE AND CONVERTER FOR USE ON AN AIRPLANE, BUS AND TRAIN (U.S. CLS. 21, 23, 26, 36 AND 38).

DAVID H. STINE, EXAMINING ATTORNEY

SN 78-797,789. IMPACT ENGINEERING, INC., DBA IMPACT WELDING, INC., JACKSON, MI. FILED 1-24-2006.

WELD SIGNATURE

THE MARK CONSISTS OF STANDARD CHARACTERS WITHOUT CLAIM TO ANY PARTICULAR FONT, STYLE, SIZE, OR COLOR.

OWNER OF U.S. REG. NO. 2,401,085. SEC. 2(F).

FOR WELDING MONITORING SOFTWARE, NAMELY, COMPUTER SOFTWARE FOR USE IN DETERMINING WELD QUALITY; WELDING MONITORING EQUIPMENT, NAMELY, WELD DETECTORS, MICROPROCESSORS AND COMPUTERS (U.S. CLS. 21, 23, 26, 36 AND 38).

FIRST USE 9-4-1998; IN COMMERCE 9-4-1998.

DAVID MILLER, EXAMINING ATTORNEY

CLASS 9—(Continued).

SN 78-803,695. MINITAB INC., STATE COLLEGE, PA. FILED 1-31-2006.

QUALITY TRAINER BY MINITAB

THE MARK CONSISTS OF STANDARD CHARACTERS WITHOUT CLAIM TO ANY PARTICULAR FONT, STYLE, SIZE, OR COLOR.

OWNER OF U.S. REG. NOS. 2,251,375, 2,760,749 AND OTHERS.

NO CLAIM IS MADE TO THE EXCLUSIVE RIGHT TO USE "QUALITY TRAINER", APART FROM THE MARK AS SHOWN.

FOR COMPUTER SOFTWARE FOR USE IN TRAINING OF STATISTICS AND STATISTICAL SOFTWARE (U.S. CLS. 21, 23, 26, 36 AND 38).

MICHAEL LEWIS, EXAMINING ATTORNEY

SN 78-805,534. DOVER DOWNS GAMING & ENTERTAINMENT, INC., WILMINGTON, DE. FILED 2-2-2006.

DOVER DOWNS IS COOKING

THE MARK CONSISTS OF STANDARD CHARACTERS WITHOUT CLAIM TO ANY PARTICULAR FONT, STYLE, SIZE, OR COLOR.

OWNER OF U.S. REG. NOS. 2,697,403 AND 2,788,453. FOR DVDS FEATURING COOKING SHOWS (U.S. CLS. 21, 23, 26, 36 AND 38).

FIRST USE 4-5-2005; IN COMMERCE 4-5-2005.

BENJAMIN OKEKE, EXAMINING ATTORNEY

SN 78-805,623. PESA SWITCHING SYSTEMS, INC., HUNTSVILLE, AL. FILED 2-2-2006.

FORTEL INSIDE

THE MARK CONSISTS OF STANDARD CHARACTERS WITHOUT CLAIM TO ANY PARTICULAR FONT, STYLE, SIZE, OR COLOR.

FOR SIGNAL PROCESSORS FOR PROCESSING ANALOG AND DIGITAL VIDEO AND AUDIO SIGNALS AND SPECIFICALLY EXCLUDING MICROPROCESSORS, SEMI-CONDUCTOR PROCESSOR CHIPS, CIRCUIT BOARDS AND ELECTRONIC EQUIPMENT FOR RECORDING, PROCESSING, RECEIVING, REPRODUCING, TRANSMITTING, MODIFYING, COMPRESSING, DECOMPRESSING, BROADCASTING, MERGING, AND ENHANCING SOUND, VIDEO IMAGES, GRAPHICS AND DATA (U.S. CLS. 21, 23, 26, 36 AND 38).

JORDAN BAKER, EXAMINING ATTORNEY

CLASS 9—(Continued).

SN 78-806,726. ARTECO VISION SYSTEMS, ST. LOUIS, MO. FILED 2-3-2006.

**THE POWER OF SEEING
WITHOUT WATCHING**

THE MARK CONSISTS OF STANDARD CHARACTERS WITHOUT CLAIM TO ANY PARTICULAR FONT, STYLE, SIZE, OR COLOR.

FOR COMPUTER SOFTWARE AND COMBINED COMPUTER HARDWARE AND SOFTWARE FOR USE IN PERFORMING PERCEPTUAL ANALYSIS OF IMAGES OF PEOPLE AND OTHER MOVABLE OBJECTS (U.S. CLS. 21, 23, 26, 36 AND 38).

FIRST USE 3-1-2005; IN COMMERCE 3-1-2005.

ANDREA K. NADELMAN, EXAMINING ATTORNEY

SN 78-809,595. PESA SWITCHING SYSTEMS, INC., HUNTSVILLE, AL. FILED 2-8-2006.



THE MARK CONSISTS OF THE WORD "FORTEL" ENCLOSED IN A RECTANGLE. A CURVED LINE APPEARS IN THE LOWER CENTER TO RIGHT HAND CORNER OF THE RECTANGLE BELOW THE WORD "FORTEL". THE WORD "INSIDE" APPEARS WITHIN THE CURVED LINE.

FOR SIGNAL PROCESSORS FOR PROCESSING ANALOG AND DIGITAL VIDEO AND AUDIO SIGNALS AND SPECIFICALLY EXCLUDING MICROPROCESSORS, SEMI-CONDUCTOR PROCESSOR CHIPS, CIRCUIT BOARDS AND ELECTRONIC EQUIPMENT FOR RECORDING, PROCESSING, RECEIVING, REPRODUCING, TRANSMITTING, MODIFYING, COMPRESSING, DECOMPRESSING, BROADCASTING, MERGING, AND ENHANCING SOUND, VIDEO IMAGES, GRAPHICS AND DATA (U.S. CLS. 21, 23, 26, 36 AND 38).

JORDAN BAKER, EXAMINING ATTORNEY

CLASS 9—(Continued).

SN 78-809,601. PESA SWITCHING SYSTEMS, INC., HUNTSVILLE, AL. FILED 2-8-2006.



THE COLOR(S) RED AND WHITE IS/ARE CLAIMED AS A FEATURE OF THE MARK.

THE MARK CONSISTS OF THE WORD "FORTEL" ENCLOSED IN A RED RECTANGLE. A CURVED WHITE LINE APPEARS IN THE LOWER CENTER TO RIGHT HAND CORNER OF THE RECTANGLE BELOW THE WORD "FORTEL". THE WORD "INSIDE" APPEARS WITHIN THE CURVED LINE. THE WORDING "FORTEL" AND "INSIDE" BOTH APPEAR IN THE COLOR WHITE.

FOR SIGNAL PROCESSORS FOR PROCESSING ANALOG AND DIGITAL VIDEO AND AUDIO SIGNALS AND SPECIFICALLY EXCLUDING MICROPROCESSORS, SEMI-CONDUCTOR PROCESSOR CHIPS, CIRCUIT BOARDS AND ELECTRONIC EQUIPMENT FOR RECORDING, PROCESSING, RECEIVING, REPRODUCING, TRANSMITTING, MODIFYING, COMPRESSING, DECOMPRESSING, BROADCASTING, MERGING, AND ENHANCING SOUND, VIDEO IMAGES, GRAPHICS AND DATA (U.S. CLS. 21, 23, 26, 36 AND 38).

JORDAN BAKER, EXAMINING ATTORNEY

SN 78-810,732. THIS IS HIT, INC., DBA BROKEN BOW RECORDS, NASHVILLE, TN. FILED 2-9-2006.

BROKEN BOW RECORDS

THE MARK CONSISTS OF STANDARD CHARACTERS WITHOUT CLAIM TO ANY PARTICULAR FONT, STYLE, SIZE, OR COLOR.

NO CLAIM IS MADE TO THE EXCLUSIVE RIGHT TO USE "RECORDS", APART FROM THE MARK AS SHOWN. FOR MUSICAL SOUND RECORDINGS AND AUDIO-VISUAL RECORDINGS FEATURING MUSIC AND ENTERTAINMENT (U.S. CLS. 21, 23, 26, 36 AND 38).

FIRST USE 7-15-1999; IN COMMERCE 7-15-1999.
MICHAEL GAFFAR, EXAMINING ATTORNEY

CLASS 9—(Continued).

SN 78-814,430. DREAMFACTORY SOFTWARE, INC., LOS GATOS, CA. FILED 2-14-2006.

ORGVIEW

THE MARK CONSISTS OF STANDARD CHARACTERS WITHOUT CLAIM TO ANY PARTICULAR FONT, STYLE, SIZE, OR COLOR.
FOR COMPUTER SOFTWARE FOR BUILDING, VIEWING, AND MANAGING HIGHLY GRAPHICAL ORGANIZATION CHARTS (U.S. CLS. 21, 23, 26, 36 AND 38).
FIRST USE 10-1-2005; IN COMMERCE 10-1-2005.
GILBERT SWIFT, EXAMINING ATTORNEY

SN 78-816,212. ELECTRONIC INSTRUMENTATION AND TECHNOLOGY, INC., STERLING, VA. FILED 2-16-2006.

Cure3D

THE MARK CONSISTS OF STANDARD CHARACTERS WITHOUT CLAIM TO ANY PARTICULAR FONT, STYLE, SIZE, OR COLOR.
OWNER OF U.S. REG. NO. 2,995,649.
FOR SOFTWARE FOR USE WITH ULTRAVIOLET MEASUREMENT INSTRUMENTS (U.S. CLS. 21, 23, 26, 36 AND 38).
FIRST USE 5-2-2004; IN COMMERCE 5-2-2004.
CHRISTOPHER OTT, EXAMINING ATTORNEY

SN 78-818,113. WASHINGTON MUTUAL, INC., SEATTLE, WA. FILED 2-17-2006.



OWNER OF U.S. REG. NOS. 1,197,378, 2,919,255 AND OTHERS.
THE MARK IS THE STYLIZED REPRESENTATION OF THE LETTER "W".
FOR MAGNETICALLY ENCODED CREDIT CARDS, CASH CARDS, CHECK CARDS, ATM CARDS, DEPOSIT CARDS, DEBIT CARDS AND STORED VALUE CARDS (U.S. CLS. 21, 23, 26, 36 AND 38).
NANCY CLARKE, EXAMINING ATTORNEY

CLASS 9—(Continued).

SN 78-819,305. PIRATECOM LLC, DENVER, PA. FILED 2-21-2006.



THE MARK CONSISTS OF SKULL AND HEADPHONES WITH STYLIZED PIRATECOM BELOW SKULL.
FOR INTERCOMS; PERSONAL HEADPHONES FOR USE WITH SOUND TRANSMITTING SYSTEMS (U.S. CLS. 21, 23, 26, 36 AND 38).
FIRST USE 1-1-2005; IN COMMERCE 1-1-2005.
MARILYN IZZI, EXAMINING ATTORNEY

SN 78-820,102. WEBSHAKA, INC., PALO ALTO, CA. FILED 2-21-2006.



THE COLOR(S) RED, BLACK, WHITE IS/ARE CLAIMED AS A FEATURE OF THE MARK.
THE MARK CONSISTS OF BEGINNING WITH THE LETTERS "YOU" IN RED AND ENDING WITH THE LETTERS "OS" IN BLACK, AGAINST A WHITE BACKGROUND.
FOR COMPUTER OPERATING SYSTEMS; COMPUTER SOFTWARE PLATFORMS FOR DISTRIBUTING AND EXECUTING WEB APPLICATIONS; COMPUTER SOFTWARE THAT ASSISTS COMPUTERS IN DEPLOYING PARALLEL APPLICATIONS AND PERFORMING PARALLEL COMPUTATIONS; WEB SITE DEVELOPMENT SOFTWARE (U.S. CLS. 21, 23, 26, 36 AND 38).
FIRST USE 2-6-2006; IN COMMERCE 2-14-2006.
JAMES GRIFFIN, EXAMINING ATTORNEY

CLASS 9—(Continued).

SN 78-820,659. KEEN INC, PORTLAND, OR. FILED 2-22-2006.

HYBRIDLIFE

THE MARK CONSISTS OF STANDARD CHARACTERS WITHOUT CLAIM TO ANY PARTICULAR FONT, STYLE, SIZE, OR COLOR.

FOR EYEWEAR, NAMELY, SUNGLASSES AND SUNGLASS FRAMES; SPORT GOGGLES FOR USE WITH SWIMMING, SCUBA, CYCLING, SKATING, MOTORCYCLING AND SKIING; SAFETY GOGGLES; EYEWEAR ACCESSORIES, NAMELY, STRAPS, NECK CORDS AND HEAD STRAPS WHICH RESTRAIN EYEWEAR FROM MOVEMENT ON THE WEARER; CASES FOR EYEWEAR (U.S. CLS. 21, 23, 26, 36 AND 38).
MARGERY A. TIERNEY, EXAMINING ATTORNEY

CLASS 9—(Continued).

SN 78-825,384. UNITED SCIENCES TESTING, INC., WARRENDALE, PA. FILED 2-28-2006.

AUTO-PROBE Q2000

THE MARK CONSISTS OF STANDARD CHARACTERS WITHOUT CLAIM TO ANY PARTICULAR FONT, STYLE, SIZE, OR COLOR.

NO CLAIM IS MADE TO THE EXCLUSIVE RIGHT TO USE "AUTO PROBE", APART FROM THE MARK AS SHOWN.

FOR AUTOMATIC COMBUSTION CONTROL MACHINE AND INSTRUMENT, NAMELY AN AUTOMATED SAMPLE PROBE FOR SAMPLING A GAS STREAM (U.S. CLS. 21, 23, 26, 36 AND 38).

FIRST USE 11-30-1997; IN COMMERCE 11-30-1997.
MICHELE SWAIN, EXAMINING ATTORNEY

SN 78-827,465. SECURE-IT, INC., EAST LONGMEADOW, MA. FILED 3-2-2006.

POD SAFE

THE MARK CONSISTS OF STANDARD CHARACTERS WITHOUT CLAIM TO ANY PARTICULAR FONT, STYLE, SIZE, OR COLOR.

NO CLAIM IS MADE TO THE EXCLUSIVE RIGHT TO USE "SAFE", APART FROM THE MARK AS SHOWN.

FOR PLASTIC CASE USED AS A SECURITY DEVICE FOR PROTECTING AND SECURING PORTABLE ELECTRONIC PRODUCTS, NAMELY, ELECTRONIC MUSIC AND/OR VIDEO PLAYERS FROM THEFT (U.S. CLS. 21, 23, 26, 36 AND 38).

CHERYL CLAYTON, EXAMINING ATTORNEY

SN 78-823,036. SIBERIAN CONSULTING, LLC, PORTSMOUTH, NH. FILED 2-24-2006.

THE SECRET OF SECRETS

THE MARK CONSISTS OF STANDARD CHARACTERS WITHOUT CLAIM TO ANY PARTICULAR FONT, STYLE, SIZE, OR COLOR.

FOR CD-ROMS, DVDS AND COMPUTER SOFTWARE ALL FEATURING FICTIONAL CONTENT; ELECTRONIC PUBLICATIONS, NAMELY, BOOKS, MAGAZINES, NEWSLETTERS AND MAGAZINE COLUMNS RECORDED ON COMPUTER MEDIA ALL FEATURING FICTIONAL CONTENT, DOWNLOADABLE ELECTRONIC PUBLICATIONS, NAMELY, BOOKS, MAGAZINES, NEWSLETTERS AND MAGAZINE COLUMNS ALL FEATURING FICTIONAL CONTENT; PRE-RECORDED AUDIO CASSETTES AND COMPACT DISCS FEATURING FICTIONAL BOOKS; COMPUTER GAME SOFTWARE AND CARTRIDGES (U.S. CLS. 21, 23, 26, 36 AND 38).

MATTHEW PAPPAS, EXAMINING ATTORNEY

SN 78-830,840. BARTIZAN CONNECTS, LLC, YONKERS, NY. FILED 3-7-2006.

BadgeMax

THE MARK CONSISTS OF STANDARD CHARACTERS WITHOUT CLAIM TO ANY PARTICULAR FONT, STYLE, SIZE, OR COLOR.

FOR COMPUTER SOFTWARE FOR BADGE CREATION THAT ALLOWS DATA ENTRY AND BADGE PRINTING WITH OR WITHOUT ENCODED INFORMATION (U.S. CLS. 21, 23, 26, 36 AND 38).

FIRST USE 10-15-2005; IN COMMERCE 10-15-2005.
BARBARA BROWN, EXAMINING ATTORNEY

CLASS 9—(Continued).

SN 78-833,349. 2B WIRELESS, INC., NEW YORK, NY. FILED 3-9-2006.

mShopper

THE MARK CONSISTS OF STANDARD CHARACTERS WITHOUT CLAIM TO ANY PARTICULAR FONT, STYLE, SIZE, OR COLOR.

FOR COMPUTER APPLICATION SOFTWARE FOR MOBILE PHONES; COMPUTER E-COMMERCE SOFTWARE TO ALLOW USERS TO PERFORM ELECTRONIC BUSINESS TRANSACTIONS VIA A GLOBAL COMPUTER NETWORK (U.S. CLS. 21, 23, 26, 36 AND 38).
PRISCILLA MILTON, EXAMINING ATTORNEY

SN 78-835,051. ROBERTS, JOSEPH D., JR., LONGMONT, CO. AND ROBERTS, LISA M., LONGMONT, CO. FILED 3-11-2006.

PaperModus

THE MARK CONSISTS OF STANDARD CHARACTERS WITHOUT CLAIM TO ANY PARTICULAR FONT, STYLE, SIZE, OR COLOR.

FOR COMPUTER SOFTWARE FOR THE COLLECTION, EDITING, ORGANIZING, MODIFYING, BOOK MARKING, TRANSMISSION, STORAGE AND SHARING OF DATA AND INFORMATION (U.S. CLS. 21, 23, 26, 36 AND 38).
SHAUNIA WALLACE, EXAMINING ATTORNEY

SN 78-835,759. ACUNETX, INC., SUPERIOR, CO. FILED 3-13-2006.

VISIONETX

THE MARK CONSISTS OF STANDARD CHARACTERS WITHOUT CLAIM TO ANY PARTICULAR FONT, STYLE, SIZE, OR COLOR.

FOR COMPUTER SOFTWARE AND DEVICE HARDWARE THAT READ AND ANALYZE EYE AND PUPILARY MOVEMENTS FOR PURPOSES OF OCCUPATIONAL SAFETY, LAW ENFORCEMENT, AND NATIONAL SECURITY AND DEFENSE (U.S. CLS. 21, 23, 26, 36 AND 38).
JAMES MACFARLANE, EXAMINING ATTORNEY

CLASS 9—(Continued).

SN 78-836,169. VIVENDI UNIVERSAL, 75008 PARIS, FRANCE, FILED 3-13-2006.

VIVENDI VISUAL ENTERTAINMENT

THE MARK CONSISTS OF STANDARD CHARACTERS WITHOUT CLAIM TO ANY PARTICULAR FONT, STYLE, SIZE, OR COLOR.

OWNER OF U.S. REG. NOS. 2,315,457, 2,766,054 AND OTHERS.

NO CLAIM IS MADE TO THE EXCLUSIVE RIGHT TO USE "VISUAL ENTERTAINMENT", APART FROM THE MARK AS SHOWN.

FOR PRE-RECORDED AUDIO TAPES, DISCS AND CASSETTES, VIDEO TAPES, DISCS AND CASSETTES, DIGITAL AUDIO AND AUDIO VIDEO TAPES AND DISCS, CDS, DVDS, LASER DISCS, AND PHONOGRAPH RECORDS FEATURING MUSIC AND ENTERTAINMENT; THEATRICAL AND MUSICAL SOUND AND VIDEO RECORDINGS; VIRTUAL REALITY GAME SOFTWARE; DOWNLOADABLE RING TONES, MUSIC, MP3S, GRAPHICS, GAMES, IMAGES AND VIDEOS FOR WIRELESS COMMUNICATION DEVICES; COMPUTER AND VIDEO GAME EQUIPMENT CONTAINING MEMORY DEVICES, NAMELY, COMPUTER AND VIDEO GAME SOFTWARE, TAPES, CARTRIDGES, CASSETTES, JOYSTICKS AND REMOTE CONTROL UNITS; MOUSE PADS; PORTABLE AND HANDHELD DIGITAL ELECTRONIC DEVICES FOR RECORDING, ORGANIZING, TRANSMITTING, MANIPULATING, AND REVIEWING TEXT, DATA AND AUDIO FILES; AND DIGITAL ELECTRONIC DEVICES FOR RECORDING, ORGANIZING, TRANSMITTING, MANIPULATING, AND REVIEWING TEXT, DATA AND AUDIO FILES FOR VEHICLES (U.S. CLS. 21, 23, 26, 36 AND 38).
ALLISON SCHRODY, EXAMINING ATTORNEY

SN 78-836,277. R. BROOKS ASSOCIATES, INC., WILLIAMSON, NY. FILED 3-14-2006.

SOURCE WATCH

THE MARK CONSISTS OF STANDARD CHARACTERS WITHOUT CLAIM TO ANY PARTICULAR FONT, STYLE, SIZE, OR COLOR.

NO CLAIM IS MADE TO THE EXCLUSIVE RIGHT TO USE "WATCH", APART FROM THE MARK AS SHOWN.

FOR PORTABLE ALARM SYSTEM, COMPRISED OF SENSORS, CONTROL UNIT AND CELLULAR TRANSMITTER, FOR AUTOMATED DELIVERY OF ALARM NOTIFICATIONS USING WIRELESS TELECOMMUNICATIONS NETWORKS (U.S. CLS. 21, 23, 26, 36 AND 38).
MARIAM MAHMOUDI, EXAMINING ATTORNEY

CLASS 9—(Continued).

SN 78-836,375. VIRGINIA TECH INTELLECTUAL PROPERTIES, INC., BLACKSBURG, VA. FILED 3-14-2006.

PULSEVT

THE MARK CONSISTS OF STANDARD CHARACTERS WITHOUT CLAIM TO ANY PARTICULAR FONT, STYLE, SIZE, OR COLOR.

FOR MATERIAL HANDLING AND PACKAGING SOFTWARE FOR USE AS A COMPUTER AIDED DESIGN PROGRAM (CAD) (U.S. CLS. 21, 23, 26, 36 AND 38).
STEVEN JACKSON, EXAMINING ATTORNEY

SN 78-837,284. MANCINI, RAYMOND JOSEPH, BROOKLYN, NY. AND FENEQUITO, LINA JACQUELINE, NEW YORK, NY. FILED 3-14-2006.

Vitascope

THE MARK CONSISTS OF STANDARD CHARACTERS WITHOUT CLAIM TO ANY PARTICULAR FONT, STYLE, SIZE, OR COLOR.

FOR VIDEO OR FILM-BASED MEDIA, NAMELY PRE-RECORDED DVDS, THAT DESCRIBE AND DOCUMENT A PERSON'S LIFE FOR THE USE AND ENJOYMENT OF THE INDIVIDUAL'S FAMILY AND FRIENDS (U.S. CLS. 21, 23, 26, 36 AND 38).

BRENDAN REGAN, EXAMINING ATTORNEY

SN 78-837,868. WILLIAMS, RUPERT C., NEW YORK, NY. FILED 3-15-2006.

GIRL WATCHERS

THE MARK CONSISTS OF STANDARD CHARACTERS WITHOUT CLAIM TO ANY PARTICULAR FONT, STYLE, SIZE, OR COLOR.

NO CLAIM IS MADE TO THE EXCLUSIVE RIGHT TO USE "GIRL", APART FROM THE MARK AS SHOWN.

FOR ELECTRICAL APPARATUS NAMELY, PRE-RECORDED PHONOGRAPH RECORDS, COMPACT DISCS, VIDEO CASSETTES, AND DVDS, ALL FEATURING MUSIC AND CONTENT FOR MATURE AUDIENCES (U.S. CLS. 21, 23, 26, 36 AND 38).

KRISTIN DAHLING, EXAMINING ATTORNEY

CLASS 9—(Continued).

SN 78-840,140. XHEO INC, TEMECULA, CA. FILED 3-17-2006.

XHEO

THE MARK CONSISTS OF STANDARD CHARACTERS WITHOUT CLAIM TO ANY PARTICULAR FONT, STYLE, SIZE, OR COLOR.

FOR COMPUTER E-COMMERCE SOFTWARE TO ALLOW USERS TO PERFORM ELECTRONIC BUSINESS TRANSACTIONS VIA A GLOBAL COMPUTER NETWORK; COMPUTER SOFTWARE DEVELOPMENT TOOLS; COMPUTER SOFTWARE FOR ENCRYPTION; WEB SITE DEVELOPMENT SOFTWARE (U.S. CLS. 21, 23, 26, 36 AND 38).

FIRST USE 11-1-2002; IN COMMERCE 11-1-2002.
GINA FINK, EXAMINING ATTORNEY

SN 78-840,170. XHEO INC, TEMECULA, CA. FILED 3-17-2006.

CodeVeil

THE MARK CONSISTS OF STANDARD CHARACTERS WITHOUT CLAIM TO ANY PARTICULAR FONT, STYLE, SIZE, OR COLOR.

FOR COMPILER SOFTWARE; COMPUTER E-COMMERCE SOFTWARE TO ALLOW USERS TO PERFORM ELECTRONIC BUSINESS TRANSACTIONS VIA A GLOBAL COMPUTER NETWORK; COMPUTER SOFTWARE DEVELOPMENT TOOLS; COMPUTER SOFTWARE FOR ENCRYPTION; DATA COMPRESSION SOFTWARE; DECODER SOFTWARE (U.S. CLS. 21, 23, 26, 36 AND 38).

FIRST USE 7-20-2005; IN COMMERCE 7-20-2005.
GINA FINK, EXAMINING ATTORNEY

SN 78-840,704. ANWELL TECHNOLOGIES USA, SOUTH SAN FRANCISCO, CA. FILED 3-19-2006.

ANWELL

THE MARK CONSISTS OF STANDARD CHARACTERS WITHOUT CLAIM TO ANY PARTICULAR FONT, STYLE, SIZE, OR COLOR.

FOR EQUIPMENT COMPRISED OF REPLICATORS, OFF-LINE HARD COATERS, AND DYE COATERS FOR MAKING OPTICAL DISCS; AND, EQUIPMENT COMPRISED OF REPLICATORS, OFF-LINE HARD COATERS, AND DYE COATERS FOR MANUFACTURING OPTICAL MEDIUM (U.S. CLS. 21, 23, 26, 36 AND 38).

FIRST USE 11-2-2002; IN COMMERCE 11-2-2002.
WILLIAM P. SHANAHAN, EXAMINING ATTORNEY

CLASS 9—(Continued).

SN 78-840,810. ZAGNER PRODUCTS, WEBSTER, NY. FILED 3-19-2006.

WINDCHECKER

THE MARK CONSISTS OF STANDARD CHARACTERS WITHOUT CLAIM TO ANY PARTICULAR FONT, STYLE, SIZE, OR COLOR.

SEC. 2(F).

FOR AIR DIRECTION AND AIR QUALITY TESTERS, NAMELY, A POWDER THAT IS USED TO TEST THE AIR DIRECTION AND AIR QUALITY (U.S. CLS. 21, 23, 26, 36 AND 38).

FIRST USE 9-1-1988; IN COMMERCE 9-1-1988.
TANYA AMOS, EXAMINING ATTORNEY

CLASS 9—(Continued).

SN 78-842,673. PLANET BINGO, INC., RANCHO MIRAGE, CA. FILED 3-21-2006.

3RD ROCK BINGO

THE MARK CONSISTS OF STANDARD CHARACTERS WITHOUT CLAIM TO ANY PARTICULAR FONT, STYLE, SIZE, OR COLOR.

NO CLAIM IS MADE TO THE EXCLUSIVE RIGHT TO USE "BINGO", APART FROM THE MARK AS SHOWN.

FOR BINGO SLOT MACHINES AND ELECTRONIC GAME HARDWARE AND SOFTWARE, NAMELY, AN ELECTRONIC BINGO GAME (U.S. CLS. 21, 23, 26, 36 AND 38).

KATHERINE STOIDES, EXAMINING ATTORNEY

SN 78-841,784. CONTROL COMPONENTS, INC., RANCHO SANTA MARGARITA, CA. FILED 3-20-2006.

AB JAPAN VALVES

THE MARK CONSISTS OF STANDARD CHARACTERS WITHOUT CLAIM TO ANY PARTICULAR FONT, STYLE, SIZE, OR COLOR.

NO CLAIM IS MADE TO THE EXCLUSIVE RIGHT TO USE "VALVES", APART FROM THE MARK AS SHOWN.

FOR CONTROL VALVES FOR REGULATING THE FLOW OF GASES AND LIQUIDS (U.S. CLS. 21, 23, 26, 36 AND 38).

KIMBERLY PERRY, EXAMINING ATTORNEY

SN 78-842,719. PLANET BINGO, INC., RANCHO MIRAGE, CA. FILED 3-21-2006.

3RD ROCK GAMING

THE MARK CONSISTS OF STANDARD CHARACTERS WITHOUT CLAIM TO ANY PARTICULAR FONT, STYLE, SIZE, OR COLOR.

NO CLAIM IS MADE TO THE EXCLUSIVE RIGHT TO USE "GAMING", APART FROM THE MARK AS SHOWN.

FOR BINGO SLOT MACHINES AND ELECTRONIC GAME HARDWARE AND SOFTWARE, NAMELY, AN ELECTRONIC BINGO GAME (U.S. CLS. 21, 23, 26, 36 AND 38).

KATHERINE STOIDES, EXAMINING ATTORNEY

SN 78-841,787. CONTROL COMPONENTS, INC., RANCHO SANTA MARGARITA, CA. FILED 3-20-2006.

ABJ

THE MARK CONSISTS OF STANDARD CHARACTERS WITHOUT CLAIM TO ANY PARTICULAR FONT, STYLE, SIZE, OR COLOR.

FOR CONTROL VALVES FOR REGULATING THE FLOW OF GASES AND LIQUIDS (U.S. CLS. 21, 23, 26, 36 AND 38).

KIMBERLY PERRY, EXAMINING ATTORNEY

SN 78-843,440. MAUPIN, RODNEY, RAINIER, WA. FILED 3-22-2006.

Gridpoint Atlas

THE MARK CONSISTS OF STANDARD CHARACTERS WITHOUT CLAIM TO ANY PARTICULAR FONT, STYLE, SIZE, OR COLOR.

NO CLAIM IS MADE TO THE EXCLUSIVE RIGHT TO USE "ATLAS", APART FROM THE MARK AS SHOWN.

FOR COMPUTER GRAPHICS SOFTWARE (U.S. CLS. 21, 23, 26, 36 AND 38).

FIRST USE 2-17-2003; IN COMMERCE 2-17-2003.
BARBARA GAYNOR, EXAMINING ATTORNEY

CLASS 9—(Continued).

SN 78-843,810. JAMES D UNREIN, SEWARD, AK. FILED 3-22-2006.

CLASS 9—(Continued).

SN 78-845,279. EXCEPTIONAL INNOVATION LLC, WESTERVILLE, OH. FILED 3-24-2006.

Northern Journey Films

THE MARK CONSISTS OF STANDARD CHARACTERS WITHOUT CLAIM TO ANY PARTICULAR FONT, STYLE, SIZE, OR COLOR.

NO CLAIM IS MADE TO THE EXCLUSIVE RIGHT TO USE "FILMS", APART FROM THE MARK AS SHOWN.

FOR PRERECORDED DVD'S AND VIDEO CASSETTES FEATURING HUNTING AND FISHING (U.S. CLS. 21, 23, 26, 36 AND 38).

SANI KHOURI, EXAMINING ATTORNEY

life|wave

SN 78-844,037. CALDWELL, ROBERT H., GREAT MEADOWS, NJ. FILED 3-23-2006.

Starmine Records

THE MARK CONSISTS OF STANDARD CHARACTERS WITHOUT CLAIM TO ANY PARTICULAR FONT, STYLE, SIZE, OR COLOR.

NO CLAIM IS MADE TO THE EXCLUSIVE RIGHT TO USE "RECORDS", APART FROM THE MARK AS SHOWN.

FOR MUSIC RECORDS, CDS AND DVDS (U.S. CLS. 21, 23, 26, 36 AND 38).

AMY MCMENAMIN, EXAMINING ATTORNEY

FOR COMPUTER SERVER HARDWARE, FIRMWARE AND SOFTWARE FOR USE IN THE AMPLIFICATION AND DISTRIBUTION OF MULTIPLE STREAMS OF DIGITAL AUDIO THROUGH HOME AND BUSINESS WIRED AND WIRELESS NETWORKS TO REMOTELY LOCATED SPEAKERS; SAID HARDWARE, FIRMWARE, AND SOFTWARE CAPABLE OF SIMULTANEOUSLY AMPLIFYING AND DISTRIBUTING SAID MULTIPLE STREAMS; SAID HARDWARE, FIRMWARE, AND SOFTWARE FURTHER BEING CAPABLE OF DISTRIBUTING AUDIO FROM MULTIPLE AUDIO PLAYING SOURCES, NAMELY THE FOLLOWING— PCS, CD PLAYERS, MP3 PLAYERS, HIGH DEFINITION AUDIO PLAYERS, RECEIVERS, RADIO AND SATELLITE RADIO TUNERS; SAID DEVICE FURTHER CAPABLE OF BEING ACCESSED VIA CLIENT ACCESS POINTS, NAMELY THE FOLLOWING— PCS, REMOTE CONTROLS, TELEVISIONS, AUDIO-VIDEO CONTROLLERS, TOUCH PANELS, TOUCH SCREENS, WIRELESS DEVICES, AND MOBILE DEVICES (U.S. CLS. 21, 23, 26, 36 AND 38).

JENNIFER WILLISTON, EXAMINING ATTORNEY

CLASS 9—(Continued).

SN 78-845,286. EXCEPTIONAL INNOVATION LLC, WESTERVILLE, OH. FILED 3-24-2006.

CLASS 9—(Continued).

SN 78-845,294. EXCEPTIONAL INNOVATION LLC, WESTERVILLE, OH. FILED 3-24-2006.

life|aware

life|boat

FOR COMPUTER SOFTWARE AND FIRMWARE, NAMELY COMPUTER PROGRAMS TO FACILITATE THE INTEGRATION OF THIRD PARTY HARDWARE PRODUCTS INTO SOFTWARE-BASED NETWORKS TO LOCALLY AND REMOTELY MONITOR AND CONTROL, THROUGH HOME AND BUSINESS WIRED AND WIRELESS NETWORKS, ALL OF THE FOLLOWING SYSTEMS- CLIMATE AND ENVIRONMENT SYSTEMS, NAMELY HEATING, AIR-CONDITIONING, VENTILATION AND CIRCULATION SYSTEMS, SECURITY SYSTEMS, NAMELY, SYSTEMS FOR PERIMETER AND INTRUSION DETECTION, FIRE, SMOKE AND GAS DETECTION, AND AUDIO AND VIDEO SURVEILLANCE OF INTERIOR AND EXTERIOR OF PREMISES, LIGHTING SYSTEMS, NAMELY, INTERIOR AND EXTERIOR LIGHTS, WINDOW TREATMENTS, NAMELY, DRAPES, CURTAINS, BLINDS, MINI-BLINDS AND SHADES, AUDIO AND AUDIOVISUAL ENTERTAINMENT SYSTEMS, NAMELY, FUNCTIONS OF AUDIO AND AUDIOVISUAL EQUIPMENT SUCH AS CD, DVD AND VCR PLAYERS AND RECORDERS, RADIO, TV AND SATELLITE TUNERS, LASER DISC PLAYERS, MP3 PLAYERS, AND CRT, LCD, DIGITAL LIGHT PROCESSING, PLASMA AND VIDEO PROJECTOR DISPLAYS, AUDIO AND AUDIOVISUAL ENTERTAINMENT DISTRIBUTION SYSTEMS, NAMELY, DISTRIBUTION OF AUDIO AND AUDIOVISUAL ENTERTAINMENT MEDIA TO AUDIOVISUAL DEVICES, VIDEO DISPLAY COMPONENTS AND MOUNTINGS, NAMELY, MECHANIZED MOUNTINGS AND RECEPTACLES FOR VIDEO PROJECTORS, VIDEO PROJECTION SCREENS AND PANELS, AND POOL AND SPA CONTROLS FOR THE CONTROL AND MONITORING OF TEMPERATURE, CLEANING CYCLES AND DISPLAY OF ALARM EVENTS (U.S. CLS. 21, 23, 26, 36 AND 38).

JENNIFER WILLISTON, EXAMINING ATTORNEY

FOR COMPUTER HARDWARE, SOFTWARE, AND FIRMWARE IMPLEMENTED SPECIFICALLY FOR A MOBILE, MARINE-BASED, MARINE HARDENED ENVIRONMENT, OPERATED VIA PCS, REMOTE CONTROL, TOUCH PANELS, TOUCH SCREENS, MOBILE DEVICES AND WIRELESS DEVICES, TO CONTROL THE FOLLOWING ONBOARD SYSTEMS- CLIMATE AND ENVIRONMENT SYSTEMS, NAMELY, HEATING, AIR-CONDITIONING, VENTILATION AND CIRCULATION SYSTEMS, SECURITY SYSTEMS, NAMELY, SYSTEMS FOR PERIMETER AND INTRUSION DETECTION, FIRE, SMOKE AND GAS DETECTION, AND AUDIO AND VIDEO SURVEILLANCE OF INTERIOR AND EXTERIOR OF PREMISES, LIGHTING SYSTEMS, NAMELY, INTERIOR AND EXTERIOR LIGHTS, WINDOW TREATMENTS, NAMELY, DRAPES, CURTAINS, BLINDS, MINI-BLINDS AND SHADES, AUDIO AND AUDIOVISUAL ENTERTAINMENT SYSTEMS, NAMELY, FUNCTIONS OF AUDIO AND AUDIOVISUAL EQUIPMENT SUCH AS CD, DVD AND VCR PLAYERS AND RECORDERS, RADIO, TV AND SATELLITE TUNERS, LASER DISC PLAYERS, MP3 PLAYERS, AND CRT, LCD, DIGITAL LIGHT PROCESSING, PLASMA AND VIDEO PROJECTOR DISPLAYS, AUDIO AND AUDIOVISUAL ENTERTAINMENT DISTRIBUTION SYSTEMS, NAMELY, DISTRIBUTION OF AUDIO AND AUDIOVISUAL ENTERTAINMENT MEDIA TO AUDIOVISUAL DEVICES, VIDEO DISPLAY COMPONENTS AND MOUNTINGS, NAMELY, MECHANIZED MOUNTINGS AND RECEPTACLES FOR VIDEO PROJECTORS, VIDEO PROJECTION SCREENS AND PANELS, AND POOL AND SPA CONTROLS FOR THE CONTROL AND MONITORING OF TEMPERATURE, CLEANING CYCLES AND DISPLAY OF ALARM EVENTS (U.S. CLS. 21, 23, 26, 36 AND 38).

JENNIFER WILLISTON, EXAMINING ATTORNEY

CLASS 9—(Continued).

SN 78-845,302. EXCEPTIONAL INNOVATION LLC, WESTERVILLE, OH. FILED 3-24-2006.

life|butler

FOR COMPUTER SOFTWARE FOR USE IN HOME AND BUILDING MANAGEMENT FOR MANAGING SYSTEM EVENT COMMUNICATIONS AMONG SYSTEM CLIENTS, LOCALLY AND REMOTELY, THROUGH HOME AND BUSINESS WIRED AND WIRELESS NETWORKS, NAMELY THE FOLLOWING SYSTEM CLIENTS— PCS, REMOTE CONTROLS, TELEVISIONS, TOUCH PANELS, TOUCH SCREENS, WIRELESS DEVICES, MOBILE DEVICES, AND THE FOLLOWING CONTROL SYSTEMS— CLIMATE AND ENVIRONMENT SYSTEMS, NAMELY, HEATING, AIR-CONDITIONING, VENTILATION AND CIRCULATION SYSTEMS, SECURITY SYSTEMS, NAMELY, SYSTEMS FOR PERIMETER AND INTRUSION DETECTION, FIRE, SMOKE AND GAS DETECTION, AND AUDIO AND VIDEO SURVEILLANCE OF INTERIOR AND EXTERIOR OF PREMISES, LIGHTING SYSTEMS, NAMELY, INTERIOR AND EXTERIOR LIGHTS, WINDOW TREATMENTS, NAMELY, DRAPES, CURTAINS, BLINDS, MINI-BLINDS AND SHADES, AUDIO AND AUDIOVISUAL ENTERTAINMENT SYSTEMS, NAMELY, FUNCTIONS OF AUDIO AND AUDIOVISUAL EQUIPMENT SUCH AS CD, DVD AND VCR PLAYERS AND RECORDERS, RADIO, TV AND SATELLITE TUNERS, LASER DISC PLAYERS, MP3 PLAYERS, AND CRT, LCD, DIGITAL LIGHT PROCESSING, PLASMA AND VIDEO PROJECTOR DISPLAYS, AUDIO AND AUDIOVISUAL ENTERTAINMENT DISTRIBUTION SYSTEMS, NAMELY, DISTRIBUTION OF AUDIO AND AUDIOVISUAL ENTERTAINMENT MEDIA TO AUDIOVISUAL DEVICES, VIDEO DISPLAY COMPONENTS AND MOUNTINGS, NAMELY, MECHANIZED MOUNTINGS AND RECEPTACLES FOR VIDEO PROJECTORS, VIDEO PROJECTION SCREENS AND PANELS, AND POOL AND SPA CONTROLS FOR THE CONTROL AND MONITORING OF TEMPERATURE, CLEANING CYCLES AND DISPLAY OF ALARM EVENTS (U.S. CLS. 21, 23, 26, 36 AND 38).

JENNIFER WILLISTON, EXAMINING ATTORNEY

CLASS 9—(Continued).

SN 78-845,515. EXCEPTIONAL INNOVATION LLC, WESTERVILLE, OH. FILED 3-24-2006.

life|point

FOR COMPUTER HARDWARE, FIRMWARE AND SOFTWARE FOR USE IN AN ALL-DIGITAL AND HIGH-DEFINITION CAPABLE ENVIRONMENT, COMPRISING AN IN-WALL LCD TOUCH SCREEN, SELF-CONTAINED ON-BOARD COMPUTER WITH PROCESSOR, RAM, AND HARD DRIVE FOR DISPLAYING DIGITAL MEDIA AND ACCESSING, MONITORING, AND CONTROLLING, THROUGH HOME AND BUSINESS WIRED AND WIRELESS NETWORKS, ALL OF THE FOLLOWING SYSTEMS— CLIMATE AND ENVIRONMENT SYSTEMS, NAMELY HEATING, AIR-CONDITIONING, VENTILATION AND CIRCULATION; SECURITY SYSTEMS, NAMELY PERIMETER AND INTRUSION DETECTION, FIRE, SMOKE AND GAS DETECTION, AND AUDIO AND VIDEO SURVEILLANCE OF INTERIOR AND EXTERIOR OF PREMISES; LIGHTING SYSTEMS, NAMELY INTERIOR AND EXTERIOR LIGHTS; WINDOW TREATMENTS, NAMELY DRAPES, CURTAINS, BLINDS, MINI-BLINDS AND SHADES; AUDIO AND AUDIOVISUAL ENTERTAINMENT SYSTEMS, NAMELY FUNCTIONS OF AUDIO AND AUDIOVISUAL EQUIPMENT SUCH AS CD, DVD AND VCR PLAYERS AND RECORDERS, RADIO, TV AND SATELLITE TUNERS, LASER DISC PLAYERS, MP3 PLAYERS, AND CRT, LCD, DIGITAL LIGHT PROCESSING, PLASMA AND VIDEO PROJECTOR DISPLAYS; AUDIO AND AUDIOVISUAL ENTERTAINMENT DISTRIBUTION SYSTEMS, NAMELY DISTRIBUTION OF AUDIO AND AUDIOVISUAL ENTERTAINMENT MEDIA TO AUDIOVISUAL DEVICES; VIDEO DISPLAY COMPONENTS AND MOUNTINGS, NAMELY MECHANIZED MOUNTINGS AND RECEPTACLES FOR VIDEO PROJECTORS, VIDEO PROJECTION SCREENS AND PANELS; POOL AND SPA CONTROLS, NAMELY CONTROL AND MONITORING OF TEMPERATURE, CLEANING CYCLES AND DISPLAY OF ALARM EVENTS (U.S. CLS. 21, 23, 26, 36 AND 38).

JENNIFER WILLISTON, EXAMINING ATTORNEY

CLASS 9—(Continued).

SN 78-845,695. AWS CONVERGENCE TECHNOLOGIES, INC., GERMANTOWN, MD. FILED 3-24-2006.

BLUEBUGBOX

THE MARK CONSISTS OF STANDARD CHARACTERS WITHOUT CLAIM TO ANY PARTICULAR FONT, STYLE, SIZE, OR COLOR.

FOR ELECTRONIC MASTER CONTROL UNIT, ELECTRONIC DATA LOGGER, ELECTRONIC SIGNAL RECEIVER, ELECTRONIC SIGNAL TRANSMITTER, COMPUTER SOFTWARE, COMPUTER HARDWARE AND PERIPHERALS, ALL FOR TRANSMISSION OF WEATHER DATA OVER THE INTERNET (U.S. CLS. 21, 23, 26, 36 AND 38).

FIRST USE 1-0-2005; IN COMMERCE 1-0-2005.
MELISSA VALLILLO, EXAMINING ATTORNEY

SN 78-845,720. AWS CONVERGENCE TECHNOLOGIES, INC., GERMANTOWN, MD. FILED 3-24-2006.

GREENBUGBOX

THE MARK CONSISTS OF STANDARD CHARACTERS WITHOUT CLAIM TO ANY PARTICULAR FONT, STYLE, SIZE, OR COLOR.

FOR ELECTRONIC SIGNAL RECEIVER, ELECTRONIC SIGNAL TRANSMITTER, COMPUTER SOFTWARE, COMPUTER HARDWARE AND PERIPHERALS, ALL FOR TRANSMISSION OF WEATHER DATA OVER THE INTERNET (U.S. CLS. 21, 23, 26, 36 AND 38).

FIRST USE 12-0-2004; IN COMMERCE 12-0-2004.
MELISSA VALLILLO, EXAMINING ATTORNEY

SN 78-845,867. PACKET DESIGN, INC., PALO ALTO, CA. FILED 3-24-2006.

ROUTE EXPLORER

THE MARK CONSISTS OF STANDARD CHARACTERS WITHOUT CLAIM TO ANY PARTICULAR FONT, STYLE, SIZE, OR COLOR.

NO CLAIM IS MADE TO THE EXCLUSIVE RIGHT TO USE ROUTE, APART FROM THE MARK AS SHOWN.

FOR COMPUTER HARDWARE; COMPUTER SOFTWARE THAT PROVIDES REAL-TIME, INTEGRATED BUSINESS MANAGEMENT INTELLIGENCE BY MONITORING, DIAGNOSING, ANALYZING, AND VISUALIZING, NAMELY, DATA, TOPOLOGY MAPS AND SUMMARY GRAPHS, AND GENERATING REPORTS OF NETWORK ACTIVITY AND OPERATIONS FOR USER INTERFACE (U.S. CLS. 21, 23, 26, 36 AND 38).

FIRST USE 1-23-2003; IN COMMERCE 1-0-2003.
FRED CARL, EXAMINING ATTORNEY

CLASS 9—(Continued).

SN 78-847,745. DAYSTAR TECHNOLOGIES, HALFMOON, NY. FILED 3-28-2006.

ENABLING AFFORDABLE ELECTRICITY FROM THE SUN

THE MARK CONSISTS OF STANDARD CHARACTERS WITHOUT CLAIM TO ANY PARTICULAR FONT, STYLE, SIZE, OR COLOR.

FOR SOLAR CELLS AND PHOTOVOLTAIC SOLAR MODULES (U.S. CLS. 21, 23, 26, 36 AND 38).

SETH A. RAPPAPORT, EXAMINING ATTORNEY

SN 78-847,803. VIVA VISION, INC., SAN DIEGO, CA. FILED 3-28-2006.

MINISTRY PHONE

THE MARK CONSISTS OF STANDARD CHARACTERS WITHOUT CLAIM TO ANY PARTICULAR FONT, STYLE, SIZE, OR COLOR.

NO CLAIM IS MADE TO THE EXCLUSIVE RIGHT TO USE "PHONE", APART FROM THE MARK AS SHOWN.

FOR COMPUTER SOFTWARE FOR USE IN DELIVERING LIVE STREAMING VIDEO OVER A COMPUTER NETWORK SERVER FOR A GLOBAL INFORMATION NETWORK, OR THROUGH OTHER VIDEO TRANSMISSION VEHICLES, NAMELY WIRELESS DEVICES (U.S. CLS. 21, 23, 26, 36 AND 38).

JOHN LINCOSKI, EXAMINING ATTORNEY

SN 78-848,689. RAZORGATOR INTERACTIVE GROUP, INC., BEVERLY HILLS, CA. FILED 3-29-2006.

MASTERBROKER

THE MARK CONSISTS OF STANDARD CHARACTERS WITHOUT CLAIM TO ANY PARTICULAR FONT, STYLE, SIZE, OR COLOR.

FOR COMPUTER SOFTWARE FOR USE BY PROFESSIONAL TICKET BROKERS FOR INVENTORY MANAGEMENT, TICKET TRADING AND ACCOUNTING (U.S. CLS. 21, 23, 26, 36 AND 38).

FIRST USE 12-31-1992; IN COMMERCE 12-31-1992.
PAMELA HIRSCHMAN, EXAMINING ATTORNEY

CLASS 9—(Continued).

SN 78-850,208. PACKET DESIGN, INC., PALO ALTO, CA. FILED 3-30-2006.

TRAFFIC EXPLORER

THE MARK CONSISTS OF STANDARD CHARACTERS WITHOUT CLAIM TO ANY PARTICULAR FONT, STYLE, SIZE, OR COLOR.

NO CLAIM IS MADE TO THE EXCLUSIVE RIGHT TO USE TRAFFIC, APART FROM THE MARK AS SHOWN.

FOR COMPUTER HARDWARE; COMPUTER SOFTWARE THAT PROVIDES REAL-TIME, INTEGRATED BUSINESS MANAGEMENT INTELLIGENCE BY MONITORING, DIAGNOSING, ANALYZING, AND VISUALIZING, NAMELY, DATA, TOPOLOGY MAPS AND SUMMARY GRAPHS, AND GENERATING REPORTS OF NETWORK ACTIVITY AND OPERATIONS FOR USER INTERFACE (U.S. CLS. 21, 23, 26, 36 AND 38).

FIRST USE 3-27-2006; IN COMMERCE 3-27-2006.
FRED CARL, EXAMINING ATTORNEY

SN 78-850,497. ANSOFT CORPORATION, PITTSBURGH, PA. FILED 3-30-2006.

SIMPLORER

THE MARK CONSISTS OF STANDARD CHARACTERS WITHOUT CLAIM TO ANY PARTICULAR FONT, STYLE, SIZE, OR COLOR.

FOR COMPUTER SOFTWARE FOR SIMULATION OF COMPLEX TECHNICAL SYSTEMS WITH ELECTRICAL AND NON-ELECTRICAL PARTS AND ANALYSIS OF THE SIMULATED RESULTS (U.S. CLS. 21, 23, 26, 36 AND 38).

LA TONIA FISHER, EXAMINING ATTORNEY

SN 78-850,631. FASTSCALE TECHNOLOGY, INC., SAN JOSE, CA. FILED 3-30-2006.

FastScale

THE MARK CONSISTS OF STANDARD CHARACTERS WITHOUT CLAIM TO ANY PARTICULAR FONT, STYLE, SIZE, OR COLOR.

FOR COMPUTER SOFTWARE FOR USE IN COMPUTER SYSTEMS MANAGEMENT, SOFTWARE PROVISIONING, VIRTUALIZATION, SECURITY, USAGE TRACKING, COMPLIANCE MANAGEMENT AND AUDITING, SOFTWARE DISTRIBUTION, DIAGNOSTICS, SOFTWARE CUSTOMIZATION, LICENSING, AND STORAGE (U.S. CLS. 21, 23, 26, 36 AND 38).

JAY BESCH, EXAMINING ATTORNEY

CLASS 9—(Continued).

SN 78-850,848. NATIONAL AUTOMOTIVE PARTS ASSOCIATION, ATLANTA, GA. FILED 3-31-2006.



FOR SENSORS FOR THE DETERMINATION OF MASS AIR FLOW FOR USE ON VEHICLES (U.S. CLS. 21, 23, 26, 36 AND 38).

FIRST USE 10-0-2005; IN COMMERCE 10-0-2005.
BARBARA A. LOUGHRAN, EXAMINING ATTORNEY

SN 78-850,850. NATIONAL AUTOMOTIVE PARTS ASSOCIATION, ATLANTA, GA. FILED 3-31-2006.

MAXDRIVE

THE MARK CONSISTS OF STANDARD CHARACTERS WITHOUT CLAIM TO ANY PARTICULAR FONT, STYLE, SIZE, OR COLOR.

FOR SENSORS FOR THE DETERMINATION OF MASS AIR FLOW FOR USE ON VEHICLES (U.S. CLS. 21, 23, 26, 36 AND 38).

FIRST USE 10-0-2005; IN COMMERCE 10-0-2005.
BARBARA A. LOUGHRAN, EXAMINING ATTORNEY

SN 78-851,299. ABLESYS CORPORATION, HAYWARD, CA. FILED 3-31-2006.

ASCTREND

THE MARK CONSISTS OF STANDARD CHARACTERS WITHOUT CLAIM TO ANY PARTICULAR FONT, STYLE, SIZE, OR COLOR.

FOR DOWNLOADABLE SOFTWARE FOR TRADING STOCKS, FUTURES AND FOREIGN CURRENCY (U.S. CLS. 21, 23, 26, 36 AND 38).

FIRST USE 1-1-1995; IN COMMERCE 1-1-1995.
ALLISON SCHRODY, EXAMINING ATTORNEY

CLASS 9—(Continued).

SN 78-852,519. SILVER CREEK ENTERTAINMENT CORPORATION, GRANTS PASS, OR. FILED 4-3-2006.

Silver Creek Entertainment

THE MARK CONSISTS OF STANDARD CHARACTERS WITHOUT CLAIM TO ANY PARTICULAR FONT, STYLE, SIZE, OR COLOR.

OWNER OF U.S. REG. NOS. 2,370,859, 3,056,063 AND OTHERS.

NO CLAIM IS MADE TO THE EXCLUSIVE RIGHT TO USE "ENTERTAINMENT", APART FROM THE MARK AS SHOWN.

FOR ELECTRONIC GAME PROGRAMS; GAME SOFTWARE; INTERACTIVE MULTIMEDIA COMPUTER PROGRAM FOR GAMES; INTERACTIVE VIDEO GAME PROGRAMS (U.S. CLS. 21, 23, 26, 36 AND 38).

FIRST USE 8-8-1994; IN COMMERCE 7-20-1995.
MICHELE SWAIN, EXAMINING ATTORNEY

SN 78-852,672. PITTS, JOHN, URBANNA, VA. FILED 4-3-2006.

PEEPER PIN

THE MARK CONSISTS OF STANDARD CHARACTERS WITHOUT CLAIM TO ANY PARTICULAR FONT, STYLE, SIZE, OR COLOR.

NO CLAIM IS MADE TO THE EXCLUSIVE RIGHT TO USE "PIN", APART FROM THE MARK AS SHOWN.

FOR EYEWEAR ACCESSORIES, NAMELY, HOOPS AND PINS WHICH RESTRAIN EYEWEAR FROM BEING DROPPED OR MISPLACED (U.S. CLS. 21, 23, 26, 36 AND 38).

KATHERINE STOIDES, EXAMINING ATTORNEY

SN 78-852,699. INTELLIGENT BANKING SOLUTIONS, INC. (IBS), NEW LONDON, NH. FILED 4-3-2006.

Collection and Asset Recovery Manager

THE MARK CONSISTS OF STANDARD CHARACTERS WITHOUT CLAIM TO ANY PARTICULAR FONT, STYLE, SIZE, OR COLOR.

OWNER OF U.S. REG. NO. 2,310,061.

NO CLAIM IS MADE TO THE EXCLUSIVE RIGHT TO USE "MANAGER", APART FROM THE MARK AS SHOWN. SEC. 2(F).

FOR SOFTWARE FOR USE BY BANKS AND OTHER COMMERCIAL LENDERS FOR TRACKING AND COLLECTING LOANS AND MANAGING DELIQUENT REAL ESTATE MORTGAGE LOANS (U.S. CLS. 21, 23, 26, 36 AND 38).

FIRST USE 2-20-1998; IN COMMERCE 2-20-1998.
AMY GEARIN, EXAMINING ATTORNEY

CLASS 9—(Continued).

SN 78-852,977. STORCH, DONALD NICK, BROOKLYN, NY. FILED 4-3-2006.

New Weathermen Records

THE MARK CONSISTS OF STANDARD CHARACTERS WITHOUT CLAIM TO ANY PARTICULAR FONT, STYLE, SIZE, OR COLOR.

NO CLAIM IS MADE TO THE EXCLUSIVE RIGHT TO USE "RECORDS", APART FROM THE MARK AS SHOWN.

FOR MUSICAL SOUND RECORDINGS; MUSICAL VIDEO RECORDINGS (U.S. CLS. 21, 23, 26, 36 AND 38).

CHARLOTTE CORWIN, EXAMINING ATTORNEY

SN 78-853,232. TAKE-TWO INTERACTIVE SOFTWARE, INC., NEW YORK, NY. FILED 4-4-2006.

CIV IV

THE MARK CONSISTS OF STANDARD CHARACTERS WITHOUT CLAIM TO ANY PARTICULAR FONT, STYLE, SIZE, OR COLOR.

FOR COMPUTER GAME PROGRAMS, COMPUTER GAME SOFTWARE, COMPUTER GAME CARTRIDGES AND INSTRUCTION MANUALS SOLD AS A UNIT CONNECTED THEREWITH (U.S. CLS. 21, 23, 26, 36 AND 38).

NAKIA HENRY, EXAMINING ATTORNEY

SN 78-853,329. RFCYBER CORP., FREMONT, CA. FILED 4-4-2006.

LoginEZ

THE MARK CONSISTS OF STANDARD CHARACTERS WITHOUT CLAIM TO ANY PARTICULAR FONT, STYLE, SIZE, OR COLOR.

FOR COMPUTER SOFTWARE, NAMELY, COMPUTER PROGRAMS WHICH ALLOW USERS TO LOGIN TO COMPUTERS, UNLOCK COMPUTERS, AND UNLOCK SCREEN SAVERS AUTOMATICALLY, AND INSTRUCTION MANUALS SOLD THEREWITH AS UNIT (U.S. CLS. 21, 23, 26, 36 AND 38).

FIRST USE 12-15-2005; IN COMMERCE 3-1-2006.
STEVEN PEREZ, EXAMINING ATTORNEY

CLASS 9—(Continued).

SN 78-853,408. EARTHWORKS, INC., MILFORD, NH. FILED 4-4-2006.

KICKPAD

THE MARK CONSISTS OF STANDARD CHARACTERS WITHOUT CLAIM TO ANY PARTICULAR FONT, STYLE, SIZE, OR COLOR.

FOR EQUALIZERS AND SOUND EFFECTS PROCESSORS USED WITH AUDIO EQUIPMENT (U.S. CLS. 21, 23, 26, 36 AND 38).

FIRST USE 11-0-2004; IN COMMERCE 11-0-2004.
PAMELA HIRSCHMAN, EXAMINING ATTORNEY

CLASS 9—(Continued).

SN 78-854,449. MAG-TEK, INC., CARSON, CA. FILED 4-5-2006.

EXCELLA

THE MARK CONSISTS OF STANDARD CHARACTERS WITHOUT CLAIM TO ANY PARTICULAR FONT, STYLE, SIZE, OR COLOR.

FOR ELECTRONIC CHECK READERS (U.S. CLS. 21, 23, 26, 36 AND 38).

FIRST USE 6-1-2004; IN COMMERCE 6-1-2004.
JEFFERY COWARD, EXAMINING ATTORNEY

SN 78-853,448. ISYMPHONY HOLDINGS ENTERPRISES, VAN NUYS, CA. FILED 4-4-2006.

ISYMPHONY

THE MARK CONSISTS OF STANDARD CHARACTERS WITHOUT CLAIM TO ANY PARTICULAR FONT, STYLE, SIZE, OR COLOR.

FOR CONSUMER ELECTRONICS, NAMELY, DIGITAL AUDIO PLAYERS, AUDIO SPEAKERS, AUDIO AMPLIFIERS, PERSONAL STEREOS, COMPACT DISC AND MP3 PLAYERS, STEREO RECEIVERS AND TUNERS, PROTECTIVE CARRYING CASES FOR THE FOREGOING; HEADPHONES AND NOISE CANCELING HEADPHONES (U.S. CLS. 21, 23, 26, 36 AND 38).

FIRST USE 7-19-2006; IN COMMERCE 8-11-2006.
IRA J. GOODSAD, EXAMINING ATTORNEY

SN 78-854,721. MCDOWELL SIGNAL PROCESSING, LLC, MOUNTAIN VIEW, CA. FILED 4-5-2006.

MC2000

THE MARK CONSISTS OF STANDARD CHARACTERS WITHOUT CLAIM TO ANY PARTICULAR FONT, STYLE, SIZE, OR COLOR.

FOR COMPUTER SOFTWARE FOR MANIPULATING DIGITAL AUDIO INFORMATION FOR USE IN AUDIO MEDIA APPLICATIONS (U.S. CLS. 21, 23, 26, 36 AND 38).

FIRST USE 7-1-2000; IN COMMERCE 8-1-2000.
VERNA BETH RIRIE, EXAMINING ATTORNEY

SN 78-853,949. MEDIALINE, INC., LOS ANGELES, CA. FILED 4-4-2006.



FOR TV SETS, DIGITAL TV SETS, AUDIO RECEIVERS, VIDEO RECEIVERS, DVD PLAYER, PORTABLE MULTI MEDIAPLAYER, PORTABLE AUDIO PLAYER, HEADPHONE, AND DIGITAL VIDEO RECORDER (U.S. CLS. 21, 23, 26, 36 AND 38).

FIRST USE 10-1-2004; IN COMMERCE 10-1-2004.
TRACY CROSS, EXAMINING ATTORNEY

SN 78-854,859. MCDOWELL SIGNAL PROCESSING, LLC, MOUNTAIN VIEW, CA. FILED 4-5-2006.

Chrome Tone

THE MARK CONSISTS OF STANDARD CHARACTERS WITHOUT CLAIM TO ANY PARTICULAR FONT, STYLE, SIZE, OR COLOR.

FOR COMPUTER SOFTWARE FOR MANIPULATING DIGITAL AUDIO INFORMATION FOR USE IN AUDIO MEDIA APPLICATIONS (U.S. CLS. 21, 23, 26, 36 AND 38).

FIRST USE 9-1-2003; IN COMMERCE 11-1-2003.
VERNA BETH RIRIE, EXAMINING ATTORNEY

CLASS 9—(Continued).

SN 78-854,989. MCDOWELL SIGNAL PROCESSING, LLC, MOUNTAIN VIEW, CA. FILED 4-5-2006.

CLASS 9—(Continued).

SN 78-856,380. SURREAL SOFTWARE INC., SEATTLE, WA. FILED 4-7-2006.

McDSP

ONLY IN MIAMI

THE MARK CONSISTS OF STANDARD CHARACTERS WITHOUT CLAIM TO ANY PARTICULAR FONT, STYLE, SIZE, OR COLOR.

FOR COMPUTER SOFTWARE FOR MANIPULATING DIGITAL AUDIO INFORMATION FOR USE IN AUDIO MEDIA APPLICATIONS (U.S. CLS. 21, 23, 26, 36 AND 38).

FIRST USE 9-1-1998; IN COMMERCE 1-1-1999.
VERNA BETH RIRIE, EXAMINING ATTORNEY

THE MARK CONSISTS OF STANDARD CHARACTERS WITHOUT CLAIM TO ANY PARTICULAR FONT, STYLE, SIZE, OR COLOR.

FOR COMPUTER AND VIDEO GAME PROGRAMS RECORDED ON CARTRIDGES, DISCS, CD-ROMS, CASSETTES, TAPES AND MINI DISCS; VIDEO AND COMPUTER GAME SOFTWARE (U.S. CLS. 21, 23, 26, 36 AND 38).

AMY MCMENAMIN, EXAMINING ATTORNEY

SN 78-855,361. VIEWTECH INCORPORATED, OCEANSIDE, CA. FILED 4-6-2006.

SN 78-856,384. SURREAL SOFTWARE INC., SEATTLE, WA. FILED 4-7-2006.

VIEWSAT

ONLY IN ATLANTIC CITY

THE MARK CONSISTS OF STANDARD CHARACTERS WITHOUT CLAIM TO ANY PARTICULAR FONT, STYLE, SIZE, OR COLOR.

FOR SATELLITE RECEIVERS (U.S. CLS. 21, 23, 26, 36 AND 38).

FIRST USE 5-1-2005; IN COMMERCE 5-15-2005.
ESTHER A. BORSUK, EXAMINING ATTORNEY

THE MARK CONSISTS OF STANDARD CHARACTERS WITHOUT CLAIM TO ANY PARTICULAR FONT, STYLE, SIZE, OR COLOR.

FOR COMPUTER AND VIDEO GAME PROGRAMS RECORDED ON CARTRIDGES, DISCS, CD-ROMS, CASSETTES, TAPES AND MINI DISCS; VIDEO AND COMPUTER GAME SOFTWARE (U.S. CLS. 21, 23, 26, 36 AND 38).

AMY MCMENAMIN, EXAMINING ATTORNEY

SN 78-856,376. SURREAL SOFTWARE INC., SEATTLE, WA. FILED 4-7-2006.

SN 78-856,476. BRILLS, JEFFREY, BLAINE, MN. FILED 4-7-2006.

ONLY IN VEGAS

Dr. Carpet

THE MARK CONSISTS OF STANDARD CHARACTERS WITHOUT CLAIM TO ANY PARTICULAR FONT, STYLE, SIZE, OR COLOR.

FOR COMPUTER AND VIDEO GAME PROGRAMS RECORDED ON CARTRIDGES, DISCS, CD-ROMS, CASSETTES, TAPES AND MINI DISCS; VIDEO AND COMPUTER GAME SOFTWARE (U.S. CLS. 21, 23, 26, 36 AND 38).

AMY MCMENAMIN, EXAMINING ATTORNEY

THE MARK CONSISTS OF STANDARD CHARACTERS WITHOUT CLAIM TO ANY PARTICULAR FONT, STYLE, SIZE, OR COLOR.

FOR PRE-RECORDED VIDEO CASSETTES FEATURING INSTRUCTION ABOUT CARPET CLEANING (U.S. CLS. 21, 23, 26, 36 AND 38).

MARK T. MULLEN, EXAMINING ATTORNEY

CLASS 9—(Continued).

SN 78-856,609. WESTFALIA TECHNOLOGIES, INC., YORK, PA. FILED 4-7-2006.

SAVANNA.NET

THE MARK CONSISTS OF STANDARD CHARACTERS WITHOUT CLAIM TO ANY PARTICULAR FONT, STYLE, SIZE, OR COLOR.

FOR COMPUTER PROGRAMS FOR CONTROLLING DISTRIBUTION WAREHOUSE OPERATIONS (U.S. CLS. 21, 23, 26, 36 AND 38).

FIRST USE 2-3-2006; IN COMMERCE 2-3-2006.
ANDREA EVANS, EXAMINING ATTORNEY

SN 78-856,648. O2 HOLDINGS, LLC, NEW YORK, NY. FILED 4-7-2006.

MO'NIQUE'S FAT CHANCE

THE MARK CONSISTS OF STANDARD CHARACTERS WITHOUT CLAIM TO ANY PARTICULAR FONT, STYLE, SIZE, OR COLOR.

FOR PRE-RECORDED AUDIO TAPES, AUDIO CASSETTES, VIDEO TAPES, VIDEO CASSETTES AND VIDEO DISCS FEATURING BEAUTY CONTESTS FOR PLUS SIZED WOMEN (U.S. CLS. 21, 23, 26, 36 AND 38).
AMY MCMENAMIN, EXAMINING ATTORNEY

SN 78-856,658. THE HEALTHCARE CHAPLAINCY, NEW YORK, NY. FILED 4-7-2006.

ChaplaincyCounts

THE MARK CONSISTS OF STANDARD CHARACTERS WITHOUT CLAIM TO ANY PARTICULAR FONT, STYLE, SIZE, OR COLOR.

FOR COMPUTER SOFTWARE FOR USE IN RECORDING DATA FROM CHAPLAIN VISITS WITH PATIENTS (U.S. CLS. 21, 23, 26, 36 AND 38).

PAM WILLIS, EXAMINING ATTORNEY

CLASS 9—(Continued).

SN 78-856,732. DETCON INC., THE WOODLANDS, TX. FILED 4-7-2006.



FOR ELECTRONIC DETECTION SENSORS FOR DETECTING THE PRESENCE OF HAZARDOUS GASSES IN THE ATMOSPHERE; ELECTRONIC DETECTION SYSTEMS, COMPRISED OF MICROPROCESSOR-BASED ALARM CONTROLLERS AND ASSOCIATED GAS SENSORS, FOR MONITORING THE PRESENCE OF HAZARDOUS GASSES IN THE ATMOSPHERE; PROCESS ANALYZERS FOR THE DETECTION OF CORROSIVE GASES IN GAS SAMPLES (U.S. CLS. 21, 23, 26, 36 AND 38).

FIRST USE 12-20-1986; IN COMMERCE 8-16-1987.
SETH A. RAPPAPORT, EXAMINING ATTORNEY

SN 78-856,802. ADVANCED MOBILE TECHNOLOGIES, LLC, MORGANVILLE, NJ. FILED 4-7-2006.

RIDEGEAR

THE MARK CONSISTS OF STANDARD CHARACTERS WITHOUT CLAIM TO ANY PARTICULAR FONT, STYLE, SIZE, OR COLOR.

FOR ON-BOARD COMPUTERS FOR VEHICLES (U.S. CLS. 21, 23, 26, 36 AND 38).

ELIZABETH J. WINTER, EXAMINING ATTORNEY

SN 78-856,856. MATRIX TECHNOLOGIES CORPORATION, HUDSON, NH. FILED 4-7-2006.

E-DROP

THE MARK CONSISTS OF STANDARD CHARACTERS WITHOUT CLAIM TO ANY PARTICULAR FONT, STYLE, SIZE, OR COLOR.

FOR LIQUID DISPENSERS FOR SCIENTIFIC APPLICATIONS (U.S. CLS. 21, 23, 26, 36 AND 38).

FIRST USE 6-21-2005; IN COMMERCE 6-21-2005.
SANI KHOURI, EXAMINING ATTORNEY

CLASS 9—(Continued).

SN 78-856,946. AUTOMATED FINANCIAL SYSTEMS, INC.,
EXTON, PA. FILED 4-7-2006.

AFSVision

THE MARK CONSISTS OF STANDARD CHARACTERS WITHOUT CLAIM TO ANY PARTICULAR FONT, STYLE, SIZE, OR COLOR.

FOR COMPUTER SOFTWARE FOR PROCESSING AND REPORTING LOAN INFORMATION; COMPUTER SOFTWARE AND INSTRUCTION MANUALS SOLD AS A UNIT FOR PROCESSING AND REPORTING LOAN INFORMATION; COMPUTER SOFTWARE FOR PROCESSING AND REPORTING LOAN INFORMATION IN MULTIPLE CURRENCIES AND LANGUAGES; COMPUTER SOFTWARE AND INSTRUCTION MANUALS SOLD AS A UNIT FOR PROCESSING AND REPORTING LOAN INFORMATION IN MULTIPLE CURRENCIES AND LANGUAGES (U.S. CLS. 21, 23, 26, 36 AND 38).

DOMINICK J. SALEMI, EXAMINING ATTORNEY

SN 78-856,960. QUALITY CARE SOLUTIONS, INC., PHOENIX, AZ. FILED 4-7-2006.

MYHEALTH

THE MARK CONSISTS OF STANDARD CHARACTERS WITHOUT CLAIM TO ANY PARTICULAR FONT, STYLE, SIZE, OR COLOR.

FOR COMPUTER SOFTWARE DESIGNED TO ASSIST HEALTH INSURERS AND BENEFIT ADMINISTRATORS TO ENABLE THEIR CUSTOMERS TO GAIN ACCESS TO PERSONALIZED HEALTHCARE INFORMATION (U.S. CLS. 21, 23, 26, 36 AND 38).

DOMINICK J. SALEMI, EXAMINING ATTORNEY

SN 78-857,011. PLANET BINGO, INC., RANCHO MIRAGE, CA. FILED 4-7-2006.



NO CLAIM IS MADE TO THE EXCLUSIVE RIGHT TO USE "GAMING", APART FROM THE MARK AS SHOWN.

THE MARK CONSISTS OF A PLANET AROUND THE 3 AND THE WORDS SHOW THAT THEY WERE IN ESSENCE PUT TOGETHER LIKE ROCKS PUT TOGETHER.

FOR BINGO SLOT MACHINES AND ELECTRONIC GAME HARDWARE AND SOFTWARE, NAMELY, AN ELECTRONIC BINGO GAME (U.S. CLS. 21, 23, 26, 36 AND 38).

KATHERINE STOIDES, EXAMINING ATTORNEY

CLASS 9—(Continued).

SN 78-857,299. TOBIAS, ANDREW J., PACIFIC PALISADES, CA. FILED 4-9-2006.

TOBI HOUSEWARES

THE MARK CONSISTS OF STANDARD CHARACTERS WITHOUT CLAIM TO ANY PARTICULAR FONT, STYLE, SIZE, OR COLOR.

NO CLAIM IS MADE TO THE EXCLUSIVE RIGHT TO USE "HOUSE WARES", APART FROM THE MARK AS SHOWN.

FOR HOUSEWARES APPLIANCES, NAMELY, GARMENT STEAMER (U.S. CLS. 21, 23, 26, 36 AND 38).

DAYNA BROWNE, EXAMINING ATTORNEY

SN 78-857,361. COMPUTER SOLUTIONS & SOFTWARE INTERNATIONAL, INC., COCONUT CREEK, FL. FILED 4-9-2006.

VUE

THE MARK CONSISTS OF STANDARD CHARACTERS WITHOUT CLAIM TO ANY PARTICULAR FONT, STYLE, SIZE, OR COLOR.

FOR COMPUTER SOFTWARE, NAMELY, SOFTWARE FOR INSURANCE COMMISSIONS MANAGEMENT, INSURANCE INCENTIVE COMPENSATION MANAGEMENT, INSURANCE POLICY MANAGEMENT, INSURANCE PAYMENT PROCESSING, INSURANCE AGENT LEAD MANAGEMENT, AND RELATED COMMISSION, INCENTIVE, AND POLICY REPORTING (U.S. CLS. 21, 23, 26, 36 AND 38).

FIRST USE 6-30-2003; IN COMMERCE 6-30-2003.

SALLY SHIH, EXAMINING ATTORNEY

SN 78-857,457. ITT CORPORATION, WHITE PLAINS, NY. FILED 4-10-2006.

CIRCUIT SETTER

THE MARK CONSISTS OF STANDARD CHARACTERS WITHOUT CLAIM TO ANY PARTICULAR FONT, STYLE, SIZE, OR COLOR.

OWNER OF U.S. REG. NO. 1,521,618.

SEC. 2(F).

FOR BALANCE VALVES (U.S. CLS. 21, 23, 26, 36 AND 38).

FIRST USE 6-6-1969; IN COMMERCE 6-6-1969.

ODESSA BIBBINS, EXAMINING ATTORNEY

CLASS 9—(Continued).

SN 78-857,517. IGT, RENO, NV. FILED 4-10-2006.

CACTUS FLOWER

THE MARK CONSISTS OF STANDARD CHARACTERS WITHOUT CLAIM TO ANY PARTICULAR FONT, STYLE, SIZE, OR COLOR.

FOR GAMING MACHINES, NAMELY, DEVICES WHICH ACCEPT A WAGER AND COMPONENTS THEREFOR, NAMELY, CONTROLLERS, DISPLAYS, BUTTON PANELS, BOLSTERS, ELECTRICAL WIRING, AND COMPUTER HARDWARE AND SOFTWARE ASSOCIATED THEREWITH (U.S. CLS. 21, 23, 26, 36 AND 38).

JASON ROTH, EXAMINING ATTORNEY

SN 78-857,519. IGT, RENO, NV. FILED 4-10-2006.

ANCIENT GOLD

THE MARK CONSISTS OF STANDARD CHARACTERS WITHOUT CLAIM TO ANY PARTICULAR FONT, STYLE, SIZE, OR COLOR.

FOR GAMING MACHINES, NAMELY, DEVICES WHICH ACCEPT A WAGER AND COMPONENTS THEREFOR, NAMELY, CONTROLLERS, DISPLAYS, BUTTON PANELS, BOLSTERS, ELECTRICAL WIRING, AND COMPUTER HARDWARE AND SOFTWARE ASSOCIATED THEREWITH (U.S. CLS. 21, 23, 26, 36 AND 38).

JASON ROTH, EXAMINING ATTORNEY

CLASS 9—(Continued).

SN 78-857,935. EDX ELECTRONICS, INC., WINTER SPRINGS, FL. FILED 4-10-2006.



FOR SOFTWARE FOR WORLDWIDE TRACKING OF ELECTRONIC COMPONENTS, NAMELY CIRCUIT BOARD ELECTRONIC PART COMPONENTS, BY PROVIDING STATISTICAL INFORMATION, NAMELY HIGH, MEDIUM AND LOW PART COMPONENT AVAILABILITY, BENCHMARK PRICING, FACTORY LEAD TIME, SALES HISTORY, PURCHASE HISTORY AND GLOBAL AVAILABILITY SHOWING SUPPLIER INFORMATION SPECIFICS, NAMELY QUANTITY OF PART COMPONENT AVAILABILITY AND PART COMPONENT PRICING AND FACTORY DELIVERY LEAD TIME, ON ELECTRONIC PART COMPONENTS BEING SEARCHED; SOFTWARE FOR TRACKING AND RECORDING ELECTRONIC PART COMPONENT SEARCH HISTORIES FOR CUSTOMERS, NAMELY PAST CUSTOMER SALES AND PAST CUSTOMER SEARCH ORDERS AND PAST CUSTOMER SEARCH REQUIREMENTS; SOFTWARE FOR EMAILING OVER THE WORLDWIDE WEB TO DISTRIBUTORS AND ELECTRONIC COMPONENT MANUFACTURERS REQUESTS FOR BIDDING LOWEST PRICES AND AVAILABILITY OF ELECTRONIC COMPONENTS, NAMELY CIRCUIT BOARD ELECTRONIC COMPONENTS (U.S. CLS. 21, 23, 26, 36 AND 38).

FIRST USE 3-1-2006; IN COMMERCE 3-1-2006.
REBECCA SMITH, EXAMINING ATTORNEY

SN 78-858,264. MOTIVE EYEWEAR, INC., MIAMI, FL. FILED 4-10-2006.

HIGHWAY 101

THE MARK CONSISTS OF STANDARD CHARACTERS WITHOUT CLAIM TO ANY PARTICULAR FONT, STYLE, SIZE, OR COLOR.

FOR SUNGLASSES (U.S. CLS. 21, 23, 26, 36 AND 38).
SANI KHOURI, EXAMINING ATTORNEY

CLASS 9—(Continued).

SN 78-858,392. MARCHESSAULT, STEVEN, CANYON COUNTRY, CA. FILED 4-11-2006.

ContactMate

THE MARK CONSISTS OF STANDARD CHARACTERS WITHOUT CLAIM TO ANY PARTICULAR FONT, STYLE, SIZE, OR COLOR.

FOR COMPUTER SOFTWARE FOR INDIVIDUALS AND BUSINESSES, NAMELY, CUSTOMER RELATIONSHIP MANAGEMENT AND CONTACT MANAGEMENT SOFTWARE ENABLING USERS TO MAKE CONTACT AND BUILD RELATIONSHIPS THROUGH INTERACTIVE VOICE RESPONSE COMMUNICATIONS SOFTWARE FOR SALES FORCE, MARKETING, AND CUSTOMER SERVICE PURPOSES (U.S. CLS. 21, 23, 26, 36 AND 38).

JASON LOTT, EXAMINING ATTORNEY

SN 78-858,638. HEALTHWARE CORPORATION, LINCOLN, NE. FILED 4-11-2006.

iDVM

THE MARK CONSISTS OF STANDARD CHARACTERS WITHOUT CLAIM TO ANY PARTICULAR FONT, STYLE, SIZE, OR COLOR.

FOR COMPUTER SOFTWARE FOR MAINTAINING PATIENT RECORDS AND BILLING IN THE FIELD OF PRACTICE MANAGEMENT FOR VETERINARIANS (U.S. CLS. 21, 23, 26, 36 AND 38).

DAVID TAYLOR, EXAMINING ATTORNEY

SN 78-858,658. NCS PEARSON, INC., BLOOMINGTON, MN. FILED 4-11-2006.

PROSPER

THE MARK CONSISTS OF STANDARD CHARACTERS WITHOUT CLAIM TO ANY PARTICULAR FONT, STYLE, SIZE, OR COLOR.

FOR COMPUTER SOFTWARE, NAMELY, SOFTWARE FOR CREATING, DELIVERING, SCORING AND REPORTING ON TESTS AND ASSESSMENTS FOR THE PURPOSE OF PROVIDING INSTRUCTORS TIMELY FEEDBACK THAT ENABLES THEM TO MAKE BETTER INSTRUCTIONAL DECISIONS AND IMPROVE LEARNER PERFORMANCE (U.S. CLS. 21, 23, 26, 36 AND 38).

FIRST USE 6-30-2004; IN COMMERCE 6-30-2004.

JASON BLAIR, EXAMINING ATTORNEY

CLASS 9—(Continued).

SN 78-858,670. NCS PEARSON, INC., BLOOMINGTON, MN. FILED 4-11-2006.

Prosper

**assessment
system**

NO CLAIM IS MADE TO THE EXCLUSIVE RIGHT TO USE "ASSESSMENT SYSTEM", APART FROM THE MARK AS SHOWN.

FOR COMPUTER SOFTWARE, NAMELY, SOFTWARE FOR CREATING, DELIVERING, SCORING AND REPORTING ON TESTS AND ASSESSMENTS FOR THE PURPOSE OF PROVIDING INSTRUCTORS TIMELY FEEDBACK THAT ENABLES THEM TO MAKE BETTER INSTRUCTIONAL DECISIONS AND IMPROVE LEARNER PERFORMANCE (U.S. CLS. 21, 23, 26, 36 AND 38).

FIRST USE 6-30-2004; IN COMMERCE 6-30-2004.

JASON BLAIR, EXAMINING ATTORNEY

SN 78-858,799. BAPTIST HEALTH VENTURES, INC., PENSACOLA, FL. FILED 4-11-2006.

The Daily Line-Up

THE MARK CONSISTS OF STANDARD CHARACTERS WITHOUT CLAIM TO ANY PARTICULAR FONT, STYLE, SIZE, OR COLOR.

NO CLAIM IS MADE TO THE EXCLUSIVE RIGHT TO USE "DAILY", APART FROM THE MARK AS SHOWN.

FOR COMPUTER SOFTWARE FOR MAINTAINING, CUSTOMIZING, AND DELIVERING DAILY EDUCATIONAL MESSAGES FOR EMPLOYEES (U.S. CLS. 21, 23, 26, 36 AND 38).

FIRST USE 2-1-2001; IN COMMERCE 6-1-2004.

BENJAMIN OKEKE, EXAMINING ATTORNEY

SN 78-858,889. MINARIK, MARC, LOS ANGELES, CA. FILED 4-11-2006.

TONE PERFECT

THE MARK CONSISTS OF STANDARD CHARACTERS WITHOUT CLAIM TO ANY PARTICULAR FONT, STYLE, SIZE, OR COLOR.

NO CLAIM IS MADE TO THE EXCLUSIVE RIGHT TO USE "TONE", APART FROM THE MARK AS SHOWN.

FOR ELECTRONIC SOUND PICKUP FOR GUITARS AND BASSES (U.S. CLS. 21, 23, 26, 36 AND 38).

FIRST USE 1-5-2005; IN COMMERCE 6-3-2005.

DAVID COLLIER, EXAMINING ATTORNEY

CLASS 9—(Continued).

SN 78-859,138. WOWZEE WORKS, LLC, LAS VEGAS, NV.
FILED 4-11-2006.



FOR AUDIO RECORDINGS FEATURING CHILDREN'S MUSIC AND VIDEOTAPES AND VIDEO DISKS RECORDED WITH ANIMATION (U.S. CLS. 21, 23, 26, 36 AND 38).

DEZMONA MIZELLE, EXAMINING ATTORNEY

CLASS 9—(Continued).

SN 78-859,375. QTHOUGHTS, LONDON, CANADA, FILED 4-11-2006.

eGym

THE MARK CONSISTS OF STANDARD CHARACTERS WITHOUT CLAIM TO ANY PARTICULAR FONT, STYLE, SIZE, OR COLOR.

FOR COMPUTER SOFTWARE FOR THE COLLECTION, EDITING, ORGANIZING, MODIFYING, BOOK MARKING, TRANSMISSION, STORAGE AND SHARING OF DATA AND INFORMATION; COMPUTER SOFTWARE THAT PROVIDES REAL-TIME, INTEGRATED BUSINESS MANAGEMENT INTELLIGENCE BY COMBINING INFORMATION FROM VARIOUS DATABASES AND PRESENTING IT IN AN EASY-TO-UNDERSTAND USER INTERFACE (U.S. CLS. 21, 23, 26, 36 AND 38).

REBECCA POVARCHUK, EXAMINING ATTORNEY

SN 78-859,417. POWER SUPPORT, SHIBUYA, JAPAN, FILED 4-11-2006.

POWER SUPPORT

THE MARK CONSISTS OF STANDARD CHARACTERS WITHOUT CLAIM TO ANY PARTICULAR FONT, STYLE, SIZE, OR COLOR.

FOR ARM RESTS FOR USE WITH COMPUTERS; BACKUP DRIVES FOR COMPUTERS; BAGS FOR CAMERAS AND PHOTOGRAPHIC EQUIPMENT; BATTERY CASES; BLANK COMPUTER DISCS; BLANK DISCS FOR COMPUTERS; BLANK FLOPPY COMPUTER DISCS; BLANK HARD COMPUTER DISCS; BLANK MAGNETIC COMPUTER TAPES; BLANK TAPES FOR STORAGE OF COMPUTER DATA; CAMERA CASES; CAMERA CLOSURES; CAMERA FILTERS; CAR NAVIGATION COMPUTERS; CD DRIVES FOR COMPUTERS; COMPUTER CABLES; COMPUTER CAMERAS; COMPUTER CARRYING CASES; COMPUTER CHASSIS; COMPUTER CURSOR CONTROL DEVICES, NAMELY, COMPUTER MOUSE; COMPUTER CURSOR CONTROL DEVICES, NAMELY, DIGITIZER TABLETS; COMPUTER CURSOR CONTROL DEVICES, NAMELY, LIGHT PENS; COMPUTER CURSOR CONTROL DEVICES, NAMELY, TOUCHPADS; COMPUTER CURSOR CONTROL DEVICES, NAMELY, TRACKBALLS; COMPUTER JOYSTICKS; COMPUTER KEYBOARDS; COMPUTER KEYPADS; COMPUTER MONITORS; COMPUTER MOUSE; COMPUTER MOUSE, NAMELY, TOUCHPADS; COMPUTER MOUSE, NAMELY, TRACKBALLS; COMPUTER PERIPHERALS; COMPUTER SCREEN FILTERS; COMPUTER STANDS SPECIALLY DESIGNED FOR HOLDING A COMPUTER, PRINTER AND ACCESSORIES; COMPUTER STYLUS; DUST COVERS FOR COMPUTERS; MOUSE PADS; OPTICAL FILTERS FOR SCREENS; PROTECTIVE CARRYING CASES FOR PORTABLE MUSIC PLAYERS NAMELY MP3 PLAYERS; WIRELESS COMPUTER PERIPHERALS; WRIST RESTS FOR COMPUTER MOUSE USERS; WRIST RESTS FOR USE WITH COMPUTERS; WRIST SUPPORTS FOR COMPUTER MOUSE USERS (U.S. CLS. 21, 23, 26, 36 AND 38).

FIRST USE 9-30-1996; IN COMMERCE 9-30-1996.

JACQUELINE A. LAVINE, EXAMINING ATTORNEY

SN 78-859,200. WOWZEE WORKS, LLC, LAS VEGAS, NV.
FILED 4-11-2006.



FOR AUDIO RECORDINGS FEATURING CHILDREN'S MUSIC AND VIDEOTAPES AND VIDEO DISKS RECORDED WITH ANIMATION (U.S. CLS. 21, 23, 26, 36 AND 38).

DEZMONA MIZELLE, EXAMINING ATTORNEY

CLASS 9—(Continued).

SN 78-859,430. POWER SUPPORT CO., LTD., SHIBUYA, JAPAN, FILED 4-11-2006.

PAWASAPO

THE MARK CONSISTS OF STANDARD CHARACTERS WITHOUT CLAIM TO ANY PARTICULAR FONT, STYLE, SIZE, OR COLOR.

FOR ARM RESTS FOR USE WITH COMPUTERS; BACKUP DRIVES FOR COMPUTERS; BAGS FOR CAMERAS AND PHOTOGRAPHIC EQUIPMENT; BATTERY CASES; BLANK COMPUTER DISCS; BLANK DISCS FOR COMPUTERS; BLANK FLOPPY COMPUTER DISCS; BLANK HARD COMPUTER DISCS; CAMERA CASES; CAMERA CLOSURES; CAMERA FILTERS; COLOR FILTERS FOR TELEVISION AND MOTION PICTURE FILM CAMERAS; COLOR SEPARATION FILM; COMPUTER CABLES; COMPUTER CAMERAS; COMPUTER CARRYING CASES; COMPUTER CHASSIS; COMPUTER CURSOR CONTROL DEVICES, NAMELY, COMPUTER MOUSE; COMPUTER CURSOR CONTROL DEVICES, NAMELY, DIGITIZER TABLETS; COMPUTER CURSOR CONTROL DEVICES, NAMELY, LIGHT PENS; COMPUTER CURSOR CONTROL DEVICES, NAMELY, TOUCH PADS; COMPUTER CURSOR CONTROL DEVICES, NAMELY, TRACKBALLS; COMPUTER DOCKING STATION; COMPUTER GAME DISCS; COMPUTER GAME JOYSTICKS; COMPUTER HARDWARE; COMPUTER JOYSTICKS; COMPUTER KEYBOARDS; COMPUTER KEYPADS; COMPUTER MOUSE; COMPUTER MOUSE, NAMELY, TOUCHPADS; COMPUTER MOUSE, NAMELY, TRACKBALLS; COMPUTER PERIPHERALS; COMPUTER SCREEN FILTERS; COMPUTER STANDS SPECIALLY DESIGNED FOR HOLDING A COMPUTER, PRINTER AND ACCESSORIES; COMPUTER STYLUS; COMPUTER TERMINALS; DUST COVERS FOR COMPUTERS; FLAT PANEL DISPLAY SCREENS; FRAMES FOR ATTACHMENT TO COMPUTER MONITORS; HANDHELD PERSONAL COMPUTERS; LCD LARGE-SCREEN DISPLAYS; MOUNTING RACKS FOR COMPUTER HARDWARE; MOUSE PADS; MP3 PLAYERS; NAVIGATION APPARATUS FOR VEHICLES; NOTEBOOK COMPUTERS; OPTICAL FILTERS FOR SCREENS; PERSONAL COMPUTERS; PERSONAL DIGITAL ASSISTANT COMPUTERS; PORTABLE LISTENING DEVICES, NAMELY, MP3 PLAYERS; PROTECTIVE CARRYING CASES FOR PORTABLE MUSIC PLAYERS NAMELY MP3 PLAYERS; REMOTE CURSOR CONTROLS FOR COMPUTERS; TABLET COMPUTER; WIRELESS COMPUTER PERIPHERALS; WRIST RESTS FOR COMPUTER MOUSE USERS; WRIST RESTS FOR USE WITH COMPUTERS; WRIST SUPPORTS FOR COMPUTER MOUSE USERS (U.S. CLS. 21, 23, 26, 36 AND 38).

FIRST USE 9-30-1996; IN COMMERCE 9-30-1996.
JACQUELINE A. LAVINE, EXAMINING ATTORNEY

CLASS 9—(Continued).

SN 78-859,839. NYX GOLF, INC., ADDISON, TX. FILED 4-12-2006.

Deflector

THE MARK CONSISTS OF STANDARD CHARACTERS WITHOUT CLAIM TO ANY PARTICULAR FONT, STYLE, SIZE, OR COLOR.

FOR SUNGLASS LENSES (U.S. CLS. 21, 23, 26, 36 AND 38).

FIRST USE 3-15-1995; IN COMMERCE 6-6-1995.
JENNIFER VASQUEZ, EXAMINING ATTORNEY

SN 78-859,855. NYX GOLF, INC., ADDISON, TX. FILED 4-12-2006.

Neutralizer

THE MARK CONSISTS OF STANDARD CHARACTERS WITHOUT CLAIM TO ANY PARTICULAR FONT, STYLE, SIZE, OR COLOR.

FOR SUNGLASS LENSES (U.S. CLS. 21, 23, 26, 36 AND 38).

FIRST USE 3-15-1995; IN COMMERCE 6-6-1995.
JENNIFER VASQUEZ, EXAMINING ATTORNEY

SN 78-859,899. NYX GOLF, INC., ADDISON, TX. FILED 4-12-2006.

Read Every Green

THE MARK CONSISTS OF STANDARD CHARACTERS WITHOUT CLAIM TO ANY PARTICULAR FONT, STYLE, SIZE, OR COLOR.

FOR SUNGLASS LENSES; SUNGLASSES (U.S. CLS. 21, 23, 26, 36 AND 38).

FIRST USE 3-15-1995; IN COMMERCE 6-6-1995.
JENNIFER VASQUEZ, EXAMINING ATTORNEY

CLASS 9—(Continued).

SN 78-860,031. BOUTROSS, THERESA, BARRINGTON, IL. FILED 4-12-2006.

APPRENTICIZE

THE MARK CONSISTS OF STANDARD CHARACTERS WITHOUT CLAIM TO ANY PARTICULAR FONT, STYLE, SIZE, OR COLOR.

FOR DOWNLOADABLE VIDEO RECORDINGS FEATURING FITNESS EDUCATION; EDUCATIONAL SOFTWARE FEATURING INSTRUCTION IN FITNESS EDUCATION; PRE-RECORDED CD'S, VIDEO TAPES, LASER DISKS AND DVD'S FEATURING FITNESS EDUCATION; VIDEO RECORDINGS FEATURING FITNESS EDUCATION (U.S. CLS. 21, 23, 26, 36 AND 38). SARAH WAYDA, EXAMINING ATTORNEY

SN 78-860,110. MATRIX TECHNOLOGIES CORPORATION, HUDSON, NH. FILED 4-12-2006.

FLUID THINKING

THE MARK CONSISTS OF STANDARD CHARACTERS WITHOUT CLAIM TO ANY PARTICULAR FONT, STYLE, SIZE, OR COLOR.

FOR LABORATORY EQUIPMENT, NAMELY, LIQUID DISPENSERS, PIPETTORS, TUBE AND PIPETTE RACKS AND TRAYS; LABORATORY HARDWARE, NAMELY PIPETTES, MICROPROCESSORS, KEYBOARDS AND DIGITAL DISPLAY MONITORS FOR DISPENSERS; AND LABORATORY CONSUMABLES, NAMELY, PIPETTE TIPS, FILTER TIPS; LABORATORY STORAGE DEVICES, NAMELY, MULTIWELL PLATES, DEEPWELL BLOCKS, TUBE RACKS, TEST TUBES, AND REAGENT RESERVOIRS (U.S. CLS. 21, 23, 26, 36 AND 38). FIRST USE 5-31-2003; IN COMMERCE 5-31-2003.

SANI KHOURI, EXAMINING ATTORNEY

CLASS 9—(Continued).

SN 78-860,235. ITRON, INC., SPOKANE, WA. FILED 4-12-2006.

HH-PRO

THE MARK CONSISTS OF STANDARD CHARACTERS WITHOUT CLAIM TO ANY PARTICULAR FONT, STYLE, SIZE, OR COLOR.

FOR COMPUTER SOFTWARE FOR ACCESSING, INSTALLING, CONFIGURING, PROGRAMMING, SYNCHRONIZING, SCHEDULING, MANAGING AND TROUBLESHOOTING UTILITY METERS FOR USE ON A VARIETY OF PLATFORMS; COMPUTER SOFTWARE THAT WILL ALLOW THE USER TO PERFORM VARIOUS TASKS, NAMELY, OBTAINING, COLLECTING, RECORDING, PROCESSING AND TRANSMITTING METER DATA RELATING TO USE AND TRANSMITTAL OF ELECTRICITY, WATER, GAS AND THERMAL ENERGY (U.S. CLS. 21, 23, 26, 36 AND 38).

KATHLEEN M. VANSTON, EXAMINING ATTORNEY

SN 78-860,345. POWER SUPPORT CO., LTD., SHIBUYA, JAPAN, FILED 4-12-2006.

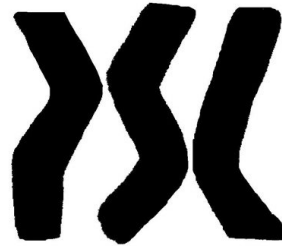

THE MARK CONSISTS OF THREE, SEPARATE DESIGN MARKS THAT RESEMBLE A P, AN S AND A C, THAT STANDS FOR POWER SUPPORT CO.

FOR ARM RESTS FOR USE WITH COMPUTERS; BACKUP DRIVES FOR COMPUTERS; BAGS FOR CAMERAS AND PHOTOGRAPHIC EQUIPMENT; BATTERY CASES; BEEPER CARRYING CASES; BLANK COMPUTER DISCS; BLANK DISCS FOR COMPUTERS; BLANK FLOPPY COMPUTER DISCS; CAMERA CASES; CAMERA CLOSURES; CAMERA FILTERS; CAR NAVIGATION COMPUTERS; CASES FOR DISKETTES AND COMPACT DISKS; CASES FOR ELECTRONIC DIARIES; CASES FOR MOBILE PHONES; CASES FOR PHOTOGRAPHIC APPARATUS; CASES FOR POCKET CALCULATORS; CASES FOR SPECTACLES AND SUNGLASSES; CASES FOR TELEPHONES; CD CASES; COMMUNICATIONS COMPUTERS; COMPACT DISC CASES; COMPUTER CABLES; COMPUTER CAMERAS; COMPUTER CARRYING CASES; COMPUTER CHASSIS; COMPUTER CURSOR CONTROL DEVICES, NAMELY, COMPUTER MOUSE; COMPUTER CURSOR CONTROL DEVICES, NAMELY, DIGITIZER TABLETS; COMPUTER CURSOR CONTROL DEVICES, NAMELY, LIGHT PENS; COMPUTER CURSOR CONTROL DEVICES, NAMELY, TOUCH PADS; COMPUTER CURSOR CONTROL DEVICES, NAMELY, TRACKBALLS; COMPUTER DISC DRIVES; COMPUTER DOCKING STATION; COMPUTER GAME CARTRIDGES; COMPUTER GAME CASSETTES; COMPUTER GAME DISCS; COMPUTER GAME EQUIPMENT CONTAINING MEMORY DEVICES NAMELY, DISCS; COMPUTER GAME JOYSTICKS; COMPUTER GAME

CLASS 9—(Continued).

PROGRAMS; COMPUTER HARDWARE; COMPUTER JOYSTICKS; COMPUTER KEYBOARDS; COMPUTER KEYPADS; COMPUTER MEMORIES; COMPUTER MONITOR FRAMES; COMPUTER MONITORS; COMPUTER MOUSE; COMPUTER MOUSE, NAMELY, TOUCH-PADS; COMPUTER MOUSE, NAMELY, TRACKBALLS; COMPUTER NETWORK HUBS, SWITCHES AND ROUTERS; COMPUTER PERIPHERALS; COMPUTER PRINTERS; COMPUTER SCREEN FILTERS; COMPUTER SCREEN SAVER SOFTWARE; COMPUTER STANDS SPECIALLY DESIGNED FOR HOLDING A COMPUTER, PRINTER AND ACCESSORIES; COMPUTER STYLUS; COMPUTER TERMINALS; DESKTOP COMPUTERS; DUST COVERS FOR COMPUTERS; ELECTRONIC COMPUTERS; HANDHELD COMPUTERS; HANDHELD PERSONAL COMPUTERS; JACKETS FOR COMPUTER DISKS; LAPTOP CARRYING CASES; LAPTOP COMPUTERS; LENS FILTERS; MICRO-COMPUTER; MICRO-COMPUTERS; MOBILE COMPUTERS; MOUNTING RACKS FOR COMPUTER HARDWARE; MOUSE PADS; NOTEBOOK COMPUTERS; OPTICAL FILTERS; OPTICAL FILTERS FOR SCREENS; PERSONAL COMPUTERS; PERSONAL DIGITAL ASSISTANT COMPUTERS; POCKET COMPUTERS FOR NOTE-TAKING; PROTECTIVE CARRYING CASES FOR PORTABLE MUSIC PLAYERS NAMELY MP3 PLAYERS; REMOTE CURSOR CONTROLS FOR COMPUTERS; TABLET COMPUTER; WIRELESS COMPUTER PERIPHERALS; WRIST RESTS FOR COMPUTER MOUSE USERS; WRIST RESTS FOR USE WITH COMPUTERS; WRIST SUPPORTS FOR COMPUTER MOUSE USERS (U.S. CLS. 21, 23, 26, 36 AND 38).

FIRST USE 9-30-1996; IN COMMERCE 9-30-1996.

JACQUELINE A. LAVINE, EXAMINING ATTORNEY

CLASS 9—(Continued).

SN 78-860,358. REELIN' IN THE YEARS PRODUCTIONS LLC, EL CAJON, CA. FILED 4-12-2006.



NO CLAIM IS MADE TO THE EXCLUSIVE RIGHT TO USE "JAZZ ICONS", APART FROM THE MARK AS SHOWN.

FOR MUSICAL VIDEO RECORDINGS, AUDIO RECORDS, VIDEOTAPES, DVDS FEATURING VARIOUS MUSIC PERFORMERS (U.S. CLS. 21, 23, 26, 36 AND 38).
NAKIA HENRY, EXAMINING ATTORNEY

SN 78-860,356. UNIVERSAL CITY STUDIOS LLLP, UNIVERSAL CITY, CA. FILED 4-12-2006.

FOUR STAR COLLECTION

THE MARK CONSISTS OF STANDARD CHARACTERS WITHOUT CLAIM TO ANY PARTICULAR FONT, STYLE, SIZE, OR COLOR.

NO CLAIM IS MADE TO THE EXCLUSIVE RIGHT TO USE "COLLECTION", APART FROM THE MARK AS SHOWN.

FOR PRERECORDED VIDEO DISCS AND PRERECORDED VIDEO TAPES ALL FEATURING MOTION PICTURES (U.S. CLS. 21, 23, 26, 36 AND 38).

DEIRDRE ROBERTSON, EXAMINING ATTORNEY

SN 78-860,446. STRIX SYSTEMS, INC., CALABASAS, CA. FILED 4-12-2006.

Strix DMA

THE MARK CONSISTS OF STANDARD CHARACTERS WITHOUT CLAIM TO ANY PARTICULAR FONT, STYLE, SIZE, OR COLOR.

OWNER OF U.S. REG. NOS. 2,835,797, 2,987,369 AND 3,090,988.

FOR COMPUTER HARDWARE AND SOFTWARE ENABLING WIRELESS ACCESS TO A COMPUTER-BASED INFORMATION NETWORK; COMPUTER HARDWARE FOR USE IN A WIRELESS NETWORK; COMPUTER SOFTWARE FOR USE IN CREATING, MAINTAINING AND MANAGING A WIRELESS NETWORK (U.S. CLS. 21, 23, 26, 36 AND 38).

KIMBERLY FRYE, EXAMINING ATTORNEY

CLASS 9—(Continued).

SN 78-860,447. STRIX SYSTEMS, INC., CALABASAS, CA.
FILED 4-12-2006.

Strix HPMA

THE MARK CONSISTS OF STANDARD CHARACTERS WITHOUT CLAIM TO ANY PARTICULAR FONT, STYLE, SIZE, OR COLOR.

OWNER OF U.S. REG. NOS. 2,835,797, 2,987,369 AND 3,090,988.

FOR COMPUTER HARDWARE AND SOFTWARE ENABLING WIRELESS ACCESS TO A COMPUTER-BASED INFORMATION NETWORK; COMPUTER HARDWARE FOR USE IN A WIRELESS NETWORK; COMPUTER SOFTWARE FOR USE IN CREATING, MAINTAINING AND MANAGING A WIRELESS NETWORK (U.S. CLS. 21, 23, 26, 36 AND 38).

KIMBERLY FRYE, EXAMINING ATTORNEY

SN 78-860,448. STRIX SYSTEMS, INC., CALABASAS, CA.
FILED 4-12-2006.

Strix SMFR

THE MARK CONSISTS OF STANDARD CHARACTERS WITHOUT CLAIM TO ANY PARTICULAR FONT, STYLE, SIZE, OR COLOR.

OWNER OF U.S. REG. NOS. 2,835,797, 2,987,369 AND 3,090,988.

FOR COMPUTER HARDWARE AND SOFTWARE ENABLING WIRELESS ACCESS TO A COMPUTER-BASED INFORMATION NETWORK; COMPUTER HARDWARE FOR USE IN A WIRELESS NETWORK; COMPUTER SOFTWARE FOR USE IN CREATING, MAINTAINING AND MANAGING A WIRELESS NETWORK (U.S. CLS. 21, 23, 26, 36 AND 38).

KIMBERLY FRYE, EXAMINING ATTORNEY

SN 78-860,547. VISABILITY, INC., GRANTS PASS, OR.
FILED 4-13-2006.

Redi-Mirror

THE MARK CONSISTS OF STANDARD CHARACTERS WITHOUT CLAIM TO ANY PARTICULAR FONT, STYLE, SIZE, OR COLOR.

FOR OPHTHALMIC OPTICAL LENSES (U.S. CLS. 21, 23, 26, 36 AND 38).

INGRID C. EULIN, EXAMINING ATTORNEY

CLASS 9—(Continued).

SN 78-860,549. PRICE, KEITH, E, TORONTO, ONTARIO,
CANADA, FILED 4-13-2006.



THE APPLICANT CLAIMS COLOR AS A FEATURE OF THE MARK, NAMELY, BLACK, WHITE, GREEN, YELLOW.

THE MARK CONSISTS OF A WHITE COLORED SCRIPT FONT CALLED "SCRIPTINA" THAT SPELLS OUT THE LITERAL ELEMENT OF "BUNNY RUGS". THE WORDS "BUNNY RUGS" APPEAR IN WHITE AND APPEAR ON TOP OF GRADIENT COLORS THAT INCLUDE IN THIS ORDER FROM LEFT TO RIGHT - BLACK, GREEN, BLACK, YELLOW, BLACK. THE TOP OF THE GRADIENT COLORS START AT THE TOP OF THE "R" IN RUGS THEN TO THE BOTTOM OF THE "R" IN RUGS. THE GRADIENT COLORS START FROM THE BEGINNING OF THE WORD "BUNNY" AND GO LEFT TO RIGHT TO THE END OF THE WORD "RUGS". THE GRADIENT COLORS UNDER THE WORDS "BUNNY RUGS" CAN APPEAR ON TOP OF ANY COLOR - FOR FILING PURPOSES IT IS OVER THE COLOR BLACK.

FOR MUSICAL SOUND RECORDINGS (U.S. CLS. 21, 23, 26, 36 AND 38).

FIRST USE 8-25-2005; IN COMMERCE 8-25-2005.
INGRID C. EULIN, EXAMINING ATTORNEY

SN 78-860,644. TESARIK, DAVID, PRAHA, CZECH REPUBLIC,
FILED 4-13-2006.

TRUECRYPT

THE MARK CONSISTS OF STANDARD CHARACTERS WITHOUT CLAIM TO ANY PARTICULAR FONT, STYLE, SIZE, OR COLOR.

FOR COMPUTER SOFTWARE FOR ENCRYPTION (U.S. CLS. 21, 23, 26, 36 AND 38).

FIRST USE 11-22-2003; IN COMMERCE 2-2-2004.

MARGERY A. TIERNEY, EXAMINING ATTORNEY

CLASS 9—(Continued).

SN 78-860,675. H. COOPER WALKER, BURLINGTON, NC.
FILED 4-13-2006.

EDUPALS

THE MARK CONSISTS OF STANDARD CHARACTERS WITHOUT CLAIM TO ANY PARTICULAR FONT, STYLE, SIZE, OR COLOR.

FOR ELECTRONIC PUBLICATIONS, NAMELY, CHILDREN'S BOOKS FEATURING ILLUSTRATED STORIES, ANIMATED STORIES, AND COLORING BOOKS RECORDED ON COMPUTER MEDIA (U.S. CLS. 21, 23, 26, 36 AND 38).

NORA BUCHANAN WILL, EXAMINING ATTORNEY

SN 78-860,788. MEDICAL & TECHNICAL INTERFACE ASSOCIATES INC., SIMI VALLEY, CA. FILED 4-13-2006.

IMAGIFAX

THE MARK CONSISTS OF STANDARD CHARACTERS WITHOUT CLAIM TO ANY PARTICULAR FONT, STYLE, SIZE, OR COLOR.

FOR COMPUTER SOFTWARE FOR INTERNET FAXING OF DOCTOR'S ORDERS THROUGH CELLULAR PHONES (U.S. CLS. 21, 23, 26, 36 AND 38).

JANICE KIM, EXAMINING ATTORNEY

SN 78-860,947. FGE, ETOBICOKE, ONTARIO, CANADA,
FILED 4-13-2006.

SURVEILLANCE WEBCAM FGE

THE MARK CONSISTS OF STANDARD CHARACTERS WITHOUT CLAIM TO ANY PARTICULAR FONT, STYLE, SIZE, OR COLOR.

OWNER OF U.S. REG. NO. 2,829,954.

NO CLAIM IS MADE TO THE EXCLUSIVE RIGHT TO USE "SURVEILLANCE WEBCAM", APART FROM THE MARK AS SHOWN.

FOR COMPUTER SOFTWARE WHICH PROVIDES VIDEO MONITORING AND SURVEILLANCE FUNCTIONS, CAPTURES VIDEO OF OBJECTS IN MOTION AND ALLOWS THE VIDEO TO BE SEEN OVER THE INTERNET, AND ALSO PROVIDES ALARMS OVER THE INTERNET (U.S. CLS. 21, 23, 26, 36 AND 38).

FIRST USE 9-25-2003; IN COMMERCE 9-25-2003.

CARRIE ACHEN, EXAMINING ATTORNEY

CLASS 9—(Continued).

SN 78-861,143. GAME-XPERT, INC., LAKE FOREST, CA.
FILED 4-13-2006.

TekNmotion

THE MARK CONSISTS OF STANDARD CHARACTERS WITHOUT CLAIM TO ANY PARTICULAR FONT, STYLE, SIZE, OR COLOR.

FOR BLANK CD-ROMS FOR SOUND OR VIDEO RECORDING; CASES FOR DISKETTES AND COMPACT DISKS; CD CASES; CD SLEEVES; CD STORAGE RACKS; CD STORAGE WALLETS; COMPACT DISC CASES; DVD CASES; PLASTIC AND CARDBOARD CASES FOR STORING RECORD ALBUMS; PLASTIC CASE USED AS A SECURITY DEVICE FOR PROTECTING AND SECURING DVD'S AND OTHER MAGNETIC AND ELECTRONIC MEDIA FROM THEFT (U.S. CLS. 21, 23, 26, 36 AND 38).

FIRST USE 1-1-2006; IN COMMERCE 2-1-2006.

JASON BLAIR, EXAMINING ATTORNEY

SN 78-861,408. NANOPOINT, INC., HONOLULU, HI. FILED
4-13-2006.

cellTRAY

THE MARK CONSISTS OF STANDARD CHARACTERS WITHOUT CLAIM TO ANY PARTICULAR FONT, STYLE, SIZE, OR COLOR.

FOR PLATES, GLASS SLIDES OR CHIPS HAVING MULTI-WELL ARRAYS THAT CAN BE USED IN CHEMICAL ANALYSIS, BIOLOGICAL ANALYSIS OR PATTERNING FOR SCIENTIFIC, LABORATORY OR MEDICAL RESEARCH USE (U.S. CLS. 21, 23, 26, 36 AND 38).

AISHA CLARKE, EXAMINING ATTORNEY

SN 78-861,442. CARPENTER, RICHARD L, ALBUQUERQUE,
NM. FILED 4-13-2006.

ABGAMER

THE MARK CONSISTS OF STANDARD CHARACTERS WITHOUT CLAIM TO ANY PARTICULAR FONT, STYLE, SIZE, OR COLOR.

FOR ELECTRONIC AND VIDEO GAME CONTROLLERS INCORPORATED INTO EXERCISE (U.S. CLS. 21, 23, 26, 36 AND 38).

ELIZABETH J. WINTER, EXAMINING ATTORNEY

CLASS 9—(Continued).

SN 78-861,755. COMPUTERIZED MEDICAL SYSTEMS, INC., ST. LOUIS, MO. FILED 4-14-2006.



OWNER OF U.S. REG. NO. 1,967,676.
THE COLORS BLUE, YELLOW, RED, LIGHT BLUE, PURPLE, GREEN, BLACK AND WHITE ARE CLAIMED AS A FEATURE OF THE MARK.

THE MARK CONSISTS OF THE LITERAL ELEMENT "CMS" WITH ASSOCIATED DESIGN. CMS APPEARS IN THE COLOR BLUE. THE DESIGN IS A FANCIFUL REPRESENTATION OF A SPHERE, APPEARING PRIMARILY IN THE COLOR BLUE, AND TRANSITIONING TO BLACK AT THE BOTTOM, AND HAVING A WHITE SPOT IN THE UPPER PORTION REPRESENTING SHININESS, AND FIVE RECTANGLES, FROM TOP TO BOTTOM, APPEARING IN THE COLORS YELLOW, RED, LIGHT BLUE, PURPLE AND GREEN, WITH ASSOCIATED ARCuated BANDS, WITH EACH APPEARING IN THE SAME COLOR INITIALLY AS ITS ADJACENT RECTANGLE AND TRANSITIONING, FROM RIGHT TO LEFT TO THE COLOR WHITE, CREATING THE IMPRESSION THAT THE BANDS ARE ORBITING THE SPHERE ALONG ADJACENT PATHS. NO SPECIFIC COLOR CLAIM IS MADE WITH RESPECT TO THE BACKGROUND.

FOR TWO-DIMENSIONAL AND THREE-DIMENSIONAL PATIENT TREATMENT PLANNING SYSTEMS, COMPRISING AN INTERACTIVE, MULTI-USER, MULTI-TASKING COMPUTER NETWORK, COMPRISED OF HARDWARE, MEDICAL SOFTWARE, AND PERIPHERALS, AND USED IN THE PLANNING, APPLICATION AND ANALYSIS OF RADIATION TREATMENT OF PATIENTS; TREATMENT INFORMATION VERIFICATION SYSTEMS, COMPRISING A NETWORK OF COMPUTERS, COMPRISED OF COMPUTER HARDWARE, OPERATING MEDICAL SOFTWARE, AND PERIPHERALS, AND USED IN THE PLANNING, APPLICATION AND ANALYSIS OF RADIATION TREATMENT OF PATIENTS; AND MEDICAL DOSIMETRY SYSTEMS, COMPRISED OF COMPUTER HARDWARE, OPERATING SOFTWARE, AND PERIPHERALS, AND USED IN THE PLANNING, APPLICATION AND ANALYSIS OF RADIATION TREATMENT OF PATIENTS (U.S. CLS. 21, 23, 26, 36 AND 38).

JUDITH HELFMAN, EXAMINING ATTORNEY

CLASS 9—(Continued).

SN 78-861,812. FINANCIAL AID MANAGEMENT FOR EDUCATION, INC., FORT LAUDERDALE, FL. FILED 4-14-2006.

ADVANTAGE

THE MARK CONSISTS OF STANDARD CHARACTERS WITHOUT CLAIM TO ANY PARTICULAR FONT, STYLE, SIZE, OR COLOR.

OWNER OF U.S. REG. NO. 3,073,921.

FOR COMPUTER SOFTWARE FOR THE ADMINISTRATION AND MANAGEMENT OF THE OFFICES AND OPERATIONS, OF EDUCATIONAL INSTITUTIONS, NAMELY, ADMISSIONS, BUSINESS, REGISTRAR, FINANCIAL AID, ACADEMICS, HOUSING, BOOKSTORE, LIBRARY, CAFETERIA, MAIL, PLACEMENT, DEFAULT MANAGEMENT, ALUMNI, FUND RAISING, HUMAN RESOURCES, PURCHASING, FACULTY, FACILITIES AND SECURITY (U.S. CLS. 21, 23, 26, 36 AND 38).

LEIGH CAROLINE CASE, EXAMINING ATTORNEY

SN 78-862,073. ROSEN, ROBERT M, MARLBORO, NJ. FILED 4-14-2006.

Magnifier
EnLighten

NO CLAIM IS MADE TO THE EXCLUSIVE RIGHT TO USE MAGNIFIER, APART FROM THE MARK AS SHOWN.

THE MARK CONSISTS OF THE WORDS ENLIGHTEN MAGNIFIER, WITH THE L CHARACTER LARGER; THE TOP OF THE L IS DECORATED WITH A SEMICIRCULAR RING OF DOTS OR STARS.

FOR MAGNIFYING GLASSES (U.S. CLS. 21, 23, 26, 36 AND 38).

PAUL E. FAHRENKOPF, EXAMINING ATTORNEY

SN 78-862,360. TEKSTYL, INC., WINTHROP, MA. FILED 4-16-2006.

omni

THE MARK CONSISTS OF STANDARD CHARACTERS WITHOUT CLAIM TO ANY PARTICULAR FONT, STYLE, SIZE, OR COLOR.

FOR COMPUTER CARRYING CASES (U.S. CLS. 21, 23, 26, 36 AND 38).

FIRST USE 3-7-2005; IN COMMERCE 5-6-2005.

MICHAEL LEWIS, EXAMINING ATTORNEY

CLASS 9—(Continued).

SN 78-862,461. KRISTENSEN, PER SVERRE, OSLO, NORWAY, FILED 4-17-2006.

Easy3D

THE MARK CONSISTS OF STANDARD CHARACTERS WITHOUT CLAIM TO ANY PARTICULAR FONT, STYLE, SIZE, OR COLOR.

FOR COMPUTER PROGRAMS RECORDED ON DATA MEDIA (SOFTWARE) DESIGNED FOR USE IN CONSTRUCTION AND AUTOMATED MANUFACTURING (CAD/CAM) (U.S. CLS. 21, 23, 26, 36 AND 38).

FIRST USE 4-10-2006; IN COMMERCE 4-10-2006.
VIVIAN MICZNIK FIRST, EXAMINING ATTORNEY

SN 78-862,550. SAGE SOFTWARE, INC., IRVINE, CA. FILED 4-17-2006.

ACCURACY. CONTROL. RESULTS.

THE MARK CONSISTS OF STANDARD CHARACTERS WITHOUT CLAIM TO ANY PARTICULAR FONT, STYLE, SIZE, OR COLOR.

FOR COMPUTER SOFTWARE FOR BUSINESS ACCOUNTING THAT MAY BE DOWNLOADED FROM A GLOBAL COMPUTER NETWORK (U.S. CLS. 21, 23, 26, 36 AND 38).

CAROLINE WEIMER, EXAMINING ATTORNEY

SN 78-862,603. THE HILSINGER COMPANY, PLAINVILLE, MA. FILED 4-17-2006.

HYDRO FITNESS

THE MARK CONSISTS OF STANDARD CHARACTERS WITHOUT CLAIM TO ANY PARTICULAR FONT, STYLE, SIZE, OR COLOR.

OWNER OF U.S. REG. NO. 2,430,540.
SEC. 2(F).
FOR PROTECTIVE EYEWEAR FOR SWIMMING (U.S. CLS. 21, 23, 26, 36 AND 38).

FIRST USE 2-0-1999; IN COMMERCE 2-0-1999.
JOHN SCHUYLER YARD, EXAMINING ATTORNEY

CLASS 9—(Continued).

SN 78-862,629. PROFLARE, INC., STUART, FL. FILED 4-17-2006.

TOTALFLARE

THE MARK CONSISTS OF STANDARD CHARACTERS WITHOUT CLAIM TO ANY PARTICULAR FONT, STYLE, SIZE, OR COLOR.

FOR EMERGENCY HAZARD MARKER KIT COMPRISED OF AN ELECTRONIC HAZARD LIGHT UTILIZING LIGHT EMITTING DIODES (LEDS) CONTAINED IN A HIGH IMPACT COMPOSITE BASE WITH A TRANSPARENT UPPER HOUSING IN THE GENERAL SHAPE OF A DISC CONNECTED BY A LINK WHICH ALLOWS THE LIGHT TO BE ORIENTED IN DIFFERENT PLANES OF ILLUMINATION AND TRANSLUCENT CONE AND PENNANT WITH STAFF WHICH EITHER PROVIDES LIGHT THAT CAN BE SEEN BY A MOTORIST AT A SUBSTANTIAL DISTANCE FROM THE HAZARD OR THAT CAN BE SEEN BY AN AIRCRAFT FLYING ABOVE THE HAZARD MARKER (U.S. CLS. 21, 23, 26, 36 AND 38).

MICHAEL LEWIS, EXAMINING ATTORNEY

SN 78-862,702. ENVIRONMENTAL SUPPORT SOLUTIONS, INC., TEMPE, AZ. FILED 4-17-2006.

COMPLIANCE MESSENGER

THE MARK CONSISTS OF STANDARD CHARACTERS WITHOUT CLAIM TO ANY PARTICULAR FONT, STYLE, SIZE, OR COLOR.

FOR COMPUTER SOFTWARE THAT ENHANCES AND FACILITATES THE MANAGEMENT OF ELECTRONIC COMMUNICATIONS BETWEEN PARTIES VIA COMPUTER NETWORKS, PERSONAL COMPUTERS, PDAS AND THE INTERNET (U.S. CLS. 21, 23, 26, 36 AND 38).

IRA J. GOODSaid, EXAMINING ATTORNEY

CLASS 9—(Continued).

SN 78-863,111. HITACHI GLOBAL STORAGE TECHNOLOGIES NETHERLANDS B.V., AMSTERDAM, NETHERLANDS, FILED 4-17-2006.

CINEMASTAR

THE MARK CONSISTS OF STANDARD CHARACTERS WITHOUT CLAIM TO ANY PARTICULAR FONT, STYLE, SIZE, OR COLOR.

FOR COMPUTER HARDWARE, NAMELY, MOBILE HARD DISK DRIVES FOR DATA STORAGE AND RETRIEVAL, COMPUTER HARD DISK DRIVES, COMPUTER FLOPPY DISK DRIVES, BLANK MAGNETIC DISKS, COMPUTER HARDWARE FOR AUDIO AND AUDIOVISUAL RECORDING, DISPLAY, AND PLAYBACK; ELECTRONIC EQUIPMENT FOR AUDIO AND AUDIOVISUAL RECORDING, DISPLAY, AND PLAYBACK; COMPUTER SOFTWARE FOR AUDIO AND AUDIOVISUAL RECORDING, DISPLAY, AND PLAYBACK; INSTRUCTION MANUALS SOLD AS A UNIT THEREWITH FOR THE AFORESAID GOODS (U.S. CLS. 21, 23, 26, 36 AND 38).

ANTHONY RINKER, EXAMINING ATTORNEY

SN 78-863,116. HITEC RCD USA, INC., POWAY, CA. FILED 4-17-2006.

ROBONOVA

THE MARK CONSISTS OF STANDARD CHARACTERS WITHOUT CLAIM TO ANY PARTICULAR FONT, STYLE, SIZE, OR COLOR.

FOR RADIO CONTROL SYSTEM CONSISTING OF A REMOTE CONTROLLER FOR MODEL VEHICLES AND ROBOTS, RADIO CONTROL SYSTEM CONSISTING OF A SPEED CONTROLLER FOR MODEL VEHICLES AND ROBOTS, RADIO FREQUENCY TRANSMITTER MODULES, AM AND FM RECEIVERS, ELECTRONIC SERVO CONTROLS, SERVO MOTORS, ELECTRICAL ON/OFF SWITCHES, AND CHARGER FOR RADIO CONTROL SYSTEMS; AND ROBOTS FOR PERSONAL OR HOBBY USE (U.S. CLS. 21, 23, 26, 36 AND 38).

FIRST USE 8-1-2005; IN COMMERCE 1-1-2006.

ALICE BENMAMAN, EXAMINING ATTORNEY

CLASS 9—(Continued).

SN 78-863,126. SKEEM, WAYNE, TWIN FALLS, ID. FILED 4-17-2006.

SOS

THE MARK CONSISTS OF STANDARD CHARACTERS WITHOUT CLAIM TO ANY PARTICULAR FONT, STYLE, SIZE, OR COLOR.

FOR ELECTRIC OR ELECTRONIC SENSORS FOR RECEIVING SIGNALS FOR THE PURPOSE OF PROVIDING ACCESS THROUGH A GATE OR OTHER PASSAGEWAY (U.S. CLS. 21, 23, 26, 36 AND 38).

FIRST USE 2-0-1989; IN COMMERCE 2-0-1989.

ANDREA SAUNDERS, EXAMINING ATTORNEY

SN 78-863,157. BODY HOOPS, LLC, OJAI, CA. FILED 4-17-2006.

BODYHOOPS

THE MARK CONSISTS OF STANDARD CHARACTERS WITHOUT CLAIM TO ANY PARTICULAR FONT, STYLE, SIZE, OR COLOR.

FOR PRE-RECORDED VIDEO TAPES AND DVDS FEATURING PHYSICAL EXERCISE INSTRUCTION (U.S. CLS. 21, 23, 26, 36 AND 38).

FIRST USE 4-15-2005; IN COMMERCE 4-15-2005.

WON TEAK OH, EXAMINING ATTORNEY

SN 78-863,190. MICROSOFT CORPORATION, REDMOND, WA. FILED 4-17-2006.

WINDOWS RALLY

THE MARK CONSISTS OF STANDARD CHARACTERS WITHOUT CLAIM TO ANY PARTICULAR FONT, STYLE, SIZE, OR COLOR.

OWNER OF U.S. REG. NOS. 1,872,264 AND 2,513,051.
FOR OPERATING SYSTEM SOFTWARE AND UTILITIES; COMPUTER SOFTWARE FOR MANAGING NETWORK COMMUNICATIONS; COMPUTER SOFTWARE FOR CONNECTING COMPUTERS, COMPUTER PERIPHERALS, DIGITAL CAMERAS, CELL PHONES AND SOFTWARE APPLICATION PROGRAMS TO COMPUTER NETWORKS; AND COMPUTER SOFTWARE FOR MANAGING POWER SUPPLIES FOR COMPUTERS (U.S. CLS. 21, 23, 26, 36 AND 38).

DAVID ELTON, EXAMINING ATTORNEY

CLASS 9—(Continued).

SN 78-863,192. MICROSOFT CORPORATION, REDMOND, WA. FILED 4-17-2006.

RALLY

THE MARK CONSISTS OF STANDARD CHARACTERS WITHOUT CLAIM TO ANY PARTICULAR FONT, STYLE, SIZE, OR COLOR.

FOR OPERATING SYSTEM SOFTWARE AND UTILITIES; COMPUTER SOFTWARE FOR MANAGING NETWORK COMMUNICATIONS; COMPUTER SOFTWARE FOR CONNECTING COMPUTERS, COMPUTER PERIPHERALS, DIGITAL CAMERAS, CELL PHONES AND SOFTWARE APPLICATION PROGRAMS TO COMPUTER NETWORKS; AND COMPUTER SOFTWARE FOR MANAGING POWER SUPPLIES FOR COMPUTERS (U.S. CLS. 21, 23, 26, 36 AND 38).

DAVID ELTON, EXAMINING ATTORNEY

SN 78-863,391. SKURO, JOHN M., VIRGINIA BEACH, VA. FILED 4-18-2006.

REVERIE

THE MARK CONSISTS OF STANDARD CHARACTERS WITHOUT CLAIM TO ANY PARTICULAR FONT, STYLE, SIZE, OR COLOR.

FOR EYEGLASSES OF ALL TYPES, EYEGLASS FRAMES, EYEGLASS LENSES, EYEGLASS CASES AND EYEGLASS RETAINER STRAPS (U.S. CLS. 21, 23, 26, 36 AND 38).

SHARON MEIER, EXAMINING ATTORNEY

SN 78-863,595. HME, INCORPORATED, WYOMING, MI. FILED 4-18-2006.

Spectr

THE MARK CONSISTS OF STANDARD CHARACTERS WITHOUT CLAIM TO ANY PARTICULAR FONT, STYLE, SIZE, OR COLOR.

FOR FIRE TRUCKS (U.S. CLS. 21, 23, 26, 36 AND 38). MARK SPARACINO, EXAMINING ATTORNEY

CLASS 9—(Continued).

SN 78-863,692. NET IRRIGATE, LLC, BLOOMINGTON, IN. FILED 4-18-2006.

NetIrrigate

THE MARK CONSISTS OF STANDARD CHARACTERS WITHOUT CLAIM TO ANY PARTICULAR FONT, STYLE, SIZE, OR COLOR.

FOR ELECTRICAL CONTROLS FOR IRRIGATION SPRINKLER SYSTEMS (U.S. CLS. 21, 23, 26, 36 AND 38). MONIQUE MILLER, EXAMINING ATTORNEY

SN 78-863,945. NSI AUDIO INC, SAN JOSE, CA. FILED 4-18-2006.

AudioBank

THE MARK CONSISTS OF STANDARD CHARACTERS WITHOUT CLAIM TO ANY PARTICULAR FONT, STYLE, SIZE, OR COLOR.

FOR AUDIO EQUIPMENT FOR VEHICLES, NAMELY, STEREOs, SPEAKERS, AMPLIFIERS, EQUALIZERS, CROSSOVERS AND SPEAKER HOUSINGS (U.S. CLS. 21, 23, 26, 36 AND 38).

CAROLYN CATALDO, EXAMINING ATTORNEY

SN 78-863,961. FAN, YANG, DIAMOND BAR, CA. FILED 4-18-2006.

TASE

THE MARK CONSISTS OF STANDARD CHARACTERS WITHOUT CLAIM TO ANY PARTICULAR FONT, STYLE, SIZE, OR COLOR.

FOR AUDIO EQUIPMENT FOR VEHICLES, NAMELY, STEREOs, SPEAKERS, AMPLIFIERS, EQUALIZERS, CROSSOVERS AND SPEAKER HOUSINGS; AUDIO SPEAKER ENCLOSURES; AUDIO SPEAKERS; MICROPHONES (U.S. CLS. 21, 23, 26, 36 AND 38).

FIRST USE 12-1-2005; IN COMMERCE 12-1-2005. FRED MANDIR, EXAMINING ATTORNEY

CLASS 9—(Continued).

SN 78-864,022. NSI AUDIO INC, SAN JOSE, CA. FILED 4-18-2006.

AudioTek

THE MARK CONSISTS OF STANDARD CHARACTERS WITHOUT CLAIM TO ANY PARTICULAR FONT, STYLE, SIZE, OR COLOR.

FOR AUDIO EQUIPMENT FOR VEHICLES, NAMELY, STEREOs, SPEAKERS, AMPLIFIERS, EQUALIZERS, CROSSOVERS AND SPEAKER HOUSINGS (U.S. CLS. 21, 23, 26, 36 AND 38).

CAROLYN CATALDO, EXAMINING ATTORNEY

CLASS 9—(Continued).

SN 78-864,435. BATRONIC INVESTMENTS, LLC, BRANFORD, CT. FILED 4-19-2006.

Batrow

THE MARK CONSISTS OF STANDARD CHARACTERS WITHOUT CLAIM TO ANY PARTICULAR FONT, STYLE, SIZE, OR COLOR.

THE NAME(S), PORTRAIT(S), AND/OR SIGNATURE(S) SHOWN IN THE MARK IDENTIFIES ALICE BATROW, WHOSE CONSENT(S) TO REGISTER IS SUBMITTED.

FOR CONTROLLED TIMERS (U.S. CLS. 21, 23, 26, 36 AND 38).

FIRST USE 4-1-1979; IN COMMERCE 4-1-1979.
BRIDGETT SMITH, EXAMINING ATTORNEY

SN 78-864,069. MONSTER CABLE PRODUCTS, INC., BRISBANE, CA. FILED 4-18-2006.

ILLUMINESSENCE

THE MARK CONSISTS OF STANDARD CHARACTERS WITHOUT CLAIM TO ANY PARTICULAR FONT, STYLE, SIZE, OR COLOR.

FOR REMOTE CONTROLS FOR LIGHTING, TELEPHONE, HEATING, VENTILATION, AIR CONDITIONING, GAMING, COMPUTER, AUDIO, AND VIDEO DEVICES (U.S. CLS. 21, 23, 26, 36 AND 38).

ODESSA BIBBINS, EXAMINING ATTORNEY

SN 78-864,749. TRUPOWER LLC, ALEDO, TX. FILED 4-19-2006.

Battery Maximizer

THE MARK CONSISTS OF STANDARD CHARACTERS WITHOUT CLAIM TO ANY PARTICULAR FONT, STYLE, SIZE, OR COLOR.

NO CLAIM IS MADE TO THE EXCLUSIVE RIGHT TO USE "BATTERY", APART FROM THE MARK AS SHOWN.

FOR BATTERY CHARGERS (U.S. CLS. 21, 23, 26, 36 AND 38).

GILBERT SWIFT, EXAMINING ATTORNEY

SN 78-864,146. NYC EYEWEAR, PARSIPPANY, NJ. FILED 4-18-2006.



NO CLAIM IS MADE TO THE EXCLUSIVE RIGHT TO USE NYC EYEWEAR, APART FROM THE MARK AS SHOWN.

THE MARK CONSISTS OF WORDS IN OVAL.

FOR SUNGLASSES (U.S. CLS. 21, 23, 26, 36 AND 38).
AMOS T. MATTHEWS, JR., EXAMINING ATTORNEY

SN 78-864,784. HEALTHSIMPLE TOOLS, LLC, MINNEAPOLIS, MN. FILED 4-19-2006.

HEALTHSIMPLE

THE MARK CONSISTS OF STANDARD CHARACTERS WITHOUT CLAIM TO ANY PARTICULAR FONT, STYLE, SIZE, OR COLOR.

FOR PRE-RECORDED VIDEOS AND AUDIOTAPES AND COMPUTER GAME SOFTWARE, ALL IN CONNECTION WITH HEALTH EDUCATION AND LIFESTYLE MANAGEMENT (U.S. CLS. 21, 23, 26, 36 AND 38).

RUDY R. SINGLETON, EXAMINING ATTORNEY

CLASS 9—(Continued).

SN 78-864,826. MASTERLINK CORPORATION, ORLANDO, FL. FILED 4-19-2006.

ZERO NEGLECT

THE MARK CONSISTS OF STANDARD CHARACTERS WITHOUT CLAIM TO ANY PARTICULAR FONT, STYLE, SIZE, OR COLOR.

FOR COMPUTER SOFTWARE FOR WORK MANAGEMENT, NAMELY, SCHEDULING WORKERS TO PERFORM TASKS, TRACKING WORK AS IT OCCURS, ANALYSIS OF WORK TASKS, RECORDING COSTS AND SIMULATING THE POTENTIAL EFFECT ON THE MANPOWER AND MATERIALS OF FUTURE CHANGES IN OPERATING POLICY AND ENVIRONMENT (U.S. CLS. 21, 23, 26, 36 AND 38).

MATTHEW MCDOWELL, EXAMINING ATTORNEY

SN 78-864,850. L.R. NELSON CORPORATION, PEORIA, IL. FILED 4-19-2006.

REMOTE RAIN

THE MARK CONSISTS OF STANDARD CHARACTERS WITHOUT CLAIM TO ANY PARTICULAR FONT, STYLE, SIZE, OR COLOR.

FOR REMOTE CONTROL HOSE ON/OFF VALVES (U.S. CLS. 21, 23, 26, 36 AND 38).

MARTHA SANTOMARTINO, EXAMINING ATTORNEY

SN 78-864,947. XCPT COMMUNICATION TECHNOLOGIES, LLC, VENICE, FL. FILED 4-19-2006.

XPARENCY

THE MARK CONSISTS OF STANDARD CHARACTERS WITHOUT CLAIM TO ANY PARTICULAR FONT, STYLE, SIZE, OR COLOR.

FOR COMPUTER SOFTWARE USED TO MANAGE, RENDER, INTERPRET, ENHANCE AND PROCESS PICTURES, X-RAYS, IMAGES AND DIGITAL CONTENT IN THE FIELD OF DENTISTRY FOR DIAGNOSIS AND TREATMENT (U.S. CLS. 21, 23, 26, 36 AND 38).

LEIGH LOWRY, EXAMINING ATTORNEY

CLASS 9—(Continued).

SN 78-864,950. DIRECTV, INC., EL SEGUNDO, CA. FILED 4-19-2006.

GET THE BEST

THE MARK CONSISTS OF STANDARD CHARACTERS WITHOUT CLAIM TO ANY PARTICULAR FONT, STYLE, SIZE, OR COLOR.

FOR ANTENNAS; ANTENNAS FOR WIRELESS COMMUNICATIONS APPARATUS; APPARATUS FOR RECORDING, TRANSMISSION OR REPRODUCTION OF SOUND AND IMAGES; AUDIOVISUAL RECEIVERS; BATTERY CHARGERS; BATTERY PACKS; CABLES FOR ELECTRICAL AND OPTICAL SIGNAL TRANSMISSION SYSTEMS; CABLES FOR ELECTRICAL OR OPTICAL SIGNAL TRANSMISSION; COAXIAL CABLES; COMPUTER GAME SOFTWARE; COMPUTER SOFTWARE FOR COMMUNICATING WITH USERS OF HAND-HELD COMPUTERS; DECODER SOFTWARE; DOWNLOADABLE FILMS AND TV PROGRAMS PROVIDED VIA A VIDEO-ON-DEMAND; ELECTRICAL CELLS AND BATTERIES; ELECTRONIC COMBINERS FOR CONNECTING ANTENNAS AND RECEIVERS; ELECTRONIC GAME SOFTWARE FOR HANDHELD ELECTRONIC DEVICES; HANDHELD COMPUTERS; INTEGRATED CIRCUIT MODULES; LAPTOP CARRYING CASES; LAPTOP COMPUTERS; MULTIPLEXERS; RECEIVERS FOR SATELLITES; REMOTE CONTROLS FOR SET-TOP BOX; SATELLITE AND MICROWAVE COMMUNICATIONS APPARATUS TO TRANSMIT COMMUNICATIONS FROM A VEHICLE TO ANOTHER VEHICLE, OR FROM A VEHICLE TO A SATELLITE; SATELLITE DISHES; SATELLITE DISHES FOR SATELLITE TRANSMISSIONS; SATELLITE RECEIVERS; SET-TOP BOXES; SPECIALTY HOLSTER FOR CARRYING HAND HELD COMPUTER UNITS; TELECOMMUNICATION CABLES; TELECOMMUNICATIONS TRANSMITTERS; TELEVISION ANTENNAS; TELEVISION DECODER; VIDEO PROJECTORS; VIDEO TRANSMISSION APPARATUS (U.S. CLS. 21, 23, 26, 36 AND 38).

NORA BUCHANAN WILL, EXAMINING ATTORNEY

SN 78-864,996. XCPT COMMUNICATION TECHNOLOGIES, LLC, VENICE, FL. FILED 4-19-2006.

LOOK BY XCPT

THE MARK CONSISTS OF STANDARD CHARACTERS WITHOUT CLAIM TO ANY PARTICULAR FONT, STYLE, SIZE, OR COLOR.

FOR COMPUTER SOFTWARE USED TO MANAGE, RENDER, INTERPRET, ENHANCE AND PROCESS PICTURES, X-RAYS, IMAGES AND DIGITAL CONTENT IN THE FIELD OF DENTISTRY FOR DIAGNOSIS AND TREATMENT (U.S. CLS. 21, 23, 26, 36 AND 38).

LEIGH LOWRY, EXAMINING ATTORNEY

CLASS 9—(Continued).

SN 78-865,026. THE MCGRAW-HILL COMPANIES, INC., NEW YORK, NY. FILED 4-19-2006.

EVERYDAY MATHEMATICS

THE MARK CONSISTS OF STANDARD CHARACTERS WITHOUT CLAIM TO ANY PARTICULAR FONT, STYLE, SIZE, OR COLOR.

OWNER OF U.S. REG. NOS. 1,944,182 AND 2,970,223.

NO CLAIM IS MADE TO THE EXCLUSIVE RIGHT TO USE "MATHEMATICS", APART FROM THE MARK AS SHOWN.

FOR CD-ROM FEATURING EDUCATIONAL MATERIAL ON MATHEMATICS, FOR USE WITH MATHEMATICS CURRICULA (U.S. CLS. 21, 23, 26, 36 AND 38).

FIRST USE 1-10-2003; IN COMMERCE 1-10-2003.

JEFF DEFORD, EXAMINING ATTORNEY

SN 78-865,084. AMBIR TECHNOLOGY, INC., ELMHURST, IL. FILED 4-19-2006.

DOCUSTART

THE MARK CONSISTS OF STANDARD CHARACTERS WITHOUT CLAIM TO ANY PARTICULAR FONT, STYLE, SIZE, OR COLOR.

FOR COMPUTER SOFTWARE FOR USE IN DOCUMENT MANAGEMENT, SCANNING, AND ELECTRONIC SIGNATURE CAPTURE (U.S. CLS. 21, 23, 26, 36 AND 38).

PAULA MAYS, EXAMINING ATTORNEY

SN 78-865,094. SAV-A-LIFE INDUSTRIES, LTD, NEW YORK, NY. FILED 4-19-2006.



THE COLOR(S) BLACK AND YELLOW IS/ARE CLAIMED AS A FEATURE OF THE MARK.

THE COLOR(S) APPEAR IN THE MARK AS FOLLOWS – THE MARK CONSISTS OF A FANCIFUL DEPICTION OF A BLACK DEER AND AN APPROACHING YELLOW AUTOMOBILE. THE DEPICTION OF ULTRASONIC WAVES IS ALTERNATING BLACK AND YELLOW STRIPES. THE WORDING "SAV-A-LIFE" IS YELLOW.

FOR ELECTRONIC ULTRASONIC SOUND EMITTING APPARATUS USED BY MOTORISTS TO WARN APPROACHING ANIMALS (U.S. CLS. 21, 23, 26, 36 AND 38).

FIRST USE 1-1-1985; IN COMMERCE 1-1-1985.

GINA FINK, EXAMINING ATTORNEY

CLASS 9—(Continued).

SN 78-865,110. HUTSON, FREDERICK, LAS VEGAS, NV. FILED 4-19-2006.

Affiliated Records

THE MARK CONSISTS OF STANDARD CHARACTERS WITHOUT CLAIM TO ANY PARTICULAR FONT, STYLE, SIZE, OR COLOR.

NO CLAIM IS MADE TO THE EXCLUSIVE RIGHT TO USE "RECORDS", APART FROM THE MARK AS SHOWN.

FOR SOUND AND AUDIOVISUAL RECORDINGS FEATURING MUSIC, NAMELY, PHONOGRAPH RECORDS, PRE-RECORDED AUDIO TAPES, COMPACT DISCS, PRE-RECORDED VIDEOTAPES, DOWNLOADABLE MUSIC FILES, AND DVDS (U.S. CLS. 21, 23, 26, 36 AND 38).

STANLEY I. OSBORNE, EXAMINING ATTORNEY

SN 78-865,347. ROLDAN, SEAN, HOLLYWOOD, CA. AND BAKER, GEORGE C., III, ONTARIO, CA. FILED 4-19-2006.

THE PRIVATEER

THE MARK CONSISTS OF STANDARD CHARACTERS WITHOUT CLAIM TO ANY PARTICULAR FONT, STYLE, SIZE, OR COLOR.

FOR SERIES OF PRE-RECORDED MOTION PICTURE FILMS, AND PRE-RECORDED VIDEO TAPES, VIDEO CASSETTES, CD-ROMS, DVDS, AND COMPACT DISCS, ALL FEATURING ENTERTAINMENT RELATED TO FILMS (U.S. CLS. 21, 23, 26, 36 AND 38).

ARETHA SOMERVILLE, EXAMINING ATTORNEY

SN 78-865,350. ROLDAN, SEAN, HOLLYWOOD, CA. AND BAKER, GEORGE C. III, ONTARIO, CA. FILED 4-19-2006.

THE MAKING OF A CHAMPION

THE MARK CONSISTS OF STANDARD CHARACTERS WITHOUT CLAIM TO ANY PARTICULAR FONT, STYLE, SIZE, OR COLOR.

FOR SERIES OF PRE-RECORDED MOTION PICTURE FILMS, AND PRE-RECORDED VIDEO TAPES, VIDEO CASSETTES, CD-ROMS, DVDS, AND COMPACT DISCS, ALL FEATURING ENTERTAINMENT RELATED TO FILMS (U.S. CLS. 21, 23, 26, 36 AND 38).

ARETHA SOMERVILLE, EXAMINING ATTORNEY

CLASS 9—(Continued).

SN 78-865,605. RWD TECHNOLOGIES, INC., BALTIMORE, MD. FILED 4-20-2006.

EPOST

THE MARK CONSISTS OF STANDARD CHARACTERS WITHOUT CLAIM TO ANY PARTICULAR FONT, STYLE, SIZE, OR COLOR.

OWNER OF U.S. REG. NO. 2,527,725.
FOR COMPUTER SOFTWARE FOR RAPID DEVELOPMENT, EDITING AND DISTRIBUTION OF ELECTRONIC LEARNING COURSEWARE, STANDARD OPERATING PROCEDURES, STANDARD WORK INSTRUCTIONS AND USER INFORMATION MANUALS VIA ELECTRONIC COMMUNICATIONS NETWORKS (U.S. CLS. 21, 23, 26, 36 AND 38).

EVELYN BRADLEY, EXAMINING ATTORNEY

CLASS 9—(Continued).

SN 78-865,763. SCOTT TECHNOLOGIES, INC., BOCA RATON, FL. FILED 4-20-2006.

SA2000

THE MARK CONSISTS OF STANDARD CHARACTERS WITHOUT CLAIM TO ANY PARTICULAR FONT, STYLE, SIZE, OR COLOR.

FOR PORTABLE GAS SAFETY DETECTORS USED FOR DETECTING AND STORING OXYGEN AND TOXIC GAS MEASUREMENTS (U.S. CLS. 21, 23, 26, 36 AND 38).

FIRST USE 7-0-1996; IN COMMERCE 7-0-1996.
KIMBERLY FRYE, EXAMINING ATTORNEY

SN 78-865,607. RWD TECHNOLOGIES, INC., BALTIMORE, MD. FILED 4-20-2006.



OWNER OF U.S. REG. NO. 2,527,725.
FOR COMPUTER SOFTWARE FOR RAPID DEVELOPMENT, EDITING AND DISTRIBUTION OF ELECTRONIC LEARNING COURSEWARE, STANDARD OPERATING PROCEDURES, STANDARD WORK INSTRUCTIONS AND USER INFORMATION MANUALS VIA ELECTRONIC COMMUNICATIONS NETWORKS (U.S. CLS. 21, 23, 26, 36 AND 38).

EVELYN BRADLEY, EXAMINING ATTORNEY

SN 78-865,847. SHORHOUSE, TODD RICHARD, ALTAMONTE SPRINGS, FL. FILED 4-20-2006.



THE COLOR(S) BLUE, BLACK, YELLOW, GREEN AND RED IS/ARE CLAIMED AS A FEATURE OF THE MARK.

THE CAP, THE WORD "VIDEODIPLOMA" AND THE STARS ARE IN BLUE, THE OVAL SHAPE SURROUNDING THE CAP IS YELLOW, THE OUTLINES ON THE CAP ARE BLACK AND GREEN AND THE SPIKES AND THE TASSEL ARE IN RED.

FOR DIGITAL PHOTO FRAMES FOR DISPLAYING DIGITAL PICTURES, VIDEO CLIPS AND MUSIC (U.S. CLS. 21, 23, 26, 36 AND 38).

JENNY PARK, EXAMINING ATTORNEY

SN 78-865,624. TRANSILIENT MEDIA, INC., ROLLING HILLS ESTATES, CA. FILED 4-20-2006.



THE MARK CONSISTS OF A CROWD OF PEOPLE WITH THE TEXT CROWDRULES OVER IT.

FOR COMPUTER SOFTWARE FOR CONDUCTING CONTESTS (U.S. CLS. 21, 23, 26, 36 AND 38).

COLLEEN DOMBROW, EXAMINING ATTORNEY

SN 78-865,848. IDEAZON, INC., MINNEAPOLIS, MN. FILED 4-20-2006.

MERC

THE MARK CONSISTS OF STANDARD CHARACTERS WITHOUT CLAIM TO ANY PARTICULAR FONT, STYLE, SIZE, OR COLOR.

FOR COMPUTER KEYBOARDS (U.S. CLS. 21, 23, 26, 36 AND 38).

FIRST USE 2-6-2006; IN COMMERCE 2-6-2006.

MICHAEL SOUDERS, EXAMINING ATTORNEY

CLASS 9—(Continued).

SN 78-865,964. EXCEL TECHNOLOGIES, INC., ENFIELD, CT. FILED 4-20-2006.



OWNER OF U.S. REG. NO. 1,200,943.
NO CLAIM IS MADE TO THE EXCLUSIVE RIGHT TO USE TECHNOLOGIES, INC., APART FROM THE MARK AS SHOWN.

FOR OPTICAL AND METALLURGICAL LABORATORY EQUIPMENT—NAMELY, MICROSCOPES AND PARTS THEREFOR (U.S. CLS. 21, 23, 26, 36 AND 38).

JOHN E. MICHOS, EXAMINING ATTORNEY

SN 78-866,015. DIRECTV, INC., EL SEGUNDO, CA. FILED 4-20-2006.

TURN ON THE BEST

THE MARK CONSISTS OF STANDARD CHARACTERS WITHOUT CLAIM TO ANY PARTICULAR FONT, STYLE, SIZE, OR COLOR.

FOR ANTENNAS; ANTENNAS FOR WIRELESS COMMUNICATIONS APPARATUS; APPARATUS FOR RECORDING, TRANSMISSION OR REPRODUCTION OF SOUND AND IMAGES; AUDIOVISUAL RECEIVERS; BATTERY CHARGERS; BATTERY PACKS; CABLES FOR ELECTRICAL AND OPTICAL SIGNAL TRANSMISSION SYSTEMS; CABLES FOR ELECTRICAL OR OPTICAL SIGNAL TRANSMISSION; COAXIAL CABLES; COMPUTER GAME SOFTWARE; COMPUTER SOFTWARE FOR COMMUNICATING WITH USERS OF HAND-HELD COMPUTERS; DECODER SOFTWARE; DOWNLOADABLE FILMS AND TV PROGRAMS PROVIDED VIA A VIDEO-ON-DEMAND; ELECTRICAL CELLS AND BATTERIES; ELECTRONIC COMBINERS FOR CONNECTING ANTENNAS AND RECEIVERS; ELECTRONIC GAME SOFTWARE FOR HANDHELD ELECTRONIC DEVICES; HANDHELD COMPUTERS; INTEGRATED CIRCUIT MODULES; LAPTOP CARRYING CASES; LAPTOP COMPUTERS; MULTIPLEXERS; RECEIVERS FOR SATELLITES; REMOTE CONTROLS FOR SET-TOP BOX; SATELLITE AND MICROWAVE COMMUNICATIONS APPARATUS TO TRANSMIT COMMUNICATIONS FROM A VEHICLE TO ANOTHER VEHICLE, OR FROM A VEHICLE TO A SATELLITE; SATELLITE DISHES; SATELLITE DISHES FOR SATELLITE TRANSMISSIONS; SATELLITE RECEIVERS; SET-TOP BOXES; SPECIALTY HOLSTER FOR CARRYING HAND HELD COMPUTER UNITS; TELECOMMUNICATION CABLES; TELECOMMUNICATIONS TRANSMITTERS; TELEVISION ANTENNAS; TELEVISION DECODER; VIDEO PROJECTORS; VIDEO TRANSMISSION APPARATUS (U.S. CLS. 21, 23, 26, 36 AND 38).

NORA BUCHANAN WILL, EXAMINING ATTORNEY

CLASS 9—(Continued).

SN 78-866,078. SHARING WORLD ENTERTAINMENT, NEW YORK, NY. FILED 4-20-2006.

EDVD

THE MARK CONSISTS OF STANDARD CHARACTERS WITHOUT CLAIM TO ANY PARTICULAR FONT, STYLE, SIZE, OR COLOR.

FOR CHILDREN'S EDUCATIONAL MUSIC CDS AND DVDS; CHILDREN'S EDUCATIONAL SOFTWARE; EDUCATIONAL SOFTWARE FEATURING INSTRUCTION IN INITIAL READING PROFICIENCY, LITERACY ENHANCEMENT, VOCABULARY, COMPREHENSION AND HUMAN UNDERSTANDING (U.S. CLS. 21, 23, 26, 36 AND 38).

AISHA CLARKE, EXAMINING ATTORNEY

SN 78-866,297. MENDOZA, OSCAR, ARLETA, CA. FILED 4-20-2006.



THE MARK CONSISTS OF BLACK BACKGROUND WITH DESIGN TEXT OF NEZZLEE IN WHITE.

FOR PRE-RECORDED CD'S, VIDEO TAPES, LASER DISKS AND DVD'S FEATURING MUSIC (U.S. CLS. 21, 23, 26, 36 AND 38).

LEIGH CAROLINE CASE, EXAMINING ATTORNEY

SN 78-866,301. AMALGAM SOLID LLC, LOS ANGELES, CA. FILED 4-20-2006.

Replug

THE MARK CONSISTS OF STANDARD CHARACTERS WITHOUT CLAIM TO ANY PARTICULAR FONT, STYLE, SIZE, OR COLOR.

FOR ADAPTER PLUGS, ADAPTERS ELECTRICITY, CABLE CONNECTORS, ELECTRIC CONNECTORS, ELECTRICAL CONNECTORS, INSULATED ELECTRICAL CONNECTORS, PLUG CONNECTORS, PLUG-IN CONNECTORS, ROUND PLUG CONNECTORS, THREADED CABLE CONNECTORS OF METAL, CABLE CONNECTORS, COMPUTER CABLES, CONNECTING ELECTRICAL CABLES, CONNECTION CABLES, ELECTRIC CABLES, ELECTRIC WIRE AND CABLE, ELECTRIC WIRES AND CABLES, ELECTRICAL CABLES, ELECTRONIC CABLES, EXTENSION CABLES, POWER CABLES, STEREO CABLES, ELECTRICAL RECEPTACLES, EXTENSION CORDS, EXTENSION CORDS, ELECTRIC CORDS (U.S. CLS. 21, 23, 26, 36 AND 38).

KYLE PEETE, EXAMINING ATTORNEY

CLASS 9—(Continued).

SN 78-866,326. SEANOVA, NUUFOLAU JOEL, BEVERLY HILLS, CA. FILED 4-20-2006.

SAMOA JOE

THE MARK CONSISTS OF STANDARD CHARACTERS WITHOUT CLAIM TO ANY PARTICULAR FONT, STYLE, SIZE, OR COLOR.

THE NAME SAMOA JOE IDENTIFIES A LIVING INDIVIDUAL WHOSE CONSENT IS OF RECORD.

FOR MULTIMEDIA SOFTWARE RECORDED ON CD-ROM FEATURING GAMES RELATED TO PROFESSIONAL WRESTLING; PRE-RECORDED CDS, VIDEO TAPES, LASER DISKS AND DVDS FEATURING WRESTLING EXHIBITS AND PERFORMANCES BY A PROFESSIONAL WRESTLER (U.S. CLS. 21, 23, 26, 36 AND 38).

FIRST USE 6-30-2000; IN COMMERCE 6-30-2000.
ELIZABETH PIGNATELLO, EXAMINING ATTORNEY

SN 78-866,327. NARTRON CORPORATION, REED CITY, MI. FILED 4-20-2006.

SIR GALAHAD

THE MARK CONSISTS OF STANDARD CHARACTERS WITHOUT CLAIM TO ANY PARTICULAR FONT, STYLE, SIZE, OR COLOR.

FOR ELECTRICAL CIRCUITRY FOR USE IN VEHICLES WITH POWER WINDOWS FOR REVERSING POWER WINDOW MOTOR UPON SENSING PRESENCE OF AN OBJECT IN THE PATH OF THE POWER WINDOW (U.S. CLS. 21, 23, 26, 36 AND 38).

ELIZABETH PIGNATELLO, EXAMINING ATTORNEY

SN 78-866,342. JORDAN OUTDOOR ENTERPRISES, LTD., COLUMBUS, GA. FILED 4-20-2006.

THE BEST OF MONSTER BUCKS BOWHUNTING

THE MARK CONSISTS OF STANDARD CHARACTERS WITHOUT CLAIM TO ANY PARTICULAR FONT, STYLE, SIZE, OR COLOR.

OWNER OF U.S. REG. NO. 2,176,279.

NO CLAIM IS MADE TO THE EXCLUSIVE RIGHT TO USE "BEST OF" AND "BOWHUNTING", APART FROM THE MARK AS SHOWN.

FOR SERIES OF PRE-RECORDED VIDEOS FEATURING GAME HUNTING (U.S. CLS. 21, 23, 26, 36 AND 38).
TARAH HARDY, EXAMINING ATTORNEY

CLASS 9—(Continued).

SN 78-866,344. JORDAN OUTDOOR ENTERPRISES, LTD., COLUMBUS, GA. FILED 4-20-2006.

THE BEST OF REALTREE'S BIG GAME HUNTING

THE MARK CONSISTS OF STANDARD CHARACTERS WITHOUT CLAIM TO ANY PARTICULAR FONT, STYLE, SIZE, OR COLOR.

OWNER OF U.S. REG. NOS. 1,736,108, 1,957,418 AND 2,146,099.

NO CLAIM IS MADE TO THE EXCLUSIVE RIGHT TO USE "BEST OF" AND "BIG GAME HUNTING", APART FROM THE MARK AS SHOWN.

FOR SERIES OF PRE-RECORDED VIDEOS FEATURING GAME HUNTING (U.S. CLS. 21, 23, 26, 36 AND 38).
TARAH HARDY, EXAMINING ATTORNEY

SN 78-866,437. MODERN TRANSPORT SYSTEMS CORP., WESTLAKE VILLAGE, CA. FILED 4-21-2006.

MagneGlide

THE MARK CONSISTS OF STANDARD CHARACTERS WITHOUT CLAIM TO ANY PARTICULAR FONT, STYLE, SIZE, OR COLOR.

FOR MAGNETIC DEVICE USED TO SUPPORT AND SUSPEND SLIDING OBJECTS SUCH AS SLIDING DOORS AND GATES (U.S. CLS. 21, 23, 26, 36 AND 38).

FIRST USE 3-1-2006; IN COMMERCE 3-1-2006.
ANDREA SAUNDERS, EXAMINING ATTORNEY

SN 78-866,492. COMMSCOPE PROPERTIES, LLC, HICKORY, NC. FILED 4-21-2006.

WHAT TECHNOLOGY MAKES POSSIBLE, COMMSCOPE MAKES A REALITY

THE MARK CONSISTS OF STANDARD CHARACTERS WITHOUT CLAIM TO ANY PARTICULAR FONT, STYLE, SIZE, OR COLOR.

OWNER OF U.S. REG. NOS. 898,651, 3,124,082 AND OTHERS.

FOR COMMUNICATIONS CABLE, NAMELY COAXIAL CABLE, FIBER OPTIC CABLE, TWISTED PAIR CABLE AND HYBRIDS THEREOF, AND CONNECTORS THEREFOR; ELECTRIC WIRES IN THE NATURE OF PATCH CORDS, FIBER OPTIC INTERCONNECTION CABLES; TELECOMMUNICATIONS CONNECTORS, PLUGS, JACKS AND CONNECTING BLOCKS; TELECOMMUNICATIONS DEVICES THAT REPEAT, RESHAPE OR REFORMATS SIGNALS FROM DATA TERMINALS AND CONTROLLERS; TELECOMMUNICATIONS BRACKETS, CLIPS AND CLAMPS TO HOUSE AND SUPPORT CABLE AND TELECOMMUNICATIONS EQUIPMENT ALL DISTRIBUTED AS A UNIT (U.S. CLS. 21, 23, 26, 36 AND 38).

STEVEN PEREZ, EXAMINING ATTORNEY

CLASS 9—(Continued).

SN 78-866,659. CORE PRACTICE SOLUTIONS LLC, ATLANTA, GA. FILED 4-21-2006.

CoRemEDI

FOR COMPUTER SOFTWARE FOR PROCESSING, RECONCILING, AND AUTOMATED UPDATING OF MEDICAL OFFICE BILLING, REMITTANCE, AND PAYMENT INFORMATION (U.S. CLS. 21, 23, 26, 36 AND 38).
JACQUELINE A. LAVINE, EXAMINING ATTORNEY

SN 78-867,007. ROBOMATTER, INC., PITTSBURGH, PA. FILED 4-21-2006.

ROBOTC

THE MARK CONSISTS OF STANDARD CHARACTERS WITHOUT CLAIM TO ANY PARTICULAR FONT, STYLE, SIZE, OR COLOR.
FOR COMPUTER SOFTWARE FOR OPERATING EDUCATIONAL MOBILE ROBOTS (U.S. CLS. 21, 23, 26, 36 AND 38).
JOHN GARTNER, EXAMINING ATTORNEY

SN 78-867,126. ISYS AUTOMATION, INC., SAN DIEGO, CA. FILED 4-21-2006.

BACpod

THE MARK CONSISTS OF STANDARD CHARACTERS WITHOUT CLAIM TO ANY PARTICULAR FONT, STYLE, SIZE, OR COLOR.
FOR COMPUTER PROGRAMS FOR REMOTE MONITORING AND CONTROL OF NETWORK DATA AND EQUIPMENT VIA ANY HANDHELD MICROPROCESSOR BASED DEVICE, NAMELY A CELLPHONE OR PDA (U.S. CLS. 21, 23, 26, 36 AND 38).
DAVID MILLER, EXAMINING ATTORNEY

CLASS 9—(Continued).

SN 78-867,141. RAWLINGS SPORTING GOODS COMPANY, INC., ALBANY, NY. FILED 4-21-2006.

IDENTITY

THE MARK CONSISTS OF STANDARD CHARACTERS WITHOUT CLAIM TO ANY PARTICULAR FONT, STYLE, SIZE, OR COLOR.
FOR HELMETS FOR THE SPORT OF LACROSSE (U.S. CLS. 21, 23, 26, 36 AND 38).
SHARON MEIER, EXAMINING ATTORNEY

SN 78-867,152. TEKTRONIX, INC., BEAVERTON, OR. FILED 4-21-2006.

CERIFY

THE MARK CONSISTS OF STANDARD CHARACTERS WITHOUT CLAIM TO ANY PARTICULAR FONT, STYLE, SIZE, OR COLOR.
FOR COMPUTER SOFTWARE FOR DIGITAL VIDEO CONTENT TESTING AND VERIFICATION, AND COMPUTER HARDWARE FOR USE WITH SUCH SOFTWARE (U.S. CLS. 21, 23, 26, 36 AND 38).
SHARON MEIER, EXAMINING ATTORNEY

SN 78-867,266. AVERATEC, INC., SANTA ANA, CA. FILED 4-21-2006.

Voya

THE MARK CONSISTS OF STANDARD CHARACTERS WITHOUT CLAIM TO ANY PARTICULAR FONT, STYLE, SIZE, OR COLOR.
FOR SATELLITE NAVIGATIONAL SYSTEM, NAMELY, A GLOBAL POSITIONING SYSTEM (GPS) (U.S. CLS. 21, 23, 26, 36 AND 38).
MARTHA SANTOMARTINO, EXAMINING ATTORNEY

CLASS 9—(Continued).

SN 78-867,307. MICROSOFT CORPORATION, REDMOND, WA. FILED 4-21-2006.

FOREFRONT

THE MARK CONSISTS OF STANDARD CHARACTERS WITHOUT CLAIM TO ANY PARTICULAR FONT, STYLE, SIZE, OR COLOR.

FOR COMPUTER SOFTWARE FOR PROVIDING COMPUTER AND COMPUTER NETWORK SECURITY, ANTI-VIRUS PROTECTION, AND INTRUSION DETECTION AND PREVENTION; COMPUTER SOFTWARE FOR MANAGING AND FILTERING ELECTRONIC COMMUNICATIONS; COMPUTER SOFTWARE FOR PROTECTING AND SECURING COMPUTER NETWORKS AND APPLICATIONS; COMPUTER SOFTWARE PROVIDING FIREWALL PROTECTION; AND COMPUTER SOFTWARE FOR MONITORING AND ASSESSING SECURITY RISKS ON COMPUTERS AND COMPUTER NETWORKS (U.S. CLS. 21, 23, 26, 36 AND 38).

DAVID ELTON, EXAMINING ATTORNEY

CLASS 9—(Continued).

SN 78-867,760. COHEN, DANIEL E., CHASKA, MN. FILED 4-24-2006.



FOR ELECTRONIC APPARATUS CONSISTING OF AUDIO SPEAKERS SET INTO FOAM PADDING AND CONNECTED TO AN AUDIO AMPLIFIER; ELECTRONIC APPARATUS CONSISTING OF AUDIO SPEAKERS INCORPORATED INTO A CHAIR; AUDIO AMPLIFIERS (U.S. CLS. 21, 23, 26, 36 AND 38).

KELLY BOULTON, EXAMINING ATTORNEY

SN 78-867,329. WI2WI, INC., SAN JOSE, CA. FILED 4-21-2006.

WI2WI

THE MARK CONSISTS OF STANDARD CHARACTERS WITHOUT CLAIM TO ANY PARTICULAR FONT, STYLE, SIZE, OR COLOR.

FOR INTEGRATED CIRCUITS USED IN WIRELESS COMMUNICATIONS (U.S. CLS. 21, 23, 26, 36 AND 38).

FIRST USE 4-14-2006; IN COMMERCE 4-14-2006.
HOWARD B. LEVINE, EXAMINING ATTORNEY

SN 78-867,799. TAEKWORLD, VIENNA, VA. FILED 4-24-2006.

Kition

THE MARK CONSISTS OF STANDARD CHARACTERS WITHOUT CLAIM TO ANY PARTICULAR FONT, STYLE, SIZE, OR COLOR.

FOR AUDIO RECORDINGS FEATURING MEDITATION MUSIC; SOUND RECORDINGS FEATURING MEDITATION MUSIC (U.S. CLS. 21, 23, 26, 36 AND 38).

FIRST USE 8-1-2005; IN COMMERCE 8-1-2005.
CIMMERIAN COLEMAN, EXAMINING ATTORNEY

SN 78-867,339. WI2WI, INC., SAN JOSE, CA. FILED 4-21-2006.

THE FUTURE OF INTEGRATED
WIRELESS TODAY

THE MARK CONSISTS OF STANDARD CHARACTERS WITHOUT CLAIM TO ANY PARTICULAR FONT, STYLE, SIZE, OR COLOR.

FOR INTEGRATED CIRCUITS FOR USE IN WIRELESS COMMUNICATIONS (U.S. CLS. 21, 23, 26, 36 AND 38).

FIRST USE 4-14-2006; IN COMMERCE 4-14-2006.
HOWARD B. LEVINE, EXAMINING ATTORNEY

SN 78-867,907. MJW CORPORATION INC., AMHERST, NY. FILED 4-24-2006.

OWNER OF U.S. REG. NO. 2,976,869.
FOR COMPUTER PROGRAM FOR GATHERING, ANALYZING AND REPORTING BEHAVIOR-BASED SAFETY OBSERVATION DATA (U.S. CLS. 21, 23, 26, 36 AND 38).

FIRST USE 6-16-2005; IN COMMERCE 6-16-2005.
ALAIN LAPTER, EXAMINING ATTORNEY

CLASS 9—(Continued).

SN 78-868,041. TBI AUDIO SYSTEMS LLC, ROCKVILLE, MD. FILED 4-24-2006.

HDSS

THE MARK CONSISTS OF STANDARD CHARACTERS WITHOUT CLAIM TO ANY PARTICULAR FONT, STYLE, SIZE, OR COLOR.

FOR EARPHONES; LOUDSPEAKERS; MICROPHONES (U.S. CLS. 21, 23, 26, 36 AND 38).

DARRYL SPRUILL, EXAMINING ATTORNEY

SN 78-868,333. SIMPLIFIED LOGIC, INC., GREENWOOD, IN. FILED 4-24-2006.

NITROCLIP

THE MARK CONSISTS OF STANDARD CHARACTERS WITHOUT CLAIM TO ANY PARTICULAR FONT, STYLE, SIZE, OR COLOR.

FOR COMPUTER SOFTWARE FOR THE CONFIGURATION, ORGANIZATION AND DISTRIBUTION OF GRAPHIC DESIGNS, BUSINESS INFORMATION AND GENERAL DATA OF OTHERS (U.S. CLS. 21, 23, 26, 36 AND 38).

GEORGE LORENZO, EXAMINING ATTORNEY

SN 78-868,534. ROADMAX, INC., TORRANCE, CA. FILED 4-24-2006.

ROADMAX

THE MARK CONSISTS OF STANDARD CHARACTERS WITHOUT CLAIM TO ANY PARTICULAR FONT, STYLE, SIZE, OR COLOR.

FOR VEHICLE NAVIGATION SYSTEMS IN THE NATURE OF ON-BOARD COMPUTERS; VEHICLE AUDIO/VIDEO STEREO/MULTI-CHANNEL SYSTEMS, NAMELY CD RECORDERS/PLAYERS, DVD RECORDER/PLAYERS, EQUALIZERS/PROCESSORS, AMPLIFIERS, CROSSOVERS, SPEAKERS, SPEAKER HOUSINGS; PORTABLE COMPUTERS, DIGITAL CAMERAS, AUDIO/VIDEO RECORDERS AND PLAYERS; CELL PHONES (U.S. CLS. 21, 23, 26, 36 AND 38).

CAROLYN GRAY, EXAMINING ATTORNEY

CLASS 9—(Continued).

SN 78-868,570. ISYS AUTOMATION, INC., SAN DIEGO, CA. FILED 4-24-2006.

openSense

THE MARK CONSISTS OF STANDARD CHARACTERS WITHOUT CLAIM TO ANY PARTICULAR FONT, STYLE, SIZE, OR COLOR.

FOR ELECTRIC OR ELECTRONIC SENSORS FOR THE DETERMINATION OF ENVIRONMENTAL CONDITIONS OF AN AREA, NAMELY OCCUPANCY, MOTION, TEMPERATURE, HUMIDITY, LIGHTING LEVELS, SOUND LEVELS, CARBON MONOXIDE, CARBON DIOXIDE, TOXIC SUBSTANCES, PRESSURES, FLUID LEVELS, SEPARATELY OR IN ANY COMBINATION (U.S. CLS. 21, 23, 26, 36 AND 38).

DAVID MILLER, EXAMINING ATTORNEY

SN 78-868,578. POETVISION CORPORATION, BOISE, ID. FILED 4-24-2006.

PoetVision

THE MARK CONSISTS OF STANDARD CHARACTERS WITHOUT CLAIM TO ANY PARTICULAR FONT, STYLE, SIZE, OR COLOR.

FOR APPARATUS FOR RECORDING, TRANSMISSION OR REPRODUCTION OF SOUND AND IMAGES (U.S. CLS. 21, 23, 26, 36 AND 38).

H. M. FISHER, EXAMINING ATTORNEY

SN 78-868,777. CONTINENTAL CONNECTION, LLC, MINNETONKA, MN. FILED 4-25-2006.

CROSSTALK

THE MARK CONSISTS OF STANDARD CHARACTERS WITHOUT CLAIM TO ANY PARTICULAR FONT, STYLE, SIZE, OR COLOR.

FOR HANDS FREE CELLULAR PHONE SPEAKER SYSTEM WITH MICROPHONE FOR IN-VEHICLE USE (U.S. CLS. 21, 23, 26, 36 AND 38).

JENNIFER MARTIN, EXAMINING ATTORNEY

CLASS 9—(Continued).

SN 78-868,940. DAILYBITZ, LLC, DOWNERS GROVE, IL.
FILED 4-25-2006.

ChickBitz

THE MARK CONSISTS OF STANDARD CHARACTERS WITHOUT CLAIM TO ANY PARTICULAR FONT, STYLE, SIZE, OR COLOR.

FOR COMPUTER SOFTWARE FOR THE TRANSMISSION AND DELIVERY OF MESSAGE OR INFORMATION (U.S. CLS. 21, 23, 26, 36 AND 38).

FIRST USE 9-1-2005; IN COMMERCE 2-1-2006.

ALAIN LAPTEY, EXAMINING ATTORNEY

CLASS 9—(Continued).

SN 78-869,374. CDMDATA, INC., SCOTTSDALE, AZ. FILED
4-25-2006.

DIGITALLOT

THE MARK CONSISTS OF STANDARD CHARACTERS WITHOUT CLAIM TO ANY PARTICULAR FONT, STYLE, SIZE, OR COLOR.

OWNER OF U.S. REG. NO. 2,881,942.

FOR COMPUTER SOFTWARE FOR UPLOADING, DOWNLOADING, PROCESSING, ORGANIZING, VIEWING, PRINTING AND SEARCHING OF VEHICLE INFORMATION (U.S. CLS. 21, 23, 26, 36 AND 38).

RONALD MCMORROW, EXAMINING ATTORNEY

SN 78-868,975. WRIGHT LABORATORIES, TEMECULA, CA.
FILED 4-25-2006.

TACTIO

THE MARK CONSISTS OF STANDARD CHARACTERS WITHOUT CLAIM TO ANY PARTICULAR FONT, STYLE, SIZE, OR COLOR.

FOR ADAPTORS FOR USE WITH PORTABLE ELECTRONIC MEDIA DEVICES (U.S. CLS. 21, 23, 26, 36 AND 38).

NAKIA HENRY, EXAMINING ATTORNEY

SN 78-869,384. PETTINGILL, BERNARD F. JR., PALM
BEACH GARDENS, FL. FILED 4-25-2006.



THE MARK CONSISTS OF CONSISTS OF FOUR LETTERS, WHICH WILL BE MARKED ON PRODUCT.

FOR EAR PLUGS FOR SLEEPING; EAR PLUGS FOR SOUNDPROOFING; EAR PLUGS NOT FOR MEDICAL PURPOSES (U.S. CLS. 21, 23, 26, 36 AND 38).

ALLISON HOLTZ, EXAMINING ATTORNEY

SN 78-869,261. TOVAR, DOROTHY L., PLACERVILLE, CA.
FILED 4-25-2006.

WHAT HAPPENS IN VEGAS STAYS IN VEGAS

THE MARK CONSISTS OF STANDARD CHARACTERS WITHOUT CLAIM TO ANY PARTICULAR FONT, STYLE, SIZE, OR COLOR.

OWNER OF U.S. REG. NOS. 2,930,998 AND 2,986,162.

NO CLAIM IS MADE TO THE EXCLUSIVE RIGHT TO USE "VEGAS", APART FROM THE MARK AS SHOWN.

FOR CAMERA CASES; DISPOSABLE CAMERAS (U.S. CLS. 21, 23, 26, 36 AND 38).

CAROLYN GRAY, EXAMINING ATTORNEY

SN 78-869,476. MICROSOFT CORPORATION, REDMOND,
WA. FILED 4-25-2006.

WINDOWS POWERSHELL

THE MARK CONSISTS OF STANDARD CHARACTERS WITHOUT CLAIM TO ANY PARTICULAR FONT, STYLE, SIZE, OR COLOR.

OWNER OF U.S. REG. NOS. 1,872,264 AND 2,513,051.

FOR OPERATING SYSTEM SOFTWARE AND UTILITIES; COMPUTER SOFTWARE FOR ADMINISTRATION OF COMPUTER NETWORKS; AND COMPUTER SOFTWARE DEVELOPMENT TOOLS FOR USE BY COMPUTER NETWORK ADMINISTRATORS (U.S. CLS. 21, 23, 26, 36 AND 38).

DAVID ELTON, EXAMINING ATTORNEY

CLASS 9—(Continued).

SN 78-869,496. KOGNITO SOLUTIONS LLC, NEW YORK, NY. FILED 4-25-2006.



THE MARK CONSISTS OF EQUAL SIGN TO THE LEFT OF STYLIZED TEXT KOGNITO.

FOR EDUCATIONAL SOFTWARE FEATURING INSTRUCTION IN MANAGERIAL AND LEADERSHIP TOPICS (U.S. CLS. 21, 23, 26, 36 AND 38).

FIRST USE 3-4-2003; IN COMMERCE 3-4-2003.
KEVON CHISOLM, EXAMINING ATTORNEY

CLASS 9—(Continued).

SN 78-869,644. INTEROPERABLE TECHNOLOGIES LLC, DEERFIELD BEACH, FL. FILED 4-26-2006.

SELECTSR

THE MARK CONSISTS OF STANDARD CHARACTERS WITHOUT CLAIM TO ANY PARTICULAR FONT, STYLE, SIZE, OR COLOR.

FOR ANTENNAS FOR RADIO, FOR TELEVISION; MOBILE RADIOS; PORTABLE RADIOS; RADIO AND TELEVISION AERIALS; RADIO RECEIVERS; RADIO RECEIVERS AND MONITORS FOR REPRODUCTION OF SOUND AND SIGNALS; RADIOS FOR VEHICLES; RADIOS INCORPORATING CLOCKS (U.S. CLS. 21, 23, 26, 36 AND 38).

HOWARD B. LEVINE, EXAMINING ATTORNEY

SN 78-869,702. WYNDHAM TM CORP., LAS VEGAS, NV. FILED 4-26-2006.

WYNTUNES

THE MARK CONSISTS OF STANDARD CHARACTERS WITHOUT CLAIM TO ANY PARTICULAR FONT, STYLE, SIZE, OR COLOR.

FOR PRE-RECORDED CD'S, VIDEO TAPES, LASER DISKS AND DVD'S FEATURING MUSIC (U.S. CLS. 21, 23, 26, 36 AND 38).

DARRYL SPRUILL, EXAMINING ATTORNEY

SN 78-869,568. POETVISION CORPORATION, BOISE, ID. FILED 4-25-2006.



THE MARK CONSISTS OF A DIMENSIONALLY GRADUATING SPIRAL CONSISTING OF 1.5 REVOLUTIONS RELATIVE TO RADIUS.

FOR APPARATUS FOR RECORDING, TRANSMISSION OR REPRODUCTION OF SOUND AND IMAGES (U.S. CLS. 21, 23, 26, 36 AND 38).

H. M. FISHER, EXAMINING ATTORNEY

SN 78-869,800. GAMMA ENTERPRISE TECHNOLOGIES, WOODLAND HILLS, CA. FILED 4-26-2006.

INFOSTART

THE MARK CONSISTS OF STANDARD CHARACTERS WITHOUT CLAIM TO ANY PARTICULAR FONT, STYLE, SIZE, OR COLOR.

FOR SOFTWARE FOR USE WITH SAP SOFTWARE FOR MOVING CONFIGURATION AND MASTER DATA FROM PRODUCTION INTO NON-PRODUCTION SYSTEMS TO INCREASE EFFICIENCY AND MINIMIZE DISK SPACE, DISK USAGE, AND ELIMINATE THE LABOR REQUIRED AND ERRORS INTRODUCED WHEN USING CUSTOM PROGRAMS OR MANUAL ENTRY TO MOVE AND CREATE DATA (U.S. CLS. 21, 23, 26, 36 AND 38).

MARTHA SANTOMARTINO, EXAMINING ATTORNEY

CLASS 9—(Continued).

SN 78-869,891. INTEROPERABLE TECHNOLOGIES LLC, DEERFIELD BEACH, FL. FILED 4-26-2006.

EZSET

THE MARK CONSISTS OF STANDARD CHARACTERS WITHOUT CLAIM TO ANY PARTICULAR FONT, STYLE, SIZE, OR COLOR.

FOR ANTENNAS FOR RADIO, FOR TELEVISION; MOBILE RADIOS; PORTABLE RADIOS; RADIO AND TELEVISION AERIALS; RADIO RECEIVERS; RADIO RECEIVERS AND MONITORS FOR REPRODUCTION OF SOUND AND SIGNALS; RADIOS FOR VEHICLES; RADIOS INCORPORATING CLOCKS (U.S. CLS. 21, 23, 26, 36 AND 38).

HOWARD B. LEVINE, EXAMINING ATTORNEY

SN 78-869,895. INTEROPERABLE TECHNOLOGIES LLC, DEERFIELD BEACH, FL. FILED 4-26-2006.

EZSELECT

THE MARK CONSISTS OF STANDARD CHARACTERS WITHOUT CLAIM TO ANY PARTICULAR FONT, STYLE, SIZE, OR COLOR.

FOR ANTENNAS FOR RADIO, FOR TELEVISION; MOBILE RADIOS; PORTABLE RADIOS; RADIO AND TELEVISION AERIALS; RADIO RECEIVERS; RADIO RECEIVERS AND MONITORS FOR REPRODUCTION OF SOUND AND SIGNALS; RADIOS FOR VEHICLES; RADIOS INCORPORATING CLOCKS (U.S. CLS. 21, 23, 26, 36 AND 38).

HOWARD B. LEVINE, EXAMINING ATTORNEY

SN 78-869,904. MIDISOFT CORPORATION, TORRANCE, CA. FILED 4-26-2006.

Midisoft Corporation

THE MARK CONSISTS OF STANDARD CHARACTERS WITHOUT CLAIM TO ANY PARTICULAR FONT, STYLE, SIZE, OR COLOR.

NO CLAIM IS MADE TO THE EXCLUSIVE RIGHT TO USE "CORPORATION", APART FROM THE MARK AS SHOWN.

FOR AUDIO SOUND RECORDINGS FEATURING MUSIC LYRICS AND OTHER INFORMATION, NAMELY, VERBAL INFORMATION, WHICH MAY BE RELATED TO THE OTHER CONTENTS OF THE RECORDINGS, AND COMPUTER SOFTWARE USED FOR PLAYING, RECORDING, EDITING, AND PROGRAMMING MUSIC AND OTHER AUDIO RECORDINGS (U.S. CLS. 21, 23, 26, 36 AND 38).

SHARON MEIER, EXAMINING ATTORNEY

CLASS 9—(Continued).

SN 78-870,003. VOBILE, INC., MILPITAS, CA. FILED 4-26-2006.

VOBILE

THE MARK CONSISTS OF STANDARD CHARACTERS WITHOUT CLAIM TO ANY PARTICULAR FONT, STYLE, SIZE, OR COLOR.

FOR COMPUTER SOFTWARE FOR VIDEO IMAGE RECOGNITION AND INDEXING (U.S. CLS. 21, 23, 26, 36 AND 38).

WANDA KAY PRICE, EXAMINING ATTORNEY

SN 78-870,015. NIELSEN MEDIA RESEARCH, INC., NEW YORK, NY. FILED 4-26-2006.

SPOTTRAC

THE MARK CONSISTS OF STANDARD CHARACTERS WITHOUT CLAIM TO ANY PARTICULAR FONT, STYLE, SIZE, OR COLOR.

FOR COMPUTER SOFTWARE AND HARDWARE FOR USE IN ENCODING, DECODING, READING, AND ANALYZING BROADCAST, TELEVISION, VIDEO AND AUDIO SIGNALS, AUDIO AND VIDEO CODING, AND SIGNAL SOURCE IDENTIFICATION AND ANALYSIS; FIRMWARE, NAMELY ELECTRONIC AND INTEGRATED CIRCUITS, FOR USE IN ENCODING, DECODING, READING, AND ANALYZING BROADCAST, TELEVISION, VIDEO AND AUDIO SIGNALS, AUDIO AND VIDEO CODING, AND SIGNAL SOURCE IDENTIFICATION AND ANALYSIS; ELECTRONIC AUDIO AND VIDEO ENCODERS; AND ELECTRONIC AUDIO AND VIDEO READERS (U.S. CLS. 21, 23, 26, 36 AND 38).

HEATHER SAPP, EXAMINING ATTORNEY

SN 78-870,109. WMS GAMING INC., WAUKEGAN, IL. FILED 4-26-2006.

FREE SPIN MAXIMUS

THE MARK CONSISTS OF STANDARD CHARACTERS WITHOUT CLAIM TO ANY PARTICULAR FONT, STYLE, SIZE, OR COLOR.

NO CLAIM IS MADE TO THE EXCLUSIVE RIGHT TO USE "FREE SPIN", APART FROM THE MARK AS SHOWN.

FOR GAMING MACHINES (U.S. CLS. 21, 23, 26, 36 AND 38).

GEORGE LORENZO, EXAMINING ATTORNEY

CLASS 9—(Continued).

SN 78-870,156. FESTA FACILITATORS, INC., TAMPA, FL.
FILED 4-26-2006.

CLASS 9—(Continued).

SN 78-870,620. ANOMIC APHASIA, WICHITA, KS. FILED 4-
26-2006.

BUILDERWERKS

THE MARK CONSISTS OF STANDARD CHARACTERS
WITHOUT CLAIM TO ANY PARTICULAR FONT, STYLE,
SIZE, OR COLOR.

FOR COMPUTER PROGRAMS RECORDED ON DATA
MEDIA (SOFTWARE) DESIGNED FOR USE IN CON-
STRUCTION AND AUTOMATED MANUFACTURING
(CAD/CAM) (U.S. CLS. 21, 23, 26, 36 AND 38).

FIRST USE 8-20-2003; IN COMMERCE 8-26-2003.
JENNY PARK, EXAMINING ATTORNEY

Angel Advocates

THE MARK CONSISTS OF STANDARD CHARACTERS
WITHOUT CLAIM TO ANY PARTICULAR FONT, STYLE,
SIZE, OR COLOR.

FOR COMPUTER GAME SOFTWARE (U.S. CLS. 21, 23,
26, 36 AND 38).

ALEXANDER L. POWERS, EXAMINING ATTORNEY

SN 78-870,208. ADHESIVES RESEARCH, INC., GLEN ROCK,
PA. FILED 4-26-2006.

SN 78-871,633. FROGUTS INC., SEATTLE, WA. FILED 4-27-
2006.

ARvision

THE MARK CONSISTS OF STANDARD CHARACTERS
WITHOUT CLAIM TO ANY PARTICULAR FONT, STYLE,
SIZE, OR COLOR.

FOR DIGITAL ANALYSIS SYSTEM COMPRISING
REMOTE MAGNIFYING READER AND ASSOCIATED
AUTHENTICATING SOFTWARE, FOR USE IN PRO-
DUCT AUTHENTICATION BY NONDESTRUCTIVE VI-
SUAL OR FORENSIC ANALYSIS (U.S. CLS. 21, 23, 26, 36
AND 38).

ESTHER BELENKER, EXAMINING ATTORNEY

FROGUTS

THE MARK CONSISTS OF STANDARD CHARACTERS
WITHOUT CLAIM TO ANY PARTICULAR FONT, STYLE,
SIZE, OR COLOR.

FOR EDUCATIONAL SOFTWARE FEATURING IN-
STRUCTION IN DISSECTION AND RELATED BIOLOGY
SUBJECTS (U.S. CLS. 21, 23, 26, 36 AND 38).

BILL DAWE, EXAMINING ATTORNEY

SN 78-870,220. WMS GAMING INC., WAUKEGAN, IL.
FILED 4-26-2006.

SN 78-871,648. ABRAHMS, DARRYL, REDMOND, WA.
FILED 4-27-2006.

FREE SPIN PLUNDER

THE MARK CONSISTS OF STANDARD CHARACTERS
WITHOUT CLAIM TO ANY PARTICULAR FONT, STYLE,
SIZE, OR COLOR.

NO CLAIM IS MADE TO THE EXCLUSIVE RIGHT TO
USE "FREE SPIN", APART FROM THE MARK AS SHOWN.

FOR GAMING MACHINES (U.S. CLS. 21, 23, 26, 36
AND 38).

GEORGE LORENZO, EXAMINING ATTORNEY

PALMTECH

THE MARK CONSISTS OF STANDARD CHARACTERS
WITHOUT CLAIM TO ANY PARTICULAR FONT, STYLE,
SIZE, OR COLOR.

FOR PROTECTIVE GLOVES FOR INDUSTRIAL USE
(U.S. CLS. 21, 23, 26, 36 AND 38).

GEORGE LORENZO, EXAMINING ATTORNEY

CLASS 9—(Continued).

SN 78-872,928. EVORY TECHNOLOGIES, INC., PHILADELPHIA, PA. FILED 4-30-2006.

Wii

THE MARK CONSISTS OF STANDARD CHARACTERS WITHOUT CLAIM TO ANY PARTICULAR FONT, STYLE, SIZE, OR COLOR.

FOR AMPLIFIERS; AUDIO SPEAKERS; AUDIO-VIDEO RECEIVERS; BATTERIES; BATTERY CHARGERS; BRAKE CONTROLLERS; CABLE TELEVISION CONVERTERS; CALCULATORS; CAMERAS; CINEMATOGRAPHIC PROJECTORS; COMPUTER GAME CARTRIDGES; COMPUTER GAME CASSETTES; COMPUTER GAME DISCS; COMPUTER GAME JOYSTICKS; COMPUTER GAME PROGRAMS; COMPUTER GAME TAPES; COMPUTER MEMORIES; COMPUTERS; CONVERTERS; DRY CELLS; DVD BURNERS; DVD DRIVES; DVD RECORDING APPARATUS; DVD-PLAYERS; ELECTRIC WIRE AND CABLE; ELECTRICAL CELLS AND BATTERIES; ELECTRICAL CONTROLLERS; ELECTRONIC GAME PROGRAMS; ELECTRONIC GAME SOFTWARE FOR CELLULAR TELEPHONES; ELECTRONIC GAME SOFTWARE FOR HANDHELD ELECTRONIC DEVICES; ELECTRONIC GAME SOFTWARE FOR WIRELESS DEVICES; FLASH MEMORY CARD; FUEL CELLS; GAME SOFTWARE; GLOBAL POSITIONING SYSTEM (GPS) CONSISTING OF COMPUTERS, COMPUTER SOFTWARE, TRANSMITTERS, RECEIVERS, AND NETWORK INTERFACE DEVICES; IGNITION BATTERIES; KEYBOARDS; LCD LARGE-SCREEN DISPLAYS; LCD PANELS; LIQUID CRYSTAL DISPLAY (LCD) PROJECTORS; LOUD SPEAKER SYSTEMS; MEMORY BOARDS; MICROPHONES; MOBILE DATA RECEIVERS; MOVIE PROJECTORS; MP3 PLAYERS; MULTIMEDIA PROJECTORS; OPTICAL CABLES; PERSONAL DIGITAL ASSISTANTS (PDA); PHOTOGRAPHIC PROJECTORS; PHOTOVOLTAIC CELLS; PICTURE PROJECTORS; POWER CONTROLLERS; PROGRAMMABLE DIGITAL TELEVISION RECORDERS; RADAR RECEIVERS WITH AMPLIFIERS; RADIO RECEIVERS; SATELLITE NAVIGATIONAL SYSTEM, NAMELY, A GLOBAL POSITIONING SYSTEM (GPS); SATELLITE RECEIVERS; SEMI-CONDUCTOR MEMORIES; SLIDE PROJECTORS; SOLAR CELLS; STEREO RECEIVERS; TELEVISION ANTENNAS; TELEVISION DECODER; TELEVISION MONITORS; TELEVISION SETS; TRANSFORMERS; VEHICLE MOUNTED GPS SENSOR FOR DETERMINING THE RATE OF MOTION FOR A VEHICLE; VIDEO GAME CARTRIDGES; VIDEO GAME DISCS; VIDEO GAME INTERACTIVE CONTROL FLOOR PADS OR MATS; VIDEO GAME INTERACTIVE REMOTE CONTROL UNITS; VIDEO GAME JOYSTICKS; VIDEO GAME MACHINES FOR USE WITH TELEVISIONS; VIDEO PROJECTORS; VIRTUAL REALITY GAME SOFTWARE; WATER FILTER CONTROLLERS; WET CELLS; WOOLERS (U.S. CLS. 21, 23, 26, 36 AND 38).

FIRST USE 1-1-2006; IN COMMERCE 1-1-2006.

JACQUELINE A. LAVINE, EXAMINING ATTORNEY

CLASS 9—(Continued).

SN 78-872,986. MIPAD DE P.R., INC., GUAYNABO, PUERTO RICO, FILED 4-30-2006.

FOXTAIL

THE MARK CONSISTS OF STANDARD CHARACTERS WITHOUT CLAIM TO ANY PARTICULAR FONT, STYLE, SIZE, OR COLOR.

FOR ELECTRIC CURRENT SWITCHES; ELECTRIC DOOR BELLS; ELECTRIC LIGHT SWITCHES; ELECTRIC PLUGS; ELECTRIC SWITCHES; ELECTRICAL PLUGS; ELECTRICAL RECEPTACLES; ELECTRONIC TOUCH SENSITIVE SWITCHES; LIGHT SWITCHES; POWER SWITCHES; PROTECTION MASKS; PROTECTIVE EYEGLASSES; PROTECTIVE EYEWEAR; PROTECTIVE GLASSES; PROTECTIVE GLOVES FOR INDUSTRIAL USE; PROTECTIVE HELMETS; PROTECTIVE INDUSTRIAL SHOES; PROTECTIVE WORK GLOVES; SAFETY EYEWEAR; SAFETY GOGGLES; SAFETY HELMETS; WELDING ELECTRODES (U.S. CLS. 21, 23, 26, 36 AND 38).

FIRST USE 9-5-2000; IN COMMERCE 9-5-2000.

HEATHER SAPP, EXAMINING ATTORNEY

SN 78-873,279. BLACKHAWK INDUSTRIES PRODUCT GROUP UNLIMITED LLC, NORFOLK, VA. FILED 5-1-2006.

THE WORLD'S FINEST
TACTICAL GEAR

THE MARK CONSISTS OF STANDARD CHARACTERS WITHOUT CLAIM TO ANY PARTICULAR FONT, STYLE, SIZE, OR COLOR.

OWNER OF U.S. REG. NOS. 3,128,840 AND 3,128,841.

NO CLAIM IS MADE TO THE EXCLUSIVE RIGHT TO USE "TACTICAL GEAR", APART FROM THE MARK AS SHOWN.

SEC. 2(F).

FOR TACTICAL GEAR AND TACTICAL EQUIPMENT FOR MILITARY, LAW ENFORCEMENT AND DEFENSE APPLICATIONS, NAMELY, PROTECTIVE CLOTHING; PROTECTIVE EYEWEAR; PROTECTIVE SUNGLASSES; PROTECTIVE GOGGLES AND MASKS; PROTECTIVE HELMETS; GLOVES FOR PROTECTION AGAINST ACCIDENTS AND INJURY, NAMELY, PROTECTIVE GLOVES, DRIVING GLOVES, SHOOTING GLOVES, HAZMAT GLOVES, WATER OPERATION DIVING GLOVES, ASSAULT GLOVES, VIRAL BARRIER GLOVES, RESCUE GLOVES, RAPPELLING GLOVES, AND GLOVE LINERS; PROTECTIVE CLOTHING, NAMELY, FLAME RETARDANT BALACLAVAS, SLASH RESISTANT BALACLAVAS, THERMAL BALACLAVAS, TACTICAL VESTS, MODULAR TACTICAL VESTS, RAPID ENTRY VESTS, MESH VESTS, ARMOR BEARING VESTS, RESCUE VESTS, MEDICAL AND PARAMEDIC VESTS, COMBINATION BALLISTIC/FLOTATION VESTS, LOAD-BEARING VESTS; HARNESSES AND SLINGS USED FOR KEEPING CLOTHING AND TACTICAL EQUIPMENT IN PLACE; PROTECTIVE ELBOW PADS, KNEE PADS, SHIN PADS AND SHINGUARDS; DISTURBANCE CONTROL GEAR, NAMELY, HARD SHELL RIOT SUITS AND SOFT SHELL RIOT SUITS; HAND-HELD TACTICAL AND PROTECTIVE SHIELDS; BAGS FOR TACTICAL GEAR AND TACTICAL EQUIPMENT (U.S. CLS. 21, 23, 26, 36 AND 38).

FIRST USE 1-0-2003; IN COMMERCE 1-0-2003.

AISHA CLARKE, EXAMINING ATTORNEY

CLASS 9—(Continued).

SN 78-873,569. ISYS AUTOMATION, INC., SAN DIEGO, CA.
FILED 5-1-2006.

iSYS LonPod

THE MARK CONSISTS OF STANDARD CHARACTERS WITHOUT CLAIM TO ANY PARTICULAR FONT, STYLE, SIZE, OR COLOR.

FOR COMPUTER PROGRAMS FOR REMOTE MONITORING AND CONTROL OF NETWORK DATA AND EQUIPMENT VIA ANY HANDHELD MICROPROCESSOR BASED DEVICE, NAMELY A CELLPHONE OR PDA (U.S. CLS. 21, 23, 26, 36 AND 38).

FIRST USE 8-23-2005; IN COMMERCE 8-23-2005.
DAVID MILLER, EXAMINING ATTORNEY

SN 78-874,212. ABSOLUTE PROCESS INSTRUMENTS, INC.,
LIBERTYVILLE, IL. FILED 5-2-2006.

ThermoPro

THE MARK CONSISTS OF STANDARD CHARACTERS WITHOUT CLAIM TO ANY PARTICULAR FONT, STYLE, SIZE, OR COLOR.

FOR TEMPERATURE INDICATORS (U.S. CLS. 21, 23,
26, 36 AND 38).

FIRST USE 10-28-2004; IN COMMERCE 12-1-2004.
GINA FINK, EXAMINING ATTORNEY

SN 78-874,375. HOODMAN CORPORATION, TORRANCE,
CA. FILED 5-2-2006.

WRISTSHOT

THE MARK CONSISTS OF STANDARD CHARACTERS WITHOUT CLAIM TO ANY PARTICULAR FONT, STYLE, SIZE, OR COLOR.

FOR CAMCORDER SUPPORT MOUNT (U.S. CLS. 21,
23, 26, 36 AND 38).

FIRST USE 4-24-2006; IN COMMERCE 4-24-2006.
WILLIAM ROSSMAN, EXAMINING ATTORNEY

CLASS 9—(Continued).

SN 78-874,424. SOLID 21 INCORPORATED, LOS ANGELES,
CA. FILED 5-2-2006.

RED GOLD

THE MARK CONSISTS OF STANDARD CHARACTERS WITHOUT CLAIM TO ANY PARTICULAR FONT, STYLE, SIZE, OR COLOR.

FOR SUNGLASSES (U.S. CLS. 21, 23, 26, 36 AND 38).
DOMINIC J. FERRAIUOLO, EXAMINING ATTORNEY

SN 78-875,297. ZILOG, INC., SAN JOSE, CA. FILED 5-3-2006.

ZBase

THE MARK CONSISTS OF STANDARD CHARACTERS WITHOUT CLAIM TO ANY PARTICULAR FONT, STYLE, SIZE, OR COLOR.

FOR DATABASES RECORDED ON COMPUTER MEDIA FEATURING SIGNALS AND CODES FOR PROGRAMMING A REMOTE CONTROL PRODUCT OR AN INTEGRATED CIRCUIT THEREOF; COMPUTER SOFTWARE CONTAINING DATABASES FEATURING SIGNALS AND CODES FOR PROGRAMMING A REMOTE CONTROL PRODUCT OR AN INTEGRATED CIRCUIT THEREOF; SOFTWARE AND FIRMWARE FOR ACCESSING THE AFOREMENTIONED DATABASES. (U.S. CLS. 21, 23, 26, 36 AND 38).

KATHY DE JONGE, EXAMINING ATTORNEY

SN 78-875,462. MICROSOFT CORPORATION, REDMOND,
WA. FILED 5-3-2006.

BITLOCKER

THE MARK CONSISTS OF STANDARD CHARACTERS WITHOUT CLAIM TO ANY PARTICULAR FONT, STYLE, SIZE, OR COLOR.

PRIORITY CLAIMED UNDER SEC. 44(D) ON FED REP GERMANY APPLICATION NO. 30571279, FILED 11-29-2005, REG. NO. 30571279, DATED 1-19-2006, EXPIRES 11-30-2015.

FOR OPERATING SYSTEM SOFTWARE; COMPUTER UTILITY PROGRAMS; COMPUTER SOFTWARE FOR ENCRYPTION; AND COMPUTER SOFTWARE FOR RESTRICTING ACCESS TO DATA AND COMPUTER PROGRAMS STORED ON A PERSONAL COMPUTER (U.S. CLS. 21, 23, 26, 36 AND 38).

DAVID ELTON, EXAMINING ATTORNEY

CLASS 9—(Continued).

SN 78-876,081. CYBERSENSE, INC., NICHOLASVILLE, KY.
FILED 5-3-2006.

CYMOGRAPH

THE MARK CONSISTS OF STANDARD CHARACTERS WITHOUT CLAIM TO ANY PARTICULAR FONT, STYLE, SIZE, OR COLOR.

FOR COMPUTER PROGRAMS FOR SCIENTIFIC AND ENGINEERING DATA ACQUISITION, CONTROL, SIMULATION, AND ANALYSIS AND INSTRUCTION MANUALS SOLD THEREWITH (U.S. CLS. 21, 23, 26, 36 AND 38).

FIRST USE 11-6-2002; IN COMMERCE 11-6-2002.
MICHAEL KEATING, EXAMINING ATTORNEY

SN 78-876,162. SHELL TRADEMARK MANAGEMENT B.V.,
THE HAGUE, NETHERLANDS, FILED 5-4-2006.

PRODUCTION UNIVERSE

THE MARK CONSISTS OF STANDARD CHARACTERS WITHOUT CLAIM TO ANY PARTICULAR FONT, STYLE, SIZE, OR COLOR.

NO CLAIM IS MADE TO THE EXCLUSIVE RIGHT TO USE "PRODUCTION", APART FROM THE MARK AS SHOWN.

FOR COMPUTER SOFTWARE FOR MONITORING, CONTROL AND OPTIMIZATION OF OIL AND GAS PRODUCTION FROM THE RESERVOIR TO THE POINT OF SALE (U.S. CLS. 21, 23, 26, 36 AND 38).

TRAVIS WHEATLEY, EXAMINING ATTORNEY

SN 78-876,250. SEPATON, INC., MARLBOROUGH, MA.
FILED 5-4-2006.

DELTASTOR

THE MARK CONSISTS OF STANDARD CHARACTERS WITHOUT CLAIM TO ANY PARTICULAR FONT, STYLE, SIZE, OR COLOR.

FOR SOFTWARE FOR DATA DEDUPLICATION (U.S. CLS. 21, 23, 26, 36 AND 38).

KEVIN DINALLO, EXAMINING ATTORNEY

CLASS 9—(Continued).

SN 78-876,824. DAILYBITZ, LLC, DOWNERS GROVE, IL.
FILED 5-4-2006.

DudeBitz

THE MARK CONSISTS OF STANDARD CHARACTERS WITHOUT CLAIM TO ANY PARTICULAR FONT, STYLE, SIZE, OR COLOR.

FOR COMPUTER SOFTWARE FOR THE TRANSMISSION AND DELIVERY OF MESSAGES OR INFORMATION (U.S. CLS. 21, 23, 26, 36 AND 38).

FIRST USE 1-1-2006; IN COMMERCE 5-1-2006.
ALAIN LAPTER, EXAMINING ATTORNEY

SN 78-877,001. POWELL, JULIAN KENT, DETROIT, MI.
FILED 5-4-2006.



NO CLAIM IS MADE TO THE EXCLUSIVE RIGHT TO USE "RECORDINGS" AND THE GEOGRAPHICAL OUTLINE OF THE CONTINENTAL UNITED STATES OF AMERICA, APART FROM THE MARK AS SHOWN.

THE MARK CONSISTS OF A MAP OF THE CONTINENTAL UNITED STATES, OUTLINED BY STATE, BEHIND THE WORDS THE GRITTY NORTH RECORDINGS.

FOR AUDIO RECORDINGS FEATURING MUSIC; DOWNLOADABLE MUSICAL SOUND RECORDINGS; DOWNLOADABLE RING TONES, GRAPHICS AND MUSIC VIA A GLOBAL COMPUTER NETWORK AND WIRELESS DEVICES; MUSICAL SOUND RECORDINGS; MUSICAL VIDEO RECORDINGS; SOUND RECORDINGS FEATURING MUSIC; VISUAL RECORDINGS AND AUDIO VISUAL RECORDINGS FEATURING MUSIC AND ANIMATION (U.S. CLS. 21, 23, 26, 36 AND 38).

EDWARD NELSON, EXAMINING ATTORNEY

CLASS 9—(Continued).

SN 78-877,198. LINCOLN GLOBAL, INC., SANTA FE SPRINGS, CA. FILED 5-5-2006.

JETWELD

THE MARK CONSISTS OF STANDARD CHARACTERS WITHOUT CLAIM TO ANY PARTICULAR FONT, STYLE, SIZE, OR COLOR.

OWNER OF U.S. REG. NO. 590,581.
FOR WELDING ELECTRODES (U.S. CLS. 21, 23, 26, 36 AND 38).

FIRST USE 9-25-1953; IN COMMERCE 9-25-1953.
MICHELE SWAIN, EXAMINING ATTORNEY

SN 78-877,224. LINCOLN GLOBAL, INC., SANTA FE SPRINGS, CA. FILED 5-5-2006.

IDEALARC

THE MARK CONSISTS OF STANDARD CHARACTERS WITHOUT CLAIM TO ANY PARTICULAR FONT, STYLE, SIZE, OR COLOR.

OWNER OF U.S. REG. NO. 630,789.
FOR WELDING ELECTRODES (U.S. CLS. 21, 23, 26, 36 AND 38).

FIRST USE 10-29-1954; IN COMMERCE 10-29-1954.
MICHELE SWAIN, EXAMINING ATTORNEY

SN 78-877,239. LINCOLN GLOBAL, INC., SANTA FE SPRINGS, CA. FILED 5-5-2006.

MUREX

THE MARK CONSISTS OF STANDARD CHARACTERS WITHOUT CLAIM TO ANY PARTICULAR FONT, STYLE, SIZE, OR COLOR.

OWNER OF U.S. REG. NO. 325,116.
FOR WELDING ELECTRODES (U.S. CLS. 21, 23, 26, 36 AND 38).

FIRST USE 11-1-1931; IN COMMERCE 11-1-1931.
MICHELE SWAIN, EXAMINING ATTORNEY

CLASS 9—(Continued).

SN 78-878,094. MICROSOFT CORPORATION, REDMOND, WA. FILED 5-5-2006.

TURN 10

THE MARK CONSISTS OF STANDARD CHARACTERS WITHOUT CLAIM TO ANY PARTICULAR FONT, STYLE, SIZE, OR COLOR.

FOR COMPUTER PROGRAMS, NAMELY, GAME SOFTWARE FOR USE ON COMPUTERS AND VIDEO GAME PLAYERS; PRERECORDED VIDEOTAPES, AUDIO TAPES, CDS AND DVDS FEATURING SOUND AND VIDEO IN THE FIELDS OF MUSIC, LIVE ACTION PROGRAMS, MOTION PICTURES AND ANIMATED CARTOONS; MOTION PICTURE FILMS FEATURING COMEDY, DRAMA, ACTION, ADVENTURE AND ANIMATION; MOTION PICTURE FILMS FOR BROADCAST ON TELEVISION FEATURING COMEDY, DRAMA, ACTION, ADVENTURE AND ANIMATION; AND COVERS FOR COMPUTER GAME CONSOLES AND PERIPHERALS (U.S. CLS. 21, 23, 26, 36 AND 38).

DAVID ELTON, EXAMINING ATTORNEY

SN 78-878,988. WMS GAMING INC., WAUKEGAN, IL. FILED 5-8-2006.

TRIPLE GOLDEN CHERRIES

THE MARK CONSISTS OF STANDARD CHARACTERS WITHOUT CLAIM TO ANY PARTICULAR FONT, STYLE, SIZE, OR COLOR.

FOR GAMING MACHINES (U.S. CLS. 21, 23, 26, 36 AND 38).
ALICE SUE CARRUTHERS, EXAMINING ATTORNEY

SN 78-878,990. WMS GAMING INC., WAUKEGAN, IL. FILED 5-8-2006.

3 ALARM FIRE

THE MARK CONSISTS OF STANDARD CHARACTERS WITHOUT CLAIM TO ANY PARTICULAR FONT, STYLE, SIZE, OR COLOR.

FOR GAMING MACHINES (U.S. CLS. 21, 23, 26, 36 AND 38).
GEORGE LORENZO, EXAMINING ATTORNEY

CLASS 9—(Continued).

SN 78-878,994. WMS GAMING INC., WAUKEGAN, IL.
FILED 5-8-2006.

CASH-TASTIC

THE MARK CONSISTS OF STANDARD CHARACTERS
WITHOUT CLAIM TO ANY PARTICULAR FONT, STYLE,
SIZE, OR COLOR.

FOR GAMING MACHINES (U.S. CLS. 21, 23, 26, 36
AND 38).

ALICE SUE CARRUTHERS, EXAMINING ATTORNEY

CLASS 9—(Continued).

SN 78-882,086. COMMSCOPE PROPERTIES, LLC, SPARKS,
NV. FILED 5-12-2006.

CONNECTED BY COMMSCOPE

THE MARK CONSISTS OF STANDARD CHARACTERS
WITHOUT CLAIM TO ANY PARTICULAR FONT, STYLE,
SIZE, OR COLOR.

OWNER OF U.S. REG. NOS. 898,651, 3,124,082 AND
OTHERS.

FOR COMMUNICATIONS CABLES, NAMELY, FIBER
OPTIC, TWISTED PAIR AND COAXIAL CABLES, AND
HYBRIDS THEREOF, AND CONNECTORS THEREFOR
(U.S. CLS. 21, 23, 26, 36 AND 38).

STEVEN PEREZ, EXAMINING ATTORNEY

SN 78-879,354. WMS GAMING INC., WAUKEGAN, IL.
FILED 5-9-2006.

REEL ADVENTURE

THE MARK CONSISTS OF STANDARD CHARACTERS
WITHOUT CLAIM TO ANY PARTICULAR FONT, STYLE,
SIZE, OR COLOR.

OWNER OF U.S. REG. NO. 2,846,402.
FOR GAMING MACHINES (U.S. CLS. 21, 23, 26, 36
AND 38).

ALICE SUE CARRUTHERS, EXAMINING ATTORNEY

SN 78-883,527. NIPPON DENKI KABUSHIKI KAISHA, DBA
NEC CORPORATION, TOKYO, JAPAN, FILED 5-15-2006.

WANBOOSTER

THE MARK CONSISTS OF STANDARD CHARACTERS
WITHOUT CLAIM TO ANY PARTICULAR FONT, STYLE,
SIZE, OR COLOR.

FOR SERVER AND NETWORKING SOFTWARE USED
TO IMPROVE THE PERFORMANCE OF COMPUTER
APPLICATIONS, SERVERS, DATA STORAGE AND
COMMUNICATIONS PROTOCOLS USED IN WIDE
AREA AND GLOBAL NETWORKS; COMPUTER NET-
WORKING HARDWARE; COMPUTER SOFTWARE FOR
USE IN ENHANCING, OPTIMIZING, SECURING, AC-
CELERATING, MONITORING, AND MANAGING COM-
PUTER NETWORK TRAFFIC AND APPLICATIONS
COMMUNICATING ACROSS NETWORKS (U.S. CLS.
21, 23, 26, 36 AND 38).

BENJAMIN OKEKE, EXAMINING ATTORNEY

SN 78-879,830. QUADRAMED CORPORATION, RESTON,
VA. FILED 5-9-2006.

LINKSEARCH

THE MARK CONSISTS OF STANDARD CHARACTERS
WITHOUT CLAIM TO ANY PARTICULAR FONT, STYLE,
SIZE, OR COLOR.

FOR COMPUTER SOFTWARE, NAMELY, SOFTWARE
THAT COMPARES DEMOGRAPHIC DATA AND FACIL-
ITATES THE LINKING AND MERGING OF RECORDS
FOR USE IN THE HEALTH-CARE FIELD (U.S. CLS. 21,
23, 26, 36 AND 38).

ALICE SUE CARRUTHERS, EXAMINING ATTORNEY

SN 78-884,242. GENERAL ELECTRIC COMPANY, SCHE-
NECTADY, NY. FILED 5-16-2006.

LIGHTX

THE MARK CONSISTS OF STANDARD CHARACTERS
WITHOUT CLAIM TO ANY PARTICULAR FONT, STYLE,
SIZE, OR COLOR.

FOR LIGHTING CONTROL SOFTWARE FOR USE IN
COMMERCIAL AND INDUSTRIAL FACILITIES (U.S.
CLS. 21, 23, 26, 36 AND 38).

KATHERINE E. HALMEN, EXAMINING ATTORNEY

CLASS 9—(Continued).

SN 78-885,706. DEPARTMENT OF THE ARMY, ARLINGTON, VA. FILED 5-17-2006.

ATMAS

THE MARK CONSISTS OF STANDARD CHARACTERS WITHOUT CLAIM TO ANY PARTICULAR FONT, STYLE, SIZE, OR COLOR.

FOR COMPUTER SOFTWARE FOR USE AS A DATABASE, CALENDARING, AND TASKING PROGRAM IN THE MANAGEMENT OF CULTURAL RESOURCES (U.S. CLS. 21, 23, 26, 36 AND 38).

FIRST USE 1-20-2006; IN COMMERCE 1-20-2006.
HOWARD B. LEVINE, EXAMINING ATTORNEY

SN 78-887,844. UNIVERSAL CITY STUDIOS LLLP, UNIVERSAL CITY, CA. FILED 5-19-2006.

THE LOOK AND SOUND OF PERFECT

THE MARK CONSISTS OF STANDARD CHARACTERS WITHOUT CLAIM TO ANY PARTICULAR FONT, STYLE, SIZE, OR COLOR.

FOR PRE-RECORDED AUDIO, VIDEO AND AUDIO VISUAL RECORDINGS ALL FEATURING MOTION PICTURES, TELEVISION PROGRAMS, MUSIC AND ENTERTAINMENT PROGRAMS; BLANK DVDS, CD-ROMS AND CDS FOR RECORDING SOUND AND VIDEO (U.S. CLS. 21, 23, 26, 36 AND 38).

DEIRDRE ROBERTSON, EXAMINING ATTORNEY

SN 78-887,959. BELDEN TECHNOLOGIES, INC., ST. LOUIS, MO. FILED 5-19-2006.

XTRA·GUARD

THE MARK CONSISTS OF STANDARD CHARACTERS WITHOUT CLAIM TO ANY PARTICULAR FONT, STYLE, SIZE, OR COLOR.

OWNER OF U.S. REG. NO. 1,356,390.
FOR ELECTRONIC WIRE AND CABLES (U.S. CLS. 21, 23, 26, 36 AND 38).

FIRST USE 12-18-1984; IN COMMERCE 12-18-1984.
DAVID ELTON, EXAMINING ATTORNEY

CLASS 9—(Continued).

SN 78-887,964. BELDEN TECHNOLOGIES, INC., ST. LOUIS, MO. FILED 5-19-2006.

XTREME PERFORMANCE FOR XTREME ENVIRONMENTS

THE MARK CONSISTS OF STANDARD CHARACTERS WITHOUT CLAIM TO ANY PARTICULAR FONT, STYLE, SIZE, OR COLOR.

FOR ELECTRICAL AND ELECTRONIC WIRE AND CABLE (U.S. CLS. 21, 23, 26, 36 AND 38).

FIRST USE 5-1-2006; IN COMMERCE 5-1-2006.

DAVID ELTON, EXAMINING ATTORNEY

SN 78-889,781. CAMBRIDGE VISCOSITY, INC., MEDFORD, MA. FILED 5-23-2006.



THE MARK CONSISTS OF A DESIGN SUGGESTING LIQUID FLOWING FROM A PIPE.

FOR DEVICES FOR SENSING AND MEASURING THE PROPERTIES OF LIQUIDS, NAMELY VISCOMETERS (U.S. CLS. 21, 23, 26, 36 AND 38).

WENDY GOODMAN, EXAMINING ATTORNEY

SN 78-890,010. SAF-T-GARD INTERNATIONAL, INC., NORTHBROOK, IL. FILED 5-23-2006.

MECHANI-GARD

THE MARK CONSISTS OF STANDARD CHARACTERS WITHOUT CLAIM TO ANY PARTICULAR FONT, STYLE, SIZE, OR COLOR.

FOR PROTECTIVE WORK GLOVES AND APPAREL IN THE NATURE OF PROTECTIVE CLOTHING (U.S. CLS. 21, 23, 26, 36 AND 38).

FIRST USE 5-23-2006; IN COMMERCE 5-23-2006.
ROBERT LAVACHE, EXAMINING ATTORNEY

CLASS 9—(Continued).

SN 78-890,027. SAF-T-GARD INTERNATIONAL, INC.,
NORTHBROOK, IL. FILED 5-23-2006.

REFLECT-A-GARD

THE MARK CONSISTS OF STANDARD CHARACTERS
WITHOUT CLAIM TO ANY PARTICULAR FONT, STYLE,
SIZE, OR COLOR.

FOR PROTECTIVE WORK GLOVES AND APPAREL
IN THE NATURE OF PROTECTIVE CLOTHING (U.S.
CLS. 21, 23, 26, 36 AND 38).

FIRST USE 5-23-2006; IN COMMERCE 5-23-2006.
ROBERT LAVACHE, EXAMINING ATTORNEY

CLASS 9—(Continued).

SN 78-893,678. GENERAL ELECTRIC COMPANY, SCHE-
NECTADY, NY. FILED 5-26-2006.

WINDFREE

THE MARK CONSISTS OF STANDARD CHARACTERS
WITHOUT CLAIM TO ANY PARTICULAR FONT, STYLE,
SIZE, OR COLOR.

FOR COMPUTER HARDWARE; DOWNLOADABLE
SOFTWARE FOR THE OPERATION OF WIND FARMS
AND WIND TURBINES (U.S. CLS. 21, 23, 26, 36 AND 38).
KATHERINE E. HALMEN, EXAMINING ATTORNEY

SN 78-890,191. SUNTIGER, INC., CALABASAS, CA. FILED 5-
23-2006.

ASTI

THE MARK CONSISTS OF STANDARD CHARACTERS
WITHOUT CLAIM TO ANY PARTICULAR FONT, STYLE,
SIZE, OR COLOR.

FOR EYEGLASSES; SPECTACLES; SUNGLASSES;
EYEGLASS CASES, CLIPS, HOLDERS AND CHAINS;
EYEGLASS AND OPTICAL LENSES, EYEGLASS
FRAMES; PROTECTIVE EYEWEAR (U.S. CLS. 21, 23,
26, 36 AND 38).

FIRST USE 5-14-2004; IN COMMERCE 5-14-2004.
SONYA STEPHENS, EXAMINING ATTORNEY

SN 78-898,830. BENTLEY KINETICS, INC., BEDFORD, NH.
FILED 6-2-2006.

KINESYNC

THE MARK CONSISTS OF STANDARD CHARACTERS
WITHOUT CLAIM TO ANY PARTICULAR FONT, STYLE,
SIZE, OR COLOR.

FOR SOFTWARE FOR THE CAPTURE, ANALYSIS,
SYNCHRONIZATION, AND GRAPHIC REPRESENTA-
TION OF DATA COLLECTED FROM MOTION CAP-
TURE SENSORS MOUNTED ON A USERS BODY (U.S.
CLS. 21, 23, 26, 36 AND 38).

FIRST USE 1-25-2006; IN COMMERCE 1-25-2006.
JEFFERY COWARD, EXAMINING ATTORNEY

SN 78-893,093. DELPHI TECHNOLOGIES, INC., TROY, MI.
FILED 5-25-2006.

DELPHI

THE MARK CONSISTS OF STANDARD CHARACTERS
WITHOUT CLAIM TO ANY PARTICULAR FONT, STYLE,
SIZE, OR COLOR.

FOR ELECTRONIC SPEED AND DIRECTION CON-
TROLLERS FOR WHEELCHAIRS (U.S. CLS. 21, 23, 26, 36
AND 38).

CHRISTINE COOPER, EXAMINING ATTORNEY

SN 78-899,226. WMS GAMING INC., WAUKEGAN, IL.
FILED 6-2-2006.

DOUBLE LIFE OF LUXURY

THE MARK CONSISTS OF STANDARD CHARACTERS
WITHOUT CLAIM TO ANY PARTICULAR FONT, STYLE,
SIZE, OR COLOR.

OWNER OF U.S. REG. NO. 2,317,146.
FOR GAMING MACHINES (U.S. CLS. 21, 23, 26, 36
AND 38).

GEORGE LORENZO, EXAMINING ATTORNEY

CLASS 9—(Continued).

SN 78-900,114. IMATE SUPPLY CORP., JUNGHE CITY, TAIWAN, FILED 6-5-2006.

3CMate

THE MARK CONSISTS OF STANDARD CHARACTERS WITHOUT CLAIM TO ANY PARTICULAR FONT, STYLE, SIZE, OR COLOR.

FOR AMPLIFIERS; CARD READERS FOR CREDIT CARDS; CHIP CARD READERS; COMPUTER GAME JOYSTICKS; COMPUTER JOYSTICKS; COMPUTER KEYBOARDS; COMPUTER MOUSE; COMPUTER NETWORK ADAPTERS; DEVICES FOR WIRELESS RADIO TRANSMISSION; DISC STORAGE CONTAINERS; DUST COVERS FOR COMPUTERS; FIBER OPTIC CABLES; FLASH CARD READERS; LAN (LOCAL AREA NETWORK) ACCESS POINTS FOR CONNECTING NETWORK COMPUTER USERS; LAN (LOCAL AREA NETWORK) COMPUTER CARDS FOR CONNECTING PORTABLE COMPUTER DEVICES TO COMPUTER NETWORKS; LAPTOP CARRYING CASES; MAGNETIC CODED CARD READERS; MAGNETIC ENCODED CARD READERS; MAGNETIC HEAD CLEANERS; MOUSE PADS; NETWORK ACCESS SERVER HARDWARE; POWER WIRES; UNFILLED INK CARTRIDGES FOR PHOTOCOPY MACHINES OR COMPUTER PRINTERS (U.S. CLS. 21, 23, 26, 36 AND 38).

FIRST USE 10-19-2005; IN COMMERCE 10-19-2005.
GRETTA YAO, EXAMINING ATTORNEY

SN 78-901,002. ALTA HEIGHTS TECHNOLOGY CORPORATION, LOS GATOS, CA. FILED 6-5-2006.

One2OneMate

THE MARK CONSISTS OF STANDARD CHARACTERS WITHOUT CLAIM TO ANY PARTICULAR FONT, STYLE, SIZE, OR COLOR.

FOR COMPUTER APPLICATIONS AND OPERATING SOFTWARE AND HARDWARE FOR USE IN INDIVIDUALIZED STUDENT ASSESSMENT AND INSTRUCTION, USED TO IMPROVE SKILLS, MONITOR AND TRACK PERFORMANCE (U.S. CLS. 21, 23, 26, 36 AND 38).

CHRISTOPHER OTT, EXAMINING ATTORNEY

CLASS 9—(Continued).

SN 78-902,808. SHARP KABUSHIKI KAISHA, TA SHARP CORPORATION, OSAKA, JAPAN, FILED 6-7-2006.

THE BRAIN EXERCISER

THE MARK CONSISTS OF STANDARD CHARACTERS WITHOUT CLAIM TO ANY PARTICULAR FONT, STYLE, SIZE, OR COLOR.

FOR ELECTRONIC CALCULATORS (U.S. CLS. 21, 23, 26, 36 AND 38).

SKYE YOUNG, EXAMINING ATTORNEY

SN 78-903,258. ITRON, INC., SPOKANE, WA. FILED 6-7-2006.

OPENWAY

THE MARK CONSISTS OF STANDARD CHARACTERS WITHOUT CLAIM TO ANY PARTICULAR FONT, STYLE, SIZE, OR COLOR.

FOR METERING, COMMUNICATION AND CONTROL TECHNOLOGY, NAMELY, HARDWARE, SOFTWARE AND COMMUNICATION DEVICES THAT ENABLE UTILITIES AND ENERGY PROVIDERS TO GATHER UTILITY, ELECTRICITY, NATURAL GAS, AND WATER USAGE DATA TO SUPPORT TIME-BASED RATES AND ENABLE CONSUMERS AND BUSINESSES TO MAKE CHOICES ABOUT UTILITY, POWER, ENERGY AND WATER USAGE IN RESPONSE TO MARKET AND PRICE SIGNALS, AS WELL AS SYSTEM CONDITIONS; METERING, COMMUNICATION AND CONTROL TECHNOLOGY, NAMELY, HARDWARE, SOFTWARE AND COMMUNICATION DEVICES THAT PROVIDE ALERTS OF UTILITY, POWER OUTAGES, POWER RESTORATION AND WATER LEAKS; METERING, COMMUNICATION AND CONTROL TECHNOLOGY, NAMELY, HARDWARE, SOFTWARE AND COMMUNICATION DEVICES THAT PROVIDE CONSUMERS AND BUSINESSES WITH ACCESS TO THEIR USAGE DATA AND PROVIDE REMOTE DISCONNECTION AND RECONNECTION OF UTILITY SERVICES; SOFTWARE AND HARDWARE PLATFORM FOR CONNECTIVITY TO AND MANAGEMENT OF IN-HOME APPLIANCES AND DEVICES SUCH AS THERMOSTATS, WATER HEATERS, POOL HEATERS, DIRECTLY OR VIA IN-HOME GATEWAY(S) SO THAT USE OF THOSE DEVICES CAN BE ALTERED AS CONDITIONS WARRANT; COMMUNICATION HARDWARE AND SOFTWARE FOR USE IN THE UTILITY, POWER, ENERGY AND WATER INDUSTRIES; UTILITY, SOLID-STATE ELECTRICITY METERS, NATURAL GAS AND WATER METERS, UTILITY TELEMETRY DEVICES; DATA COLLECTION COMPUTER AND COMMUNICATION NETWORK SYSTEMS COMPRISED OF COMPUTER HARDWARE, COMPUTER OPERATING SOFTWARE AND COMPUTER SOFTWARE FOR DATA COLLECTION APPLICATIONS, NAMELY, AUTOMATED METER READING, DISTRIBUTION AUTOMATION, TWO-WAY COMMUNICATIONS BETWEEN NETWORKS AND UTILITY METERS, AND DEMAND SIDE MANAGEMENT APPLICATIONS VIA THE INTERNET, INTRANETS, EXTRANETS, RADIO FREQUENCY NETWORKS, SATELLITE, WIRELESS NETWORKS, TELEPHONE LINES, AND INTEGRATED COMMUNICATIONS NETWORKS, NAMELY, PUBLIC SWITCHED TELEPHONE NETWORKS, VIRTUAL PRIVATE NETWORKS, PRIVATE NETWORKS, PUBLIC NETWORKS, AND CELLULAR NETWORKS, ALL FOR USE IN THE UTILITY, POWER,

CLASS 9—(Continued).

ENERGY AND WATER INDUSTRIES; METER INTERFACE UNITS COMPRISED OF DIGITAL, MECHANICAL AND OPTICAL SENSORS, ENCODERS AND TRANSMITTERS; INBOUND, OUTBOUND, TWO-WAY COMMUNICATION SYSTEMS, NAMELY, COMPUTER HARDWARE, COMPUTER OPERATING SOFTWARE AND COMPUTER SOFTWARE FOR DATA COLLECTION AND REMOTE PROGRAMMING APPLICATIONS, NAMELY, ONE-WAY AND TWO-WAY AUTOMATED METER READING, DISTRIBUTION AUTOMATION, REMOTE COMMUNICATIONS BETWEEN NETWORKS AND BETWEEN AND AMONG UTILITY METERS, AND DEMAND SIDE MANAGEMENT APPLICATIONS VIA THE INTERNET, INTRANETS, EXTRANETS, RADIO FREQUENCY NETWORKS, SATELLITE, WIRELESS NETWORKS, TELEPHONE LINES, AND INTEGRATED COMMUNICATIONS NETWORKS, NAMELY, PUBLIC SWITCHED TELEPHONE NETWORKS, IP-BASED PUBLIC NETWORKS, VIRTUAL PRIVATE NETWORKS, PRIVATE NETWORKS, POWERLINE AND BROADBAND OVER POWERLINE NETWORKS, PUBLIC NETWORKS AND CELLULAR NETWORKS FOR ENERGY, WATER AND FUEL DATA, AND OTHER UTILITY METER MONITORING POINTS; TELEPHONE, CELLULAR AND RADIO TRANSRECEIVERS, INTELLIGENT COMMUNICATION ADAPTERS, AND SWITCHPOINTS FOR USE IN THE UTILITY, POWER, ENERGY AND WATER INDUSTRIES (U.S. CLS. 21, 23, 26, 36 AND 38).
KATHLEEN M. VANSTON, EXAMINING ATTORNEY

SN 78-904,778. NEXPLORE TECHNOLOGIES, INC., FRISCO, TX. FILED 6-9-2006.

ZAPCASTER

THE MARK CONSISTS OF STANDARD CHARACTERS WITHOUT CLAIM TO ANY PARTICULAR FONT, STYLE, SIZE, OR COLOR.

FOR COMPUTER SOFTWARE, NAMELY, FILE TRANSFER SOFTWARE (U.S. CLS. 21, 23, 26, 36 AND 38).

CAROL SPILS, EXAMINING ATTORNEY

SN 78-905,429. MARKETING AND CREATIVE SALES, INC., CHESTERFIELD, MO. FILED 6-10-2006.

U TUNE IT

THE MARK CONSISTS OF STANDARD CHARACTERS WITHOUT CLAIM TO ANY PARTICULAR FONT, STYLE, SIZE, OR COLOR.

FOR ELECTRIC DOORBELLS; AUDIO RECORDERS (U.S. CLS. 21, 23, 26, 36 AND 38).

DAVID COLLIER, EXAMINING ATTORNEY

CLASS 9—(Continued).

SN 78-906,764. EVEREADY BATTERY COMPANY, INC., ST. LOUIS, MO. FILED 6-13-2006.

DOCK & GO

THE MARK CONSISTS OF STANDARD CHARACTERS WITHOUT CLAIM TO ANY PARTICULAR FONT, STYLE, SIZE, OR COLOR.

FOR BATTERIES; BATTERY CHARGERS (U.S. CLS. 21, 23, 26, 36 AND 38).

DORITT L. CARROLL, EXAMINING ATTORNEY

SN 78-907,044. SONY ONLINE ENTERTAINMENT LLC, CULVER CITY, CA. FILED 6-13-2006.

STATION LAUNCHER

THE MARK CONSISTS OF STANDARD CHARACTERS WITHOUT CLAIM TO ANY PARTICULAR FONT, STYLE, SIZE, OR COLOR.

OWNER OF U.S. REG. NO. 2,807,396.

NO CLAIM IS MADE TO THE EXCLUSIVE RIGHT TO USE "LAUNCHER", APART FROM THE MARK AS SHOWN.

FOR COMPUTER SOFTWARE FOR USE IN LAUNCHING COMPUTER APPLICATIONS, INTERNET CHAT AND MESSAGING, INTERACTING WITH ONLINE GAME SERVERS, AND RETRIEVING AND DISPLAYING WEB MATERIAL, AND AUDIO VISUAL CONTENT (U.S. CLS. 21, 23, 26, 36 AND 38).

KATHERINE CONNOLLY, EXAMINING ATTORNEY

SN 78-907,280. DIEBOLD, INCORPORATED, NORTH CANTON, OH. FILED 6-13-2006.

AGILIS EMPOWER

THE MARK CONSISTS OF STANDARD CHARACTERS WITHOUT CLAIM TO ANY PARTICULAR FONT, STYLE, SIZE, OR COLOR.

OWNER OF U.S. REG. NOS. 2,770,359 AND 2,774,140.

FOR SOFTWARE FOR OPERATING AUTOMATED TRANSACTION MACHINES, NAMELY, SOFTWARE FOR OPERATING AUTOMATED BANKING MACHINES OR AUTOMATED TELLER MACHINES THAT RESIDES ON THE AUTOMATED BANKING MACHINE OR AUTOMATED TELLER MACHINE THAT CAUSES THE AUTOMATED BANKING MACHINE OR AUTOMATED TELLER MACHINE TO PERFORM FINANCIAL TRANSACTIONS (U.S. CLS. 21, 23, 26, 36 AND 38).

BRIDGETT SMITH, EXAMINING ATTORNEY

CLASS 9—(Continued).

SN 78-907,506. DIEBOLD, INCORPORATED, NORTH CANTON, OH. FILED 6-13-2006.

VERICOUNT TABULATOR

THE MARK CONSISTS OF STANDARD CHARACTERS WITHOUT CLAIM TO ANY PARTICULAR FONT, STYLE, SIZE, OR COLOR.

NO CLAIM IS MADE TO THE EXCLUSIVE RIGHT TO USE "TABULATOR", APART FROM THE MARK AS SHOWN.

FOR BAR CODE READERS (U.S. CLS. 21, 23, 26, 36 AND 38).

BRIDGETT SMITH, EXAMINING ATTORNEY

SN 78-909,770. ZYLOWARE CORPORATION, LONG ISLAND CITY, NY. FILED 6-16-2006.

GET IT?

THE MARK CONSISTS OF STANDARD CHARACTERS WITHOUT CLAIM TO ANY PARTICULAR FONT, STYLE, SIZE, OR COLOR.

FOR EYEGLASSES, EYEGLASS FRAMES, SUNGLASSES AND SUNGLASS FRAMES (U.S. CLS. 21, 23, 26, 36 AND 38).

DARRYL SPRUILL, EXAMINING ATTORNEY

CLASS 9—(Continued).

SN 78-911,768. CASH ONLY PRODUCTIONS, LOS ANGELES, CA. FILED 6-19-2006.



THE APPLICANT CLAIMS COLOR AS A FEATURE OF THE MARK, NAMELY, RED, WHITE AND BLACK.

THE MARK CONSISTS OF A WHITE SKULL AND A WHITE BULLET WHICH BULLET HAS JUST EXITED THE SKULL THROUGH ONE TEMPLE FRAME RIGHT HAVING ENTERED THE SKULL THROUGH THE OPPOSITE TEMPLE FRAME LEFT, AN ARCHED RED "UNDERGROUND" ABOVE THE SKULL WHEREIN THE ARCH PROCEEDS CLOCKWISE, AND AN ARCHED RED "BOUNTY HUNTER" BENEATH THE SKULL WHEREIN THE ARCH PROCEEDS COUNTERCLOCKWISE, ALL OF THE AFOREMENTIONED ON A BLACK BACKGROUND.

FOR COMPUTER GAME SOFTWARE; INTERACTIVE VIDEO GAME PROGRAMS; MULTIMEDIA SOFTWARE RECORDED ON CD-ROM FEATURING ACTION ADVENTURE; VIDEO GAME SOFTWARE; VIRTUAL REALITY GAME SOFTWARE (U.S. CLS. 21, 23, 26, 36 AND 38).

LINDA ESTRADA, EXAMINING ATTORNEY

SN 78-921,946. JACK HENRY SOFTWARE/COMMLINK, L.P., MONETT, MO. FILED 7-3-2006.

PROFITSTARS SYNERGY

THE MARK CONSISTS OF STANDARD CHARACTERS WITHOUT CLAIM TO ANY PARTICULAR FONT, STYLE, SIZE, OR COLOR.

OWNER OF U.S. REG. NOS. 2,522,151, 2,827,531 AND 2,827,532.

FOR COMPUTER SOFTWARE MARKETED AND SOLD PRIMARILY TO BANKS AND OTHER FINANCIAL INSTITUTIONS FOR DOCUMENT IMAGING (U.S. CLS. 21, 23, 26, 36 AND 38).

JAY BESCH, EXAMINING ATTORNEY

CLASS 9—(Continued).

SN 78-933,614. DEAN, THOMAS M, HIRAM, GA. FILED 7-20-2006.

lobie

THE MARK CONSISTS OF STANDARD CHARACTERS WITHOUT CLAIM TO ANY PARTICULAR FONT, STYLE, SIZE, OR COLOR.

FOR PERSONAL HEADPHONES FOR USE WITH SOUND TRANSMITTING SYSTEMS (U.S. CLS. 21, 23, 26, 36 AND 38).

KELLY MCCOY, EXAMINING ATTORNEY

SN 78-935,692. VIACOM INTERNATIONAL INC., NEW YORK, NY. FILED 7-24-2006.

VMTV

THE MARK CONSISTS OF STANDARD CHARACTERS WITHOUT CLAIM TO ANY PARTICULAR FONT, STYLE, SIZE, OR COLOR.

FOR COMPUTER GAME SOFTWARE, COMPUTER GAME PROGRAMS, COMPUTER GAME SOFTWARE THAT MAY BE DOWNLOADED FROM A GLOBAL COMPUTER NETWORK, COMPUTER GAME CARTRIDGES TO BE USED IN COMPUTER GAME MACHINES ADAPTED FOR USE WITH TELEVISION RECEIVERS (U.S. CLS. 21, 23, 26, 36 AND 38).

SUSAN RICHARDS, EXAMINING ATTORNEY

SN 78-935,696. VIACOM INTERNATIONAL INC., NEW YORK, NY. FILED 7-24-2006.

VLB

THE MARK CONSISTS OF STANDARD CHARACTERS WITHOUT CLAIM TO ANY PARTICULAR FONT, STYLE, SIZE, OR COLOR.

FOR COMPUTER GAME SOFTWARE, COMPUTER GAME PROGRAMS, COMPUTER GAME SOFTWARE THAT MAY BE DOWNLOADED FROM A GLOBAL COMPUTER NETWORK, COMPUTER GAME CARTRIDGES TO BE USED IN COMPUTER GAME MACHINES ADAPTED FOR USE WITH TELEVISION RECEIVERS (U.S. CLS. 21, 23, 26, 36 AND 38).

SUSAN RICHARDS, EXAMINING ATTORNEY

CLASS 9—(Continued).

SN 78-960,270. WMS GAMING INC., WAUKEGAN, IL. FILED 8-25-2006.

BLUE MOON

THE MARK CONSISTS OF STANDARD CHARACTERS WITHOUT CLAIM TO ANY PARTICULAR FONT, STYLE, SIZE, OR COLOR.

FOR GAMING MACHINES THAT GENERATE OR DISPLAY WAGER OUTCOMES; GAMING SOFTWARE THAT GENERATES OR DISPLAYS WAGER OUTCOMES OF GAMING MACHINES (U.S. CLS. 21, 23, 26, 36 AND 38).

GEORGE LORENZO, EXAMINING ATTORNEY

SN 78-976,970. ROOM 40 LLC, CHICAGO, IL. FILED 8-30-2005.

ROOM 40

THE MARK CONSISTS OF STANDARD CHARACTERS WITHOUT CLAIM TO ANY PARTICULAR FONT, STYLE, SIZE, OR COLOR.

FOR SOFTWARE FOR DATA MINING, SEGMENTATION ANALYSIS AND PROFILING, MARKET MODELING AND RESULTS TRACKING OF MARKETING CAMPAIGNS, ALL IN THE FIELD OF MARKET RESEARCH AND STRATEGY (U.S. CLS. 21, 23, 26, 36 AND 38).

SUSAN STIGLITZ, EXAMINING ATTORNEY

SN 78-977,592. BRIDGELUX, INC., SUNNYVALE, CA. FILED 4-11-2006.

DELIVERING BRILLIANCE

THE MARK CONSISTS OF STANDARD CHARACTERS WITHOUT CLAIM TO ANY PARTICULAR FONT, STYLE, SIZE, OR COLOR.

FOR LIGHT EMITTING DIODE CHIPS (U.S. CLS. 21, 23, 26, 36 AND 38).

FIRST USE 5-7-2006; IN COMMERCE 5-7-2006.
HANNO RITTNER, EXAMINING ATTORNEY

CLASS 9—(Continued).

SN 79-015,313. TIMELESS, FRANCE, FILED 8-18-2005.

MISTERPINK

PRIORITY DATE OF 2-23-2005 IS CLAIMED.
OWNER OF INTERNATIONAL REGISTRATION 0862103
DATED 8-18-2005, EXPIRES 8-18-2015.

FOR COMPUTER SOFTWARE FOR RETAIL MANAGEMENT AND SUPPLY CHAIN OPTIMIZATION, COMPUTER SOFTWARE FOR SINGLE AND MULTIPLE CHANNEL RETAILERS, AND COMPUTER SOFTWARE FOR USE BY SPECIALTY AND GENERAL MERCHANDISE RETAIL CHAINS AND OUTLETS, SUPERSTORES, AND DEPARTMENT STORES, ALL FOR SALES AND DEMAND FORECASTING, STORE AND WAREHOUSE INVENTORY MANAGEMENT, MERCHANDISE PLANNING AND ALLOCATION, STOCK CONTROL, PRODUCT TRACKING, DELIVERIES, RECEPTIONS, REPLENISHMENT, PROCUREMENT, MERCHANDISING, DISTRIBUTION, CUSTOMER FOLLOW-UPS, SALES ANALYSIS ACROSS DISTRIBUTION CHANNELS, SALES, CUSTOMER RELATIONSHIP MANAGEMENT (CRM) AND CRM DATA COMPILATION AND ANALYSIS (U.S. CLS. 21, 23, 26, 36 AND 38).

ANDREA SAUNDERS, EXAMINING ATTORNEY

SN 79-016,621. HUBER+SUHNER AG, SWITZERLAND,
FILED 9-9-2005.

SUCOFLEX

THE MARK CONSISTS OF STANDARD CHARACTERS WITHOUT CLAIM TO ANY PARTICULAR FONT, STYLE, SIZE, OR COLOR.

PRIORITY DATE OF 4-22-2005 IS CLAIMED.

OWNER OF INTERNATIONAL REGISTRATION 0865633
DATED 9-9-2005, EXPIRES 9-9-2015.

OWNER OF U.S. REG. NOS. 1,213,985 AND 1,545,193.

FOR APPARATUS AND INSTRUMENTS FOR CONDUCTING, SWITCHING, TRANSFORMING, ACCUMULATING, REGULATING OR CONTROLLING ELECTRICITY; NAMELY, ELECTRIC CONDUCTORS, ELECTRIC SWITCHES, ELECTRIC TRANSFORMERS, ELECTRIC ACCUMULATORS, VOLTAGE REGULATORS FOR ELECTRIC POWER, ELECTRIC CONTROLLERS; ELECTRIC WIRES AND CABLES, ELECTRIC CABLE AND ELECTRICITY CONNECTOR SYSTEMS, COMPRISED OF ELECTRIC CABLE AND ELECTRIC CONNECTORS, HIGH-FREQUENCY ELECTRIC CONNECTORS AND HIGH-FREQUENCY ELECTRIC CABLES; MICROWAVE COMPONENTS, NAMELY ANTENNAS, CABLES, FILTERS AND CONNECTORS; COMPONENTS FOR FIBER OPTIC TECHNOLOGIES, NAMELY FIBER OPTIC CABLES, CONNECTORS AND CONVERTERS, FINE VARNISHED WIRES INCLUDED IN THIS CLASS; NAMELY, WINDING WIRES AND POWER WIRES; HEAT-SHRINKABLE ELECTRIC CONNECTOR BOOTS, BRANCHING POINTS FOR ELECTRIC WIRES AND CABLES (U.S. CLS. 21, 23, 26, 36 AND 38).

ERNEST SHOSHO, EXAMINING ATTORNEY

CLASS 9—(Continued).

SN 79-016,725. QIU BINGZHEN, CHINA, FILED 1-24-2005.

**欧多尔**

올도이오디오

OWNER OF INTERNATIONAL REGISTRATION 0865883
DATED 1-24-2005, EXPIRES 1-24-2015.

THE FIRST CHINESE CHARACTER TRANSLITERATED AS "OU", GENERALLY MEANS "EUROPE", HERE HAS NO MEANING; SECOND CHINESE CHARACTER TRANSLITERATED AS "DUO" GENERALLY MEANS "MANY, PLENTY OF"; THE THIRD CHINESE CHARACTER TRANSLITERATED AS "ER" IS A MODAL WORD, HAS NO MATERIAL MEANING; THE COMBINATION OF THE THREE WORDS HERE HAS NO MATERIAL MEANING.

THE NON-LATIN CHARACTER(S) IN THE MARK TRANSLITERATES INTO WALDO IODIO, AND THIS MEANS "EUROPE" AND "MANY" IN ENGLISH.

FOR COMPUTERS; TELEPHONES; MICROPHONES; SOUND MIXERS, NAMELY, ELECTRIC EQUIPMENT FOR MIXING AUDIO SOUNDS; CABINETS FOR LOUDSPEAKERS; LOUDSPEAKERS; AMUSEMENT APPARATUS ADAPTED FOR USE WITH TELEVISION RECEIVERS ONLY, NAMELY, VIDEO GAME MACHINES FOR USE WITH TELEVISIONS; ACOUSTIC CONDUITS; PHOTOGRAPHIC CAMERAS; ELECTRIC IRONS (U.S. CLS. 21, 23, 26, 36 AND 38).

SUNG IN, EXAMINING ATTORNEY

SN 79-016,845. FEINMETALL GMBH, FED REP GERMANY,
FILED 9-2-2005.

Direct Attach ViProbe

THE MARK CONSISTS OF STANDARD CHARACTERS WITHOUT CLAIM TO ANY PARTICULAR FONT, STYLE, SIZE, OR COLOR.

PRIORITY DATE OF 5-18-2005 IS CLAIMED.

OWNER OF INTERNATIONAL REGISTRATION 0866274
DATED 9-2-2005, EXPIRES 9-2-2015.

NO CLAIM IS MADE TO THE EXCLUSIVE RIGHT TO USE "DIRECT ATTACH", APART FROM THE MARK AS SHOWN.

FOR ELECTRIC CONTACT DEVICES, NAMELY PROBECARDS AND TEST HEADS FOR ELECTRICAL TESTING, MAINLY CONSISTING OF ELECTRIC CONTACTS, RECEPTACLES FOR THE CONTACTS, PROBE NEEDLES, CONTACT PROBES, PITCH PROBES, PNEUMATIC PROBES, SHORT TRAVEL PROBES, STANDARD PROBES, WIRE HARNESS PROBES AND ADAPTER (U.S. CLS. 21, 23, 26, 36 AND 38).

DOMINICK J. SALEMI, EXAMINING ATTORNEY

CLASS 9—(Continued).

SN 79-017,388. Q-GEAR AUSTRALIA PTY LTD, VIC, AUSTRALIA, FILED 8-2-2005.

Q キューギヤ
Q-GEAR

OWNER OF INTERNATIONAL REGISTRATION 0867495 DATED 8-2-2005, EXPIRES 8-2-2015.

THE NON-LATIN CHARACTERS IN THE MARK TRANSLITERATE TO "KYU GI YA" AND THIS MEANS "Q-GEAR" IN ENGLISH.

FOR COMPUTER HARDWARE; COMPUTER PERIPHERALS, PARTS AND ACCESSORIES NAMELY, PRINTERS, MOUSE, KEYBOARDS, ELECTRONIC COMPUTER LOCKS, COMPUTER SPEAKERS; DATA PROCESSORS; PORTABLE COMPUTER CARRY BAGS; CASES TO CARRY CDS AND DVDS (U.S. CLS. 21, 23, 26, 36 AND 38).

JOHN GARTNER, EXAMINING ATTORNEY

CLASS 9—(Continued).

SN 79-018,298. RIETER INGOLSTADT SPINNEREIMASCHINENBAU AG, 85055 INGOLSTADT, FED REP GERMANY, FILED 9-21-2004.

AUTOset

THE MARK CONSISTS OF STANDARD CHARACTERS WITHOUT CLAIM TO ANY PARTICULAR FONT, STYLE, SIZE, OR COLOR.

PRIORITY DATE OF 3-29-2004 IS CLAIMED.

OWNER OF INTERNATIONAL REGISTRATION 0869854 DATED 9-21-2004, EXPIRES 9-21-2014.

FOR ELECTRONIC CONTROL DEVICES, NAMELY, COMPUTERS FOR MONITORING AND CONTROLLING SLIVER INSPECTION, SLIVER ACCEPTANCE AND/OR SLIVER PREPARATION ON TEXTILE MACHINES (U.S. CLS. 21, 23, 26, 36 AND 38).

SUSAN BILLHEIMER, EXAMINING ATTORNEY

SN 79-018,198. MICROPRÉCISION ÉLECTRONICS S.A., SWITZERLAND, FILED 9-30-2005.



OWNER OF INTERNATIONAL REGISTRATION 0302272 DATED 9-10-1965, EXPIRES 9-10-2015.

FOR ELECTRONIC AUTOMATION COMPONENTS AND APPARATUS, NAMELY ELECTRONIC SWITCHES FOR AUTOMATION, ELECTRONIC MICRO-SWITCHES FOR AUTOMATION, AND ELECTRONIC PROXIMITY SENSORS; AND CONNECTORS AND INTERFACE BOXES FOR ELECTRICAL WIRING (U.S. CLS. 21, 23, 26, 36 AND 38).

LEIGH LOWRY, EXAMINING ATTORNEY

SN 79-018,593. LOUIS VUITTON MALLETIER, FRANCE, FILED 11-3-2005.

LV LANDSCAPE

THE MARK CONSISTS OF STANDARD CHARACTERS WITHOUT CLAIM TO ANY PARTICULAR FONT, STYLE, SIZE, OR COLOR.

PRIORITY DATE OF 5-13-2005 IS CLAIMED.

OWNER OF INTERNATIONAL REGISTRATION 0870865 DATED 11-3-2005, EXPIRES 11-3-2015.

OWNER OF U.S. REG. NO. 2,909,002.

FOR SPECTACLES; SUNGLASSES; SPECTACLE FRAMES; SPECTACLE LENSES, NAMELY, GLASS LENSES, PLASTIC LENSES, CORRECTIVE LENSES, PROGRESSIVE LENSES, LENSES FOR SUNGLASSES, POLARIZED LENSES, TINTED LENSES, PHOTOCHROMIC LENSES, LIGHT-SENSITIVE LENSES, TREATED LENSES, COATED LENSES, ANTI-REFLECTIVE LENSES; SPECTACLE CASES (U.S. CLS. 21, 23, 26, 36 AND 38).

PRISCILLA MILTON, EXAMINING ATTORNEY

CLASS 9—(Continued).

SN 79-020,385. SONY ERICSSON MOBILE COMMUNICATIONS AB, SWEDEN, FILED 4-21-2005.

P700

PRIORITY DATE OF 10-21-2004 IS CLAIMED.
OWNER OF INTERNATIONAL REGISTRATION 0875424
DATED 4-21-2005, EXPIRES 4-21-2015.

FOR TELECOMMUNICATIONS APPARATUS AND INSTRUMENTS, NAMELY TELEPHONE HANDSETS, TELEPHONE EAR PIECES, HANDS-FREE SETS AND TELEPHONE HOLDERS; CELLULAR TELEPHONES; MOBILE TELEPHONES; TELEPHONE EQUIPMENT CABINETS; TELEPHONE EQUIPMENT RACKS; TELEPHONE SWITCHING UNITS, SWITCHES AND RELAYS FOR TELEPHONE CONSOLES AND SWITCHBOARDS; AUDIO AMPLIFIERS; TELEPHONE RECEIVERS; TELEPHONES; FAX MACHINES; DISPLAY SCREENS, NAMELY COMPUTER DISPLAY SCREENS AND DISPLAY SCREENS FOR TELEPHONES; ELECTRONIC GAMES PROGRAMS; COMPONENT PARTS FOR TELECOMMUNICATIONS APPARATUS AND INSTRUMENTS, NAMELY, TELEPHONE HANDSETS, TELEPHONE EAR PIECES, HANDS-FREE TELEPHONE SETS AND TELEPHONE HOLDERS, CELLULAR TELEPHONES, MOBILE TELEPHONES, TELEPHONE SWITCHING UNITS, SWITCHES AND RELAYS FOR TELEPHONE CONSOLES AND SWITCHBOARDS, AUDIO AMPLIFIERS, TELEPHONE RECEIVERS; BATTERIES AND CHARGERS FOR TELECOMMUNICATIONS APPARATUS, NAMELY TELEPHONE HANDSETS, TELEPHONE EAR PIECES, HANDS-FREE TELEPHONE SETS AND TELEPHONE HOLDERS, CELLULAR TELEPHONES, MOBILE TELEPHONES; HEADSETS FOR USE IN RELATION TO HANDS-FREE USE OF TELEPHONES; TELEPHONE EAR PIECES FOR USE IN RELATION TO HANDS-FREE USE OF TELEPHONES; COMPUTER KEYBOARDS AND KEYBOARDS ON OR FOR USE IN CONJUNCTION WITH MOBILE TELEPHONES; DATA PROCESSING APPARATUS, NAMELY DATA MODEMS FOR HIGH SPEED DATA TRANSMISSIONS; MEDIA FOR RECORDING OR REPRODUCTION OF DATA, SOUND, IMAGES OR SIGNALS, NAMELY, BLANK AUDIO MAGNETIC TAPES, BLANK VIDEO MAGNETIC TAPES AND BLANK VIDEO DISCS; OPTICAL OR MAGNETIC APPARATUS AND INSTRUMENTS, NAMELY EYEGLASSES, SUNGLASSES AND BINOCULARS; COMPUTERS, COMPUTER TERMINALS; COMPUTER SOFTWARE, NAMELY, COMPUTER PROGRAMS IN RECORDED FORM AND FIXED IN ELECTRONIC MEMORY CIRCUITS FOR USE WITH TELECOMMUNICATION DEVICES FOR PLAYING ELECTRONIC GAMES, FOR THE TRANSMISSION, REPRODUCTION, RECEIVING, ACCESSING, SEARCHING, INDEXING AND RETRIEVING OF GAMES, IMAGES, MUSIC, SOUNDS, TEXT, MOVIES, VIDEO AND ANIMATIONS IN THE FIELD OF GENERAL ENTERTAINMENT AND DATA, FOR GENERAL DATABASE MANAGEMENT, FOR THE MANAGEMENT AND OPERATION OF WIRELESS COMMUNICATION DEVICES, FOR ENABLING AND SECURING ELECTRONIC TRANSACTIONS, AND FOR THE TRANSMISSION, REPRODUCTION, RECEIVING, ACCESSING, SEARCHING, INDEXING AND RETRIEVING OF GAMES, IMAGES, MUSIC, SOUNDS, TEXT, MOVIES, VIDEO AND ANIMATIONS IN THE FIELD OF GENERAL ENTERTAINMENT, AND DATA FROM COMPUTER OR COMMUNICATION NETWORKS; MEDIA FOR DATA STORAGE, NAMELY, BLANK SMART CARDS,

CLASS 9—(Continued).

BLANK MEMORY CHIPS AND BLANK MAGNETIC CARDS; ELECTRONIC PERSONAL ORGANIZERS; MULTI-MEDIA TERMINALS, NAMELY, COMPUTERS AND MOBILE TELEPHONES; DOWNLOADABLE ELECTRONIC PUBLICATIONS NAMELY, MAGAZINES AND MANUALS RELATING TO TELECOMMUNICATIONS; CINEMATOGRAPHIC AND PHOTOGRAPHIC APPARATUS AND INSTRUMENTS, NAMELY, STILL AND VIDEO CAMERAS, VIDEO VIEWING SCREENS AND VIEWFINDERS, ALL ADAPTED FOR USE WITH TELECOMMUNICATIONS DEVICES; PRINTERS (U.S. CLS. 21, 23, 26, 36 AND 38).

SOPHIA S. KIM, EXAMINING ATTORNEY

SN 79-022,705. SHENZHEN DONJIN COMMUNICATION; TECH CO., LTD., CHINA, FILED 2-17-2006.



OWNER OF INTERNATIONAL REGISTRATION 0881949
DATED 2-17-2006, EXPIRES 2-17-2016.

FOR DATA PROCESSING APPARATUS; COMPUTER PERIPHERAL DEVICES; COMPUTER SERIAL PORTS AND COMPUTER PARALLEL PORTS FOR USE WITH DATA PROCESSORS; COMPUTER MONITORS; ELECTRICAL INPUT CONTROLLER FOR USE WITH DATA PROCESSORS; COMPUTER CENTRAL PROCESSING UNIT; ACOUSTIC COUPLERS FOR USE WITH COMMUNICATIONS EQUIPMENT; SOUND RECORDING CARRIERS IN THE NATURE OF TAPE; ELECTRIC MONITORING APPARATUS, NAMELY COMPUTER MONITORS, TELEVISION MONITORS, VOICE DISPLAY MONITORS; NETWORK COMMUNICATION APPARATUS IN THE NATURE OF MODEMS, ANTENNAS, AERIALS (U.S. CLS. 21, 23, 26, 36 AND 38).

AMEETA JORDAN, EXAMINING ATTORNEY

CLASS 9—(Continued).

SN 79-022,873. SHENZHEN COLORFUL TECHNOLOGY; AND DEVELOPMENT CO., LTD., CHINA, FILED 2-28-2006.

COLORFUL

OWNER OF INTERNATIONAL REGISTRATION 0882709 DATED 2-28-2006, EXPIRES 2-28-2016.

FOR INTEGRATED CIRCUIT CARDS; COMPUTER SOFTWARE FOR DATABASE MANAGEMENT OR USE AS A SPREADSHEET AND WORD PROCESSING; NOTEBOOK COMPUTERS; LAPTOP COMPUTERS; FLOPPY DISK DRIVES FOR COMPUTERS; COMPACT DISK DRIVES FOR COMPUTERS; MAGNETIC DISK DRIVES FOR COMPUTERS; DIGITAL DISK DRIVES FOR COMPUTERS; COMPUTER HARDWARE, NAMELY, HARD DISKS AND MONITORS; INTEGRATED CIRCUITS (U.S. CLS. 21, 23, 26, 36 AND 38).

ATTIYA MALIK, EXAMINING ATTORNEY

CLASS 9—(Continued).

SN 79-023,474. CANON KABUSHIKI KAISHA, JAPAN, FILED 1-17-2006.



PRIORITY DATE OF 12-20-2005 IS CLAIMED.

OWNER OF INTERNATIONAL REGISTRATION 0883920 DATED 1-17-2006, EXPIRES 1-17-2016.

THE COLORS BLACK, RED, WHITE, YELLOW, GREEN AND BLUE ARE CLAIMED AS A FEATURE OF THE MARK.

THE MARK CONSISTS OF THE GEOMETRIC FIGURE ON THE LEFT WHICH HAS A FORWARD FACING RECTANGLE OF BLACK, A RIGHT HAND PORTION THAT IS RED AND THE TOP IS WHITE; A GEOMETRIC FIGURE ON THE RIGHT THAT HAS A FORWARD FACING RECTANGLE OF BLACK AND A RIGHT HAND PORTION THAT IS YELLOW, GREEN AND BLUE AND THE TOP IS WHITE.

FOR INKJET PRINTERS; LARGE FORMAT PRINTERS (U.S. CLS. 21, 23, 26, 36 AND 38).

KATHLEEN M. VANSTON, EXAMINING ATTORNEY

SN 79-023,074. OXAND, F-77210 AVON, FRANCE, FILED 4-18-2006.

SIMEO

OWNER OF INTERNATIONAL REGISTRATION 0882827 DATED 4-18-2006, EXPIRES 4-18-2016.

FOR MODELLING, SIMULATION AND PREDICTION SOFTWARE FOR CIVIL ENGINEERING, REAL ESTATE, MINING OR NAVAL INFRASTRUCTURE; SOFTWARE FOR MANAGEMENT OF INDUSTRIAL RISK, FOR DATABASE MANAGEMENT (U.S. CLS. 21, 23, 26, 36 AND 38).

JAMES MACFARLANE, EXAMINING ATTORNEY

SN 79-023,838. FLICKNTICK PTY LTD, AUSTRALIA, FILED 3-6-2006.

Speedymark

THE MARK CONSISTS OF STANDARD CHARACTERS WITHOUT CLAIM TO ANY PARTICULAR FONT, STYLE, SIZE, OR COLOR.

OWNER OF INTERNATIONAL REGISTRATION 0884891 DATED 3-6-2006, EXPIRES 3-6-2016.

FOR COMPUTER SOFTWARE FOR ENABLING PHOTOCOPIERS TO SCAN AND SEND DATA TO THE CPU (U.S. CLS. 21, 23, 26, 36 AND 38).

TRACY CROSS, EXAMINING ATTORNEY

CLASS 10—MEDICAL APPARATUS

SN 76-657,978. ORBUSNEICH MEDICAL, INC., FT. LAUDERDALE, FL. FILED 4-6-2006.



OWNER OF U.S. REG. NOS. 2,294,462 AND 2,441,793.
FOR MEDICAL STENTS (U.S. CLS. 26, 39 AND 44).
MELVIN AXILBUND, EXAMINING ATTORNEY

SN 76-658,940. SLEEP DEVICES, INC., KISSIMMEE, FL.
FILED 4-24-2006.

SONA PILLOW

THE MARK CONSISTS OF STANDARD CHARACTERS
WITHOUT CLAIM TO ANY PARTICULAR FONT, STYLE,
SIZE, OR COLOR.

NO CLAIM IS MADE TO THE EXCLUSIVE RIGHT TO
USE PILLOW, APART FROM THE MARK AS SHOWN.

FOR AIR PILLOWS FOR MEDICAL PURPOSES (U.S.
CLS. 26, 39 AND 44).

FIRST USE 3-2-2005; IN COMMERCE 3-2-2005.

HOWARD B. LEVINE, EXAMINING ATTORNEY

SN 78-674,854. DENTAL COMPONENTS, LLC, NEWBERG,
OR. FILED 7-20-2005.

DCI

THE MARK CONSISTS OF STANDARD CHARACTERS
WITHOUT CLAIM TO ANY PARTICULAR FONT, STYLE,
SIZE, OR COLOR.

FOR DENTAL AND MEDICAL APPARATUS, MA-
CHINES AND INSTRUMENTS, NAMELY, DENTAL
HANDPIECES, DENTAL HANDPIECE CONTROLS FOR
CONTROLLING THE FLOW OF AIR AND WATER TO
DENTAL HANDPIECES, DENTAL HANDPIECE FLUSH
SYSTEMS, COMPRISING DENTAL HANDPIECE LUBRI-
CANT, DENTAL HANDPIECE FOOT CONTROLS; DEN-
TAL SYRINGES, STERILIZERS FOR MEDICAL
PURPOSES, DELIVERY ARMS, DENTAL INSTRUMENT
TRAYS, DENTAL CHAIRS, INTRA-ORAL DENTAL
LIGHT SYSTEMS, APPARATUS FOR THE DELIVERY
AND MONITORING OF SEDATIVE GAS AND OXYGEN,
DENTAL MOUTH PROPS, OPERATORY AIR COMPRES-
SORS, TUBING, CONTROL VALVES FOR DENTAL USE
FOR CONTROLLING THE RATE OF FLOW OF SEDA-
TIVE GAS AND OXYGEN, VACUUM VALVES FOR
DENTAL USE, OPERATORY VACUUM PUMPS AND
TURBINES (U.S. CLS. 26, 39 AND 44).

FIRST USE 4-0-1987; IN COMMERCE 4-0-1987.

STEVEN JACKSON, EXAMINING ATTORNEY

CLASS 10—(Continued).

SN 78-685,495. BORYUNG MEDIENCE CO., LTD., SEOUL,
REPUBLIC OF KOREA, FILED 8-4-2005.



FOR THERMOMETERS FOR MEDICAL PURPOSES,
SPHYGMOMANOMETERS; STERILIZING APPARATUS,
NAMELY, PAPER BAGS AND ENVELOPES FOR STER-
ILIZING MEDICAL INSTRUMENTS; SPOONS FOR AD-
MINISTERING MEDICINE; BABIES' PACIFIERS;
FEEDING BOTTLE TEATS; BABIES' BOTTLES; FEED-
ING BOTTLE VALVES; TEETHING RINGS; CONTRA-
CEPTIVES; CONDOMS; PESSARIES; INJECTION
NEEDLES; NOSE INHALERS, NAMELY, ANESTHETIC
INHALER FOR MEDICAL PURPOSES, INHALERS FOR
THERAPEUTIC USE, INHALERS FOR USE AS A DE-
CONGESTANT FOR BABIES'S NOSES; NURSING BOT-
TLES; BREAST PUMPS; AND EAR PICKS (U.S. CLS. 26,
39 AND 44).

CAROLYN CATALDO, EXAMINING ATTORNEY

SN 78-697,503. RIC INVESTMENTS, LLC, WILMINGTON,
DE. FILED 8-22-2005.

QUO

THE MARK CONSISTS OF STANDARD CHARACTERS
WITHOUT CLAIM TO ANY PARTICULAR FONT, STYLE,
SIZE, OR COLOR.

FOR MEDICAL CAPNOGRAPHY INSTRUMENTS,
NAMELY, MAINSTREAM OXYGEN AND CARBON
DIOXIDE SENSORS (U.S. CLS. 26, 39 AND 44).

MICHAEL KAZAZIAN, EXAMINING ATTORNEY

SN 78-697,511. RIC INVESTMENTS, LLC, WILMINGTON,
DE. FILED 8-22-2005.

21ST CENTURY CO2 TECHNOLOGY

THE MARK CONSISTS OF STANDARD CHARACTERS
WITHOUT CLAIM TO ANY PARTICULAR FONT, STYLE,
SIZE, OR COLOR.

NO CLAIM IS MADE TO THE EXCLUSIVE RIGHT TO
USE "CO2 TECHNOLOGY", APART FROM THE MARK AS
SHOWN.

FOR MEDICAL INSTRUMENTS, NAMELY ELECTRO-
NIC SENSORS AND MONITORS FOR USE IN MEASUR-
ING AND MONITORING END TIDAL CARBON
DIOXIDE IN PATIENTS (U.S. CLS. 26, 39 AND 44).

DAVID MURRAY, EXAMINING ATTORNEY

CLASS 10—(Continued).

SN 78-703,128. BRASSELER USA, INC., SAVANNAH, GA. FILED 8-30-2005.

ET

THE MARK CONSISTS OF STANDARD CHARACTERS WITHOUT CLAIM TO ANY PARTICULAR FONT, STYLE, SIZE, OR COLOR.
FOR DENTAL INSTRUMENTS, NAMELY, DIAMOND AND CARBIDE BURS (U.S. CLS. 26, 39 AND 44).
FIRST USE 12-31-1981; IN COMMERCE 12-31-1981.
INGRID C. EULIN, EXAMINING ATTORNEY

SN 78-705,087. CARD GUARD AG, NEUHAUSEN AM RHEINFALL, SWITZERLAND, FILED 9-1-2005.

HEALTHPOD

THE MARK CONSISTS OF STANDARD CHARACTERS WITHOUT CLAIM TO ANY PARTICULAR FONT, STYLE, SIZE, OR COLOR.
FOR PHONE-ENABLED PERSONAL HEALTH MONITORING DEVICE CONSISTING OF SENSORS FOR MEASURING ECG WAVEFORM, HEART RATE, BODY FAT, BLOOD GLUCOSE, AND BODY TEMPERATURE (U.S. CLS. 26, 39 AND 44).
SARA THOMAS, EXAMINING ATTORNEY

SN 78-707,060. LAWSON, ROBERT A, BELLEVUE, WA. FILED 9-6-2005.

NeuroSync

THE MARK CONSISTS OF STANDARD CHARACTERS WITHOUT CLAIM TO ANY PARTICULAR FONT, STYLE, SIZE, OR COLOR.
FOR MEDICAL INSTRUMENT TO INDUCE RELAXATION VIA ELECTROENCEPHALOGRAPHIC BIOFEEDBACK (U.S. CLS. 26, 39 AND 44).
KATHERINE E. HALMEN, EXAMINING ATTORNEY

CLASS 10—(Continued).

SN 78-707,070. BIVAB LLC, MARBLEHEAD, MA. FILED 9-6-2005.

ALINE

THE MARK CONSISTS OF STANDARD CHARACTERS WITHOUT CLAIM TO ANY PARTICULAR FONT, STYLE, SIZE, OR COLOR.
FOR ORTHOTIC INSERTS FOR ADULT FOOTWEAR (U.S. CLS. 26, 39 AND 44).
RONALD MCMORROW, EXAMINING ATTORNEY

SN 78-713,684. OSSTEM CO., LTD., SEOUL, REPUBLIC OF KOREA, FILED 9-15-2005.



osstem

FOR ARTIFICIAL TEETH; DENTURES; DENTAL IMPLANTS; SURGICAL IMPLANTS COMPRISING ARTIFICIAL MATERIAL; PROSTHETIC INSTRUMENTS FOR DENTAL PURPOSES; DENTAL EXCAVATORS; FILLING INSTRUMENTS FOR DENTAL PURPOSES; DECAYED TOOTH DETECTORS; DENTAL MIRRORS; DENTAL CHAIRS; BROACHES FOR DENTAL PURPOSES; DENTAL DRILLS; SURGICAL INSTRUMENTS FOR DENTAL PURPOSES; TREATMENT BEDS FOR DENTAL PURPOSES; CLEANING DEVICES FOR STERILIZATION AND DISINFECTION OF DENTAL APPARATUS; DENTAL INSTRUMENTS, NAMELY, SCALERS FOR DENTAL CLEANING; ORTHODONTIC MACHINES AND INSTRUMENTS FOR DENTAL PURPOSES; ORTHODONTIC APPLIANCES; PROBES FOR GINGIVAL POCKETS; X-RAYS APPLIANCES FOR DENTAL USE; X-RAY APPARATUS FOR DENTAL USE (U.S. CLS. 26, 39 AND 44).
DAVID TAYLOR, EXAMINING ATTORNEY

CLASS 10—(Continued).

SN 78-718,728. ENDOLOGIX, INC., IRVINE, CA. FILED 9-22-2005.

POWERLINK XL

THE MARK CONSISTS OF STANDARD CHARACTERS WITHOUT CLAIM TO ANY PARTICULAR FONT, STYLE, SIZE, OR COLOR.

OWNER OF U.S. REG. NO. 2,456,038.

NO CLAIM IS MADE TO THE EXCLUSIVE RIGHT TO USE "XL", APART FROM THE MARK AS SHOWN.

FOR MEDICALLY IMPLANTED STENT-GRAFTS AND STENT-GRAFT CATHETER DELIVERY APPARATUS FOR THE TREATMENT OF VASCULAR DISEASES (U.S. CLS. 26, 39 AND 44).

MARLENE BELL, EXAMINING ATTORNEY

CLASS 10—(Continued).

SN 78-744,735. GYRUS GROUP PLC, WOKINGHAM, BERKS, UNITED KINGDOM, FILED 11-1-2005.



OWNER OF UNITED KINGDOM REG. NO. 2376178, DATED 4-8-2005, EXPIRES 10-20-2014.

OWNER OF U.S. REG. NO. 2,954,429.

THE COLOR(S) ORANGE AND WHITE IS/ARE CLAIMED AS A FEATURE OF THE MARK.

THE MARK CONSISTS OF STYLIZED LETTERS OF PK APPEARING IN THE COLOR ORANGE AND HAVING A BORDER/OUTLINING IN THE COLOR WHITE.

FOR ELECTROSURGICAL APPARATUS, NAMELY, ELECTROSURGICAL GENERATORS AND HAND-HELD ELECTROSURGICAL INSTRUMENTS, NAMELY, FORCEPS, SCISSORS, SCALPELS, PADDLES, SNARES, LOOPS AND OTHER UROLOGY ELECTRODES, NEEDLE ELECTRODES AND ELECTROSURGICAL BLADES FOR DEBRIDER INSTRUMENTS, USED THEREIN FOR CUTTING AND/OR COAGULATING TISSUES (U.S. CLS. 26, 39 AND 44).

DOMINIC FATHY, EXAMINING ATTORNEY

SN 78-742,676. BELT, SHEILA, ROCKFORD, IL. FILED 10-28-2005.

Cov-r-Shield

THE MARK CONSISTS OF STANDARD CHARACTERS WITHOUT CLAIM TO ANY PARTICULAR FONT, STYLE, SIZE, OR COLOR.

FOR MEDICAL PRODUCTS, NAMELY OSTOMY POUCH COVERS AND OSTOMY BAG COVERS (U.S. CLS. 26, 39 AND 44).

FIRST USE 7-10-2005; IN COMMERCE 8-14-2005.

DOMINIC FATHY, EXAMINING ATTORNEY

SN 78-745,544. CAPITOL VIAL, INC., AUBURN, AL. FILED 11-2-2005.

VERSA VIAL

THE MARK CONSISTS OF STANDARD CHARACTERS WITHOUT CLAIM TO ANY PARTICULAR FONT, STYLE, SIZE, OR COLOR.

FOR CONTAINERS FOR THE COLLECTION AND STORAGE OF EXPRESSED HUMAN BREAST MILK (U.S. CLS. 26, 39 AND 44).

FIRST USE 8-9-2004; IN COMMERCE 8-9-2004.

JAY BESCH, EXAMINING ATTORNEY

CLASS 10—(Continued).

SN 78-782,603. PRONUCLEOTEIN BIOTECHNOLOGIES, LLC, SAN ANTONIO, TX. FILED 12-29-2005.

OLIGOTEINS

THE MARK CONSISTS OF STANDARD CHARACTERS WITHOUT CLAIM TO ANY PARTICULAR FONT, STYLE, SIZE, OR COLOR.

FOR MEDICAL AND DIAGNOSTIC DEVICES, NAMELY, DEVICES FOR DETECTION OF PATHOGENS (U.S. CLS. 26, 39 AND 44).

MEGAN WHITNEY, EXAMINING ATTORNEY

SN 78-818,865. NATURAL PRODUCTS INTERNATIONAL LLC, MIAMI, FL. FILED 2-20-2006.



NO CLAIM IS MADE TO THE EXCLUSIVE RIGHT TO USE "SAUNA", APART FROM THE MARK AS SHOWN.

THE COLOR(S) WHITE AND BLUE IS/ARE CLAIMED AS A FEATURE OF THE MARK.

THE MARK CONSISTS OF WHITE TEXT AND BLUE BACKGROUND, THE WORDING SAUNA SLIM APPEAR IN WHITE ON A BLUE BACKGROUND.

FOR ELECTRICAL WEIGHT LOSS BODY BELT (U.S. CLS. 26, 39 AND 44).

FIRST USE 2-1-2006; IN COMMERCE 2-1-2006.

KAREN K. BUSH, EXAMINING ATTORNEY

SN 78-826,340. HOWMEDICA OSTEONICS CORP., MAHWAH, NJ. FILED 3-1-2006.

ACCOLADE HFX

THE MARK CONSISTS OF STANDARD CHARACTERS WITHOUT CLAIM TO ANY PARTICULAR FONT, STYLE, SIZE, OR COLOR.

OWNER OF U.S. REG. NO. 2,553,552.

NO CLAIM IS MADE TO THE EXCLUSIVE RIGHT TO USE "HFX", APART FROM THE MARK AS SHOWN.

FOR ORTHOPEDIC HIP IMPLANTS AND COMPONENTS AND SURGICAL INSTRUMENTATION THEREFOR, NAMELY, REAMERS, RASPS, STEM INSERTERS AND EXTRACTORS, NECK RESECTION GUIDES, TRIALS AND STERILIZATION TRAYS (U.S. CLS. 26, 39 AND 44).

FIRST USE 9-26-2005; IN COMMERCE 10-13-2005.

SONYA STEPHENS, EXAMINING ATTORNEY

CLASS 10—(Continued).

SN 78-841,565. HOSPIRA, INC., LAKE FOREST, IL. FILED 3-20-2006.

IPUSH

THE MARK CONSISTS OF STANDARD CHARACTERS WITHOUT CLAIM TO ANY PARTICULAR FONT, STYLE, SIZE, OR COLOR.

FOR DRUG DELIVERY SYSTEMS, NAMELY A SYRINGE SYSTEM FOR DELIVERING INTRAVENOUS PHARMACEUTICALS (U.S. CLS. 26, 39 AND 44).

CARRIE ACHEN, EXAMINING ATTORNEY

SN 78-843,437. IMPLANT INNOVATIONS, INC., PALM BEACH GARDENS, FL. FILED 3-22-2006.

QuickBridge

THE MARK CONSISTS OF STANDARD CHARACTERS WITHOUT CLAIM TO ANY PARTICULAR FONT, STYLE, SIZE, OR COLOR.

FOR DENTAL ABUTMENTS AND PARTS AND FITTINGS THEREFOR (U.S. CLS. 26, 39 AND 44).

PAMELA HIRSCHMAN, EXAMINING ATTORNEY

SN 78-848,752. C. R. BARD, INC., MURRAY HILL, NJ. FILED 3-29-2006.

PERMASORB

THE MARK CONSISTS OF STANDARD CHARACTERS WITHOUT CLAIM TO ANY PARTICULAR FONT, STYLE, SIZE, OR COLOR.

FOR MEDICAL DEVICES AND APPARATUS, NAMELY, SURGICAL MESH (U.S. CLS. 26, 39 AND 44).

CATHERINE FAINT, EXAMINING ATTORNEY

CLASS 10—(Continued).

SN 78-857,042. MONTEREY MEDICAL, INC., SANTA CRUZ, CA. FILED 4-7-2006.

EasyFlow

THE MARK CONSISTS OF STANDARD CHARACTERS WITHOUT CLAIM TO ANY PARTICULAR FONT, STYLE, SIZE, OR COLOR.

FOR INJECTION DEVICE FOR PHARMACEUTICALS (U.S. CLS. 26, 39 AND 44).
REBECCA POVARCHUK, EXAMINING ATTORNEY

CLASS 10—(Continued).

SN 78-861,034. SEQUAL TECHNOLOGIES INC., SAN DIEGO, CA. FILED 4-13-2006.

AXIOM

THE MARK CONSISTS OF STANDARD CHARACTERS WITHOUT CLAIM TO ANY PARTICULAR FONT, STYLE, SIZE, OR COLOR.

FOR OXYGEN CONCENTRATORS FOR MEDICAL APPLICATIONS (U.S. CLS. 26, 39 AND 44).
DAVID MILLER, EXAMINING ATTORNEY

SN 78-858,783. LIFE SPINE, LLC, HOFFMAN ESTATES, IL. FILED 4-11-2006.

GHOST

THE MARK CONSISTS OF STANDARD CHARACTERS WITHOUT CLAIM TO ANY PARTICULAR FONT, STYLE, SIZE, OR COLOR.

FOR IMPLANTS CONSISTING OF ARTIFICIAL MATERIALS, NAMELY, ORTHOPEDIC DEVICES FOR THE SPINE, SPINAL BODY REPLACEMENT DEVICES, INTRAVERTEBRAL BODY REPLACEMENT DEVICES, SPINAL INTERBODY DEVICES (U.S. CLS. 26, 39 AND 44).

FIRST USE 9-21-2005; IN COMMERCE 9-21-2005.
GINA FINK, EXAMINING ATTORNEY

SN 78-861,175. BIOTEX, INC., HOUSTON, TX. FILED 4-13-2006.

THE MARK CONSISTS OF THE WORD "PHOTEX" WITH CAPITALIZED "P" AND "T" AND WITH A TAPERED ARC EXTENDING FROM THE "X".

FOR LASERS FOR MEDICAL USE; LASERS FOR SURGICAL AND MEDICAL USE (U.S. CLS. 26, 39 AND 44).

FIRST USE 1-6-2006; IN COMMERCE 3-21-2006.
ANGELA M. MICHELI, EXAMINING ATTORNEY

SN 78-859,967. EARPOWER, LLC, HOUSTON, TX. FILED 4-12-2006.

DeMumbler

THE MARK CONSISTS OF STANDARD CHARACTERS WITHOUT CLAIM TO ANY PARTICULAR FONT, STYLE, SIZE, OR COLOR.

FOR HEARING AIDS (U.S. CLS. 26, 39 AND 44).
MELISSA VALLILLO, EXAMINING ATTORNEY

SN 78-861,376. ZILA PHARMACEUTICALS, INC., PHOENIX, AZ. FILED 4-13-2006.

ORAVUE

THE MARK CONSISTS OF STANDARD CHARACTERS WITHOUT CLAIM TO ANY PARTICULAR FONT, STYLE, SIZE, OR COLOR.

FOR MEDICAL DEVICES, NAMELY, GOGGLES FOR USE IN DIAGNOSIS OF ORAL CONDITIONS (U.S. CLS. 26, 39 AND 44).

STEVEN R. FINE, EXAMINING ATTORNEY

CLASS 10—(Continued).

SN 78-861,569. SCHERING-PLOUGH HEALTHCARE PRODUCTS, INC., MEMPHIS, TN. FILED 4-14-2006.

CLASS 10—(Continued).

SN 78-863,715. MICRO-INVASIVE TECHNOLOGY, INC., POMFRET CENTER, CT. FILED 4-18-2006.

MEMORY FIT

TheraScope

THE MARK CONSISTS OF STANDARD CHARACTERS WITHOUT CLAIM TO ANY PARTICULAR FONT, STYLE, SIZE, OR COLOR.
OWNER OF U.S. REG. NO. 3,042,679.
FOR ELECTRIC AND BATTERY POWERED BODY MASSAGERS (U.S. CLS. 26, 39 AND 44).
BERYL GARDNER, EXAMINING ATTORNEY

THE MARK CONSISTS OF STANDARD CHARACTERS WITHOUT CLAIM TO ANY PARTICULAR FONT, STYLE, SIZE, OR COLOR.
FOR ENDOSCOPES (U.S. CLS. 26, 39 AND 44).
KIMBERLY FRYE, EXAMINING ATTORNEY

SN 78-861,630. MEDTRONIC XOMED, INC., JACKSONVILLE, FL. FILED 4-14-2006.

SN 78-863,955. CYPRESS MEDICAL PRODUCTS, L.P., MCHENRY, IL. FILED 4-18-2006.

WECK-CEL

CYNERGY

THE MARK CONSISTS OF STANDARD CHARACTERS WITHOUT CLAIM TO ANY PARTICULAR FONT, STYLE, SIZE, OR COLOR.
FOR SURGICAL SPONGES (U.S. CLS. 26, 39 AND 44).
FIRST USE 9-30-1966; IN COMMERCE 9-30-1966.
JENNIFER VASQUEZ, EXAMINING ATTORNEY

THE MARK CONSISTS OF STANDARD CHARACTERS WITHOUT CLAIM TO ANY PARTICULAR FONT, STYLE, SIZE, OR COLOR.
FOR LATEX GLOVES FOR MEDICAL USE (U.S. CLS. 26, 39 AND 44).
SHAUNIA WALLACE, EXAMINING ATTORNEY

SN 78-862,346. VITALWEAR, INC., SOUTH SAN FRANCISCO, CA. FILED 4-16-2006.

SN 78-864,023. INNOVATION ALLEY DESIGN, LLC, LYNDHURST, OH. FILED 4-18-2006.

RECOVERYWRAP

MAX FLOW

THE MARK CONSISTS OF STANDARD CHARACTERS WITHOUT CLAIM TO ANY PARTICULAR FONT, STYLE, SIZE, OR COLOR.
FOR MEDICAL INSTRUMENTS FOR INTERSTITIAL THERMOTHERAPY OF BIOLOGICAL TISSUE (U.S. CLS. 26, 39 AND 44).
FIRST USE 6-1-2006; IN COMMERCE 7-1-2006.
ANNE MADDEN, EXAMINING ATTORNEY

THE MARK CONSISTS OF STANDARD CHARACTERS WITHOUT CLAIM TO ANY PARTICULAR FONT, STYLE, SIZE, OR COLOR.
FOR NASAL DILATORS (U.S. CLS. 26, 39 AND 44).
PAUL E. FAHRENKOPF, EXAMINING ATTORNEY

CLASS 10—(Continued).

SN 78-864,125. BONRO MEDICAL, INC., EVANS, GA. FILED 4-18-2006.

Return intimacy to your
relationship

THE MARK CONSISTS OF STANDARD CHARACTERS WITHOUT CLAIM TO ANY PARTICULAR FONT, STYLE, SIZE, OR COLOR.
FOR ADULT SEXUAL AIDS, NAMELY, VACUUM ERECTION DEVICE FOR MALE SEXUAL DYSFUNCTION (U.S. CLS. 26, 39 AND 44).
FIRST USE 5-1-2003; IN COMMERCE 5-1-2003.
ALAIN LAPTER, EXAMINING ATTORNEY

CLASS 10—(Continued).

SN 78-864,670. ALLERGAN, INC., IRVINE, CA. FILED 4-19-2006.

MICROCELL

THE MARK CONSISTS OF STANDARD CHARACTERS WITHOUT CLAIM TO ANY PARTICULAR FONT, STYLE, SIZE, OR COLOR.
FOR MEDICAL SURGICAL PRODUCT, NAMELY, A MAMMARY PROSTHESIS (U.S. CLS. 26, 39 AND 44).
CATHERINE FAINT, EXAMINING ATTORNEY

SN 78-864,465. OLYMPUS CORPORATION, TOKYO, JAPAN, FILED 4-19-2006.

OSFERION

THE MARK CONSISTS OF STANDARD CHARACTERS WITHOUT CLAIM TO ANY PARTICULAR FONT, STYLE, SIZE, OR COLOR.
FOR BONE FILLING MATERIALS, NAMELY, SYNTHETIC CERAMIC BONE REPLACEMENT, BONE GRAFTING AND BONE SUBSTITUTE MATERIALS (U.S. CLS. 26, 39 AND 44).
ANGELA M. MICHELI, EXAMINING ATTORNEY

SN 78-864,769. TARGETED THERAPY TECHNOLOGIES, LLC, IRVINE, CA. FILED 4-19-2006.

SCLEL

THE MARK CONSISTS OF STANDARD CHARACTERS WITHOUT CLAIM TO ANY PARTICULAR FONT, STYLE, SIZE, OR COLOR.
FOR DRUG DELIVERY SYSTEMS (U.S. CLS. 26, 39 AND 44).
JOHN SCHUYLER YARD, EXAMINING ATTORNEY

SN 78-864,467. OLYMPUS CORPORATION, TOKYO, JAPAN, FILED 4-19-2006.

OSferion

FOR BONE FILLING MATERIALS, NAMELY, SYNTHETIC CERAMIC BONE REPLACEMENT, BONE GRAFTING AND BONE SUBSTITUTE MATERIALS (U.S. CLS. 26, 39 AND 44).
ANGELA M. MICHELI, EXAMINING ATTORNEY

SN 78-865,085. ALCON, INC., CH-6331 HUNENBERG, SWITZERLAND, FILED 4-19-2006.

FREEDOM. SEE IT IN YOUR
EYES

THE MARK CONSISTS OF STANDARD CHARACTERS WITHOUT CLAIM TO ANY PARTICULAR FONT, STYLE, SIZE, OR COLOR.
FOR INTRAOCULAR LENSES (U.S. CLS. 26, 39 AND 44).
STANLEY I. OSBORNE, EXAMINING ATTORNEY

CLASS 10—(Continued).

SN 78-865,091. ALCON, INC., CH-6331 HUNENBERG, SWITZERLAND, FILED 4-19-2006.

FREEDOM. SEE IT IN THEIR EYES

THE MARK CONSISTS OF STANDARD CHARACTERS WITHOUT CLAIM TO ANY PARTICULAR FONT, STYLE, SIZE, OR COLOR.
FOR INTRAOCULAR LENSES (U.S. CLS. 26, 39 AND 44).
STANLEY I. OSBORNE, EXAMINING ATTORNEY

SN 78-865,816. ADVANCED RESPIRATORY, INC., ST. PAUL, MN. FILED 4-20-2006.

THE VEST

THE MARK CONSISTS OF STANDARD CHARACTERS WITHOUT CLAIM TO ANY PARTICULAR FONT, STYLE, SIZE, OR COLOR.
OWNER OF U.S. REG. NOS. 2,751,952 AND 2,751,953. SEC. 2(F).
FOR MEDICAL APPARATUS, NAMELY A DEVICE THAT PROVIDES HIGH-FREQUENCY, CHEST WALL OSCILLATION FOR AIRWAY CLEARANCE THERAPY (U.S. CLS. 26, 39 AND 44).
FIRST USE 1-17-2001; IN COMMERCE 1-17-2001.
ANDREW RHIM, EXAMINING ATTORNEY

SN 78-873,704. ALLERGAN, INC., IRVINE, CA. FILED 5-1-2006.

SILESSENSE

THE MARK CONSISTS OF STANDARD CHARACTERS WITHOUT CLAIM TO ANY PARTICULAR FONT, STYLE, SIZE, OR COLOR.
FOR SILICONE SURGICAL BREAST PROSTHESIS (U.S. CLS. 26, 39 AND 44).
CATHERINE FAINT, EXAMINING ATTORNEY

CLASS 10—(Continued).

SN 78-873,710. ALLERGAN, INC., IRVINE, CA. FILED 5-1-2006.

TRILUCENT

THE MARK CONSISTS OF STANDARD CHARACTERS WITHOUT CLAIM TO ANY PARTICULAR FONT, STYLE, SIZE, OR COLOR.
FOR BREAST IMPLANTS (U.S. CLS. 26, 39 AND 44).
CATHERINE FAINT, EXAMINING ATTORNEY

SN 78-874,531. ACCURATE SURGICAL & SCIENTIFIC INSTRUMENTS CORPORATION, WESTBURY, NY. FILED 5-2-2006.

LALONDE

THE MARK CONSISTS OF STANDARD CHARACTERS WITHOUT CLAIM TO ANY PARTICULAR FONT, STYLE, SIZE, OR COLOR.
OWNER OF U.S. REG. NO. 2,448,516. SEC. 2(F).
FOR SURGICAL INSTRUMENTS, NAMELY CLAMPS, FORCEPS, APPROXIMATORS AND BREAST SIZERS (U.S. CLS. 26, 39 AND 44).
FIRST USE 12-31-1987; IN COMMERCE 12-31-1987.
FRED CARL, EXAMINING ATTORNEY

SN 78-876,594. IMPLANT INNOVATIONS, INC., PALM BEACH GARDENS, FL. FILED 5-4-2006.

NANOTITE

THE MARK CONSISTS OF STANDARD CHARACTERS WITHOUT CLAIM TO ANY PARTICULAR FONT, STYLE, SIZE, OR COLOR.
FOR DENTAL IMPLANTS, DENTAL IMPLANT ABUTMENTS AND PARTS AND FITTINGS THEREFOR (U.S. CLS. 26, 39 AND 44).
PAMELA HIRSCHMAN, EXAMINING ATTORNEY

CLASS 10—(Continued).

SN 78-882,022. VISIONQUEST INDUSTRIES, INC., IRVINE, CA. FILED 5-12-2006.

CATALYST

THE MARK CONSISTS OF STANDARD CHARACTERS WITHOUT CLAIM TO ANY PARTICULAR FONT, STYLE, SIZE, OR COLOR.

FOR KNEE BRACES FOR MEDICAL USE (U.S. CLS. 26, 39 AND 44).

MICHAEL SOUDERS, EXAMINING ATTORNEY

CLASS 10—(Continued).

SN 78-883,632. PHARMA-PEN, INC., ATHENS, TX. FILED 5-15-2006.



THE MARK CONSISTS OF THE WORDS PHARMA PEN WITH A SMALL CIRCLE SEPARATING THE WORDS AND A CURVED LINE GOING ABOVE THE WORD PHARMA AND COMING DOWN BETWEEN THE WORDS AND CURVING UNDER THE WORD PEN.

FOR MEDICAL SYRINGES (U.S. CLS. 26, 39 AND 44).

FIRST USE 7-25-2005; IN COMMERCE 7-25-2005.

PAULA MAYS, EXAMINING ATTORNEY

SN 78-882,024. VISIONQUEST INDUSTRIES, INC., IRVINE, CA. FILED 5-12-2006.

CATALYST-X

THE MARK CONSISTS OF STANDARD CHARACTERS WITHOUT CLAIM TO ANY PARTICULAR FONT, STYLE, SIZE, OR COLOR.

FOR KNEE BRACES FOR MEDICAL USE (U.S. CLS. 26, 39 AND 44).

MICHAEL SOUDERS, EXAMINING ATTORNEY

SN 78-887,608. ALLERGAN, INC., IRVINE, CA. FILED 5-19-2006.

VASOSTAT

THE MARK CONSISTS OF STANDARD CHARACTERS WITHOUT CLAIM TO ANY PARTICULAR FONT, STYLE, SIZE, OR COLOR.

FOR INJECTABLE COMPOSITION FOR OCCLUDING BLOOD VESSELS FOR USE IN SURGICAL PROCEDURES (U.S. CLS. 26, 39 AND 44).

CATHERINE FAINT, EXAMINING ATTORNEY

SN 78-882,027. VISIONQUEST INDUSTRIES, INC., IRVINE, CA. FILED 5-12-2006.

CATALYST CONTACT

THE MARK CONSISTS OF STANDARD CHARACTERS WITHOUT CLAIM TO ANY PARTICULAR FONT, STYLE, SIZE, OR COLOR.

FOR KNEE BRACES FOR MEDICAL USE (U.S. CLS. 26, 39 AND 44).

MICHAEL SOUDERS, EXAMINING ATTORNEY

SN 78-898,013. MEDLINE INDUSTRIES, INC., MUNDELEIN, IL. FILED 6-1-2006.

COMFORT LOOP

THE MARK CONSISTS OF STANDARD CHARACTERS WITHOUT CLAIM TO ANY PARTICULAR FONT, STYLE, SIZE, OR COLOR.

FOR FORCEPS FOR MEDICAL USE (U.S. CLS. 26, 39 AND 44).

JUSTINE D. PARKER, EXAMINING ATTORNEY

CLASS 10—(Continued).

SN 78-899,291. CONOR MEDSYSTEMS, INC., MENLO PARK, CA. FILED 6-2-2006.

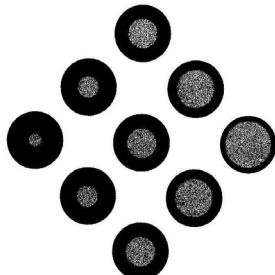

THE MARK CONSISTS OF NINE CIRCLES, EACH WITH A DARKER SHADED OUTER CIRCUMFERENCE AND A LIGHTER SHADED INNER AREA, ARRANGED IN A DIAMOND PATTERN.

FOR CATHETERS; MEDICAL APPARATUS FOR INTRODUCING PHARMACEUTICAL PREPARATIONS INTO THE HUMAN BODY; MEDICAL STENTS; STENTS (U.S. CLS. 26, 39 AND 44).

FIRST USE 5-18-2005; IN COMMERCE 6-1-2005.
LINDA ESTRADA, EXAMINING ATTORNEY

SN 78-902,526. SUNRISE MEDICAL HHG INC., LONGMONT, CO. FILED 6-7-2006.

DEVILBISS TRAVELER

THE MARK CONSISTS OF STANDARD CHARACTERS WITHOUT CLAIM TO ANY PARTICULAR FONT, STYLE, SIZE, OR COLOR.

OWNER OF U.S. REG. NOS. 164,521 AND 1,745,662.
FOR PORTABLE NEBULIZER AND COMPRESSOR FOR RESPIRATION THERAPY (U.S. CLS. 26, 39 AND 44).

FIRST USE 4-14-2006; IN COMMERCE 4-14-2006.
MARLENE BELL, EXAMINING ATTORNEY

SN 78-905,697. STRYKER CORPORATION, KALAMAZOO, MI. FILED 6-12-2006.

AEROTURN

THE MARK CONSISTS OF STANDARD CHARACTERS WITHOUT CLAIM TO ANY PARTICULAR FONT, STYLE, SIZE, OR COLOR.

FOR SPECIALTY INFLATABLE MATTRESSES FOR THERAPEUTIC AND MEDICAL USE. FOR USE BY MEDICAL AND HEALTH INSTITUTIONS AND ELDERLY CARE FACILITIES (U.S. CLS. 26, 39 AND 44).

YONG KIM, EXAMINING ATTORNEY

CLASS 10—(Continued).

SN 78-923,489. D. GOODMAN, INC., MIAMI, FL. FILED 7-6-2006.

MIACO

THE MARK CONSISTS OF STANDARD CHARACTERS WITHOUT CLAIM TO ANY PARTICULAR FONT, STYLE, SIZE, OR COLOR.

FOR MESSAGE APPARATUS; MESSAGE TABLES (U.S. CLS. 26, 39 AND 44).

FIRST USE 5-1-2005; IN COMMERCE 5-1-2005.
DAVID YONTEF, EXAMINING ATTORNEY

SN 78-923,700. THE SPECTRANETICS CORPORATION, COLORADO SPRINGS, CO. FILED 7-6-2006.

TURBO-ELITE

THE MARK CONSISTS OF STANDARD CHARACTERS WITHOUT CLAIM TO ANY PARTICULAR FONT, STYLE, SIZE, OR COLOR.

FOR CATHETERS AND SHEATHS FOR CATHETERS (U.S. CLS. 26, 39 AND 44).

JASON LOTT, EXAMINING ATTORNEY

SN 79-014,661. CORDATEC NAAMLOZE VENNOOTSCHAP, BELGIUM. FILED 8-1-2005.

A-View

THE MARK CONSISTS OF STANDARD CHARACTERS WITHOUT CLAIM TO ANY PARTICULAR FONT, STYLE, SIZE, OR COLOR.

PRIORITY DATE OF 3-16-2005 IS CLAIMED.
OWNER OF INTERNATIONAL REGISTRATION 0860488 DATED 8-1-2005, EXPIRES 8-1-2015.

FOR CATHETERS (U.S. CLS. 26, 39 AND 44).
DOMINIC J. FERRAIUOLO, EXAMINING ATTORNEY

CLASS 10—(Continued).

SN 79-018,612. NATIONAL DIAGNOSTIC PRODUCTS, AUSTRALIA, FILED 11-2-2005.

BETACHEK

THE MARK CONSISTS OF STANDARD CHARACTERS WITHOUT CLAIM TO ANY PARTICULAR FONT, STYLE, SIZE, OR COLOR.

OWNER OF INTERNATIONAL REGISTRATION 0870757 DATED 11-2-2005, EXPIRES 11-2-2015.

FOR MEDICAL TEST KITS FOR DIABETES MONITORING FOR HOME USE; LANCETS FOR MEDICAL USE; MONITORING APPARATUS FOR MEDICAL USE, NAMELY BLOOD GLUCOSE MEASURING DEVICES IN THE NATURE OF METERS FOR DIABETICS (U.S. CLS. 26, 39 AND 44).

RAMONA ORTIGA, EXAMINING ATTORNEY

CLASS 11—ENVIRONMENTAL CONTROL APPARATUS

SN 76-389,913. NORITZ CORPORATION, KOBE 650-0033, JAPAN, FILED 3-29-2002.

NORITZ

THE MARK CONSISTS OF STANDARD CHARACTERS WITHOUT CLAIM TO ANY PARTICULAR FONT, STYLE, SIZE, OR COLOR.

OWNER OF JAPAN REG. NO. 2282536, DATED 11-30-1990, EXPIRES 11-30-2010.

OWNER OF JAPAN REG. NO. 2167916, DATED 9-29-1989, EXPIRES 9-29-2009.

OWNER OF JAPAN REG. NO. 1929132, DATED 1-28-1987, RENEWED AS REG. NO. 1929132, DATED 1-28-2007, EXPIRES 1-28-2017.

OWNER OF JAPAN REG. NO. 2636657, DATED 3-31-1994, EXPIRES 3-31-2014.

OWNER OF JAPAN REG. NO. 2636657, DATED 3-31-1994, EXPIRES 3-31-2014.

FOR GAS HEATERS FOR WATER; OIL HEATERS FOR WATER FOR DOMESTIC USE; OIL HEATERS FOR WATER FOR INDUSTRIAL USE; SAUNAS FOR INDUSTRIAL USE; FURNACE BOILERS; HEATING APPARATUS, NAMELY, GAS RANGES, COOKING OVENS FOR KITCHEN USE, PORTABLE WOOD BURNING STOVES MADE OF CLAY, OIL STOVES, AND BARBECUE GRILLS; SINKS; ELECTRIC DISH DRYERS FOR INDUSTRIAL USE; RICE COOKERS FOR INDUSTRIAL USE; ELECTRIC ROASTERS FOR COMMERCIAL USE; GAS RANGES FOR INDUSTRIAL AND COMMERCIAL USE; ELECTRIC RANGES FOR INDUSTRIAL AND COMMERCIAL USE; DRYING APPARATUS, NAMELY, HAIR DRYERS, ELECTRIC DISH DRYERS, CLOTHES DRYERS, ELECTRIC INDUSTRIAL ROOM DRYERS FOR HEATING, AND HOT WATER INDUSTRIAL ROOM DRYERS FOR HEATING; DISTILLATE APPARATUS, NAMELY, DISTILLING UNITS, DISTILLING TUBES, DISTILLING TANKS, DISTILLING FLASKS, DISTILLING CONDENSERS, DISTILLATION ANALYZERS, AND DISTILLING COLUMNS; HEAT EXCHANGERS; HEATING AND AIR CONDITIONING EQUIPMENT, NAMELY, WARM HEATERS, AIR HEATING FURNACES, HOT WATER HEATERS, STEAM HEATERS, SINGLE INDUCTION AIR CONDITIONERS, CENTRAL AIR CONDITIONERS, WINDOW AIR CONDITIONERS, RADIATORS, FLOOR WARMERS, ELECTRIC ROAD SURFACE WARMERS, AND HOT WATER ROAD SURFACE WARMERS; TOILET CUBICAL UNIT COMPRISING A TOILET, WASHBASIN AND LIGHT FIXTURE ENCLOSED IN A SINGLE UNIT; BATH CUBICLE UNIT COMPRISING A SHOWER, BATHTUB, WASHING FLOOR, VANITY, AND LIGHT FIXTURE ENCLOSED IN A SINGLE UNIT; SAUNAS FOR DOMESTIC USE; BATH GOODS, NAMELY, SHOWERS, BATHTUBS, BATHTUBS WITH WASHING FLOOR, HOT TUBS, BATHTUBS WITH VANITY AND WASHING FLOOR, AND BATH BOILERS; WATER PURIFIERS FOR DOMESTIC USE; LEVEL CONTROLLING METAL VALVES IN TANKS, AND LEVEL CONTROLLING PLASTIC VALVES IN TANKS; ELECTRIC GARBAGE INCINERATORS FOR DOMESTIC USE; ELECTRIC GARBAGE INCINERATORS FOR INDUSTRIAL USE; SOLAR HEATERS FOR WATER; ELECTRIC HEATERS FOR WATER FOR DOMESTIC USE; ELECTRIC HEATING APPLIANCES FOR DOMESTIC USE, NAMELY, AIR CONDITIONERS AND RANGE HOODS; ELECTRIC HEATERS FOR WATER FOR INDUSTRIAL USE; TOILET SEATS WITH HYGIENIC CLEANING FUNCTION; AND TOILET BOWLS (U.S. CLS. 13, 21, 23, 31 AND 34).

JOHN SCHUYLER YARD, EXAMINING ATTORNEY

SN 79-019,904. 3MENSIO MEDICAL IMAGING BV, NL-3723 BS BILTHOVEN, NETHERLANDS, FILED 5-4-2005.

3viseon

THE MARK CONSISTS OF STANDARD CHARACTERS WITHOUT CLAIM TO ANY PARTICULAR FONT, STYLE, SIZE, OR COLOR.

PRIORITY DATE OF 11-9-2004 IS CLAIMED. OWNER OF INTERNATIONAL REGISTRATION 0874057 DATED 5-4-2005, EXPIRES 5-4-2015.

FOR MEDICAL EQUIPMENT, NAMELY APPARATUS FOR THE DISPLAY AND MANIPULATION OF MEDICAL IMAGING INFORMATION (U.S. CLS. 26, 39 AND 44).

JOHN LINCOSKI, EXAMINING ATTORNEY

CLASS 11—(Continued).

SN 76-615,019. KIT, CHAN PONG, KUALA LUMPUR, WILAYAH PERSEKUTUAN, MALAYSIA, FILED 10-7-2004.



FOR SEWAGE FILTERS; PLUMBING FITTINGS NAMELY, METERED VALVES; TAP WATER FAUCETS; TAPS COCKS, SPIGOTS FOR PIPES; WATER TAPS FOR PIPES; TOILET BOWLS; TOILET SEATS; TOILET WATER-CLOSETS; URINALS; SANITARY FIXTURES, NAMELY, LEVEL CONTROLLING VALVES IN TANKS; WATER LEVEL CONTROLLING VALVES IN TANKS; WATER CLOSETS; WATER FILTERS; WATER FLUSHER; AND WATER PURIFICATION UNITS (U.S. CLS. 13, 21, 23, 31 AND 34).

MONIQUE MILLER, EXAMINING ATTORNEY

SN 76-644,446. NINETY TEN TECHNOLOGIES, INC., ATKINSON, NH. FILED 8-5-2005.

THE BLUEBERRY

THE MARK CONSISTS OF STANDARD CHARACTERS WITHOUT CLAIM TO ANY PARTICULAR FONT, STYLE, SIZE, OR COLOR.

FOR WATER FILTRATION AND PURIFICATION SYSTEMS, NAMELY WATER FILTERS AND WATER PURIFIERS (U.S. CLS. 13, 21, 23, 31 AND 34).

FIRST USE 10-15-2005; IN COMMERCE 11-4-2005.

DAWN HAN, EXAMINING ATTORNEY

SN 76-646,196. CLIMATE ENERGY LLC, MEDFIELD, MA. FILED 9-6-2005.

Climate Energy 

NO CLAIM IS MADE TO THE EXCLUSIVE RIGHT TO USE "CLIMATE ENERGY", APART FROM THE MARK AS SHOWN.

THE MARK CONSISTS OF TWO CIRCULAR SWISHES.

FOR MICRO HEAT AND POWER SYSTEMS COMPRISED OF MASTER CONTROL MODULES, ENGINE COOLING HEAT EXCHANGER, LIQUID COOLANT, CIRCUIT AUXILIARY BURNER AND HEAT EXCHANGER, AIR BLOW AND CABINET, ENGINE GENERATOR, INVERTER AND VENT SYSTEM FOR THE PURPOSE OF THE COMBINED PRODUCTION OF HEAT AND ELECTRICITY FOR COMMERCIAL AND RESIDENTIAL USE (U.S. CLS. 13, 21, 23, 31 AND 34).

H. M. FISHER, EXAMINING ATTORNEY

CLASS 11—(Continued).

SN 76-647,292. TOPP INTELLECUTAL PROPERTIES, INC., ASTON, PA. FILED 9-22-2005.

SAFE-HEAT

THE MARK CONSISTS OF STANDARD CHARACTERS WITHOUT CLAIM TO ANY PARTICULAR FONT, STYLE, SIZE, OR COLOR.

OWNER OF U.S. REG. NO. 1,739,670.

FOR HEATERS, NAMELY, GAS, ELECTRIC, PROPANE AND FUEL OIL HEATERS FOR RESIDENTIAL, COMMERCIAL, AND INDUSTRIAL USE; PORTABLE SPACE HEATERS USING GAS, ELECTRIC, PROPANE AND FUEL OIL; LIQUID PROPANE SPACE HEATERS; ELECTRIC SPACE HEATERS; OIL SPACE HEATERS; DEHUMIDIFIERS AND PORTABLE DEHUMIDIFIERS (U.S. CLS. 13, 21, 23, 31 AND 34).

FIRST USE 9-30-1991; IN COMMERCE 9-30-1991.

LEIGH CAROLINE CASE, EXAMINING ATTORNEY

SN 76-648,918. CFM PRODUCTS, LLC., CHICAGO, IL. FILED 10-20-2005.

BLUE BLOWER

THE MARK CONSISTS OF STANDARD CHARACTERS WITHOUT CLAIM TO ANY PARTICULAR FONT, STYLE, SIZE, OR COLOR.

OWNER OF U.S. REG. NO. 2,801,877.

FOR ELECTRICAL HEATER ATTACHMENTS FOR USE WITH ELECTRICAL FANS, AND ELECTRICAL HEATER ATTACHMENTS SOLD AS A COMPONENT OF ELECTRICAL FANS (U.S. CLS. 13, 21, 23, 31 AND 34).

RICHARD WHITE, EXAMINING ATTORNEY

SN 76-652,115. CRAWFORD SUPPLY COMPANY, MORTON GROVE, IL. FILED 12-12-2005.



NO CLAIM IS MADE TO THE EXCLUSIVE RIGHT TO USE "AIR", APART FROM THE MARK AS SHOWN.

FOR PRESSURIZED DUCT HEATING AND COOLING SYSTEM, SOLD AS A UNIT, COMPOSED PRIMARILY OF RETURN AIR KIT, AIR HANDLER UNIT, SUPPLY PLENUMS, AIR DISTRIBUTION BOXES AND FLEXIBLE OUTLET PIPE (U.S. CLS. 13, 21, 23, 31 AND 34).

FIRST USE 10-29-2002; IN COMMERCE 10-29-2002.

ANNE FARRELL, EXAMINING ATTORNEY

CLASS 11—(Continued).

SN 76-655,264. PETER HILL, DBA WESTOVER, OMAHA, NE.
FILED 2-16-2006.



FOR FAUCETS, SHOWER PANELS AND SHOWER
SPRAYS; ELECTRIC AND HYDRONIC TOWEL WAR-
MERS (U.S. CLS. 13, 21, 23, 31 AND 34).
FIRST USE 11-0-2005; IN COMMERCE 11-0-2005.
GINA HAYES, EXAMINING ATTORNEY

SN 76-658,469. GEMTRON CORPORATION, SWEETWATER,
TN. FILED 4-14-2006.

ADJUST-A-TRACK

THE MARK CONSISTS OF STANDARD CHARACTERS
WITHOUT CLAIM TO ANY PARTICULAR FONT, STYLE,
SIZE, OR COLOR.
FOR VERTICALLY ADJUSTABLE SHELVES FOR RE-
FRIGERATORS (U.S. CLS. 13, 21, 23, 31 AND 34).
WILLIAM BRECKENFELD, EXAMINING ATTORNEY

SN 76-659,182. SAKAMOTO SEIKI CO., LTD, OSAKA 535-
0022, JAPAN, FILED 4-27-2006.

FRONTIER ONE

THE MARK CONSISTS OF STANDARD CHARACTERS
WITHOUT CLAIM TO ANY PARTICULAR FONT, STYLE,
SIZE, OR COLOR.
FOR WATER PURIFYING APPARATUS AND MA-
CHINES (U.S. CLS. 13, 21, 23, 31 AND 34).
JILL PRATER, EXAMINING ATTORNEY

CLASS 11—(Continued).

SN 78-465,688. SIRIUS LIGHT TECHNOLOGY CO., LTD.,
TAINAN, TAIWAN, FILED 8-11-2004.



FOR LAMPS FOR VEHICLES; FOG LAMPS, HEAD-
LAMPS, TAIL LAMPS, DRIVING LAMPS, STOP LAMPS,
SIGNAL LAMPS, AND DIRECTIONAL LIGHTS FOR
VEHICLES; AUTOMOTIVE HEADLAMPS; HEADLAMPS
FOR AGRICULTURAL VEHICLES; BACKUP LIGHTS
FOR LAND VEHICLES; AND HALOGEN LIGHT BULBS
FOR VEHICLES (U.S. CLS. 13, 21, 23, 31 AND 34).
FIRST USE 5-15-1995; IN COMMERCE 8-24-2000.
ANNE MADDEN, EXAMINING ATTORNEY

SN 78-532,746. R.A.M. LIGHTING LTD., MILTON, ONTAR-
IO, CANADA, FILED 12-15-2004.

R.A.M. LIGHTING

THE MARK CONSISTS OF STANDARD CHARACTERS
WITHOUT CLAIM TO ANY PARTICULAR FONT, STYLE,
SIZE, OR COLOR.
NO CLAIM IS MADE TO THE EXCLUSIVE RIGHT TO
USE "LIGHTING", APART FROM THE MARK AS SHOWN.
FOR ELECTRICAL LIGHTING FIXTURES, NAMELY
CEILING PENDANTS, FLUSH MOUNT CEILING FIX-
TURES AND WALL SCONES; PORTABLE ELECTRIC
LAMPS (U.S. CLS. 13, 21, 23, 31 AND 34).
FIRST USE 12-31-1997; IN COMMERCE 12-31-1983.
MICHELE SWAIN, EXAMINING ATTORNEY

CLASS 11—(Continued).

SN 78-551,294. IDEAL TRADING, LLC, PHOENIX, AZ. FILED 1-20-2005.

MILLENIUM BRASS

THE MARK CONSISTS OF STANDARD CHARACTERS WITHOUT CLAIM TO ANY PARTICULAR FONT, STYLE, SIZE, OR COLOR.

NO CLAIM IS MADE TO THE EXCLUSIVE RIGHT TO USE "BRASS", APART FROM THE MARK AS SHOWN.

FOR PLUMBING FITTINGS, NAMELY, SHOWER CONTROL VALVES AND DIVERTERS; SINKS, FAUCETS, WATER FAUCET SPOUTS; PLUMBING FIXTURES OF BRASS AND STAINLESS STEEL, NAMELY, KITCHEN FAUCETS AND SPRAYERS, LAVATORY FAUCETS, BATHROOM FAUCETS, SHOWER VALVES, FAUCETS, SPRAY HEADS, TUB VALVES, SPOUTS AND DIVERTERS, BAR FAUCETS, KITCHEN SINKS, BATHROOM SINKS, BAR SINKS, AND SHOWER DOORS (U.S. CLS. 13, 21, 23, 31 AND 34).

FIRST USE 1-20-2005; IN COMMERCE 1-20-2005.
KATHERINE CONNOLLY, EXAMINING ATTORNEY

CLASS 11—(Continued).

SN 78-661,433. SAFETY GUARD TECHNOLOGIES, LLC, NAPLES, FL. FILED 6-30-2005.



FOR WATER FLUSHING SYSTEMS COMPRISING PIPES, TUBES, HOSES, FITTINGS, FASTENERS, FLOW CONTROL VALVES INCLUDING TIMER CONTROL VALVES AND TEMPERATURE CONTROL VALVES, AND PROGRAMMABLE VALVE CONTROLLERS FOR USE IN WATER DISTRIBUTION SYSTEMS, EMERGENCY EYE WASH STATIONS, SAFETY SHOWERS, DRINKING FOUNTAINS, HOSPITALS, SCHOOLS, HOUSES, BUILDINGS, OIL REFINERIES, AND CHEMICAL PLANTS, OPTIONALLY PROVIDING WATER FLUSHING, WATER SAMPLING, DECHLORINATION, BACKFLOW PREVENTION, AND TEMPERATURE CONTROL, SUCH AS FREEZE PROTECTION AND SCALD PROTECTION (U.S. CLS. 13, 21, 23, 31 AND 34).

FIRST USE 6-0-2004; IN COMMERCE 6-0-2004.
RICHARD WHITE, EXAMINING ATTORNEY

SN 78-618,289. ASSOCIATION OF INDEPENDENT OIL DISTRIBUTORS, INC., MONTROSE, CO. FILED 4-27-2005.



OWNER OF U.S. REG. NOS. 2,987,136 AND 3,013,379. FOR HEADLAMPS/HEADLIGHTS EXCLUSIVELY FOR USE IN CONJUNCTION WITH THE SERVICING AND ONGOING MAINTENANCE OF AUTOMOBILES (U.S. CLS. 13, 21, 23, 31 AND 34).

FIRST USE 1-15-1995; IN COMMERCE 1-15-1995.
DAVID ELTON, EXAMINING ATTORNEY

SN 78-680,726. BERNARD DALSIN MANUFACTURING COMPANY, FARMINGTON, MN. FILED 7-28-2005.

AIR-A-LATOR

THE MARK CONSISTS OF STANDARD CHARACTERS WITHOUT CLAIM TO ANY PARTICULAR FONT, STYLE, SIZE, OR COLOR.

FOR OUTSIDE AIR INTAKE REGULATOR FOR FIREPLACES (U.S. CLS. 13, 21, 23, 31 AND 34).

FIRST USE 8-8-1972; IN COMMERCE 9-6-1972.
YONG KIM, EXAMINING ATTORNEY

SN 78-620,538. WISENBAKER BUILDER SERVICES, LTD., HOUSTON, TX. FILED 5-1-2005.

MIRADO

THE MARK CONSISTS OF STANDARD CHARACTERS WITHOUT CLAIM TO ANY PARTICULAR FONT, STYLE, SIZE, OR COLOR.

THE ENGLISH TRANSLATION OF THE WORDING "MIRADO" IS "TO LOOK, RESPECTFUL, CONSIDERATE, AND DISCREET".

FOR KITCHEN AND BATH SINKS; FAUCETS; PIPING HOT WATER DISPENSERS AND INSTAHOTS, NAMELY INSTANTANEOUS WATER HEATER THAT SUPPLIES HOT WATER; HOT AND COLD WATER TAPS; HOT AND COLD MIXER WATER FAUCETS; WATER TAPS; PLUMBING ACCESSORIES, NAMELY SINK SPRAYERS, SINK TRAPS, AND STRAINERS (U.S. CLS. 13, 21, 23, 31 AND 34).

FIRST USE 3-0-2005; IN COMMERCE 3-0-2005.
MICHAEL KEATING, EXAMINING ATTORNEY

SN 78-681,120. KOHLER CO., KOHLER, WI. FILED 7-28-2005.

CIMARRON

THE MARK CONSISTS OF STANDARD CHARACTERS WITHOUT CLAIM TO ANY PARTICULAR FONT, STYLE, SIZE, OR COLOR.

FOR TOILETS, LAVATORIES, LAVATORY PEDESTALS AND FLUSH TRIP LEVERS (U.S. CLS. 13, 21, 23, 31 AND 34).

JEFF DEFORD, EXAMINING ATTORNEY

CLASS 11—(Continued).

SN 78-685,436. IMAGINE GOLD, L.L.C., SOUTH HACKENSACK, NJ. FILED 8-4-2005.

BIO XSTREAM

THE MARK CONSISTS OF STANDARD CHARACTERS WITHOUT CLAIM TO ANY PARTICULAR FONT, STYLE, SIZE, OR COLOR.

FOR WATER FILTER CARTRIDGES FOR AQUARIUMS PLACED IN HOMES, OFFICES AND SMALLER COMMERCIAL ESTABLISHMENTS (U.S. CLS. 13, 21, 23, 31 AND 34).

FIRST USE 5-28-2005; IN COMMERCE 5-28-2005.
DAVID COLLIER, EXAMINING ATTORNEY

SN 78-688,218. MASCO CORPORATION OF INDIANA, INDIANAPOLIS, IN. FILED 8-9-2005.

SPREE

THE MARK CONSISTS OF STANDARD CHARACTERS WITHOUT CLAIM TO ANY PARTICULAR FONT, STYLE, SIZE, OR COLOR.

FOR PLUMBING PRODUCTS, NAMELY FAUCETS (U.S. CLS. 13, 21, 23, 31 AND 34).

YONG KIM, EXAMINING ATTORNEY

SN 78-701,568. FERGUSON ENTERPRISES, INC., NEWPORT NEWS, VA. FILED 8-26-2005.



OWNER OF U.S. REG. NO. 3,050,928.
FOR LIGHTING, NAMELY, ELECTRIC LIGHTING FIXTURES (U.S. CLS. 13, 21, 23, 31 AND 34).
DANNEAN HETZEL, EXAMINING ATTORNEY

CLASS 11—(Continued).

SN 78-702,367. KING OF FANS, INC., FT. LAUDERDALE, FL. FILED 8-29-2005.

BRIO

THE MARK CONSISTS OF STANDARD CHARACTERS WITHOUT CLAIM TO ANY PARTICULAR FONT, STYLE, SIZE, OR COLOR.

THE ENGLISH TRANSLATION OF THE WORD "BRIO" IS "ENTHUSIASTIC VIGOR, VIVACITY, VERVE".

FOR ENVIRONMENTAL CONTROL APPARATUS, NAMELY ELECTRIC FLOOR FANS AND REPLACEMENT PARTS THEREFOR; CIRCULATING FANS FOR DOMESTIC AND COMMERCIAL USE; PORTABLE ELECTRIC FANS, FIXTURES AND PARTS THEREFOR; FREESTANDING ELECTRIC FANS, FIXTURES AND PARTS THEREFOR; ELECTRIC DESK FANS, FIXTURES AND PARTS THEREFOR, EXCLUDING ELECTRIC LIGHTING FIXTURES (U.S. CLS. 13, 21, 23, 31 AND 34).
INGA ERVIN, EXAMINING ATTORNEY

SN 78-703,401. VORNADO AIR CIRCULATION SYSTEMS, INC., ANDOVER, KS. FILED 8-30-2005.

VORNADOFAN

THE MARK CONSISTS OF STANDARD CHARACTERS WITHOUT CLAIM TO ANY PARTICULAR FONT, STYLE, SIZE, OR COLOR.

OWNER OF U.S. REG. NOS. 1,636,821, 2,426,655 AND OTHERS.

FOR ELECTRIC FANS AND AIR CIRCULATORS (U.S. CLS. 13, 21, 23, 31 AND 34).

FIRST USE 3-14-2004; IN COMMERCE 3-14-2004.
PAUL E. FAHRENKOPF, EXAMINING ATTORNEY

CLASS 11—(Continued).

SN 78-717,767. LLADRO USA, INC., MOONACHIE, NJ.
FILED 9-21-2005.



OWNER OF U.S. REG. NOS. 1,310,087, 2,885,239 AND OTHERS.

THE MARK CONSISTS OF A STYLIZED FLOWER AND ANCIENT CHEMICAL SYMBOL DESIGN.

FOR BATH TUB JETS; BIDETS; DRAIN STRUCTURES FOR USE IN SPAS, STEAM ROOMS AND BATHS; FAUCET SPRAYERS; FAUCETS; FIXED SPOUTS ON WALLS AND DIRECTLY ON THE BATHS, BASINS, BIDETS; HAND HELD SHOWER HEADS; HAND SHOWERS; HAND-HELD SHOWERS; KITCHEN SINK SPRAYERS; KITCHEN SINKS; MANUALLY-OPERATED PLUMBING VALVES; MIXER FAUCETS FOR WATER PIPES; PLUMBING FITTINGS, NAMELY SHOWER CONTROL VALVES, TUB CONTROL VALVES, COUPLERS, AERATORS FOR FAUCETS, DRAINS, FAUCET FILTERS, SPOUTS, COCKS, SINK STRAINERS, VALVES; PLUMBING FIXTURES, NAMELY, SHOWER SPRAYERS; PLUMBING FIXTURES, NAMELY, SINK SPRAYERS; PORTABLE BATH SEAT; SHOWER FAUCET EXTENSIONS; SHOWER HEAD SPRAYERS; SHOWER HEADS; SINGLE LEVER FIXTURES FOR LAVATORIES AND SINKS; SINKS; TAP WATER FAUCETS; TOILET SEATS; WATER FAUCET SPOUT (U.S. CLS. 13, 21, 23, 31 AND 34).

BRIAN PINO, EXAMINING ATTORNEY

SN 78-742,419. LSI INDUSTRIES INC., CINCINNATI, OH.
FILED 10-28-2005.



NO CLAIM IS MADE TO THE EXCLUSIVE RIGHT TO USE "ADVANCED REFLECTOR TECHNOLOGY", APART FROM THE MARK AS SHOWN.

THE MARK CONSISTS OF A POLE-MOUNTED LIGHTING FIXTURE PROJECTING A CONICAL BEAM OF LIGHT SHAPED AS AND REPRESENTING THE LETTER "A" FOLLOWED BY THE LETTERS RT AND UNDERNEATH THE WORDS ADVANCED REFLECTOR TECHNOLOGY ALL INSIDE A RECTANGLE.

FOR LIGHT REFLECTORS SOLD AS AN INTEGRAL COMPONENT OF ELECTRICAL LIGHTING FIXTURES (U.S. CLS. 13, 21, 23, 31 AND 34).

FIRST USE 3-1-2006; IN COMMERCE 3-1-2006.

LAURA KOVALSKY, EXAMINING ATTORNEY

CLASS 11—(Continued).

SN 78-758,598. CORNDALE MARKETING PTE LTD, SINGAPORE, SINGAPORE, FILED 11-21-2005.



FOR REFRIGERATING MACHINES; REFRIGERATING APPARATUS, NAMELY CHILLING UNITS FOR WINES AND BEVERAGES, REFRIGERATING APPLIANCES AND INSTALLATIONS, NAMELY, CHILLERS AND RAPID WINE CHILLING UNITS, REFRIGERATING CABINETS; REFRIGERATING CHAMBERS AND REFRIGERATORS (U.S. CLS. 13, 21, 23, 31 AND 34).

GRETTA YAO, EXAMINING ATTORNEY

SN 78-765,898. GAP (APPAREL) LLC, SAN FRANCISCO, CA.
FILED 12-2-2005.

GAP

THE MARK CONSISTS OF STANDARD CHARACTERS WITHOUT CLAIM TO ANY PARTICULAR FONT, STYLE, SIZE, OR COLOR.

OWNER OF U.S. REG. NOS. 2,860,344, 3,020,444 AND OTHERS.

FOR BICYCLE LAMPS; BICYCLE LIGHTS; BICYCLE REFLECTORS; CANDLE LANTERNS; ELECTRIC FANS; ELECTRIC LIGHTS FOR CHRISTMAS TREES; ELECTRIC NIGHT LIGHTS; FLASHLIGHTS; LAMP SHADES; LAMPS (U.S. CLS. 13, 21, 23, 31 AND 34).

MYRIAH HABEEB, EXAMINING ATTORNEY

SN 78-783,975. TAYLOR, KIM L, KIBBUTZ KADARIM, ISRAEL, FILED 1-3-2006.



NO CLAIM IS MADE TO THE EXCLUSIVE RIGHT TO USE "OUTDOOR WATER STATIONS", APART FROM THE MARK AS SHOWN.

THE COLOR(S) BLACK, GREEN AND BLUE IS/ARE CLAIMED AS A FEATURE OF THE MARK.

THE MARK CONSISTS OF THE WORDING APPEARS IN BLACK, THE WATER APPEARS IN BLUE AND THE UNDERLINE AND LEAVES APPEAR IN GREEN.

FOR SINKS (U.S. CLS. 13, 21, 23, 31 AND 34).

FIRST USE 1-1-2006; IN COMMERCE 1-1-2006.

JASON TURNER, EXAMINING ATTORNEY

CLASS 11—(Continued).

SN 78-790,173. STORZ, MARKUS HANS, TUTTLINGEN, FED REP GERMANY, FILED 1-12-2006.

OWNER OF U.S. REG. NO. 3,084,430.
FOR ELECTRIC VAPORIZERS (U.S. CLS. 13, 21, 23, 31 AND 34).
FIRST USE 2-19-2002; IN COMMERCE 2-19-2002.
GRETTA YAO, EXAMINING ATTORNEY

SN 78-796,272. SLOAN VALVE COMPANY, FRANKLIN PARK, IL. FILED 1-20-2006.

FOR ELECTRONIC PLUMBING DEVICES, NAMELY, SENSOR-ACTIVATED CONTROLLERS FOR USE IN CONNECTION WITH TOILETS, URINALS AND FLUSHOMETERS (U.S. CLS. 13, 21, 23, 31 AND 34).
FIRST USE 11-8-2005; IN COMMERCE 11-8-2005.
LINDA E. BLOHM, EXAMINING ATTORNEY

SN 78-822,639. SHAW, JAMES MALCOMB II, ATLANTA, GA. FILED 2-24-2006.

Hair Instruments

THE MARK CONSISTS OF STANDARD CHARACTERS WITHOUT CLAIM TO ANY PARTICULAR FONT, STYLE, SIZE, OR COLOR.
NO CLAIM IS MADE TO THE EXCLUSIVE RIGHT TO USE "HAIR", APART FROM THE MARK AS SHOWN.
FOR HAIR DRYERS (U.S. CLS. 13, 21, 23, 31 AND 34).
ALLISON HOLTZ, EXAMINING ATTORNEY

CLASS 11—(Continued).

SN 78-827,473. SOUTHERN SALES & MARKETING GROUP, ATLANTA, GA. FILED 3-2-2006.

SOUTHERN RADIANCE

THE MARK CONSISTS OF STANDARD CHARACTERS WITHOUT CLAIM TO ANY PARTICULAR FONT, STYLE, SIZE, OR COLOR.

NO CLAIM IS MADE TO THE EXCLUSIVE RIGHT TO USE RADIANCE, APART FROM THE MARK AS SHOWN.
FOR SOLAR LIGHT FIXTURES, NAMELY, INDOOR AND OUTDOOR SOLAR POWERED LIGHTING UNITS AND FIXTURES (U.S. CLS. 13, 21, 23, 31 AND 34).
FIRST USE 11-2-2005; IN COMMERCE 11-2-2005.
JENNIFER KRISP, EXAMINING ATTORNEY

SN 78-838,094. BLING LIGHTS, ALPINE, NJ. FILED 3-15-2006.

Bling Lights

THE MARK CONSISTS OF STANDARD CHARACTERS WITHOUT CLAIM TO ANY PARTICULAR FONT, STYLE, SIZE, OR COLOR.

NO CLAIM IS MADE TO THE EXCLUSIVE RIGHT TO USE "LIGHTS", APART FROM THE MARK AS SHOWN.
FOR AUTOMOTIVE LIGHTING ACCESSORIES FOR ALL TYPES OF VEHICLES, NAMELY HEADLAMPS, TAILLIGHTS, FOG LAMPS, DRIVING LIGHTS, LED LAMPS AND SIDE SIGNAL LIGHTS, REPLACEMENT BULBS AND REPLACEMENT HID PARTS, NAMELY, BULBS (U.S. CLS. 13, 21, 23, 31 AND 34).
FIRST USE 9-1-2004; IN COMMERCE 9-15-2004.
DARRYL SPRUILL, EXAMINING ATTORNEY

SN 78-843,132. NGUYEN, PHU, ORLANDO, FL. FILED 3-22-2006.

NO CLAIM IS MADE TO THE EXCLUSIVE RIGHT TO USE "BALLOON", APART FROM THE MARK AS SHOWN.
FOR DECORATIVE LIGHTS FOR RUBBER AND PLASTIC BALLOONS (U.S. CLS. 13, 21, 23, 31 AND 34).
FIRST USE 1-1-2005; IN COMMERCE 2-4-2005.
SOPHIA S. KIM, EXAMINING ATTORNEY

CLASS 11—(Continued).

SN 78-849,666. BSH BOSCH UND SIEMENS HAUSGERAETE GMBH, MUNICH 81739, FED REP GERMANY, FILED 3-30-2006.

CLASS 11—(Continued).

SN 78-849,689. BSH BOSCH UND SIEMENS HAUSGERAETE GMBH, MUNICH, FED REP GERMANY, FILED 3-30-2006.

AMARENA

EASY CAPPUMACCHIATO

THE MARK CONSISTS OF STANDARD CHARACTERS WITHOUT CLAIM TO ANY PARTICULAR FONT, STYLE, SIZE, OR COLOR.

PRIORITY CLAIMED UNDER SEC. 44(D) ON FED REP GERMANY APPLICATION NO. 30568195.8/0, FILED 11-16-2005, REG. NO. 30568195, DATED 12-15-2005, EXPIRES 11-30-2015.

FOR HOUSEHOLD AND KITCHEN MACHINES AND EQUIPMENT, NAMELY, HEATING, STEAM PRODUCING, AND COOKING DEVICES, NAMELY, ELECTRIC COFFEE MAKERS, ELECTRIC ESPRESSO MACHINES, ELECTRIC COFFEE POTS; AND PARTS THEREFOR (U.S. CLS. 13, 21, 23, 31 AND 34).

KENNETH E. SHARPERSON, EXAMINING ATTORNEY

THE MARK CONSISTS OF STANDARD CHARACTERS WITHOUT CLAIM TO ANY PARTICULAR FONT, STYLE, SIZE, OR COLOR.

PRIORITY CLAIMED UNDER SEC. 44(D) ON FED REP GERMANY APPLICATION NO. 305626531, FILED 10-20-2005, REG. NO. 305626531, DATED 11-17-2005, EXPIRES 10-31-2015.

FOR HOUSEHOLD AND KITCHEN MACHINES AND EQUIPMENT, NAMELY, HEATING, STEAM PRODUCING, AND COOKING DEVICES, NAMELY, ELECTRIC COFFEE MAKERS, ELECTRIC ESPRESSO MACHINES, ELECTRIC COFFEE POTS, AND PARTS THEREFOR (U.S. CLS. 13, 21, 23, 31 AND 34).

KENNETH E. SHARPERSON, EXAMINING ATTORNEY

SN 78-849,678. BSH BOSCH UND SIEMENS HAUSGERAETE GMBH, MUNICH, FED REP GERMANY, FILED 3-30-2006.

SN 78-849,752. BSH BOSCH UND SIEMENS HAUSGERAETE GMBH, MUNICH, FED REP GERMANY, FILED 3-30-2006.

EASY MACCHIATO

AUTOMACCHIATO

THE MARK CONSISTS OF STANDARD CHARACTERS WITHOUT CLAIM TO ANY PARTICULAR FONT, STYLE, SIZE, OR COLOR.

PRIORITY CLAIMED UNDER SEC. 44(D) ON FED REP GERMANY APPLICATION NO. 305626558, FILED 10-20-2005, REG. NO. 305626558, DATED 11-17-2005, EXPIRES 10-31-2015.

NO CLAIM IS MADE TO THE EXCLUSIVE RIGHT TO USE "MACCHIATO", APART FROM THE MARK AS SHOWN.

FOR HOUSEHOLD AND KITCHEN MACHINES AND EQUIPMENT, NAMELY, HEATING, STEAM PRODUCING, AND COOKING DEVICES, NAMELY, ELECTRIC COFFEE MAKERS, ELECTRIC ESPRESSO MACHINES, ELECTRIC COFFEE POTS, AND PARTS THEREFOR (U.S. CLS. 13, 21, 23, 31 AND 34).

KENNETH E. SHARPERSON, EXAMINING ATTORNEY

THE MARK CONSISTS OF STANDARD CHARACTERS WITHOUT CLAIM TO ANY PARTICULAR FONT, STYLE, SIZE, OR COLOR.

PRIORITY CLAIMED UNDER SEC. 44(D) ON FED REP GERMANY APPLICATION NO. 30562657.4, FILED 10-20-2005, REG. NO. 30562657, DATED 11-17-2005, EXPIRES 10-31-2015.

FOR HOUSEHOLD AND KITCHEN MACHINES AND EQUIPMENT, NAMELY, HEATING, STEAM PRODUCING, AND COOKING DEVICES, NAMELY, ELECTRIC COFFEE MAKERS, ELECTRIC ESPRESSO MACHINES, ELECTRIC COFFEE POTS, AND PARTS THEREFOR (U.S. CLS. 13, 21, 23, 31 AND 34).

KENNETH E. SHARPERSON, EXAMINING ATTORNEY

CLASS 11—(Continued).

SN 78-849,778. BSH BOSCH UND SIEMENS HAUSGERAETE GMBH, MUNICH, FED REP GERMANY, FILED 3-30-2006.

VELOCCINO

THE MARK CONSISTS OF STANDARD CHARACTERS WITHOUT CLAIM TO ANY PARTICULAR FONT, STYLE, SIZE, OR COLOR.

PRIORITY CLAIMED UNDER SEC. 44(D) ON FED REP GERMANY APPLICATION NO. 305626566, FILED 10-20-2005, REG. NO. 30562656, DATED 11-17-2005, EXPIRES 10-31-2015.

FOR HOUSEHOLD AND KITCHEN MACHINES AND EQUIPMENT, NAMELY, HEATING, STEAM PRODUCING, AND COOKING DEVICES, NAMELY, ELECTRIC COFFEE MAKERS, ELECTRIC ESPRESSO MACHINES, ELECTRIC COFFEE POTS; AND PARTS THEREFOR (U.S. CLS. 13, 21, 23, 31 AND 34).

KENNETH E. SHARPERSON, EXAMINING ATTORNEY

SN 78-853,003. THE BASIC SOURCE, INC., ROHNERT PARK, CA. FILED 4-3-2006.

ALUMENT

THE MARK CONSISTS OF STANDARD CHARACTERS WITHOUT CLAIM TO ANY PARTICULAR FONT, STYLE, SIZE, OR COLOR.

FOR ELECTRIC LIGHTING FIXTURES (U.S. CLS. 13, 21, 23, 31 AND 34).

FIRST USE 10-14-2005; IN COMMERCE 10-14-2005.
LINDA MICKLEBURGH, EXAMINING ATTORNEY

SN 78-853,103. AQUATIC INDUSTRIES, INC., LEANDER, TX. FILED 4-4-2006.

HOTSOAK

THE MARK CONSISTS OF STANDARD CHARACTERS WITHOUT CLAIM TO ANY PARTICULAR FONT, STYLE, SIZE, OR COLOR.

FOR BATHTUBS; WATER JETS FOR USE IN BATHTUBS; WHIRLPOOL BATHS; WHIRLPOOLS (U.S. CLS. 13, 21, 23, 31 AND 34).

MARTHA FROMM, EXAMINING ATTORNEY

CLASS 11—(Continued).

SN 78-853,223. SEVERN TRENT WATER PURIFICATION, INC., COLMAR, PA. FILED 4-4-2006.

CLORTEC

THE MARK CONSISTS OF STANDARD CHARACTERS WITHOUT CLAIM TO ANY PARTICULAR FONT, STYLE, SIZE, OR COLOR.

FOR WATER TREATMENT EQUIPMENT, NAMELY, HYPOCHLORITE GENERATORS AND CHEMICAL VAPOR CONTROL SYSTEMS; WATER STORAGE MANAGEMENT SYSTEM, NAMELY, EQUIPMENT TO PREVENT THERMAL STRATIFICATION AND STAGNATION AND TO ALLOW BLENDING OF DIFFERENT WATER QUALITIES WITHIN THE SYSTEM (U.S. CLS. 13, 21, 23, 31 AND 34).

FIRST USE 7-29-1997; IN COMMERCE 7-29-1997.
JAMES MACFARLANE, EXAMINING ATTORNEY

SN 78-855,658. MECHANICAL MANUFACTURING CORPORATION, SUNRISE, FL. FILED 4-6-2006.

ACCUFIT

THE MARK CONSISTS OF STANDARD CHARACTERS WITHOUT CLAIM TO ANY PARTICULAR FONT, STYLE, SIZE, OR COLOR.

FOR LIQUID FILTER BAGS FOR INDUSTRIAL USE IN REMOVING PARTICULATE FROM LIQUIDS, NAMELY, PAINTS, OILS, REFRIGERANTS, CHEMICALS, BEVERAGES AND WATER, FOR COMMERCIAL AND INDUSTRIAL USE (U.S. CLS. 13, 21, 23, 31 AND 34).

FIRST USE 1-1-1993; IN COMMERCE 1-1-1993.
MICHAEL ENGEL, EXAMINING ATTORNEY

SN 78-855,671. MECHANICAL MANUFACTURING CORPORATION, SUNRISE, FL. FILED 4-6-2006.

VALUFIT

THE MARK CONSISTS OF STANDARD CHARACTERS WITHOUT CLAIM TO ANY PARTICULAR FONT, STYLE, SIZE, OR COLOR.

FOR LIQUID FILTER BAGS FOR INDUSTRIAL USE IN REMOVING PARTICULATE FROM LIQUIDS, NAMELY, PAINTS, OILS, REFRIGERANTS, CHEMICALS, BEVERAGES AND WATER, FOR COMMERCIAL AND INDUSTRIAL USE (U.S. CLS. 13, 21, 23, 31 AND 34).

FIRST USE 9-1-2005; IN COMMERCE 9-1-2005.
MICHAEL ENGEL, EXAMINING ATTORNEY

CLASS 11—(Continued).

SN 78-860,042. TROPICAL BREEZE PRODUCTS, INC., FT. LAUDERDALE, FL. FILED 4-12-2006.

GIZA

THE MARK CONSISTS OF STANDARD CHARACTERS WITHOUT CLAIM TO ANY PARTICULAR FONT, STYLE, SIZE, OR COLOR.

FOR PORTABLE ELECTRIC ROOM AND SPACE HEATERS FOR INDOOR USE, GAS SPACE HEATERS FOR INDOOR AND OUTDOOR USE; CIRCULATING FANS FOR DOMESTIC AND COMMERCIAL USE; ELECTRIC HIGH VELOCITY WALL SURFACE MOUNTED FANS AND PARTS THEREFOR; AND ELECTRIC HIGH VELOCITY FLOOR FANS AND PARTS THEREFOR; PORTABLE ELECTRIC FANS AND PARTS THEREFOR; FREESTANDING ELECTRIC FANS AND PARTS THEREFOR; ELECTRIC DESK FANS AND PARTS THEREFOR (U.S. CLS. 13, 21, 23, 31 AND 34).
ADA HAN, EXAMINING ATTORNEY

SN 78-860,068. TROPICAL BREEZE PRODUCTS, INC., FT. LAUDERDALE, FL. FILED 4-12-2006.

NESIKA

THE MARK CONSISTS OF STANDARD CHARACTERS WITHOUT CLAIM TO ANY PARTICULAR FONT, STYLE, SIZE, OR COLOR.

FOR PORTABLE ELECTRIC ROOM AND SPACE HEATERS FOR INDOOR USE, GAS SPACE HEATERS FOR INDOOR AND OUTDOOR USE; CIRCULATING FANS FOR DOMESTIC AND COMMERCIAL USE; ELECTRIC HIGH VELOCITY WALL SURFACE MOUNTED FANS AND PARTS THEREFOR; AND ELECTRIC HIGH VELOCITY FLOOR FANS AND PARTS THEREFOR; PORTABLE ELECTRIC FANS AND PARTS THEREFOR; FREESTANDING ELECTRIC FANS AND PARTS THEREFOR; ELECTRIC DESK FANS AND PARTS THEREFOR (U.S. CLS. 13, 21, 23, 31 AND 34).
ADA HAN, EXAMINING ATTORNEY

SN 78-860,792. VINTAGE AIR, INC., SAN ANTONIO, TX. FILED 4-13-2006.

SureFit

THE MARK CONSISTS OF STANDARD CHARACTERS WITHOUT CLAIM TO ANY PARTICULAR FONT, STYLE, SIZE, OR COLOR.

FOR AUTOMOTIVE AIR CONDITIONERS AND PARTS THEREFOR (U.S. CLS. 13, 21, 23, 31 AND 34).
JANICE KIM, EXAMINING ATTORNEY

CLASS 11—(Continued).

SN 78-861,192. KESSLER INDUSTRIES, INC., PATERSON, NJ. FILED 4-13-2006.

LIENA BAY

THE MARK CONSISTS OF STANDARD CHARACTERS WITHOUT CLAIM TO ANY PARTICULAR FONT, STYLE, SIZE, OR COLOR.

FOR KITCHEN AND BATH PLUMBING FIXTURES, NAMELY SINKS, BATHTUBS, FAUCETS, AND TOILETS (U.S. CLS. 13, 21, 23, 31 AND 34).

JASON BLAIR, EXAMINING ATTORNEY

SN 78-862,574. RHYNE & SON, INC., RINGGOLD, GA. FILED 4-17-2006.

OWNER OF U.S. REG. NO. 3,032,301.
FOR LAMPS (U.S. CLS. 13, 21, 23, 31 AND 34).
JOHN WILKE, EXAMINING ATTORNEY

SN 78-862,828. ESSENERGY, INC., MILPITAS, CA. FILED 4-17-2006.

VitaClay

THE MARK CONSISTS OF STANDARD CHARACTERS WITHOUT CLAIM TO ANY PARTICULAR FONT, STYLE, SIZE, OR COLOR.

FOR ELECTRIC COOKING POTS FOR HOUSEHOLD PURPOSES (U.S. CLS. 13, 21, 23, 31 AND 34).
FIRST USE 3-10-2005; IN COMMERCE 3-10-2005.
BARNEY CHARLON, EXAMINING ATTORNEY

CLASS 11—(Continued).

SN 78-863,723. LACY, JARVIS, GRAND PRAIRIE, TX. FILED 4-18-2006.

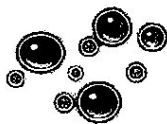

VITASHOWER
WWW.ROBIN-ONLINE.COM

FOR VITAMIN C DECHLORINATING SHOWER FILTERS (U.S. CLS. 13, 21, 23, 31 AND 34).
KELLY BOULTON, EXAMINING ATTORNEY

SN 78-863,949. LEE, BRYANT, GREENDALE, WI. AND LEE, LINDA, GREENDALE, WI. FILED 4-18-2006.



THE MARK CONSISTS OF STYLIZED IMAGE OF SUN INSIDE A DIAMOND.
FOR WATER FILTERS (U.S. CLS. 13, 21, 23, 31 AND 34).
ANNE FARRELL, EXAMINING ATTORNEY

SN 78-866,041. OLYMPIC MEDICAL CORP., SEATTLE, WA. FILED 4-20-2006.

WARMETTE

THE MARK CONSISTS OF STANDARD CHARACTERS WITHOUT CLAIM TO ANY PARTICULAR FONT, STYLE, SIZE, OR COLOR.

FOR ELECTRONIC APPARATUS, NAMELY, BLANKET AND SOLUTION WARMERS FOR PEDIATRIC, EMERGENCY DEPARTMENT, OPERATING ROOM, AND RECOVERY ROOM USE (U.S. CLS. 13, 21, 23, 31 AND 34).

FIRST USE 12-2-1991; IN COMMERCE 12-2-1991.
JULIE WATSON, EXAMINING ATTORNEY

CLASS 11—(Continued).

SN 78-866,708. KEURIG, INCORPORATED, WAKEFIELD, MA. FILED 4-21-2006.

MY K-CUP

THE MARK CONSISTS OF STANDARD CHARACTERS WITHOUT CLAIM TO ANY PARTICULAR FONT, STYLE, SIZE, OR COLOR.

FOR REUSABLE PLASTIC CARTRIDGE CONTAINING A FILTER FOR USE IN COFFEE BREWING MACHINES (U.S. CLS. 13, 21, 23, 31 AND 34).

FIRST USE 9-30-2005; IN COMMERCE 9-30-2005.
CAROLYN CATALDO, EXAMINING ATTORNEY

SN 78-867,275. BLANFORD, THOMAS C., VENTURA, CA. FILED 4-21-2006.



NO CLAIM IS MADE TO THE EXCLUSIVE RIGHT TO USE "STUDIO", APART FROM THE MARK AS SHOWN.
FOR TABLETOP LIGHT BOX STUDIO FOR PHOTOGRAPHY (U.S. CLS. 13, 21, 23, 31 AND 34).
FIRST USE 6-15-2005; IN COMMERCE 2-1-2006.
PAUL E. FAHRENKOPF, EXAMINING ATTORNEY

SN 78-868,255. ETS, INC., INDIANAPOLIS, IN. FILED 4-24-2006.

LUMAGEN

THE MARK CONSISTS OF STANDARD CHARACTERS WITHOUT CLAIM TO ANY PARTICULAR FONT, STYLE, SIZE, OR COLOR.

FOR TANNING BEDS (U.S. CLS. 13, 21, 23, 31 AND 34).
MARGERY A. TIERNEY, EXAMINING ATTORNEY

CLASS 11—(Continued).

SN 78-868,297. HYDRABATHS, INC., SANTA ANA, CA. FILED 4-24-2006.

BUILDING A BETTER WHIRL

THE MARK CONSISTS OF STANDARD CHARACTERS WITHOUT CLAIM TO ANY PARTICULAR FONT, STYLE, SIZE, OR COLOR.
FOR BATH TUB JETS; WHIRLPOOL BATHS; WHIRLPOOL JETS (U.S. CLS. 13, 21, 23, 31 AND 34).
FIRST USE 2-1-1981; IN COMMERCE 2-1-1981.
BARNEY CHARLON, EXAMINING ATTORNEY

SN 78-868,376. FANCY KOI OUTLET, SAN JOSE, CA. FILED 4-24-2006.

DreamPond

THE MARK CONSISTS OF STANDARD CHARACTERS WITHOUT CLAIM TO ANY PARTICULAR FONT, STYLE, SIZE, OR COLOR.
FOR PLUMBING FITTINGS, NAMELY DRAINS, COUPLERS, VALVES (U.S. CLS. 13, 21, 23, 31 AND 34).
KELLY MCCOY, EXAMINING ATTORNEY

SN 78-868,980. PCS VACDRY USA LIMITED PARTNERSHIP, JERSEY SHORE, PA. FILED 4-25-2006.

VACDRY KILNS

THE MARK CONSISTS OF STANDARD CHARACTERS WITHOUT CLAIM TO ANY PARTICULAR FONT, STYLE, SIZE, OR COLOR.
NO CLAIM IS MADE TO THE EXCLUSIVE RIGHT TO USE "KILNS", APART FROM THE MARK AS SHOWN.
FOR VACUUM DRYING KILNS FOR DRYING WOOD (U.S. CLS. 13, 21, 23, 31 AND 34).
ANDREW RHIM, EXAMINING ATTORNEY

CLASS 11—(Continued).

SN 78-868,993. PCS VACDRY KILNS LIMITED, HASTINGS, NEW ZEALAND, FILED 4-25-2006.

VACDRY

THE MARK CONSISTS OF STANDARD CHARACTERS WITHOUT CLAIM TO ANY PARTICULAR FONT, STYLE, SIZE, OR COLOR.
FOR VACUUM DRYING KILNS FOR DRYING WOOD (U.S. CLS. 13, 21, 23, 31 AND 34).
ANDREW RHIM, EXAMINING ATTORNEY

SN 78-870,008. ENTEGRIS, INC., CHASKA, MN. FILED 4-26-2006.

phasor

THE MARK CONSISTS OF STANDARD CHARACTERS WITHOUT CLAIM TO ANY PARTICULAR FONT, STYLE, SIZE, OR COLOR.
FOR HEAT EXCHANGER FOR HIGH PURITY FLUIDS (U.S. CLS. 13, 21, 23, 31 AND 34).
FIRST USE 1-1-2006; IN COMMERCE 1-1-2006.
DAYNA BROWNE, EXAMINING ATTORNEY

SN 78-870,510. ENVIRONMENTAL DYNAMICS GROUP, PRINCETON, NJ. FILED 4-26-2006.

DYNAMIC

THE MARK CONSISTS OF STANDARD CHARACTERS WITHOUT CLAIM TO ANY PARTICULAR FONT, STYLE, SIZE, OR COLOR.
FOR AIR CLEANING UNITS; AIR FILTERS FOR AIR CONDITIONING UNITS; AIR FILTERS FOR DOMESTIC USE; AIR FILTERS FOR INDUSTRIAL INSTALLATIONS; AIR PURIFICATION UNITS; AIR PURIFIERS; AIR PURIFYING UNITS FOR RESIDENTIAL, COMMERCIAL, AND INDUSTRIAL USE; HOUSEHOLD AIR CLEANERS; INDUSTRIAL AIR FILTER MACHINES; INDUSTRIAL AIR PURIFIERS (U.S. CLS. 13, 21, 23, 31 AND 34).
FIRST USE 10-30-1998; IN COMMERCE 10-30-1998.
ALEXANDER L. POWERS, EXAMINING ATTORNEY

CLASS 11—(Continued).

SN 78-872,449. UNITED STATES STOVE COMPANY, SOUTH PITTSBURG, TN. FILED 4-28-2006.

MIRACLE HEAT

THE MARK CONSISTS OF STANDARD CHARACTERS WITHOUT CLAIM TO ANY PARTICULAR FONT, STYLE, SIZE, OR COLOR.

NO CLAIM IS MADE TO THE EXCLUSIVE RIGHT TO USE "HEAT", APART FROM THE MARK AS SHOWN.

FOR HEAT RECOVERY UNITS FOR USE IN STOVE AND FURNACE FLUE PIPES (U.S. CLS. 13, 21, 23, 31 AND 34).

FIRST USE 7-0-1980; IN COMMERCE 7-0-1980.
PAM WILLIS, EXAMINING ATTORNEY

CLASS 11—(Continued).

SN 78-874,420. COMPANIA MEXICANA DE CERAMICA, S.A. DE C.V., SALINAS VICTORIA, MEXICO, FILED 5-2-2006.

MAXIMUS

THE MARK CONSISTS OF STANDARD CHARACTERS WITHOUT CLAIM TO ANY PARTICULAR FONT, STYLE, SIZE, OR COLOR.

FOR TOILETS (U.S. CLS. 13, 21, 23, 31 AND 34).
FIRST USE 7-1-2005; IN COMMERCE 7-1-2005.
DOMINIC FATHY, EXAMINING ATTORNEY

SN 78-872,648. WILTON INDUSTRIES, INC., WOODRIDGE, IL. FILED 4-28-2006.

CHOCOLATE PRO

THE MARK CONSISTS OF STANDARD CHARACTERS WITHOUT CLAIM TO ANY PARTICULAR FONT, STYLE, SIZE, OR COLOR.

OWNER OF U.S. REG. NOS. 2,716,490 AND 2,907,065.

NO CLAIM IS MADE TO THE EXCLUSIVE RIGHT TO USE "CHOCOLATE", APART FROM THE MARK AS SHOWN.

FOR AN ELECTRIC POT WHICH MELTS CHOCOLATE (U.S. CLS. 13, 21, 23, 31 AND 34).

FIRST USE 3-15-2006; IN COMMERCE 3-15-2006.
MARY ROSSMAN, EXAMINING ATTORNEY

SN 78-874,035. UNITED STATES STOVE COMPANY, SOUTH PITTSBURG, TN. FILED 5-2-2006.

FORESTER

THE MARK CONSISTS OF STANDARD CHARACTERS WITHOUT CLAIM TO ANY PARTICULAR FONT, STYLE, SIZE, OR COLOR.

FOR WOOD BURNING STOVES (U.S. CLS. 13, 21, 23, 31 AND 34).

FIRST USE 8-10-1978; IN COMMERCE 8-10-1978.
PAM WILLIS, EXAMINING ATTORNEY

SN 78-877,627. CONAIR CORPORATION, STAMFORD, CT. FILED 5-5-2006.

GRIDDLER GOURMET

THE MARK CONSISTS OF STANDARD CHARACTERS WITHOUT CLAIM TO ANY PARTICULAR FONT, STYLE, SIZE, OR COLOR.

OWNER OF U.S. REG. NO. 2,983,938.

FOR ELECTRIC GRIDDLES (U.S. CLS. 13, 21, 23, 31 AND 34).

SCOTT SISUN, EXAMINING ATTORNEY

SN 78-879,557. CONAIR CORPORATION, STAMFORD, CT. FILED 5-9-2006.

GRIDDLER PLUS

THE MARK CONSISTS OF STANDARD CHARACTERS WITHOUT CLAIM TO ANY PARTICULAR FONT, STYLE, SIZE, OR COLOR.

OWNER OF U.S. REG. NO. 2,983,938.

FOR ELECTRIC GRIDDLES; ELECTRIC GRILLS; ELECTRIC WAFFLE MAKER (U.S. CLS. 13, 21, 23, 31 AND 34).

SCOTT SISUN, EXAMINING ATTORNEY

CLASS 11—(Continued).

SN 78-893,663. RC2 BRANDS, INC., OAK BROOK, IL. FILED 5-26-2006.

BABY BREW

THE MARK CONSISTS OF STANDARD CHARACTERS WITHOUT CLAIM TO ANY PARTICULAR FONT, STYLE, SIZE, OR COLOR.

NO CLAIM IS MADE TO THE EXCLUSIVE RIGHT TO USE "BABY", APART FROM THE MARK AS SHOWN.

FOR ELECTRICAL DEVICES TO BE PLUGGED INTO WALL OUTLETS HAVING A HEATING ELEMENT AND WHICH DISPENSES BABY FORMULAS IN LIQUID AND POWDER FORM FOR NON-MEDICAL USE (U.S. CLS. 13, 21, 23, 31 AND 34).

TONI HICKEY, EXAMINING ATTORNEY

CLASS 12—VEHICLES

SN 76-633,640. WIN-HOLT EQUIPMENT CORP., GARDEN CITY, NY. FILED 3-14-2005.

U-BOAT

THE MARK CONSISTS OF STANDARD CHARACTERS WITHOUT CLAIM TO ANY PARTICULAR FONT, STYLE, SIZE, OR COLOR.

FOR MATERIAL HANDLING EQUIPMENT, NAMELY, HAND TRUCKS USED PRIMARILY IN SUPERMARKETS, HOME CENTERS, AND RETAIL STORES (U.S. CLS. 19, 21, 23, 31, 35 AND 44).

FIRST USE 2-1-2005; IN COMMERCE 2-1-2005.

PRISCILLA MILTON, EXAMINING ATTORNEY

SN 78-895,827. ETS, INC., INDIANAPOLIS, IN. FILED 5-30-2006.

DARK SUN

THE MARK CONSISTS OF STANDARD CHARACTERS WITHOUT CLAIM TO ANY PARTICULAR FONT, STYLE, SIZE, OR COLOR.

FOR ULTRAVIOLET LAMPS NOT FOR MEDICAL PURPOSES (U.S. CLS. 13, 21, 23, 31 AND 34).

MARGERY A. TIERNEY, EXAMINING ATTORNEY

SN 76-646,505. DR. ING. H.C. F. PORSCHE AG, 70435 STUTTGART-ZUFFENHAUSEN, FED REP GERMANY, FILED 9-8-2005.

PORSCHE
Speedster

OWNER OF FED REP GERMANY REG. NO. 1116936, DATED 1-22-1988, EXPIRES 12-30-2007.

OWNER OF U.S. REG. NOS. 618,933, 1,036,454 AND OTHERS.

NO CLAIM IS MADE TO THE EXCLUSIVE RIGHT TO USE "SPEEDSTER", APART FROM THE MARK AS SHOWN. FOR SPORTS CARS (U.S. CLS. 19, 21, 23, 31, 35 AND 44).

KELLY BOULTON, EXAMINING ATTORNEY

SN 78-919,629. HEB GROCERY COMPANY, LP, SAN ANTONIO, TX. FILED 6-29-2006.

LONE STAR STATEMENTS

THE MARK CONSISTS OF STANDARD CHARACTERS WITHOUT CLAIM TO ANY PARTICULAR FONT, STYLE, SIZE, OR COLOR.

FOR ELECTRIC TOASTERS; ELECTRIC COFFEE MAKERS; ELECTRIC KITCHEN COOKING APPLIANCES, NAMELY, ELECTRIC GRILLS, SLOW COOKERS, AND FONDUE SETS (U.S. CLS. 13, 21, 23, 31 AND 34).

EUGENIA MARTIN, EXAMINING ATTORNEY

SN 76-647,383. CHEN, PO-LIN, LAS VEGAS, NV. FILED 9-23-2005.

AZ
AIR-ZENITH

FOR AUTOMOBILE SUSPENSION SYSTEM COMPONENTS, NAMELY, AIR PUMPS (U.S. CLS. 19, 21, 23, 31, 35 AND 44).

FIRST USE 5-20-2005; IN COMMERCE 5-20-2005.

DAVID TAYLOR, EXAMINING ATTORNEY

CLASS 12—(Continued).

SN 76-649,955. BAYERISCHE MOTOREN WERKE AKTIENGESELLSCHAFT, 80809 MUNICH, FED REP GERMANY, FILED 11-8-2005.

THE RIDE IS ON

THE MARK CONSISTS OF STANDARD CHARACTERS WITHOUT CLAIM TO ANY PARTICULAR FONT, STYLE, SIZE, OR COLOR.

FOR MOTORCYCLES AND STRUCTURAL PARTS THEREFOR (U.S. CLS. 19, 21, 23, 31, 35 AND 44).

FIRST USE 2-0-2004; IN COMMERCE 2-0-2004.
KRISTINA KLOIBER, EXAMINING ATTORNEY

CLASS 12—(Continued).

SN 76-658,586. THE STANDING COMPANY, SAGINAW, MI. FILED 4-17-2006.

NANO

THE MARK CONSISTS OF STANDARD CHARACTERS WITHOUT CLAIM TO ANY PARTICULAR FONT, STYLE, SIZE, OR COLOR.

FOR WHEELCHAIRS (U.S. CLS. 19, 21, 23, 31, 35 AND 44).

FIRST USE 3-28-2006; IN COMMERCE 3-28-2006.
CHRISTOPHER BUONGIORNO, EXAMINING ATTORNEY

SN 76-654,099. SOUTHWEST RESEARCH INSTITUTE, SAN ANTONIO, TX. FILED 1-26-2006.

SKYWISP

THE MARK CONSISTS OF STANDARD CHARACTERS WITHOUT CLAIM TO ANY PARTICULAR FONT, STYLE, SIZE, OR COLOR.

FOR REMOTE-CONTROLLED GLIDERS FOR SCIENTIFIC USE (U.S. CLS. 19, 21, 23, 31, 35 AND 44).

FIRST USE 3-11-2005; IN COMMERCE 3-11-2005.
MARTHA SANTOMARTINO, EXAMINING ATTORNEY



SN 76-659,007. SERRANO FERNANDEZ, DANIEL, 46018 VALENCIA, SPAIN, AND SERRANO FERNANDEZ, PEDRO, 46018 VALENCIA, SPAIN, FILED 4-25-2006.

SN 76-657,470. TRACTOR SUPPLY CO. OF TEXAS, LP, BRENTWOOD, TN. FILED 3-29-2006.

MANITOBA

THE MARK CONSISTS OF STANDARD CHARACTERS WITHOUT CLAIM TO ANY PARTICULAR FONT, STYLE, SIZE, OR COLOR.

FOR GASOLINE AND DIESEL ENGINES FOR LAND VEHICLES (U.S. CLS. 19, 21, 23, 31, 35 AND 44).

PAM WILLIS, EXAMINING ATTORNEY

FOR MIRRORS FOR VEHICLES NAMELY, REAR VIEW MIRRORS AND VANITY MIRRORS (U.S. CLS. 19, 21, 23, 31, 35 AND 44).

JENNY PARK, EXAMINING ATTORNEY

SN 76-660,150. AIRERX HEALTHCARE, LLC, NASHVILLE, TN. FILED 5-17-2006.

AN OVERDUE CLINICAL BREAKTHROUGH

THE MARK CONSISTS OF STANDARD CHARACTERS WITHOUT CLAIM TO ANY PARTICULAR FONT, STYLE, SIZE, OR COLOR.

FOR WHEELCHAIR CUSHIONS (U.S. CLS. 19, 21, 23, 31, 35 AND 44).

CHRISTINE COOPER, EXAMINING ATTORNEY

CLASS 12—(Continued).

SN 78-485,539. EUROCOPTER, 13725 MARIGNANE CEDEX, FRANCE, FILED 9-17-2004.

PRV-21

THE MARK CONSISTS OF STANDARD CHARACTERS WITHOUT CLAIM TO ANY PARTICULAR FONT, STYLE, SIZE, OR COLOR.

PRIORITY CLAIMED UNDER SEC. 44(D) ON ERP N CMNTY TM OFC APPLICATION NO. 004026852, FILED 9-17-2004, REG. NO. 004026852, DATED 9-17-2006, EXPIRES 9-17-2014.

FOR VEHICLES, NAMELY, AIRCRAFT, HELICOPTERS, ROTORCRAFTS, TRUCKS AND CARS (U.S. CLS. 19, 21, 23, 31, 35 AND 44).

JOHN DWYER, EXAMINING ATTORNEY

SN 78-639,340. MAZDA MOTOR CORPORATION, HIROSHI-MA, JAPAN, FILED 5-27-2005.

BT-50

THE MARK CONSISTS OF STANDARD CHARACTERS WITHOUT CLAIM TO ANY PARTICULAR FONT, STYLE, SIZE, OR COLOR.

FOR AUTOMOBILES AND STRUCTURAL PARTS THEREOF, BUT EXCLUDING TIRES; ENGINES FOR AUTOMOBILES; MOTORS AND ENGINES FOR LAND VEHICLES; SUSPENSION SYSTEMS FOR AUTOMOBILES; SHOCK ABSORBERS AND SPRINGS FOR LAND VEHICLE SUSPENSION SYSTEMS; DRIVE SHAFTS AND AXLES FOR LAND VEHICLES; WHEEL BEARINGS AND SHAFT COUPLINGS FOR LAND VEHICLES; TRANSMISSIONS FOR LAND VEHICLES; BRAKES FOR LAND VEHICLES; ANTI-THEFT ALARMS FOR VEHICLES (U.S. CLS. 19, 21, 23, 31, 35 AND 44).

NANCY CLARKE, EXAMINING ATTORNEY

CLASS 12—(Continued).

SN 78-646,664. FOUR WHEEL DRIVE HARDWARE, L.L.C., COLUMBIANA, OH. FILED 6-8-2005.



OWNER OF U.S. REG. NOS. 1,287,048, 2,281,093 AND OTHERS.

THE MARK CONSISTS OF GRAPHIC SQUARES WITH A LARGE W AND THE TEXT WELTMEISTER UNDERNEATH THE W.

THE ENGLISH TRANSLATION OF THE WORD WELTMEISTER IN THE MARK IS "WORLD CHAMPION" OR "WORLD MASTER".

FOR SUSPENSION SPRINGS FOR AUTOMOBILES, PLASTIC SUSPENSION BUSHINGS FOR AUTOMOBILES, PEDAL CLUSTER BUSHINGS FOR AUTOMOBILES, AND SWAY BARS (U.S. CLS. 19, 21, 23, 31, 35 AND 44).

FIRST USE 6-9-1982; IN COMMERCE 6-9-1982.

ELISSA GARBER KON, EXAMINING ATTORNEY

SN 78-662,984. CRYSTAL CREEK, INC., LAGRANGE, IN. FILED 7-1-2005.

CRYSTAL CREEK

THE MARK CONSISTS OF STANDARD CHARACTERS WITHOUT CLAIM TO ANY PARTICULAR FONT, STYLE, SIZE, OR COLOR.

FOR RECREATIONAL VEHICLES, NAMELY CAMPERS, TRUCK CAMPERS, MOTOR HOMES, TRAILERS, AND FIFTH WHEELS (U.S. CLS. 19, 21, 23, 31, 35 AND 44).

JOHN DWYER, EXAMINING ATTORNEY

SN 78-682,514. MOLNARI, INC., RICHARDSON, TX. FILED 8-1-2005.

Molnari

THE MARK CONSISTS OF STANDARD CHARACTERS WITHOUT CLAIM TO ANY PARTICULAR FONT, STYLE, SIZE, OR COLOR.

FOR AIRCRAFT (U.S. CLS. 19, 21, 23, 31, 35 AND 44).

STEVEN PEREZ, EXAMINING ATTORNEY

CLASS 12—(Continued).

SN 78-685,462. ROLSTON, JOE S. IV, LAS VEGAS, NV. FILED 8-4-2005.

It's Vegas, Baby!

THE MARK CONSISTS OF STANDARD CHARACTERS WITHOUT CLAIM TO ANY PARTICULAR FONT, STYLE, SIZE, OR COLOR.

FOR WINDSHIELD SUNSHADES; AUTOMOBILES (U.S. CLS. 19, 21, 23, 31, 35 AND 44).
SEAN CROWLEY, EXAMINING ATTORNEY

SN 78-695,296. TRUXXX MANUFACTURING, LLC, TUCSON, AZ. FILED 8-18-2005.

Truxxx

THE MARK CONSISTS OF STANDARD CHARACTERS WITHOUT CLAIM TO ANY PARTICULAR FONT, STYLE, SIZE, OR COLOR.

FOR STRUCTURAL PARTS FOR TRUCKS (U.S. CLS. 19, 21, 23, 31, 35 AND 44).
FIRST USE 2-20-2004; IN COMMERCE 2-20-2004.
HANNO RITTNER, EXAMINING ATTORNEY

SN 78-707,270. FUSION WAKEBOARD ACCESSORIES, INC., PLEASANTON, CA. FILED 9-6-2005.

FUSION WAKE

THE MARK CONSISTS OF STANDARD CHARACTERS WITHOUT CLAIM TO ANY PARTICULAR FONT, STYLE, SIZE, OR COLOR.

FOR BOAT PARTS, NAMELY, WAKEBOARD TOWERS AND RACKS, WAKEBOARD TOWER MIRRORS, AND CLAMPS FOR MOUNTING RACKS, LIGHT BARS, MIRRORS, AND AUDIO SPEAKERS ON WAKEBOARD TOWERS (U.S. CLS. 19, 21, 23, 31, 35 AND 44).
RONALD AIKENS, EXAMINING ATTORNEY

CLASS 12—(Continued).

SN 78-707,624. FUSION WAKEBOARD ACCESSORIES, INC., PLEASANTON, CA. FILED 9-6-2005.



THE MARK CONSISTS OF A STYLIZED LETTER F IN A HEXAGON SURROUNDED BY THREE CHEVRON SHAPED DESIGNS.

FOR BOAT PARTS, NAMELY, WAKEBOARD TOWERS AND RACKS FOR BOATS, WAKEBOARD TOWER MIRRORS, AND CLAMPS FOR MOUNTING RACKS, LIGHT BARS, MIRRORS, AND AUDIO SPEAKERS ON WAKEBOARD TOWERS (U.S. CLS. 19, 21, 23, 31, 35 AND 44).
FIRST USE 10-23-2003; IN COMMERCE 10-23-2003.
KATHERINE STOIDES, EXAMINING ATTORNEY

SN 78-708,128. JAYCO, INC., MIDDLEBURY, IN. FILED 9-7-2005.

JAY FLIGHT

THE MARK CONSISTS OF STANDARD CHARACTERS WITHOUT CLAIM TO ANY PARTICULAR FONT, STYLE, SIZE, OR COLOR.

FOR RECREATIONAL VEHICLES, NAMELY TRAVEL TRAILERS AND FIFTH WHEELS (U.S. CLS. 19, 21, 23, 31, 35 AND 44).
FIRST USE 7-0-2001; IN COMMERCE 7-0-2001.
INGA ERVIN, EXAMINING ATTORNEY

SN 78-720,242. BANDAG, INCORPORATED, MUSCATINE, IA. FILED 9-26-2005.

BDV

THE MARK CONSISTS OF STANDARD CHARACTERS WITHOUT CLAIM TO ANY PARTICULAR FONT, STYLE, SIZE, OR COLOR.

FOR TREAD USED TO RETREAD TIRES AND RETREADED TIRES (U.S. CLS. 19, 21, 23, 31, 35 AND 44).
FIRST USE 5-1-2005; IN COMMERCE 5-1-2005.
MARGERY A. TIERNEY, EXAMINING ATTORNEY

CLASS 12—(Continued).

SN 78-722,027. SNOW, JEREMY R., POWELL, OH. FILED 9-28-2005.

EVANTE

THE MARK CONSISTS OF STANDARD CHARACTERS WITHOUT CLAIM TO ANY PARTICULAR FONT, STYLE, SIZE, OR COLOR.

FOR MOTOR LAND VEHICLES IN THE NATURE OF ELECTRIC MOTORIZED AUTOMOBILES AND ELECTRIC MOTORIZED TWO WHEELED CYCLES, AND STRUCTURAL PARTS THEREFOR. (U.S. CLS. 19, 21, 23, 31, 35 AND 44).

CURTIS FRENCH, EXAMINING ATTORNEY

CLASS 12—(Continued).

SN 78-771,140. BANDAG, INCORPORATED, MUSCATINE, IA. FILED 12-12-2005.

BDL

THE MARK CONSISTS OF STANDARD CHARACTERS WITHOUT CLAIM TO ANY PARTICULAR FONT, STYLE, SIZE, OR COLOR.

FOR TREAD USED TO RETREAD TIRES; RETREADED TIRES (U.S. CLS. 19, 21, 23, 31, 35 AND 44).

MARGERY A. TIERNEY, EXAMINING ATTORNEY

SN 78-745,596. GENMAR INDUSTRIES, INC., MINNEAPOLIS, MN. FILED 11-2-2005.

GLASTRON CARLSON

THE MARK CONSISTS OF STANDARD CHARACTERS WITHOUT CLAIM TO ANY PARTICULAR FONT, STYLE, SIZE, OR COLOR.

OWNER OF U.S. REG. NOS. 656,024 AND 1,109,303. FOR BOATS AND STRUCTURAL PARTS THEREFOR (U.S. CLS. 19, 21, 23, 31, 35 AND 44).

JOHN GARTNER, EXAMINING ATTORNEY

SN 78-771,174. BANDAG, INCORPORATED, MUSCATINE, IA. FILED 12-12-2005.

BRL

THE MARK CONSISTS OF STANDARD CHARACTERS WITHOUT CLAIM TO ANY PARTICULAR FONT, STYLE, SIZE, OR COLOR.

FOR TREAD USED TO RETREAD TIRES; RETREADED TIRES (U.S. CLS. 19, 21, 23, 31, 35 AND 44).

MARGERY A. TIERNEY, EXAMINING ATTORNEY

SN 78-771,094. BANDAG, INCORPORATED, MUSCATINE, IA. FILED 12-12-2005.

BDR

THE MARK CONSISTS OF STANDARD CHARACTERS WITHOUT CLAIM TO ANY PARTICULAR FONT, STYLE, SIZE, OR COLOR.

FOR TREAD USED TO RETREAD TIRES; RETREADED TIRES (U.S. CLS. 19, 21, 23, 31, 35 AND 44).

MARGERY A. TIERNEY, EXAMINING ATTORNEY

SN 78-771,398. BANDAG, INCORPORATED, MUSCATINE, IA. FILED 12-12-2005.

BTL

THE MARK CONSISTS OF STANDARD CHARACTERS WITHOUT CLAIM TO ANY PARTICULAR FONT, STYLE, SIZE, OR COLOR.

FOR TREAD USED TO RETREAD TIRES; RETREADED TIRES (U.S. CLS. 19, 21, 23, 31, 35 AND 44).

MARGERY A. TIERNEY, EXAMINING ATTORNEY

CLASS 12—(Continued).

SN 78-771,406. BANDAG, INCORPORATED, MUSCATINE, IA. FILED 12-12-2005.

BRR

THE MARK CONSISTS OF STANDARD CHARACTERS WITHOUT CLAIM TO ANY PARTICULAR FONT, STYLE, SIZE, OR COLOR.

FOR TREAD USED TO RETREAD TIRES; RETREADED TIRES (U.S. CLS. 19, 21, 23, 31, 35 AND 44).
MARGERY A. TIERNEY, EXAMINING ATTORNEY

CLASS 12—(Continued).

SN 78-811,824. NMC-WOLLARD, INC., EAU CLAIRE, WI. FILED 2-10-2006.

SUPER BEE

THE MARK CONSISTS OF STANDARD CHARACTERS WITHOUT CLAIM TO ANY PARTICULAR FONT, STYLE, SIZE, OR COLOR.

FOR ARTICULATED LIFT TRUCKS (U.S. CLS. 19, 21, 23, 31, 35 AND 44).
FIRST USE 1-0-1998; IN COMMERCE 1-0-1998.
DOMINIC J. FERRAIUOLO, EXAMINING ATTORNEY

SN 78-780,475. PRIDE MOBILITY PRODUCTS CORPORATION, EXETER, PA. FILED 12-23-2005.

GO GO TRAVEL PRO

THE MARK CONSISTS OF STANDARD CHARACTERS WITHOUT CLAIM TO ANY PARTICULAR FONT, STYLE, SIZE, OR COLOR.

OWNER OF U.S. REG. NOS. 2,744,441 AND 3,088,459.
NO CLAIM IS MADE TO THE EXCLUSIVE RIGHT TO USE TRAVEL PRO, APART FROM THE MARK AS SHOWN.
FOR ELECTRICALLY POWERED PORTABLE FOLDABLE PERSONAL MOBILITY VEHICLES FOR USE BY PERSONS IN NEED OF PHYSICAL ASSISTANCE TO ACCOMPLISH INDOOR AND OUTDOOR AMBULATORY TASKS (U.S. CLS. 19, 21, 23, 31, 35 AND 44).
AMY BROZENIC, EXAMINING ATTORNEY

SN 78-801,371. THE GATES CORPORATION, DENVER, CO. FILED 1-27-2006.

THE DRIVING FORCE

THE MARK CONSISTS OF STANDARD CHARACTERS WITHOUT CLAIM TO ANY PARTICULAR FONT, STYLE, SIZE, OR COLOR.

OWNER OF U.S. REG. NO. 2,624,912.
FOR TRANSMISSION BELTS AS PARTS FOR LAND VEHICLE ENGINES AND TRANSMISSIONS (U.S. CLS. 19, 21, 23, 31, 35 AND 44).
TIMOTHY FINNEGAN, EXAMINING ATTORNEY

SN 78-815,034. NMC-WOLLARD, INC., EAU CLAIRE, WI. FILED 2-15-2006.

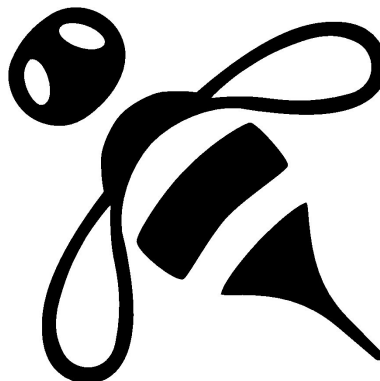

FOR ARTICULATED LIFT TRUCKS (U.S. CLS. 19, 21, 23, 31, 35 AND 44).
FIRST USE 1-0-1998; IN COMMERCE 1-0-1988.
DOMINIC J. FERRAIUOLO, EXAMINING ATTORNEY

SN 78-817,228. R-VISION, INC., ELKHART, IN. FILED 2-17-2006.

FREEDOM TRAIL

THE MARK CONSISTS OF STANDARD CHARACTERS WITHOUT CLAIM TO ANY PARTICULAR FONT, STYLE, SIZE, OR COLOR.

FOR RECREATIONAL VEHICLES, NAMELY, FIFTH WHEELS, MOTOR HOMES AND TRAVEL TRAILERS (U.S. CLS. 19, 21, 23, 31, 35 AND 44).
RICHARD WHITE, EXAMINING ATTORNEY

CLASS 12—(Continued).

SN 78-822,020. SPRAY CONTROL SYSTEMS, INC., BLOOMING PRAIRIE, MN. FILED 2-23-2006.

MINIMIZER

THE MARK CONSISTS OF STANDARD CHARACTERS WITHOUT CLAIM TO ANY PARTICULAR FONT, STYLE, SIZE, OR COLOR.

FOR TRUCK AND TRAILER COMPONENTS AND TRUCK AND TRAILER ACCESSORIES, NAMELY, FENDERS AND FENDER ATTACHMENT BRACKETS, MUD FLAPS, FITTED TOOLBOXES AND TOOLBOX ATTACHMENT BRACKETS FOR VEHICLES (U.S. CLS. 19, 21, 23, 31, 35 AND 44).

FIRST USE 6-0-1984; IN COMMERCE 10-0-1984.
GENE MACIOL, EXAMINING ATTORNEY

SN 78-830,993. PRINCE LIONHEART, INC., SANTA MARIA, CA. FILED 3-7-2006.

2 STAGE

THE MARK CONSISTS OF STANDARD CHARACTERS WITHOUT CLAIM TO ANY PARTICULAR FONT, STYLE, SIZE, OR COLOR.

FOR FITTED PROTECTIVE RUBBER SHEETS FOR AUTOMOBILE SEATS (U.S. CLS. 19, 21, 23, 31, 35 AND 44).

FIRST USE 1-1-2003; IN COMMERCE 1-1-2003.
TARAH HARDY, EXAMINING ATTORNEY

SN 78-833,508. WHITE KNUCKLE, INC., MONROE, WA. FILED 3-9-2006.

WHITE KNUCKLE

THE MARK CONSISTS OF STANDARD CHARACTERS WITHOUT CLAIM TO ANY PARTICULAR FONT, STYLE, SIZE, OR COLOR.

FOR PARTS OF MOTORCYCLES, NAMELY, HANDLE BAR GRIPS (U.S. CLS. 19, 21, 23, 31, 35 AND 44).

FIRST USE 4-1-1995; IN COMMERCE 4-1-1995.
GIANCARLO CASTRO, EXAMINING ATTORNEY

CLASS 12—(Continued).

SN 78-836,640. HO YI LOCK CO., LTD., JHUCI TOWNSHIP, TAIWAN, FILED 3-14-2006.

ARMOUR WARRIOR

THE MARK CONSISTS OF STANDARD CHARACTERS WITHOUT CLAIM TO ANY PARTICULAR FONT, STYLE, SIZE, OR COLOR.

FOR ANTI-THEFT LOCKS FOR USE ON AUTOMOBILE STEERING WHEELS; AND ANTI-THEFT LOCKS FOR USE ON MOTORCYCLES (U.S. CLS. 19, 21, 23, 31, 35 AND 44).

KIMBERLY FRYE, EXAMINING ATTORNEY

SN 78-837,586. THE GATES CORPORATION, DENVER, CO. FILED 3-15-2006.



NO CLAIM IS MADE TO THE EXCLUSIVE RIGHT TO USE "OE MATCH", APART FROM THE MARK AS SHOWN. THE COLOR(S) YELLOW AND SILVER IS/ARE CLAIMED AS A FEATURE OF THE MARK.

THE MARK CONSISTS OF YELLOW LETTERS "OE", THE WORD "MATCH" COLORED SILVER, ALL ENCIRCLED BY A PARTIAL OVAL COLORED SILVER. A SMALL SILVER STAR DISPOSED TO THE LEFT OF THE LETTERS "OE".

FOR POWER TRANSMISSION BELTS FOR USE IN LAND VEHICLES (U.S. CLS. 19, 21, 23, 31, 35 AND 44).
TIMOTHY FINNEGAN, EXAMINING ATTORNEY

SN 78-853,506. ORBEA, SDAD COOP., MALLABIA, SPAIN, FILED 4-4-2006.

ORBEA ALMA

THE MARK CONSISTS OF STANDARD CHARACTERS WITHOUT CLAIM TO ANY PARTICULAR FONT, STYLE, SIZE, OR COLOR.

OWNER OF U.S. REG. NOS. 2,576,631 AND 2,958,550. THE ENGLISH TRANSLATION OF THE WORDING "ALMA" IS "SOUL."

FOR BICYCLE FRAMES (U.S. CLS. 19, 21, 23, 31, 35 AND 44).
MELISSA VALLILLO, EXAMINING ATTORNEY

CLASS 12—(Continued).

SN 78-854,223. MACNEIL BIKES, INC, BURNABY, CANADA, FILED 4-5-2006.

CENECA

THE MARK CONSISTS OF STANDARD CHARACTERS WITHOUT CLAIM TO ANY PARTICULAR FONT, STYLE, SIZE, OR COLOR.

FOR BICYCLE PARTS, NAMELY, SADDLES AND SEAT POSTS (U.S. CLS. 19, 21, 23, 31, 35 AND 44).
ELIZABETH J. WINTER, EXAMINING ATTORNEY

SN 78-855,071. DAVIS, GARY C., SHERMAN OAKS, CA. FILED 4-5-2006.



NO CLAIM IS MADE TO THE EXCLUSIVE RIGHT TO USE RACING FRAMES, APART FROM THE MARK AS SHOWN.

THE MARK CONSISTS OF A DIAMOND SHAPED BORDER WITHIN WHICH APPEARS THE WORDS – TRACK MASTER RACING FRAMES AS FOLLOWS – THE WORD – TRACK ON THE LEFT SIDE; THE WORD – MASTER ON THE RIGHT SIDE; THE WORDS – RACING FRAMES IN THE CENTER.

FOR BICYCLE FRAMES; BICYCLE KICKSTANDS; BICYCLE PARTS, NAMELY, HANDLE BAR STEMS; BICYCLE PARTS, NAMELY, TUBES AND CONNECTORS FOR BICYCLE FRAMES; BICYCLE SEAT POSTS; FRAMES FOR BICYCLES; LAND VEHICLES AND STRUCTURAL PARTS THEREFOR; MOTORCYCLE KICKSTANDS; MOTORCYCLES AND STRUCTURAL PARTS THEREFOR; PARTS OF MOTORCYCLES, NAMELY, HANDLE BARS; RACING BICYCLES; ROAD RACING BICYCLES; TRICYCLES (U.S. CLS. 19, 21, 23, 31, 35 AND 44).

FIRST USE 2-12-1965; IN COMMERCE 2-12-1965.
PAULA MAHONEY, EXAMINING ATTORNEY

CLASS 12—(Continued).

SN 78-855,879. QUALITY S MANUFACTURING, INC., PHOENIX, AZ. FILED 4-6-2006.

SOLAR SHADOWS

THE MARK CONSISTS OF STANDARD CHARACTERS WITHOUT CLAIM TO ANY PARTICULAR FONT, STYLE, SIZE, OR COLOR.

NO CLAIM IS MADE TO THE EXCLUSIVE RIGHT TO USE "SOLAR", APART FROM THE MARK AS SHOWN.

FOR AUTOMOTIVE WINDOW SHADE SCREENS (U.S. CLS. 19, 21, 23, 31, 35 AND 44).

FIRST USE 3-10-2006; IN COMMERCE 3-10-2006.
ZACHARY BELLO, EXAMINING ATTORNEY

SN 78-855,979. AURORA FLIGHT SCIENCES CORPORATION, MANASSAS, VA. FILED 4-6-2006.

MARSFLYER

THE MARK CONSISTS OF STANDARD CHARACTERS WITHOUT CLAIM TO ANY PARTICULAR FONT, STYLE, SIZE, OR COLOR.

FOR UNMANNED RESEARCH AIRCRAFT (U.S. CLS. 19, 21, 23, 31, 35 AND 44).

FIRST USE 9-20-2002; IN COMMERCE 9-20-2002.
LA TONIA FISHER, EXAMINING ATTORNEY

SN 78-859,123. INTERTREND LTD, CAUSEWAY BAY, HONG KONG, FILED 4-11-2006.

SILVER FOX

THE MARK CONSISTS OF STANDARD CHARACTERS WITHOUT CLAIM TO ANY PARTICULAR FONT, STYLE, SIZE, OR COLOR.

OWNER OF U.S. REG. NO. 2,167,795.

FOR BICYCLE BELLS; BICYCLE FRAMES; BICYCLE HANDLEBAR GRIPS; BICYCLE HORNS; BICYCLE PUMPS; BICYCLE SADDLE COVERS; BICYCLE SADDLES; BICYCLE WATER BOTTLE CAGES; BICYCLE WHEELS; BICYCLES; FRAMES FOR BICYCLES; HANDLEBARS; MOUNTAIN BICYCLES; RACING BICYCLES; RIMS FOR BICYCLE WHEELS; ROAD RACING BICYCLES; TOURING BICYCLES; WATER BOTTLE HOLDERS FOR BICYCLES (U.S. CLS. 19, 23, 31, 35 AND 44).

JANICE KIM, EXAMINING ATTORNEY

CLASS 12—(Continued).

SN 78-859,139. STU SEGALL, SAN DIEGO, CA. FILED 4-11-2006.

GETFO

THE MARK CONSISTS OF STANDARD CHARACTERS WITHOUT CLAIM TO ANY PARTICULAR FONT, STYLE, SIZE, OR COLOR.

FOR LAND VEHICLE PARTS AND ACCESSORIES FOR ATTACHMENT TO LAND VEHICLES, NAMELY SYSTEMS FOR FACILITATING MOUNTING AND DISMOUNTING FROM A VEHICLE, COMPRISED OF STEPS AND SUPPORT POLES (U.S. CLS. 19, 21, 23, 31, 35 AND 44).

FIRST USE 3-17-2006; IN COMMERCE 3-17-2006.
THEODORE MCBRIDE, EXAMINING ATTORNEY

SN 78-859,276. SWEETPEA BICYCLES, LLC, PORTLAND, OR. FILED 4-11-2006.

Sweetpea

THE MARK CONSISTS OF STANDARD CHARACTERS WITHOUT CLAIM TO ANY PARTICULAR FONT, STYLE, SIZE, OR COLOR.

FOR BICYCLE FRAMES AND FORKS (U.S. CLS. 19, 21, 23, 31, 35 AND 44).

FIRST USE 5-1-2005; IN COMMERCE 3-1-2006.
TINA BROWN, EXAMINING ATTORNEY

SN 78-859,451. DROPIK, JESSE, WALWORTH, WI. AND SANDERS, KEVIN, WALWORTH, WI. FILED 4-11-2006.

HOVER DECK

THE MARK CONSISTS OF STANDARD CHARACTERS WITHOUT CLAIM TO ANY PARTICULAR FONT, STYLE, SIZE, OR COLOR.

NO CLAIM IS MADE TO THE EXCLUSIVE RIGHT TO USE HOVER, APART FROM THE MARK AS SHOWN.

FOR HOVERCRAFT (U.S. CLS. 19, 21, 23, 31, 35 AND 44).

FRED CARL, EXAMINING ATTORNEY

CLASS 12—(Continued).

SN 78-859,963. SAMSON SPORTS LLC, CAMAS, WA. FILED 4-12-2006.

SAMSON

THE MARK CONSISTS OF STANDARD CHARACTERS WITHOUT CLAIM TO ANY PARTICULAR FONT, STYLE, SIZE, OR COLOR.

FOR BOAT PARTS, NAMELY, WAKEBOARD BOAT TOWERS, WAKEBOARD RACKS, BIMINI TOPS, ROD HOLDERS, RADAR ARCHES, FISHING BOAT TOWERS, AND REARVIEW MIRRORS (U.S. CLS. 19, 21, 23, 31, 35 AND 44).

FIRST USE 11-27-2001; IN COMMERCE 11-27-2001.
LINDA M. KING, EXAMINING ATTORNEY

SN 78-860,076. OLD TOWN CANOE COMPANY, FERNDALE, WA. FILED 4-12-2006.



THE MARK CONSISTS OF PERSON IN A CANOE OR KAYAK HOLDING A PADDLE OVERHEAD IN A LINE OF WATER.

FOR HUMAN PROPELLED AND SMALL NON-MOTORIZED WATERCRAFT, NAMELY, KAYAKS AND CANOES; ACCESSORIES AND PARTS FOR KAYAKS AND CANOES, NAMELY, KAYAK AND CANOE PADDLES, KAYAK KNEE BRACES TO BE STRAPPED WITHIN KAYAK AND CANOE COCKPITS TO FACILITATE CONTROL OF KAYAKS AND CANOES, STRAPS FOR KAYAK KNEE BRACES, CARRYING BAGS FOR KAYAKS, BACKRESTS TO BE MOUNTED WITHIN KAYAKS AND CANOE COCKPITS, PADDLE LEASHES FOR ATTACHING KAYAK AND CANOE PADDLES TO KAYAKS AND CANOES; KAYAK SKATES ON WHICH KAYAKS AND CANOES ARE MOUNTED FOR TRANSPORTATION ON LAND (U.S. CLS. 19, 21, 23, 31, 35 AND 44).

FIRST USE 8-29-2003; IN COMMERCE 8-29-2003.
ELISSA GARBER KON, EXAMINING ATTORNEY

CLASS 12—(Continued).

SN 78-860,189. THE WORKMAN GROUP, PRINEVILLE, OR. FILED 4-12-2006.



NO CLAIM IS MADE TO THE EXCLUSIVE RIGHT TO USE "MOTORS A FAMILY BUSINESS", APART FROM THE MARK AS SHOWN.

THE MARK CONSISTS OF THREE PEOPLE STANDING, ALL THREE WITH HATS ON. THE TWO ON THE ENDS ARE HOLDING SMOKING GUNS. THE WORDS - MAFIA MOTORS A FAMILY BUSINESS - ARE BELOW THE PEOPLE.

FOR HUBS FOR VEHICLE WHEELS FOR MOTORCYCLES; MOTORCYCLE ENGINES; MOTORCYCLE KICKSTANDS; MOTORCYCLE SADDLEBAGS; MOTORCYCLE SIDECARS; MOTORCYCLES; MOTORCYCLES AND STRUCTURAL PARTS THEREFOR; MOTORCYCLES FOR MOTOCROSS; PARTS OF MOTORCYCLES, NAMELY, BRAKE CABLES; PARTS OF MOTORCYCLES, NAMELY, BRAKE CALIPERS; PARTS OF MOTORCYCLES, NAMELY, BRAKE PEDALS; PARTS OF MOTORCYCLES, NAMELY, BRAKE ROTORS; PARTS OF MOTORCYCLES, NAMELY, CLUTCH CABLES; PARTS OF MOTORCYCLES, NAMELY, FORK BEARINGS AND RACES; PARTS OF MOTORCYCLES, NAMELY, FORK DUST BOOTS; PARTS OF MOTORCYCLES, NAMELY, FORK SEALS; PARTS OF MOTORCYCLES, NAMELY, FRONT DASH PANELS; PARTS OF MOTORCYCLES, NAMELY, FRONT SPACERS; PARTS OF MOTORCYCLES, NAMELY, HANDLE BAR CONTROL LEVERS; PARTS OF MOTORCYCLES, NAMELY, HANDLE BAR DAMPERS; PARTS OF MOTORCYCLES, NAMELY, HANDLE BAR GRIPS; PARTS OF MOTORCYCLES, NAMELY, HANDLE BARS; PARTS OF MOTORCYCLES, NAMELY, HEADLIGHT MOUNTS; PARTS OF MOTORCYCLES, NAMELY, SHIFT LEVERS; PNEUMATIC TYRES AND INNER TUBES FOR MOTORCYCLES; STRUCTURAL PARTS FOR MOTORCYCLES (U.S. CLS. 19, 21, 23, 31, 35 AND 44).

LYDIA BELZER, EXAMINING ATTORNEY

SN 78-861,103. GPX INTERNATIONAL TIRE CORPORATION, MALDEN, MA. FILED 4-13-2006.

GRYPHON

THE MARK CONSISTS OF STANDARD CHARACTERS WITHOUT CLAIM TO ANY PARTICULAR FONT, STYLE, SIZE, OR COLOR.

FOR TIRES, PASSENGER CAR TIRES, LIGHT TRUCK TIRES, TRACTOR TIRES, FARM IMPLEMENT TIRES, FORESTRY TIRES, AGRICULTURAL TIRES, TRUCK TIRES, INDUSTRIAL TIRES, OTR TIRES, ATV TIRES, LAWN AND GARDEN TIRES, CONTRACT UTILITY TIRES, TIRES FOR MILITARY VEHICLES, TIRES FOR MATERIAL HANDLING VEHICLES, TRACKS FOR VEHICLES MADE OF RUBBER, RUBBER PRESS ON SOLID TIRES, PNEUMATIC SHAPED SOLID TIRES AND POLYURETHANE TIRES (U.S. CLS. 19, 21, 23, 31, 35 AND 44).

CYNTHIA SLOAN, EXAMINING ATTORNEY

CLASS 12—(Continued).

SN 78-861,310. NEWELL COACH CORPORATION, MIAMI, OK. FILED 4-13-2006.

NEWELL

THE MARK CONSISTS OF STANDARD CHARACTERS WITHOUT CLAIM TO ANY PARTICULAR FONT, STYLE, SIZE, OR COLOR.

OWNER OF U.S. REG. NO. 855,020.
FOR MOTOR HOMES (U.S. CLS. 19, 21, 23, 31, 35 AND 44).

FIRST USE 0-0-1990; IN COMMERCE 0-0-1990.
LINDA ESTRADA, EXAMINING ATTORNEY

SN 78-861,348. COPLAND, AL, C., METAIRIE, LA. FILED 4-13-2006.

CRAFTED FOR MAXIMUM SPEED

THE MARK CONSISTS OF STANDARD CHARACTERS WITHOUT CLAIM TO ANY PARTICULAR FONT, STYLE, SIZE, OR COLOR.

NO CLAIM IS MADE TO THE EXCLUSIVE RIGHT TO USE "CRAFTED" AND "SPEED", APART FROM THE MARK AS SHOWN.

FOR BOATS (U.S. CLS. 19, 21, 23, 31, 35 AND 44).
H. M. FISHER, EXAMINING ATTORNEY

SN 78-861,961. MORENO, VICTOR, ANAHEIM, CA. FILED 4-14-2006.



THE MARK CONSISTS OF THE LETTERS "IID" SUPERIMPOSED UPON A SHIELD.

FOR CAPS FOR WHEEL RIMS; WHEEL RIMS; WHEEL RIMS; WHEELS (U.S. CLS. 19, 21, 23, 31, 35 AND 44).
FIRST USE 2-6-2006; IN COMMERCE 2-6-2006.
SEAN CROWLEY, EXAMINING ATTORNEY

CLASS 12—(Continued).

SN 78-862,712. JERVIS B.WEBB COMPANY, FARMINGTON HILLS, MI. FILED 4-17-2006.

MENTOR

THE MARK CONSISTS OF STANDARD CHARACTERS WITHOUT CLAIM TO ANY PARTICULAR FONT, STYLE, SIZE, OR COLOR.

FOR AUTOMATIC GUIDED VEHICLES (U.S. CLS. 19, 21, 23, 31, 35 AND 44).

FIRST USE 3-31-1990; IN COMMERCE 3-31-1990.
LAURIE KAUFMAN, EXAMINING ATTORNEY

CLASS 12—(Continued).

SN 78-863,818. MONACO COACH CORPORATION, COBURG, OR. FILED 4-18-2006.

DAMARA

THE MARK CONSISTS OF STANDARD CHARACTERS WITHOUT CLAIM TO ANY PARTICULAR FONT, STYLE, SIZE, OR COLOR.

FOR RECREATIONAL VEHICLES, NAMELY MOTOR-HOMES (U.S. CLS. 19, 21, 23, 31, 35 AND 44).

DARRYL SPRUILL, EXAMINING ATTORNEY

SN 78-862,726. JERVIS B. WEBB COMPANY, FARMINGTON HILLS, MI. FILED 4-17-2006.

MENTOR AGVS

THE MARK CONSISTS OF STANDARD CHARACTERS WITHOUT CLAIM TO ANY PARTICULAR FONT, STYLE, SIZE, OR COLOR.

NO CLAIM IS MADE TO THE EXCLUSIVE RIGHT TO USE "AGVS", APART FROM THE MARK AS SHOWN.

FOR AUTOMATIC GUIDED VEHICLES (U.S. CLS. 19, 21, 23, 31, 35 AND 44).

FIRST USE 5-31-1993; IN COMMERCE 5-31-1993.
LAURIE KAUFMAN, EXAMINING ATTORNEY

SN 78-864,135. GRUPO GATUN, INC., DBA TIRE AND WHEEL CHOICES, MIAMI, FL. FILED 4-18-2006.



FOR WHEELS FOR PASSENGER CARS AND TRUCKS (U.S. CLS. 19, 21, 23, 31, 35 AND 44).

FIRST USE 5-1-2006; IN COMMERCE 5-1-2006.
INGRID C. EULIN, EXAMINING ATTORNEY

SN 78-863,071. CC MARINE BRAND ACQUISITION, LLC, SARASOTA, FL. FILED 4-17-2006.

CORSAIR

THE MARK CONSISTS OF STANDARD CHARACTERS WITHOUT CLAIM TO ANY PARTICULAR FONT, STYLE, SIZE, OR COLOR.

FOR BOATS (U.S. CLS. 19, 21, 23, 31, 35 AND 44).

FIRST USE 7-20-2002; IN COMMERCE 7-20-2002.
JOHN WILKE, EXAMINING ATTORNEY

SN 78-864,587. FLORIDA MANUFACTURING GROUP, INC., ODESSA, FL. FILED 4-19-2006.

OX4ROXX

THE MARK CONSISTS OF STANDARD CHARACTERS WITHOUT CLAIM TO ANY PARTICULAR FONT, STYLE, SIZE, OR COLOR.

FOR AUTOMOTIVE PARTS FOR USE IN OFF ROAD VEHICLES, NAMELY, DIFFERENTIAL LOCKS (U.S. CLS. 19, 21, 23, 31, 35 AND 44).

KAPIL BHANOT, EXAMINING ATTORNEY

CLASS 12—(Continued).

SN 78-865,208. INTERCO TIRE CORPORATION, RAYNE, LA. FILED 4-19-2006.



THE MARK CONSISTS OF A CIRCLE WITH A CROSS IN BETWEEN SS AND M16.
FOR TIRES (U.S. CLS. 19, 21, 23, 31, 35 AND 44).
CAROLYN CATALDO, EXAMINING ATTORNEY

SN 78-866,049. TRUCK ACCESSORIES GROUP, INC., EL-KHART, IN. FILED 4-20-2006.

PACE EDWARDS

THE MARK CONSISTS OF STANDARD CHARACTERS WITHOUT CLAIM TO ANY PARTICULAR FONT, STYLE, SIZE, OR COLOR.

FOR LAND VEHICLE PARTS, NAMELY, ENCLOSURES TO BE FITTED ON TRUCK BEDS AND FITTED COVERS FOR TRUCK BEDS (U.S. CLS. 19, 21, 23, 31, 35 AND 44).

FIRST USE 0-0-1985; IN COMMERCE 0-0-1985.
KATRINA EDGE, EXAMINING ATTORNEY

SN 78-866,059. TRUCK ACCESSORIES GROUP, INC., EL-KHART, IN. FILED 4-20-2006.



OWNER OF U.S. REG. NO. 2,823,891.
FOR LAND VEHICLE PARTS, NAMELY, ENCLOSURES TO BE FITTED ON TRUCK BEDS AND FITTED COVERS FOR TRUCK BEDS (U.S. CLS. 19, 21, 23, 31, 35 AND 44).

FIRST USE 0-0-2002; IN COMMERCE 0-0-2002.
KATRINA EDGE, EXAMINING ATTORNEY

CLASS 12—(Continued).

SN 78-866,070. TRUCK ACCESSORIES GROUP, INC., EL-KHART, IN. FILED 4-20-2006.

Full Metal Jack Rabbit

THE MARK CONSISTS OF STANDARD CHARACTERS WITHOUT CLAIM TO ANY PARTICULAR FONT, STYLE, SIZE, OR COLOR.

OWNER OF U.S. REG. NO. 2,823,891.
FOR LAND VEHICLE PARTS, NAMELY, ENCLOSURES TO BE FITTED ON TRUCK BEDS AND FITTED COVERS FOR TRUCK BEDS (U.S. CLS. 19, 21, 23, 31, 35 AND 44).

FIRST USE 11-0-2005; IN COMMERCE 11-0-2005.
KATRINA EDGE, EXAMINING ATTORNEY

SN 78-866,885. GLOBAL ENGINE MANUFACTURING ALLIANCE LLC, AUBURN HILLS, MI. FILED 4-21-2006.

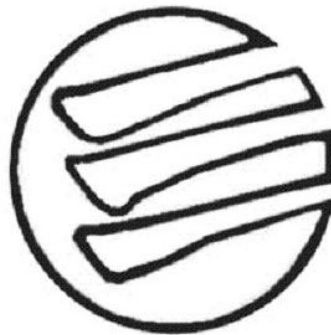

THE MARK CONSISTS OF AN ARBITRARY DESIGN. FOR MOTOR VEHICLE ENGINES; STRUCTURAL PARTS OF MOTOR VEHICLE ENGINES (U.S. CLS. 19, 21, 23, 31, 35 AND 44).

FIRST USE 3-1-2006; IN COMMERCE 3-1-2006.
KIMBERLY FRYE, EXAMINING ATTORNEY

SN 78-867,093. AMERICAN DURABILT, L.L.C., CALIFON, NJ. FILED 4-21-2006.

DURABILT-A-BUMPER

THE MARK CONSISTS OF STANDARD CHARACTERS WITHOUT CLAIM TO ANY PARTICULAR FONT, STYLE, SIZE, OR COLOR.

OWNER OF U.S. REG. NOS. 2,932,835 AND 2,932,836.
FOR TRUCK BUMPERS AND ACCESSORIES, NAMELY REAR CENTER PANELS, MUD FLAP WEIGHTS, MUD FLAP HOLDERS, TOW HOLE COVERS AND STAINLESS STEEL BUMPER TRIM (U.S. CLS. 19, 21, 23, 31, 35 AND 44).

BARBARA A. LOUGHRAN, EXAMINING ATTORNEY

CLASS 12—(Continued).

SN 78-867,525. TIEN HSIN INDUSTRIES CO., LTD., TAI-CHUNG HSIEN, TAIWAN, FILED 4-23-2006.

K-Wing

THE MARK CONSISTS OF STANDARD CHARACTERS WITHOUT CLAIM TO ANY PARTICULAR FONT, STYLE, SIZE, OR COLOR.

FOR BICYCLES; BICYCLE PARTS, NAMELY, FRONT FORKS, BICYCLE CRANKS, BICYCLE RIMS, SEAT-POSTS, HANDLEBARS, BOTTOM BRACKETS, CHAINRINGS, HEADSET BEARINGS, BICYCLE HUBS, BICYCLE SPOKES, BICYCLE BRAKES, BICYCLE CHAINS, HANDLEBAR STEMS, AND BICYCLE GEARS (U.S. CLS. 19, 21, 23, 31, 35 AND 44).

FIRST USE 4-1-2001; IN COMMERCE 4-1-2005.
HANNO RITTNER, EXAMINING ATTORNEY

SN 78-867,530. TIEN HSIN INDUSTRIES CO., LTD., TAI-CHUNG HSIEN, TAIWAN, FILED 4-23-2006.

Wing Pro

THE MARK CONSISTS OF STANDARD CHARACTERS WITHOUT CLAIM TO ANY PARTICULAR FONT, STYLE, SIZE, OR COLOR.

NO CLAIM IS MADE TO THE EXCLUSIVE RIGHT TO USE "PRO", APART FROM THE MARK AS SHOWN.

FOR BICYCLES; BICYCLE PARTS, NAMELY, FRONT FORKS, BICYCLE CRANKS, BICYCLE RIMS, SEAT-POSTS, HANDLEBARS, BOTTOM BRACKETS, CHAINRINGS, HEADSET BEARINGS, BICYCLE HUBS, BICYCLE SPOKES, BICYCLE BRAKES, BICYCLE CHAINS, HANDLEBAR STEMS, AND BICYCLE GEARS (U.S. CLS. 19, 21, 23, 31, 35 AND 44).

FIRST USE 4-1-2001; IN COMMERCE 4-1-2005.
HANNO RITTNER, EXAMINING ATTORNEY

SN 78-868,447. TIEN HSIN INDUSTRIES CO., LTD., TAI-CHUNG HSIEN, TAIWAN, FILED 4-24-2006.

X-Drive

THE MARK CONSISTS OF STANDARD CHARACTERS WITHOUT CLAIM TO ANY PARTICULAR FONT, STYLE, SIZE, OR COLOR.

FOR BICYCLES; BICYCLE PARTS, NAMELY, FRONT FORKS, BICYCLE CRANKS, BICYCLE RIMS, SEAT-POSTS, HANDLEBARS, BOTTOM BRACKETS, CHAINRINGS, HEADSET BEARINGS, BICYCLE HUBS, BICYCLE SPOKES, BICYCLE BRAKES, BICYCLE CHAINS, HANDLEBAR STEMS, AND BICYCLE GEARS (U.S. CLS. 19, 21, 23, 31, 35 AND 44).

FIRST USE 4-1-2001; IN COMMERCE 4-1-2005.
HANNO RITTNER, EXAMINING ATTORNEY

CLASS 12—(Continued).

SN 78-868,471. TIEN HSIN INDUSTRIES CO., LTD., TAI-CHUNG HSIEN, TAIWAN, FILED 4-24-2006.

DYNA DRIVE

THE MARK CONSISTS OF STANDARD CHARACTERS WITHOUT CLAIM TO ANY PARTICULAR FONT, STYLE, SIZE, OR COLOR.

NO CLAIM IS MADE TO THE EXCLUSIVE RIGHT TO USE "DRIVE", APART FROM THE MARK AS SHOWN.

FOR BICYCLES; BICYCLE PARTS, NAMELY, FRONT FORKS, BICYCLE CRANKS, BICYCLE RIMS, SEAT-POSTS, HANDLEBARS, BOTTOM BRACKETS, CHAINRINGS, HEADSET BEARINGS, BICYCLE HUBS, BICYCLE SPOKES, BICYCLE BRAKES, BICYCLE CHAINS, HANDLEBAR STEMS, AND BICYCLE GEARS (U.S. CLS. 19, 21, 23, 31, 35 AND 44).

FIRST USE 4-1-2001; IN COMMERCE 4-1-2005.
HANNO RITTNER, EXAMINING ATTORNEY

SN 78-868,484. TIEN HSIN INDUSTRIES CO., LTD., TAI-CHUNG HSIEN, TAIWAN, FILED 4-24-2006.

VERO

THE MARK CONSISTS OF STANDARD CHARACTERS WITHOUT CLAIM TO ANY PARTICULAR FONT, STYLE, SIZE, OR COLOR.

THE ENGLISH TRANSLATION OF THE WORD VERO IN THE MARK IS "TRUE".

FOR BICYCLES; BICYCLE PARTS, NAMELY, FRONT FORKS, BICYCLE CRANKS, BICYCLE RIMS, SEAT-POSTS, HANDLEBARS, BOTTOM BRACKETS, CHAINRINGS, HEADSET BEARINGS, BICYCLE HUBS, BICYCLE SPOKES, BICYCLE BRAKES, BICYCLE CHAINS, HANDLEBAR STEMS, AND BICYCLE GEARS (U.S. CLS. 19, 21, 23, 31, 35 AND 44).

FIRST USE 4-1-2001; IN COMMERCE 4-1-2005.
HANNO RITTNER, EXAMINING ATTORNEY

CLASS 12—(Continued).

SN 78-869,166. STANISZEWSKI, JOHN T., STATEN ISLAND, NY. FILED 4-25-2006.

VIZOR MATE

THE MARK CONSISTS OF STANDARD CHARACTERS WITHOUT CLAIM TO ANY PARTICULAR FONT, STYLE, SIZE, OR COLOR.

NO CLAIM IS MADE TO THE EXCLUSIVE RIGHT TO USE "VIZOR", APART FROM THE MARK AS SHOWN.

FOR CASE, ADAPTED FOR MOUNTING ON A VISOR OF A VEHICLE, FOR STORING ARTICLES AND DISPLAYING MESSAGES RELEVANT TO THE VEHICLE AND THE OPERATION OF THE VEHICLE (U.S. CLS. 19, 21, 23, 31, 35 AND 44).

FIRST USE 1-24-2006; IN COMMERCE 1-24-2006.
SANDRA MANIOS, EXAMINING ATTORNEY

SN 78-870,449. SOTO, CARLOS, O., MIAMI, FL. FILED 4-26-2006.

CADENZA

THE MARK CONSISTS OF STANDARD CHARACTERS WITHOUT CLAIM TO ANY PARTICULAR FONT, STYLE, SIZE, OR COLOR.

FOR BOATS; BOATS AND STRUCTURAL PARTS THEREFOR; CANOES; DINGHIES; FISHING BOATS; KAYAK EQUIPMENT, NAMELY, PADDLES, PADDLE LEASHES, COCKPIT COVER, SEAT CUSHIONS, CHAIRS, BACK RESTS, SEATS; KAYAK-LIKE BOATS; KAYAKS; OARS; SCULLS; SKIFFS; STRUCTURAL PARTS FOR BOATS (U.S. CLS. 19, 21, 23, 31, 35 AND 44).

FIRST USE 4-20-2006; IN COMMERCE 4-20-2006.
MARY CRAWFORD, EXAMINING ATTORNEY

SN 78-870,555. SOTO, CARLOS, O., MIAMI, FL. FILED 4-26-2006.

THE WAY OF WATER

THE MARK CONSISTS OF STANDARD CHARACTERS WITHOUT CLAIM TO ANY PARTICULAR FONT, STYLE, SIZE, OR COLOR.

FOR BOATS; BOATS AND STRUCTURAL PARTS THEREFOR; CANOES; DINGHIES; FISHING BOATS; KAYAK EQUIPMENT, NAMELY, PADDLES, PADDLE LEASHES, COCKPIT COVER, SEAT CUSHIONS, CHAIRS, BACK RESTS, SEATS; KAYAK-LIKE BOATS; KAYAKS; OARS; SCULLS; SKIFFS; STRUCTURAL PARTS FOR BOATS (U.S. CLS. 19, 21, 23, 31, 35 AND 44).

MARY CRAWFORD, EXAMINING ATTORNEY

CLASS 12—(Continued).

SN 78-870,942. LOCKHEED MARTIN CORPORATION, BETHESDA, MD. FILED 4-27-2006.

LIGHTNING II

THE MARK CONSISTS OF STANDARD CHARACTERS WITHOUT CLAIM TO ANY PARTICULAR FONT, STYLE, SIZE, OR COLOR.

FOR JET AIRCRAFT AND STRUCTURAL PARTS THEREFOR (U.S. CLS. 19, 21, 23, 31, 35 AND 44).

PAULA MAYS, EXAMINING ATTORNEY

SN 78-873,581. TENNECO AUTOMOTIVE OPERATING COMPANY INC., LAKE FOREST, IL. FILED 5-1-2006.

ALTER YOUR EGO

THE MARK CONSISTS OF STANDARD CHARACTERS WITHOUT CLAIM TO ANY PARTICULAR FONT, STYLE, SIZE, OR COLOR.

FOR MOTOR VEHICLE SUSPENSION PARTS, NAMELY, SHOCK ABSORBERS, STEERING STABILIZERS, COIL SPRINGS AND LEAF SPRINGS, AND STRUTS; AUTOMOTIVE PARTS AND ACCESSORIES, NAMELY, GRILL GUARDS, BRUSH GUARDS, BODY GUARDS, LIGHT GUARDS, RUNNING BOARDS AND SIDE STEP BARS, ADJUSTABLE AUTO SWAY BARS, ROLL BARS, LIGHT MOUNTING BARS AND BUMPERS FOR MOTOR VEHICLES (U.S. CLS. 19, 21, 23, 31, 35 AND 44).

TAMARA LEE, EXAMINING ATTORNEY

SN 78-874,237. DAIMLERCHRYSLER CORPORATION, AUBURN HILLS, MI. FILED 5-2-2006.

R/T

THE MARK CONSISTS OF STANDARD CHARACTERS WITHOUT CLAIM TO ANY PARTICULAR FONT, STYLE, SIZE, OR COLOR.

OWNER OF U.S. REG. NOS. 1,590,771, 2,362,584 AND 2,475,380.

FOR LAND VEHICLES (U.S. CLS. 19, 21, 23, 31, 35 AND 44).

FIRST USE 8-0-1966; IN COMMERCE 8-0-1966.
LINDA LAVACHE, EXAMINING ATTORNEY

CLASS 12—(Continued).

SN 78-877,458. DAIMLERCHRYSLER CORPORATION, AUBURN HILLS, MI. FILED 5-5-2006.

NASSAU

THE MARK CONSISTS OF STANDARD CHARACTERS WITHOUT CLAIM TO ANY PARTICULAR FONT, STYLE, SIZE, OR COLOR.

FOR MOTOR VEHICLES, NAMELY CARS, TRUCKS AND SPORT UTILITY VEHICLES (U.S. CLS. 19, 21, 23, 31, 35 AND 44).

LINDA LAVACHE, EXAMINING ATTORNEY

SN 78-885,461. ELECTRIC MOBILITY CORPORATION, SEWELL, NJ. FILED 5-17-2006.



OWNER OF U.S. REG. NOS. 1,692,810 AND 3,090,420. NO CLAIM IS MADE TO THE EXCLUSIVE RIGHT TO USE "COMPANY", APART FROM THE MARK AS SHOWN.

THE COLOR GREY IS NOT A FEATURE OF THE MARK. THE MARK CONSISTS OF THE WORDS "THE RASCAL COMPANY" ARE INSIDE AN OVAL SHAPE WITH PARTS OF THE "R" AND THE TAIL END OF THE "L" ARE OUTSIDE OF THE OVAL.

FOR MOTORIZED SCOOTERS; MOTORIZED, SELF-PROPELLED, WHEELED PERSONAL MOBILITY DEVICE, NAMELY SCOOTER; WHEELCHAIRS (U.S. CLS. 19, 21, 23, 31, 35 AND 44).

FIRST USE 5-1-2006; IN COMMERCE 5-1-2006.

KATHERINE STOIDES, EXAMINING ATTORNEY

SN 78-887,568. FORD MOTOR COMPANY, DEARBORN, MI. FILED 5-19-2006.

GALAXIE

THE MARK CONSISTS OF STANDARD CHARACTERS WITHOUT CLAIM TO ANY PARTICULAR FONT, STYLE, SIZE, OR COLOR.

OWNER OF U.S. REG. NO. 679,918.

THE ENGLISH TRANSLATION OF GALAXIE IS GALAXY.

FOR MOTOR VEHICLES, NAMELY, AUTOMOBILES, TRUCKS, VANS, SPORT-UTILITY VEHICLES, AND THEIR STRUCTURAL PARTS AND ENGINES (U.S. CLS. 19, 21, 23, 31, 35 AND 44).

NANCY CLARKE, EXAMINING ATTORNEY

CLASS 12—(Continued).

SN 78-903,833. DEEGAN, BRIAN, TEMECULA, CA. FILED 6-8-2006.

HEVY HITTERS

THE MARK CONSISTS OF STANDARD CHARACTERS WITHOUT CLAIM TO ANY PARTICULAR FONT, STYLE, SIZE, OR COLOR.

FOR BICYCLES; MOTORCYCLES; MOTORCYCLES FOR MOTOCROSS (U.S. CLS. 19, 21, 23, 31, 35 AND 44).

SHARON MEIER, EXAMINING ATTORNEY

SN 78-907,019. DAIMLERCHRYSLER CORPORATION, AUBURN HILLS, MI. FILED 6-13-2006.

LIBERTY LATITUDE

THE MARK CONSISTS OF STANDARD CHARACTERS WITHOUT CLAIM TO ANY PARTICULAR FONT, STYLE, SIZE, OR COLOR.

OWNER OF U.S. REG. NO. 2,602,905.

FOR AUTOMOBILES (U.S. CLS. 19, 21, 23, 31, 35 AND 44).

LINDA LAVACHE, EXAMINING ATTORNEY

SN 78-907,048. DAIMLERCHRYSLER CORPORATION, AUBURN HILLS, MI. FILED 6-13-2006.

LATITUDE

THE MARK CONSISTS OF STANDARD CHARACTERS WITHOUT CLAIM TO ANY PARTICULAR FONT, STYLE, SIZE, OR COLOR.

FOR AUTOMOBILES (U.S. CLS. 19, 21, 23, 31, 35 AND 44).

LINDA LAVACHE, EXAMINING ATTORNEY

CLASS 12—(Continued).

SN 78-914,054. ORBEA, SDAD COOP., MALLABIA, SPAIN,
FILED 6-22-2006.

ORBEA ORA

THE MARK CONSISTS OF STANDARD CHARACTERS
WITHOUT CLAIM TO ANY PARTICULAR FONT, STYLE,
SIZE, OR COLOR.

OWNER OF U.S. REG. NOS. 2,576,631 AND 2,958,550.
THE ENGLISH TRANSLATION OF THE WORDING
"ORA" IS "TIME" OR "HOUR."
FOR BICYCLE FRAMES; BICYCLES (U.S. CLS. 19, 21,
23, 31, 35 AND 44).
MELISSA VALLILLO, EXAMINING ATTORNEY

SN 78-914,118. ORBEA SDAD, COOP., MALLABIA, SPAIN,
FILED 6-22-2006.

ORBEA ORDU

THE MARK CONSISTS OF STANDARD CHARACTERS
WITHOUT CLAIM TO ANY PARTICULAR FONT, STYLE,
SIZE, OR COLOR.

OWNER OF U.S. REG. NOS. 2,576,631 AND 2,958,550.
THE ENGLISH TRANSLATION OF THE WORDING
"ORDU" IS "TIME" OR "HOUR."
FOR BICYCLE FRAMES; BICYCLES (U.S. CLS. 19, 21,
23, 31, 35 AND 44).
MELISSA VALLILLO, EXAMINING ATTORNEY

SN 79-024,422. YUHUAN DELIZHONG COMPANY, CHINA,
FILED 4-4-2006.

DLZ

OWNER OF INTERNATIONAL REGISTRATION 0886363
DATED 4-4-2006. EXPIRES 4-4-2016.

FOR TORSION BARS FOR VEHICLES; AUTOMOBILE
CHASSIS; AXLE BEARINGS FOR LAND VEHICLES;
MOTORS FOR AUTOMOBILES; DRIVE SHAFT FOR
LAND VEHICLES; FRONT AXLES AND REAR AXLES
FOR MOTOR VEHICLES (U.S. CLS. 19, 21, 23, 31, 35 AND
44).

WENDY GOODMAN, EXAMINING ATTORNEY

CLASS 13—FIREARMS

SN 78-699,371. THOMPSON CENTER ARMS COMPANY
INC., ROCHESTER, NH. FILED 8-24-2005.



"THE COLOR(S) YELLOW AND RED IS/ARE CLAIMED
AS A FEATURE OF THE MARK."

THE MARK CONSISTS OF AN INTERLOCKING 'T' AND
'C', ENCIRCLED BY TAPERED ARCS, ALL IN YELLOW. A
RED DISC IS ENCIRCLED BY THE 'C'.

FOR FIREARMS; GUN BARRELS; GUN STOCKS;
GUN PARTS; AMMUNITION FOR FIREARMS; CASES
FOR FIREARMS; CLEANING IMPLEMENTS FOR FIRE-
ARMS, NAMELY BRUSHES, RODS, PULL-THROUGHS,
CLOSER CUPS, SHELL EXTRACTORS, DECAPPERS
(U.S. CLS. 2 AND 9).

FIRST USE 1-31-1998; IN COMMERCE 1-31-1998.
AMY HELLA, EXAMINING ATTORNEY

SN 78-804,572. THOMPSON CENTER ARMS COMPANY
INC., ROCHESTER, NH. FILED 2-1-2006.

U-VIEW

THE MARK CONSISTS OF STANDARD CHARACTERS
WITHOUT CLAIM TO ANY PARTICULAR FONT, STYLE,
SIZE, OR COLOR.

FOR LOADING TOOLS FOR WEAPONS NAMELY,
GUN POWDER MEASURES (U.S. CLS. 2 AND 9).
FIRST USE 12-31-2001; IN COMMERCE 12-31-2001.
RONALD MCMORROW, EXAMINING ATTORNEY

SN 78-859,283. DO-ALL TRAPS, LLC, NASHVILLE, TN.
FILED 4-11-2006.

**TROPHY BUCK**

FOR GUN AND RIFLE CASES (U.S. CLS. 2 AND 9).
FIRST USE 10-0-2005; IN COMMERCE 10-0-2005.
LINDA MICKLEBURGH, EXAMINING ATTORNEY

CLASS 13—(Continued).

SN 78-859,295. DO-ALL TRAPS, LLC, NASHVILLE, TN.
FILED 4-11-2006.



FOR GUN AND RIFLE CASES (U.S. CLS. 2 AND 9).
FIRST USE 10-0-2005; IN COMMERCE 10-0-2005.
LINDA MICKLEBURGH, EXAMINING ATTORNEY

CLASS 13—(Continued).

SN 78-861,252. SALISH TRUST, COMPRISING MARVIN
WILBUR, SR., JOAN WILBUR, LENORA WILBUR-COOK,
C. MARVIN WILBUR, JR., AND MICHAEL WILBUR, ALL
U.S. CITIZENS, ANACORTES, WA. FILED 4-13-2006.

CURTAIN CALL

THE MARK CONSISTS OF STANDARD CHARACTERS
WITHOUT CLAIM TO ANY PARTICULAR FONT, STYLE,
SIZE, OR COLOR.
FOR FIREWORKS (U.S. CLS. 2 AND 9).
MEGAN WHITNEY, EXAMINING ATTORNEY

SN 78-861,000. SALISH TRUST, COMPRISING MARVIN
WILBUR, SR., JOAN WILBUR, LENORA WILBUR-COOK,
C. MARVIN WILBUR, JR., AND MICHAEL WILBUR, ALL
U.S. CITIZENS, ANACORTES, WA. FILED 4-13-2006.

GAME BREAKER

THE MARK CONSISTS OF STANDARD CHARACTERS
WITHOUT CLAIM TO ANY PARTICULAR FONT, STYLE,
SIZE, OR COLOR.
FOR FIREWORKS (U.S. CLS. 2 AND 9).
MEGAN WHITNEY, EXAMINING ATTORNEY

SN 78-861,294. SALISH TRUST, COMPRISING MARVIN
WILBUR, SR., JOAN WILBUR, LENORA WILBUR-COOK,
C. MARVIN WILBUR, JR., AND MICHAEL WILBUR, ALL
U.S. CITIZENS, ANACORTES, WA. FILED 4-13-2006.

BIG CUL-DE-SAC PACK

THE MARK CONSISTS OF STANDARD CHARACTERS
WITHOUT CLAIM TO ANY PARTICULAR FONT, STYLE,
SIZE, OR COLOR.
NO CLAIM IS MADE TO THE EXCLUSIVE RIGHT TO
USE "PACK", APART FROM THE MARK AS SHOWN.
FOR FIREWORKS (U.S. CLS. 2 AND 9).
MEGAN WHITNEY, EXAMINING ATTORNEY

SN 78-861,223. SALISH TRUST, COMPRISING MARVIN
WILBUR, SR., JOAN WILBUR, LENORA WILBUR-COOK,
C. MARVIN WILBUR, JR., AND MICHAEL WILBUR, ALL
U.S. CITIZENS, ANACORTES, WA. FILED 4-13-2006.

**I GOT YOUR 500 GRAMS RIGHT
HERE!**

THE MARK CONSISTS OF STANDARD CHARACTERS
WITHOUT CLAIM TO ANY PARTICULAR FONT, STYLE,
SIZE, OR COLOR.
FOR FIREWORKS (U.S. CLS. 2 AND 9).
MEGAN WHITNEY, EXAMINING ATTORNEY

SN 78-861,332. SALISH TRUST, COMPRISING MARVIN
WILBUR, SR., JOAN WILBUR, LENORA WILBUR-COOK,
C. MARVIN WILBUR, JR., AND MICHAEL WILBUR, ALL
U.S. CITIZENS, ANACORTES, WA. FILED 4-13-2006.

BIG DRUM FIREWORKS

THE MARK CONSISTS OF STANDARD CHARACTERS
WITHOUT CLAIM TO ANY PARTICULAR FONT, STYLE,
SIZE, OR COLOR.
NO CLAIM IS MADE TO THE EXCLUSIVE RIGHT TO
USE "FIREWORKS", APART FROM THE MARK AS
SHOWN.
FOR FIREWORKS (U.S. CLS. 2 AND 9).
MEGAN WHITNEY, EXAMINING ATTORNEY

CLASS 13—(Continued).

SN 78-861,351. SALISH TRUST, COMPRISING MARVIN WILBUR, SR., JOAN WILBUR, LENORA WILBUR-COOK, C. MARVIN WILBUR, JR., AND MICHAEL WILBUR, ALL U.S. CITIZENS, ANACORTES, WA. FILED 4-13-2006.

PYRO MOTION

THE MARK CONSISTS OF STANDARD CHARACTERS WITHOUT CLAIM TO ANY PARTICULAR FONT, STYLE, SIZE, OR COLOR.

NO CLAIM IS MADE TO THE EXCLUSIVE RIGHT TO USE "PYRO", APART FROM THE MARK AS SHOWN. FOR FIREWORKS (U.S. CLS. 2 AND 9).
MEGAN WHITNEY, EXAMINING ATTORNEY

SN 78-861,365. SALISH TRUST, COMPRISING MARVIN WILBUR, SR., JOAN WILBUR, LENORA WILBUR-COOK, C. MARVIN WILBUR, JR., AND MICHAEL WILBUR, ALL U.S. CITIZENS, ANACORTES, WA. FILED 4-13-2006.

FASTEN YOUR SEATBELTS

THE MARK CONSISTS OF STANDARD CHARACTERS WITHOUT CLAIM TO ANY PARTICULAR FONT, STYLE, SIZE, OR COLOR.

FOR FIREWORKS (U.S. CLS. 2 AND 9).
MEGAN WHITNEY, EXAMINING ATTORNEY

SN 78-863,736. SPS MARKETING, INC., ROHNERT PARK, CA. FILED 4-18-2006.

BRUSH BUDDY

THE MARK CONSISTS OF STANDARD CHARACTERS WITHOUT CLAIM TO ANY PARTICULAR FONT, STYLE, SIZE, OR COLOR.

FOR GUN CLEANING BRUSHES (U.S. CLS. 2 AND 9).
JESSICA A. POWERS, EXAMINING ATTORNEY

CLASS 13—(Continued).

SN 78-864,929. SHELTON, GREGORY P., DBA SHELTON FIREWORKS, EAGLEVILLE, MO. FILED 4-19-2006.

VIXEN

THE MARK CONSISTS OF STANDARD CHARACTERS WITHOUT CLAIM TO ANY PARTICULAR FONT, STYLE, SIZE, OR COLOR.

FOR FIREWORKS (U.S. CLS. 2 AND 9).
FIRST USE 6-12-2001; IN COMMERCE 6-12-2001.
DAHLIA GEORGE, EXAMINING ATTORNEY

SN 78-865,157. SALISH TRUST, ANACORTES, WA. FILED 4-19-2006.

MAJOR HAVOC

THE MARK CONSISTS OF STANDARD CHARACTERS WITHOUT CLAIM TO ANY PARTICULAR FONT, STYLE, SIZE, OR COLOR.

FOR FIREWORKS (U.S. CLS. 2 AND 9).
FIRST USE 3-31-1990; IN COMMERCE 3-31-1990.
MEGAN WHITNEY, EXAMINING ATTORNEY

SN 78-865,862. DETONICS USA, LLC, PENDERGRASS, GA. FILED 4-20-2006.

StreetMaster

THE MARK CONSISTS OF STANDARD CHARACTERS WITHOUT CLAIM TO ANY PARTICULAR FONT, STYLE, SIZE, OR COLOR.

FOR FIREARMS (U.S. CLS. 2 AND 9).
FIRST USE 11-15-2005; IN COMMERCE 11-15-2005.
SARAH WAYDA, EXAMINING ATTORNEY

CLASS 13—(Continued).

SN 78-868,222. NOSLER, INC., BEND, OR. FILED 4-24-2006.

DESIGNED FOR PERFORMANCE,
BUILT FOR ACCURACY.

THE MARK CONSISTS OF STANDARD CHARACTERS
WITHOUT CLAIM TO ANY PARTICULAR FONT, STYLE,
SIZE, OR COLOR.

FOR AMMUNITION AND COMPONENTS THEREOF;
RIFLES; BULLETS (U.S. CLS. 2 AND 9).

FIRST USE 3-31-2006; IN COMMERCE 3-31-2006.

C. DIONNE CLYBURN, EXAMINING ATTORNEY

CLASS 14—(Continued).

SN 76-654,868. JEWELNET CORPORATION, BOCA RATON, FL. FILED 2-10-2006.

Lucern

CLASS 14—JEWELRY

SN 76-479,584. UNION PACIFIC RAILROAD COMPANY, OMAHA, NE. FILED 12-31-2002.



OWNER OF U.S. REG. NOS. 32,036, 2,666,974 AND
OTHERS.

NO CLAIM IS MADE TO THE EXCLUSIVE RIGHT TO
USE OVERLAND ROUTE, APART FROM THE MARK AS
SHOWN.

FOR ORNAMENTAL PINS (U.S. CLS. 2, 27, 28 AND 50).

FIRST USE 0-0-2000; IN COMMERCE 0-0-2000.

BARBARA RUTLAND, EXAMINING ATTORNEY

THE MARK CONSISTS OF STANDARD CHARACTERS
WITHOUT CLAIM TO ANY PARTICULAR FONT, STYLE,
SIZE, OR COLOR.

FOR JEWELRY (U.S. CLS. 2, 27, 28 AND 50).

FIRST USE 5-12-1998; IN COMMERCE 5-12-1998.

RONALD AIKENS, EXAMINING ATTORNEY

SN 78-421,961. MARCHIO (BVI) LIMITED, CAUSEWAY BAY, HONG KONG, FILED 5-20-2004.



L'AMOUR

SN 76-653,993. PHILLIPS INTERNATIONAL INCORPORATED, HALLANDALE, FL. FILED 1-24-2006.

CANDACE LAUREN

THE MARK CONSISTS OF STANDARD CHARACTERS
WITHOUT CLAIM TO ANY PARTICULAR FONT, STYLE,
SIZE, OR COLOR.

THE NAME "CANDACE LAUREN" DOES NOT IDENTIFY
A LIVING INDIVIDUAL.

FOR COSTUME JEWELRY (U.S. CLS. 2, 27, 28 AND
50).

FIRST USE 7-0-1998; IN COMMERCE 7-0-1998.

TRICIA SONNEBORN, EXAMINING ATTORNEY

OWNER OF AUSTRALIA REG. NO. 977084, DATED 11-5-
2003, EXPIRES 11-5-2013.

THE LINING IS A FEATURE OF THE MARK.

THE MARK INCLUDES THE STYLIZED LETTERS "CP".

THE FOREIGN WORDING IN THE MARK TRANSLATES
INTO ENGLISH AS "LOVE".

FOR JEWELRY (U.S. CLS. 2, 27, 28 AND 50).

MATTHEW PAPPAS, EXAMINING ATTORNEY

CLASS 14—(Continued).

SN 78-629,588. ZHEJIANG PROVINCE SHANXIAHU PEARL COMPANY, LIMITED, ZHUJI CITY, ZHEJIANG, CHINA, FILED 5-13-2005.



OWNER OF CHINA REG. NO. 3322230, DATED 4-28-2004, EXPIRES 4-27-2014.

THE LINING IS A FEATURE OF THE MARK.
THE MARK CONSISTS OF A DESIGN EMBLEM FEATURING A GLOBE DESIGN OUTLINED BY A FANCIFUL BORDER.

FOR JEWELRY, NAMELY AMULETS, BRACELETS, SMALL ORNAMENTS OF PRECIOUS METAL, BROOCHES, CHAINS, NECKLACES, PEARLS, IMITATION JEWELRY, RINGS, AND ORNAMENTS OF PRECIOUS METAL (U.S. CLS. 2, 27, 28 AND 50).

FIRST USE 1-1-2001; IN COMMERCE 1-1-2004.
SONYA STEPHENS, EXAMINING ATTORNEY

SN 78-647,800. PRIME GROWTH ASSETS LIMITED, ROAD TOWN, TORTOLA, BR. VIRGIN ISLANDS, FILED 6-10-2005.



MIRANDA GEMS

NO CLAIM IS MADE TO THE EXCLUSIVE RIGHT TO USE "GEMS", APART FROM THE MARK AS SHOWN.

FOR JEWELRY, DIAMONDS, PRECIOUS AND SEMI-PRECIOUS GEMSTONES, PRECIOUS METALS IN GENERAL, ORNAMENTS OF PRECIOUS METALS, CLOCKS AND WATCHES (U.S. CLS. 2, 27, 28 AND 50).

RONALD AIKENS, EXAMINING ATTORNEY

CLASS 14—(Continued).

SN 78-652,256. WALDMAN, MATTHEW, NEW YORK, NY, FILED 6-16-2005.

NOOKA

THE MARK CONSISTS OF STANDARD CHARACTERS WITHOUT CLAIM TO ANY PARTICULAR FONT, STYLE, SIZE, OR COLOR.

OWNER OF U.S. REG. NO. 2,543,198.
FOR WATCHES AND CLOCKS AND PARTS AND FITTINGS THEREFOR (U.S. CLS. 2, 27, 28 AND 50).
JENNIFER WILLISTON, EXAMINING ATTORNEY

SN 78-681,018. STARLINGEAR CORPORATION, BURBANK, CA, FILED 7-28-2005.

STARLINGEAR

THE MARK CONSISTS OF STANDARD CHARACTERS WITHOUT CLAIM TO ANY PARTICULAR FONT, STYLE, SIZE, OR COLOR.

FOR JEWELRY (U.S. CLS. 2, 27, 28 AND 50).
FIRST USE 8-0-2001; IN COMMERCE 8-0-2001.
MARK T. MULLEN, EXAMINING ATTORNEY

SN 78-681,147. STARLINGEAR CORPORATION, BURBANK, CA, FILED 7-28-2005.



THE MARK CONSISTS OF THE WORD STARLINGEAR STYLIZED WITH DESIGN.

FOR JEWELRY (U.S. CLS. 2, 27, 28 AND 50).
FIRST USE 8-0-2001; IN COMMERCE 8-0-2001.
MARK T. MULLEN, EXAMINING ATTORNEY

CLASS 14—(Continued).

SN 78-699,792. TURNER CLASSIC MOVIES LP, LLLP, ATLANTA, GA. FILED 8-24-2005.

TCM

THE MARK CONSISTS OF STANDARD CHARACTERS WITHOUT CLAIM TO ANY PARTICULAR FONT, STYLE, SIZE, OR COLOR.

OWNER OF U.S. REG. NOS. 2,525,046, 2,600,389 AND OTHERS.

FOR CLOCKS, INCLUDING ALARM CLOCKS, WALL CLOCKS AND CLOCKS INCORPORATING RADIOS; WRISTWATCHES; DECORATIVE BOXES OF PRECIOUS METAL; CHARMS; LAPEL PINS AND COSTUME JEWELRY (U.S. CLS. 2, 27, 28 AND 50).

FIRST USE 4-0-1994; IN COMMERCE 4-0-1994.
KATHERINE STOIDES, EXAMINING ATTORNEY

CLASS 14—(Continued).

SN 78-718,364. K.F. LICENSING, INC., MILLBURN, NJ. FILED 9-22-2005.

ROYAL TITANIUM

THE MARK CONSISTS OF STANDARD CHARACTERS WITHOUT CLAIM TO ANY PARTICULAR FONT, STYLE, SIZE, OR COLOR.

NO CLAIM IS MADE TO THE EXCLUSIVE RIGHT TO USE "TITANIUM", APART FROM THE MARK AS SHOWN, FOR JEWELRY COMPOSED IN WHOLE OR IN PART OF TITANIUM (U.S. CLS. 2, 27, 28 AND 50).

MELVIN AXILBUND, EXAMINING ATTORNEY

SN 78-712,615. ENO SPORTS LTD, WANCHAI, HONG KONG, FILED 9-14-2005.

ENO

THE MARK CONSISTS OF STANDARD CHARACTERS WITHOUT CLAIM TO ANY PARTICULAR FONT, STYLE, SIZE, OR COLOR.

THE FOREIGN WORDING IN THE MARK TRANSLATES INTO ENGLISH AS "UNCLE."

FOR JEWELRY, NAMELY, WATCHES, BRACELETS, CHARMS, EARRINGS, NECKLACES, PENDANTS, PINS AND PRECIOUS METAL MONEY CLIPS (U.S. CLS. 2, 27, 28 AND 50).

KEVON CHISOLM, EXAMINING ATTORNEY

SN 78-779,307. COLIBRI CORPORATION, PROVIDENCE, RI. FILED 12-22-2005.

PASSPORT

THE MARK CONSISTS OF STANDARD CHARACTERS WITHOUT CLAIM TO ANY PARTICULAR FONT, STYLE, SIZE, OR COLOR.

FOR BRACELETS; CUFF-LINKS; ITEMS MADE OF PRECIOUS METAL, NAMELY MONEY CLIPS; JEWELRY; JEWELRY, NAMELY, CROSSES; KEY RINGS OF PRECIOUS METAL; RINGS BEING JEWELRY; TIE FASTENERS (U.S. CLS. 2, 27, 28 AND 50).

FIRST USE 1-31-2004; IN COMMERCE 1-31-2004.
ESTHER BELENKER, EXAMINING ATTORNEY

SN 78-713,399. POSADA, LUCIA C., MIAMI BEACH, FL. AND KOENIG, GARY D., MIAMI BEACH, FL. FILED 9-15-2005.



FOR JEWELRY (U.S. CLS. 2, 27, 28 AND 50).
FIRST USE 7-15-2005; IN COMMERCE 7-15-2005.
BARBARA GAYNOR, EXAMINING ATTORNEY

SN 78-790,965. FRANKLIN, CANDIDA, PALMER, EXTON, PA. FILED 1-13-2006.

Spirit Girl

THE MARK CONSISTS OF STANDARD CHARACTERS WITHOUT CLAIM TO ANY PARTICULAR FONT, STYLE, SIZE, OR COLOR.

FOR JEWELRY (U.S. CLS. 2, 27, 28 AND 50).
FIRST USE 1-15-2006; IN COMMERCE 1-15-2006.
DAVID COLLIER, EXAMINING ATTORNEY

CLASS 14—(Continued).

SN 78-796,933. SONES, MICHAEL, ATLANTIC BEACH, FL.
FILED 1-23-2006.

IN GOD WE TRUST

THE MARK CONSISTS OF STANDARD CHARACTERS
WITHOUT CLAIM TO ANY PARTICULAR FONT, STYLE,
SIZE, OR COLOR.

FOR CHARITY BRACELETS (U.S. CLS. 2, 27, 28 AND
50).

JOHN GARTNER, EXAMINING ATTORNEY

CLASS 14—(Continued).

SN 78-816,092. C & A DIAMONDS INTERNATIONAL, LLC,
CANFIELD, OH. FILED 2-16-2006.

FIANA COLLECTION

THE MARK CONSISTS OF STANDARD CHARACTERS
WITHOUT CLAIM TO ANY PARTICULAR FONT, STYLE,
SIZE, OR COLOR.

NO CLAIM IS MADE TO THE EXCLUSIVE RIGHT TO
USE "COLLECTION", APART FROM THE MARK AS
SHOWN.

FOR JEWELRY (U.S. CLS. 2, 27, 28 AND 50).

AMY ALFIERI, EXAMINING ATTORNEY

SN 78-804,506. MOVADO LLC, WILMINGTON, DE. FILED 2-
1-2006.

IMPERIAL

THE MARK CONSISTS OF STANDARD CHARACTERS
WITHOUT CLAIM TO ANY PARTICULAR FONT, STYLE,
SIZE, OR COLOR.

FOR HOROLOGICAL AND CHRONOMETRIC IN-
STRUMENTS (U.S. CLS. 2, 27, 28 AND 50).

BRENDAN REGAN, EXAMINING ATTORNEY

SN 78-816,690. C & K NISSENBAUM INC., NEW YORK, NY.
FILED 2-16-2006.

CHAIM CUT

THE MARK CONSISTS OF STANDARD CHARACTERS
WITHOUT CLAIM TO ANY PARTICULAR FONT, STYLE,
SIZE, OR COLOR.

NO CLAIM IS MADE TO THE EXCLUSIVE RIGHT TO
USE "CUT", APART FROM THE MARK AS SHOWN.

"THE FOREIGN WORDING IN THE MARK TRANS-
LATES INTO ENGLISH AS LIFE."

FOR DIAMOND JEWELRY AND CUT DIAMONDS
(U.S. CLS. 2, 27, 28 AND 50).

DARRYL SPRUILL, EXAMINING ATTORNEY

SN 78-814,908. INTERNATIONAL GOLD, INC., LOS AN-
GELES, CA. FILED 2-14-2006.



THE NAME "CB BERCHET" DOES NOT IDENTIFY A
LIVING INDIVIDUAL.

THE MARK CONSISTS OF STYLIZED LETTERS ALL IN
CAPITALS STARTING WITH REVERSED LETTERS B AND
C, MIRRORED BY THE SAME (LETTERS C AND B IN
FORWARD STANDARD LETTERS), FOLLOWED BY THE
REMAINING LETTERS CONTAINED IN THE WORD
"BERCHET," THOSE BEING "ERCHET" TO FORM THE
LOGO CB BERCHET.

FOR JEWELRY (U.S. CLS. 2, 27, 28 AND 50).

FIRST USE 3-1-2005; IN COMMERCE 3-1-2005.

PETER B. BROMAGHIM, EXAMINING ATTORNEY

SN 78-841,826. ABBY ANNE JEWELRY LLC, JOPLIN, MO.
FILED 3-20-2006.

ABBY ANNE

THE MARK CONSISTS OF STANDARD CHARACTERS
WITHOUT CLAIM TO ANY PARTICULAR FONT, STYLE,
SIZE, OR COLOR.

THE NAME ABBY ANNE IDENTIFIES A PARTICULAR
LIVING INDIVIDUAL WHOSE CONSENT IS OF RECORD.

FOR BEADS FOR USE IN THE MANUFACTURE OF
JEWELRY; BRACELETS; BRACELETS OF PRECIOUS
METAL; CLIP EARRINGS; COSTUME JEWELRY; EARR-
INGS; JEWELRY; JEWELRY CHAINS; NECKLACES;
RINGS; RINGS BEING JEWELRY (U.S. CLS. 2, 27, 28
AND 50).

FIRST USE 1-1-2004; IN COMMERCE 1-1-2004.

KATHERINE STOIDES, EXAMINING ATTORNEY

CLASS 14—(Continued).

SN 78-849,318. OSCAR AND NANCY, INC., NEW YORK, NY.
FILED 3-29-2006.

OSCAR AND NANCY

THE MARK CONSISTS OF STANDARD CHARACTERS WITHOUT CLAIM TO ANY PARTICULAR FONT, STYLE, SIZE, OR COLOR.

FOR JEWELRY (U.S. CLS. 2, 27, 28 AND 50).
FIRST USE 8-4-2002; IN COMMERCE 8-4-2002.
SANI KHOURI, EXAMINING ATTORNEY

SN 78-855,364. CARTIER N.V., CURACAO, NETHERLANDS ANTILLES, FILED 4-6-2006.



NO CLAIM IS MADE TO THE EXCLUSIVE RIGHT TO USE "THE NUMBERS 1-12 OR THE WATCH HANDS", APART FROM THE MARK AS SHOWN.

THE MARK CONSISTS OF A CONFIGURATION OF A WATCH WITH A SQUARE FACE WITH ROUNDED CORNERS; SQUARE BEZEL OR METAL FRAME WITH ROUNDED CORNERS AND SCREW TIPS AT 1, 2, 4, 7, 8, 10 AND 11 O'CLOCK; AN OUTER FRAME COMPOSED OF FOUR SEGMENTS, WITH THE TWO SEGMENTS OF THE OUTER FRAME WHICH ARE HORIZONTAL TO THE FRAME BEING RECTANGULAR, AND THE OTHER TWO PIECES OF THE OUTER FRAME WHICH ARE VERTICAL RELATIVE TO THE CASE EXTENDING HORIZONTALLY AROUND THE CORNER OF THE BEZEL AND THEN VERTICALLY AWAY FROM THE CASE TO EACH CORNER (BOTH THE INNER AND OUTER FRAMES MAY OR MAY NOT BE DECORATED IN JEWELS); AN OCTAGONAL WINDING CROWN WITH "CABOCHON," A ROUNDED STONE; ART DECO ROMAN NUMERALS INCLINING TO CONFORM TO THE ANGLE-DIRECTION OF THE WATCH HANDS AT SUCH TIME AS THE HANDS ARE JUXTAPOSED TO THAT NUMERAL; A "CHEMIN-DE-FER," A RAILROAD, CHAPTER RING OR MINUTE GUIDE BETWEEN THE CENTER OF THE DIAL AND NUMERALS, WITH EVERY FIFTH MINUTE INDICATION BEING

CLASS 14—(Continued).

THICKER AND BOLDER; AND A METAL BRACELET (A WATCH BAND MADE OF METAL) CONSISTING OF FIVE ROWS OF INTERLOCKING RECTANGULAR LINKS (WITH THE RECTANGLES BEING APPROXIMATELY THREE-AND-A-HALF TIMES AS LONG AS WIDE, WITH THE WIDER SIDE VERTICAL TO THE WATCH FACE), WITH LINKS STAGGERED SUCH THAT THE FIRST, THIRD AND FIFTH ROWS ARE STAGGERED ONE-HALF A RECTANGLE LENGTH TO THE SECOND AND FOURTH ROWS.

SEC. 2(F).
FOR HOROLOGIC AND CHRONOMETRIC INSTRUMENTS, NAMELY, WATCHES (U.S. CLS. 2, 27, 28 AND 50).

FIRST USE 6-15-1984; IN COMMERCE 6-15-1984.
CAROLINE WOOD, EXAMINING ATTORNEY

SN 78-858,434. BRICKYARD TRADEMARKS, INC., LAS VEGAS, NV. FILED 4-11-2006.



OWNER OF U.S. REG. NOS. 807,810, 971,243 AND OTHERS.

THE MARK CONSISTS OF A WINGED-WHEEL WITH FLAGS DESIGN WITH WORDS "INDIANAPOLIS MOTOR SPEEDWAY" OUTLINED OVER THE DESIGN.

SEC. 2(F) "INDIANAPOLIS HAS BECOME DISTINCTIVE OF THE GOODS/SERVICES AS EVIDENCED BY THE OWNERSHIP ON THE PRINCIPAL REGISTER FOR THE SAME MARK FOR RELATED GOODS OR SERVICES OF U.S. REGISTRATION NO(S)807810, 808494, 815638, 815639, 970470, 971243, 1021234, 1192522, 1471725, 1532376, 1924168, 2127155, 2127170, 2214672, 2658513, 2723712, 2731526, 2761313, 2785741, 2799837, 2850533, 2850646, 2962768, 2962769, 3063271

FOR WATCHES (U.S. CLS. 2, 27, 28 AND 50).
FIRST USE 5-0-2004; IN COMMERCE 5-0-2004.
DOMINIC FATHY, EXAMINING ATTORNEY

SN 78-859,327. AGEE, JOHN, SHERMAN OAKS, CA. FILED 4-11-2006.

JOHN AGEE

THE MARK CONSISTS OF STANDARD CHARACTERS WITHOUT CLAIM TO ANY PARTICULAR FONT, STYLE, SIZE, OR COLOR.

FOR JEWELRY (U.S. CLS. 2, 27, 28 AND 50).
FIRST USE 0-0-1994; IN COMMERCE 0-0-1994.
RAY THOMAS, EXAMINING ATTORNEY

CLASS 14—(Continued).

SN 78-862,371. WILLIAMS, WENDY S., ORLANDO, FL.
FILED 4-16-2006.

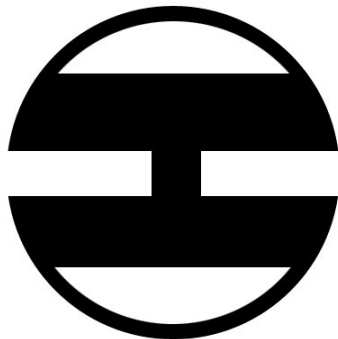

THE MARK CONSISTS OF A STYLIZED CAPITAL
LETTER I IN A CIRCLE.
FOR JEWEL PENDANTS (U.S. CLS. 2, 27, 28 AND 50).
CURTIS FRENCH, EXAMINING ATTORNEY

SN 78-862,873. BELIEFNET, INC., NEW YORK, NY. FILED 4-
17-2006.

FAITH & HARMONY

THE MARK CONSISTS OF STANDARD CHARACTERS
WITHOUT CLAIM TO ANY PARTICULAR FONT, STYLE,
SIZE, OR COLOR.
FOR JEWELRY (U.S. CLS. 2, 27, 28 AND 50).
WON TEAK OH, EXAMINING ATTORNEY

SN 78-862,954. LUNCH AT THE RITZ EARWEAR, INC.,
LAKE KATRINE, NY. FILED 4-17-2006.

LUNCH AT THE RITZ TO GO

THE MARK CONSISTS OF STANDARD CHARACTERS
WITHOUT CLAIM TO ANY PARTICULAR FONT, STYLE,
SIZE, OR COLOR.
FOR JEWELRY (U.S. CLS. 2, 27, 28 AND 50).
EVELYN BRADLEY, EXAMINING ATTORNEY

CLASS 14—(Continued).

SN 78-864,213. GERDRUM, CHERYL, GREAT FALLS, MT.
FILED 4-18-2006.



FOR JEWELRY, NECKLACES AND BRACELETS (U.S.
CLS. 2, 27, 28 AND 50).
FIRST USE 2-0-2004; IN COMMERCE 2-0-2004.
KENNETH E. SHARPERSON, EXAMINING ATTORNEY

SN 78-865,258. RUBINS, BRENDA WASSER, LOS ANGELES,
CA. FILED 4-19-2006.

ID.O

THE MARK CONSISTS OF STANDARD CHARACTERS
WITHOUT CLAIM TO ANY PARTICULAR FONT, STYLE,
SIZE, OR COLOR.
FOR JEWELRY (U.S. CLS. 2, 27, 28 AND 50).
FIRST USE 3-16-2006; IN COMMERCE 3-16-2006.
HEATHER THOMPSON, EXAMINING ATTORNEY

SN 78-865,467. NARRAGANSETT JEWELRY CO., INC.,
PROVIDENCE, RI. FILED 4-20-2006.

KARIBOU

THE MARK CONSISTS OF STANDARD CHARACTERS
WITHOUT CLAIM TO ANY PARTICULAR FONT, STYLE,
SIZE, OR COLOR.
FOR JEWELRY (U.S. CLS. 2, 27, 28 AND 50).
FIRST USE 1-20-1994; IN COMMERCE 1-20-1994.
GILBERT SWIFT, EXAMINING ATTORNEY

CLASS 14—(Continued).

SN 78-867,537. FOURTH AND MARKET, DBA MUDAN BOUTIQUE, ATLANTA, GA. FILED 4-23-2006.



NO CLAIM IS MADE TO THE EXCLUSIVE RIGHT TO USE "BOUTIQUE", APART FROM THE MARK AS SHOWN. THE COLORS RED, PINK, GRAY AND BLACK ARE CLAIMED AS A FEATURE OF THE MARK.

THE COLOR BLACK APPEARS IN THE WORD "MUDAN", THE COLOR RED APPEARS IN THE WORD "BOUTIQUE", THE COLORS PINK, RED AND A SALMON RED SHADE APPEAR IN THE PETALS OF THE DESIGN OF A PEONY FLOWER AND THE COLOR GRAY APPEARS IN A DROP SHADOW BELOW THE WORD MUDAN AND IN THE VINE EXTENDING FROM THE PEONY FLOWER.

THE MARK CONSISTS IN PART OF THE WORD "MUDAN" WHICH IS A WORD HAVING NO MEANING IN ENGLISH OTHER THAN AS TAKEN FROM THE TRANSLITERATION OF THE CHINESE CHARACTERS "MU" AND "DAN" MEANING "PEONY," A TYPE OF FLOWER.

FOR JEWELRY (U.S. CLS. 2, 27, 28 AND 50).
FIRST USE 11-1-2005; IN COMMERCE 11-17-2005.
HANNO RITTNER, EXAMINING ATTORNEY

CLASS 14—(Continued).

SN 78-885,883. WESTRIM, INC., VAN NUYS, CA. FILED 5-17-2006.

BEAD IN STYLE

THE MARK CONSISTS OF STANDARD CHARACTERS WITHOUT CLAIM TO ANY PARTICULAR FONT, STYLE, SIZE, OR COLOR.

OWNER OF U.S. REG. NO. 3,121,268.

NO CLAIM IS MADE TO THE EXCLUSIVE RIGHT TO USE BEAD, APART FROM THE MARK AS SHOWN.

FOR JEWELRY, IMITATION JEWELRY AND COSTUME JEWELRY AND PARTS THEREOF - NAMELY, WOOD BEADS, CLAY BEADS, METAL BEADS, PLASTIC BEADS, GLASS BEADS, STRINGS OF BEADS, PEARLS, RHINESTONES, DECORATIVE CHAIN, RING CASTINGS, PIN CASTINGS, MINIATURE ANIMAL AND FISH FIGURINES MADE OF PRECIOUS METALS; ORNAMENTAL PINS; JEWELRY BRACELETS; CHARMS; JEWELRY CHAINS; EAR CLIPS; TIE CLIPS; EARRINGS; FIGURES OF PRECIOUS METALS; JEWELRY BOXES MADE OF PRECIOUS METALS; NECKLACES; PENDANTS; RINGS BEING JEWELRY; SCULPTURES OF PRECIOUS METALS; KEY FOBS OF PRECIOUS METALS; AND JEWELRY FINDINGS (U.S. CLS. 2, 27, 28 AND 50).

FIRST USE 12-15-1996; IN COMMERCE 12-15-1996.

KAREN K. BUSH, EXAMINING ATTORNEY

SN 78-890,922. HOODLOVE LIMITED LIABILITY COMPANY, EAST ORANGE, NJ. FILED 5-24-2006.



SN 78-868,790. MORREN, CHRIS M., ZEELAND, MI. FILED 4-25-2006.

HEAR OUR PRAYERS

THE MARK CONSISTS OF STANDARD CHARACTERS WITHOUT CLAIM TO ANY PARTICULAR FONT, STYLE, SIZE, OR COLOR.

FOR JEWELRY; JEWELRY CHAINS; PINS BEING JEWELRY (U.S. CLS. 2, 27, 28 AND 50).

FIRST USE 4-1-2006; IN COMMERCE 4-1-2006.

HOWARD B. LEVINE, EXAMINING ATTORNEY

THE MARK CONSISTS OF THE STYLIZED WORDING HOOD LOVE HL HOOD LOVE OVER A BACKGROUND COMPRISED OF BUILDINGS.

FOR BRACELETS; CHARMS; CLOCKS; COSTUME JEWELRY; JEWELRY; JEWELRY FOR THE HEAD; LAPEL PINS; NAPKIN HOLDERS OF PRECIOUS METAL; NAPKIN RINGS OF PRECIOUS METAL; NUTCRACKERS, PEPPER POTS, SUGAR BOWLS, SALT SHAKERS, EGG CUPS, NAPKIN HOLDERS, NAPKIN RINGS, TRAYS AND TOOTHPICK HOLDERS OF PRECIOUS METAL; ORNAMENTAL LAPEL PINS; PINS BEING JEWELRY; RINGS BEING JEWELRY; WALL CLOCKS; WATCHES (U.S. CLS. 2, 27, 28 AND 50).

BARBARA BROWN, EXAMINING ATTORNEY

CLASS 14—(Continued).

SN 78-890,924. HOODLOVE LIMITED LIABILITY COMPANY, EAST ORANGE, NJ. FILED 5-24-2006.

HOOD LOVE

THE MARK CONSISTS OF STANDARD CHARACTERS WITHOUT CLAIM TO ANY PARTICULAR FONT, STYLE, SIZE, OR COLOR.

FOR BRACELETS; CHARMS; CLOCKS; COSTUME JEWELRY; JEWELRY; JEWELRY FOR THE HEAD; LAPEL PINS; NAPKIN HOLDERS OF PRECIOUS METAL; NAPKIN RINGS OF PRECIOUS METAL; NUTCRACKERS, PEPPER POTS, SUGAR BOWLS, SALT SHAKERS, EGG CUPS, NAPKIN HOLDERS, NAPKIN RINGS, TRAYS AND TOOTHPICK HOLDERS OF PRECIOUS METAL; ORNAMENTAL LAPEL PINS; PINS BEING JEWELRY; RINGS BEING JEWELRY; WALL CLOCKS; WATCHES (U.S. CLS. 2, 27, 28 AND 50).

BARBARA BROWN, EXAMINING ATTORNEY

SN 78-960,624. O'BRIEN, PAUL, TUNKHANNOCK, PA. FILED 8-25-2006.

AVERA

THE MARK CONSISTS OF STANDARD CHARACTERS WITHOUT CLAIM TO ANY PARTICULAR FONT, STYLE, SIZE, OR COLOR.

FOR JEWELRY (U.S. CLS. 2, 27, 28 AND 50).
JEFFERY COWARD, EXAMINING ATTORNEY

SN 79-015,071. OMEGA SA (OMEGA AG) (OMEGA LTD.), SWITZERLAND, FILED 9-5-2005.

OMEGA DE VILLE CONNOISSEUR

THE MARK CONSISTS OF STANDARD CHARACTERS WITHOUT CLAIM TO ANY PARTICULAR FONT, STYLE, SIZE, OR COLOR.

PRIORITY DATE OF 7-26-2005 IS CLAIMED.
OWNER OF INTERNATIONAL REGISTRATION 0861398 DATED 9-5-2005, EXPIRES 9-5-2015.
OWNER OF U.S. REG. NOS. 25,036, 1,309,929 AND OTHERS.

THE ENGLISH TRANSLATION OF DE VILLE IS "OF THE CITY".

FOR PRECIOUS METALS AND THEIR ALLOYS AND GOODS IN PRECIOUS METALS OR COATED THEREWITH NAMELY LIGHTERS FOR SMOKERS, CIGAR CUTTERS, ASHTRAYS FOR SMOKERS, KEY RINGS, TROPHIES; JEWELRY, PRECIOUS STONES; HOROLOGICAL AND CHRONOMETRIC INSTRUMENTS (U.S. CLS. 2, 27, 28 AND 50).

STEVEN PEREZ, EXAMINING ATTORNEY

CLASS 14—(Continued).

SN 79-021,905. SHISHI XINJIA ELECTRONICS CO., LTD., CHINA, FILED 9-26-2005.

SINTE

OWNER OF INTERNATIONAL REGISTRATION 0879917 DATED 9-26-2005, EXPIRES 9-26-2015.

FOR CLOCKS, WATCHES, CHRONOGRAPHS FOR USE AS WATCHES, ELECTRIC CLOCKS AND ELECTRIC WATCHES, WATCH BANDS, CASES FOR CLOCK AND WATCHMAKING, WATCH CASES, STOPWATCHES (U.S. CLS. 2, 27, 28 AND 50).

LANA PHAM, EXAMINING ATTORNEY

SN 79-024,092. ALFRED DUNHILL LIMITED, UNITED KINGDOM, FILED 4-3-2006.

PENTAGRAPH

THE MARK CONSISTS OF STANDARD CHARACTERS WITHOUT CLAIM TO ANY PARTICULAR FONT, STYLE, SIZE, OR COLOR.

PRIORITY DATE OF 10-12-2005 IS CLAIMED.

OWNER OF INTERNATIONAL REGISTRATION 0885538 DATED 4-3-2006, EXPIRES 4-3-2016.

FOR HOROLOGICAL AND CHRONOMETRIC INSTRUMENTS; CLOCKS, WATCHES; WATCH STRAPS, WATCH BRACELETS; JEWELLERY, CUFFLINKS; TIE BARS, TIE PINS; SHIRT AND COLLAR STUDS (U.S. CLS. 2, 27, 28 AND 50).

JOSETTE BEVERLY, EXAMINING ATTORNEY

SN 79-025,252. PARMIGIANI FLEURIER S.A., SWITZERLAND, FILED 4-20-2006.

KALHYDRA

THE MARK CONSISTS OF STANDARD CHARACTERS WITHOUT CLAIM TO ANY PARTICULAR FONT, STYLE, SIZE, OR COLOR.

PRIORITY DATE OF 10-25-2005 IS CLAIMED.

OWNER OF INTERNATIONAL REGISTRATION 0888619 DATED 4-20-2006, EXPIRES 4-20-2016.

FOR ALL WATCH AND CLOCK PRODUCTS, NAMELY WATCHES, WRISTWATCHES, WATCH BANDS, CASES FOR WATCHES, WATCH CRYSTALS, WATCH WINDING BUTTONS, WATCH MOVEMENTS, WATCHBAND BUCKLES, WATCH DIALS, WATCH BELZELS; CHRONOMETERS, CHRONOGRAPHS FOR USE AS WATCHES; WALL CLOCKS AND DIALS FOR WALL CLOCKS, MOVEMENTS; JEWELRY NAMELY RINGS, EARRINGS, BRACELETS, NECKLACES, PENDANTS, CUFF LINKS, BROOCHES (U.S. CLS. 2, 27, 28 AND 50).

HOWARD B. LEVINE, EXAMINING ATTORNEY

CLASS 15—MUSICAL INSTRUMENTS

SN 76-647,857. IYM CORP., RIDGEWOOD, NJ. FILED 10-3-2005.

MAXIMUS

THE MARK CONSISTS OF STANDARD CHARACTERS WITHOUT CLAIM TO ANY PARTICULAR FONT, STYLE, SIZE, OR COLOR.
FOR MOUTHPIECE FOR BRASS MUSICAL INSTRUMENTS (U.S. CLS. 2, 21 AND 36).
FIRST USE 6-25-2005; IN COMMERCE 6-25-2005.
KELLY MCCOY, EXAMINING ATTORNEY

SN 76-656,816. BALDWIN PIANO, INC., NASHVILLE, TN. FILED 3-17-2006.

MIRACLE

THE MARK CONSISTS OF STANDARD CHARACTERS WITHOUT CLAIM TO ANY PARTICULAR FONT, STYLE, SIZE, OR COLOR.
FOR ELECTRONIC MUSICAL INSTRUMENTS, NAMELY, ELECTRONIC KEYBOARD INSTRUMENTS AND PRINTED AND ELECTRONIC TEACHING MATERIALS IN THE FIELD OF PIANO LESSONS AND OPERATING MANUALS SUPPLIED AS A UNIT (U.S. CLS. 2, 21 AND 36).
DOMINICK J. SALEMI, EXAMINING ATTORNEY

SN 76-656,818. BALDWIN PIANO, INC., NASHVILLE, TN. FILED 3-17-2006.

THE SOFTWARE TOOLWORKS

THE MARK CONSISTS OF STANDARD CHARACTERS WITHOUT CLAIM TO ANY PARTICULAR FONT, STYLE, SIZE, OR COLOR.
NO CLAIM IS MADE TO THE EXCLUSIVE RIGHT TO USE "SOFTWARE", APART FROM THE MARK AS SHOWN.
FOR ELECTRONIC MUSICAL INSTRUMENTS, NAMELY, ELECTRONIC KEYBOARD INSTRUMENTS AND PRINTED AND ELECTRONIC TEACHING MATERIALS IN THE FIELD OF PIANO LESSONS AND OPERATING MANUALS SUPPLIED AS A UNIT (U.S. CLS. 2, 21 AND 36).
DOMINICK J. SALEMI, EXAMINING ATTORNEY

CLASS 15—(Continued).

SN 78-695,802. 117506 CANADA INC., BAIE-D'URFE, QC, CANADA, FILED 8-18-2005.

MULTIAC

THE MARK CONSISTS OF STANDARD CHARACTERS WITHOUT CLAIM TO ANY PARTICULAR FONT, STYLE, SIZE, OR COLOR.
FOR GUITARS (U.S. CLS. 2, 21 AND 36).
FIRST USE 2-28-1994; IN COMMERCE 2-28-1994.
JASON LOTT, EXAMINING ATTORNEY

SN 78-698,421. J.D. CALATO MANUFACTURING CO., INC., NIAGARA FALLS, NY. FILED 8-23-2005.

E SERIES

THE MARK CONSISTS OF STANDARD CHARACTERS WITHOUT CLAIM TO ANY PARTICULAR FONT, STYLE, SIZE, OR COLOR.
OWNER OF U.S. REG. NOS. 811,712, 2,954,328 AND OTHERS.
NO CLAIM IS MADE TO THE EXCLUSIVE RIGHT TO USE "SERIES", APART FROM THE MARK AS SHOWN.
FOR DRUMSTICKS AND PERCUSSION MUSICAL INSTRUMENTS (U.S. CLS. 2, 21 AND 36).
FIRST USE 11-1-2003; IN COMMERCE 11-1-2003.
LYDIA BELZER, EXAMINING ATTORNEY

SN 78-713,946. ROSE, FLOYD D., SAMMAMISH, WA. FILED 9-15-2005.

GREEN MONSTER

THE MARK CONSISTS OF STANDARD CHARACTERS WITHOUT CLAIM TO ANY PARTICULAR FONT, STYLE, SIZE, OR COLOR.
FOR STRINGED INSTRUMENTS, NAMELY GUITARS (U.S. CLS. 2, 21 AND 36).
RICHARD A. STRASER, EXAMINING ATTORNEY

CLASS 15—(Continued).

SN 78-771,697. TAYLOR-LISTUG, INC., EL CAJON, CA.
FILED 12-12-2005.



OWNER OF U.S. REG. NOS. 1,221,601, 2,256,651 AND OTHERS.
SEC. 2(F) AS TO "TAYLOR".
FOR MUSICAL INSTRUMENTS, NAMELY, GUITARS; AND CARRYING CASES FOR MUSICAL INSTRUMENTS (U.S. CLS. 2, 21 AND 36).
TINA BROWN, EXAMINING ATTORNEY

CLASS 15—(Continued).

SN 78-841,213. HARRINGTON, TIMOTHY, LEWIS, LEAGUE CITY, TX. FILED 3-20-2006.



OWNER OF U.S. REG. NO. 2,891,162.
THE MARK CONSISTS OF GOLDFISH NAME ON TOP OF A SYMBOL THAT IS FISH SHAPED.
FOR BRASS INSTRUMENTS; BRASS INSTRUMENTS, NAMELY, SAXOPHONES AND OBOES; CARRYING CASES FOR MUSICAL INSTRUMENTS; DRUMS; ELECTRONIC MUSICAL KEYBOARDS; JAPANESE TRADITIONAL MUSICAL INSTRUMENTS; KEYBOARD INSTRUMENTS; MANDOLINS; MUSIC PITCH PIPES; MUSIC SYNTHESIZERS; MUSICAL BOXES; MUSICAL CHRISTMAS ORNAMENTS; MUSICAL INSTRUMENT STANDS; MUSICAL INSTRUMENTS; MUSICAL INSTRUMENTS, NAMELY, BASS GUITARS; MUSICAL INSTRUMENTS, NAMELY, GONGS; MUSICAL INSTRUMENTS, NAMELY, RATTLES; MUSICAL INSTRUMENTS, NAMELY, STEEL DRUMS; MUSICAL INSTRUMENTS, NAMELY, STRING BASSES; MUSICAL INSTRUMENTS, NAMELY, ELECTRIC GUITARS AND ACOUSTIC GUITARS; MUSICAL KEYBOARD CARRYING CASES; PERCUSSION INSTRUMENTS; PERCUSSION INSTRUMENTS, NAMELY, BONGOS, DRUMS, CYMBALS AND CYMBAL STANDS; PICKS FOR STRINGED INSTRUMENTS; RECORDERS; STANDS FOR MUSICAL INSTRUMENTS; STRING INSTRUMENTS; STRING INSTRUMENTS, NAMELY, KIDS GUITARS, KIDS BASS GUITARS AND KIDS ACOUSTIC GUITARS; STRINGS FOR JAPANESE STYLE STRINGED INSTRUMENTS; STRINGS FOR WESTERN MUSICAL INSTRUMENTS; TUNERS FOR MUSICAL INSTRUMENTS; TUNING APPARATUS FOR MUSICAL INSTRUMENTS; WESTERN STYLE MUSICAL INSTRUMENTS; WIND INSTRUMENTS; WIND INSTRUMENTS, NAMELY, FLUTES; WOODWIND INSTRUMENTS; WOODWIND INSTRUMENTS, NAMELY, CLARINETS AND BASS CLARINETS (U.S. CLS. 2, 21 AND 36).
FIRST USE 12-10-2000; IN COMMERCE 12-7-2002.
KEVON CHISOLM, EXAMINING ATTORNEY

CLASS 15—(Continued).

SN 78-856,950. SAWHNEY, RAVI K., THOUSAND OAKS, CA.
FILED 4-7-2006.



OWNER OF U.S. REG. NO. 2,869,587.
THE MARK CONSISTS OF THE LETTERS RKS.
FOR MUSICAL INSTRUMENTS (U.S. CLS. 2, 21 AND
36).
FIRST USE 6-1-2003; IN COMMERCE 6-1-2003.
DOMINICK J. SALEMI, EXAMINING ATTORNEY

SN 78-860,282. WINCH WAY MUSIC LIMITED, WELLING-
TON, NEW ZEALAND, FILED 4-12-2006.

Gig Gard

THE MARK CONSISTS OF STANDARD CHARACTERS
WITHOUT CLAIM TO ANY PARTICULAR FONT, STYLE,
SIZE, OR COLOR.
FOR COVERS FOR MUSICAL INSTRUMENTS TO
PROTECT INSTRUMENTS FROM DUST; COVERS FOR
MUSICAL INSTRUMENTS TO KEEP INSTRUMENTS
WARM; COVERS FOR MUSICAL INSTRUMENTS TO
RESIST UNDESIRE RESONANCES AND AUDIO RE-
FLECTIONS FROM SUCH INSTRUMENTS (U.S. CLS. 2,
21 AND 36).
ALLISON SCHRODY, EXAMINING ATTORNEY

SN 78-860,440. MICHAEL TOBIAS DESIGN, LLC, KING-
STON, NY. FILED 4-12-2006.

435

THE MARK CONSISTS OF STANDARD CHARACTERS
WITHOUT CLAIM TO ANY PARTICULAR FONT, STYLE,
SIZE, OR COLOR.
OWNER OF U.S. REG. NO. 2,251,114.
SEC. 2(F).
FOR STRINGED MUSICAL INSTRUMENTS, NAMELY
ELECTRIC AND ACOUSTIC BASSES (U.S. CLS. 2, 21
AND 36).
FIRST USE 1-1-1994; IN COMMERCE 1-20-1994.
DOMINIC FATHY, EXAMINING ATTORNEY

CLASS 15—(Continued).

SN 78-861,174. MICHAEL TOBIAS DESIGN, LLC, KING-
STON, NY. FILED 4-13-2006.

635

THE MARK CONSISTS OF STANDARD CHARACTERS
WITHOUT CLAIM TO ANY PARTICULAR FONT, STYLE,
SIZE, OR COLOR.
OWNER OF U.S. REG. NO. 2,251,114.
SEC. 2(F).
FOR STRINGED MUSICAL INSTRUMENTS,
NAMELY, ELECTRIC AND ACOUSTIC BASSES (U.S.
CLS. 2, 21 AND 36).
FIRST USE 1-1-1994; IN COMMERCE 1-20-1994.
DOMINIC FATHY, EXAMINING ATTORNEY

SN 78-865,318. DAVID FRENCH MUSIC CO. INC., WEST-
BOROUGH, MA. FILED 4-19-2006.

CONSERVATORY

THE MARK CONSISTS OF STANDARD CHARACTERS
WITHOUT CLAIM TO ANY PARTICULAR FONT, STYLE,
SIZE, OR COLOR.
FOR MUSICAL INSTRUMENTS (U.S. CLS. 2, 21 AND
36).
RUSS HERMAN, EXAMINING ATTORNEY

SN 78-869,700. BUSHMAN MUSIC WORKS, LLC, NEW
PALESTINE, IN. FILED 4-26-2006.

DELTA FROST

THE MARK CONSISTS OF STANDARD CHARACTERS
WITHOUT CLAIM TO ANY PARTICULAR FONT, STYLE,
SIZE, OR COLOR.
FOR HARMONICAS (U.S. CLS. 2, 21 AND 36).
FIRST USE 10-31-1999; IN COMMERCE 10-31-1999.
WANDA KAY PRICE, EXAMINING ATTORNEY

CLASS 15—(Continued).

SN 78-875,608. PAUL REED SMITH GUITARS, LIMITED PARTNERSHIP, STEVENSVILLE, MD. FILED 5-3-2006.



THE MARK CONSISTS OF A CIRCLE AND CROSS LOGO, FOR BASS GUITARS; GUITARS (U.S. CLS. 2, 21 AND 36).

AMY MCMENAMIN, EXAMINING ATTORNEY

SN 79-022,178. PROSTAGE GMBH, SWITZERLAND, FILED 1-9-2006.

PROSTAGE

OWNER OF INTERNATIONAL REGISTRATION 0785610 DATED 7-4-2002, EXPIRES 7-4-2012.

FOR MUSICAL INSTRUMENT CONTROL PEDALS, NAMELY, FOOT CONTROLLERS FOR USE BY MUSICIANS TO CONTROL ELECTRONIC MUSICAL INSTRUMENTS AND ACCESSORIES THEREFORE, NAMELY, DIGITAL MIDI SIGNAL ADAPTERS/CONVERTERS AND DIGITAL/ANALOG SIGNAL SWITCHING/ROUTING DEVICES SOLD THEREWITH AS A UNIT (U.S. CLS. 2, 21 AND 36).

STEVEN PEREZ, EXAMINING ATTORNEY

CLASS 16—PAPER GOODS AND PRINTED MATTER

SN 76-532,050. DEFILIPPE, THOMAS, OYSTER BAY, NY. FILED 7-9-2003.

I HOPE YOU DANCE

FOR PHOTOGRAPH ALBUMS, DIARIES, BLANK JOURNALS, WRITING JOURNALS CONTAINING INSPIRATIONAL MESSAGES, BOOKMARKS, GREETING CARDS, PRINTED INVITATIONS, WRITING PAPER AND ENVELOPES, GIFT WRAPPING PAPER AND PAPER GIFT BAGS, DECORATIVE TISSUE PAPER, PAPER RIBBONS AND BOWS FOR GIFT WRAP, PAPER TABLE CLOTHS, PAPER NAPKINS, AND PAPERWEIGHTS (U.S. CLS. 2, 5, 22, 23, 29, 37, 38 AND 50).

PAM WILLIS, EXAMINING ATTORNEY

CLASS 16—(Continued).

SN 76-625,065. SCOTT PAPER LIMITED, MISSISSAUGA, ONTARIO, CANADA, FILED 12-17-2004.



PRIORITY CLAIMED UNDER SEC. 44(D) ON CANADA APPLICATION NO. 1240693, FILED 12-14-2004, REG. NO. TMA652150, DATED 11-2-2005, EXPIRES 11-2-2020.

OWNER OF U.S. REG. NO. 2,070,125.

NO CLAIM IS MADE TO THE EXCLUSIVE RIGHT TO USE "ULTRA", APART FROM THE MARK AS SHOWN.

FOR BATHROOM AND FACIAL TISSUE (U.S. CLS. 2, 5, 22, 23, 29, 37, 38 AND 50).

ANN E. SAPPENFIELD, EXAMINING ATTORNEY

SN 76-628,834. FUNDACION SANTA MARIA, MADRID, SPAIN, FILED 1-26-2005.

ediciones **sm**

OWNER OF SPAIN REG. NO. 1286374, DATED 4-5-1990, RENEWED AS REG. NO. 1286374, DATED 4-5-2005, EXPIRES 4-5-2010.

OWNER OF U.S. REG. NO. 1,471,699.

NO CLAIM IS MADE TO THE EXCLUSIVE RIGHT TO USE "EDICIONES", APART FROM THE MARK AS SHOWN.

THE COLOR(S) RED, BLACK AND WHITE IS/ARE CLAIMED AS A FEATURE OF THE MARK.

THE COLOR BLACK APPEARS IN THE WORD "EDICIONES." THE COLOR RED APPEARS IN TWO RECTANGLES OF THE DESIGN. THE COLOR WHITE APPEARS AS THE LETTERS "SM" IN THE RED RECTANGLES.

THE ENGLISH TRANSLATION OF THE WORD "EDICIONES" IS "EDITIONS."

FOR PUBLICATIONS, NAMELY, MAGAZINES, BOOKS, MANUALS AND TEXTBOOKS IN THE FIELDS OF LINGUISTICS, MATHEMATICS, SCIENCE, GEOGRAPHY, HISTORY, LITERATURE, ART, PHYSICS, CHEMISTRY, BIOLOGY FOR USE IN TEACHING LANGUAGES; PRINTED TEACHING MATERIAL, NAMELY, CHILDREN'S ACTIVITY BOOKS, TEACHER'S GUIDE BOOKS FEATURING LINGUISTICS, MATHEMATICS, SCIENCE, GEOGRAPHY, HISTORY, LITERATURE, ART, PHYSICS, CHEMISTRY, BIOLOGY FOR USE IN TEACHING LANGUAGES; SERIES OF FICTION AND NONFICTION BOOKS ON A VARIETY OF MATTERS WITH EDUCATIONAL AND ENTERTAINMENT PURPOSES (U.S. CLS. 2, 5, 22, 23, 29, 37, 38 AND 50).

MICHELE SWAIN, EXAMINING ATTORNEY

CLASS 16—(Continued).

SN 76-642,914. HOUGHTON MIFFLIN COMPANY, BOSTON, MA. FILED 7-15-2005.

UNIT GROUP ABILITIES TEST

THE MARK CONSISTS OF STANDARD CHARACTERS WITHOUT CLAIM TO ANY PARTICULAR FONT, STYLE, SIZE, OR COLOR.

NO CLAIM IS MADE TO THE EXCLUSIVE RIGHT TO USE "GROUP ABILITIES TEST", APART FROM THE MARK AS SHOWN.

FOR PRINT PUBLICATIONS, NAMELY, PRINTED TESTS, SCORE REPORTS, ANSWER SHEETS, RELATED INSTRUCTION MANUALS, RESOURCES, TOOLS AND TRAINING MATERIALS FOR USE IN ADMINISTERING CLINICAL ASSESSMENT OF NON-VERBAL INTELLIGENCE (U.S. CLS. 2, 5, 22, 23, 29, 37, 38 AND 50).

IRENE D. WILLIAMS, EXAMINING ATTORNEY

SN 76-643,757. WAUSAU PAPER CORP., MOSINEE, WI. FILED 7-28-2005.

EXACT ECO 100

THE MARK CONSISTS OF STANDARD CHARACTERS WITHOUT CLAIM TO ANY PARTICULAR FONT, STYLE, SIZE, OR COLOR.

OWNER OF U.S. REG. NOS. 1,123,706 AND 1,901,731. FOR PRINTING, WRITING, AND IMAGING PAPERS (U.S. CLS. 2, 5, 22, 23, 29, 37, 38 AND 50).

SANI KHOURI, EXAMINING ATTORNEY

SN 76-643,886. SILVER GHOST ASSOCIATION, INC., TAYLORVILLE, IL. FILED 7-29-2005.

SILVER GHOST TOURER

THE MARK CONSISTS OF STANDARD CHARACTERS WITHOUT CLAIM TO ANY PARTICULAR FONT, STYLE, SIZE, OR COLOR.

FOR PRINTED PUBLICATIONS, NAMELY, NEWS MAGAZINES (U.S. CLS. 2, 5, 22, 23, 29, 37, 38 AND 50). FIRST USE 5-0-1987; IN COMMERCE 5-0-1987.

LEIGH CAROLINE CASE, EXAMINING ATTORNEY

CLASS 16—(Continued).

SN 76-644,179. WIZARDS OF THE COAST, INC., PAWTUCKET, RI. FILED 8-3-2005.

PLAYER'S HANDBOOK

THE MARK CONSISTS OF STANDARD CHARACTERS WITHOUT CLAIM TO ANY PARTICULAR FONT, STYLE, SIZE, OR COLOR.

NO CLAIM IS MADE TO THE EXCLUSIVE RIGHT TO USE "HANDBOOK", APART FROM THE MARK AS SHOWN.

SEC. 2(F).

FOR PUBLICATIONS, NAMELY INSTRUCTIONAL BOOKLETS FOR THE PLAYING OF ROLE-PLAY GAMES (U.S. CLS. 2, 5, 22, 23, 29, 37, 38 AND 50).

FIRST USE 8-15-1978; IN COMMERCE 8-15-1978.

SKYE YOUNG, EXAMINING ATTORNEY

SN 76-644,849. KID STUFF MARKETING, INC., TOPEKA, KS. FILED 8-15-2005.

S. C. U. G. S.

THE MARK CONSISTS OF STANDARD CHARACTERS WITHOUT CLAIM TO ANY PARTICULAR FONT, STYLE, SIZE, OR COLOR.

FOR PAPER DISPLAY POSTERS; PAPER BAGS FOR PACKAGING FOOD AND ACCOMPANYING PROMOTIONAL TOYS; TRADING CARDS (U.S. CLS. 2, 5, 22, 23, 29, 37, 38 AND 50).

FIRST USE 2-23-2004; IN COMMERCE 2-23-2004.

KRISTINA KLOIBER, EXAMINING ATTORNEY

SN 76-645,733. EDGERTON, CALVIN R., FOUR OAKS, NC. AND EDGERTON, DOTTY J., FOUR OAKS, NC. FILED 8-26-2005.

Simple Press

THE MARK CONSISTS OF STANDARD CHARACTERS WITHOUT CLAIM TO ANY PARTICULAR FONT, STYLE, SIZE, OR COLOR.

NO CLAIM IS MADE TO THE EXCLUSIVE RIGHT TO USE "PRESS", APART FROM THE MARK AS SHOWN.

FOR PRINTED MATTER NAMELY, BOOKS, MAGAZINES FEATURING THE SUBJECT OF GROWTH AND INSPIRATION IN THE CHRISTIAN LIFE, FICTION AND NON-FICTION; PRINTED TEACHING MATERIAL IN THE FIELD OF GROWTH AND INSPIRATION IN THE CHRISTIAN LIFE (U.S. CLS. 2, 5, 22, 23, 29, 37, 38 AND 50).

PAULA MAYS, EXAMINING ATTORNEY

CLASS 16—(Continued).

SN 76-648,760. CENTRAL FLORIDA INVESTMENTS, INC., ORLANDO, FL. FILED 10-14-2005.



OWNER OF U.S. REG. NOS. 1,892,182, 2,859,176 AND OTHERS.

NO CLAIM IS MADE TO THE EXCLUSIVE RIGHT TO USE "MYRTLE BEACH", APART FROM THE MARK AS SHOWN.

FOR MAGAZINES DEALING WITH THE CITY OF MYRTLE BEACH, SOUTH CAROLINA AND TOURISM THEREIN WHICH PROVIDE INFORMATION REGARDING PERSONS, BUSINESSES, RESORTS, RESTAURANTS, ATTRACTIONS AND ACTIVITIES THEREIN; COUPONS FOR USE AT BUSINESSES, ENTERTAINMENT FACILITIES, ATTRACTIONS, RESORTS, ACTIVITIES AND RESTAURANTS; AND NOVELTY ITEMS AND SOUVENIRS, NAMELY, BUMPER STICKERS, JUMBO PAPER CLIPS AND PENS (U.S. CLS. 2, 5, 22, 23, 29, 37, 38 AND 50).

KATHERINE E. HALMEN, EXAMINING ATTORNEY

SN 76-648,761. CENTRAL FLORIDA INVESTMENTS, INC., ORLANDO, FL. FILED 10-14-2005.



OWNER OF U.S. REG. NOS. 2,524,004, 2,859,176 AND OTHERS.

NO CLAIM IS MADE TO THE EXCLUSIVE RIGHT TO USE "MIAMI", APART FROM THE MARK AS SHOWN.

FOR MAGAZINES DEALING WITH THE CITY OF MIAMI, FLORIDA AND TOURISM THEREIN WHICH PROVIDE INFORMATION REGARDING PERSONS, BUSINESSES, RESORTS, RESTAURANTS, ATTRACTIONS AND ACTIVITIES THEREIN; COUPONS FOR USE AT BUSINESSES, ENTERTAINMENT FACILITIES, ATTRACTIONS, RESORTS, ACTIVITIES AND RESTAURANTS; AND NOVELTY ITEMS AND SOUVENIRS, NAMELY, BUMPER STICKERS, JUMBO PAPER CLIPS AND PENS (U.S. CLS. 2, 5, 22, 23, 29, 37, 38 AND 50).

BARNEY CHARLON, EXAMINING ATTORNEY

SN 76-650,237. CAR-O-LINER COMPANY, WIXOM, MI. FILED 11-14-2005.



THE MARK CONSISTS OF STANDARD CHARACTERS WITHOUT CLAIM TO ANY PARTICULAR FONT, STYLE, SIZE, OR COLOR.

FOR BOOKS AND CHARTS CONTAINING VEHICLE BODY DIMENSIONS, VEHICLE FRAME DIMENSIONS OR BOTH (U.S. CLS. 2, 5, 22, 23, 29, 37, 38 AND 50).

FIRST USE 12-31-1953; IN COMMERCE 12-31-1953.

INGRID C. EULIN, EXAMINING ATTORNEY

CLASS 16—(Continued).

SN 76-650,902. WALGREEN CO., DEERFIELD, IL. FILED 11-23-2005.



THE MARK CONSISTS OF STANDARD CHARACTERS WITHOUT CLAIM TO ANY PARTICULAR FONT, STYLE, SIZE, OR COLOR.

FOR REBATE CATALOG AND COUPONS USED TO OBTAIN REBATES AND DISCOUNTS FROM MANUFACTURERS (U.S. CLS. 2, 5, 22, 23, 29, 37, 38 AND 50).

FIRST USE 2-0-1995; IN COMMERCE 2-0-1995.

ELLEN B. AWRICH, EXAMINING ATTORNEY

SN 76-654,411. REYNOLDS, CONNIE, DBA POWER COMMUNICATIONS, NORTH BERGEN, NJ. FILED 1-27-2006.



THE MARK CONSISTS OF STANDARD CHARACTERS WITHOUT CLAIM TO ANY PARTICULAR FONT, STYLE, SIZE, OR COLOR.

NO CLAIM IS MADE TO THE EXCLUSIVE RIGHT TO USE "ART", APART FROM THE MARK AS SHOWN.

FOR FRAMED ART COMBINING WORDS AND QUOTATIONS WITH VISUAL IMAGES, NAMELY, PHOTOGRAPHS, SCULPTURES AND PAINTINGS (U.S. CLS. 2, 5, 22, 23, 29, 37, 38 AND 50).

FIRST USE 11-11-2005; IN COMMERCE 1-3-2006.

KATHERINE CHANG, EXAMINING ATTORNEY

CLASS 16—(Continued).

SN 76-657,329. MAGS ENTERTAINMENT, LLC, GREENWOOD, SC. FILED 3-24-2006.

**BEARSHEBA J. BEAR
BJ'S TEDDY BEAR CLUB
AND BIBLE STORIES**

THE MARK CONSISTS OF STANDARD CHARACTERS WITHOUT CLAIM TO ANY PARTICULAR FONT, STYLE, SIZE, OR COLOR.

NO CLAIM IS MADE TO THE EXCLUSIVE RIGHT TO USE "BEAR", "TEDDY BEAR", AND "BIBLE STORIES", APART FROM THE MARK AS SHOWN.

THE NAME BEARSHEBA J. BEAR DOES NOT IDENTIFY A LIVING INDIVIDUAL.

FOR CHILDREN'S BOOKS, NAMELY, SERIES OF FICTION BOOKS AND NON-FICTION BOOKS FOR CHILDREN; PUBLICATIONS INTENDED FOR USE BY CHILDREN, NAMELY, CHILDREN'S BOOKS, MAGAZINES FEATURING RELIGIOUS CONTENT, PRE-SCHOOL EDUCATION AND CARTOON CHARACTERS, COMIC BOOKS, PICTURE BOOKS, COLORING BOOKS, CHILDREN'S STORY BOOKS, BIBLE STORY BOOKS, EDUCATIONAL BOOKS FEATURING ANIMATED CHARACTERS AND STORIES, MUSIC, BIBLE TEACHINGS, GAMES AND FUN ACTIVITIES; EXERCISE BOOKS; PAMPHLETS IN THE FIELD OF RELIGIOUS SUBJECT MATTER, PRE-SCHOOL EDUCATION AND CARTOONS; NEWSLETTERS IN THE FIELD OF RELIGIOUS SUBJECT MATTER, PRE-SCHOOL EDUCATION AND CARTOONS; CALENDARS; POSTERS, PHOTOGRAPHS, PICTURES AND PRINTS; STICKERS, BUMPER STICKERS, DECALS AND REMOVABLE TATTOOS; TRADING CARDS, GREETING CARDS, NOTE CARDS, POSTCARDS AND BLANK CARDS; STATIONERY, WRITING PAPER, NOTE PADS, NOTEBOOKS, ADDRESS BOOKS, APPOINTMENT BOOKS, COMPOSITION BOOKS, DAILY PLANNERS, DIARIES AND SCRAPBOOK ALBUMS; BOOK COVERS, FOLDERS AND BINDERS; BOOKMARKS; WRITING IMPLEMENTS, NAMELY, PENS, PENCILS, ERASERS, MARKERS, CRAYONS AND CHALK; RUBBER STAMPS AND STAMP PADS; PAPER AND PAPER ARTICLES, NAMELY, PAPER GIFT WRAP AND WRAPPING PAPER; PAPER BAGS; TISSUE PAPER; AND PAPER PARTY GOODS, NAMELY, PARTY HATS, PAPER CAKE DECORATIONS, PARTY DECORATIONS, NAPKINS, TABLE CLOTHS, PLACE MATS AND DECORATIVE CENTERPIECES (U.S. CLS. 2, 5, 22, 23, 29, 37, 38 AND 50).
KATHERINE E. HALMEN, EXAMINING ATTORNEY

CLASS 16—(Continued).

SN 76-657,810. EIDE, SCOTT, BISMARCK, ND. FILED 4-3-2006.

CHICAGO BOB

THE MARK CONSISTS OF STANDARD CHARACTERS WITHOUT CLAIM TO ANY PARTICULAR FONT, STYLE, SIZE, OR COLOR.

THE NAME CHICAGO BOB DOES NOT IDENTIFY A LIVING INDIVIDUAL.

FOR PRINTED MATTER AND PAPER GOODS, NAMELY, CHILDREN'S BOOKS; COLORING BOOKS; STICKER BOOKS; STICKERS; CHILDREN'S ACTIVITY BOOKS; STATIONERY; WRITING PAPER; NOTEBOOKS; GREETING CARDS; TRADING CARDS; PENS, PENCILS AND CASES THEREFOR; ERASERS; CRAYONS; MARKERS; COLORED PENCILS; DECALS; POSTERS; CALENDARS; GIFT WRAPPING PAPER; PAPER PARTY FAVORS AND PAPER PARTY GOODS, NAMELY, GIFT WRAPPING PAPER, PAPER INVITATIONS, PAPER NAPKINS, PAPER PLACEMATS, PAPER PARTY HATS, AND PAPER TABLECLOTHS (U.S. CLS. 2, 5, 22, 23, 29, 37, 38 AND 50).

FRED MANDIR, EXAMINING ATTORNEY

SN 76-658,379. AMERICAN TRANSPORTATION INSTITUTE, INC., FALLS CHURCH, VA. FILED 4-13-2006.

THE AMERICAN DREAM STARTS HERE

THE MARK CONSISTS OF STANDARD CHARACTERS WITHOUT CLAIM TO ANY PARTICULAR FONT, STYLE, SIZE, OR COLOR.

FOR PRINTED MATTER, NAMELY, INSTRUCTIONAL TEACHING AND TRAINING MANUALS, REFERENCE BOOKS, WORKBOOKS, TEXTBOOKS, CATALOGS, MANUSCRIPTS, CLASSROOM AND INDEPENDENT STUDY GUIDES, PAMPHLETS, LEAFLETS, DIRECTORIES, CALENDARS, BROCHURES, CHARTS, FACT SHEETS, PRACTICE SHEETS AND FOLIOS RELATING TO POST-SECONDARY AND COLLEGE LEVEL ACCREDITED AND CERTIFIED COURSES OF INSTRUCTION (U.S. CLS. 2, 5, 22, 23, 29, 37, 38 AND 50).

ELLEN B. AWRICH, EXAMINING ATTORNEY

SN 76-658,612. SANJEF, LLC, VENICE, FL. FILED 4-10-2006.

SHARKBUNNY

FOR CHILDREN'S BOOKS (U.S. CLS. 2, 5, 22, 23, 29, 37, 38 AND 50).

STANLEY I. OSBORNE, EXAMINING ATTORNEY

CLASS 16—(Continued).

SN 76-658,648. LA PRENSA GRAFICA, INC., LOS ANGELES, CA. FILED 4-18-2006.

LO HACEMOS POR DEPORTE

THE MARK CONSISTS OF STANDARD CHARACTERS WITHOUT CLAIM TO ANY PARTICULAR FONT, STYLE, SIZE, OR COLOR.

THE ENGLISH TRANSLATION OF "LO HACEMOS POR DEPORTE" IS "WE DO IT FOR SPORT".

FOR PRINTED PERIODICALS IN THE SPANISH LANGUAGE FOCUSING ON SPORTS REPORTING, EDITORIALS ON SPORTS, AND SPORTS TRIVIA (U.S. CLS. 2, 5, 22, 23, 29, 37, 38 AND 50).

FIRST USE 2-13-2006; IN COMMERCE 2-13-2006.
MAUREEN DALL, EXAMINING ATTORNEY

CLASS 16—(Continued).

SN 78-323,551. BAYARD PRESSE (CANADA) INC, MONTREAL, QC, CANADA, FILED 11-5-2003.

OWLKIDS

SN 76-658,771. LIFEWAY CHRISTIAN RESOURCES OF THE SOUTHERN BAPTIST CONVENTION, NASHVILLE, TN. FILED 4-20-2006.

ENGAGE 365

THE MARK CONSISTS OF STANDARD CHARACTERS WITHOUT CLAIM TO ANY PARTICULAR FONT, STYLE, SIZE, OR COLOR.

FOR CHURCH SUPPLY PRODUCTS FOR MARKETING AND COMMUNICATION PRODUCTS, NAMELY, CHURCH INDOOR-OUTDOOR PAPER BANNERS, WEEKLY BULLETINS CONCERNING CHURCH AND WORSHIP INFORMATION, POSTCARDS, PAPER DOORKNOB HANGERS, VISITOR CARDS (U.S. CLS. 2, 5, 22, 23, 29, 37, 38 AND 50).

DAVID MILLER, EXAMINING ATTORNEY

THE MARK CONSISTS OF STANDARD CHARACTERS WITHOUT CLAIM TO ANY PARTICULAR FONT, STYLE, SIZE, OR COLOR.

PRIORITY CLAIMED UNDER SEC. 44(D) ON CANADA APPLICATION NO. 1179826, FILED 6-2-2003, REG. NO. TMA669,444, DATED 8-8-2006, EXPIRES 8-8-2021.

FOR PUBLICATIONS, NAMELY, MAGAZINES, BOOKS, PERIODICALS, NEWSPAPERS, NEWSLETTERS, COMIC BOOKS, BROCHURES, CATALOGUES, THEATRE PROGRAMS, PAMPHLETS FEATURING CHILDREN'S STORIES AND ACTIVITIES; STATIONERY, NAMELY, CALENDARS, PAPER PADS, ENVELOPES, RECIPE CARDS, PAPER LABELS, NAME TAGS, PAPER IDENTIFICATION TAGS, COUPONS, NOTEBOOKS, NOTEPADS, DAYBOOKS, SHOPPING GUIDE, GREETING CARDS, ADDRESS BOOKS, WRITING PAPER, NOVELTY ITEMS, NAMELY, STICKERS, GIFT BOXES, GIFT WRAP, DECALS, PRINTED MATERIAL, NAMELY, FLYERS FEATURING CHILDREN'S STORIES AND ACTIVITIES, PHOTOGRAPHS, POSTCARDS, COLLECTOR'S ALBUMS, PRINTED GUIDES FEATURING EDUCATIONAL SUBJECTS, COMIC STRIPS, COLOURING BOOKS, GROWTH CHARTS, FOOD GUIDES, MAPS, MENUS, BUMPER STICKERS, PICTURES, MURALS, POSTERS, PAPER BANNERS; SCHOOL AND OFFICE SUPPLIES, NAMELY, BOOK MARKS, PENS, PENCILS, MARKERS, INDEX DIVIDERS, BOOKCOVERS, BOOKENDS, FILE FOLDERS, BULLETIN BOARDS, CARDHOLDERS, HOLDERS FOR BUSINESS CARDS, WRITING PAPER HOLDERS, DOCUMENT CASES MADE OF CARDBOARD, ERASERS, PAPER CLIPS, GUEST BOOKS, PAPERWEIGHTS, PENCIL BOXES, PENCIL CASES, PENCIL SHARPENERS, PLACE CARDS, DIARIES, LETTER OPENERS, DRAWING RULERS, PHOTO ALBUMS, STAMP BOOKLETS, DECORATIVE PAPER, SHELF PAPER, CONTACT PAPER, CALENDAR HOLDERS, PAINTBRUSHES, ARTS AND CRAFTS PAINT KITS, CRAYONS, COLOURING PENCILS, ADHESIVE TAPE DISPENSERS FOR HOUSEHOLD OR STATIONERY USE, PAPER LABEL HOLDERS, DAYBOOK HOLDERS, RUBBER STAMPS, ADHESIVE STAMPS, NON-POSTAL ADHESIVE STAMPS, STAMP DISPENSERS, ADHESIVE-BACKED NUMBERS FOR USE IN MAKING SIGNS AND POSTERS; PARTY ACCESSORIES, NAMELY, PAPER HATS, PAPER PARTY FAVORS IN THE NATURE OF HORNS, AND PARTY FAVOURS AND INVITATIONS MADE OF PAPER (U.S. CLS. 2, 5, 22, 23, 29, 37, 38 AND 50).

JAMES A. RAUEN, EXAMINING ATTORNEY

SN 78-259,002. CURTCO MEDIA LABS, LLC, MALIBU, CA. FILED 6-5-2003.

CURTCO'S DIGITAL TV

NO CLAIM IS MADE TO THE EXCLUSIVE RIGHT TO USE DIGITAL TV, APART FROM THE MARK AS SHOWN.

FOR MAGAZINES FEATURING DIGITAL TELEVISIONS, DIGITAL TELEVISION TECHNOLOGY, ELECTRONICS RELATED TO DIGITAL TELEVISIONS, AND CONSUMER INFORMATION RELATED TO DIGITAL TELEVISIONS, TECHNOLOGY AND ELECTRONICS, FOR GENERAL CIRCULATION (U.S. CLS. 2, 5, 22, 23, 29, 37, 38 AND 50).

PAM WILLIS, EXAMINING ATTORNEY

CLASS 16—(Continued).

SN 78-326,389. BOMB SQUAD, LLC, FAIRFIELD, CT. FILED 11-12-2003.

THE BOMB SQUAD

THE MARK CONSISTS OF STANDARD CHARACTERS WITHOUT CLAIM TO ANY PARTICULAR FONT, STYLE, SIZE, OR COLOR.

OWNER OF U.S. REG. NO. 3,081,601.

SEC. 2(F).

FOR PAPER GOODS AND PRINTED MATTER, NAMELY, POSTERS, DECALS, POSTCARDS, CONCERT PROGRAMS AND STICKERS IN THE FIELD OF MUSICAL ENTERTAINMENT, ALL RELATING TO MUSICAL PERFORMANCES BY A MUSICAL GROUP (U.S. CLS. 2, 5, 22, 23, 29, 37, 38 AND 50).

FIRST USE 2-1-2001; IN COMMERCE 2-1-2001.

ANNE MADDEN, EXAMINING ATTORNEY

CLASS 16—(Continued).

SN 78-507,698. AMERICAN GRAPHICS GROUP, LLC, BERNE, IN. FILED 10-28-2004.

DRIVING FORCE

THE MARK CONSISTS OF STANDARD CHARACTERS WITHOUT CLAIM TO ANY PARTICULAR FONT, STYLE, SIZE, OR COLOR.

OWNER OF U.S. REG. NO. 2,250,580.

FOR MAGAZINE DEVOTED TO THE TRUCKING INDUSTRY (U.S. CLS. 2, 5, 22, 23, 29, 37, 38 AND 50).

FIRST USE 12-31-1997; IN COMMERCE 12-31-1997.

ALICIA COLLINS, EXAMINING ATTORNEY

SN 78-535,134. CMP MEDIA LLC, MANHASSET, NY. FILED 12-19-2004.

SN 78-418,816. TRUSTEES OF FIDELITY INVESTMENTS CHARITABLE GIFT FUND, BOSTON, MA. FILED 5-14-2004.

**CSI COMPUTER
SECURITY INSTITUTE****THE BENEFACTOR**

THE MARK CONSISTS OF STANDARD CHARACTERS WITHOUT CLAIM TO ANY PARTICULAR FONT, STYLE, SIZE, OR COLOR.

SEC. 2(F).

FOR NEWSLETTERS IN THE FIELD OF PHILANTHROPY AND SUBJECTS RELATING TO DONOR-ADVISED FUNDS FOR CHARITABLE PURPOSES (U.S. CLS. 2, 5, 22, 23, 29, 37, 38 AND 50).

FIRST USE 11-0-1993; IN COMMERCE 11-0-1993.

JOANNA DUKOVIC, EXAMINING ATTORNEY

THE MARK CONSISTS OF STANDARD CHARACTERS WITHOUT CLAIM TO ANY PARTICULAR FONT, STYLE, SIZE, OR COLOR.

OWNER OF U.S. REG. NOS. 3,041,559, 3,041,560 AND 3,041,562.

SEC. 2(F) AS TO "COMPUTER SECURITY INSTITUTE".

FOR PRINTED PUBLICATIONS, NAMELY, MAGAZINES, NEWSLETTERS AND JOURNALS IN THE FIELDS OF INFORMATION TECHNOLOGY, COMPUTER SECURITY AND NETWORK SECURITY (U.S. CLS. 2, 5, 22, 23, 29, 37, 38 AND 50).

FIRST USE 1-31-1997; IN COMMERCE 1-31-1997.

WENDY GOODMAN, EXAMINING ATTORNEY

CLASS 16—(Continued).

SN 78-538,556. CMP MEDIA LLC, MANHASSET, NY. FILED 12-27-2004.



C O M P U T E R
S E C U R I T Y
I N S T I T U T E

OWNER OF U.S. REG. NOS. 3,041,559, 3,041,560 AND 3,041,562.

SEC. 2(F) AS TO "COMPUTER SECURITY INSTITUTE". FOR PRINTED PUBLICATIONS, NAMELY, MAGAZINES, NEWSLETTERS AND JOURNALS IN THE FIELDS OF INFORMATION TECHNOLOGY, COMPUTER SECURITY AND NETWORK SECURITY (U.S. CLS. 2, 5, 22, 23, 29, 37, 38 AND 50).

FIRST USE 1-31-1997; IN COMMERCE 1-31-1997.
WENDY GOODMAN, EXAMINING ATTORNEY

SN 78-578,700. NEWPAGE CORPORATION, DAYTON, OH. FILED 3-2-2005.



THE COLORS WHITE AND RED ARE CLAIMED AS A FEATURE OF THE MARK.

THE TOP PAGE OF THE DESIGN APPEARS IN WHITE WITH A RED BORDER. THE SECOND PAGE APPEARS IN THE COLOR RED.

THE MARK CONSISTS OF A STYLIZED "TURNING PAGE" DESIGN.

FOR PAPER, NAMELY, PRINTING PAPER, PRINTING PAPER COMPRISED WHOLLY OF WOOD FIBERS, BOOK PAPER, CATALOGUE PAPER, LETTERLESS PAPER, WEB OFFSET PAPER, LITHOGRAPHIC PAPER, GRAVURE PAPER, WRITING PAPER, ENVELOPE PAPER, PAPETERIES, GREETING CARD PAPER, BUSINESS PAPERS, CONVERTING PAPERS, PRINTED READY-TO-CLIP ARTWORK FOR REPRODUCTION, MAGNETIC PAPERS TO BE SOLD INTO THE COMMERCIAL PRINTING MARKET, SECURITY PAPERS, NAMELY PAPER FOR CHECKS, BUSINESS DOCUMENTS AND SECURE DOCUMENTS, COATED PRINTING PAPER FOR COMMERCIAL PRINTED APPLICATIONS, COATED PAPER FOR ELECTROSTATIC, DIGITAL IMAGING, AND INK JET AND PHOTOGRAPHIC INK JET PRINTING DEVICES, SURFACE COATED ENGRAVING PAPER, COATED CONVERTING PAPER, COATED OFFSET PAPER WITH A

CLASS 16—(Continued).

DULL, GLOSS, MATTE, AND/OR CAST COATED FINISH, COATED PRINTING AND CONVERTED PAPER FOR THE LABEL AND RELEASE MARKET, COATED LITHOGRAPHIC PAPER, COATED BOOK AND MAGAZINE PAPER, UNCOATED OFFSET AND BOND PAPER AND LEDGER PAPER, UNCOATED PRINTING AND WRITING PAPER, UNCOATED PRINTING AND CONVERTED PAPER FOR THE LABEL AND RELEASE MARKET, CARBONLESS PAPER AND CARBONLESS COPY PAPER, AND COATED PAPER USED FOR LABELS, WRAPS, BOOK DUST JACKETS, ENVELOPES, BASE SHEET FOR METALLIZING, BASE SHEET FOR LAMINATION, BASE SHEET FOR SILICONE COATED RELEASE LINERS, FACING SHEET FOR SELF ADHESIVE LAMINATION, COATED CONVERTING PAPERS, COATED PAPER FOR LAMINATION, PHOTOGRAPHIC BASESTOCK PAPER NOT CHEMICALLY TREATED WITH SILVER HALIDE; PUBLICATIONS, MANUALS AND PAMPHLETS RELATING TO PAPER AND PRINTING, NAMELY, RELATING TO COMMERCIAL BUSINESS AND SPECIFIERS WHO USE PRINTED COLLATERAL MATERIAL IN THEIR BUSINESS, PRODUCT INFORMATION ABOUT CARBONLESS COPY PAPER, PAPER MANUFACTURING AND PRINT PRODUCTION (U.S. CLS. 2, 5, 22, 23, 29, 37, 38 AND 50).

JILL PRATER, EXAMINING ATTORNEY

SN 78-602,808. HMP COMMUNICATIONS, LLC, MALVERN, PA. FILED 4-6-2005.

ECPN
EXTENDED CARE PRODUCT NEWS

THE MARK CONSISTS OF STANDARD CHARACTERS WITHOUT CLAIM TO ANY PARTICULAR FONT, STYLE, SIZE, OR COLOR.

SEC. 2(F).

FOR MAGAZINES, BROCHURES, PAMPHLETS AND NEWSLETTERS FOR HEALTH CARE PROFESSIONALS IN THE FIELDS OF ACUTE, LONG-TERM AND HOME CARE (U.S. CLS. 2, 5, 22, 23, 29, 37, 38 AND 50).

FIRST USE 0-0-1987; IN COMMERCE 0-0-1987.

GEOFFREY FOSDICK, EXAMINING ATTORNEY

CLASS 16—(Continued).

SN 78-611,634. MEMORY CROSS, INC., HIGH POINT, NC.
FILED 4-19-2005.

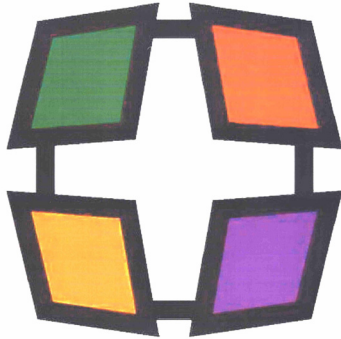

THE COLOR(S) GREEN, YELLOW, PURPLE, ORANGE, BLACK, AND WHITE IS/ARE CLAIMED AS A FEATURE OF THE MARK.

THE MARK CONSISTS OF THE COLOR WHITE APPEARS IN THE SHAPE OF A CROSS OUTLINED IN BLACK, THE COLOR GREEN APPEARS IN THE UPPER LEFT-HAND SQUARE, THE COLOR ORANGE APPEARS IN THE UPPER RIGHT-HAND SQUARE, THE COLOR YELLOW APPEARS IN THE LOWER LEFT-HAND SQUARE, THE COLOR PURPLE APPEARS IN THE LOWER RIGHT-HAND SQUARE, AND THE COLOR BLACK APPEARS IN THE OUTLINE OF THE CROSS AND THE SQUARES.

FOR MULTI-FOLD FLASH CARD USED TO MEMORIZE BIBLICAL SCRIPTURE AND SHOWCASE PRODUCTS AND SERVICES, NAMELY, GIFTWARE, HOUSEHOLD PRODUCTS, GIFT CARDS, MINISTERIAL SERVICES, AND OFFICE SUPPLIES (U.S. CLS. 2, 5, 22, 23, 29, 37, 38 AND 50).

FIRST USE 10-1-2004; IN COMMERCE 10-1-2004.
MYRIAH HABEEB, EXAMINING ATTORNEY

SN 78-615,240. SHINING SEA TRADING COMPANY, CENTERVILLE, UT. FILED 4-22-2005.



NO CLAIM IS MADE TO THE EXCLUSIVE RIGHT TO USE "TREE", APART FROM THE MARK AS SHOWN.

FOR BAGS, NAMELY, PLASTIC BAGS FOR STORING ARTIFICIAL CHRISTMAS TREES (U.S. CLS. 2, 5, 22, 23, 29, 37, 38 AND 50).

ARETHA SOMERVILLE, EXAMINING ATTORNEY

CLASS 16—(Continued).

SN 78-633,367. TOGETHER, INC., ST. ANTHONY, MN.
FILED 5-19-2005.

Together!

THE MARK CONSISTS OF STANDARD CHARACTERS WITHOUT CLAIM TO ANY PARTICULAR FONT, STYLE, SIZE, OR COLOR.

FOR NON-FICTION BOOKS ON A VARIETY OF RELIGIOUS TOPICS (U.S. CLS. 2, 5, 22, 23, 29, 37, 38 AND 50).

FIRST USE 6-0-2004; IN COMMERCE 6-0-2004.
KATHERINE STOIDES, EXAMINING ATTORNEY

SN 78-649,212. IMPACTO LLC, STAMFORD, CT. FILED 6-13-2005.

LAS ESTRELLAS NACEN AQUI

THE MARK CONSISTS OF STANDARD CHARACTERS WITHOUT CLAIM TO ANY PARTICULAR FONT, STYLE, SIZE, OR COLOR.

THE FOREIGN WORDING IN THE MARK TRANSLATES INTO ENGLISH AS THE STARS ARE BORN HERE.

FOR PAPER GOODS AND PRINTED MATTER, NAMELY, TRADING CARDS, POSTERS, STICKERS, DECALS, TEMPORARY TATTOOS, BUMPER STICKERS, SCORE BOOKS, SCORECARDS, PRINTED BASEBALL GAME PROGRAMS, MAGAZINES AND BOOKS FEATURING BASEBALL, NEWSLETTERS, BROCHURES AND PAMPHLETS FEATURING BASEBALL, WRITING PADS, NOTE PAPER, NOTEBOOKS, BINDERS, STATIONERY-TYPE PORTFOLIOS, STATIONERY FOLDERS, STATIONERY SETS, NAMELY, WRITING PAPER, CARDS, AND ENVELOPES, COMMEMORATIVE ENVELOPES, FLIP BOOKS, PREPRINTED AGENDA ORGANIZERS, MEMO BOARDS, SCRAPBOOKS, AUTOGRAPH BOOKS, BASEBALL CARD ALBUMS, BOOK COVERS, BOOKMARKS, BOOKENDS, CALENDARS, GREETING CARDS, POSTCARDS, PRINTED BANK CHECKBOOKS, CHECKBOOK COVERS, COLLECTIBLE STAMPS, RUBBER STAMPS, INK STAMPS, COMMEMORATIVE STAMPS, PAPER PENNANTS, GIFT WRAPPING PAPER, PAPER GIFT AND PARTY BAGS, PAPER PARTY GOODS IN THE NATURE OF PAPER PARTY DECORATIONS; PAPER COASTERS, PAPER NAPKINS, FACIAL TISSUE, PAPER TABLECLOTHS, MOUNTED AND UN-MOUNTED PHOTOGRAPHS, PHOTOGRAPH ALBUMS, LITHOGRAPHS, PLASTIC BASEBALL CARD HOLDERS AND COLLECTORS CASES, PAPERWEIGHTS, LETTER OPENERS, PENS, PENCILS, PENCIL TOP ORNAMENTS, CRAYONS, MARKERS, NON-ELECTRIC ERASERS, PENCIL SHARPENERS, PENCIL CASES, UN-GRADUATED RULERS, PAPER TICKET HOLDERS AND NON-METAL LANYARDS PROVIDED THEREWITH, ART PICTURES, ART PRINTS (U.S. CLS. 2, 5, 22, 23, 29, 37, 38 AND 50).

TINA BROWN, EXAMINING ATTORNEY

CLASS 16—(Continued).

SN 78-670,489. THE HAWORTH PRESS, INC., BINGHAMTON, NY. FILED 7-14-2005.

Administration in Social Work

THE MARK CONSISTS OF STANDARD CHARACTERS WITHOUT CLAIM TO ANY PARTICULAR FONT, STYLE, SIZE, OR COLOR.

SEC. 2(F).

FOR JOURNALS CONTAINING ARTICLES RELATING TO IMPROVING MANAGEMENT IN SOCIAL AGENCIES, BOOK AND LITERATURE REVIEWS, AND EXAMINATION OF THE ISSUES OF SOCIAL PROGRAM DEVELOPMENT, AFFIRMATIVE ACTION, ACCOUNTABILITY, BUDGETING, EMPLOYMENT AND PERSONNEL POLICIES, FINANCES AND ACCOUNTING, QUALITY IMPROVEMENT AND CONTROL, MONITORING AND LEGALITIES (U.S. CLS. 2, 5, 22, 23, 29, 37, 38 AND 50).

FIRST USE 6-20-1977; IN COMMERCE 6-20-1977.
JULIE GUTTADAURO, EXAMINING ATTORNEY

SN 78-672,199. THE HAWORTH PRESS, INC., BINGHAMTON, NY. FILED 7-18-2005.

Physical & Occupational Therapy in Pediatrics

THE MARK CONSISTS OF STANDARD CHARACTERS WITHOUT CLAIM TO ANY PARTICULAR FONT, STYLE, SIZE, OR COLOR.

SEC. 2(F).

FOR PUBLICATIONS NAMELY, QUARTERLY JOURNALS FEATURING ARTICLES RELATING TO THE CURRENT CLINICAL ADVANCES AND RESEARCH FINDINGS IN THERAPY, IMPLICATIONS AND APPLICATIONS FOR THERAPY PRACTICE, CASE REPORTS AND REVIEWS AND CRITIQUES OF NEW THERAPY MEASURES, TARGETED FOR AN AUDIENCE OF PEDIATRIC PROFESSIONALS IN HOSPITALS, REHABILITATION CENTERS, SCHOOLS AND HEALTH AND HUMAN SERVICE AGENCIES (U.S. CLS. 2, 5, 22, 23, 29, 37, 38 AND 50).

FIRST USE 4-21-1981; IN COMMERCE 4-21-1981.
RICHARD WHITE, EXAMINING ATTORNEY

CLASS 16—(Continued).

SN 78-674,199. THE HAWORTH PRESS, INC., BINGHAMTON, NY. FILED 7-20-2005.

Medical Reference Services Quarterly

THE MARK CONSISTS OF STANDARD CHARACTERS WITHOUT CLAIM TO ANY PARTICULAR FONT, STYLE, SIZE, OR COLOR.

NO CLAIM IS MADE TO THE EXCLUSIVE RIGHT TO USE "QUARTERLY", APART FROM THE MARK AS SHOWN.

SEC. 2(F).

FOR PUBLICATION CONTAINING PRACTICE-ORIENTED ARTICLES RELATING TO REFERENCE IN MEDICINE AND RELATED SPECIALTIES, THE BIOMEDICAL SCIENCES, NURSING AND ALLIED HEALTH, WITH AN EMPHASIS ON USER EDUCATION, DATABASE SEARCHING, ELECTRONIC INFORMATION, INFORMATICS EDUCATION, INFORMATION MANAGEMENT EDUCATION, MICROCOMPUTER APPLICATIONS TO LIBRARIES, AND END-USER SEARCHING (U.S. CLS. 2, 5, 22, 23, 29, 37, 38 AND 50).

FIRST USE 6-30-1982; IN COMMERCE 6-30-1982.

PAULA MAYS, EXAMINING ATTORNEY

SN 78-684,264. KIMBERLY-CLARK WORLDWIDE, INC., NEENAH, WI. FILED 8-3-2005.

SOFTMIST

THE MARK CONSISTS OF STANDARD CHARACTERS WITHOUT CLAIM TO ANY PARTICULAR FONT, STYLE, SIZE, OR COLOR.

FOR FACIAL TISSUE (U.S. CLS. 2, 5, 22, 23, 29, 37, 38 AND 50).

FIRST USE 1-6-2005; IN COMMERCE 1-6-2005.

ELLEN BURNS, EXAMINING ATTORNEY

SN 78-684,865. APOLLO PHOTO IMAGIZING, LLC, MILWAUKEE, WI. FILED 8-3-2005.

ILLUMA

THE MARK CONSISTS OF STANDARD CHARACTERS WITHOUT CLAIM TO ANY PARTICULAR FONT, STYLE, SIZE, OR COLOR.

FOR PRINTED PAPER PRODUCTS FEATURING PHOTOGRAPHIC IMAGES, NAMELY, MEMORY BOOKS, NOTE CARDS AND OCCASION CARDS FEATURING PHOTOGRAPHIC ART AND GREETING CARDS (U.S. CLS. 2, 5, 22, 23, 29, 37, 38 AND 50).

FIRST USE 7-27-2003; IN COMMERCE 7-27-2003.

SAIMA MAKHDOOM, EXAMINING ATTORNEY

CLASS 16—(Continued).

SN 78-685,463. ZENDEL, AZITA, LOS ANGELES, CA. FILED 8-4-2005.

HOW TO BREAK INTO HOLLYWOOD & SURVIVE THE TOXIC BOSS SYNDROME

THE MARK CONSISTS OF STANDARD CHARACTERS WITHOUT CLAIM TO ANY PARTICULAR FONT, STYLE, SIZE, OR COLOR.

FOR SERIES OF BOOKS AND MAGAZINES IN THE FIELD OF SELF-ESTEEM AND INSPIRATION AND IMPROVEMENT OF EMPLOYEE RELATIONS AND CAREER ISSUES (U.S. CLS. 2, 5, 22, 23, 29, 37, 38 AND 50).

FIRST USE 3-4-1997; IN COMMERCE 9-13-2002.
SEAN CROWLEY, EXAMINING ATTORNEY

SN 78-698,195. SMITH, CHRISTOPHER ALAN, LEANDER, TX. FILED 8-23-2005.



NO CLAIM IS MADE TO THE EXCLUSIVE RIGHT TO USE "BATTLEFIELD" "GOLIAD," "GONZALES," "SAN JACINTO," "THE ALAMO," "TEXAS," AND "ILLUSTRATED HISTORICAL MAPS", APART FROM THE MARK AS SHOWN.

THE COLORS DARK RED, BLUE, YELLOW AND GOLD ARE CLAIMED AS A FEATURE OF THE MARK.

THE MARK CONSISTS OF A STYLIZED OVAL CONTAINING THE WORDING "BATTLEFIELD", "GOLIAD", "GONZALES", "SAN JACINTO", AND "THE ALAMO" APPEARING IN YELLOW. THE WORD "TEXAS" APPEARS AT THE CENTER OF THE OVAL SUPERIMPOSED ON THE BATTLEMENT FIGURE AND IS IN RED BORDERED BY YELLOW. THE WORDING "ILLUSTRATED HISTORICAL MAPS" IS ON THE LOWER INSIDE OF THE OVAL AND IS RED. THE BACKGROUND IS BLUE AND GOLD; THE BATTLEMENT FIGURE, CANNONS BELOW AND SURROUNDING ELEMENTS ARE DARK RED. THE THREE STARS APPEARING ON THE BLUE BACKGROUND ARE GOLD. THE SIX STARS ACROSS THE BOTTOM OF THE OVAL DESIGN ARE YELLOW. A STAR APPEARS ABOVE THE OVAL AND IS RED BORDERED BY YELLOW.

FOR MAPS (U.S. CLS. 2, 5, 22, 23, 29, 37, 38 AND 50).
MICHAEL SOUDERS, EXAMINING ATTORNEY

CLASS 16—(Continued).

SN 78-699,596. MILES, BARBARA, DECATUR, GA. FILED 8-24-2005.

ChocolateSingles

THE MARK CONSISTS OF STANDARD CHARACTERS WITHOUT CLAIM TO ANY PARTICULAR FONT, STYLE, SIZE, OR COLOR.

FOR LIFESTYLE EDUCATIONAL PUBLICATIONS, NAMELY, TRAINING MANUALS IN THE FIELD OF INTERPERSONAL RELATIONSHIPS (U.S. CLS. 2, 5, 22, 23, 29, 37, 38 AND 50).

CHERYL CLAYTON, EXAMINING ATTORNEY

SN 78-701,018. NATIONAL SECURITY AGENCY, FT. MEADE, MD. FILED 8-26-2005.

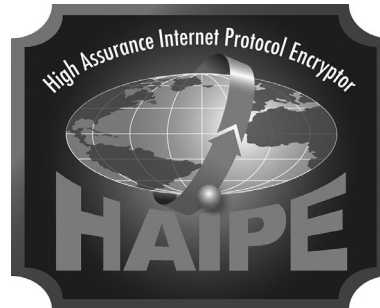

NO CLAIM IS MADE TO THE EXCLUSIVE RIGHT TO USE "HIGH ASSURANCE INTERNET PROTOCOL ENCRYPTOR", APART FROM THE MARK AS SHOWN.

THE MARK CONSISTS OF A SQUARE WITH CROPPED CORNERS ENCOMPASSING A GLOBE HAVING A V-CUT RIBBON WRAPPED AROUND IT WITH THE CURVED WORD HAiPE BENEATH AND THE WORDS HIGH ASSURANCE INTERNET PROTOCOL ENCRYPTOR ABOVE.

FOR MANUALS IN THE FIELD OF COMPUTER SECURITY (U.S. CLS. 2, 5, 22, 23, 29, 37, 38 AND 50).
LAURA HAMMEL, EXAMINING ATTORNEY

SN 78-711,066. TIGER LEASING LLC, NEW YORK, NY. FILED 9-12-2005.

LIFE IS FUN

THE MARK CONSISTS OF STANDARD CHARACTERS WITHOUT CLAIM TO ANY PARTICULAR FONT, STYLE, SIZE, OR COLOR.

FOR SERIES OF FICTION BOOKS (U.S. CLS. 2, 5, 22, 23, 29, 37, 38 AND 50).

ARETHA SOMERVILLE, EXAMINING ATTORNEY

CLASS 16—(Continued).

SN 78-712,401. ASSOCIATED KOI CLUBS OF AMERICA, INC., ORANGE, CA. FILED 9-14-2005.

KOI USA

THE MARK CONSISTS OF STANDARD CHARACTERS WITHOUT CLAIM TO ANY PARTICULAR FONT, STYLE, SIZE, OR COLOR.

NO CLAIM IS MADE TO THE EXCLUSIVE RIGHT TO USE "KOI", APART FROM THE MARK AS SHOWN.

SEC. 2(F).

FOR MAGAZINES FEATURING PHOTOGRAPHS AND ARTICLES ABOUT KOI FISH (U.S. CLS. 2, 5, 22, 23, 29, 37, 38 AND 50).

FIRST USE 2-1-1992; IN COMMERCE 2-1-1992.

ELIZABETH J. WINTER, EXAMINING ATTORNEY

SN 78-712,651. SCRIMAGES, INC., SYRACUSE, UT. FILED 9-14-2005.

SCRIMAGES

THE MARK CONSISTS OF STANDARD CHARACTERS WITHOUT CLAIM TO ANY PARTICULAR FONT, STYLE, SIZE, OR COLOR.

FOR PAPER GOODS AND PRINTED MATTER, NAMELY, SCRAPBOOK EMBELLISHMENTS, NAMELY, DECORATIVE PAPER, STICKERS, SCRAPBOOK PAGES, PAPER WITH PRINTED DESIGNS, AND PAPER DIE CUT SHAPES (U.S. CLS. 2, 5, 22, 23, 29, 37, 38 AND 50).

ELLEN BURNS, EXAMINING ATTORNEY

SN 78-713,152. ACTS 1:8 MINISTRY, INCORPORATED, GREEN BAY, WI. FILED 9-14-2005.

P.A.C.K.

THE MARK CONSISTS OF STANDARD CHARACTERS WITHOUT CLAIM TO ANY PARTICULAR FONT, STYLE, SIZE, OR COLOR.

FOR EDUCATIONAL PUBLICATIONS, NAMELY TRAINING MANUALS, PRINTED PROGRAM GUIDES, AND OTHER PRINTED MATERIALS, NAMELY PAMPHLETS, HANDBOOKS, AND IDEA CARDS, IN THE FIELD OF CHRISTIAN EVANGELISM AND OUTREACH (U.S. CLS. 2, 5, 22, 23, 29, 37, 38 AND 50).

FIRST USE 11-20-2002; IN COMMERCE 11-20-2002.

SARA THOMAS, EXAMINING ATTORNEY

CLASS 16—(Continued).

SN 78-714,023. THE HAWORTH PRESS, INC., BINGHAMTON, NY. FILED 9-15-2005.

Internet Reference Services Quarterly

THE MARK CONSISTS OF STANDARD CHARACTERS WITHOUT CLAIM TO ANY PARTICULAR FONT, STYLE, SIZE, OR COLOR.

NO CLAIM IS MADE TO THE EXCLUSIVE RIGHT TO USE "QUARTERLY", APART FROM THE MARK AS SHOWN.

SEC. 2(F).

FOR JOURNAL CONTAINING ARTICLES RELATING TO EMERGING TECHNOLOGICAL INNOVATIONS, AND THE THEORETICAL, RESEARCH, AND PRACTICAL APPLICATIONS OF INTERNET-RELATED INFORMATION SERVICES, SOURCES, AND RESOURCES, AND THE TOPICS OF COURSE MANAGEMENT SYSTEMS, BLOGS, STATISTICAL PACKAGES AND ANALYZERS, WEB TUTORIALS, STREAMING VIDEO AND AUDIO, LIBRARY WEB SITE INNOVATIONS, DIGITAL AND CHAT REFERENCE, DIGITAL COLLECTIONS AND DIGITAL OBJECT REPOSITORIES, INTERNET AND COPYRIGHT LAW, LINK RESOLVERS, FEDERATED SEARCHING TECHNOLOGIES, MANAGEMENT OF ELECTRONIC RESOURCES, INFORMATION TECHNOLOGY (IT) LIBRARY MERGERS, INTERNET SECURITY, CARRY-ALONG COLLECTIONS ON HANDHELD DEVICES, ARCHIVE, CATALOG, COLLECTION DEVELOPMENT, AND CIRCULATION ISSUES, AND INSTRUCTION AND DISTANCE EDUCATION (U.S. CLS. 2, 5, 22, 23, 29, 37, 38 AND 50).

FIRST USE 8-28-1996; IN COMMERCE 8-28-1996.

JOHN SCHUYLER YARD, EXAMINING ATTORNEY

SN 78-715,459. LUVINCOM, LLC, HIALEAH, FL. FILED 9-19-2005.

LUVINCOM

THE MARK CONSISTS OF STANDARD CHARACTERS WITHOUT CLAIM TO ANY PARTICULAR FONT, STYLE, SIZE, OR COLOR.

FOR EXTERIOR HOME DESIGN ITEMS AND INTERIOR HOME DESIGN ITEMS, NAMELY MURALS AND MURAL ASSEMBLY KITS COMPRISED OF MOUNTING HARDWARE, FRAMING HARDWARE AND THREE-DIMENSIONAL EXTENSION PIECES ALL SOLD AS A UNIT (U.S. CLS. 2, 5, 22, 23, 29, 37, 38 AND 50).

JEFF DEFORD, EXAMINING ATTORNEY

CLASS 16—(Continued).

SN 78-718,006. UNITED STATES ACADEMIC DECATHLON ASSOCIATION, LOS ALAMITOS, CA. FILED 9-21-2005.

ACADEMIC DECATHLON

THE MARK CONSISTS OF STANDARD CHARACTERS WITHOUT CLAIM TO ANY PARTICULAR FONT, STYLE, SIZE, OR COLOR.

OWNER OF U.S. REG. NO. 2,655,356.
SEC. 2(F).

FOR FLASH CARDS, BOOKLETS OF ART REPRODUCTIONS, COACH HANDBOOKS, STUDENT WORKBOOKS AND PRACTICE TESTS DIRECTED TO ACADEMIC COMPETITIONS, AND STUDY GUIDES (U.S. CLS. 2, 5, 22, 23, 29, 37, 38 AND 50).

FIRST USE 0-0-1981; IN COMMERCE 0-0-1981.
MARIA-VICTORIA SUAREZ, EXAMINING ATTORNEY

SN 78-718,637. STEVENS, ROGER, BAKERSFIELD, CA. FILED 9-22-2005.

**TRADITIONAL ROD & KULTURE
ILLUSTRATED**

THE MARK CONSISTS OF STANDARD CHARACTERS WITHOUT CLAIM TO ANY PARTICULAR FONT, STYLE, SIZE, OR COLOR.

NO CLAIM IS MADE TO THE EXCLUSIVE RIGHT TO USE "ILLUSTRATED", APART FROM THE MARK AS SHOWN.

FOR MAGAZINES, SPECIFICALLY FEATURING AUTOMOBILES, AUTOMOBILE MODIFICATION, AUTOMOBILE PARTS, AUTOMOBILE REVIEWS, MOTORCYCLES, TATTOOS AND MUSIC REVIEWS (U.S. CLS. 2, 5, 22, 23, 29, 37, 38 AND 50).

FIRST USE 3-1-2005; IN COMMERCE 3-1-2005.
CHRISIE B. KING, EXAMINING ATTORNEY

SN 78-718,837. RANTA, SUSAN, LINCOLN, NE. FILED 9-22-2005.

SET YOUR TABLE

THE MARK CONSISTS OF STANDARD CHARACTERS WITHOUT CLAIM TO ANY PARTICULAR FONT, STYLE, SIZE, OR COLOR.

OWNER OF U.S. REG. NO. 2,129,098.

FOR DIRECTORIES OF TABLEWARE, MATCHING SERVICES AND DEALERS INTERNATIONALLY (U.S. CLS. 2, 5, 22, 23, 29, 37, 38 AND 50).

FIRST USE 2-1-1995; IN COMMERCE 2-1-1995.
LAURIE KAUFMAN, EXAMINING ATTORNEY

CLASS 16—(Continued).

SN 78-720,845. THE ORPHANAGE, INC., SAN FRANCISCO, CA. FILED 9-26-2005.

ORPHANAGE ANIMATION STUDIOS

THE MARK CONSISTS OF STANDARD CHARACTERS WITHOUT CLAIM TO ANY PARTICULAR FONT, STYLE, SIZE, OR COLOR.

OWNER OF U.S. REG. NO. 2,683,844.

NO CLAIM IS MADE TO THE EXCLUSIVE RIGHT TO USE "ANIMATION STUDIOS", APART FROM THE MARK AS SHOWN.

FOR PAPER GOODS AND PRINTED MATTER, NAMELY, COMIC BOOKS AND MAGAZINES FEATURING COMIC STRIPS AND SHEET MUSIC, FICTION, NON-FICTION, SCIENCE FICTION, MYSTERY, FAIRY TALES, ROMANCE, COMEDY, DRAMA, MUSICALS AND FANTASY THEMES, STORIES AND CHARACTERS; COMIC BOOK REFERENCE GUIDE BOOKS; A SERIES OF BOOKS AND NOVELIZATIONS FEATURING STORIES ON COMIC STRIPS AND MUSIC, ANIMATED AND LIVE-ACTION PERFORMANCES, FICTION, NON-FICTION, SCIENCE FICTION, MYSTERY, FAIRY TALES, ROMANCE, COMEDY, DRAMA, MUSICALS AND FANTASY THEMES, STORIES AND CHARACTERS IN ILLUSTRATED FORMS; NOVELS FEATURING GRAPHICAL ILLUSTRATIONS; GRAPHIC NOVELS; NOVELS; PRINTED POSTCARDS; PICTURE POSTCARDS; COMIC POSTCARDS; POSTCARDS; TRADING CARDS AND COLLECTORS CARDS FEATURING COMIC BOOK, COMIC STRIP, CARTOON, ANIMATED AND LIVE ACTION CHARACTERS; NOTEBOOKS; BINDERS; DECALS; STICKERS; POSTERS; PHOTOGRAPH AND SCRAPBOOK ALBUMS; CALENDARS; GREETING CARDS; FOLDERS; DESK PADS; WRITING PADS; STATIONERY FOLDERS AND STATIONERY; PENS; PENCILS; ERASERS; VIDEO GAME STRATEGY MANUALS AND BOOKS ON VIDEO GAME STRATEGY; COMPUTER GAME INSTRUCTION MANUALS AND STRATEGY BOOKS; COFFEE TABLE BOOKS (U.S. CLS. 2, 5, 22, 23, 29, 37, 38 AND 50).

JENNIFER KRISP, EXAMINING ATTORNEY

SN 78-726,435. FRIENDS OF THE SCHINDLER HOUSE, WEST HOLLYWOOD, CA. FILED 10-4-2005.

**FRIENDS OF THE SCHINDLER
HOUSE**

THE MARK CONSISTS OF STANDARD CHARACTERS WITHOUT CLAIM TO ANY PARTICULAR FONT, STYLE, SIZE, OR COLOR.

FOR PENS, PENCILS, ERASERS, NOTEBOOKS, FOLDERS, PAPER BANNERS, POSTERS, COLORING BOOKS, SELF-ADHESIVE STICKERS, PAPER CLIPS, BOOKMARKS, BUMPER STICKERS, PRINTED STORE DIRECTORY AND PRINTED INFORMATION GUIDES, MAPS, TRAVEL BOOKS, ART PRINTS, AND GRAPHIC ART REPRODUCTIONS (U.S. CLS. 2, 5, 22, 23, 29, 37, 38 AND 50).

KATRINA EDGE, EXAMINING ATTORNEY

CLASS 16—(Continued).

SN 78-730,185. AMERICAN COLLEGE OF HEALTHCARE EXECUTIVES, CHICAGO, IL. FILED 10-10-2005.

**JOURNAL OF HEALTHCARE
MANAGEMENT**

THE MARK CONSISTS OF STANDARD CHARACTERS WITHOUT CLAIM TO ANY PARTICULAR FONT, STYLE, SIZE, OR COLOR.

NO CLAIM IS MADE TO THE EXCLUSIVE RIGHT TO USE "JOURNAL", APART FROM THE MARK AS SHOWN. SEC. 2(F).

FOR PRINTED PUBLICATIONS, NAMELY, JOURNALS IN THE AREA OF HEALTHCARE MANAGEMENT (U.S. CLS. 2, 5, 22, 23, 29, 37, 38 AND 50).

FIRST USE 1-0-1998; IN COMMERCE 1-0-1998.

JENNY PARK, EXAMINING ATTORNEY

CLASS 16—(Continued).

SN 78-742,253. PENTAIR WATER POOL AND SPA, INC., MOORPARK, CA. FILED 10-28-2005.

PENTAIR EDGEUCATION

THE MARK CONSISTS OF STANDARD CHARACTERS WITHOUT CLAIM TO ANY PARTICULAR FONT, STYLE, SIZE, OR COLOR.

FOR PRINTED EDUCATIONAL AND TEACHING MATERIALS IN THE FIELD OF POOL AND SPA EQUIPMENT (U.S. CLS. 2, 5, 22, 23, 29, 37, 38 AND 50).

FIRST USE 6-30-2005; IN COMMERCE 6-30-2005.

KIMBERLY PERRY, EXAMINING ATTORNEY

SN 78-731,554. MARTZ, VERNILYN, COLORADO SPRINGS, CO. FILED 10-12-2005.

**KITCHEN TALK: SOUL STORIES
AND LIFE RECIPES**

THE MARK CONSISTS OF STANDARD CHARACTERS WITHOUT CLAIM TO ANY PARTICULAR FONT, STYLE, SIZE, OR COLOR.

FOR WRITTEN MATERIALS, NAMELY RESPITE CARE MANUALS, COMMUNICATION MANUALS FOR THERAPY GROUPS AND COMMUNICATION EDUCATION COACHING, PRAYERS AND POEMS, AND SPIRITUAL DEVELOPMENT MATERIALS NAMELY, PRAYERS, POEMS, JOURNALS AND WORKBOOKS FOR SPIRITUAL FORMATION (U.S. CLS. 2, 5, 22, 23, 29, 37, 38 AND 50).

KATHERINE M. DUBRAY, EXAMINING ATTORNEY

SN 78-746,462. VIRGO PUBLISHING, LLC, PHOENIX, AZ. FILED 11-3-2005.

FOOD PRODUCT DESIGN

THE MARK CONSISTS OF STANDARD CHARACTERS WITHOUT CLAIM TO ANY PARTICULAR FONT, STYLE, SIZE, OR COLOR.

SEC. 2(F).

FOR MAGAZINES FEATURING FOOD PROCESSING (U.S. CLS. 2, 5, 22, 23, 29, 37, 38 AND 50).

FIRST USE 4-15-1991; IN COMMERCE 4-15-1991.

DOMINIC FATHY, EXAMINING ATTORNEY

SN 78-736,854. COCA-COLA COMPANY, THE, ATLANTA, GA. FILED 10-20-2005.

MAKE EVERY DROP COUNT

THE MARK CONSISTS OF STANDARD CHARACTERS WITHOUT CLAIM TO ANY PARTICULAR FONT, STYLE, SIZE, OR COLOR.

FOR PUBLICATIONS, NAMELY PAMPHLETS, POSTERS AND NEWSLETTERS IN THE FIELD OF HEALTH, WELLNESS, FITNESS, LIFESTYLE AND BEVERAGE CHOICES (U.S. CLS. 2, 5, 22, 23, 29, 37, 38 AND 50).

SHANNON TWOHIG, EXAMINING ATTORNEY

SN 78-746,471. VIRGO PUBLISHING, LLC, PHOENIX, AZ. FILED 11-3-2005.

Food Product

DESIGN

SEC. 2(F).

FOR MAGAZINES FEATURING FOOD PROCESSING (U.S. CLS. 2, 5, 22, 23, 29, 37, 38 AND 50).

FIRST USE 4-15-1991; IN COMMERCE 4-15-1991.

DOMINIC FATHY, EXAMINING ATTORNEY

CLASS 16—(Continued).

SN 78-760,051. AVONDALE MEDICAL PUBLICATIONS, LLC, PLYMOUTH MEETING, PA. FILED 11-23-2005.

Derm Perspectives

THE MARK CONSISTS OF STANDARD CHARACTERS WITHOUT CLAIM TO ANY PARTICULAR FONT, STYLE, SIZE, OR COLOR.

NO CLAIM IS MADE TO THE EXCLUSIVE RIGHT TO USE "DERM", APART FROM THE MARK AS SHOWN.

FOR EDUCATIONAL PUBLICATIONS, NAMELY, TRAINING MANUALS IN THE FIELD OF DERMATOLOGY PHYSICIAN ASSISTANTS (U.S. CLS. 2, 5, 22, 23, 29, 37, 38 AND 50).

FIRST USE 11-12-2005; IN COMMERCE 11-12-2005.
TARAH HARDY, EXAMINING ATTORNEY

SN 78-772,362. LUTGERT, ERIK, FT. MYERS, FL. FILED 12-13-2005.

WAKESKATE LIFE

THE MARK CONSISTS OF STANDARD CHARACTERS WITHOUT CLAIM TO ANY PARTICULAR FONT, STYLE, SIZE, OR COLOR.

NO CLAIM IS MADE TO THE EXCLUSIVE RIGHT TO USE "WAKESKATE", APART FROM THE MARK AS SHOWN.

FOR MAGAZINES FEATURING WATER SPORTS (U.S. CLS. 2, 5, 22, 23, 29, 37, 38 AND 50).

ANNE MADDEN, EXAMINING ATTORNEY

SN 78-773,419. BOWTIE, INC., IRVINE, CA. FILED 12-14-2005.

PET PRODUCT NEWS INTERNATIONAL

THE MARK CONSISTS OF STANDARD CHARACTERS WITHOUT CLAIM TO ANY PARTICULAR FONT, STYLE, SIZE, OR COLOR.

OWNER OF U.S. REG. NOS. 1,698,574 AND 1,967,786.

NO CLAIM IS MADE TO THE EXCLUSIVE RIGHT TO USE "NEWS INTERNATIONAL", APART FROM THE MARK AS SHOWN.

SEC. 2(F) AS TO "PET PRODUCT NEWS".

FOR PRINTED PUBLICATIONS, NAMELY, MAGAZINES, IN THE FIELD OF PET PRODUCTS (U.S. CLS. 2, 5, 22, 23, 29, 37, 38 AND 50).

DOMINICK J. SALEMI, EXAMINING ATTORNEY

CLASS 16—(Continued).

SN 78-775,153. BOWTIE, INC., IRVINE, CA. FILED 12-16-2005.



OWNER OF U.S. REG. NOS. 1,698,574 AND 1,967,786.
NO CLAIM IS MADE TO THE EXCLUSIVE RIGHT TO USE "NEWS INTERNATIONAL", APART FROM THE MARK AS SHOWN.

SEC. 2(F) AS TO "PET PRODUCT NEWS".

FOR PRINTED PUBLICATIONS, NAMELY, MAGAZINES, IN THE FIELD OF PET PRODUCTS (U.S. CLS. 2, 5, 22, 23, 29, 37, 38 AND 50).

DOMINICK J. SALEMI, EXAMINING ATTORNEY

SN 78-776,128. STEELEY, ROBIN, VANCOUVER, WA. FILED 12-19-2005.

Crave Magazine

THE MARK CONSISTS OF STANDARD CHARACTERS WITHOUT CLAIM TO ANY PARTICULAR FONT, STYLE, SIZE, OR COLOR.

NO CLAIM IS MADE TO THE EXCLUSIVE RIGHT TO USE "MAGAZINE", APART FROM THE MARK AS SHOWN.

FOR MAGAZINES FEATURING COVERAGE OF LIVE MUSIC PERFORMANCES AND RECORDED MUSICAL ENTERTAINMENT (U.S. CLS. 2, 5, 22, 23, 29, 37, 38 AND 50).

FIRST USE 1-30-2004; IN COMMERCE 1-30-2004.

CAROL SPILS, EXAMINING ATTORNEY

SN 78-778,246. HARRISON, DAVID, JAMES, ALMA, MI. FILED 12-21-2005.

Skid Rodents

THE MARK CONSISTS OF STANDARD CHARACTERS WITHOUT CLAIM TO ANY PARTICULAR FONT, STYLE, SIZE, OR COLOR.

FOR COMIC MAGAZINES, COMIC BOOKS, GRAPHIC NOVELS, GREETING CARDS, CARDBOARD PACKAGING, PAPER POSTERS, BLISTER CARDS FOR PACKAGING, PAPER ENVELOPES, WRAPPING PAPER, PAPER BAGS FOR MERCHANDISE PACKAGING, BLANK CARDS, PAPER BANNERS, CARDBOARD OR PAPER LABELS, GIFT-WRAPPING PAPER, PAPER NAPKINS, PAPER NOTEBOOKS, PAPER GIFT BAGS, BOXES OF PAPER OR CARDBOARD, ADVERTISING SIGNS OF PAPER OR CARDBOARD (U.S. CLS. 2, 5, 22, 23, 29, 37, 38 AND 50).

FIRST USE 2-21-1993; IN COMMERCE 2-21-1993.

ALAIN LAPTER, EXAMINING ATTORNEY

CLASS 16—(Continued).

SN 78-779,644. VOIP SERVICES, INC, MIAMI, FL. FILED 12-22-2005.

LA CHIQUITI BUM

THE MARK CONSISTS OF STANDARD CHARACTERS WITHOUT CLAIM TO ANY PARTICULAR FONT, STYLE, SIZE, OR COLOR.

FOR PREPAID TELEPHONE CALLING CARDS, NOT MAGNETICALLY ENCODED (U.S. CLS. 2, 5, 22, 23, 29, 37, 38 AND 50).

ANN E. SAPPENFIELD, EXAMINING ATTORNEY

CLASS 16—(Continued).

SN 78-789,358. DURRE, LINNDA, WINTER PARK, FL. FILED 1-11-2006.

GREAT RELATIONSHIPS

THE MARK CONSISTS OF STANDARD CHARACTERS WITHOUT CLAIM TO ANY PARTICULAR FONT, STYLE, SIZE, OR COLOR.

OWNER OF U.S. REG. NO. 1,975,086.
SEC. 2(F).

FOR SERIES OF NON-FICTION BOOKS ON THE SUBJECT OF INSTRUCTION FOR PEOPLE WHO WISH TO HAVE BETTER RELATIONSHIPS WITH OTHERS (U.S. CLS. 2, 5, 22, 23, 29, 37, 38 AND 50).

FIRST USE 1-0-1993; IN COMMERCE 1-0-1993.
KRISTIN DAHLING, EXAMINING ATTORNEY

SN 78-785,282. PEASE, PAMELA, DBA PAINTBOX PRESS, CHAPEL HILL, NC. FILED 1-5-2006.

SN 78-791,758. PLAYDATE KIDS PUBLISHING, INC., MALIBU, CA. FILED 1-13-2006.

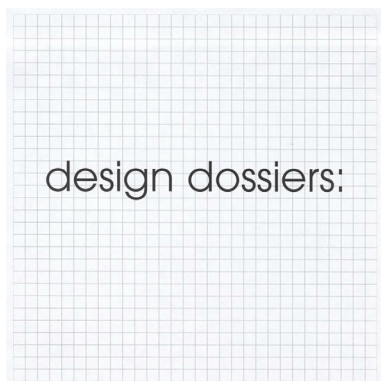

design dossiers:

NO CLAIM IS MADE TO THE EXCLUSIVE RIGHT TO USE DESIGN DOSSIERS, APART FROM THE MARK AS SHOWN.

THE COLOR(S) BLACK, WHITE, AND GREY IS/ARE CLAIMS AS A FEATURE OF THE MARK.

THE MARK CONSISTS OF GREY LINES AGAINST A WHITE BACKGROUND SPACED 1/4" APART BOTH VERTICALLY AND HORIZONTALLY TO FORM A GRID. ON THE GRID ARE THE WORDS "DESIGN DOSSIERS:" IN BLACK LETTERS.

FOR SERIES OF NON-FICTION BOOKS IN THE FIELD OF DESIGN (U.S. CLS. 2, 5, 22, 23, 29, 37, 38 AND 50).

FIRST USE 1-5-2006; IN COMMERCE 1-5-2006.
KATHERINE STOIDES, EXAMINING ATTORNEY

THE PLAYDATE KIDS

THE MARK CONSISTS OF STANDARD CHARACTERS WITHOUT CLAIM TO ANY PARTICULAR FONT, STYLE, SIZE, OR COLOR.

NO CLAIM IS MADE TO THE EXCLUSIVE RIGHT TO USE "KIDS", APART FROM THE MARK AS SHOWN.

FOR PRINTED MATTER AND PAPER GOODS—NAMESLY, BOOKS FEATURING CHARACTERS FROM ANIMATED, ACTION ADVENTURE, COMEDY AND/OR DRAMA FEATURES, COMIC BOOKS, CHILDREN'S BOOKS, MAGAZINES FEATURING CHARACTERS FROM ANIMATED, ACTION ADVENTURE, COMEDY AND/OR DRAMA FEATURES, COLORING BOOKS, CHILDREN'S ACTIVITY BOOKS; STATIONERY, WRITING PAPER, ENVELOPES, NOTEBOOKS, DIARIES, NOTE CARDS, GREETING CARDS, TRADING CARDS; LITHOGRAPHS; PENS, PENCILS, CASES THEREFOR, ERASERS, CRAYONS, MARKERS, COLORED PENCILS, PAINTING SETS, CHALK AND CHALKBOARDS; DECALS, HEAT TRANSFERS; POSTERS; MOUNTED AND/OR UNMOUNTED PHOTOGRAPHS; BOOK COVERS, BOOK MARKS, CALENDARS, GIFT WRAPPING PAPER; PAPER PARTY FAVORS AND PAPER PARTY DECORATIONS—NAMESLY, PAPER NAPKINS, PAPER DOILIES, PAPER PLACE MATS, CREPE PAPER, PAPER HATS, INVITATIONS, PAPER TABLE CLOTHS, PAPER CAKE DECORATIONS; PRINTED TRANSFERS FOR EMBROIDERY OR FABRIC APPLIQUES; PRINTED PATTERNS FOR COSTUMES, PAJAMAS, SWEATSHIRTS AND T-SHIRTS (U.S. CLS. 2, 5, 22, 23, 29, 37, 38 AND 50).

FIRST USE 8-31-2005; IN COMMERCE 8-31-2005.
RONALD MCMORROW, EXAMINING ATTORNEY

CLASS 16—(Continued).

SN 78-801,450. GOODMAN, DARNELL A., EASTON, PA.
FILED 1-27-2006.

THE MARK CONSISTS OF WORDING WITH A STY-
LIZED "A" BETWEEN THE LETTERS J AND I.
FOR GENERAL FEATURE MAGAZINES (U.S. CLS. 2,
5, 22, 23, 29, 37, 38 AND 50).
MIDGE BUTLER, EXAMINING ATTORNEY

CLASS 16—(Continued).

SN 78-814,159. READING ETC., INC., DEERFIELD BEACH,
FL. FILED 2-14-2006.

RIVER TREASURES COLLECTION

THE MARK CONSISTS OF STANDARD CHARACTERS
WITHOUT CLAIM TO ANY PARTICULAR FONT, STYLE,
SIZE, OR COLOR.
OWNER OF U.S. REG. NO. 3,025,786.
NO CLAIM IS MADE TO THE EXCLUSIVE RIGHT TO
USE "COLLECTION", APART FROM THE MARK AS
SHOWN.
FOR AQUARIUMS (U.S. CLS. 2, 5, 22, 23, 29, 37, 38
AND 50).
MONIQUE MILLER, EXAMINING ATTORNEY

SN 78-804,196. LAURENCE, AMY, REBECCA, DUBLIN, OH.
FILED 2-1-2006.

Jazz Mice

THE MARK CONSISTS OF STANDARD CHARACTERS
WITHOUT CLAIM TO ANY PARTICULAR FONT, STYLE,
SIZE, OR COLOR.
NO CLAIM IS MADE TO THE EXCLUSIVE RIGHT TO
USE "JAZZ", APART FROM THE MARK AS SHOWN.
FOR SHEET MUSIC (U.S. CLS. 2, 5, 22, 23, 29, 37, 38
AND 50).
FIRST USE 10-28-1999; IN COMMERCE 3-21-2001.
WILLIAM BRECKENFELD, EXAMINING ATTORNEY

SN 78-814,676. YE YUAN HSIN ENTERPRISE CO., LTD.,
TAICHUNG COUNTY, TAIWAN, FILED 2-14-2006.

SN 78-812,371. BAIK, MIA HYE-RI, SANTA MONICA, CA.
FILED 2-10-2006.

THE APPLICANT CLAIMS COLOR AS A FEATURE OF
THE MARK, NAMELY, BLACK, GREEN, ORANGE AND
RED.

THE MARK CONSISTS OF A STYLIZED LETTER "I" SET
WITHIN THE TEXT "THE DAY I ADOPTED". THE STY-
LIZED LETTER "I" IS A GREEN LETTER "I" WITH A
STYLIZED QUESTION MARK IMMEDIATELY ABOVE.
THE STYLIZED QUESTION MARK IS A CURLY LINE IN
THE SHAPE OF QUESTION MARK, CURLING OUTWARD
APPROACHING THE ENDPOINT IN A LOWER POSITION
ON THE MARK, AND CURLING INWARD APPROACHING
THE ENDPOINT IN A HIGHER POSITION ON THE MARK,
WHERE A HEART SHAPE IS ATTACHED, ALL SET FORTH
IN RED, EXCEPT FOR THE PERIOD AT THE BOTTOM OF
THE STYLIZED QUESTION MARK, WHICH IS ORANGE,
AND WHICH SERVES AS THE DOT ABOVE THE LETTER
"I". THE BALANCE OF THE CHARACTERS OF THE MARK
ARE SET FORTH IN BLACK.

FOR SERIES OF FICTION BOOKS (U.S. CLS. 2, 5, 22,
23, 29, 37, 38 AND 50).
AMEETA JORDAN, EXAMINING ATTORNEY

Protima

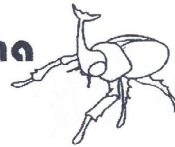

FOR PAINT STIRRERS (U.S. CLS. 2, 5, 22, 23, 29, 37, 38
AND 50).
FIRST USE 12-24-2003; IN COMMERCE 1-17-2006.
JUSTINE D. PARKER, EXAMINING ATTORNEY

CLASS 16—(Continued).

SN 78-817,385. TURNER, PATRICIA E, SNELLVILLE, GA. FILED 2-17-2006.



NO CLAIM IS MADE TO THE EXCLUSIVE RIGHT TO USE "BOOKS", APART FROM THE MARK AS SHOWN.

THE MARK CONSISTS OF A DRAWING OF A MAN LEANING ON A STREET POLE READING A BOOK. THE STREET POLE IS MARKED "5TH STREET" AND THE WORD "BOOKS" APPEARS UNDER THE MAN.

FOR SERIES OF FICTION AND NON-FICTION BOOKS ON A VARIETY OF TOPICS (U.S. CLS. 2, 5, 22, 23, 29, 37, 38 AND 50).

FIRST USE 5-5-2006; IN COMMERCE 5-5-2006.
DAVID MILLER, EXAMINING ATTORNEY

SN 78-822,000. CONROS CORPORATION, NORTH YORK, ONTARIO, CANADA, FILED 2-23-2006.

DIRECT-2-HOME

THE MARK CONSISTS OF STANDARD CHARACTERS WITHOUT CLAIM TO ANY PARTICULAR FONT, STYLE, SIZE, OR COLOR.

FOR ADHESIVE TAPES FOR STATIONERY OR HOUSEHOLD PURPOSE; MAILING ENVELOPES; PACKING BOXES OF PAPER OR CARDBOARD; PAPER CARTONS FOR DELIVERING GOODS (U.S. CLS. 2, 5, 22, 23, 29, 37, 38 AND 50).

DAWN HAN, EXAMINING ATTORNEY

CLASS 16—(Continued).

SN 78-822,570. LEARNINGRX, INC., COLORADO SPRINGS, CO. FILED 2-24-2006.

LIFT OFF

THE MARK CONSISTS OF STANDARD CHARACTERS WITHOUT CLAIM TO ANY PARTICULAR FONT, STYLE, SIZE, OR COLOR.

FOR PRINTED INSTRUCTIONAL, EDUCATIONAL, AND TEACHING MATERIALS IN THE FIELD OF COGNITIVE TRAINING FOR THE TRAINING OF COGNITIVE SKILLS IN CHILDREN UNDER AGE SEVEN IN THE AREAS OF MEMORY, AUDITORY PROCESSING, VISUAL PROCESSING, PROCESSING SPEED, ATTENTION, AND REASONING (U.S. CLS. 2, 5, 22, 23, 29, 37, 38 AND 50).

FIRST USE 5-1-2005; IN COMMERCE 5-1-2005.
JULIE WATSON, EXAMINING ATTORNEY

SN 78-823,043. SIBERIAN CONSULTING, LLC, PORTSMOUTH, NH. FILED 2-24-2006.

THE SECRET OF SECRETS

THE MARK CONSISTS OF STANDARD CHARACTERS WITHOUT CLAIM TO ANY PARTICULAR FONT, STYLE, SIZE, OR COLOR.

FOR PUBLICATIONS, NAMELY, PRINTED BOOKS, MAGAZINES, NEWSLETTERS, NEWSPAPER COLUMNS IN THE FIELD OF FICTION; POSTERS, CALENDARS, NOTE CARDS, GREETING CARDS, STATIONERY ITEMS, NAMELY, PENS, PENCILS, NOTEBOOKS, NOTEPADS, STICKERS, BINDERS, FOLDERS, WRITING PAPER AND ENVELOPES (U.S. CLS. 2, 5, 22, 23, 29, 37, 38 AND 50).

MATTHEW PAPPAS, EXAMINING ATTORNEY

SN 78-823,287. BRADLEY'S FINE JEWELERS INC., FT. MYERS, FL. FILED 2-24-2006.



THE MARK CONSISTS OF A STYLIZED E. FOR PRINTS NAMELY, POSTERS, LETTER HEAD PAPER, CALENDARS (U.S. CLS. 2, 5, 22, 23, 29, 37, 38 AND 50).

JOSETTE BEVERLY, EXAMINING ATTORNEY

CLASS 16—(Continued).

SN 78-823,851. ONE SCOTTSDALE HOLDINGS LLC, SCOTTSDALE, AZ. FILED 2-27-2006.

ONE SCOTTSDALE

THE MARK CONSISTS OF STANDARD CHARACTERS WITHOUT CLAIM TO ANY PARTICULAR FONT, STYLE, SIZE, OR COLOR.

NO CLAIM IS MADE TO THE EXCLUSIVE RIGHT TO USE "SCOTTSDALE", APART FROM THE MARK AS SHOWN.

FOR PRINTED MATERIAL AND PUBLICATIONS, NAMELY, MAGAZINES FEATURING LIFESTYLE, ENTERTAINMENT, FASHION, AND COMMUNITY INFORMATION; INSTRUCTIONAL AND EDUCATIONAL MATERIALS IN THE FIELD OF REAL ESTATE DEVELOPMENT; NEWSLETTERS FEATURING HOMEOWNER ASSOCIATION INFORMATION, COMMUNITY AND LEISURE LIVING INFORMATION (U.S. CLS. 2, 5, 22, 23, 29, 37, 38 AND 50).

CAROLYN CATALDO, EXAMINING ATTORNEY

CLASS 16—(Continued).

SN 78-823,992. JPORTER INDUSTRIES, INC., DULUTH, GA. FILED 2-27-2006.

Julep Green

THE MARK CONSISTS OF STANDARD CHARACTERS WITHOUT CLAIM TO ANY PARTICULAR FONT, STYLE, SIZE, OR COLOR.

FOR SERIES OF CHILDREN'S BOOKS (U.S. CLS. 2, 5, 22, 23, 29, 37, 38 AND 50).

JIM RINGLE, EXAMINING ATTORNEY

SN 78-825,172. HIGHMARK INC., PITTSBURGH, PA. FILED 2-28-2006.

WHAT'S YOUR NUMBER?

THE MARK CONSISTS OF STANDARD CHARACTERS WITHOUT CLAIM TO ANY PARTICULAR FONT, STYLE, SIZE, OR COLOR.

FOR EDUCATIONAL POSTERS, PAMPHLETS, AND PRINTED PERIODICALS IN THE FIELD OF HEALTH AND WELLNESS, FOCUSING ON MEASUREMENT OF BODY MASS INDEX, BLOOD PRESSURE, CHOLESTEROL AN GLUCOSE LEVELS (U.S. CLS. 2, 5, 22, 23, 29, 37, 38 AND 50).

FIRST USE 9-1-2004; IN COMMERCE 9-1-2004.
BILL DAWE, EXAMINING ATTORNEY

SN 78-828,587. PATIRE, TOM, PARK RIDGE, NJ. FILED 3-3-2006.

TOM'S TIPS

THE MARK CONSISTS OF STANDARD CHARACTERS WITHOUT CLAIM TO ANY PARTICULAR FONT, STYLE, SIZE, OR COLOR.

NO CLAIM IS MADE TO THE EXCLUSIVE RIGHT TO USE "TIPS", APART FROM THE MARK AS SHOWN.

FOR SERIES OF ARTICLES AND NEWSLETTERS REGARDING PERSONAL AND FAMILY PROTECTION, PERSONAL HEALTH AND LIFESTYLES (U.S. CLS. 2, 5, 22, 23, 29, 37, 38 AND 50).

FIRST USE 10-1-2003; IN COMMERCE 10-1-2003.
VERNA BETH RIRIE, EXAMINING ATTORNEY

SN 78-823,915. ONE SCOTTSDALE HOLDINGS LLC, SCOTTSDALE, AZ. FILED 2-27-2006.



ONE SCOTTSDALE

NO CLAIM IS MADE TO THE EXCLUSIVE RIGHT TO USE "SCOTTSDALE", APART FROM THE MARK AS SHOWN.

FOR PRINTED MATERIAL AND PUBLICATIONS, NAMELY, MAGAZINES FEATURING LIFESTYLE, ENTERTAINMENT, FASHION, AND COMMUNITY INFORMATION; INSTRUCTIONAL AND EDUCATIONAL MATERIALS IN THE FIELD OF REAL ESTATE DEVELOPMENT; NEWSLETTERS FEATURING HOMEOWNER ASSOCIATION INFORMATION, COMMUNITY AND LEISURE LIVING INFORMATION (U.S. CLS. 2, 5, 22, 23, 29, 37, 38 AND 50).

CAROLYN CATALDO, EXAMINING ATTORNEY

CLASS 16—(Continued).

SN 78-828,923. MEDICAL TECHNOLOGY (W.B.) INC., LONDON, CANADA, FILED 3-3-2006.



FOR POSTERS, TRADING CARDS, BOOKMARKS, AND STICKERS (U.S. CLS. 2, 5, 22, 23, 29, 37, 38 AND 50).
DAVID COLLIER, EXAMINING ATTORNEY

SN 78-830,377. VOIP SERVICES, INC, MIAMI, FL. FILED 3-6-2006.

BAASU

THE MARK CONSISTS OF STANDARD CHARACTERS WITHOUT CLAIM TO ANY PARTICULAR FONT, STYLE, SIZE, OR COLOR.

THE FOREIGN WORDING IN THE MARK TRANSLATES INTO ENGLISH AS PROSPEROUS.

FOR PREPAID TELEPHONE CALLING CARDS, NOT MAGNETICALLY ENCODED (U.S. CLS. 2, 5, 22, 23, 29, 37, 38 AND 50).

FIRST USE 2-28-2006; IN COMMERCE 2-28-2006.
ANN E. SAPPENFIELD, EXAMINING ATTORNEY

SN 78-834,225. MEDIMEDIA USA, INC., YARDLEY, PA. FILED 3-10-2006.

CLINIFORMS

THE MARK CONSISTS OF STANDARD CHARACTERS WITHOUT CLAIM TO ANY PARTICULAR FONT, STYLE, SIZE, OR COLOR.

FOR PRE-PRINTED PATIENTS' MEDICAL INFORMATION FORMS AND STATIONERY, PRINTED MEDICAL RECORD FORMS AND CHARTS (U.S. CLS. 2, 5, 22, 23, 29, 37, 38 AND 50).

FIRST USE 11-25-1986; IN COMMERCE 11-25-1986.
ANDREA K. NADELMAN, EXAMINING ATTORNEY

CLASS 16—(Continued).

SN 78-836,478. FELIX, ANALISA, SAN DIEGO, CA. FILED 3-14-2006.

Caddy Tag

THE MARK CONSISTS OF STANDARD CHARACTERS WITHOUT CLAIM TO ANY PARTICULAR FONT, STYLE, SIZE, OR COLOR.

NO CLAIM IS MADE TO THE EXCLUSIVE RIGHT TO USE TAG, APART FROM THE MARK AS SHOWN.

FOR ADHESIVE LABELS (U.S. CLS. 2, 5, 22, 23, 29, 37, 38 AND 50).

FIRST USE 2-10-2006; IN COMMERCE 2-10-2006.
SUE LAWRENCE, EXAMINING ATTORNEY

SN 78-837,500. BLUEWATER PUBLISHING, INC., NEWPORT BEACH, CA. FILED 3-15-2006.

FOAM

THE MARK CONSISTS OF STANDARD CHARACTERS WITHOUT CLAIM TO ANY PARTICULAR FONT, STYLE, SIZE, OR COLOR.

FOR PRINTED PERIODICAL PUBLICATIONS, NAMELY, MAGAZINES FEATURING FASHION, SPORTS AND BEAUTY (U.S. CLS. 2, 5, 22, 23, 29, 37, 38 AND 50).

BARBARA A. LOUGHRAN, EXAMINING ATTORNEY

SN 78-837,584. ROBERT BARROS PHOTOGRAPHY, SANTA FE, NM. FILED 3-15-2006.



THE COLORS YELLOW, BLACK, WHITE, PINK, OFF-WHITE AND BLUE ARE CLAIMED AS A FEATURE OF THE MARK.

THE COLOR YELLOW APPEARS IN THE LEFT SIDE OF THE BANNER. THE COLOR BLACK APPEARS IN THE WORDING TRAVEL. THE BANNER, THE WHEELS AND STEERING WHEEL OF THE CAR, AND THE SUNGLASSES. THE COLOR WHITE APPEARS IN THE WORDING DOGS AND IN THE BANNER. THE COLOR PINK APPEARS IN THE CAR, THE DOG'S ACCESSORIES, AND IN THE BACKGROUND. THE COLOR OFF-WHITE APPEARS IN THE DOG'S COAT. AND THE COLORS BLUE APPEARS IN THE WINDSHIELD AND THE WHEELS.

FOR CALENDARS; BANK CHECKS; STATIONERY; PAPER GIFT BAGS; GREETING CARDS (U.S. CLS. 2, 5, 22, 23, 29, 37, 38 AND 50).

FIRST USE 6-1-2004; IN COMMERCE 1-1-2005.
HEATHER SAPP, EXAMINING ATTORNEY

CLASS 16—(Continued).

SN 78-840,415. WESTRIM, INC., WOODLAND HILLS, CA.
FILED 3-17-2006.



OWNER OF U.S. REG. NO. 2,086,435.

FOR PAPER SHEETS; PAPER GIFT AND GREETING PRODUCTS, NAMELY, GIFT BAGS, GIFT TISSUE PAPER, GIFT WRAP, AND GIFT TAGS; GREETING CARDS; NOTE CARDS; POST CARDS; PLACE CARDS; THANK YOU CARDS; ART PAPER CARDS WITH DISTINCTIVE SHAPES; MATCHING ENVELOPES AND CARDS; COLORED PAPER CARD STOCK; FRAMING MATS; COLLAGE PAPERS; COLLAGE PACKS; PAPER ROLLS; WRAPPING PAPER; BOOK MARKS; PAPER PACKS; COLOR COORDINATED PAPER PACKS; METALLIC PAPER; CORRUGATED PAPER; STITCHED PAPER; PAGE PROTECTORS; CARD STOCK; BACK-GROUND PAPERS; PRINT PAPERS; MEMORY BOOKS; PHOTO ALBUMS; PICTURE BOOKS; PRINTED DESIGN PAPER SHEETS; PAPER DIE CUTS; PAPER FRAMES AND BORDERING; PAPER BAGS; PAPER BOXES; PAPER CONTAINERS; PAPER GIFT AND NOVELTY PACKAGES; NAME CARDS; PAPER NAPKINS; INSERT CARDS FOR PARTIES AND WEDDINGS; PRINTED PARTY AND WEDDING INVITATION CARDS; MEMO PADS; PAPER PARTY FAVORS; PAPER PARTY DECORATIONS; PRINTED CHARTS; PAPER COASTERS; PAPER FLAGS; CRAFT PAPER; TRACING PAPER; BOOK ENDS; WRITING INSTRUMENTS; RUBBER STAMPS; TEMPLATES; STENCILS; CRAFT PAPER OF VARIOUS SIZES, SHAPES, TEXTURE, PATTERNS AND DESIGNS FOR HOBBIES AND HANDICRAFTS; DECORATIVE AND ORNAMENTAL PAPER RIBBONS; INK STAMPERS; PERSONALIZED STICKERS AND INK STAMPERS SOLD AS A UNIT; THREE-DIMENSIONAL PAPER EMBELLISHMENTS AND DECORATIONS FOR USE IN HAND CRAFTING SCRAPBOOKS, PHOTO ALBUMS, GREETING CARDS AND GIFT BAGS; PHOTO ALBUMS; SCRAPBOOK ALBUMS; PRINTED ALBUMS; PICTURE FRAMING MAT BOARDS AND BORDERING TRIMS FOR PHOTO ALBUMS; STATIONERY; PLASTIC TEMPLATES; PRINTED PAPERS FOR USE IN CREATING PHOTO ALBUMS, SCRAPBOOKS, AND MEMORY BOOKS; PAPER STICKERS; PHOTO AND SCRAPBOOK THEME ALBUM KITS; SCRAP BOOKING KITS CONSISTING PRIMARILY OF PHOTO ALBUMS, PLAIN COLOR PAPER SHEETS, PRINTED DESIGN PAPER SHEETS, SHEET PROTECTORS, PENS, PENCILS, GLUE, TEMPLATES, STICKERS, PAPER DIE CUT OUTS, PAPER FRAMES AND BORDERING; DRAWING TEMPLATES; PAPER AND PRINTED EMBLEMS; STICKERS; DRAWING RULERS AND DRAFTING RULERS; WRITING PENCILS; WRITING PENS; LOOSE LEAF PAPER; PRINTED PATTERNS FOR BEAD WORK; BOOKS ON THE SUBJECT OF BEAD WORK; PAPER DESIGN PUNCHES; LEDGER AND JOURNAL SHEETS; LETTERING TABS; TABBED PAPERS; SHEETS OF PAPER, LETTERS, NUMBERS, WORDS AND SYMBOLS; VELLUMS; FOLDABLE AND ACCORDION SHAPED CARD STOCK; SHEETS OF PUNCH-OUT TAGS; SHEETS OF POP-UP TAGS; FILE FOLDERS; PAPER RUB ON IMAGES; CALENDARS; BOOKS OF QUOTES AND PHRASES; BOOKS FOR DESIGNING AND FORMATTING SCRAPBOOKS, AND PHOTO ALBUMS AND ART IMAGES (U.S. CLS. 2, 5, 22, 23, 29, 37, 38 AND 50).
FIRST USE 1-15-2000; IN COMMERCE 1-15-2000.

KAREN K. BUSH, EXAMINING ATTORNEY

CLASS 16—(Continued).

SN 78-840,739. BEER, GERALD, GUYMON, OK. FILED 3-19-2006.



NO CLAIM IS MADE TO THE EXCLUSIVE RIGHT TO USE "AMERICAN", APART FROM THE MARK AS SHOWN. THE COLOR(S) BLUE, WHITE, BLACK, AND RED IS/ARE CLAIMED AS A FEATURE OF THE MARK.

THE MARK CONSISTS OF A MAP OF THE UNITED STATES COMPRISING THREE HORIZONTAL STRIPES, THE TOP STRIPE BEING BLUE, THE MIDDLE STRIPE BEING WHITE, AND THE BOTTOM STRIPE BEING RED. THE WORD "AMERICAN" IS INSCRIBED IN WHITE ON THE BLUE STRIPE, THE WORD "AGRICULTURE" IN BLACK ON THE WHITE STRIPE, AND THE WORD "DOLLARS" IN WHITE ON THE RED STRIPE.

FOR BANK CHECKS (U.S. CLS. 2, 5, 22, 23, 29, 37, 38 AND 50).

ELLEN BURNS, EXAMINING ATTORNEY

SN 78-842,930. ANAND INTERNATIONAL, MUMBAI 400 067, INDIA, FILED 3-22-2006.

DIGNO

THE MARK CONSISTS OF STANDARD CHARACTERS WITHOUT CLAIM TO ANY PARTICULAR FONT, STYLE, SIZE, OR COLOR.

THE FOREIGN WORDING IN THE MARK TRANSLATES INTO ENGLISH AS WORTHY.

FOR PENS (U.S. CLS. 2, 5, 22, 23, 29, 37, 38 AND 50).

FIRST USE 2-15-2006; IN COMMERCE 2-15-2006.

GEORGE LORENZO, EXAMINING ATTORNEY

SN 78-844,212. PESSO, JANEN MOYER, BOCA RATON, FL. FILED 3-23-2006.

Divorce "RICH"

NO CLAIM IS MADE TO THE EXCLUSIVE RIGHT TO USE "DIVORCE", APART FROM THE MARK AS SHOWN.

THE COLOR(S) TEAL AND GOLD IS/ARE CLAIMED AS A FEATURE OF THE MARK.

THE COLOR TEAL APPEARS IN THE WORD DIVORCE AND THE COLOR GOLD APPEARS IN THE WORD RICH AND IN THE QUOTATION MARKS AROUND THE WORD "RICH".

FOR SERIES OF NON-FICTION BOOKS IN THE FIELD OF THE FINANCIAL AND LEGAL ASPECTS OF DIVORCE (U.S. CLS. 2, 5, 22, 23, 29, 37, 38 AND 50).

KAELIE KUNG, EXAMINING ATTORNEY

CLASS 16—(Continued).

SN 78-845,257. KVM-VERLAG-GMBH, MARBURG, FED REP GERMANY, FILED 3-24-2006.

NUTROPOLY

THE MARK CONSISTS OF STANDARD CHARACTERS WITHOUT CLAIM TO ANY PARTICULAR FONT, STYLE, SIZE, OR COLOR.

FOR STATIONERY; WRITING PAPER; ENVELOPES; CALENDARS; STATIONERY-TYPE PORTFOLIOS; PERIODICAL PUBLICATIONS AND BROCHURES, NAMELY MAGAZINES AND NEWSLETTERS THAT PERTAIN TO WEIGHT LOSS AND WEIGHT CONTROL; PRINTED TRAINING MANUALS, PRINTED INSTRUCTIONAL TEACHING MATERIALS AND COOKBOOKS ALL FEATURING RECIPES, INFORMATION AND ADVICE ON WEIGHT LOSS AND WEIGHT CONTROL (U.S. CLS. 2, 5, 22, 23, 29, 37, 38 AND 50).

CIMMERIAN COLEMAN, EXAMINING ATTORNEY

CLASS 16—(Continued).

SN 78-847,767. TWO GALLANTS, SAN FRANCISCO, CA. FILED 3-28-2006.

TWO GALLANTS

THE MARK CONSISTS OF STANDARD CHARACTERS WITHOUT CLAIM TO ANY PARTICULAR FONT, STYLE, SIZE, OR COLOR.

FOR POSTERS, TOUR BOOKS RELATING TO MUSICAL PERFORMANCES, CONCERT PROGRAMS, SCRAPBOOK ALBUMS, CALENDARS, SONG BOOKS, PENS, PENCILS, GREETING CARDS, GIFT WRAPPING PAPER, PAPER PARTY DECORATIONS, PAPER EMBLEMS, PAPER FLAGS, MAGAZINES FEATURING SUBJECT MATTER RELATING TO THE MUSIC INDUSTRY, MUSICAL GROUPS AND MUSICAL SOUND RECORDINGS, TRADING CARDS, AUTOGRAPH BOOKS, POSTER BOOKS, PHOTOGRAPH ALBUMS, ADDRESS BOOKS, APPOINTMENT BOOKS, ART PICTURES, ART PAPERS, PAPER BAGS, PAPER BANNERS, BINDERS, PENCIL CASES, BOOK COVERS, COLORING BOOKS, PAPER PLACE MATS, PAPER COASTERS, DECALS, STICKERS, NOTEBOOKS, AND LITHOGRAPHS (U.S. CLS. 2, 5, 22, 23, 29, 37, 38 AND 50).

KATHERINE STOIDES, EXAMINING ATTORNEY

SN 78-845,866. GLOBAL TISSUE GROUP, INC., BOHEMIA, NY. FILED 3-24-2006.

TAD

THE MARK CONSISTS OF STANDARD CHARACTERS WITHOUT CLAIM TO ANY PARTICULAR FONT, STYLE, SIZE, OR COLOR.

THE NAME TAD DOES NOT IDENTIFY A LIVING INDIVIDUAL.

FOR PAPER GOODS AND INDUSTRIAL PAPER PRODUCTS NAMELY, PAPER NAPKINS, PAPER TOWELS, FACIAL TISSUE, AND TOILET TISSUE (U.S. CLS. 2, 5, 22, 23, 29, 37, 38 AND 50).

FRED CARL, EXAMINING ATTORNEY

SN 78-847,888. HOUR MEDIA, LLC, ROYAL OAK, MI. FILED 3-28-2006.

DBusiness

FOR BUSINESS MAGAZINE RELATING TO DETROIT AND SURROUNDING REGIONS (U.S. CLS. 2, 5, 22, 23, 29, 37, 38 AND 50).

FRED CARL, EXAMINING ATTORNEY

CLASS 16—(Continued).

SN 78-852,086. ARGOSY COMMUNICATIONS, INC., LOS ANGELES, CA. FILED 4-2-2006.

THE SECRET 6

THE MARK CONSISTS OF STANDARD CHARACTERS WITHOUT CLAIM TO ANY PARTICULAR FONT, STYLE, SIZE, OR COLOR.

FOR SERIES OF FICTION BOOKS; MAGAZINES FEATURING ACTION STORIES WITH ILLUSTRATIONS (U.S. CLS. 2, 5, 22, 23, 29, 37, 38 AND 50).

FIRST USE 9-30-1934; IN COMMERCE 9-30-1934.
LINDA ORNDORFF, EXAMINING ATTORNEY

CLASS 16—(Continued).

SN 78-854,222. CLARKSON, ALVIN VICTOR JR., COLUMBIA, MD. AND CLARKSON, TINA LORRAINE, COLUMBIA, MD. FILED 4-5-2006.

God's Fingerprints

THE MARK CONSISTS OF STANDARD CHARACTERS WITHOUT CLAIM TO ANY PARTICULAR FONT, STYLE, SIZE, OR COLOR.

FOR CARDS BEARING UNIVERSAL GREETINGS; GREETING CARDS (U.S. CLS. 2, 5, 22, 23, 29, 37, 38 AND 50).

ELIZABETH J. WINTER, EXAMINING ATTORNEY

SN 78-852,372. AMONES, TROY, ARCATA, CA. FILED 4-3-2006.

In-School Ink

THE MARK CONSISTS OF STANDARD CHARACTERS WITHOUT CLAIM TO ANY PARTICULAR FONT, STYLE, SIZE, OR COLOR.

NO CLAIM IS MADE TO THE EXCLUSIVE RIGHT TO USE INK, APART FROM THE MARK AS SHOWN.

FOR COMIC BOOKS (U.S. CLS. 2, 5, 22, 23, 29, 37, 38 AND 50).

JEFF DEFORD, EXAMINING ATTORNEY

SN 78-854,898. SUMEX DESIGN, PORTSMOUTH, NH. FILED 4-5-2006.

**Sumex Design
Design - Document - Detail
- Develop**

THE MARK CONSISTS OF STANDARD CHARACTERS WITHOUT CLAIM TO ANY PARTICULAR FONT, STYLE, SIZE, OR COLOR.

NO CLAIM IS MADE TO THE EXCLUSIVE RIGHT TO USE "DESIGN" OR "DETAIL", APART FROM THE MARK AS SHOWN.

FOR ARCHITECTURAL PLANS AND SPECIFICATIONS (U.S. CLS. 2, 5, 22, 23, 29, 37, 38 AND 50).

FIRST USE 11-1-2005; IN COMMERCE 11-15-2005.

TRACY WHITAKER-BOWN, EXAMINING ATTORNEY

SN 78-854,139. LANCE, KYDE, H., FLETCHER, NC. FILED 4-5-2006.

ID CONCEPTS, INC.

THE MARK CONSISTS OF STANDARD CHARACTERS WITHOUT CLAIM TO ANY PARTICULAR FONT, STYLE, SIZE, OR COLOR.

NO CLAIM IS MADE TO THE EXCLUSIVE RIGHT TO USE "ID" AND "INC.", APART FROM THE MARK AS SHOWN.

FOR LAMINATED PAPER IDENTIFICATION CARDS; PAPER BADGES; PAPER POUCHES FOR PACKAGING (U.S. CLS. 2, 5, 22, 23, 29, 37, 38 AND 50).

FIRST USE 10-2-1997; IN COMMERCE 10-2-1997.
ANDREA EVANS, EXAMINING ATTORNEY

SN 78-857,776. MYDECIDE, INC., MOUNTAIN VIEW, CA. FILED 4-10-2006.

MYDECIDE

THE MARK CONSISTS OF STANDARD CHARACTERS WITHOUT CLAIM TO ANY PARTICULAR FONT, STYLE, SIZE, OR COLOR.

FOR PRINTED MATERIALS, NAMELY, BROCHURES, MAGAZINES, NEWSLETTERS, REFERENCE BOOKS, PRESS RELEASES, CATALOGS, PAMPHLETS, INSTRUCTIONAL MATERIALS, AND MANUALS IN THE FIELD OF IMPROVING DECISION MAKING (U.S. CLS. 2, 5, 22, 23, 29, 37, 38 AND 50).

TRAVIS WHEATLEY, EXAMINING ATTORNEY

CLASS 16—(Continued).

SN 78-858,056. ELDERHOSTEL, INC., BOSTON, MA. FILED 4-10-2006.

LIFELONG LEARNING

THE MARK CONSISTS OF STANDARD CHARACTERS WITHOUT CLAIM TO ANY PARTICULAR FONT, STYLE, SIZE, OR COLOR.

FOR MAGAZINES FEATURING GENERAL INTEREST SUBJECT MATTER (U.S. CLS. 2, 5, 22, 23, 29, 37, 38 AND 50).

LEIGH CAROLINE CASE, EXAMINING ATTORNEY

SN 78-858,330. MALONEY, PATRICK J., DBA FINE RHYME IMAGERY, GALES FERRY, CT. FILED 4-10-2006.

Fine Rhyme Imagery

THE MARK CONSISTS OF STANDARD CHARACTERS WITHOUT CLAIM TO ANY PARTICULAR FONT, STYLE, SIZE, OR COLOR.

NO CLAIM IS MADE TO THE EXCLUSIVE RIGHT TO USE "RHYME IMAGERY", APART FROM THE MARK AS SHOWN.

FOR ART PRINTS (U.S. CLS. 2, 5, 22, 23, 29, 37, 38 AND 50).

FIRST USE 7-29-2005; IN COMMERCE 7-29-2005.
ANNE FARRELL, EXAMINING ATTORNEY

SN 78-858,640. VIACOM INTERNATIONAL INC., NEW YORK, NY. FILED 4-11-2006.

BEST DAY EVER

THE MARK CONSISTS OF STANDARD CHARACTERS WITHOUT CLAIM TO ANY PARTICULAR FONT, STYLE, SIZE, OR COLOR.

FOR PRINTED MATTER, NAMELY, NOTE PAPER AND LOOSE LEAF PAPER, SERIES OF FICTION BOOKS, DECALS, BUMPER STICKERS, TRADING CARDS, NOTE CARDS, POSTERS, FOLDERS, CALENDARS, STATIONERY WRITING PAPER AND ENVELOPES, ARTS AND CRAFT PAINT KITS; NOTEBOOKS; BLANK JOURNALS; ADDRESS BOOKS; DIARIES; DAILY PLANNERS; DESKTOP PLANNERS; PERSONAL PLANNERS; BOOKMARKS; AND CARDBOARD; CRAFT BOOKS; SCHOOL SUPPLIES, NAMELY, SCHOOL BOXES MADE OF CARDBOARD PENCIL, PENS, PEN AND PENCIL CASES AND HOLDERS, ERASERS, PENCIL SHARPENERS, HIGHLIGHTS MARKERS, MARKERS, AND DRAWING RULERS; GIFT WRAPPING PAPER; PAPER PARTY DECORATIONS; PARTY PAPER BAGS (U.S. CLS. 2, 5, 22, 23, 29, 37, 38 AND 50).

SUSAN RICHARDS, EXAMINING ATTORNEY

CLASS 16—(Continued).

SN 78-859,086. WOWZEE WORKS, LLC, LAS VEGAS, NV. FILED 4-11-2006.



FOR CHILDREN'S BOOKS (U.S. CLS. 2, 5, 22, 23, 29, 37, 38 AND 50).

DEZMONA MIZELLE, EXAMINING ATTORNEY

SN 78-859,183. WOWZEE WORKS, LLC, LAS VEGAS, NV. FILED 4-11-2006.



FOR CHILDREN'S BOOKS (U.S. CLS. 2, 5, 22, 23, 29, 37, 38 AND 50).

DEZMONA MIZELLE, EXAMINING ATTORNEY

CLASS 16—(Continued).

SN 78-859,226. PANTONE, INC., CARLSTADT, NJ. FILED 4-11-2006.

PANTONE UNIVERSE

THE MARK CONSISTS OF STANDARD CHARACTERS WITHOUT CLAIM TO ANY PARTICULAR FONT, STYLE, SIZE, OR COLOR.

OWNER OF U.S. REG. NOS. 1,674,917, 1,884,707 AND OTHERS.

FOR ADDRESS BOOKS; ADHESIVE LABELS; ADHESIVE NOTE PADS; ADHESIVE TAPE DISPENSERS; ADHESIVES FOR STATIONERY PURPOSES; APPOINTMENT BOOKS; BALL POINT PENS; BINDERS; BLANK JOURNAL BOOKS; BOOKENDS; BUSINESS CARD CASES; CALENDARS; CARRYING CASES MADE OF PAPER; CLIP BOARDS; COASTERS MADE OF PAPER; COLOR PENCILS; COPIER PAPER; CORRECTING TAPE FOR TYPE; CRAYONS; DAY PLANNERS; DESK FILE TRAYS; DESK PADS; DESKTOP BUSINESS CARD HOLDERS; DESKTOP DOCUMENT STANDS; DESKTOP ORGANIZERS; DESKTOP PLANNERS; DIARIES; DOCUMENT PORTFOLIOS; DRAWING RULERS; ENVELOPES; ERASERS; FABRIC GIFT BAGS; FELT PENS; FILE FOLDERS; FILE POCKETS; FILE TRAYS; HANGING FOLDERS; HIGHLIGHTER PENS; HOLDERS FOR DESK ACCESSORIES; INDEX DIVIDERS; INK PENS; MARKING PENS; MARKING TABS; MECHANICAL PENCILS; NOTE BOOKS; NOTE PAD HOLDERS; NOTE PADS; NOTEBOOK DIVIDERS; OFFICE HOLE PUNCHERS; PAPER BOXES; PAPER CLIP HOLDERS; PAPER CLIPS; PAPER EXPANDING FILES; PAPER FASTENERS; PAPER FILE JACKETS; PAPER GIFT BAGS; PAPER GIFT TAGS; PAPER LABELS; PEN AND PENCIL CASES AND BOXES; PENCIL LEADS; PENCIL SHARPENERS; PENCILS; PENS; PLASTIC GIFT WRAP; PRESENTATION BOARDS; PRESENTATION FOLDERS; STATIONERY BOXES; SCRAPBOOK ALBUMS; SCRAPBOOK PAGES; SCRAPBOOKS; STAPLE REMOVERS; STAPLERS; STATIONERY; STATIONERY-TYPE PORTFOLIOS; TABLE MATS OF PAPER; WRAPPING PAPER (U.S. CLS. 2, 5, 22, 23, 29, 37, 38 AND 50).

TINA BROWN, EXAMINING ATTORNEY

SN 78-859,545. MILLER, CANFIELD, PADDOCK AND STONE, P.L.C., DETROIT, MI. FILED 4-12-2006.

Hot-Points

THE MARK CONSISTS OF STANDARD CHARACTERS WITHOUT CLAIM TO ANY PARTICULAR FONT, STYLE, SIZE, OR COLOR.

FOR NEWSLETTERS IN THE FIELD OF LAW AND LEGAL RELATED ISSUES (U.S. CLS. 2, 5, 22, 23, 29, 37, 38 AND 50).

FIRST USE 1-1-1993; IN COMMERCE 1-1-1993.
WENDY GOODMAN, EXAMINING ATTORNEY

CLASS 16—(Continued).

SN 78-859,552. DAP BRANDS COMPANY, MEDINA, OH. FILED 4-12-2006.

WATERSTIK

THE MARK CONSISTS OF STANDARD CHARACTERS WITHOUT CLAIM TO ANY PARTICULAR FONT, STYLE, SIZE, OR COLOR.

FOR WATER-BASED ADHESIVE FOR STATIONERY AND HOUSEHOLD PURPOSES (U.S. CLS. 2, 5, 22, 23, 29, 37, 38 AND 50).

MICHAEL KAZAZIAN, EXAMINING ATTORNEY

SN 78-859,638. HARRIET ZIEFERT, INC., MAPLEWOOD, NJ. FILED 4-12-2006.

BEGIN SMART

THE MARK CONSISTS OF STANDARD CHARACTERS WITHOUT CLAIM TO ANY PARTICULAR FONT, STYLE, SIZE, OR COLOR.

FOR EDUCATIONAL BOOKS FEATURING A DEVELOPMENTAL PROGRAM FOR CHILDREN (U.S. CLS. 2, 5, 22, 23, 29, 37, 38 AND 50).

JENNIFER VASQUEZ, EXAMINING ATTORNEY

SN 78-859,693. HARRIET ZIEFERT, INC., MAPLEWOOD, NJ. FILED 4-12-2006.

flip-a FACE

THE MARK CONSISTS OF STANDARD CHARACTERS WITHOUT CLAIM TO ANY PARTICULAR FONT, STYLE, SIZE, OR COLOR.

FOR CHILDREN'S BOOKS (U.S. CLS. 2, 5, 22, 23, 29, 37, 38 AND 50).

FIRST USE 9-1-2005; IN COMMERCE 9-1-2005.
JENNIFER VASQUEZ, EXAMINING ATTORNEY

CLASS 16—(Continued).

SN 78-859,715. TURNKEY MARKETING GROUP, LLC, CAMBRIDGE, MA. FILED 4-12-2006.



THE COLORS DARK BLUE, LIGHT BLUE AND WHITE ARE CLAIMED AS A FEATURE OF THE MARK.

THE MARK CONSISTS OF THE STYLIZED LETTER T IN WHITE AND L IN LIGHT BLUE, LOCATED WITHIN A DARK BLUE CIRCLE. THE WORDS TEENLIFE APPEAR IN DARK AND LIGHT BLUE UNDERNEATH THE CIRCLE.

FOR GUIDE BOOKS FEATURING SUMMER ACTIVITIES FOR TEENS (U.S. CLS. 2, 5, 22, 23, 29, 37, 38 AND 50).

FIRST USE 2-24-2006; IN COMMERCE 3-10-2006.
GISELLE AGOSTO, EXAMINING ATTORNEY

SN 78-859,835. A WISEBROAD DESIGNS, PRINCETON, IL. FILED 4-12-2006.

Ann the Artist

THE MARK CONSISTS OF STANDARD CHARACTERS WITHOUT CLAIM TO ANY PARTICULAR FONT, STYLE, SIZE, OR COLOR.

FOR CHILDREN'S ACTIVITY BOOKS (U.S. CLS. 2, 5, 22, 23, 29, 37, 38 AND 50).

TIMOTHY FINNEGAN, EXAMINING ATTORNEY

SN 78-860,032. MINNESOTA ADVERTISING FEDERATION, ST. PAUL, MN. FILED 4-12-2006.

AD FED EDGE

THE MARK CONSISTS OF STANDARD CHARACTERS WITHOUT CLAIM TO ANY PARTICULAR FONT, STYLE, SIZE, OR COLOR.

NO CLAIM IS MADE TO THE EXCLUSIVE RIGHT TO USE "AD", APART FROM THE MARK AS SHOWN.

FOR PUBLICATION, NAMELY, MAGAZINES IN THE FIELD OF ADVERTISING (U.S. CLS. 2, 5, 22, 23, 29, 37, 38 AND 50).

SARAH WAYDA, EXAMINING ATTORNEY

CLASS 16—(Continued).

SN 78-860,434. PICTO LAB, INC., ROCKVILLE, MD. FILED 4-12-2006.



THE COLOR(S) BLACK AND WHITE IS/ARE CLAIMED AS A FEATURE OF THE MARK.

THE MARK CONSISTS OF "PB" LOGO WITH WHITE TEXT, BLACK BACKGROUND. THE LETTER "P" IS REVERSED AND COMBINED WITH THE LETTER "B". PICTOBOOKS WRITTEN IN BLACK TEXT WITH A CAPITAL "P", CAPITAL "B".

FOR ANNIVERSARY BOOKS; BABY BOOKS; BIRTHDAY BOOKS; BOOK BINDINGS; BOOK COVERS; BRAG BOOKS; COFFEE TABLE BOOKS FEATURING; ENGAGEMENT BOOKS; EVENT ALBUMS; LEATHER BOOK COVERS; MEMORY BOOKS; PHOTOGRAPH ALBUM PAGES; PHOTOGRAPH ALBUMS; PHOTOGRAPHIC ALBUMS; PICTURE BOOKS; SCRAPBOOK ALBUMS; STORY BOOKS; WEDDING ALBUMS; WEDDING BOOKS; WIREBOUND BOOKS (U.S. CLS. 2, 5, 22, 23, 29, 37, 38 AND 50).

FIRST USE 1-1-2004; IN COMMERCE 1-1-2004.
GEOFFREY FOSDICK, EXAMINING ATTORNEY

SN 78-861,188. LAS VEGAS CALENDAR GIRLS, INC., LAS VEGAS, NV. FILED 4-13-2006.



FOR 12 MONTH CALENDAR TO BE SOLD AT RETAIL AND USED IN A VARIETY OF PROMOTIONAL EVENTS (U.S. CLS. 2, 5, 22, 23, 29, 37, 38 AND 50).

CAROLYN GRAY, EXAMINING ATTORNEY

SN 78-861,487. MARANO, ROSARIO, LITTLE FALLS, NJ. FILED 4-13-2006.

ERGO-FILER

THE MARK CONSISTS OF STANDARD CHARACTERS WITHOUT CLAIM TO ANY PARTICULAR FONT, STYLE, SIZE, OR COLOR.

FOR DESKTOP ORGANIZERS (U.S. CLS. 2, 5, 22, 23, 29, 37, 38 AND 50).

COLLEEN KEARNEY, EXAMINING ATTORNEY

CLASS 16—(Continued).

SN 78-861,765. TIMES UP, INC., DBA DIGISPEC, LAS VEGAS, NV. FILED 4-14-2006.

MOUSEPAPER

THE MARK CONSISTS OF STANDARD CHARACTERS WITHOUT CLAIM TO ANY PARTICULAR FONT, STYLE, SIZE, OR COLOR.

FOR PAPER NOTE PADS WHICH MAY BE USED AS COMPUTER MOUSE PADS (U.S. CLS. 2, 5, 22, 23, 29, 37, 38 AND 50).

FIRST USE 12-1-1998; IN COMMERCE 12-1-1998.
ALICE BENMAMAN, EXAMINING ATTORNEY

SN 78-861,827. BOARDROOM INC., STAMFORD, CT. FILED 4-14-2006.

HOW TO DO EVERYTHING RIGHT

THE MARK CONSISTS OF STANDARD CHARACTERS WITHOUT CLAIM TO ANY PARTICULAR FONT, STYLE, SIZE, OR COLOR.

FOR PRINTED PUBLICATIONS, NAMELY, NEWSLETTERS FEATURING INFORMATION AND ARTICLES IN THE FIELDS OF SELF-IMPROVEMENT, HEALTH, NUTRITION, FITNESS, PERSONAL, FINANCIAL AND BUSINESS ISSUES (U.S. CLS. 2, 5, 22, 23, 29, 37, 38 AND 50).

FIRST USE 8-1-1984; IN COMMERCE 8-1-1984.
JUDITH HELFMAN, EXAMINING ATTORNEY

SN 78-862,009. INTELECTION, L.L.C., SCOTTSDALE, AZ. FILED 4-14-2006.

GUARANTEED FAILURE

THE MARK CONSISTS OF STANDARD CHARACTERS WITHOUT CLAIM TO ANY PARTICULAR FONT, STYLE, SIZE, OR COLOR.

FOR BOOKLETS IN THE FIELD OF BUSINESS AND PERSONAL DEVELOPMENT; BOOKS IN THE FIELD OF BUSINESS AND PERSONAL DEVELOPMENT; PRINTED INSTRUCTIONAL, EDUCATIONAL, AND TEACHING MATERIALS IN THE FIELD OF BUSINESS AND PERSONAL DEVELOPMENT (U.S. CLS. 2, 5, 22, 23, 29, 37, 38 AND 50).

KATHERINE CONNOLLY, EXAMINING ATTORNEY

CLASS 16—(Continued).

SN 78-862,437. TURLEY, SANDY A, FALLBROOK, CA. FILED 4-16-2006.



THE APPLICANT CLAIMS COLOR AS A FEATURE OF THE MARK, NAMELY, RED, YELLOW, AND ORANGE, BLACK OUTLINE.

THE MARK CONSISTS OF THE WORDS SPELLING STICKS WITH RED IN THE UPPER PART OF THE LETTERS, CHANGING INTO ORANGE IN THE MIDDLE OF THE LETTERS AND YELLOW AT THE BOTTOM OF THE LETTERS OUTLINED IN BLACK WITH A RED SHADOW ON THE BACK OF EACH LETTER.

FOR PRINTED INSTRUCTIONAL, EDUCATIONAL, AND TEACHING MATERIALS IN THE FIELD OF PRIMARY EDUCATION (U.S. CLS. 2, 5, 22, 23, 29, 37, 38 AND 50).

ROBIN MITTLER, EXAMINING ATTORNEY

SN 78-862,634. RHYNE & SON, INC., RINGGOLD, GA. FILED 4-17-2006.



OWNER OF U.S. REG. NO. 3,032,301.

FOR BOOKS IN THE FIELD OF MCCOY COLLECTIBLES, COLLECTING MCCOY POTTERY, DECORATING WITH MCCOY POTTERY, FAMOUS COLLECTORS OF MCCOY POTTERY (U.S. CLS. 2, 5, 22, 23, 29, 37, 38 AND 50).

JOHN WILKE, EXAMINING ATTORNEY

SN 78-863,654. PUBLISH WRITERS, INC., TEMECULA, CA. FILED 4-18-2006.

THE UNCOMMON LANGUAGE OF MONEY

THE MARK CONSISTS OF STANDARD CHARACTERS WITHOUT CLAIM TO ANY PARTICULAR FONT, STYLE, SIZE, OR COLOR.

NO CLAIM IS MADE TO THE EXCLUSIVE RIGHT TO USE "MONEY", APART FROM THE MARK AS SHOWN.

FOR EDUCATIONAL PUBLICATIONS, NAMELY, TRAINING MANUALS IN THE FIELD OF ECONOMICS (U.S. CLS. 2, 5, 22, 23, 29, 37, 38 AND 50).

GRETTA YAO, EXAMINING ATTORNEY

CLASS 16—(Continued).

SN 78-863,663. FREEDOM COMMUNICATIONS, INC., DBA THE ORANGE COUNTY REGISTER, SANTA ANA, CA. FILED 4-18-2006.

FREE SPIRIT

THE MARK CONSISTS OF STANDARD CHARACTERS WITHOUT CLAIM TO ANY PARTICULAR FONT, STYLE, SIZE, OR COLOR.

FOR PRINTED PUBLICATIONS, NAMELY, NEWSPAPERS AND MAGAZINES FEATURING MOTORCYCLES AND BOATS FOR MOTORCYCLE AND BOATING ENTHUSIASTS (U.S. CLS. 2, 5, 22, 23, 29, 37, 38 AND 50).
TINA BROWN, EXAMINING ATTORNEY

SN 78-863,737. GO NATUR'L STUDIOS, LLC, RIDGEFIELD, CT. FILED 4-18-2006.

LEAVE IT GREEN

THE MARK CONSISTS OF STANDARD CHARACTERS WITHOUT CLAIM TO ANY PARTICULAR FONT, STYLE, SIZE, OR COLOR.

FOR ADHESIVE NOTE PADS; ART PADS; BATHROOM TISSUE; BLANK JOURNAL BOOKS; BLANK WRITING JOURNALS; BUSINESS RECORD BOOKS; CARDBOARD BOXES; CARDBOARD CARTONS; CARDBOARD PACKAGING; CHILDREN'S ACTIVITY BOOKS; COMPOSITION BOOKS; DOCUMENT COVERS; DOCUMENT PORTFOLIOS; DRAWING PADS; DRAWING PAPER; ENVELOPES; FACIAL TISSUE; FACSIMILE TRANSMISSION PAPER; FILLER PAPER; FOLDERS; GREETING CARDS; LASER PRINTING PAPER; LEGAL PADS; LETTERHEAD PAPER; MEMO PADS; NOTE BOOKS; NOTE PADS; NOTE PAPER; NOTEBOOK DIVIDERS; NOTEBOOK PAPER; OFFICE STATIONERY; PAPER NAPKINS; PAPER TABLE CLOTHS; PAPER TOWELS; PHOTOCOPY PAPERS; PRINTING PAPER; PROTECTIVE COVERS FOR SHEETS OR PAPER AND PAGES OF BOOKS AND THE LIKE; RECYCLED BOND PAPER; RECYCLED PAPER; SCRATCH PADS; SKETCH PADS; SKETCHBOOKS; SPIRAL NOTEBOOKS; STATIONERY; TOILET PAPER; TOILET SEAT COVER PAPER; TRACING PAPER; WRITING PAPER PADS (U.S. CLS. 2, 5, 22, 23, 29, 37, 38 AND 50).
WARREN L. OLANDRIA, EXAMINING ATTORNEY

CLASS 16—(Continued).

SN 78-863,883. THE HAWKINS CHILDREN'S LLC, EUGENE, OR. FILED 4-18-2006.

NOVELZINE

THE MARK CONSISTS OF STANDARD CHARACTERS WITHOUT CLAIM TO ANY PARTICULAR FONT, STYLE, SIZE, OR COLOR.

FOR SERIES OF BOOKS ON RELIGION, PRAYER, CHRISTIAN FAITH, AND SPIRITUAL GROWTH (U.S. CLS. 2, 5, 22, 23, 29, 37, 38 AND 50).
SKYE YOUNG, EXAMINING ATTORNEY

SN 78-863,908. GO NATUR'L STUDIOS, LLC, RIDGEFIELD, CT. FILED 4-18-2006.



THE MARK CONSISTS OF A LEAF DESIGN SURROUNDED BY AN INNER AND OUTER CIRCLE WITH THE WORDS "RUSTLE THE LEAF LEAVE IT GREEN" ENCOMPASSED WITHIN THE OUTER CIRCLE AND A SHADOW APPEARING UNDERNEATH THE LEAF DESIGN.

FOR ADHESIVE NOTE PADS; ART PADS; BATHROOM TISSUE; BLANK JOURNAL BOOKS; BLANK WRITING JOURNALS; BUSINESS RECORD BOOKS; CARDBOARD BOXES; CARDBOARD CARTONS; CARDBOARD PACKAGING; CHILDREN'S ACTIVITY BOOKS; COMPOSITION BOOKS; DOCUMENT COVERS; DOCUMENT PORTFOLIOS; DRAWING PADS; DRAWING PAPER; ENVELOPES; FACIAL TISSUE; FACSIMILE TRANSMISSION PAPER; FILLER PAPER; FOLDERS; GREETING CARDS; LASER PRINTING PAPER; LEGAL PADS; LETTERHEAD PAPER; MEMO PADS; NOTE BOOKS; NOTE PADS; NOTE PAPER; NOTEBOOK DIVIDERS; NOTEBOOK PAPER; OFFICE STATIONERY; PAPER NAPKINS; PAPER TABLE CLOTHS; PAPER TOWELS; PHOTOCOPY PAPERS; PRINTING PAPER; PROTECTIVE COVERS FOR SHEETS OR PAPER AND PAGES OF BOOKS AND THE LIKE; RECYCLED BOND PAPER; RECYCLED PAPER; SCRATCH PADS; SKETCH BOOKS; SKETCH PADS; SPIRAL NOTEBOOKS; STATIONERY; TOILET PAPER; TOILET SEAT COVER PAPER; TRACING PAPER; WRITING PAPER PADS (U.S. CLS. 2, 5, 22, 23, 29, 37, 38 AND 50).
WARREN L. OLANDRIA, EXAMINING ATTORNEY

CLASS 16—(Continued).

SN 78-864,161. PLATINUM GLOBAL, INC., CHINO, CA. FILED 4-18-2006.

SAND ADDICTION

THE MARK CONSISTS OF STANDARD CHARACTERS WITHOUT CLAIM TO ANY PARTICULAR FONT, STYLE, SIZE, OR COLOR.

FOR PRINTED MATERIALS, NAMELY, MAGAZINES, POSTERS, CALENDARS, AND STICKERS, RELATING TO OFF-ROAD VEHICLES, OFF-ROAD VEHICLE ACTIVITIES AND PRODUCTS AND OFF-ROAD VEHICLE RELATED ISSUES (U.S. CLS. 2, 5, 22, 23, 29, 37, 38 AND 50).

FIRST USE 5-30-2003; IN COMMERCE 5-30-2003.
CARYN GLASSER, EXAMINING ATTORNEY

SN 78-864,292. FIX, MICHELLE M., NEW YORK, NY. AND DUNLEAVY, VINCENT A., NEW YORK, NY. FILED 4-18-2006.

No Filter.

THE MARK CONSISTS OF STANDARD CHARACTERS WITHOUT CLAIM TO ANY PARTICULAR FONT, STYLE, SIZE, OR COLOR.

FOR BLANK JOURNAL BOOKS; BOOKMARKS; BUMPER STICKERS; COMIC BOOKS; DESK CALENDARS; DIARIES; GREETING CARDS; MEMORY BOOKS; NOTE BOOKS; NOTE CARDS; NOTE PADS; NOVELS; PENCILS; PENS; POSTCARDS; POSTERS; SERIES OF NON-FICTION BOOKS IN THE FIELD OF TELEVISION; STICKERS; TEMPORARY TATTOOS; WALL CALENDARS (U.S. CLS. 2, 5, 22, 23, 29, 37, 38 AND 50).

NANCY CLARKE, EXAMINING ATTORNEY

SN 78-864,789. HEALTHSIMPLE TOOLS, LLC, MINNEAPOLIS, MN. FILED 4-19-2006.

HEALTHSIMPLE

THE MARK CONSISTS OF STANDARD CHARACTERS WITHOUT CLAIM TO ANY PARTICULAR FONT, STYLE, SIZE, OR COLOR.

FOR PRINTED EDUCATIONAL MATERIALS, NAMELY, BOOKS, PAMPHLETS, PRINTED FLASHCARDS, WORKSHEETS AND PRINTED FLASHCARDS WITH MAGNETIC BACKINGS USED FOR HEALTH EDUCATION AND LIFESTYLE MAINTENANCE (U.S. CLS. 2, 5, 22, 23, 29, 37, 38 AND 50).

RUDY R. SINGLETON, EXAMINING ATTORNEY

CLASS 16—(Continued).

SN 78-864,836. DALER-ROWNEY USA LIMITED, CRANBURY, NJ. FILED 4-19-2006.

CACHET

THE MARK CONSISTS OF STANDARD CHARACTERS WITHOUT CLAIM TO ANY PARTICULAR FONT, STYLE, SIZE, OR COLOR.

FOR SKETCH BOOKS AND LINED AND UNLINED JOURNAL BOOKS (U.S. CLS. 2, 5, 22, 23, 29, 37, 38 AND 50).

FIRST USE 5-1-1987; IN COMMERCE 5-1-1987.
SONYA STEPHENS, EXAMINING ATTORNEY

SN 78-865,349. SUNRISE GLOBAL DEVELOPMENT CO., LTD., TAIPEI HSIEN, TAIWAN, FILED 4-19-2006.

SUNRISE

THE MARK CONSISTS OF STANDARD CHARACTERS WITHOUT CLAIM TO ANY PARTICULAR FONT, STYLE, SIZE, OR COLOR.

FOR PAPER SHREDDERS (U.S. CLS. 2, 5, 22, 23, 29, 37, 38 AND 50).

FIRST USE 7-0-2001; IN COMMERCE 2-0-2002.
SONYA STEPHENS, EXAMINING ATTORNEY

SN 78-865,368. DOWDEN HEALTH MEDIA, INC., NEW YORK, NY. FILED 4-19-2006.

MORRIS HEALTH & LIFE

THE MARK CONSISTS OF STANDARD CHARACTERS WITHOUT CLAIM TO ANY PARTICULAR FONT, STYLE, SIZE, OR COLOR.

NO CLAIM IS MADE TO THE EXCLUSIVE RIGHT TO USE "HEALTH AND LIFE", APART FROM THE MARK AS SHOWN.

FOR MAGAZINE FEATURING ARTICLES ON GOOD HEALTH PRACTICES, MEDICAL THERAPIES AND PEOPLE OF INTEREST (U.S. CLS. 2, 5, 22, 23, 29, 37, 38 AND 50).

FIRST USE 12-31-2002; IN COMMERCE 3-31-2003.
MARIA-VICTORIA SUAREZ, EXAMINING ATTORNEY

CLASS 16—(Continued).

SN 78-865,536. MEADWESTVACO CORPORATION, STAMFORD, CT. FILED 4-20-2006.

PRINTKOTE ADVANTAGE

THE MARK CONSISTS OF STANDARD CHARACTERS WITHOUT CLAIM TO ANY PARTICULAR FONT, STYLE, SIZE, OR COLOR.

OWNER OF U.S. REG. NOS. 845,009, 2,721,151 AND OTHERS.

FOR PAPERBOARD (U.S. CLS. 2, 5, 22, 23, 29, 37, 38 AND 50).

FIRST USE 5-19-1998; IN COMMERCE 5-19-1998.
GINA HAYES, EXAMINING ATTORNEY

SN 78-865,547. MEADWESTVACO CORPORATION, STAMFORD, CT. FILED 4-20-2006.

FOR THE GIFT OF ART

THE MARK CONSISTS OF STANDARD CHARACTERS WITHOUT CLAIM TO ANY PARTICULAR FONT, STYLE, SIZE, OR COLOR.

OWNER OF U.S. REG. NOS. 2,265,316 AND 2,494,367.

FOR IMPRINTABLE STATIONERY, MEMO BOXES, MEMO TRAYS, PAPERBOARD BOXES, MESSAGE BOARDS, CHALKBOARDS (U.S. CLS. 2, 5, 22, 23, 29, 37, 38 AND 50).

FIRST USE 12-31-2002; IN COMMERCE 12-31-2002.
GINA HAYES, EXAMINING ATTORNEY

SN 78-865,617. SCHOLASTIC INC., NEW YORK, NY. FILED 4-20-2006.



FOR EDUCATIONAL READING MATERIALS, NAMELY CHILDREN'S BOOKS, ACTIVITY BOOKS AND WORKBOOKS; PRINTED PAPER LEARNING TOOLS FOR EARLY LITERACY, NAMELY TEACHING GUIDES, DESKTOP POCKET CHARTS, LEARNING MATS, FLASH CARDS, PRINTED READING CARDS, PRINTED PICTURE CARDS, AND TILES FEATURING LETTERS, NUMBERS AND WORD PARTS, ALL SOLD INDIVIDUALLY AND AS A UNIT (U.S. CLS. 2, 5, 22, 23, 29, 37, 38 AND 50).

FIRST USE 12-15-2005; IN COMMERCE 12-15-2005.
ANDREA EVANS, EXAMINING ATTORNEY

CLASS 16—(Continued).

SN 78-865,662. GO NATUR'L STUDIOS, LLC, RIDGEFIELD, CT. FILED 4-20-2006.



THE MARK CONSISTS OF A LEAF DESIGN WITH BENDABLE STEM AND UNDERLYING SHADOW.

FOR ANIMATION CELS; ART PRINTS; CARTOON PRINTS; CARTOON STRIPS; CHILDREN'S ACTIVITY BOOKS; CHILDREN'S BOOKS; CHILDREN'S STORYBOOKS; CHRISTMAS CARDS; COLORING BOOKS; COMIC BOOKS; COMIC STRIPS; COMIC STRIPS' COMIC FEATURES; CROSSWORD PUZZLES; FOLDERS; GREETING CARDS; HOLIDAY CARDS; NEWSPAPER COMIC STRIPS; NOTE BOOKS; NOTEBOOK DIVIDERS; OCCASION CARDS; POSTCARDS; POSTERS; POSTERS MADE OF PAPER; PRINTED INSTRUCTIONAL, EDUCATIONAL, AND TEACHING MATERIALS IN THE FIELD OF ENVIRONMENTAL ISSUES; PRINTED TEACHING ACTIVITY GUIDES IN THE FIELD OF ENVIRONMENTAL ISSUES; PRINTS IN THE NATURE OF CARTOON ART; RECYCLED PAPER; SKETCH PADS; WALL CALENDARS; WORKBOOKS DIRECTED TO ENVIRONMENTAL ISSUES (U.S. CLS. 2, 5, 22, 23, 29, 37, 38 AND 50).

FIRST USE 10-0-2004; IN COMMERCE 11-0-2004.
WARREN L. OLANDRIA, EXAMINING ATTORNEY

SN 78-865,751. WHATEVERLIFE, INC., LINCOLN PARK, MI. FILED 4-20-2006.

whateverlife

THE MARK CONSISTS OF STANDARD CHARACTERS WITHOUT CLAIM TO ANY PARTICULAR FONT, STYLE, SIZE, OR COLOR.

FOR PRINTED PUBLICATIONS, NAMELY, BOOKS, MAGAZINES, AND PAMPHLETS FEATURING ADVERTISING, TUTORIALS, WEB-LINKS, WEB ASSOCIATED IMAGES AND GRAPHICS, SOFTWARE CODE, AND WEB PAGE INFORMATION (U.S. CLS. 2, 5, 22, 23, 29, 37, 38 AND 50).

SKYE YOUNG, EXAMINING ATTORNEY

CLASS 16—(Continued).

SN 78-865,926. SHAPIRO, BARRY H., NEW YORK, NY.
FILED 4-20-2006.

TALES FROM THE PUBLIC DOMAIN

THE MARK CONSISTS OF STANDARD CHARACTERS
WITHOUT CLAIM TO ANY PARTICULAR FONT, STYLE,
SIZE, OR COLOR.

FOR COMIC BOOKS (U.S. CLS. 2, 5, 22, 23, 29, 37, 38
AND 50).

NAKIA HENRY, EXAMINING ATTORNEY

SN 78-865,979. PLOWMAN, RICHARD TERRY, REHOBOTH
BEACH, DE. FILED 4-20-2006.

Coastal Style

THE MARK CONSISTS OF STANDARD CHARACTERS
WITHOUT CLAIM TO ANY PARTICULAR FONT, STYLE,
SIZE, OR COLOR.

NO CLAIM IS MADE TO THE EXCLUSIVE RIGHT TO
USE "STYLE", APART FROM THE MARK AS SHOWN.

FOR GENERAL FEATURE MAGAZINES (U.S. CLS. 2,
5, 22, 23, 29, 37, 38 AND 50).

CYNTHIA SLOAN, EXAMINING ATTORNEY

SN 78-866,000. MELITTA HAUSHALTSPRODUKTE GMBH &
CO. KG, MINDEN, FED REP GERMANY, FILED 4-20-
2006.

INDULGE A LITTLE EVERY DAY

THE MARK CONSISTS OF STANDARD CHARACTERS
WITHOUT CLAIM TO ANY PARTICULAR FONT, STYLE,
SIZE, OR COLOR.

OWNER OF U.S. REG. NO. 2,718,026.
FOR COFFEE FILTERS, NAMELY COFFEE FILTER
PAPER (U.S. CLS. 2, 5, 22, 23, 29, 37, 38 AND 50).

FIRST USE 0-0-2002; IN COMMERCE 0-0-2002.

TINA BROWN, EXAMINING ATTORNEY

CLASS 16—(Continued).

SN 78-866,668. ASC PROMOTIONS, INC., DAYTONA
BEACH, FL. FILED 4-21-2006.

RACINGONE

THE MARK CONSISTS OF STANDARD CHARACTERS
WITHOUT CLAIM TO ANY PARTICULAR FONT, STYLE,
SIZE, OR COLOR.

OWNER OF U.S. REG. NOS. 2,549,934 AND 3,141,892.

FOR PUBLICATIONS, NAMELY, BOOKS, MAGA-
ZINES AND NEWSLETTERS IN THE FIELD OF MO-
TOSPORTS RACING (U.S. CLS. 2, 5, 22, 23, 29, 37, 38
AND 50).

TARAH HARDY, EXAMINING ATTORNEY

SN 78-866,795. SIAS INC., BROOKLYN, NY. FILED 4-21-2006.

ARCHIVE

THE MARK CONSISTS OF STANDARD CHARACTERS
WITHOUT CLAIM TO ANY PARTICULAR FONT, STYLE,
SIZE, OR COLOR.

FOR BOOKS IN THE FIELD OF CLOTHING, FASH-
ION TRENDS, STYLES AND INFORMATION ABOUT
THE GARMENT INDUSTRY (U.S. CLS. 2, 5, 22, 23, 29, 37,
38 AND 50).

TARAH HARDY, EXAMINING ATTORNEY

SN 78-866,886. TIME4 MEDIA, INC., NEW YORK, NY. FILED
4-21-2006.

GO BIGGER // LIVE BETTER

THE MARK CONSISTS OF STANDARD CHARACTERS
WITHOUT CLAIM TO ANY PARTICULAR FONT, STYLE,
SIZE, OR COLOR.

FOR MAGAZINES FEATURING TOPICS OF SPORTS,
ATHLETIC TRAINING, TRAVEL, AND LIFESTYLES
(U.S. CLS. 2, 5, 22, 23, 29, 37, 38 AND 50).

FIRST USE 9-30-2005; IN COMMERCE 9-30-2005.

KIMBERLY FRYE, EXAMINING ATTORNEY

CLASS 16—(Continued).

SN 78-867,465. CHAMPU SALON, LLC, PEORIA, AZ. FILED 4-22-2006.

Cutsultation

THE MARK CONSISTS OF STANDARD CHARACTERS WITHOUT CLAIM TO ANY PARTICULAR FONT, STYLE, SIZE, OR COLOR.

FOR PRINTED INFORMATIONAL CARDS IN THE FIELD OF COSMETOLOGY (U.S. CLS. 2, 5, 22, 23, 29, 37, 38 AND 50).

FIRST USE 6-10-2005; IN COMMERCE 3-29-2006.
CATHERINE FAINT, EXAMINING ATTORNEY

CLASS 16—(Continued).

SN 78-868,564. CORPORATE ALLIANCE OF UTAH, INC., PROVO, UT. FILED 4-24-2006.

INFLUENCE

THE MARK CONSISTS OF STANDARD CHARACTERS WITHOUT CLAIM TO ANY PARTICULAR FONT, STYLE, SIZE, OR COLOR.

FOR PRINTED PERIODICALS IN THE FIELD OF BUSINESS NETWORKING (U.S. CLS. 2, 5, 22, 23, 29, 37, 38 AND 50).

KEVON CHISOLM, EXAMINING ATTORNEY

SN 78-867,744. CANON COMMUNICATIONS, LLC, LOS ANGELES, CA. FILED 4-24-2006.

MEDICAL DEVICE TECHNOLOGY

THE MARK CONSISTS OF STANDARD CHARACTERS WITHOUT CLAIM TO ANY PARTICULAR FONT, STYLE, SIZE, OR COLOR.

SEC. 2(F).
FOR MAGAZINES AND TRADE JOURNALS RELATED TO MEDICAL PRODUCT MANUFACTURERS (U.S. CLS. 2, 5, 22, 23, 29, 37, 38 AND 50).

FIRST USE 6-0-1990; IN COMMERCE 6-0-1990.
JIM RINGLE, EXAMINING ATTORNEY

SN 78-868,630. TRUE LABEL, INC., TOLEDO, OH. FILED 4-25-2006.

NON-MAGNET MAGNET

THE MARK CONSISTS OF STANDARD CHARACTERS WITHOUT CLAIM TO ANY PARTICULAR FONT, STYLE, SIZE, OR COLOR.

FOR ADHESIVE LABELS (U.S. CLS. 2, 5, 22, 23, 29, 37, 38 AND 50).

AMY GEARIN, EXAMINING ATTORNEY

SN 78-868,390. MURRAY, ROBERT CRAIG, INGLEWOOD, CA. FILED 4-24-2006.

SOFTWARE IT'S AT

THE MARK CONSISTS OF STANDARD CHARACTERS WITHOUT CLAIM TO ANY PARTICULAR FONT, STYLE, SIZE, OR COLOR.

FOR COMIC STRIPS (U.S. CLS. 2, 5, 22, 23, 29, 37, 38 AND 50).

FIRST USE 10-19-1999; IN COMMERCE 10-19-1999.
MARIA-VICTORIA SUAREZ, EXAMINING ATTORNEY

SN 78-868,824. HICKS, JERRY S., SAN ANTONIO, TX. AND HICKS, ESTHER W., SAN ANTONIO, TX. FILED 4-25-2006.

**THE SCIENCE OF DELIBERATE
CREATION**

THE MARK CONSISTS OF STANDARD CHARACTERS WITHOUT CLAIM TO ANY PARTICULAR FONT, STYLE, SIZE, OR COLOR.

FOR QUARTERLY JOURNALS AND CATALOGS, BOOKS, ALL IN THE FIELD OF INSPIRATION AND SELF ESTEEM (U.S. CLS. 2, 5, 22, 23, 29, 37, 38 AND 50).

FIRST USE 12-31-1988; IN COMMERCE 12-31-1988.
JOHN GARTNER, EXAMINING ATTORNEY

CLASS 16—(Continued).

SN 78-868,885. FUJI PHOTO FILM U.S.A., INC., VALHALLA, NY. FILED 4-25-2006.

YourStamps

THE MARK CONSISTS OF STANDARD CHARACTERS WITHOUT CLAIM TO ANY PARTICULAR FONT, STYLE, SIZE, OR COLOR.

FOR POSTAGE STAMPS CONTAINING PHOTOGRAPHIC REPRODUCTIONS (U.S. CLS. 2, 5, 22, 23, 29, 37, 38 AND 50).

ALLISON HOLTZ, EXAMINING ATTORNEY

SN 78-868,986. ULI-THE URBAN LAND INSTITUTE, WASHINGTON, DC. FILED 4-25-2006.

MYTH AND FACT

THE MARK CONSISTS OF STANDARD CHARACTERS WITHOUT CLAIM TO ANY PARTICULAR FONT, STYLE, SIZE, OR COLOR.

OWNER OF U.S. REG. NOS. 2,360,953 AND 2,445,321.

FOR PERIODIC PUBLICATIONS, NAMELY PAMPHLETS, BROCHURES, NEWSLETTERS, JOURNALS AND MAGAZINES RELATING TO REAL ESTATE AND TRANSPORTATION (U.S. CLS. 2, 5, 22, 23, 29, 37, 38 AND 50).

FIRST USE 1-1-1996; IN COMMERCE 1-1-1966.
CAROLYN GRAY, EXAMINING ATTORNEY

SN 78-869,445. SEGAL, POLLY, LOS ANGELES, CA. FILED 4-25-2006.

Repeat Defender

FOR PAPER TAGS (U.S. CLS. 2, 5, 22, 23, 29, 37, 38 AND 50).

ESTHER BELENKER, EXAMINING ATTORNEY

CLASS 16—(Continued).

SN 78-869,886. VALUE PUBLICATIONS, INC., QUEEN CREEK, AZ. FILED 4-26-2006.

Smart Saver

THE MARK CONSISTS OF STANDARD CHARACTERS WITHOUT CLAIM TO ANY PARTICULAR FONT, STYLE, SIZE, OR COLOR.

FOR PRINT MATERIALS, NAMELY PUBLICATIONS FOR OTHERS IN THE NATURE OF COUPON BOOKS, PERIODICALS, AND MAGAZINES AND DISCOUNT CATALOGS COMPRISED OF ADVERTISING IN THE FORM OF OFF-PRICE COUPONS TO BE USED BY CONSUMERS IN PURCHASING THE GOODS AND SERVICES ADVERTISED (U.S. CLS. 2, 5, 22, 23, 29, 37, 38 AND 50).

FIRST USE 1-20-2006; IN COMMERCE 3-31-2006.
KATINA MISTER, EXAMINING ATTORNEY

SN 78-870,583. COTHERIX, INC., SOUTH SAN FRANCISCO, CA. FILED 4-26-2006.

TRANSFORMING PAH EXPERIENCE INTO KNOWLEDGE

THE MARK CONSISTS OF STANDARD CHARACTERS WITHOUT CLAIM TO ANY PARTICULAR FONT, STYLE, SIZE, OR COLOR.

FOR PUBLICATIONS, NAMELY, NEWSLETTERS, REPORTS, AND BROCHURES FEATURING INFORMATION IN THE FIELD OF PULMONARY ARTERIAL HYPERTENSION (U.S. CLS. 2, 5, 22, 23, 29, 37, 38 AND 50).

JASON ROTH, EXAMINING ATTORNEY

SN 78-871,118. WISDOM STAR CORPORATION, FREEHOLD, NJ. FILED 4-27-2006.

Wisdom Star

THE MARK CONSISTS OF STANDARD CHARACTERS WITHOUT CLAIM TO ANY PARTICULAR FONT, STYLE, SIZE, OR COLOR.

FOR GREETING CARDS (U.S. CLS. 2, 5, 22, 23, 29, 37, 38 AND 50).

NICHOLAS ALTREE, EXAMINING ATTORNEY

CLASS 16—(Continued).

SN 78-872,144. SCHOLASTIC INC., NEW YORK, NY. FILED 4-28-2006.



FOR SERIES OF FICTION BOOKS FOR CHILDREN (U.S. CLS. 2, 5, 22, 23, 29, 37, 38 AND 50).
ANDREA EVANS, EXAMINING ATTORNEY

SN 78-872,557. SCHOLASTIC INC., NEW YORK, NY. FILED 4-28-2006.

TIME FLIES

THE MARK CONSISTS OF STANDARD CHARACTERS WITHOUT CLAIM TO ANY PARTICULAR FONT, STYLE, SIZE, OR COLOR.
FOR A SERIES OF BOOKS FOR CHILDREN (U.S. CLS. 2, 5, 22, 23, 29, 37, 38 AND 50).
ANDREA EVANS, EXAMINING ATTORNEY

SN 78-872,853. MIPAD DE P.R., INC., GUAYNABO, PUERTO RICO, FILED 4-29-2006.

FOXTAIL

THE MARK CONSISTS OF STANDARD CHARACTERS WITHOUT CLAIM TO ANY PARTICULAR FONT, STYLE, SIZE, OR COLOR.
FOR PAINT BRUSHES (U.S. CLS. 2, 5, 22, 23, 29, 37, 38 AND 50).
FIRST USE 9-5-2000; IN COMMERCE 9-5-2000.
HEATHER SAPP, EXAMINING ATTORNEY

CLASS 16—(Continued).

SN 78-873,784. COTHERIX, INC., SOUTH SAN FRANCISCO, CA. FILED 5-1-2006.

REVEAL

FOR PUBLICATIONS, NAMELY, NEWSLETTERS, REPORTS, AND BROCHURES FEATURING INFORMATION IN THE FIELD OF PULMONARY ARTERIAL HYPERTENSION (U.S. CLS. 2, 5, 22, 23, 29, 37, 38 AND 50).
JASON ROTH, EXAMINING ATTORNEY

SN 78-874,022. MEADWESTVACO CORPORATION, STAMFORD, CT. FILED 5-2-2006.

WHIMSICAL FLOWERS

THE MARK CONSISTS OF STANDARD CHARACTERS WITHOUT CLAIM TO ANY PARTICULAR FONT, STYLE, SIZE, OR COLOR.
FOR DESK PADS, DATE PLANNERS, PERSONAL ORGANIZERS, STUDENT ASSIGNMENT BOOKS (U.S. CLS. 2, 5, 22, 23, 29, 37, 38 AND 50).
GINA HAYES, EXAMINING ATTORNEY

SN 78-874,716. LISA FRANK, INC., TUCSON, AZ. FILED 5-2-2006.

FASHION CRAZY FUN!

THE MARK CONSISTS OF STANDARD CHARACTERS WITHOUT CLAIM TO ANY PARTICULAR FONT, STYLE, SIZE, OR COLOR.
FOR CHILDREN'S STATIONERY SET CONSISTING OF TWO OR MORE OF THE FOLLOWING ITEMS: MARKERS, NOTE PADS, PENS, PENCILS, RUBBER STAMPS, FOAM STAMPS, STICKERS, SKETCH BOOK, ENVELOPES, ALL SOLD AS A UNIT, CHILDREN'S PAINTING AND DRAWING KITS (U.S. CLS. 2, 5, 22, 23, 29, 37, 38 AND 50).
HENRY S. ZAK, EXAMINING ATTORNEY

CLASS 16—(Continued).

SN 78-883,311. PRICEWATERHOUSECOOPERS LLP, NEW YORK, NY. FILED 5-15-2006.

ENGAGEMENT INTELLIGENCE

THE MARK CONSISTS OF STANDARD CHARACTERS WITHOUT CLAIM TO ANY PARTICULAR FONT, STYLE, SIZE, OR COLOR.

NO CLAIM IS MADE TO THE EXCLUSIVE RIGHT TO USE "INTELLIGENCE", APART FROM THE MARK AS SHOWN.

FOR PRINTED REPORTS AND SURVEYS IN THE FIELD OF HUMAN RESOURCES (U.S. CLS. 2, 5, 22, 23, 29, 37, 38 AND 50).

DAVID TAYLOR, EXAMINING ATTORNEY

CLASS 16—(Continued).

SN 78-887,455. CELLYNNE CORPORATION, HAINES CITY, FL. FILED 5-19-2006.

CELLUSOFT

THE MARK CONSISTS OF STANDARD CHARACTERS WITHOUT CLAIM TO ANY PARTICULAR FONT, STYLE, SIZE, OR COLOR.

FOR TOILET TISSUE AND PAPER TOWELS (U.S. CLS. 2, 5, 22, 23, 29, 37, 38 AND 50).

KAREN BRACEY, EXAMINING ATTORNEY

SN 78-887,424. MEADWESTVACO CORPORATION, STAMFORD, CT. FILED 5-19-2006.

EXO

THE MARK CONSISTS OF STANDARD CHARACTERS WITHOUT CLAIM TO ANY PARTICULAR FONT, STYLE, SIZE, OR COLOR.

FOR BINDERS, STATIONERY-TYPE PORTFOLIOS, NOTEBOOKS, MEMO BOOKS AND PADS (U.S. CLS. 2, 5, 22, 23, 29, 37, 38 AND 50).

GINA HAYES, EXAMINING ATTORNEY

SN 78-887,486. MEADWESTVACO CORPORATION, STAMFORD, CT. FILED 5-19-2006.

CUSTOMYZE

THE MARK CONSISTS OF STANDARD CHARACTERS WITHOUT CLAIM TO ANY PARTICULAR FONT, STYLE, SIZE, OR COLOR.

FOR DATE PLANNERS, PERSONAL ORGANIZERS, STUDENT ASSIGNMENT BOOKS (U.S. CLS. 2, 5, 22, 23, 29, 37, 38 AND 50).

GINA HAYES, EXAMINING ATTORNEY

SN 78-887,433. MEADWESTVACO CORPORATION, STAMFORD, CT. FILED 5-19-2006.



FOR BINDERS, STATIONERY-TYPE PORTFOLIOS, NOTEBOOKS, MEMO BOOKS AND PADS (U.S. CLS. 2, 5, 22, 23, 29, 37, 38 AND 50).

GINA HAYES, EXAMINING ATTORNEY

SN 78-887,499. MEADWESTVACO CORPORATION, STAMFORD, CT. FILED 5-19-2006.



FOR DATE PLANNERS, PERSONAL ORGANIZERS, STUDENT ASSIGNMENT BOOKS (U.S. CLS. 2, 5, 22, 23, 29, 37, 38 AND 50).

GINA HAYES, EXAMINING ATTORNEY

CLASS 16—(Continued).

SN 78-890,395. HOODLOVE LIMITED LIABILITY COMPANY, EAST ORANGE, NJ. FILED 5-24-2006.

HOOD LOVE

THE MARK CONSISTS OF STANDARD CHARACTERS WITHOUT CLAIM TO ANY PARTICULAR FONT, STYLE, SIZE, OR COLOR.

FOR ADHESIVE LABELS; BAR CODE LABELS; BOOK COVERS; BOOK-COVER PAPER; BUMPER STICKERS; ERASERS; GARBAGE BAGS OF PLASTIC; INK PENS; LEATHER APPOINTMENT BOOK COVERS; LEATHER BOOK COVERS; MAGAZINES FEATURING URBAN LIFESTYLE, SPORTS, MUSIC AND ENTERTAINMENT; PAPER BANNERS; PAPER LABELS; PAPER PARTY FAVORS; PENCIL BOXES; PENCIL SHARPENERS; PENCILS; PHOTO MATS; PICTURE FRAMING MAT BOARDS; PRINTED PAPER LABELS; PROTECTIVE COVERS FOR BOOKS; PROTECTIVE COVERS FOR SHEETS OR PAPER AND PAGES OF BOOKS AND THE LIKE; RUBBER ERASERS; STANDS FOR PENS; STICKERS; STICKERS; TRASH BAGS; TRASH CAN LINERS (U.S. CLS. 2, 5, 22, 23, 29, 37, 38 AND 50).

BARBARA BROWN, EXAMINING ATTORNEY

SN 78-896,291. LISA FRANK, INC., TUCSON, AZ. FILED 5-30-2006.

DANCING DOLPHINS

THE MARK CONSISTS OF STANDARD CHARACTERS WITHOUT CLAIM TO ANY PARTICULAR FONT, STYLE, SIZE, OR COLOR.

FOR PRINTED ITEMS, NAMELY, STATIONERY-TYPE PORTFOLIOS (U.S. CLS. 2, 5, 22, 23, 29, 37, 38 AND 50).
FIRST USE 5-18-2006; IN COMMERCE 5-18-2006.
HENRY S. ZAK, EXAMINING ATTORNEY

CLASS 16—(Continued).

SN 78-899,261. CUSTOM DIRECT, LLC, JOPPA, MD. FILED 6-2-2006.

ARTISTIC CHECKS

THE MARK CONSISTS OF STANDARD CHARACTERS WITHOUT CLAIM TO ANY PARTICULAR FONT, STYLE, SIZE, OR COLOR.

NO CLAIM IS MADE TO THE EXCLUSIVE RIGHT TO USE "CHECKS", APART FROM THE MARK AS SHOWN.

FOR PRINTED MATTER, NAMELY, BANK CHECKS, BANK DEPOSIT SLIPS, CHECK REGISTERS, CHECK-BOOK COVERS, PERSONAL CONTACT CARDS, ADDRESS LABELS, INK STAMPS, PERSONAL ORGANIZERS, DESKTOP ORGANIZERS, ADDRESS BOOKS, BLANK NOTE CARDS, AND MEMORY BOOKS, NAMELY, PHOTO ALBUMS AND SCRAPBOOKS (U.S. CLS. 2, 5, 22, 23, 29, 37, 38 AND 50).

FIRST USE 8-1-1993; IN COMMERCE 8-1-1993.

STEPHANIE DAVIS, EXAMINING ATTORNEY

SN 78-899,522. YUEN FOONG YU PAPER MFG. CO., LTD., TAIPEI CITY, TAIWAN, FILED 6-2-2006.



Beautiful color, Beautiful image

FOR ART PAPER; REEL PAPER FOR MULTI-FUNCTION PRINTER; PAPER FOR MULTI-FUNCTION PRINTER; BOND PAPER; BLOTTING PAPER; PLASTIC-COATED COPYING PAPER; PAPER FOR INKJET PRINTER; GIFT WRAPPING PAPER; PHOTOGRAPHIC PAPER FOR INKJET PRINTER (U.S. CLS. 2, 5, 22, 23, 29, 37, 38 AND 50).

SHARI SHEFFIELD, EXAMINING ATTORNEY

SN 78-904,639. LISA FRANK, INC., TUCSON, AZ. FILED 6-9-2006.

PAINT n' PLAY

THE MARK CONSISTS OF STANDARD CHARACTERS WITHOUT CLAIM TO ANY PARTICULAR FONT, STYLE, SIZE, OR COLOR.

OWNER OF U.S. REG. NO. 2,287,793.

FOR CHILDREN'S PAINT KIT COMPRISING TWO OR MORE OF THE FOLLOWING— PAINT BRUSHES, PAINTS, PAINT CONTAINERS, PRINTED CARDS WITH DRAWINGS FOR PAINTING, ALL SOLD AS A UNIT (U.S. CLS. 2, 5, 22, 23, 29, 37, 38 AND 50).

FIRST USE 11-11-2004; IN COMMERCE 11-11-2004.

HENRY S. ZAK, EXAMINING ATTORNEY

CLASS 16—(Continued).

SN 78-906,237. LABOR SYSTEMS, INC., CHANDLER, AZ.
FILED 6-12-2006.

CUT THE CRAP ... LET'S GET
REAL!

THE MARK CONSISTS OF STANDARD CHARACTERS
WITHOUT CLAIM TO ANY PARTICULAR FONT, STYLE,
SIZE, OR COLOR.

FOR EDUCATIONAL BOOKS IN THE FIELD OF
LEADERSHIP, PERSONAL MOTIVATION AND DEVEL-
OPMENT, AND EDUCATION; EDUCATIONAL PUBLI-
CATIONS, NAMELY, TRAINING MANUALS IN THE
FIELD OF LEADERSHIP, PERSONAL MOTIVATION
AND DEVELOPMENT, AND EDUCATION; PRINTED
INSTRUCTIONAL, EDUCATIONAL, AND TEACHING
MATERIALS IN THE FIELD OF LEADERSHIP, PERSONAL
MOTIVATION AND DEVELOPMENT, AND EDU-
CATION (U.S. CLS. 2, 5, 22, 23, 29, 37, 38 AND 50).

PAULA MAHONEY, EXAMINING ATTORNEY

CLASS 16—(Continued).

SN 79-022,494. SAVE AS PTY LTD, AUSTRALIA, FILED 12-8-
2005.

picturegraph

THE MARK CONSISTS OF STANDARD CHARACTERS
WITHOUT CLAIM TO ANY PARTICULAR FONT, STYLE,
SIZE, OR COLOR.

OWNER OF INTERNATIONAL REGISTRATION 0881353
DATED 12-8-2005, EXPIRES 12-8-2015.

FOR PHOTOGRAPH PICTURES (U.S. CLS. 2, 5, 22, 23,
29, 37, 38 AND 50).

ELI HELLMAN, EXAMINING ATTORNEY

SN 78-907,910. ADP, INC., ROSELAND, NJ. FILED 6-14-2006.

IPLAN ISAVE IBENEFIT

THE MARK CONSISTS OF STANDARD CHARACTERS
WITHOUT CLAIM TO ANY PARTICULAR FONT, STYLE,
SIZE, OR COLOR.

FOR PRINTED MATERIALS, NAMELY, INSTRU-
CTIONAL MANUALS, FLYERS, BROCHURES, POSTERS,
NEWSLETTERS, AND ENROLLMENT FORMS IN THE
FIELD OF EMPLOYEE EDUCATION FOR RETIRE-
MENT PLANNING (U.S. CLS. 2, 5, 22, 23, 29, 37, 38
AND 50).

JAMES GRIFFIN, EXAMINING ATTORNEY

CLASS 17—RUBBER GOODS

SN 78-590,062. MANSON INSULATION INC., BROSSARD,
CANADA, FILED 3-18-2005.

AK BOARD

SN 78-940,097. WEINGARTEN, RACHEL C, BROOKLYN,
NY. FILED 7-28-2006.

Career and Corporate Cool

THE MARK CONSISTS OF STANDARD CHARACTERS
WITHOUT CLAIM TO ANY PARTICULAR FONT, STYLE,
SIZE, OR COLOR.

NO CLAIM IS MADE TO THE EXCLUSIVE RIGHT TO
USE "CAREER AND CORPORATE", APART FROM THE
MARK AS SHOWN.

FOR BOOKS IN THE FIELD OF BUSINESS STYLE
GUIDES (U.S. CLS. 2, 5, 22, 23, 29, 37, 38 AND 50).

KRISTIN DAHLING, EXAMINING ATTORNEY

THE MARK CONSISTS OF STANDARD CHARACTERS
WITHOUT CLAIM TO ANY PARTICULAR FONT, STYLE,
SIZE, OR COLOR.

PRIORITY CLAIMED UNDER SEC. 44(D) ON CANADA
APPLICATION NO. 1251531, FILED 3-16-2005, REG. NO.
TMA667,385, DATED 7-12-2006, EXPIRES 7-12-2021.

NO CLAIM IS MADE TO THE EXCLUSIVE RIGHT TO
USE "BOARD", APART FROM THE MARK AS SHOWN.

FOR RIGID AND SEMI-RIGID THERMAL INSULA-
TION PANELS (U.S. CLS. 1, 5, 12, 13, 35 AND 50).

MARTHA SANTOMARTINO, EXAMINING ATTORNEY

CLASS 17—(Continued).

SN 78-603,104. GUOLENE WOVEN PRODUCTS (MELAKA) SND. BHD., MELAKA, MALAYSIA, FILED 4-6-2005.

PRIMERA

THE MARK CONSISTS OF STANDARD CHARACTERS WITHOUT CLAIM TO ANY PARTICULAR FONT, STYLE, SIZE, OR COLOR.

THE ENGLISH TRANSLATION OF THE WORDING "PRIMERA" IS "FIRST."

FOR INSULATING MATERIALS AND SUBSTANCES FOR INSULATING BUILDINGS AGAINST MOISTURE, NAMELY, RUBBER, GUTTA-PERCHA, GUM, ASBESTOS, MICA, PLASTICS IN EXTRUDED FORM PACKED AND USED AS INSULATING MATERIALS (U.S. CLS. 1, 5, 12, 13, 35 AND 50).

KRISTIN DAHLING, EXAMINING ATTORNEY

SN 78-658,962. KAO KABUSHIKI KAISHA, TA KAO CORPORATION, CHUO-KU, TOKYO, JAPAN, FILED 6-27-2005.

EG RUNNER

THE MARK CONSISTS OF STANDARD CHARACTERS WITHOUT CLAIM TO ANY PARTICULAR FONT, STYLE, SIZE, OR COLOR.

FOR NON-METALLIC PIPES FOR INDUSTRIAL USE, NAMELY, A DISPOSABLE USE PIPE MADE OF RECYCLED PULP USED FOR MOLTEN METAL FLOW INTO MOULDS (U.S. CLS. 1, 5, 12, 13, 35 AND 50).

IRENE D. WILLIAMS, EXAMINING ATTORNEY

CLASS 17—(Continued).

SN 78-659,904. NEWAGE INDUSTRIES, INC., SOUTHAMPTON, PA. FILED 6-28-2005.

NYLOTUBE

THE MARK CONSISTS OF STANDARD CHARACTERS WITHOUT CLAIM TO ANY PARTICULAR FONT, STYLE, SIZE, OR COLOR.

FOR INDUSTRIAL TUBING MADE OF NYLON FOR COMMERCIAL AND INDUSTRIAL APPLICATIONS, NAMELY FOR COMPRESSED AIR LINES, INSTRUMENTATION EQUIPMENT, GREASE LINES, FUEL AND OIL LINES, DISPENSING EQUIPMENT, REFRIGERATION, COOLANT LINES, HYDRAULIC LINES, LABORATORY USE, CHEMICAL TRANSFER, AIR CONDITIONING AND FOOD AND BEVERAGE DISPENSING EQUIPMENT (U.S. CLS. 1, 5, 12, 13, 35 AND 50).

FIRST USE 1-0-1974; IN COMMERCE 5-15-1974.

MARIAM MAHMOUDI, EXAMINING ATTORNEY

SN 78-685,943. GAZELLE'S OILFIELD SERVICE LTD., BRETON, ALBERTA, CANADA, FILED 8-4-2005.

INSULATION SNAKES

THE MARK CONSISTS OF STANDARD CHARACTERS WITHOUT CLAIM TO ANY PARTICULAR FONT, STYLE, SIZE, OR COLOR.

OWNER OF CANADA REG. NO. TMA486209, DATED 11-25-1997, EXPIRES 11-25-2012.

NO CLAIM IS MADE TO THE EXCLUSIVE RIGHT TO USE "INSULATION", APART FROM THE MARK AS SHOWN.

FOR INSULATION BATTING FOR PIPES (U.S. CLS. 1, 5, 12, 13, 35 AND 50).

FIRST USE 12-31-1998; IN COMMERCE 12-31-1998.

LEIGH CAROLINE CASE, EXAMINING ATTORNEY

SN 78-736,514. LARGE FORMAT DIGITAL, MADISON, WI. FILED 10-19-2005.

+ CollidEscape +

THE MARK CONSISTS OF STANDARD CHARACTERS WITHOUT CLAIM TO ANY PARTICULAR FONT, STYLE, SIZE, OR COLOR.

FOR PERFORATED WINDOW VINYL USED TO PREVENT BIRD STRIKES AGAINST WINDOWS BY REDUCING WINDOW TRANSPARENCY AND REFLECTIVITY (U.S. CLS. 1, 5, 12, 13, 35 AND 50).

FIRST USE 5-1-2005; IN COMMERCE 6-1-2005.

DARRYL SPRUILL, EXAMINING ATTORNEY

CLASS 17—(Continued).

SN 78-826,444. BEYNON ENTERPRISES, INC., HUNT VALLEY, MD. FILED 3-1-2006.

BSS.100

THE MARK CONSISTS OF STANDARD CHARACTERS WITHOUT CLAIM TO ANY PARTICULAR FONT, STYLE, SIZE, OR COLOR.

FOR ATHLETIC TRACK SURFACE COMPRISED OF RUBBER GRANULES WITH A SINGLE COMPOUND POLYURETHANE BINDER AND FINISHED WITH APPLICATIONS OF PIGMENTED POLYURETHANE AND POLYURETHANE GRANULES (U.S. CLS. 1, 5, 12, 13, 35 AND 50).

FIRST USE 4-1-2002; IN COMMERCE 4-1-2002.
ELLEN BURNS, EXAMINING ATTORNEY

SN 78-826,513. BEYNON ENTERPRISES, INC., HUNT VALLEY, MD. FILED 3-1-2006.

BSS.200

THE MARK CONSISTS OF STANDARD CHARACTERS WITHOUT CLAIM TO ANY PARTICULAR FONT, STYLE, SIZE, OR COLOR.

FOR ATHLETIC TRACK SURFACE COMPRISED OF RUBBER AND POLYURETHANE GRANULES AND COATED WITH A TWO-COMPONENT POLYURETHANE SEALER (U.S. CLS. 1, 5, 12, 13, 35 AND 50).

FIRST USE 4-1-2002; IN COMMERCE 4-1-2002.
ELLEN BURNS, EXAMINING ATTORNEY

SN 78-826,550. BEYNON ENTERPRISES, INC., HUNT VALLEY, MD. FILED 3-1-2006.

BSS.300

THE MARK CONSISTS OF STANDARD CHARACTERS WITHOUT CLAIM TO ANY PARTICULAR FONT, STYLE, SIZE, OR COLOR.

FOR ATHLETIC TRACK SURFACE COMPRISED OF A BLACK RUBBER BASE MAT WHICH IS POLYURETHANE-BOUND AND TOPPED WITH A TWO-COMPONENT POLYURETHANE SEALER (U.S. CLS. 1, 5, 12, 13, 35 AND 50).

FIRST USE 4-1-2002; IN COMMERCE 4-1-2002.
ELLEN BURNS, EXAMINING ATTORNEY

CLASS 17—(Continued).

SN 78-826,570. BEYNON ENTERPRISES, INC., HUNT VALLEY, MD. FILED 3-1-2006.

BSS.1000

THE MARK CONSISTS OF STANDARD CHARACTERS WITHOUT CLAIM TO ANY PARTICULAR FONT, STYLE, SIZE, OR COLOR.

FOR ATHLETIC TRACK SURFACE COMPRISED OF AN INTEGRATED BASE OF RUBBER AND POLYURETHANE (U.S. CLS. 1, 5, 12, 13, 35 AND 50).

FIRST USE 4-1-2002; IN COMMERCE 4-1-2002.
ELLEN BURNS, EXAMINING ATTORNEY

SN 78-826,589. BEYNON ENTERPRISES, INC., HUNT VALLEY, MD. FILED 3-1-2006.

BSS.2000

THE MARK CONSISTS OF STANDARD CHARACTERS WITHOUT CLAIM TO ANY PARTICULAR FONT, STYLE, SIZE, OR COLOR.

FOR ATHLETIC TRACK SURFACE COMPRISED OF BUTYL RUBBER AND FULL-DEPTH COLOR POLYURETHANE FINISHED WITH EMBEDDED OR ENCAPSULATED POLYURETHANE GRANULES (U.S. CLS. 1, 5, 12, 13, 35 AND 50).

FIRST USE 4-1-2002; IN COMMERCE 4-1-2002.
ELLEN BURNS, EXAMINING ATTORNEY

SN 78-828,636. M.A.G. ENGINEERING & MANUFACTURING, CO., INC., HUNTINGTON BEACH, CA. FILED 3-3-2006.

M.A.G. Blanks

THE MARK CONSISTS OF STANDARD CHARACTERS WITHOUT CLAIM TO ANY PARTICULAR FONT, STYLE, SIZE, OR COLOR.

NO CLAIM IS MADE TO THE EXCLUSIVE RIGHT TO USE "BLANKS", APART FROM THE MARK AS SHOWN.

FOR POLYURETHANE AND POLYSTYRENE FOAM FOR PURPOSES OF BUILDING AND SHAPING SURFBOARDS (U.S. CLS. 1, 5, 12, 13, 35 AND 50).

TIMOTHY FINNEGAN, EXAMINING ATTORNEY

CLASS 17—(Continued).

SN 78-844,740. M.A.G. ENGINEERING & MANUFACTURING, CO., INC., HUNTINGTON BEACH, CA. FILED 3-23-2006.

PCProTech

THE MARK CONSISTS OF STANDARD CHARACTERS WITHOUT CLAIM TO ANY PARTICULAR FONT, STYLE, SIZE, OR COLOR.

FOR POLYURETHANE FOAM FOR USE AS INSULATION FOR THE PURPOSE OF PROTECTING LAPTOP COMPUTERS FROM STATIC SHOCK OR ELECTRICAL DAMAGE WHEN PASSING THROUGH AIRPORT SCREENING MACHINES (U.S. CLS. 1, 5, 12, 13, 35 AND 50).

TIMOTHY FINNEGAN, EXAMINING ATTORNEY

SN 78-849,806. THOMAS & BETTS INTERNATIONAL, INC., WILMINGTON, DE. FILED 3-30-2006.

KNK SEALANT PATCH

THE MARK CONSISTS OF STANDARD CHARACTERS WITHOUT CLAIM TO ANY PARTICULAR FONT, STYLE, SIZE, OR COLOR.

NO CLAIM IS MADE TO THE EXCLUSIVE RIGHT TO USE "SEALANT PATCH", APART FROM THE MARK AS SHOWN.

FOR RUBBER SEALANT FOR CAULKING AND ADHESIVE PURPOSES (U.S. CLS. 1, 5, 12, 13, 35 AND 50).

FIRST USE 3-1-2006; IN COMMERCE 3-1-2006.

JANICE KIM, EXAMINING ATTORNEY

SN 78-849,866. MASTERPAK, INC., NEW YORK, NY. FILED 3-30-2006.

SOFTWRAP

THE MARK CONSISTS OF STANDARD CHARACTERS WITHOUT CLAIM TO ANY PARTICULAR FONT, STYLE, SIZE, OR COLOR.

FOR PLASTIC FLEXIBLE PACKAGING FILM FOR USE IN SHIPPING AND STORAGE, SOLD IN BULK TO INDUSTRIAL AND COMMERCIAL USERS (U.S. CLS. 1, 5, 12, 13, 35 AND 50).

FIRST USE 5-31-1994; IN COMMERCE 5-31-1994.

JOHN WILKE, EXAMINING ATTORNEY

CLASS 17—(Continued).

SN 78-849,952. MASTERPAK, INC., NEW YORK, NY. FILED 3-30-2006.

HARDWRAP

THE MARK CONSISTS OF STANDARD CHARACTERS WITHOUT CLAIM TO ANY PARTICULAR FONT, STYLE, SIZE, OR COLOR.

FOR PLASTIC FLEXIBLE PACKAGING FILM FOR USE IN SHIPPING AND STORAGE, SOLD IN BULK TO INDUSTRIAL AND COMMERCIAL USERS (U.S. CLS. 1, 5, 12, 13, 35 AND 50).

FIRST USE 5-27-2006; IN COMMERCE 5-27-2006.

JOHN WILKE, EXAMINING ATTORNEY

SN 78-852,930. PRO PAINT SUPPLY, INC., FULLERTON, CA. FILED 4-3-2006.

GASKET KING

THE MARK CONSISTS OF STANDARD CHARACTERS WITHOUT CLAIM TO ANY PARTICULAR FONT, STYLE, SIZE, OR COLOR.

NO CLAIM IS MADE TO THE EXCLUSIVE RIGHT TO USE "GASKET", APART FROM THE MARK AS SHOWN.

FOR NON-METAL GASKETS USED IN SPRAY PAINT GUNS (U.S. CLS. 1, 5, 12, 13, 35 AND 50).

FIRST USE 12-1-2004; IN COMMERCE 12-1-2004.

EUGENIA MARTIN, EXAMINING ATTORNEY

SN 78-854,228. POLYRAM RAM-ON INDUSTRIES, MOSHAV RAM-ON, ISRAEL, FILED 4-5-2006.

POLYTRON

THE MARK CONSISTS OF STANDARD CHARACTERS WITHOUT CLAIM TO ANY PARTICULAR FONT, STYLE, SIZE, OR COLOR.

FOR POLYMER THERMOPLASTIC COMPOUNDS REINFORCED BY LONG GLASS FIBER IN PELLET FORM FOR PLASTIC INJECTION MOLDING MANUFACTURING APPLICATIONS FOR USE IN THE AUTOMOTIVE, IRRIGATION, AND CONSTRUCTION FIELDS (U.S. CLS. 1, 5, 12, 13, 35 AND 50).

FIRST USE 11-30-2004; IN COMMERCE 9-11-2005.

ELIZABETH J. WINTER, EXAMINING ATTORNEY

CLASS 17—(Continued).

SN 78-858,748. GENERAL ELECTRIC COMPANY, SCHE-
NECTADY, NY. FILED 4-11-2006.

IMAGINACION EN ACCION

THE MARK CONSISTS OF STANDARD CHARACTERS
WITHOUT CLAIM TO ANY PARTICULAR FONT, STYLE,
SIZE, OR COLOR.

THE ENGLISH TRANSLATION OF THE WORDING
"IMAGINACION EN ACCION" IS "IMAGINATION AT
WORK".

FOR PLASTICS IN EXTRUDED FORM FOR USE IN
MANUFACTURE AND INDUSTRY; BUILDING INSU-
LATION; POLYURETHANE FILM FOR USE IN SEAL-
ING AND INSULATING; RESINS IN EXTRUDED FORM
FOR GENERAL INDUSTRIAL USE; SOUNDPROOFING
MATERIALS FOR BUILDINGS; ACOUSTICAL INSULA-
TION FOR BUILDINGS; FIBERGLASS INSULATION
FOR BUILDINGS; ADHESIVE AND RUBBER SEALANT
AND CAULKING COMPOUNDS; ADHESIVE SEALANTS
FOR GENERAL USE; SEALANTS FOR GENERAL USE;
GENERAL PURPOSE SILICONE RUBBER SEALANT
(U.S. CLS. 1, 5, 12, 13, 35 AND 50).

RUDY R. SINGLETON, EXAMINING ATTORNEY

SN 78-859,105. MICRO MATIC USA, INC., NORTHRIDGE,
CA. FILED 4-11-2006.

BLACK DIAMOND

THE MARK CONSISTS OF STANDARD CHARACTERS
WITHOUT CLAIM TO ANY PARTICULAR FONT, STYLE,
SIZE, OR COLOR.

FOR BEVERAGE DISPENSING EQUIPMENT,
NAMELY PLASTIC TUBING FOR TRANSFERRING
BEVERAGES (U.S. CLS. 1, 5, 12, 13, 35 AND 50).

FIRST USE 3-1-2006; IN COMMERCE 3-1-2006.
ANDREA EVANS, EXAMINING ATTORNEY

SN 78-862,610. RMAX, INC., DALLAS, TX. FILED 4-17-2006.

ULTRA-MAX

THE MARK CONSISTS OF STANDARD CHARACTERS
WITHOUT CLAIM TO ANY PARTICULAR FONT, STYLE,
SIZE, OR COLOR.

FOR ROOFING INSULATION (U.S. CLS. 1, 5, 12, 13, 35
AND 50).

FIRST USE 10-0-2004; IN COMMERCE 10-0-2004.
AMY GEARIN, EXAMINING ATTORNEY

CLASS 17—(Continued).

SN 78-868,139. VENTURE TAPE CORP., ROCKLAND, MA.
FILED 4-24-2006.

SWINGSHIELD

THE MARK CONSISTS OF STANDARD CHARACTERS
WITHOUT CLAIM TO ANY PARTICULAR FONT, STYLE,
SIZE, OR COLOR.

FOR PROTECTIVE ADHESIVE FILM FOR THE HEAD
OF A GOLF CLUB (U.S. CLS. 1, 5, 12, 13, 35 AND 50).

FIRST USE 4-5-2006; IN COMMERCE 4-19-2006.

CIMMERIAN COLEMAN, EXAMINING ATTORNEY

SN 78-906,553. EASY GARDENER PRODUCTS, LTD, WACO,
TX. FILED 6-13-2006.

POLYSPUN 350

THE MARK CONSISTS OF STANDARD CHARACTERS
WITHOUT CLAIM TO ANY PARTICULAR FONT, STYLE,
SIZE, OR COLOR.

NO CLAIM IS MADE TO THE EXCLUSIVE RIGHT TO
USE "POLYSPUN", APART FROM THE MARK AS SHOWN.

FOR PLASTIC SHEETING FOR PREVENTING WEED
GROWTH (U.S. CLS. 1, 5, 12, 13, 35 AND 50).

FIRST USE 3-1-1988; IN COMMERCE 3-1-1988.

CORY BOONE, EXAMINING ATTORNEY

CLASS 18—LEATHER GOODS

SN 76-657,604. ERES, PARIS, FRANCE, FILED 3-31-2006.

ERES

OWNER OF U.S. REG. NOS. 2,320,998 AND 2,497,205.
"THE FOREIGN WORDING IN THE MARK TRANS-
LATES INTO ENGLISH AS YOU ARE."

FOR BEACH BAGS (U.S. CLS. 1, 2, 3, 22 AND 41).

CIMMERIAN COLEMAN, EXAMINING ATTORNEY

CLASS 18—(Continued).

SN 76-658,034. KARAM, AMNAU, NEW YORK, NY. AND MALLERY, CLIFTON, NEW YORK, NY. FILED 4-7-2006.

LA SANTA BOLSA

THE MARK CONSISTS OF STANDARD CHARACTERS WITHOUT CLAIM TO ANY PARTICULAR FONT, STYLE, SIZE, OR COLOR.

NO CLAIM IS MADE TO THE EXCLUSIVE RIGHT TO USE "BOLSA", APART FROM THE MARK AS SHOWN. THE NAME LA SANTA BOLSA IS SPANISH FOR HOLY BAGS.

FOR HANDBAGS (U.S. CLS. 1, 2, 3, 22 AND 41).
FIRST USE 1-3-2002; IN COMMERCE 3-7-2006.
VERNA BETH RIRIE, EXAMINING ATTORNEY

CLASS 18—(Continued).

SN 78-669,445. CONFETTI BAY UMBRELLA COMPANY, INC., TAUNTON, MA. FILED 7-13-2005.

Confetti Bay

UMBRELLA COMPANY

SN 78-528,329. ALBRECHT-BUEHLER, CHRISTINE, LOS ANGELES, CA. FILED 12-7-2004.



FOR OVERNIGHT BAGS FOR PREGNANT WOMEN GOING TO THE HOSPITAL (U.S. CLS. 1, 2, 3, 22 AND 41).

BARBARA GAYNOR, EXAMINING ATTORNEY

NO CLAIM IS MADE TO THE EXCLUSIVE RIGHT TO USE "UMBRELLA COMPANY", APART FROM THE MARK AS SHOWN.

FOR BEACH UMBRELLAS AND PATIO UMBRELLAS (U.S. CLS. 1, 2, 3, 22 AND 41).

FIRST USE 2-11-1999; IN COMMERCE 2-11-1999.
YONG KIM, EXAMINING ATTORNEY

SN 78-671,801. DUKES, CAROL, WHITTIER, CA. FILED 7-15-2005.

SN 78-625,191. LEAVER, EDWARD/SCOTT, HINGHAM, MA. FILED 5-9-2005.

COLLARS FOR A CURE

THE MARK CONSISTS OF STANDARD CHARACTERS WITHOUT CLAIM TO ANY PARTICULAR FONT, STYLE, SIZE, OR COLOR.

NO CLAIM IS MADE TO THE EXCLUSIVE RIGHT TO USE "COLLARS", APART FROM THE MARK AS SHOWN.

FOR COLLARS FOR PETS WHEREIN ALL OR SOME PORTION OF THE PROCEEDS FROM THE SALE IN COMMERCE OF THE AFOREMENTIONED IS DIRECTED TO AID IN THE CURE FOR ONE OR MORE DISEASES, SPECIFICALLY BUT NOT LIMITED TO, CANCER (U.S. CLS. 1, 2, 3, 22 AND 41).

CHRISTOPHER OTT, EXAMINING ATTORNEY

Stylin'

FOR KNITTED AND CROCHETED SCARVES AND PONCHOS FOR DOGS (U.S. CLS. 1, 2, 3, 22 AND 41).

MARTHA FROMM, EXAMINING ATTORNEY

CLASS 18—(Continued).

SN 78-678,437. ITALIANO, PETER, DBA THE WHITE EAGLE SADDLE PAD CO., YORKTOWN HEIGHTS, NY. FILED 7-26-2005.



NO CLAIM IS MADE TO THE EXCLUSIVE RIGHT TO USE "WESTERN" AND "SERIES", APART FROM THE MARK AS SHOWN.
FOR PADS FOR HORSE SADDLES (U.S. CLS. 1, 2, 3, 22 AND 41).
FIRST USE 10-0-2004; IN COMMERCE 10-0-2004.
MICHELE SWAIN, EXAMINING ATTORNEY

SN 78-683,110. SANDS, ROLAND W., LONG BEACH, CA. FILED 8-1-2005.

RSD

THE MARK CONSISTS OF STANDARD CHARACTERS WITHOUT CLAIM TO ANY PARTICULAR FONT, STYLE, SIZE, OR COLOR.
FOR DUFFEL BAGS, BACKPACKS, AND CARRY-ALL BAGS (U.S. CLS. 1, 2, 3, 22 AND 41).
AMY GEARIN, EXAMINING ATTORNEY

CLASS 18—(Continued).

SN 78-705,129. REED, SCOTT, SALT LAKE CITY, UT. FILED 9-1-2005.

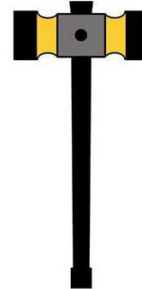

THE COLOR(S) BLACK, YELLOW-ORANGE, GRAY IS/ ARE CLAIMED AS A FEATURE OF THE MARK.
THE MARK CONSISTS OF A HAMMER WITH A DOUBLE HEAD AND A BLACK HANDLE THAT SHOWS THROUGH THE TOP OF THE HEAD. THE OUTERMOST PORTIONS OF THE HEAD ARE BLACK, AND THE CENTER OF THE HEAD IS GRAY. BETWEEN THE BLACK AND THE GRAY ON EACH SIDE ARE YELLOW-ORANGE SECTIONS.
FOR BAGS, NAMELY, HIKING BAGS, BACKPACKS, AND HUNTING BAGS, AND CAMPING BAGS, NAMELY BACKPACKS (U.S. CLS. 1, 2, 3, 22 AND 41).
FIRST USE 5-1-2005; IN COMMERCE 5-1-2005.
MARTHA FROMM, EXAMINING ATTORNEY

SN 78-711,106. SULLIVAN, DANIEL, PINNER, UNITED KINGDOM, FILED 9-12-2005.

DUNKIRK SPIRIT

THE MARK CONSISTS OF STANDARD CHARACTERS WITHOUT CLAIM TO ANY PARTICULAR FONT, STYLE, SIZE, OR COLOR.
FOR TRUNKS AND TRAVELLING BAGS; LUGGAGE; HANDBAGS, PURSES; UMBRELLAS (U.S. CLS. 1, 2, 3, 22 AND 41).
LAURA KOVALSKY, EXAMINING ATTORNEY

SN 78-719,354. IDIGDOG LLC, DREXEL HILL, PA. FILED 9-23-2005.

IDIGDOG

THE MARK CONSISTS OF STANDARD CHARACTERS WITHOUT CLAIM TO ANY PARTICULAR FONT, STYLE, SIZE, OR COLOR.
FOR PET PRODUCTS, NAMELY PROTECTIVE COLLARS, COLLARS, AND LEASHES (U.S. CLS. 1, 2, 3, 22 AND 41).
KELLEY WELLS, EXAMINING ATTORNEY

CLASS 18—(Continued).

SN 78-735,277. BOCCUTI, MICHELE H., TURNERSVILLE, NJ. FILED 10-18-2005.

BYOB

THE MARK CONSISTS OF STANDARD CHARACTERS WITHOUT CLAIM TO ANY PARTICULAR FONT, STYLE, SIZE, OR COLOR.

FOR CUSTOM HANDBAG (U.S. CLS. 1, 2, 3, 22 AND 41).

ELIZABETH J. WINTER, EXAMINING ATTORNEY

SN 78-746,180. BERNARD CHAUS, INC., NEW YORK, NY. FILED 11-3-2005.

CYNTHIA STEFFE

THE MARK CONSISTS OF STANDARD CHARACTERS WITHOUT CLAIM TO ANY PARTICULAR FONT, STYLE, SIZE, OR COLOR.

OWNER OF U.S. REG. NOS. 1,569,876 AND 2,224,693.

THE NAME(S), PORTRAIT(S), AND/OR SIGNATURE(S) SHOWN IN THE MARK IDENTIFIES CYNTHIA STEFFE, WHOSE CONSENT(S) TO REGISTER IS SUBMITTED.

FOR HANDBAGS, WALLETS, KEY CASES, CHANGE PURSES, COSMETIC BAGS AND POUCHES SOLD EMPTY, BRIEFCASE-TYPE PORTFOLIOS, SUIT BAGS, TRUNKS FOR TRAVELING, SUITCASES, UMBRELLAS, BILLFOLDS, DUFFLE BAGS, TOTE BAGS, BRIEFCASES AND ATTACHE CASES, LUGGAGE, OVERNIGHT CASES, TOILET KITS SOLD EMPTY, CREDIT CARD CASES, BUSINESS CARD CASES (U.S. CLS. 1, 2, 3, 22 AND 41).

BARBARA GAYNOR, EXAMINING ATTORNEY

SN 78-760,105. BUILT NY, INC., NEW YORK, NY. FILED 11-23-2005.

BUILT

THE MARK CONSISTS OF STANDARD CHARACTERS WITHOUT CLAIM TO ANY PARTICULAR FONT, STYLE, SIZE, OR COLOR.

OWNER OF U.S. REG. NOS. 2,984,681 AND 3,026,567.

FOR TOTE BAGS; SATCHELS (U.S. CLS. 1, 2, 3, 22 AND 41).

FIRST USE 4-30-2002; IN COMMERCE 4-30-2002.

JOHN DALIER, EXAMINING ATTORNEY

CLASS 18—(Continued).

SN 78-775,801. DADA CORPORATION, SEOUL, REPUBLIC OF KOREA, FILED 12-19-2005.

PAXCO

THE MARK CONSISTS OF STANDARD CHARACTERS WITHOUT CLAIM TO ANY PARTICULAR FONT, STYLE, SIZE, OR COLOR.

OWNER OF U.S. REG. NO. 2,285,146.

FOR KEY CASES, DIAPER BAGS, BACKPACKS, BOSTON BAGS, PURSES, BEACH BAGS, BRIEFCASES, TRAVELLING BAGS, COSMETIC BAGS SOLD EMPTY, SCHOOL BAGS, HANDBAGS (U.S. CLS. 1, 2, 3, 22 AND 41).

SHARON MEIER, EXAMINING ATTORNEY

SN 78-780,049. BOCCUTI, MICHELE H., TURNERSVILLE, NJ. FILED 12-23-2005.

BYOB Building your own Bags

THE MARK CONSISTS OF STANDARD CHARACTERS WITHOUT CLAIM TO ANY PARTICULAR FONT, STYLE, SIZE, OR COLOR.

FOR CUSTOM HANDBAG (U.S. CLS. 1, 2, 3, 22 AND 41).

ELIZABETH J. WINTER, EXAMINING ATTORNEY

SN 78-813,710. THE TRUSTEE(S) OF THE STUART-CURTIS FAMILY TRUST, NEW YORK, NY. FILED 2-13-2006.

JILLBAG BY JILL STUART

THE MARK CONSISTS OF STANDARD CHARACTERS WITHOUT CLAIM TO ANY PARTICULAR FONT, STYLE, SIZE, OR COLOR.

OWNER OF U.S. REG. NOS. 2,805,256 AND 2,808,987.

THE NAME JILL STUART IDENTIFIES A LIVING INDIVIDUAL WHOSE CONSENT IS OF RECORD.

FOR BACKPACKS; HANDBAGS; POCKETBOOKS; PURSES; SATCHELS (U.S. CLS. 1, 2, 3, 22 AND 41).

HOWARD SMIGA, EXAMINING ATTORNEY

CLASS 18—(Continued).

SN 78-819,947. NVIZION CORP., WALNUT, CA. FILED 2-21-2006.

AISSEZ

THE MARK CONSISTS OF STANDARD CHARACTERS WITHOUT CLAIM TO ANY PARTICULAR FONT, STYLE, SIZE, OR COLOR.

FOR HANDBAGS, PURSES, TRAVEL ACCESSORIES, NAMELY, COSMETIC CASES SOLD EMPTY; BAGS, NAMELY, TOTE BAGS, DUFFEL BAGS, BOOK BAGS, ALL PURPOSE SPORTS BAGS, CARRY-ON BAGS, SMALL LEATHER ARTICLES AND ACCESSORIES, NAMELY, WALLETS AND KEY CASES; LUGGAGE; CARRYING CASES (U.S. CLS. 1, 2, 3, 22 AND 41).

DARRYL SPRUILL, EXAMINING ATTORNEY

CLASS 18—(Continued).

SN 78-848,399. BRAUBURGER, ANALEA LIN, OPELOUSAS, LA. FILED 3-28-2006.

BasuraBags

THE MARK CONSISTS OF STANDARD CHARACTERS WITHOUT CLAIM TO ANY PARTICULAR FONT, STYLE, SIZE, OR COLOR.

THE ENGLISH TRANSLATION OF THE WORD "BASURA" IN THE MARK IS "TRASH".

FOR CLUTCHES, COIN PURSES, COIN PURSES NOT MADE OF PRECIOUS METAL, MULTI-PURPOSE PURSES, PURSES, SMALL CLUTCH PURSES AND SMALL PURSES (U.S. CLS. 1, 2, 3, 22 AND 41).

KATHERINE STOIDES, EXAMINING ATTORNEY

SN 78-845,105. JOHN RICH & SONS INVESTMENT HOLDING COMPANY, WILMINGTON, DE. FILED 3-24-2006.

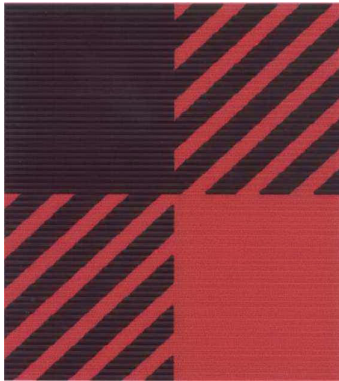

OWNER OF U.S. REG. NOS. 3,074,698, 3,127,991 AND OTHERS.

THE APPLICANT CLAIMS COLOR AS A FEATURE OF THE MARK, NAMELY, RED AND BLACK.

THE MARK CONSISTS OF A SQUARE MADE UP OF FOUR SMALLER SQUARES. THE UPPER LEFT SQUARE IS BLACK. THE LOWER RIGHT SQUARE IS RED. THE UPPER RIGHT AND LOWER LEFT SQUARES ARE DIAGONAL BLACK AND RED STRIPES.

FOR WALLETS (U.S. CLS. 1, 2, 3, 22 AND 41).

ROBERT STRUCK, EXAMINING ATTORNEY

SN 78-852,555. CIELO CREATIONS INC, COMMERCE, CA. FILED 4-3-2006.



OWNER OF U.S. REG. NO. 3,124,905.

THE COLOR(S) DARK YELLOW, LIGHT YELLOW, WHITE, BLACK, AND ORANGE IS/ARE CLAIMED AS A FEATURE OF THE MARK.

THE COLOR DARK YELLOW APPEARS IN THE OUTLINE OF THE WORDING TATOO AND IN THE BODY OF THE CHICKEN, THE COLOR LIGHT YELLOW APPEARS IN THE INSIDE OF THE WORDING TATOO AND IN THE EYES OF THE CHICKEN, THE COLOR BLACK APPEARS IN THE OUTLINE OF THE FEATURES OF THE CHICKEN, AND THE COLOR ORANGE APPEARS IN NOSE AND FEET OF THE CHICKEN.

FOR HANDBAGS, BACKPACKS, LUGGAGE, TOTE BAGS, PURSES AND WALLETS (U.S. CLS. 1, 2, 3, 22 AND 41).

FIRST USE 1-1-2006; IN COMMERCE 1-1-2006.

ATTIYA MALIK, EXAMINING ATTORNEY

CLASS 18—(Continued).

SN 78-852,565. CIELO CREATIONS INC, COMMERCE, CA.
FILED 4-3-2006.

CLASS 18—(Continued).

SN 78-852,574. CIELO CREATIONS INC, COMMERCE, CA.
FILED 4-3-2006.



OWNER OF U.S. REG. NO. 3,124,905.
 THE COLOR(S) PURPLE, LIGHT PINK, DARK PINK, GRAY, WHITE, AND BLACK IS/ARE CLAIMED AS A FEATURE OF THE MARK.
 THE COLOR PURPLE APPEARS IN THE SHADOW OF THE WORDING TATOO, THE COLORS LIGHT PINK AND DARK PINK APPEAR IN THE BODY OF THE COW, THE COLOR GRAY APPEARS IN THE BODY OF THE COW, THE COLOR WHITE APPEARS IN THE INSIDE OF THE WORDING TATOO AND IN THE BODY AND EYES OF THE COW, THE COLOR BLACK APPEARS IN THE OUTLINE OF THE WORDING TATOO AND THE OUTLINE OF THE FEATURES OF THE COW.
 FOR HANDBAGS, BACKPACKS, LUGGAGE, TOTE BAGS, PURSES AND WALLETS (U.S. CLS. 1, 2, 3, 22 AND 41).
 FIRST USE 1-1-2006; IN COMMERCE 1-1-2006.
 ATTIYA MALIK, EXAMINING ATTORNEY

OWNER OF U.S. REG. NO. 3,124,905.
 THE COLOR(S) DARK GREEN, LIGHT GREEN, BLUE, WHITE, AND BLACK IS/ARE CLAIMED AS A FEATURE OF THE MARK.
 THE COLOR DARK GREEN APPEARS IN THE OUTLINE OF THE WORDING TATOO, THE COLOR LIGHT GREEN APPEARS IN THE BODY OF THE DOG, THE COLOR BLUE APPEARS IN THE EYES OF THE DOG, THE COLOR WHITE APPEARS IN THE INSIDE OF THE WORDING TATOO AND IN THE BODY OF THE DOG, AND THE COLOR BLACK APPEARS IN THE BODY AND OUTLINE OF THE FEATURES OF THE DOG.
 FOR HANDBAGS, BACKPACKS, LUGGAGE, TOTE BAGS, PURSES AND WALLETS (U.S. CLS. 1, 2, 3, 22 AND 41).
 FIRST USE 1-1-2006; IN COMMERCE 1-1-2006.
 ATTIYA MALIK, EXAMINING ATTORNEY

CLASS 18—(Continued).

SN 78-852,597. CIELO CREATIONS INC, COMMERCE, CA.
FILED 4-3-2006.



OWNER OF U.S. REG. NO. 3,124,905.
THE COLOR(S) LIGHT BROWN, DARK BROWN, WHITE,
TAN, AND BLACK IS/ARE CLAIMED AS A FEATURE OF
THE MARK.

THE COLOR LIGHT BROWN APPEARS IN THE OUT-
LINE OF THE WORDING TATOO AND IN THE BODY OF
THE ELEPHANT, THE COLOR DARK BROWN APPEARS
IN THE BODY OF THE ELEPHANT, THE COLOR WHITE
APPEARS IN THE INSIDE OF THE WORDING TATOO, THE
COLOR TAN APPEARS IN THE EYES OF THE ELEPHANT,
AND THE COLOR BLACK APPEARS IN THE OUTLINE OF
THE FEATURES OF THE ELEPHANT.

FOR HANDBAGS, BACKPACKS, LUGGAGE, TOTE
BAGS, PURSES AND WALLETS (U.S. CLS. 1, 2, 3, 22
AND 41).

FIRST USE 1-1-2006; IN COMMERCE 1-1-2006.
ATTIYA MALIK, EXAMINING ATTORNEY

SN 78-852,610. CIELO CREATIONS INC, COMMERCE, CA.
FILED 4-3-2006.



OWNER OF U.S. REG. NO. 3,124,905.
THE COLOR(S) DARK PINK, LIGHT PINK, WHITE, AND
BLACK IS/ARE CLAIMED AS A FEATURE OF THE MARK.

THE COLOR DARK PINK APPEARS IN THE OUTLINE
OF THE WORDING TATOO AND IN THE EARS AND
BOWTIE OF THE PIG, THE COLOR LIGHT PINK APPEARS
IN THE BODY OF THE PIG, THE COLOR WHITE APPEARS
IN THE INSIDE OF THE WORDING TATOO AND IN THE
EYES OF THE PIG, AND THE COLOR BLACK APPEARS IN
THE BOWTIE AND THE OUTLINE OF THE FEATURES OF
THE PIG.

FOR HANDBAGS, BACKPACKS, LUGGAGE, TOTE
BAGS, PURSES AND WALLETS (U.S. CLS. 1, 2, 3, 22
AND 41).

FIRST USE 1-1-2006; IN COMMERCE 1-1-2006.
ATTIYA MALIK, EXAMINING ATTORNEY

CLASS 18—(Continued).

SN 78-854,198. CONSTELLATION ENERGY GROUP, INC.,
BALTIMORE, MD. FILED 4-5-2006.

CONSTELLATION ENERGY

THE MARK CONSISTS OF STANDARD CHARACTERS
WITHOUT CLAIM TO ANY PARTICULAR FONT, STYLE,
SIZE, OR COLOR.

OWNER OF U.S. REG. NOS. 2,161,537, 2,952,562 AND
OTHERS.

FOR BAGS, NAMELY, ALL-PURPOSE SPORT BAGS
AND TOTE BAGS; UMBRELLAS (U.S. CLS. 1, 2, 3, 22
AND 41).

DAVID MURRAY, EXAMINING ATTORNEY

SN 78-857,132. CIELO CREATIONS INC, COMMERCE, CA.
FILED 4-7-2006.

BOTTEGA SPORT

THE MARK CONSISTS OF STANDARD CHARACTERS
WITHOUT CLAIM TO ANY PARTICULAR FONT, STYLE,
SIZE, OR COLOR.

OWNER OF U.S. REG. NO. 3,066,833.

NO CLAIM IS MADE TO THE EXCLUSIVE RIGHT TO
USE "SPORT", APART FROM THE MARK AS SHOWN.

FOR HANDBAGS, BACKPACKS, TOTE BAGS, PURSES,
LUGGAGE AND WALLETS (U.S. CLS. 1, 2, 3, 22 AND
41).

ATTIYA MALIK, EXAMINING ATTORNEY

SN 78-859,231. PANTONE, INC., CARLSTADT, NJ. FILED 4-
11-2006.

PANTONE UNIVERSE

THE MARK CONSISTS OF STANDARD CHARACTERS
WITHOUT CLAIM TO ANY PARTICULAR FONT, STYLE,
SIZE, OR COLOR.

OWNER OF U.S. REG. NOS. 1,674,917, 1,884,707 AND
OTHERS.

FOR ALL PURPOSE ATHLETIC BAGS; ALL PURPOSE
CARRYING BAGS; ALL PURPOSE SPORTS BAGS;
BACKPACKS; DUFFLE BAGS; FANNY PACKS; GYM
BAGS (U.S. CLS. 1, 2, 3, 22 AND 41).

TINA BROWN, EXAMINING ATTORNEY

CLASS 18—(Continued).

SN 78-859,485. STEPHEN M GIFFORD, KENT, WA. FILED 4-12-2006.

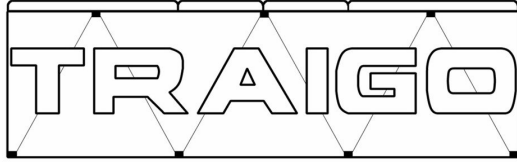

THE MARK CONSISTS OF A STYLIZED DEPICTION OF THE AUTOMOTIVE TRAVEL BAG WHICH THE MARK IS CURRENTLY ON, WITH THE WORD "TRAIGO" ACROSS IT.

THE FOREIGN WORDING IN THE MARK TRANSLATES INTO ENGLISH AS I BRING.

FOR ALL-PURPOSE CARRYING BAGS; TRAVEL BAGS (U.S. CLS. 1, 2, 3, 22 AND 41).

ANDREA EVANS, EXAMINING ATTORNEY

SN 78-860,532. TIVOLI GROUP, LLC, CINCINNATI, OH. FILED 4-12-2006.

KIK'KER

THE MARK CONSISTS OF STANDARD CHARACTERS WITHOUT CLAIM TO ANY PARTICULAR FONT, STYLE, SIZE, OR COLOR.

FOR SHOULDER BAGS, BACKPACKS, BRIEFCASES, TOTE BAGS, SUITCASES, HANDBAGS AND PURSES (U.S. CLS. 1, 2, 3, 22 AND 41).

IRENE D. WILLIAMS, EXAMINING ATTORNEY

SN 78-867,295. MONDEAMI INC., SAN JOSE, CA. FILED 4-21-2006.



FOR REUSABLE NON WOVEN POLYPROPYLENE SHOPPING BAGS (U.S. CLS. 1, 2, 3, 22 AND 41). FIRST USE 11-1-2005; IN COMMERCE 4-0-2006. DAVID TAYLOR, EXAMINING ATTORNEY

CLASS 18—(Continued).

SN 78-867,640. XU, QINGWEN, LOS ANGELES, CA. FILED 4-24-2006.

REALFOREST

THE MARK CONSISTS OF STANDARD CHARACTERS WITHOUT CLAIM TO ANY PARTICULAR FONT, STYLE, SIZE, OR COLOR.

FOR ALL PURPOSE SPORT BAGS; ALL-PURPOSE ATHLETIC BAGS; ALL-PURPOSE CARRYING BAGS; ANIMAL GAME BAGS; ATHLETIC BAGS; BABY BACKPACKS; BABY CARRYING BAGS; BACKPACKS; BACKPACKS; BAGS AND HOLDALLS FOR SPORTS CLOTHING; BAGS FOR CARRYING BABIES' ACCESSORIES; BAGS FOR UMBRELLAS; BARREL BAGS; BEACH BAGS; BELT BAGS; BOOK BAGS; CARRY-ALL BAGS; CARRY-ON BAGS; DIAPER BAGS; DUFFEL BAGS; DUFFEL BAGS FOR TRAVEL; DUFFLE BAGS; FEED BAGS FOR ANIMALS; FLEXIBLE BAGS FOR GARMENTS; GARMENT BAGS FOR TRAVEL; GYM BAGS; HIKING BAGS; HUNTERS' GAME BAGS; HUNTING BAGS; KEY BAGS; KIT BAGS; LEATHER AND IMITATION LEATHER BAGS; LEATHER BAGS FOR MERCHANDISE PACKAGING; LEATHER BAGS, SUITCASES AND WALLETS; LEATHER SHOPPING BAGS; LUGGAGE; LUGGAGE TAGS; MAKE-UP BAGS SOLD EMPTY; MESH SHOPPING BAGS; NON-MOTORIZED, COLLAPSIBLE LUGGAGE CARTS; OVERNIGHT BAGS; ROLL BAGS; SCHOOL BAGS; SCHOOL BOOK BAGS; SCHOOLCHILDREN'S BACKPACKS; SHAVING BAGS SOLD EMPTY; SHOE BAGS FOR TRAVEL; SHOPPING BAGS MADE OF SKIN; SHOPPING BAGS WITH WHEELS ATTACHED; SHOULDER BAGS; SMALL BACKPACKS; SMALL BAGS FOR MEN; SOUVENIR BAGS; SPORTS BAGS; SPORTSMAN'S HUNTING BAGS; STRAPS FOR LUGGAGE; STRING BAGS FOR SHOPPING; SUIT BAGS; TEXTILE SHOPPING BAGS; TOOL BAGS SOLD EMPTY; TOTE BAGS; TRAVEL BAGS; TRAVELING BAGS; TRAVELLING BAGS; TRAVELING CASES OF LEATHER; TRUNKS; WAIST BAGS; WINE BAGS WITH HANDLES FOR CARRYING OR HOLDING WINE; WRIST MOUNTED CARRYALL BAGS (U.S. CLS. 1, 2, 3, 22 AND 41).

FIRST USE 1-1-2006; IN COMMERCE 4-12-2006.

CAROLYN CATALDO, EXAMINING ATTORNEY

SN 78-868,178. BROWN SHOE COMPANY, INC., ST. LOUIS, MO. FILED 4-24-2006.

PALOMA

THE MARK CONSISTS OF STANDARD CHARACTERS WITHOUT CLAIM TO ANY PARTICULAR FONT, STYLE, SIZE, OR COLOR.

OWNER OF U.S. REG. NOS. 2,993,403 AND 3,100,693. THE FOREIGN WORDING IN THE MARK TRANSLATES INTO ENGLISH AS DOVE.

FOR HANDBAGS (U.S. CLS. 1, 2, 3, 22 AND 41).

MARLENE BELL, EXAMINING ATTORNEY

CLASS 18—(Continued).

SN 78-872,868. QING, WEN XU, LOS ANGELES, CA. FILED 4-29-2006.

Royal Sport

THE MARK CONSISTS OF STANDARD CHARACTERS WITHOUT CLAIM TO ANY PARTICULAR FONT, STYLE, SIZE, OR COLOR.

NO CLAIM IS MADE TO THE EXCLUSIVE RIGHT TO USE "SPORT", APART FROM THE MARK AS SHOWN.

FOR ALL PURPOSE SPORT BAGS; ALL-PURPOSE ATHLETIC BAGS; ALL-PURPOSE CARRYING BAGS; ANIMAL GAME BAGS; ATHLETIC BAGS; BABY CARRYING BAGS; BAGS AND HOLDALLS FOR SPORTS CLOTHING; BAGS FOR CARRYING BABIES' ACCESSORIES; BAGS FOR UMBRELLAS; BARREL BAGS; BEACH BAGS; BELT BAGS; BOOK BAGS; BOSTON BAGS; CARRY-ALL BAGS; CARRY-ON BAGS; CHARM BAGS (OMAMORI-IRE); CLUTCH BAGS; COSMETIC BAGS SOLD EMPTY; DIAPER BAGS; DUFFEL BAGS; DUFFEL BAGS FOR TRAVEL; DUFFLE BAGS; FEED BAGS FOR ANIMALS; FLEXIBLE BAGS FOR GARMENTS; GARMENT BAGS FOR TRAVEL; GLADSTONE BAGS; GYM BAGS; HIKING BAGS; HUNTERS' GAME BAGS; HUNTING BAGS; KEY BAGS; KIT BAGS; LEATHER AND IMITATION LEATHER BAGS; LEATHER BAGS FOR MERCHANDISE PACKAGING; LEATHER BAGS, SUITCASES AND WALLETS; LEATHER SHOPPING BAGS; LUGGAGE; LUGGAGE TAGS; MAKE-UP BAGS SOLD EMPTY; MESH SHOPPING BAGS; NON-MOTORIZED, COLLAPSIBLE LUGGAGE CARTS; OVERNIGHT BAGS; ROLL BAGS; SCHOOL BAGS; SCHOOL BOOK BAGS; SHAVING BAGS SOLD EMPTY; SHOE BAGS FOR TRAVEL; SHOPPING BAGS MADE OF SKIN; SHOPPING BAGS WITH WHEELS ATTACHED; SHOULDER BAGS; SMALL BAGS FOR MEN; SOUVENIR BAGS; SPORTS BAGS; SPORTSMAN'S HUNTING BAGS; STRAPS FOR LUGGAGE; STRING BAGS FOR SHOPPING; SUIT BAGS; TEXTILE SHOPPING BAGS; TOOL BAGS SOLD EMPTY; TOTE BAGS; TRAVEL BAGS; TRAVELING BAGS; TRAVELING BAGS; TRUNKS; WAIST BAGS; WINE BAGS WITH HANDLES FOR CARRYING OR HOLDING WINE; WRIST MOUNTED CARRYALL BAGS (U.S. CLS. 1, 2, 3, 22 AND 41).

FIRST USE 4-1-2006; IN COMMERCE 4-1-2006.
CAROLYN CATALDO, EXAMINING ATTORNEY

SN 78-874,961. FOSTER, LISA, LOS ANGELES, CA. FILED 5-3-2006.

1 BAG AT A TIME

THE MARK CONSISTS OF STANDARD CHARACTERS WITHOUT CLAIM TO ANY PARTICULAR FONT, STYLE, SIZE, OR COLOR.

FOR ALL-PURPOSE CARRYING BAGS; TOTE BAGS (U.S. CLS. 1, 2, 3, 22 AND 41).

FIRST USE 8-28-2005; IN COMMERCE 11-29-2005.
SARAH WAYDA, EXAMINING ATTORNEY

CLASS 18—(Continued).

SN 78-880,305. SAMSONITE CORPORATION, DENVER, CO. FILED 5-10-2006.

EMPARIO

THE MARK CONSISTS OF STANDARD CHARACTERS WITHOUT CLAIM TO ANY PARTICULAR FONT, STYLE, SIZE, OR COLOR.

FOR LUGGAGE (U.S. CLS. 1, 2, 3, 22 AND 41).
TONI HICKEY, EXAMINING ATTORNEY

SN 78-893,648. DADA CORPORATION, KANGNAM-GU, SEOUL, REPUBLIC OF KOREA, FILED 5-26-2006.

PXK

PAXKO

OWNER OF U.S. REG. NO. 2,285,146.

THE MARK CONSISTS OF PXK AND PAXKO. PAXKO IS SMALLER THAN PXK AND IS LOCATED UNDER PXK.

FOR KEY CASES, DIAPER BAGS, BACKPACKS, BOSTON BAGS, PURSES, BEACH BAGS, BRIEFCASES, TRAVELLING BAGS, COSMETIC BAGS SOLD EMPTY, SCHOOL BAGS, HANDBAGS, ALL-PURPOSE SPORT BAGS, ALL-PURPOSE CARRYING BAGS (U.S. CLS. 1, 2, 3, 22 AND 41).

SHARON MEIER, EXAMINING ATTORNEY

CLASS 18—(Continued).

SN 78-900,997. FISHER COACHBUILD, LLC, IRVINE, CA.
FILED 6-5-2006.



FOR LEATHER AND IMITATIONS OF LEATHER GOODS, NAMELY, BACKPACKS, ALL PURPOSE LEATHER BAGS, GYM BAGS, DUFFEL BAGS, LUGGAGE, KNAPSACKS, POCKETBOOKS, WAIST POUCHES, TRUNKS, TRAVELING BAGS, PURSES, WALLETS; UMBRELLAS (U.S. CLS. 1, 2, 3, 22 AND 41).
JOHN LINCOSKI, EXAMINING ATTORNEY

SN 78-917,767. CHATEAU INTERNATIONAL INC., NEW YORK, NY. FILED 6-27-2006.

GRACEE GIRL

THE MARK CONSISTS OF STANDARD CHARACTERS WITHOUT CLAIM TO ANY PARTICULAR FONT, STYLE, SIZE, OR COLOR.

FOR HANDBAGS, LUGGAGE, TOTE BAGS, SCHOOL BAGS, SPORTS BAGS, BACKPACKS, MINI BACKPACKS, CARRY-ALL BAGS, WAIST BAGS, FANNY PACKS, KEY CASES, BRIEFCASES, DUFFLE BAGS, ALL-PURPOSE SPORT BAGS, BUSINESS CARD CASES, CREDIT CARD CASES, CHANGE PURSES, ATTACHE CASES AND BILLFOLDS (U.S. CLS. 1, 2, 3, 22 AND 41).
JOHN E. MICHOS, EXAMINING ATTORNEY

SN 79-023,377. JIANGSU TEXTILES IMPORT & EXPORT GROUP CORPORATION, CHINA, FILED 2-28-2006.

TEXPAC

THE MARK CONSISTS OF STANDARD CHARACTERS WITHOUT CLAIM TO ANY PARTICULAR FONT, STYLE, SIZE, OR COLOR.

OWNER OF INTERNATIONAL REGISTRATION 0883666 DATED 2-28-2006, EXPIRES 2-28-2016.

FOR PURSES; SCHOOL BAGS; HANDBAGS; BRIEFCASES; LEATHER TRAVELING SETS, NAMELY SETS OF LEATHER LUGGAGE; TRAVELING BAGS; CASES OF LEATHER BOARD; GARMENT BAGS FOR TRAVEL; AND LEATHER KEY CASES (U.S. CLS. 1, 2, 3, 22 AND 41).

DAYNA BROWNE, EXAMINING ATTORNEY

CLASS 19—NON-METALLIC BUILDING MATERIALS

SN 76-619,848. GRAHAM, LAURA J., PORTLAND, OR.
FILED 11-10-2004.

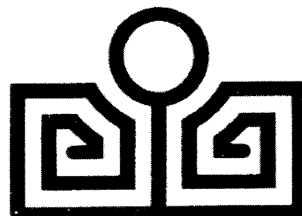

FOR ENGRAVED STONES AND HOLDING DISH SOLD AS A UNIT (U.S. CLS. 1, 12, 33 AND 50).
FIRST USE 7-0-2004; IN COMMERCE 7-0-2004.
ESTHER A. BORSUK, EXAMINING ATTORNEY

SN 76-643,500. BOBRICK WASHROOM EQUIPMENT, INC., NORTH HOLLYWOOD, CA. FILED 7-25-2005.

SIERRA SERIES

THE MARK CONSISTS OF STANDARD CHARACTERS WITHOUT CLAIM TO ANY PARTICULAR FONT, STYLE, SIZE, OR COLOR.

NO CLAIM IS MADE TO THE EXCLUSIVE RIGHT TO USE "SERIES", APART FROM THE MARK AS SHOWN.

FOR REINFORCED COMPOSITE WOOD FIBER, RESIN AND MELAMINE LAYER TOILET COMPARTMENTS COMPRISING DOORS, PARTITIONS AND PILASTERS (U.S. CLS. 1, 12, 33 AND 50).

FIRST USE 10-14-2003; IN COMMERCE 10-14-2003.
DAVID TAYLOR, EXAMINING ATTORNEY

SN 76-647,412. WARREN TRASK COMPANY, STOUGHTON, MA. FILED 9-26-2005.

SPECTRUM

THE MARK CONSISTS OF STANDARD CHARACTERS WITHOUT CLAIM TO ANY PARTICULAR FONT, STYLE, SIZE, OR COLOR.

FOR BUILDING MATERIALS, NAMELY, PRIMED PINE TRIM (U.S. CLS. 1, 12, 33 AND 50).

FIRST USE 6-0-2004; IN COMMERCE 4-0-2005.
KIMBERLY FRYE, EXAMINING ATTORNEY

CLASS 19—(Continued).

SN 76-658,666. HANOVER ARCHITECTURAL PRODUCTS, INC., HANOVER, PA. FILED 4-18-2006.

AMMON'S WALL

THE MARK CONSISTS OF STANDARD CHARACTERS WITHOUT CLAIM TO ANY PARTICULAR FONT, STYLE, SIZE, OR COLOR.

NO CLAIM IS MADE TO THE EXCLUSIVE RIGHT TO USE "WALL", APART FROM THE MARK AS SHOWN.

FOR CONCRETE BUILDING BLOCKS (U.S. CLS. 1, 12, 33 AND 50).

FIRST USE 1-16-2006; IN COMMERCE 2-20-2006.
JOHN SCHUYLER YARD, EXAMINING ATTORNEY

SN 76-659,085. SCHAFFER SYSTEMS INC., ADAIR, IA. FILED 4-26-2006.

CONNECT-A-PORT

THE MARK CONSISTS OF STANDARD CHARACTERS WITHOUT CLAIM TO ANY PARTICULAR FONT, STYLE, SIZE, OR COLOR.

FOR PLASTIC FLOATING DOCKS FOR PERSONAL WATERCRAFT (U.S. CLS. 1, 12, 33 AND 50).

FIRST USE 12-15-2005; IN COMMERCE 12-15-2005.
HOWARD B. LEVINE, EXAMINING ATTORNEY

SN 78-516,256. EAGLE MATERIALS IP LLC, DALLAS, TX. FILED 11-12-2004.

**AMERICAN
GYPSUM**

OWNER OF U.S. REG. NO. 2,171,076.
NO CLAIM IS MADE TO THE EXCLUSIVE RIGHT TO USE "GYPSUM", APART FROM THE MARK AS SHOWN.

THE MARK CONSISTS OF A HIGHLY STYLIZED LETTER A WITH THE WORDS AMERICAN GYPSUM UNDERNEATH.

SEC. 2(F) AS TO "AMERICAN GYPSUM".
FOR WALLBOARD (U.S. CLS. 1, 12, 33 AND 50).
FIRST USE 3-1-2004; IN COMMERCE 3-1-2004.
EVELYN BRADLEY, EXAMINING ATTORNEY

CLASS 19—(Continued).

SN 78-540,330. TRIPLE M HOUSING LTD., LETHBRIDGE, ALBERTA, CANADA, FILED 12-30-2004.



PRIORITY CLAIMED UNDER SEC. 44(D) ON CANADA APPLICATION NO. 1233663, FILED 10-6-2004, REG. NO. TMA656,770, DATED 1-18-2006, EXPIRES 1-18-2016.

OWNER OF U.S. REG. NO. 2,941,827.

NO CLAIM IS MADE TO THE EXCLUSIVE RIGHT TO USE "HOUSING", APART FROM THE MARK AS SHOWN.

FOR MANUFACTURED HOMES, MODULAR HOMES, MODULAR BUILDING UNITS FOR USE IN THE CONSTRUCTION OF COMMERCIAL BUILDINGS (U.S. CLS. 1, 12, 33 AND 50).

MARTHA FROMM, EXAMINING ATTORNEY

SN 78-604,227. R.J.M.S. ENTERPRISES, INC., SANTA ANA, CA. FILED 4-7-2005.

PROVENZA

THE MARK CONSISTS OF STANDARD CHARACTERS WITHOUT CLAIM TO ANY PARTICULAR FONT, STYLE, SIZE, OR COLOR.

FOR WOOD AND LAMINATE FLOORING (U.S. CLS. 1, 12, 33 AND 50).

FIRST USE 10-1-2002; IN COMMERCE 10-1-2002.
SUSAN STIGLITZ, EXAMINING ATTORNEY

SN 78-647,900. JACKSON, JAMES S., PORTSMOUTH, VA. AND SYKES, WILLIAM G., VIRGINIA BEACH, VA. FILED 6-10-2005.

FLOOD SCREEN

THE MARK CONSISTS OF STANDARD CHARACTERS WITHOUT CLAIM TO ANY PARTICULAR FONT, STYLE, SIZE, OR COLOR.

NO CLAIM IS MADE TO THE EXCLUSIVE RIGHT TO USE "FLOOD", APART FROM THE MARK AS SHOWN.

FOR PLASTIC VENT FOR EQUALIZING THE FLOOD-WATER HYDROSTATIC PRESSURE ON ADJACENT SIDES OF A CRAWLSPACE FOUNDATION WALL (U.S. CLS. 1, 12, 33 AND 50).

CHERYL CLAYTON, EXAMINING ATTORNEY

CLASS 19—(Continued).

SN 78-672,721. SURVIVOR TECHNOLOGIES, INC., HILLSIDE, NJ. FILED 7-18-2005.

SURVIVOR

THE MARK CONSISTS OF STANDARD CHARACTERS WITHOUT CLAIM TO ANY PARTICULAR FONT, STYLE, SIZE, OR COLOR.

FOR NON-METALLIC BUILDING MATERIALS, NAMELY, VINYL DECKING, VINYL FENCING, VINYL GATES, VINYL DRAINAGE PIPE, VINYL ROOFING, VINYL SIDING, VINYL TRELLIS, SKYLIGHTS WITH VINYL FRAMES AND VINYL RAILINGS FOR DECKS AND FENCE (U.S. CLS. 1, 12, 33 AND 50).

FIRST USE 12-31-1987; IN COMMERCE 12-31-1987.
GEORGE LORENZO, EXAMINING ATTORNEY

SN 78-692,949. BLUELINX CORPORATION, ATLANTA, GA. FILED 8-15-2005.

TOUGH-GUARD

THE MARK CONSISTS OF STANDARD CHARACTERS WITHOUT CLAIM TO ANY PARTICULAR FONT, STYLE, SIZE, OR COLOR.

FOR ROOFING SHINGLE UNDERLAYMENT ASPHALT SATURATED FELT; ROOFING FELT; ICE AND WATER SHIELD ROOF EAVE AND VALLEY PROTECTOR, NAMELY A SELF-ADHERING UNDERLAYMENT COMPOSED OF A POLYMER FILM LAMINATED TO A MEMBRANE OF ELASTOMERIC RUBBERIZED ASPHALT APPLIED ALONG ROOF EAVES AND AS A VALLEY BASE MATERIAL; NON-METAL BUILDING WINDOW AND DOOR FLASHING (U.S. CLS. 1, 12, 33 AND 50).

FIRST USE 5-7-2004; IN COMMERCE 5-7-2004.
TANYA AMOS, EXAMINING ATTORNEY

SN 78-697,970. NAVASTONE INC., CAMBRIDGE, ONTARIO, CANADA, FILED 8-23-2005.

TRI-WEDGE

THE MARK CONSISTS OF STANDARD CHARACTERS WITHOUT CLAIM TO ANY PARTICULAR FONT, STYLE, SIZE, OR COLOR.

OWNER OF U.S. REG. NO. 2,092,688.
FOR INTERLOCKING AND NON-INTERLOCKING CONCRETE BLOCKS AND CONCRETE RETAINING WALLS (U.S. CLS. 1, 12, 33 AND 50).

FIRST USE 2-15-2005; IN COMMERCE 2-15-2005.
JASON TURNER, EXAMINING ATTORNEY

CLASS 19—(Continued).

SN 78-697,972. NAVASTONE INC., CAMBRIDGE, ONTARIO, CANADA, FILED 8-23-2005.

WEDGESTONE XL

THE MARK CONSISTS OF STANDARD CHARACTERS WITHOUT CLAIM TO ANY PARTICULAR FONT, STYLE, SIZE, OR COLOR.

OWNER OF U.S. REG. NO. 2,092,688.
NO CLAIM IS MADE TO THE EXCLUSIVE RIGHT TO USE "XL", APART FROM THE MARK AS SHOWN.

FOR INTERLOCKING AND NON-INTERLOCKING CONCRETE BLOCKS AND CONCRETE RETAINING WALLS (U.S. CLS. 1, 12, 33 AND 50).

FIRST USE 5-4-2005; IN COMMERCE 5-4-2005.
JASON TURNER, EXAMINING ATTORNEY

SN 78-708,381. DEFUNIACK TILE MANUFACTURING, INC., BRADENTON, FL. FILED 9-7-2005.

SANTIAGO

THE MARK CONSISTS OF STANDARD CHARACTERS WITHOUT CLAIM TO ANY PARTICULAR FONT, STYLE, SIZE, OR COLOR.

FOR NON-METALLIC ROOF TILES (U.S. CLS. 1, 12, 33 AND 50).

PAM WILLIS, EXAMINING ATTORNEY

SN 78-724,575. QUALITY CRAFT LTD., SURREY, BRITISH COLUMBIA, CANADA, FILED 9-30-2005.

TRUCLICK

THE MARK CONSISTS OF STANDARD CHARACTERS WITHOUT CLAIM TO ANY PARTICULAR FONT, STYLE, SIZE, OR COLOR.

PRIORITY CLAIMED UNDER SEC. 44(D) ON CANADA APPLICATION NO. 1257242, FILED 5-4-2005, REG. NO. TMA670,779, DATED 8-22-2006, EXPIRES 2-22-2014.

FOR LAMINATE FLOORING (U.S. CLS. 1, 12, 33 AND 50).

JOHN DWYER, EXAMINING ATTORNEY

CLASS 19—(Continued).

SN 78-733,500. BOSTON CEDAR, INC., HOLBROOK, MA. FILED 10-14-2005.

OUTBACK DECKING

THE MARK CONSISTS OF STANDARD CHARACTERS WITHOUT CLAIM TO ANY PARTICULAR FONT, STYLE, SIZE, OR COLOR.

OWNER OF U.S. REG. NO. 2,930,594.
NO CLAIM IS MADE TO THE EXCLUSIVE RIGHT TO USE "DECKING", APART FROM THE MARK AS SHOWN. FOR BUILDING MATERIALS, NAMELY DECKING AND DECKING WITH A PROTECTIVE SEALANT (U.S. CLS. 1, 12, 33 AND 50).
FIRST USE 5-25-2001; IN COMMERCE 6-1-2001.
AMEETA JORDAN, EXAMINING ATTORNEY

CLASS 19—(Continued).

SN 78-775,855. CLEVER COVERS, INC., ORLANDO, FL. FILED 12-19-2005.

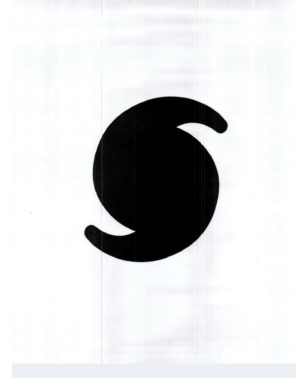

FOR NON-METALLIC PROTECTIVE DOOR AND WINDOW PANELS, NAMELY, PLASTIC PANELS AND SHUTTERS FOR PROTECTING EXTERIOR AND INTERIOR WINDOWS AND DOORS FROM STORMS AND FOR SECURITY PURPOSES, AND MOUNTING HARDWARE THEREFOR, NAMELY, HOOK AND LOOP FASTENERS, INTERLOCKING MUSHROOM HEAD FASTENERS, SCREWS, NAILS, CLIPS AND ACCESSORIES, NAMELY, HANDLES ALL SOLD ONLY AS A UNIT (U.S. CLS. 1, 12, 33 AND 50).
FIRST USE 9-12-2004; IN COMMERCE 9-12-2004.
REBECCA GAN, EXAMINING ATTORNEY

SN 78-750,169. AMERICAN BILTRITE INC., WELLESLEY HILLS, MA. FILED 11-9-2005.

DESERT STONE

THE MARK CONSISTS OF STANDARD CHARACTERS WITHOUT CLAIM TO ANY PARTICULAR FONT, STYLE, SIZE, OR COLOR.

OWNER OF U.S. REG. NO. 1,917,353.
NO CLAIM IS MADE TO THE EXCLUSIVE RIGHT TO USE STONE, APART FROM THE MARK AS SHOWN. FOR RUBBER FLOOR TILES (U.S. CLS. 1, 12, 33 AND 50).
FIRST USE 9-20-1993; IN COMMERCE 9-20-1993.
SHANNON TWOHIG, EXAMINING ATTORNEY

SN 78-794,052. AMERILUX INTERNATIONAL, LLC, DE PERE, WI. FILED 1-18-2006.

COVERBOARD

THE MARK CONSISTS OF STANDARD CHARACTERS WITHOUT CLAIM TO ANY PARTICULAR FONT, STYLE, SIZE, OR COLOR.

OWNER OF U.S. REG. NO. 2,974,020.
FOR BUILDING CONSTRUCTION MATERIALS, NAMELY PVC TRIM THAT IS RESISTANT TO WATER AND/OR CLEANING CHEMICALS (U.S. CLS. 1, 12, 33 AND 50).
SONYA STEPHENS, EXAMINING ATTORNEY

CLASS 19—(Continued).

SN 78-805,886. GULF COAST ASPHALT COMPANY, L.L.C., HOUSTON, TX. FILED 2-2-2006.

HIGHWAY EVERLAST

THE MARK CONSISTS OF STANDARD CHARACTERS WITHOUT CLAIM TO ANY PARTICULAR FONT, STYLE, SIZE, OR COLOR.

NO CLAIM IS MADE TO THE EXCLUSIVE RIGHT TO USE "HIGHWAY", APART FROM THE MARK AS SHOWN. FOR ASPHALT (U.S. CLS. 1, 12, 33 AND 50). THOMAS MANOR, EXAMINING ATTORNEY

SN 78-808,841. SPENCER, JOHN, SCOTTSDALE, AZ. FILED 2-7-2006.

EnDuraStone

THE MARK CONSISTS OF STANDARD CHARACTERS WITHOUT CLAIM TO ANY PARTICULAR FONT, STYLE, SIZE, OR COLOR.

FOR PRE TREATED STONE TILE WITH SOLVENT BASED SEALER TO PREVENT STAINING (U.S. CLS. 1, 12, 33 AND 50).

FIRST USE 11-1-2005; IN COMMERCE 11-1-2005.
NORA BUCHANAN WILL, EXAMINING ATTORNEY

SN 78-821,753. LAFARGE NORTH AMERICA INC., HERN- DON, VA. FILED 2-23-2006.

DURAPAVE SERIES

THE MARK CONSISTS OF STANDARD CHARACTERS WITHOUT CLAIM TO ANY PARTICULAR FONT, STYLE, SIZE, OR COLOR.

OWNER OF U.S. REG. NO. 2,321,646.
NO CLAIM IS MADE TO THE EXCLUSIVE RIGHT TO USE "SERIES", APART FROM THE MARK AS SHOWN. FOR ASPHALT (U.S. CLS. 1, 12, 33 AND 50). FIRST USE 8-24-2004; IN COMMERCE 8-24-2004. KATHERINE STOIDES, EXAMINING ATTORNEY

CLASS 19—(Continued).

SN 78-834,376. ROPPE CORPORATION, FOSTORIA, OH. FILED 3-10-2006.

VISUELLÉ WALL BASE

THE MARK CONSISTS OF STANDARD CHARACTERS WITHOUT CLAIM TO ANY PARTICULAR FONT, STYLE, SIZE, OR COLOR.

NO CLAIM IS MADE TO THE EXCLUSIVE RIGHT TO USE "WALL BASE", APART FROM THE MARK AS SHOWN. THE ENGLISH TRANSLATION OF THE WORD "VISUELLE" IN THE MARK IS "VISUAL".

FOR MOLDED AND EXTRUDED WALL BASE (U.S. CLS. 1, 12, 33 AND 50).

FIRST USE 1-0-2004; IN COMMERCE 1-0-2004.
CHARLOTTE CORWIN, EXAMINING ATTORNEY

SN 78-838,831. THOMAS, JAMES W., LAKELAND, FL. FILED 3-16-2006.



NO CLAIM IS MADE TO THE EXCLUSIVE RIGHT TO USE "HARDWOOD FLOORING", APART FROM THE MARK AS SHOWN.

THE COLOR(S) RED, YELLOW, ORANGE, PURPLE, WHITE, GOLD AND BLACK IS/ARE CLAIMED AS A FEATURE OF THE MARK.

THE MARK CONSISTS OF THE COLORS RED, YELLOW, ORANGE, PURPLE AND GOLD APPEAR IN THE LEAF DESIGN. THE COLOR BLACK APPEARS IN THE WORDING. THE COLOR WHITE APPEARS IN THE BACKGROUND.

FOR HARDWOOD FLOORING (U.S. CLS. 1, 12, 33 AND 50).

DORITT L. CARROLL, EXAMINING ATTORNEY

SN 78-844,191. E FOAM CORPORATION, NORTH LAS VEGAS, NV. FILED 3-23-2006.

E BASE

THE MARK CONSISTS OF STANDARD CHARACTERS WITHOUT CLAIM TO ANY PARTICULAR FONT, STYLE, SIZE, OR COLOR.

FOR DECORATIVE FOAM CORE ARCHITECTURAL ELEMENTS THAT ARE COATED TO RESEMBLE STONE (U.S. CLS. 1, 12, 33 AND 50).

ALLISON SCHRODY, EXAMINING ATTORNEY

CLASS 19—(Continued).

SN 78-844,200. E FOAM CORPORATION, NORTH LAS VEGAS, NV. FILED 3-23-2006.

ECONO-TRIM

THE MARK CONSISTS OF STANDARD CHARACTERS WITHOUT CLAIM TO ANY PARTICULAR FONT, STYLE, SIZE, OR COLOR.

FOR DECORATIVE FOAM CORE ARCHITECTURAL ELEMENTS THAT ARE COATED TO RESEMBLE STONE (U.S. CLS. 1, 12, 33 AND 50).

ALLISON SCHRODY, EXAMINING ATTORNEY

CLASS 19—(Continued).

SN 78-844,625. SAINT-GOBAIN PERFORMANCE PLASTICS CORPORATION, AURORA, OH. FILED 3-23-2006.

QUADRI-FLEX

THE MARK CONSISTS OF STANDARD CHARACTERS WITHOUT CLAIM TO ANY PARTICULAR FONT, STYLE, SIZE, OR COLOR.

FOR NON-METAL FLEXIBLE EXPANSION JOINT USED TO ACCOMMODATE THE EXPANSION AND CONTRACTION OF METAL (U.S. CLS. 1, 12, 33 AND 50).

PAUL CROWLEY, EXAMINING ATTORNEY

SN 78-844,568. SAROYAN LUMBER CO., HUNTINGTON PARK, CA. FILED 3-23-2006.

REDASIO

THE MARK CONSISTS OF STANDARD CHARACTERS WITHOUT CLAIM TO ANY PARTICULAR FONT, STYLE, SIZE, OR COLOR.

FOR FLOOR BOARDS; WOODEN FLOORING (U.S. CLS. 1, 12, 33 AND 50).

FIRST USE 1-26-2006; IN COMMERCE 1-26-2006.
PRISCILLA MILTON, EXAMINING ATTORNEY

SN 78-844,784. DROPIK, JESSE, WALWORTH, WI. AND SAUNDERS, KEVIN, WALWORTH, WI. FILED 3-23-2006.

HOVER HUT

THE MARK CONSISTS OF STANDARD CHARACTERS WITHOUT CLAIM TO ANY PARTICULAR FONT, STYLE, SIZE, OR COLOR.

NO CLAIM IS MADE TO THE EXCLUSIVE RIGHT TO USE HUT, APART FROM THE MARK AS SHOWN.

FOR ICE FISHING HOUSES NOT OF METAL (U.S. CLS. 1, 12, 33 AND 50).

FRED CARL, EXAMINING ATTORNEY

SN 78-844,605. SAROYAN LUMBER CO., HUNTINGTON PARK, CA. FILED 3-23-2006.

BROVANTE

THE MARK CONSISTS OF STANDARD CHARACTERS WITHOUT CLAIM TO ANY PARTICULAR FONT, STYLE, SIZE, OR COLOR.

FOR FLOOR BOARDS; WOODEN FLOORING (U.S. CLS. 1, 12, 33 AND 50).

FIRST USE 1-26-2006; IN COMMERCE 1-26-2006.
PRISCILLA MILTON, EXAMINING ATTORNEY

SN 78-855,548. NAN YA PLASTICS CORPORATION, TAIPEI, TAIWAN, FILED 4-6-2006.

TRANSLUMA DOORS

THE MARK CONSISTS OF STANDARD CHARACTERS WITHOUT CLAIM TO ANY PARTICULAR FONT, STYLE, SIZE, OR COLOR.

NO CLAIM IS MADE TO THE EXCLUSIVE RIGHT TO USE "DOORS", APART FROM THE MARK AS SHOWN.

FOR NON-METALLIC BUILDING PRODUCTS, NAMELY DOORS (U.S. CLS. 1, 12, 33 AND 50).

ESTHER A. BORSUK, EXAMINING ATTORNEY

CLASS 19—(Continued).

SN 78-855,567. NAN YA PLASTICS CORPORATION, TAIPEI, TAIWAN, FILED 4-6-2006.

ACURITE DOORS

THE MARK CONSISTS OF STANDARD CHARACTERS WITHOUT CLAIM TO ANY PARTICULAR FONT, STYLE, SIZE, OR COLOR.

NO CLAIM IS MADE TO THE EXCLUSIVE RIGHT TO USE "DOORS", APART FROM THE MARK AS SHOWN.

FOR NON-METALLIC BUILDING PRODUCTS, NAMELY DOORS (U.S. CLS. 1, 12, 33 AND 50).

ESTHER A. BORSUK, EXAMINING ATTORNEY

SN 78-856,822. NAN YA PLASTICS CORPORATION, TAIPEI, TAIWAN, FILED 4-7-2006.

NEUMA DOORS

THE MARK CONSISTS OF STANDARD CHARACTERS WITHOUT CLAIM TO ANY PARTICULAR FONT, STYLE, SIZE, OR COLOR.

NO CLAIM IS MADE TO THE EXCLUSIVE RIGHT TO USE "DOORS", APART FROM THE MARK AS SHOWN.

FOR NON-METALLIC BUILDING MATERIALS, NAMELY DOORS (U.S. CLS. 1, 12, 33 AND 50).

ESTHER A. BORSUK, EXAMINING ATTORNEY

SN 78-858,404. FIBER COMPOSITES, LLC, NEW LONDON, NC. FILED 4-11-2006.

FIBERAIL

THE MARK CONSISTS OF STANDARD CHARACTERS WITHOUT CLAIM TO ANY PARTICULAR FONT, STYLE, SIZE, OR COLOR.

OWNER OF U.S. REG. NO. 2,420,267.
SEC. 2(F).

FOR COMBINATION PLASTIC AND WOOD MATERIAL USED AS A WOOD SUBSTITUTE, IN THE FORM OF BOARDS, RAILS, SPINDLES, BALUSTERS, POSTS AND MOLDINGS (U.S. CLS. 1, 12, 33 AND 50).

FIRST USE 11-1-1999; IN COMMERCE 11-1-1999.
MICHELE SWAIN, EXAMINING ATTORNEY

CLASS 19—(Continued).

SN 78-860,568. RODIS, NANCY, J., ELLICOTT CITY, MD. AND ALLEN, HOLLYS, ELLICOTT CITY, MD. FILED 4-13-2006.

Permorial

THE MARK CONSISTS OF STANDARD CHARACTERS WITHOUT CLAIM TO ANY PARTICULAR FONT, STYLE, SIZE, OR COLOR.

FOR STATUES OF CONCRETE (U.S. CLS. 1, 12, 33 AND 50).

ADA HAN, EXAMINING ATTORNEY

SN 78-860,589. LAFARGE NORTH AMERICA INC., HERN-DON, VA. FILED 4-13-2006.

FortiMax

THE MARK CONSISTS OF STANDARD CHARACTERS WITHOUT CLAIM TO ANY PARTICULAR FONT, STYLE, SIZE, OR COLOR.

FOR CEMENT MIXES (U.S. CLS. 1, 12, 33 AND 50).

DORITT L. CARROLL, EXAMINING ATTORNEY

SN 78-860,591. LAFARGE NORTH AMERICA INC., HERN-DON, VA. FILED 4-13-2006.

FortiPave

THE MARK CONSISTS OF STANDARD CHARACTERS WITHOUT CLAIM TO ANY PARTICULAR FONT, STYLE, SIZE, OR COLOR.

FOR CEMENT MIXES (U.S. CLS. 1, 12, 33 AND 50).

DORITT L. CARROLL, EXAMINING ATTORNEY

CLASS 19—(Continued).

SN 78-860,861. BOLICK DISTRIBUTORS, CORP., BATON ROUGE, LA. FILED 4-13-2006.

SETTING THE COURSE FOR
FINE LIVING

THE MARK CONSISTS OF STANDARD CHARACTERS WITHOUT CLAIM TO ANY PARTICULAR FONT, STYLE, SIZE, OR COLOR.

FOR HARDWOOD FLOORING (U.S. CLS. 1, 12, 33 AND 50).
KATHERINE CONNOLLY, EXAMINING ATTORNEY

CLASS 19—(Continued).

SN 78-862,699. RHYNE & SON, INC., RINGGOLD, GA. FILED 4-17-2006.



OWNER OF U.S. REG. NO. 3,032,301.
FOR TILES OF CLAY, GLASS, GYPSUM, CERAMIC OR EARTHENWARE (U.S. CLS. 1, 12, 33 AND 50).
JOHN WILKE, EXAMINING ATTORNEY

SN 78-862,518. AMERICAN SILESTONE & GRANITE, INC., WILLINGBORO, NJ. FILED 4-17-2006.

LEXTON

THE MARK CONSISTS OF STANDARD CHARACTERS WITHOUT CLAIM TO ANY PARTICULAR FONT, STYLE, SIZE, OR COLOR.

FOR NON-METALLIC BUILDING MATERIALS, NAMELY ACRYLIC SOLID SURFACES (U.S. CLS. 1, 12, 33 AND 50).
FIRST USE 6-1-2005; IN COMMERCE 6-1-2005.
MARGERY A. TIERNEY, EXAMINING ATTORNEY

SN 78-863,632. QUALITY CRAFT, LTD., SURREY, B.C., CANADA, FILED 4-18-2006.

LAMIPRO

THE MARK CONSISTS OF STANDARD CHARACTERS WITHOUT CLAIM TO ANY PARTICULAR FONT, STYLE, SIZE, OR COLOR.

FOR LAMINATED OR SIMULATED HARDWOOD FLOORING (U.S. CLS. 1, 12, 33 AND 50).
KELLEY WELLS, EXAMINING ATTORNEY

SN 78-862,660. GEORGIA-PACIFIC CORPORATION, ATLANTA, GA. FILED 4-17-2006.

DRYPLY

THE MARK CONSISTS OF STANDARD CHARACTERS WITHOUT CLAIM TO ANY PARTICULAR FONT, STYLE, SIZE, OR COLOR.

FOR PLYWOOD (U.S. CLS. 1, 12, 33 AND 50).
FIRST USE 2-15-2006; IN COMMERCE 2-15-2006.
LINDA MICKLEBURGH, EXAMINING ATTORNEY

SN 78-864,796. GEORGIA-PACIFIC CORPORATION, ATLANTA, GA. FILED 4-19-2006.

DRYPLY

THE MARK CONSISTS OF STANDARD CHARACTERS WITHOUT CLAIM TO ANY PARTICULAR FONT, STYLE, SIZE, OR COLOR.

FOR ORIENTED STRAND BOARD (U.S. CLS. 1, 12, 33 AND 50).
LINDA MICKLEBURGH, EXAMINING ATTORNEY

CLASS 19—(Continued).

SN 78-865,453. KEYSTONE RETAINING WALL SYSTEMS, INC., MINNEAPOLIS, MN. FILED 4-20-2006.

PALAZZO STONE

THE MARK CONSISTS OF STANDARD CHARACTERS WITHOUT CLAIM TO ANY PARTICULAR FONT, STYLE, SIZE, OR COLOR.

NO CLAIM IS MADE TO THE EXCLUSIVE RIGHT TO USE "STONE", APART FROM THE MARK AS SHOWN.

FOR MODULAR CONCRETE BLOCKS USED TO CONSTRUCT EARTH RETAINING WALLS; MODULAR CONCRETE BLOCKS USED IN LANDSCAPING APPLICATIONS (U.S. CLS. 1, 12, 33 AND 50).

FIRST USE 2-15-2006; IN COMMERCE 2-15-2006.

HEATHER THOMPSON, EXAMINING ATTORNEY

CLASS 19—(Continued).

SN 78-872,439. GREENBLOCK WORLDWIDE CORP., STUART, FL. FILED 4-28-2006.

GREENBLOCK

THE MARK CONSISTS OF STANDARD CHARACTERS WITHOUT CLAIM TO ANY PARTICULAR FONT, STYLE, SIZE, OR COLOR.

OWNER OF U.S. REG. NO. 2,443,525.

SEC. 2(F).

FOR ENVIRONMENTALLY FRIENDLY BUILDING CONSTRUCTION MATERIALS, NAMELY INSULATED CONCRETE FORM PANELS (U.S. CLS. 1, 12, 33 AND 50).

FIRST USE 10-8-1992; IN COMMERCE 10-8-1992.

MATTHEW MCDOWELL, EXAMINING ATTORNEY

SN 78-868,415. BUDDY'S BARKING LOT INC., ARDSLEY, NY. FILED 4-24-2006.

Pooch Porch

THE MARK CONSISTS OF STANDARD CHARACTERS WITHOUT CLAIM TO ANY PARTICULAR FONT, STYLE, SIZE, OR COLOR.

NO CLAIM IS MADE TO THE EXCLUSIVE RIGHT TO USE "POOCH", APART FROM THE MARK AS SHOWN.

FOR PRE-FABRICATED DOG HOUSES (U.S. CLS. 1, 12, 33 AND 50).

LAURIE MAYES, EXAMINING ATTORNEY

SN 78-878,802. EPIC FLOORS, LLC, BALTIMORE, MD. FILED 5-8-2006.

Démodé

THE MARK CONSISTS OF STANDARD CHARACTERS WITHOUT CLAIM TO ANY PARTICULAR FONT, STYLE, SIZE, OR COLOR.

FOR HARDWOOD FLOORING (U.S. CLS. 1, 12, 33 AND 50).

JOHN KELLY, EXAMINING ATTORNEY

SN 78-870,303. NICHIIA CORPORATION, NAGOYA-SHI, JAPAN, FILED 4-26-2006.

Cinderstone

THE MARK CONSISTS OF STANDARD CHARACTERS WITHOUT CLAIM TO ANY PARTICULAR FONT, STYLE, SIZE, OR COLOR.

FOR NON-METAL BUILDING MATERIALS, NAMELY, CEMENT EXTERIOR WALLS (U.S. CLS. 1, 12, 33 AND 50).

FIRST USE 1-1-2004; IN COMMERCE 1-1-2004.

MONIQUE MILLER, EXAMINING ATTORNEY

SN 78-885,909. VALMONT INDUSTRIES, INC., OMAHA, NE. FILED 5-17-2006.

XTREME

THE MARK CONSISTS OF STANDARD CHARACTERS WITHOUT CLAIM TO ANY PARTICULAR FONT, STYLE, SIZE, OR COLOR.

FOR FIBERGLASS COMPOSITE POLE BASE COVERS (U.S. CLS. 1, 12, 33 AND 50).

FIRST USE 8-7-2003; IN COMMERCE 8-7-2003.

HOWARD SMIGA, EXAMINING ATTORNEY

CLASS 19—(Continued).

SN 78-897,028. GEORGIA-PACIFIC CORPORATION, ATLANTA, GA. FILED 5-31-2006.

DRYGUARD

THE MARK CONSISTS OF STANDARD CHARACTERS WITHOUT CLAIM TO ANY PARTICULAR FONT, STYLE, SIZE, OR COLOR.

FOR ORIENTED STRAND BOARD (U.S. CLS. 1, 12, 33 AND 50).

LINDA MICKLEBURGH, EXAMINING ATTORNEY

SN 78-901,575. KEYSTONE RETAINING WALL SYSTEMS, INC., MINNEAPOLIS, MN. FILED 6-6-2006.

STONEGATE

THE MARK CONSISTS OF STANDARD CHARACTERS WITHOUT CLAIM TO ANY PARTICULAR FONT, STYLE, SIZE, OR COLOR.

FOR MODULAR CONCRETE BLOCKS USED TO CONSTRUCT EARTH RETAINING WALLS; MODULAR CONCRETE BLOCKS USED IN LANDSCAPING APPLICATIONS (U.S. CLS. 1, 12, 33 AND 50).

FIRST USE 12-31-2004; IN COMMERCE 12-31-2004.
HEATHER THOMPSON, EXAMINING ATTORNEY

SN 78-958,371. EASY GARDENER PRODUCTS, INC., WACO, TX. FILED 8-23-2006.

MAXIGRID

THE MARK CONSISTS OF STANDARD CHARACTERS WITHOUT CLAIM TO ANY PARTICULAR FONT, STYLE, SIZE, OR COLOR.

FOR PLASTIC FENCING (U.S. CLS. 1, 12, 33 AND 50).
FIRST USE 8-15-2003; IN COMMERCE 8-15-2003.
CORY BOONE, EXAMINING ATTORNEY

CLASS 19—(Continued).

SN 79-003,286. ANHUI CONCH GROUP COMPANY LIMITED, CHINA, FILED 3-1-2004.

CONCH

OWNER OF INTERNATIONAL REGISTRATION 0827139 DATED 3-1-2004, EXPIRES 3-1-2014.

FOR FILLING CEMENT, BUILDING CEMENT, OIL WELL CEMENT, MASONRY CEMENT, PORTLAND CEMENT FOR ROADS; PRE-CAST UNITS MADE OF CEMENT AND CONCRETE IN THE USE OF FRAME CONSTRUCTION OR ASSEMBLING CONSTRUCTION; BRICKS, GROG MADE OF CEMENT OR CONCRETE MIXED WITH SLAG POWDER; ASPHALT ROOF COATING FOR BUILDINGS, FIREPROOF CEMENT COATINGS; GRAVESTONE MADE OF CONCRETE, STONE AND MARBLE; NON-AGRICULTURE LIME; CEMENT, NON-METAL BUILDING MATERIALS, NAMELY, SOFFITS; NON-METAL JALOUSIES; NON-METAL PROPS MADE OF CHEMICAL COMPOSITES USED FOR DOORS, DOOR FRAMES, WINDOWS, WINDOW FRAMES, CEILINGS AND DOOR ENTRANCE; NON-METAL DOORS AND DOOR PANELS; NON-METAL WINDOWS; PLYWOOD; NON-METAL CEILING PANELS; BUILDING MATERIALS, NAMELY, SLAG STONE (U.S. CLS. 1, 12, 33 AND 50).

GISELLE AGOSTO, EXAMINING ATTORNEY

SN 79-022,095. CERAMICHE CAESAR SPA, ITALY, FILED 12-22-2005.



FAP CERAMICHE

OWNER OF INTERNATIONAL REGISTRATION 0880329 DATED 12-22-2005, EXPIRES 12-22-2015.

NO CLAIM IS MADE TO THE EXCLUSIVE RIGHT TO USE "CERAMICHE", APART FROM THE MARK AS SHOWN.

THE MARK COMPRISES THE WORDS FAP CERAMICHE IN FANCY UPPERCASE FONT, NEXT TO WHICH THERE IS THE PROFILE OF A PEACOCK WITHIN A SQUARE SHAPE.

FOR NON-METALLIC BUILDING MATERIALS, PARTICULARLY FLOOR AND WALL TILES, FLOOR COVERINGS, ANGLE BEADS, COVES, NON-METALLIC ANGLE IRONS, EXTERNAL ANGLES, MODULAR ELEVATED FLOORING, SPECIAL FINISHING PARTS, STEP TREADS (U.S. CLS. 1, 12, 33 AND 50).

HEATHER THOMPSON, EXAMINING ATTORNEY

CLASS 19—(Continued).

SN 79-022,248. IMPRONTA ITALGRANITI; INDUSTRIE CERAMICHE S.P.A., ITALY, FILED 12-14-2005.

IMPRONTA ITALGRANITI

THE MARK CONSISTS OF STANDARD CHARACTERS WITHOUT CLAIM TO ANY PARTICULAR FONT, STYLE, SIZE, OR COLOR.

PRIORITY DATE OF 9-7-2005 IS CLAIMED.

OWNER OF INTERNATIONAL REGISTRATION 0880820 DATED 12-14-2005, EXPIRES 12-14-2015.

NO CLAIM IS MADE TO THE EXCLUSIVE RIGHT TO USE IMPRONTA, APART FROM THE MARK AS SHOWN. IMPRONTA MEANS "IMPRINT"; "ITALGRANITI" IS A FANCIFUL WORD.

FOR CERAMIC TILES FOR FLOORS AND COVERINGS MADE OF RAW MATERIALS FOR CERAMICS, NAMELY CLAY AND QUARTZ (U.S. CLS. 1, 12, 33 AND 50).

KATHLEEN M. VANSTON, EXAMINING ATTORNEY

CLASS 20—FURNITURE AND ARTICLES NOT OTHERWISE CLASSIFIED

SN 76-636,773. DEWITT, LES JR., WICHITA, KS. FILED 4-1-2005.



NO CLAIM IS MADE TO THE EXCLUSIVE RIGHT TO USE "COLLAR" AND "ID", APART FROM THE MARK AS SHOWN.

FOR PLASTIC PET IDENTIFICATION TAGS (U.S. CLS. 2, 13, 22, 25, 32 AND 50).

FIRST USE 1-23-1998; IN COMMERCE 1-23-1998.

SANJEEV VOHRA, EXAMINING ATTORNEY

SN 76-656,067. INTERKAL LLC, KALAMAZOO, MI. FILED 3-3-2006.

COMFOTHERM

THE MARK CONSISTS OF STANDARD CHARACTERS WITHOUT CLAIM TO ANY PARTICULAR FONT, STYLE, SIZE, OR COLOR.

FOR STADIUM AND ARENA CHAIRS AND SEATS, GYMNASIUM SEATING, AND BLEACHER SEATING SYSTEMS (U.S. CLS. 2, 13, 22, 25, 32 AND 50).

JAMES A. RAUEN, EXAMINING ATTORNEY

CLASS 20—(Continued).

SN 76-657,616. ALUMAFAB CORPORATION, PARAMOUNT, CA. FILED 3-31-2006.

SHOWCASE COMPONENTS

THE MARK CONSISTS OF STANDARD CHARACTERS WITHOUT CLAIM TO ANY PARTICULAR FONT, STYLE, SIZE, OR COLOR.

OWNER OF U.S. REG. NO. 2,409,605.

NO CLAIM IS MADE TO THE EXCLUSIVE RIGHT TO USE "SHOWCASE", APART FROM THE MARK AS SHOWN. SEC. 2(F).

FOR FURNITURE, NAMELY SALES AND DISPLAY COUNTERS (U.S. CLS. 2, 13, 22, 25, 32 AND 50).

FIRST USE 1-1-1990; IN COMMERCE 1-1-1990.

BERNICE HOWSE, EXAMINING ATTORNEY

SN 78-592,682. WOODCRAFTERS TX L.P., WESLACO, TX. FILED 3-22-2005.



OWNER OF U.S. REG. NOS. 2,578,171 AND 2,688,332.

THE MARK CONSISTS OF THE WORDS WOOD CRAFTERS BORDERED ON THE TOP AND BOTTOM WITH A LINE BORDER AND A TREE LIMB DESIGN ELEMENT THAT EMANATES FROM THE TOP OF THE LETTER "E" IN THE WORD "CRAFTERS" AND INCLUDES THREE DISTINCT LEAVES ALONG WITH AN ACORN AT THE TIP OF ONE BRANCH OF THE LIMB.

SEC. 2(F) AS TO "WOOD CRAFTERS".

FOR FURNITURE, NAMELY, BATHROOM VANITIES, BATHROOM CABINETS, MEDICINE CABINETS, MIRRORING CABINETS, KITCHEN CABINETS, CABINETS, STORAGE RACKS, SHELVING, DISPLAY UNITS, WALL UNITS, MIRRORS, BATHROOM AND SHAVING MIRRORS, SHAPED CULTURED MARBLE FOR USE AS A COUNTERTOP, VANITY TOP OR TABLETOP; FURNITURE PARTS, NAMELY, COUNTERTOPS; NON-METAL CABINET DOOR CATCHES (U.S. CLS. 2, 13, 22, 25, 32 AND 50).

FIRST USE 6-30-1994; IN COMMERCE 6-30-1994.

EUGENIA MARTIN, EXAMINING ATTORNEY

CLASS 20—(Continued).

SN 78-673,029. MOXBOX, LLC, ST. PETERSBURG, FL. FILED 7-19-2005.

MOXBOX

THE MARK CONSISTS OF STANDARD CHARACTERS WITHOUT CLAIM TO ANY PARTICULAR FONT, STYLE, SIZE, OR COLOR.

FOR FURNITURE, NAMELY, BUFFETS, ENTERTAINMENT CENTERS, SIDE TABLES, COFFEE TABLES, DRESSERS, HEADBOARDS AND FILING CABINETS; HOME FURNISHINGS, NAMELY, ROOM DIVIDERS, AND SCREENS (U.S. CLS. 2, 13, 22, 25, 32 AND 50).

FIRST USE 1-1-2004; IN COMMERCE 3-1-2005.
SAIMA MAKHDOOM, EXAMINING ATTORNEY

CLASS 20—(Continued).

SN 78-701,551. FERGUSON ENTERPRISES, INC., NEWPORT NEWS, VA. FILED 8-26-2005.

OWNER OF U.S. REG. NO. 3,050,928.
FOR BATHROOM FURNITURE, NAMELY, SINK COUNTERS, STORAGE CABINETS WITH DOORS AND/OR DRAWERS, PHARMACY CUPBOARDS, LINEN CUPBOARDS, BATHROOM VANITIES, SHELVES, AND DECORATIVE WALL MIRRORS (U.S. CLS. 2, 13, 22, 25, 32 AND 50).
DANNEAN HETZEL, EXAMINING ATTORNEY

SN 78-702,279. NORTH AMERICAN ENCLOSURES, INC., CENTRAL ISLIP, NY. FILED 8-29-2005.

LANDMARK

THE MARK CONSISTS OF STANDARD CHARACTERS WITHOUT CLAIM TO ANY PARTICULAR FONT, STYLE, SIZE, OR COLOR.

FOR PICTURE FRAMES, NOT INCLUDING FRAMED ARTWORK (U.S. CLS. 2, 13, 22, 25, 32 AND 50).
FIRST USE 8-2-2005; IN COMMERCE 8-2-2005.
MARY MUNSON, EXAMINING ATTORNEY

SN 78-673,697. WORLD BASEBALL CLASSIC, INC., NEW YORK, NY. FILED 7-19-2005.

BASEBALL SPOKEN HERE

SN 78-703,620. BUILT NY, INC., NEW YORK, NY. FILED 8-30-2005.

BUILT NY

THE MARK CONSISTS OF STANDARD CHARACTERS WITHOUT CLAIM TO ANY PARTICULAR FONT, STYLE, SIZE, OR COLOR.

FOR FURNITURE, TABLES, BENCHES, STOOLS, CHAIRS, BED HEADBOARDS, BOOSTER SEATS, CHESTS, MIRRORS, WINDOW BLINDS, CABINETS, CHAIR PADS, HAMPERS, CUSHIONS, PILLOWS, SLEEPING BAGS, DRINKING STRAWS, PLASTIC LICENSE PLATES, PLASTIC PET ID TAGS, NON-METAL BOTTLE CAPS, PLASTIC KEY CHAIN TAGS, NON-METAL AND NON-LEATHER KEY CHAINS, NON-METAL KEY FOBS, NON-METAL KEY RINGS, NON-METAL KEY HOLDERS, NON-METAL MONEY CLIPS, PLAQUES, DECORATIVE MOBILES, PICTURE FRAMES, SNOW GLOBES, NON-METAL BOXES OTHER THAN THOSE OF PAPER, NON-METAL MAILBOXES, STORAGE RACKS FOR ORGANIZING CLOTHES AND SPORTS EQUIPMENT, NON-METAL LOCKERS, DISPLAY RACKS AND POINT OF PURCHASE DISPLAYS (U.S. CLS. 2, 13, 22, 25, 32 AND 50).
ELLEN PERKINS, EXAMINING ATTORNEY

THE MARK CONSISTS OF STANDARD CHARACTERS WITHOUT CLAIM TO ANY PARTICULAR FONT, STYLE, SIZE, OR COLOR.

OWNER OF U.S. REG. NOS. 2,984,681 AND 3,026,567.
NO CLAIM IS MADE TO THE EXCLUSIVE RIGHT TO USE "NY", APART FROM THE MARK AS SHOWN.
FOR INFLATABLE CONTAINERS FOR TRANSPORTATION OF MERCHANDISE MATERIALS, FOOD, BEVERAGES AND PERSONAL ITEMS; REUSABLE PLASTIC INFLATABLE CONTAINERS FOR TRANSPORTATION OF MERCHANDISE OR MATERIALS; DISPOSABLE REUSABLE PLASTIC INFLATABLE CONTAINERS FOR TRANSPORTATION OF MERCHANDISE OR MATERIALS; FURNITURE; SEATING FURNITURE; OUTDOOR FURNITURE; LIVING ROOM FURNITURE; TABLES; FURNITURE FOR CAMPING (U.S. CLS. 2, 13, 22, 25, 32 AND 50).
JOHN DALIER, EXAMINING ATTORNEY

CLASS 20—(Continued).

SN 78-707,538. HOME CASUAL ENTERPRISES, LLC, BIRMINGHAM, AL. FILED 9-6-2005.



NO CLAIM IS MADE TO THE EXCLUSIVE RIGHT TO USE "HOME", APART FROM THE MARK AS SHOWN.

THE COLOR(S) GRAY, COPPER, BLACK AND WHITE IS/ARE CLAIMED AS A FEATURE OF THE MARK.

THE MARK CONSISTS OF THE OUTLINE OF A TABLE, UMBRELLA AND CHAIR IN THE COLOR BLACK, THE SHAPE IN THE BACKGROUND APPEARS IN THE COLOR GRAY, THE STRIPE NEAR THE BOTTOM APPEARS IN THE COLOR COPPER, THE RECTANGULAR BOX CONTAINING THE LOWER CASE WORD 'HOME' APPEARS IN THE COLOR BLACK WITH A WHITE BACKGROUND AND THE LOWER CASE WORD 'CASUAL' APPEARS IN THE COLOR WHITE ON A BLACK BACKGROUND, THE PHRASE 'EXPERIENCE THE WORLD AT HOME' APPEARS IN THE COLOR GRAY.

FOR OUTDOOR FURNITURE (U.S. CLS. 2, 13, 22, 25, 32 AND 50).

FIRST USE 11-0-2003; IN COMMERCE 11-0-2003.

CIMMERIAN COLEMAN, EXAMINING ATTORNEY

CLASS 20—(Continued).

SN 78-726,332. SEGIS, POGGIBONSI (SI), ITALY, FILED 10-4-2005.

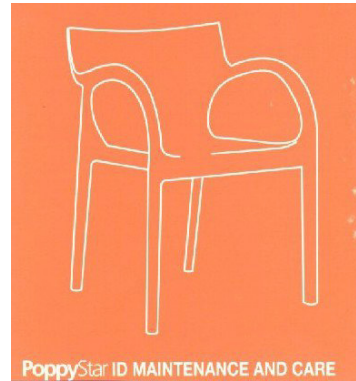

NO CLAIM IS MADE TO THE EXCLUSIVE RIGHT TO USE "ID MAINTENANCE AND CARE" AND THE DESIGN OF A CHAIR, APART FROM THE MARK AS SHOWN.

THE COLORS ORANGE AND WHITE ARE CLAIMED AS A FEATURE OF THE MARK.

THE MARK CONSISTS OF A RECTANGULAR SHAPE, THE CENTER OF WHICH FEATURES AN OUTLINE OF A CHAIR, BENEATH WHICH APPEARS THE WORDING POPPYSTAR ID MAINTENANCE AND CARE. THE COLOR ORANGE APPEARS ON THE BACKGROUND OF THE MARK. THE COLOR WHITE APPEARS ON THE OUTLINE OF THE CHAIR AND THE WORDING POPPYSTAR ID MAINTENANCE AND CARE.

FOR FURNITURE (U.S. CLS. 2, 13, 22, 25, 32 AND 50).

FIRST USE 5-5-2005; IN COMMERCE 5-5-2005.

KAELIE KUNG, EXAMINING ATTORNEY

SN 78-766,420. JASPER SEATING COMPANY, INC., JASPER, IN. FILED 12-5-2005.

SN 78-711,396. SANDBERG FURNITURE, LOS ANGELES, CA. FILED 9-12-2005.

SANDBERG FURNITURE

THE MARK CONSISTS OF STANDARD CHARACTERS WITHOUT CLAIM TO ANY PARTICULAR FONT, STYLE, SIZE, OR COLOR.

NO CLAIM IS MADE TO THE EXCLUSIVE RIGHT TO USE "FURNITURE", APART FROM THE MARK AS SHOWN.

SEC. 2(F).

FOR FURNITURE (U.S. CLS. 2, 13, 22, 25, 32 AND 50).

FIRST USE 1-0-1918; IN COMMERCE 1-0-1918.

ATTIYA MALIK, EXAMINING ATTORNEY



THE MARK CONSISTS OF A SQUARE IMAGE WITH THE TERMS KLEM AND HOSPITALITY INSIDE WITH THE VERTICAL LINES OF THE "K" AND THE "L" EXTENDED UPWARD.

FOR FURNITURE (U.S. CLS. 2, 13, 22, 25, 32 AND 50).

FIRST USE 5-1-2005; IN COMMERCE 5-1-2005.

JERI J. FICKES, EXAMINING ATTORNEY

CLASS 20—(Continued).

SN 78-778,515. INVISIBLE HAND PRODUCTIONS, LLC, HAMILTON, MT. FILED 12-21-2005.



NO CLAIM IS MADE TO THE EXCLUSIVE RIGHT TO USE "LIGHT WAVE ART", APART FROM THE MARK AS SHOWN.

THE COLORS BLUE, WHITE AND BLACK ARE CLAIMED AS A FEATURE OF THE MARK.

THE COLOR WHITE APPEARS IN ALL WORDS AND LETTERS IN THE MARK EXCEPT THE "W" IN THE WORD "WAVE" WHICH APPEARS IN THE COLOR BLUE. THE UNDERLINING IS THE COLOR BLUE AND THE STAR DESIGN APPEARS IN THE COLOR BLUE. THE RECTANGULAR BACKGROUND DESIGN APPEARS IN THE COLOR BLACK TRIMMED IN WHITE.

THE MARK CONSISTS OF STYLIZED ACRONYM: "LWA" OVER THE TEXT "LIGHTWAVE ART" WITH A WAVY "W", COLORED BLUE.

FOR ENGRAVED AND CUT STONE PLAQUES (U.S. CLS. 2, 13, 22, 25, 32 AND 50).

FIRST USE 11-9-2005; IN COMMERCE 11-9-2005.
MARK T. MULLEN, EXAMINING ATTORNEY

SN 78-780,908. WING AND A PRAYER ANGELIC CREATIONS, INC., LAKE ZURICH, IL. FILED 12-27-2005.



THE MARK CONSISTS OF THE WORDING "WING AND A PRAYER" ABOVE THE WORDING "ANGELIC CREATIONS" AND ABOVE THE WORDING "A LITTLE PEACE OF HEAVEN" A BLUE ANGEL APPEARS ABOVE "WING AND A PRAYER".

FOR BEDROOM FURNITURE; CAST STONE HOUSEHOLD AND GARDEN FURNITURE; CUSHIONS ; DOORS FOR FURNITURE; FITTED FABRIC FURNITURE COVERS; FUNERARY URNS; FURNITURE; FURNITURE CHESTS; FURNITURE FRAMES; FURNITURE PARTS; FURNITURE, NAMELY, DISPLAY UNITS; LAWN FURNITURE; MIRRORS; SEATS; TABLES (U.S. CLS. 2, 13, 22, 25, 32 AND 50).

FIRST USE 7-1-2001; IN COMMERCE 7-1-2001.
MARLENE BELL, EXAMINING ATTORNEY

CLASS 20—(Continued).

SN 78-818,381. CRUZ, ALEXANDER, BOYNTON BEACH, FL. FILED 2-18-2006.

TRILAND

THE MARK CONSISTS OF STANDARD CHARACTERS WITHOUT CLAIM TO ANY PARTICULAR FONT, STYLE, SIZE, OR COLOR.

FOR OFFICE FURNITURE; FURNITURE SYSTEM FOR OFFICES AND BUSINESSES COMPRISED OF PARTITIONS, COUNTERS, SHELVES, DRAWERS, CABLE MANAGEMENT, STORAGE UNITS, DISPLAY CASES, WALL-MOUNTED TABLE SURFACES, SHELF ORGANIZERS, AND ACCESSORIES (U.S. CLS. 2, 13, 22, 25, 32 AND 50).

MATTHEW MCDOWELL, EXAMINING ATTORNEY

SN 78-828,915. MEDICAL TECHNOLOGY (W.B.) INC., LONDON, CANADA, FILED 3-3-2006.



FOR SYNTHETIC, PLASTIC, AND VINYL IDENTIFICATION WRISTBANDS AND TAGS FOR ADMISSION, IDENTIFICATION, PROMOTIONAL, MEDICAL, SAFETY, AND SECURITY PURPOSES (U.S. CLS. 2, 13, 22, 25, 32 AND 50).

DAVID COLLIER, EXAMINING ATTORNEY

SN 78-850,080. TRENDWAY CORPORATION, HOLLAND, MI. FILED 3-30-2006.

STOWAWAY

THE MARK CONSISTS OF STANDARD CHARACTERS WITHOUT CLAIM TO ANY PARTICULAR FONT, STYLE, SIZE, OR COLOR.

FOR OFFICE FURNITURE (U.S. CLS. 2, 13, 22, 25, 32 AND 50).

FIRST USE 2-28-2006; IN COMMERCE 2-28-2006.
YONG KIM, EXAMINING ATTORNEY

CLASS 20—(Continued).

SN 78-851,166. MIKE MEINERS DESIGN, LLC, CHICAGO, IL. FILED 3-31-2006.

PIGGYBACK

THE MARK CONSISTS OF STANDARD CHARACTERS WITHOUT CLAIM TO ANY PARTICULAR FONT, STYLE, SIZE, OR COLOR.

FOR FURNITURE (U.S. CLS. 2, 13, 22, 25, 32 AND 50).
WOODROW HARTZOG, EXAMINING ATTORNEY

SN 78-854,384. DOWN ETC. LLC, SAN FRANCISCO, CA. FILED 4-5-2006.



NO CLAIM IS MADE TO THE EXCLUSIVE RIGHT TO USE "DOWN", APART FROM THE MARK AS SHOWN.

THE MARK CONSISTS OF THE WORDS "DOWN ETC" FOLLOWED BY A TRIANGLE, SQUARE AND CIRCLE.
FOR DOWN PILLOWS (U.S. CLS. 2, 13, 22, 25, 32 AND 50).

FIRST USE 8-1-2001; IN COMMERCE 8-1-2001.
ALAIN LAPTER, EXAMINING ATTORNEY

SN 78-854,732. ROBERTS IRRIGATION PRODUCTS, INC., SAN MARCOS, CA. FILED 4-5-2006.

PRO-GRIP

THE MARK CONSISTS OF STANDARD CHARACTERS WITHOUT CLAIM TO ANY PARTICULAR FONT, STYLE, SIZE, OR COLOR.

FOR PLASTIC FITTINGS FOR IRRIGATION HOSE (U.S. CLS. 2, 13, 22, 25, 32 AND 50).

FIRST USE 1-31-2005; IN COMMERCE 1-31-2005.
MARGARET POWER, EXAMINING ATTORNEY

CLASS 20—(Continued).

SN 78-858,498. NSR (HONG KONG) LIMITED, KOWLOON, HONG KONG, FILED 4-11-2006.



THE MARK CONSISTS OF THE WORDS ME IN MIND IN SPECIAL FORM WITH A REPRESENTATION OF A HOUSE SURROUNDING THE WORD "IN" WITH SMOKE COMING FROM A CHIMNEY.

FOR FURNITURE (U.S. CLS. 2, 13, 22, 25, 32 AND 50).
JESSICA A. POWERS, EXAMINING ATTORNEY

SN 78-860,476. SHEARBURN, TYLER, DANIEL, INDIANAPOLIS, IN. FILED 4-12-2006.

COMFY SACK

THE MARK CONSISTS OF STANDARD CHARACTERS WITHOUT CLAIM TO ANY PARTICULAR FONT, STYLE, SIZE, OR COLOR.

FOR PILLOWS (U.S. CLS. 2, 13, 22, 25, 32 AND 50).
KATHERINE CONNOLLY, EXAMINING ATTORNEY

SN 78-860,535. AMCO METAL INDUSTRIAL CORPORATION, CITY OF INDUSTRY, CA. FILED 4-12-2006.

Koverton

THE MARK CONSISTS OF STANDARD CHARACTERS WITHOUT CLAIM TO ANY PARTICULAR FONT, STYLE, SIZE, OR COLOR.

FOR LAWN FURNITURE; OUTDOOR FURNITURE; SEATING FURNITURE; SEATS (U.S. CLS. 2, 13, 22, 25, 32 AND 50).

FIRST USE 5-17-2005; IN COMMERCE 5-17-2005.
JOHN E. MICHOS, EXAMINING ATTORNEY

CLASS 20—(Continued).

SN 78-860,740. HANDI QUILTER, LLC, BOUNTIFUL, UT.
FILED 4-13-2006.

ELITE-QUILTABLE

THE MARK CONSISTS OF STANDARD CHARACTERS WITHOUT CLAIM TO ANY PARTICULAR FONT, STYLE, SIZE, OR COLOR.

FOR ADJUSTABLE HEIGHT AND LENGTH TABLE (U.S. CLS. 2, 13, 22, 25, 32 AND 50).
SALLY SHIH, EXAMINING ATTORNEY

SN 78-862,465. ZOOKS FAMILY HEX PLACE, LLC, PARADISE, PA. FILED 4-17-2006.

Zook

THE MARK CONSISTS OF STANDARD CHARACTERS WITHOUT CLAIM TO ANY PARTICULAR FONT, STYLE, SIZE, OR COLOR.

SEC. 2(F).
FOR WOODEN OR FIBERBOARD INTERIOR AND EXTERIOR WALL DECORATIONS (U.S. CLS. 2, 13, 22, 25, 32 AND 50).
FIRST USE 1-1-1975; IN COMMERCE 1-1-1975.
BARNEY CHARLON, EXAMINING ATTORNEY

SN 78-862,999. MCCABE, JAMES G., ODESSA, FL. FILED 4-17-2006.

Chase & Taylor

THE MARK CONSISTS OF STANDARD CHARACTERS WITHOUT CLAIM TO ANY PARTICULAR FONT, STYLE, SIZE, OR COLOR.

FOR SLEEP PRODUCTS, NAMELY, MATTRESSES, SPRING MATTRESSES, BOX SPRINGS AND MATTRESS FOUNDATIONS (U.S. CLS. 2, 13, 22, 25, 32 AND 50).
JENNY PARK, EXAMINING ATTORNEY

CLASS 20—(Continued).

SN 78-863,923. SOUTHERN ALUMINUM, MAGNOLIA, AR.
FILED 4-18-2006.

Swirl
[tables]

NO CLAIM IS MADE TO THE EXCLUSIVE RIGHT TO USE TABLES, APART FROM THE MARK AS SHOWN.

THE MARK CONSISTS OF THE WORD 'SWIRL' WITH 'TABLES' IN SQUARED PARENTHESIS UNDER 'SWIRL' AND RIGHT ALIGNED.

FOR TABLES (U.S. CLS. 2, 13, 22, 25, 32 AND 50).
FIRST USE 4-7-2005; IN COMMERCE 4-7-2005.
ZHALEH DELANEY, EXAMINING ATTORNEY

SN 78-864,184. PACIFIC BUSINESS INTERIORS, INC., MURRIETA, CA. FILED 4-18-2006.

SMART
CHAIRS USA

NO CLAIM IS MADE TO THE EXCLUSIVE RIGHT TO USE "SMART", "CHAIRS" OR "USA", APART FROM THE MARK AS SHOWN.

THE COLOR(S) RED, WHITE AND BLACK. IS/ARE CLAIMED AS A FEATURE OF THE MARK.

THE MARK CONSISTS OF THE WORD SMART IN BLACK LETTERING WITH THREE RED DOTS BETWEEN THE "M" AND THE "A" OVER A RED BLOCK CONTAINING THE WORDS CHAIRS AND USA IN WHITE.

FOR OFFICE FURNITURE; OFFICE SEATS (U.S. CLS. 2, 13, 22, 25, 32 AND 50).
CYNTHIA SLOAN, EXAMINING ATTORNEY

SN 78-864,194. PACIFIC BUSINESS INTERIORS, INC., MURRIETA, CA. FILED 4-18-2006.

 **FURSYS**
USA, INC.

NO CLAIM IS MADE TO THE EXCLUSIVE RIGHT TO USE "USA, INC.", APART FROM THE MARK AS SHOWN.

THE COLOR(S) RED BLACK AND WHITE IS/ARE CLAIMED AS A FEATURE OF THE MARK.

THE MARK CONSISTS OF CAPITAL LETTERS IN BLACK OF THE WORDS FURSYS USA, INC. A RED BLOCK OF COLOR IN UPPER LEFT OF LETTER "F".

FOR OFFICE FURNITURE (U.S. CLS. 2, 13, 22, 25, 32 AND 50).
CYNTHIA SLOAN, EXAMINING ATTORNEY

CLASS 20—(Continued).

SN 78-865,013. LEMOYNE SLEEPER CO., INC., LEMOYNE, PA. FILED 4-19-2006.

NIGHT OF LUXURY

THE MARK CONSISTS OF STANDARD CHARACTERS WITHOUT CLAIM TO ANY PARTICULAR FONT, STYLE, SIZE, OR COLOR.

FOR MATTRESSES, BOXSPRINGS AND FURNITURE (U.S. CLS. 2, 13, 22, 25, 32 AND 50).

TANYA AMOS, EXAMINING ATTORNEY

SN 78-865,369. SECURITY FROM ABOVE, LLC, MESA, AZ. FILED 4-19-2006.

Security From Above

THE MARK CONSISTS OF STANDARD CHARACTERS WITHOUT CLAIM TO ANY PARTICULAR FONT, STYLE, SIZE, OR COLOR.

FOR BAG CLOSURES NOT OF METAL; BARREL HOOPS NOT OF METAL; BATHTUB GRAB BARS NOT MADE OF METAL; BATHTUB RAILS NOT MADE OF METAL; BINDING SCREWS, NOT OF METAL, FOR CABLES; BLANK PLASTIC ADHESIVE LABELS; BLINDS OF REED, RATTAN OR BAMBOO (SUDARE); BOTTLE CLOSURES NOT OF METAL; BUSTS OF PLASTIC; CASKS NOT MADE OF METAL; CHAIR MATS IN THE NATURE OF A PILLOW OR SEAT LINER; CHESTS OF DRAWERS; CLEAR PLASTIC HOLDERS FOR BADGES; CLOTHESLINE FASTENER HAVING A PLASTIC FRAME AND PLASTIC GRIPPING PAWS; CLOTHESLINE SPREADER HAVING A PLASTIC FRAME; CONTAINER CLOSURES OF PLASTIC; CONTAINERS FOR INDUSTRIAL AND COMMERCIAL LIQUIDS NOT MADE OF METAL; CONTAINERS, NOT OF METAL FOR COMMERCIAL USE; DESKTOP STATUARY MADE OF PLASTIC; DOOR STOPS OF PLASTIC; DOOR STOPS OF WOOD; DOWELS NOT OF METAL; DRAWER PULLS OF PLASTIC OR WOOD, CORK, REED, CANE, WICKER, HORN, BONE, IVORY, WHALEBONE, SHELL, AMBER, MOTHER-OF-PEARL, MEERSCHAUM AND SUBSTITUTES FOR ALL THESE MATERIALS; FIGURES OF PLASTIC; FIGURINES OF PLASTIC; FITTED PLASTIC INSERTS FOR USE AS CONTAINER LINERS; FIXED TOWEL DISPENSERS NOT OF METAL; FURNITURE FOR DISPLAYING GOODS; GIFT PACKAGE DECORATIONS MADE OF PLASTIC; HAND MIRRORS; HOLIDAY ORNAMENTS OF PLASTIC; HOSE HANGERS NOT OF METAL; IMITATION FOODS FOR DISPLAY MADE OF PLASTIC MATERIALS, NAMELY, IMITATION DESERTS, IMITATION CANDY, IMITATION CAKES; INFLATABLE PLASTIC SIGNS; JEWELRY BOXES NOT OF METAL; JEWELRY CASES NOT OF PRECIOUS METAL; KEY FOBS, NOT OF METAL; LETTER BOXES NOT OF METAL; LETTER BOXES NOT OF METAL OR MASONRY; LETTER BOXES OF PLASTIC; LOCKING PLASTIC CAP THAT COVERS BUNG OPENINGS IN PLASTIC AND METAL CONTAINERS FOR TAMPER EVIDENCE; MATTRESSES MADE OF FLEXIBLE WOOD; MOORING BUOYS, NOT OF METAL; NON-METAL BOXES, OTHER THAN THOSE OF PAPER; NONMETAL CONTAINERS FOR THE TRANSPORT AND STORAGE OF ORGANS, TISSUES AND CELLS FOR MEDICAL AND SCIENTIFIC PURPOSES; ORNAMENTS OF PLASTIC; PACKING CONTAINERS OF PLASTIC MATERIAL; PARTY ORNAMENTS OF PLASTIC; PEG BOARDS MADE OF PLAS-

CLASS 20—(Continued).

TIC; PICTURE FRAMES; PILLOW-LIKE DEVICE COMPRISING PLASTIC CORE, FABRIC, AND CUSHION MATERIAL TO BE WORN ON ARM OR LEG WHILE SLEEPING OR AT REST; PLASTIC BANNERS; PLASTIC BOXES; PLASTIC BUNTING; PLASTIC CAKE DECORATIONS; PLASTIC CAPS; PLASTIC CARD KEYS; PLASTIC CASTERS; PLASTIC CLIPS FOR SEALING BAGS; PLASTIC CONTAINERS, NAMELY, TUBS FOR CONSUMER PRODUCTS PACKAGING; PLASTIC COVER FOR METAL HOSE CLAMPS; PLASTIC CRATES; PLASTIC DOORKNOBS; PLASTIC DRAWER LINING MATERIAL; PLASTIC EAR TAGS FOR LIVESTOCK; PLASTIC EGG CARTONS FOR COMMERCIAL USE; PLASTIC FASTENERS FOR HOLDING BED SHEETS AND LINENS IN PLACE; PLASTIC FLAGS; PLASTIC FURNITURE FOR GARDENS; PLASTIC GARAGE DOOR ROLLERS; PLASTIC GRAVE MARKERS; PLASTIC HANDCUFF STRIPS; PLASTIC HANDCUFFS IN THE NATURE OF PLASTIC STRIPS TO IMMOBILIZE THE HANDS OF INDIVIDUALS; PLASTIC HANDLES FOR CONTAINERS; PLASTIC HANG TAGS; PLASTIC HOLDERS FOR SIGNBOARDS; PLASTIC INSERTS FOR PAPERMILL CORES USED TO FACILITATE ROLL WINDING; PLASTIC INSERTS FOR USE AS CONTAINER LINERS; PLASTIC KEY CHAIN TAGS; PLASTIC KEY RINGS; PLASTIC KEY TAGS; PLASTIC KNOBS; PLASTIC LABELS; PLASTIC LANDSCAPE EDGING; PLASTIC LIDS; PLASTIC LIDS FOR CANS; PLASTIC LUGGAGE LINING MATERIAL; PLASTIC MAILING TUBES; PLASTIC MEDICATION CASES SOLD EMPTY CONTAINING A VIBRATING ALARM AS A REMINDER TO TAKE MEDICATION; PLASTIC MEDICATION CONTAINERS; PLASTIC MOLDS FOR MAKING SOAP; PLASTIC MOLDS FOR MAKING SOAP FOR COMMERCIAL PRODUCTION PURPOSES; PLASTIC MOLDS FOR USE IN MANUFACTURING FURNITURE, BED LINERS, TRAILER FLOORING AND DECKS; PLASTIC NAME BADGES; PLASTIC NOVELTY LICENSE PLATES; PLASTIC NOZZLES USED WITH HIGH VELOCITY AIR BLOWERS TO DRY VEHICLES; PLASTIC PEG BOARDS; PLASTIC PENNANTS; PLASTIC PILLBOXES; PLASTIC RODS FOR SEALING BAGS; PLASTIC SCULPTURES; PLASTIC SHELF LINING MATERIAL; PLASTIC SIGNBOARDS; PLASTIC SQUEEZE TUBES SOLD EMPTY; PLASTIC STORAGE CONTAINERS FOR COMMERCIAL OR INDUSTRIAL USE; PLASTIC STORAGE DRUMS; PLASTIC SUCTION CUPS; PLASTIC TISSUE BOX COVERS; PLASTIC TUBS; PLASTIC WALL MOUNTED BRACKET FOR STORING A PRESSURE WASHER; PLASTIC WHEEL CHOCKS; POINT OF PURCHASE DISPLAYS; PULLEYS OF PLASTIC; RAW MOTHER OF PEARL; REUSABLE PLASTIC INFLATABLE CONTAINER FOR TRANSPORTATION OF MERCHANDISE OR MATERIALS; SCULPTURES OF PLASTIC; SELF-ADHESIVE POLYURETHANE PADS FOR PLACEMENT ON THE UNDERSIDE OF ELECTRONICS PRODUCTS TO PREVENT SLIDING AND/OR SCRATCHING; SHOWER GRAB BARS NOT OF METAL; STATUES OF PLASTIC; STATUETTES OF PLASTIC; STOPPERS OF CORK OR CORK IMITATIONS; SUCTION CUP HANGERS AND HOOKS MADE OF SILICONE POLYMER; TOOL BOXES NOT OF METAL; TOOL CHESTS NOT OF METAL; UPRIGHT SIGNBOARDS OF WOOD OR PLASTICS; VALVES OF PLASTIC BEING OTHER THAN MACHINE PARTS; WORKSTATIONS HAVING MULTI-USE WORK SURFACES FOR USE IN A WIDE VARIETY OF FIELDS (U.S. CLS. 2, 13, 22, 25, 32 AND 50).

MARIA-VICTORIA SUAREZ, EXAMINING ATTORNEY

CLASS 20—(Continued).

SN 78-865,487. PHILL'S CUSTOM CABINETS, OWENSBORO, KY. FILED 4-20-2006.

CABINOTCH

THE MARK CONSISTS OF STANDARD CHARACTERS WITHOUT CLAIM TO ANY PARTICULAR FONT, STYLE, SIZE, OR COLOR.

FOR KITCHEN CABINETS AND CABINETS (U.S. CLS. 2, 13, 22, 25, 32 AND 50).

KIMBERLY FRYE, EXAMINING ATTORNEY

SN 78-868,318. FRANCO, SASSONE E., LIMA, PERU, FILED 4-24-2006.



THE COLOR(S) BLUE, RED, YELLOW AND GRAY IS/ ARE CLAIMED AS A FEATURE OF THE MARK.

THE MARK CONSISTS OF A DIAMOND-SHAPED DESIGN IN BLUE WITH RED AND YELLOW BORDERS, CONTAINING THE WORD AQUASELLAS IN GRAY AND THE STYLIZED DESIGN OF A CHAIR AND WAVY LINES.

FOR FURNITURE, NAMELY CHAIRS (U.S. CLS. 2, 13, 22, 25, 32 AND 50).

GEORGE LORENZO, EXAMINING ATTORNEY

SN 78-871,536. UNITED BARRELS, LLC, NAPA, CA. FILED 4-27-2006.

TONNELLERIE CHALUFOUR

THE MARK CONSISTS OF STANDARD CHARACTERS WITHOUT CLAIM TO ANY PARTICULAR FONT, STYLE, SIZE, OR COLOR.

NO CLAIM IS MADE TO THE EXCLUSIVE RIGHT TO USE "TONNELLERIE", APART FROM THE MARK AS SHOWN.

THE FOREIGN WORDING TONNELLERIE IN THE MARK TRANSLATES INTO ENGLISH AS COOPERAGE.

FOR NON-METALLIC CASKS AND BARRELS (U.S. CLS. 2, 13, 22, 25, 32 AND 50).

FIRST USE 7-22-1998; IN COMMERCE 7-22-1998.

BRENDAN MCCAULEY, EXAMINING ATTORNEY

CLASS 20—(Continued).

SN 78-871,958. GENERATION WAY, INC., MINNEAPOLIS, MN. FILED 4-28-2006.

CARDSICLE

THE MARK CONSISTS OF STANDARD CHARACTERS WITHOUT CLAIM TO ANY PARTICULAR FONT, STYLE, SIZE, OR COLOR.

FOR NONEDIBLE, PLASTIC CREDIT CARD HOLDERS IN WHICH CREDIT CARDS CAN BE FROZEN FOR SAFE KEEPING (U.S. CLS. 2, 13, 22, 25, 32 AND 50).

JILL C. ALT, EXAMINING ATTORNEY

SN 78-871,974. GENERATION WAY, INC., MINNEAPOLIS, MN. FILED 4-28-2006.



FOR NONEDIBLE, PLASTIC CREDIT CARD HOLDERS IN WHICH CREDIT CARDS CAN BE FROZEN FOR SAFE KEEPING (U.S. CLS. 2, 13, 22, 25, 32 AND 50).

JILL C. ALT, EXAMINING ATTORNEY

SN 78-872,623. CASTEC, INC., NORTH HOLLYWOOD, CA. FILED 4-28-2006.

ROLLSTAR

THE MARK CONSISTS OF STANDARD CHARACTERS WITHOUT CLAIM TO ANY PARTICULAR FONT, STYLE, SIZE, OR COLOR.

FOR WINDOW SHADES (U.S. CLS. 2, 13, 22, 25, 32 AND 50).

FIRST USE 12-31-1983; IN COMMERCE 12-31-1983.

ALICE BENMAMAN, EXAMINING ATTORNEY

CLASS 20—(Continued).

SN 78-874,370. ETHNICRAFT, N.V., BOOM, BELGIUM, FILED 5-2-2006.

ETHNICRAFT

THE MARK CONSISTS OF STANDARD CHARACTERS WITHOUT CLAIM TO ANY PARTICULAR FONT, STYLE, SIZE, OR COLOR.

FOR FURNITURE (U.S. CLS. 2, 13, 22, 25, 32 AND 50).
FIRST USE 9-1-2001; IN COMMERCE 9-1-2001.
GEORGE LORENZO, EXAMINING ATTORNEY

SN 78-874,378. ETHNICRAFT, N.V., BOOM, BELGIUM, FILED 5-2-2006.

EMORATIONAL

THE MARK CONSISTS OF STANDARD CHARACTERS WITHOUT CLAIM TO ANY PARTICULAR FONT, STYLE, SIZE, OR COLOR.

FOR FURNITURE (U.S. CLS. 2, 13, 22, 25, 32 AND 50).
FIRST USE 9-1-2001; IN COMMERCE 9-1-2001.
GEORGE LORENZO, EXAMINING ATTORNEY

SN 78-882,473. LEMOYNE SLEEPER CO., INC., LEMOYNE, PA. FILED 5-12-2006.

ULTRA POSTURE

THE MARK CONSISTS OF STANDARD CHARACTERS WITHOUT CLAIM TO ANY PARTICULAR FONT, STYLE, SIZE, OR COLOR.

FOR MATTRESSES AND BOXSPRINGS (U.S. CLS. 2, 13, 22, 25, 32 AND 50).
FIRST USE 9-23-1990; IN COMMERCE 9-23-1990.
TANYA AMOS, EXAMINING ATTORNEY

CLASS 20—(Continued).

SN 78-893,367. HOODLOVE LIMITED LIABILITY COMPANY, EAST ORANGE, NJ. FILED 5-25-2006.

HOOD LOVE

THE MARK CONSISTS OF STANDARD CHARACTERS WITHOUT CLAIM TO ANY PARTICULAR FONT, STYLE, SIZE, OR COLOR.

FOR NON-METAL AND NON-LEATHER KEY CHAINS; PLASTIC BANNERS; PLASTIC KEY CHAIN TAGS (U.S. CLS. 2, 13, 22, 25, 32 AND 50).
BARBARA BROWN, EXAMINING ATTORNEY

SN 78-904,766. TRUE SEATING CONCEPTS, LLC, PORT LOUIS, MAURITIUS, FILED 6-9-2006.

EZ OFFICE

THE MARK CONSISTS OF STANDARD CHARACTERS WITHOUT CLAIM TO ANY PARTICULAR FONT, STYLE, SIZE, OR COLOR.

OWNER OF U.S. REG. NO. 2,820,338.
NO CLAIM IS MADE TO THE EXCLUSIVE RIGHT TO USE OFFICE, APART FROM THE MARK AS SHOWN.
FOR HOME AND OFFICE FURNITURE (U.S. CLS. 2, 13, 22, 25, 32 AND 50).
CAROLINE WEIMER, EXAMINING ATTORNEY

SN 78-904,787. TRUE SEATING CONCEPTS, LLC, PORT LOUIS, MAURITIUS, FILED 6-9-2006.

EZ OFFICE SOLUTIONS

THE MARK CONSISTS OF STANDARD CHARACTERS WITHOUT CLAIM TO ANY PARTICULAR FONT, STYLE, SIZE, OR COLOR.

OWNER OF U.S. REG. NO. 2,820,338.
NO CLAIM IS MADE TO THE EXCLUSIVE RIGHT TO USE OFFICE, APART FROM THE MARK AS SHOWN.
FOR HOME AND OFFICE FURNITURE (U.S. CLS. 2, 13, 22, 25, 32 AND 50).
CAROLINE WEIMER, EXAMINING ATTORNEY

CLASS 20—(Continued).

SN 78-905,500. MARKETING AND CREATIVE SALES, INC., CHESTERFIELD, MO. FILED 6-11-2006.

SING TO ME SONGBIRDS

THE MARK CONSISTS OF STANDARD CHARACTERS WITHOUT CLAIM TO ANY PARTICULAR FONT, STYLE, SIZE, OR COLOR.

FOR MUSICAL FIGURINES PRIMARILY OF PLASTIC (U.S. CLS. 2, 13, 22, 25, 32 AND 50).

DAVID COLLIER, EXAMINING ATTORNEY

SN 78-907,060. LEMOYNE SLEEPER CO., INC., LEMOYNE, PA. FILED 6-13-2006.

Independence

THE MARK CONSISTS OF STANDARD CHARACTERS WITHOUT CLAIM TO ANY PARTICULAR FONT, STYLE, SIZE, OR COLOR.

FOR MATTRESSES, BOXSPRINGS AND FURNITURE (U.S. CLS. 2, 13, 22, 25, 32 AND 50).

FIRST USE 9-8-1998; IN COMMERCE 9-8-1998.

TANYA AMOS, EXAMINING ATTORNEY

SN 79-016,267. CHENG, WANG, XIAMEN FUJIAN, CHINA, AND LIYONG, GAO, XIAMEN FUJIAN, CHINA, AND GAOXIANG, WEN, XIAMEN FUJIAN, CHINA, FILED 9-26-2005.

Teammann

OWNER OF INTERNATIONAL REGISTRATION 0864657 DATED 9-26-2005, EXPIRES 9-26-2015.

FOR BENCHES; CHESTS OF DRAWERS; DISPLAY COUNTERS; TABLES; DISPLAY SHOWCASES; PICTURE FRAMES; CHAIR PADS WOVEN WITH GRASS FIBER; CHAIRS WOVEN WITH CANE FIBER; FIGURES OF RESIN; STATUETTES OF RESIN (U.S. CLS. 2, 13, 22, 25, 32 AND 50).

TONJA GASKINS, EXAMINING ATTORNEY

CLASS 21—HOUSEWARES AND GLASS

SN 75-867,798. MCRAE'S, INC., BIRMINGHAM, AL. FILED 12-10-1999.

CARGO CAFE'

FOR BAKEWARE, BEER JUGS, BEER MUGS, BEVERAGE GLASSWARE, BEVERAGEWARE, BOWLS, CHAMPAGNE BUCKETS, ICE BUCKETS, BUTTER DISHES, CAKE STANDS, CANDLE HOLDERS NOT OF PRECIOUS METAL, CANDLESTICKS NOT OF PRECIOUS METAL, CASSEROLE DISHES, COASTERS, COCKTAIL SHAKERS, COFFEE CUPS, COFFEE POTS NOT OF PRECIOUS METAL, COFFEE SERVICES NOT OF PRECIOUS METAL, COLLANDERS, COOKWARE, NAMELY, POTS AND PANS, CRUET STANDS FOR OIL OR VINEGAR NOT OF PRECIOUS METAL, CRUETS NOT OF PRECIOUS METAL, CUPS, EGG CUPS, DECANTERS, DINNERWARE, GRAVY BOATS, PEPPER GRINDERS, HOUSEHOLD UTENSILS, NAMELY POT AND PAN SCRAPERS, ROLLING PINS, SPATULAS, TURNERS, WHISKS, TEA KETTLES, KITCHEN LADLES, EARTHENWARE MUGS, GLASS MUGS, PORCELAIN MUGS, DUTCH OVENS, METAL PANS, PET FEEDING DISHES, PIE SERVERS, PITCHERS, PLATES, SERVING PLATTERS, SPICE RACKS, TOWEL RACKS, SALAD BOWLS, SALT AND PEPPER SHAKERS, SOUP TUREENS, SYRUP JUGS, VASES (U.S. CLS. 2, 13, 23, 29, 30, 33, 40 AND 50).

RONALD AIKENS, EXAMINING ATTORNEY

SN 76-647,379. CONTEK DESIGN & PRODUCTS INC., SILVER SPRING, MD. FILED 9-23-2005.

FLOSSMILE

FOR DENTAL FLOSS; FLOSS FOR DENTAL PURPOSES AND DENTAL FLOSS DISPENSERS (U.S. CLS. 2, 13, 23, 29, 30, 33, 40 AND 50).

FIRST USE 7-25-2005; IN COMMERCE 7-25-2005.

MARGERY A. TIERNEY, EXAMINING ATTORNEY

SN 76-658,028. KRITCH, JOHN, HIDDEN HILLS, CA. FILED 4-7-2006.



The logo for 'funnelite' features the word 'funnelite' in a bold, lowercase, sans-serif font. Above the letter 'i' is a stylized graphic of a funnel with a single drop of liquid falling from its tip.

FOR FUNNELS (U.S. CLS. 2, 13, 23, 29, 30, 33, 40 AND 50).

SAMUEL E. SHARPER JR., EXAMINING ATTORNEY

CLASS 21—(Continued).

SN 76-658,177. CLEANERS.TV, INC., TOMS RIVER, NJ.
FILED 4-11-2006.

EVERYTHING DUSTER

THE MARK CONSISTS OF STANDARD CHARACTERS WITHOUT CLAIM TO ANY PARTICULAR FONT, STYLE, SIZE, OR COLOR.

NO CLAIM IS MADE TO THE EXCLUSIVE RIGHT TO USE "DUSTER", APART FROM THE MARK AS SHOWN, FOR HAND HELD HOUSEHOLD DUSTER (U.S. CLS. 2, 13, 23, 29, 30, 33, 40 AND 50).

ADA HAN, EXAMINING ATTORNEY

CLASS 21—(Continued).

SN 78-447,764. WINTERLAB LIMITED, NEW YORK, NY.
FILED 7-8-2004.

NICEICE

SN 76-658,577. LIFEWAY CHRISTIAN RESOURCES OF THE SOUTHERN BAPTIST CONVENTION, NASHVILLE, TN.
FILED 4-17-2006.

REMEMBRANCEWARE

THE MARK CONSISTS OF STANDARD CHARACTERS WITHOUT CLAIM TO ANY PARTICULAR FONT, STYLE, SIZE, OR COLOR.

OWNER OF U.S. REG. NO. 2,137,691.
FOR COMMUNIONWARE, NAMELY, TRAYS, BREADPLATES, AND TRAY COVERS (U.S. CLS. 2, 13, 23, 29, 30, 33, 40 AND 50).

DAVID MILLER, EXAMINING ATTORNEY

THE MARK CONSISTS OF STANDARD CHARACTERS WITHOUT CLAIM TO ANY PARTICULAR FONT, STYLE, SIZE, OR COLOR.

FOR REUSABLE PLASTIC WATER-FILLED ICE CUBE SUBSTITUTES FOR USE IN PLACE OF ICE CUBES (U.S. CLS. 2, 13, 23, 29, 30, 33, 40 AND 50).

KHANH LE, EXAMINING ATTORNEY

SN 76-659,063. THE B&F SYSTEM, INC., DALLAS, TX.
FILED 4-24-2006.

LUCA BELLA

THE NAME SHOWN IN THE MARK DOES NOT IDENTIFY A PARTICULAR LIVING INDIVIDUAL.

THE ENGLISH TRANSLATION OF "BELLA" IS BEAUTIFUL.

FOR DECORATIVE ACCESSORIES, NAMELY, NON-ELECTRIC WALL SCONCES NOT OF PRECIOUS METAL (U.S. CLS. 2, 13, 23, 29, 30, 33, 40 AND 50).

FIRST USE 4-30-2005; IN COMMERCE 4-30-2005.
PETER B. BROMAGHIM, EXAMINING ATTORNEY

SN 78-622,210. THINK DRINK INC., LONDON, CANADA,
FILED 5-4-2005.

PermaFrost

THE MARK CONSISTS OF STANDARD CHARACTERS WITHOUT CLAIM TO ANY PARTICULAR FONT, STYLE, SIZE, OR COLOR.

FOR INSULATED AND NON-INSULATED DRINKWARE MADE OF CERAMIC, PLASTIC, STAINLESS STEEL, AND GLASS, NAMELY CUPS, GLASSES, SHOT GLASSES, STEINS, MUGS, TUMBLERS AND CARAFES (U.S. CLS. 2, 13, 23, 29, 30, 33, 40 AND 50).

NELSON SNYDER, EXAMINING ATTORNEY

CLASS 21—(Continued).

SN 78-633,789. WISEBAKER BUILDER SERVICES, LTD., HOUSTON, TX. FILED 5-20-2005.

MIRADO

THE MARK CONSISTS OF STANDARD CHARACTERS WITHOUT CLAIM TO ANY PARTICULAR FONT, STYLE, SIZE, OR COLOR.

THE ENGLISH TRANSLATION OF THE WORDING "MIRADO" IS "TO LOOK, RESPECTFUL, CONSIDERATE, AND DISCREET."

FOR BASINS AND KITCHEN AND BATH ACCESSORIES, NAMELY, LOTION DISPENSERS, SOAP DISPENSERS, BOTTOM BASIN RACKS, COLANDERS, CUTTING BOARDS, WIRE RINSE BASKETS FOR USE IN SINKS, PAPER TOWEL DISPENSERS, TOWEL RACKS, SOAP DISHES, AND WALL SOAP DISHES (U.S. CLS. 2, 13, 23, 29, 30, 33, 40 AND 50).

FIRST USE 3-0-2005; IN COMMERCE 3-0-2005.

MICHAEL KEATING, EXAMINING ATTORNEY

SN 78-638,591. RIDDLE, JESSE, SANDY, UT. FILED 5-26-2005.

I VOTED RED

THE MARK CONSISTS OF STANDARD CHARACTERS WITHOUT CLAIM TO ANY PARTICULAR FONT, STYLE, SIZE, OR COLOR.

FOR MUGS, CUPS, LEATHER COASTERS (U.S. CLS. 2, 13, 23, 29, 30, 33, 40 AND 50).

DAVID MURRAY, EXAMINING ATTORNEY

SN 78-657,775. BLAYCHON PRODUCTS, LLC, FORT COLLINS, CO. FILED 6-24-2005.

ElectraWave

THE MARK CONSISTS OF STANDARD CHARACTERS WITHOUT CLAIM TO ANY PARTICULAR FONT, STYLE, SIZE, OR COLOR.

FOR JEWELRY BOX IN THE NATURE OF A PLASTIC CONTAINER FOR STORING AND ORGANIZING JEWELRY, NAMELY, A NECKLACE HOLDER (U.S. CLS. 2, 13, 23, 29, 30, 33, 40 AND 50).

ELISSA GARBER KON, EXAMINING ATTORNEY

CLASS 21—(Continued).

SN 78-659,233. JOLIECO, LLC, SAN RAMON, AR. FILED 6-27-2005.

JOLIECO

THE MARK CONSISTS OF STANDARD CHARACTERS WITHOUT CLAIM TO ANY PARTICULAR FONT, STYLE, SIZE, OR COLOR.

FOR CHILD AND INFANT FOOD AND DRINK RECEPTACLES NAMELY, PLASTIC CUPS, PLASTIC JUICE BOX HOLDERS, PLASTIC PLATES AND ALL PURPOSE PORTABLE HOUSEHOLD CONTAINERS (U.S. CLS. 2, 13, 23, 29, 30, 33, 40 AND 50).

DAVID TAYLOR, EXAMINING ATTORNEY

SN 78-702,865. GOLDEN G.T LLC, CHICAGO, IL. FILED 8-29-2005.

INDISPENSABLE

THE MARK CONSISTS OF STANDARD CHARACTERS WITHOUT CLAIM TO ANY PARTICULAR FONT, STYLE, SIZE, OR COLOR.

FOR (BASED ON USE IN COMMERCE) HOUSEWARES, NAMELY, DRY FOOD, COFFEE, AND POWDER DISPENSERS; (BASED ON INTENT TO USE) HOUSEWARES, NAMELY, NAMELY, WINE AND BOTTLE OPENERS (U.S. CLS. 2, 13, 23, 29, 30, 33, 40 AND 50).

FIRST USE 8-1-2004; IN COMMERCE 8-1-2004.

JAMES GRIFFIN, EXAMINING ATTORNEY

SN 78-702,899. HOFFECKER, D., THOMAS, CLAWSON, MI. FILED 8-29-2005.

BRUSH FOR THE CURE

THE MARK CONSISTS OF STANDARD CHARACTERS WITHOUT CLAIM TO ANY PARTICULAR FONT, STYLE, SIZE, OR COLOR.

NO CLAIM IS MADE TO THE EXCLUSIVE RIGHT TO USE "BRUSH", APART FROM THE MARK AS SHOWN.

FOR TOOTHBRUSHES (U.S. CLS. 2, 13, 23, 29, 30, 33, 40 AND 50).

ELLEN BURNS, EXAMINING ATTORNEY

CLASS 21—(Continued).

SN 78-703,081. HOFFECKER, THOMAS D., CLAWSON, MI.
FILED 8-30-2005.

DENTUWAVE

THE MARK CONSISTS OF STANDARD CHARACTERS WITHOUT CLAIM TO ANY PARTICULAR FONT, STYLE, SIZE, OR COLOR.

FOR DENTURE BRUSHES; AND DENTURE CLEANER APPLICATORS, NAMELY, APPLICATORS FOR APPLYING DENTURE CLEANER (U.S. CLS. 2, 13, 23, 29, 30, 33, 40 AND 50).

FIRST USE 8-26-2005; IN COMMERCE 8-26-2005.
SONYA STEPHENS, EXAMINING ATTORNEY

SN 78-751,004. LION CORPORATION, TOKYO, JAPAN,
FILED 11-10-2005.



FOR TOOTHBRUSHES, ELECTRIC TOOTHBRUSHES, ULTRASONIC TOOTHBRUSHES, DENTAL FLOSS, INTERDENTAL BRUSHES (U.S. CLS. 2, 13, 23, 29, 30, 33, 40 AND 50).

TRICIA SONNEBORN, EXAMINING ATTORNEY

SN 78-769,758. WILD BIRDS UNLIMITED, INC, CARMEL, IN. FILED 12-8-2005.

ADVANCED POLE SYSTEM

THE MARK CONSISTS OF STANDARD CHARACTERS WITHOUT CLAIM TO ANY PARTICULAR FONT, STYLE, SIZE, OR COLOR.

OWNER OF U.S. REG. NO. 2,401,113.

NO CLAIM IS MADE TO THE EXCLUSIVE RIGHT TO USE "POLE SYSTEM", APART FROM THE MARK AS SHOWN.

SEC. 2(F) AS TO "ADVANCED".

FOR WILDLIFE FEEDING EQUIPMENT, NAMELY, WILDLIFE FEEDERS, BIRD FEEDERS, FEED DISPENSERS, PERCHES, STANDS FOR WILDLIFE AND BIRD FEEDERS SOLD ALONE AND AS A UNIT WITH COMPONENT DECORATIVE ACCESSORIES; SQUIRREL BAFFLES; BIRD BATHS (U.S. CLS. 2, 13, 23, 29, 30, 33, 40 AND 50).

FIRST USE 7-20-1999; IN COMMERCE 7-20-1999.
ELLEN BURNS, EXAMINING ATTORNEY

CLASS 21—(Continued).

SN 78-775,520. BOND MANUFACTURING COMPANY, BAY POINT, CA. FILED 12-16-2005.



THE MARK CONSISTS OF THE LOWER-CASE LETTERS "BOND," WITH THE STEM OF THE LETTER "D" FORMING AN ARCH OVER THE LETTERS "N" AND "D" AND BISECTING THE LETTER "O".

FOR LAWN AND GARDEN SPRINKLER, NAMELY, AN INDIVIDUAL SPRINKLER USED FOR LAWNS, GARDENS AND OTHER LANDSCAPE SURFACES (U.S. CLS. 2, 13, 23, 29, 30, 33, 40 AND 50).

FIRST USE 7-1-2005; IN COMMERCE 7-1-2005.
AMY MCMENAMIN, EXAMINING ATTORNEY

SN 78-796,063. FIESTA PRODUCTS, LLC, CLARK, NJ. FILED 1-20-2006.

BASE-BOWL

THE MARK CONSISTS OF STANDARD CHARACTERS WITHOUT CLAIM TO ANY PARTICULAR FONT, STYLE, SIZE, OR COLOR.

FOR MIXING BOWLS AND LIDS THEREFOR (U.S. CLS. 2, 13, 23, 29, 30, 33, 40 AND 50).

FIRST USE 1-17-2006; IN COMMERCE 1-17-2006.
TRAVIS WHEATLEY, EXAMINING ATTORNEY

SN 78-815,639. KNESS MFG. CO., INC., ALBIA, IA. FILED 2-15-2006.

TIP-TRAP

THE MARK CONSISTS OF STANDARD CHARACTERS WITHOUT CLAIM TO ANY PARTICULAR FONT, STYLE, SIZE, OR COLOR.

OWNER OF U.S. REG. NO. 2,409,606.

SEC. 2(F).

FOR LIVE CAPTURE MOUSE TRAP (U.S. CLS. 2, 13, 23, 29, 30, 33, 40 AND 50).

FIRST USE 9-0-1999; IN COMMERCE 9-0-1999.
MICHELE SWAIN, EXAMINING ATTORNEY

CLASS 21—(Continued).

SN 78-817,280. E. I. DU PONT DE NEMOURS AND COMPANY, WILMINGTON, DE. FILED 2-17-2006.



FOR INSULATED COVERS FOR CONTAINERS, NAMELY CONTAINERS FOR DISPENSING FOOD AND BEVERAGES (U.S. CLS. 2, 13, 23, 29, 30, 33, 40 AND 50).

ZACHARY BELLO, EXAMINING ATTORNEY

SN 78-823,316. ZIBO SHUANGFENG CERAMICS CO. LTD., PARAMOUNT, CA. FILED 2-24-2006.



FOR CERAMICS AND CERAMIC PRODUCTS, NAMELY BOWLS, CUPS, MUGS, PLATES, SAUCERS, BATHROOM SOAP HOLDERS, TOOTHBRUSH HOLDERS (U.S. CLS. 2, 13, 23, 29, 30, 33, 40 AND 50).

FIRST USE 5-1-2002; IN COMMERCE 5-1-2002.

KELLEY WELLS, EXAMINING ATTORNEY

SN 78-829,949. PEK PRESERVATION SYSTEMS, INC., WINDSOR, CA. FILED 3-6-2006.

PRESERVINO

THE MARK CONSISTS OF STANDARD CHARACTERS WITHOUT CLAIM TO ANY PARTICULAR FONT, STYLE, SIZE, OR COLOR.

FOR DEVICES FOR PRESERVING WINE IN OPENED CONTAINERS, NAMELY, PORTABLE BEVERAGE DISPENSERS (U.S. CLS. 2, 13, 23, 29, 30, 33, 40 AND 50).

SARA THOMAS, EXAMINING ATTORNEY

CLASS 21—(Continued).

SN 78-857,752. GEORGE TASH AND DEBRA B. TASH AS TRUSTEES OF THE COMMUNITY TRUST CREATED UNDER THE GEORGE TASH AND DEBRA B. TASH INTERVIVOS TRUST AGREEMENT, DATED NOVEMBER 25, 1985 AS AMENDED AND TOTALLY RESTATED ON MAY 19, 1999, MOORPARK, CA. FILED 4-10-2006.

ROYAL FLUSHER

THE MARK CONSISTS OF STANDARD CHARACTERS WITHOUT CLAIM TO ANY PARTICULAR FONT, STYLE, SIZE, OR COLOR.

OWNER OF U.S. REG. NO. 1,359,264.

NO CLAIM IS MADE TO THE EXCLUSIVE RIGHT TO USE "FLUSHER", APART FROM THE MARK AS SHOWN. FOR PLUNGERS FOR CLEARING BLOCKED DRAINS (U.S. CLS. 2, 13, 23, 29, 30, 33, 40 AND 50).

FIRST USE 12-5-1984; IN COMMERCE 12-5-1984.
WENDY GOODMAN, EXAMINING ATTORNEY

SN 78-860,874. NO PROBLEM, INC., AVON LAKE, OH. FILED 4-13-2006.

BREWCOOLER

THE MARK CONSISTS OF STANDARD CHARACTERS WITHOUT CLAIM TO ANY PARTICULAR FONT, STYLE, SIZE, OR COLOR.

FOR CUP HOLDERS (U.S. CLS. 2, 13, 23, 29, 30, 33, 40 AND 50).

BRENDAN REGAN, EXAMINING ATTORNEY

SN 78-861,473. VU, EDWARD, LAS VEGAS, NV. FILED 4-13-2006.

ONLY PAN

NO CLAIM IS MADE TO THE EXCLUSIVE RIGHT TO USE "PAN", APART FROM THE MARK AS SHOWN.

THE MARK CONSISTS OF ONLY PAN.

FOR COOKWARE, NAMELY POTS AND PANS (U.S. CLS. 2, 13, 23, 29, 30, 33, 40 AND 50).

FIRST USE 3-21-2006; IN COMMERCE 3-21-2006.

JUDITH HELFMAN, EXAMINING ATTORNEY

CLASS 21—(Continued).

SN 78-862,226. CHURCH & DWIGHT CO., INC., PRINCETON, NJ. FILED 4-14-2006.

TOSS-N-GO

THE MARK CONSISTS OF STANDARD CHARACTERS WITHOUT CLAIM TO ANY PARTICULAR FONT, STYLE, SIZE, OR COLOR.

FOR LAUNDRY DETERGENT DISPENSERS (U.S. CLS. 2, 13, 23, 29, 30, 33, 40 AND 50).

TANYA AMOS, EXAMINING ATTORNEY

SN 78-862,560. RHYNE & SON, INC., RINGGOLD, GA. FILED 4-17-2006.

OWNER OF U.S. REG. NO. 3,032,301.

FOR BATH ACCESSORIES, NAMELY, CUP HOLDERS; BIRD FEEDERS; BOTTLES, SOLD EMPTY; BREAD-CASES; CANDLE HOLDERS (NOT OF PRECIOUS METAL); CERAMIC FIGURINES; CERAMIC TISSUE BOX COVERS; COMMEMORATIVE PLATES; CONTAINERS FOR HOUSEHOLD OR KITCHEN USE; DECORATIVE PLATES; DINNERWARE; DISPENSERS FOR LIQUID SOAP; HOUSEHOLD UTENSILS, NAMELY ROLLING PINS, LADLES, SPATULAS, TURNERS, WHISKS, STRAINERS; KNOBS OF CERAMIC; LUNCH BOXES; NAPKIN HOLDERS AND NAPKIN RINGS; NON-METAL PIGGY BANKS; RECIPE BOXES; SERVING DISHES; SOAP HOLDERS AND BOXES; SOUVENIR PLATES; TABLE PLACE CARD HOLDERS NOT OF PRECIOUS METAL; TRAYS; WATERING CANS; WOOD CHOPPING BLOCKS (U.S. CLS. 2, 13, 23, 29, 30, 33, 40 AND 50).

JOHN WILKE, EXAMINING ATTORNEY

SN 78-866,016. CHIX SPORTSWEAR INC., DEWINTON, CANADA, FILED 4-20-2006.

BACK BUDDIE

THE MARK CONSISTS OF STANDARD CHARACTERS WITHOUT CLAIM TO ANY PARTICULAR FONT, STYLE, SIZE, OR COLOR.

FOR LOTION APPLICATOR (U.S. CLS. 2, 13, 23, 29, 30, 33, 40 AND 50).

GINA HAYES, EXAMINING ATTORNEY

CLASS 21—(Continued).

SN 78-869,036. IMPACT ABSORBENT TECHNOLOGIES, ATASCADERO, CA. FILED 4-25-2006.

Sweep Spills Away

THE MARK CONSISTS OF STANDARD CHARACTERS WITHOUT CLAIM TO ANY PARTICULAR FONT, STYLE, SIZE, OR COLOR.

FOR GLASS GRANULES USED AS SWEEPING COMPOUNDS AND ABSORBENTS FOR CHEMICAL AND OTHER SPILLS (U.S. CLS. 2, 13, 23, 29, 30, 33, 40 AND 50).

FIRST USE 1-1-1999; IN COMMERCE 1-1-1999.

INGRID C. EULIN, EXAMINING ATTORNEY

SN 78-869,073. IMPACT ABSORBENT TECHNOLOGIES, ATASCADERO, CA. FILED 4-25-2006.

THE APPLICANT CLAIMS COLOR AS A FEATURE OF THE MARK, NAMELY, BLACK, WHITE, YELLOW.

THE MARK CONSISTS OF XSORB WITH THE "SORB" PORTION IN SMALL CAPS, ALL ABOVE A YELLOW TRIANGLE THE TIP OF WHICH POINTS TO THE RIGHT. THE XSORB IS COMPOSED OF BLACK LETTERS OUTLINED IN WHITE.

FOR GLASS GRANULES USED AS SWEEPING COMPOUNDS AND ABSORBENTS FOR CHEMICAL AND OTHER SPILLS (U.S. CLS. 2, 13, 23, 29, 30, 33, 40 AND 50).

FIRST USE 3-23-1993; IN COMMERCE 3-23-1993.

INGRID C. EULIN, EXAMINING ATTORNEY

SN 78-869,257. TOVAR, DOROTHY L., PLACERVILLE, CA. FILED 4-25-2006.

WHAT HAPPENS IN VEGAS STAYS IN VEGAS

THE MARK CONSISTS OF STANDARD CHARACTERS WITHOUT CLAIM TO ANY PARTICULAR FONT, STYLE, SIZE, OR COLOR.

OWNER OF U.S. REG. NOS. 2,930,998 AND 2,986,162.

NO CLAIM IS MADE TO THE EXCLUSIVE RIGHT TO USE "VEGAS", APART FROM THE MARK AS SHOWN.

FOR BEVERAGE GLASSWARE; BEVERAGE STIRRERS; INSULATING SLEEVE HOLDERS FOR BEVERAGE CANS; PORTABLE ICE CHESTS FOR FOOD AND BEVERAGES; SHOT GLASSES (U.S. CLS. 2, 13, 23, 29, 30, 33, 40 AND 50).

CAROLYN GRAY, EXAMINING ATTORNEY

CLASS 21—(Continued).

SN 78-869,804. TRAMONTINA USA, INC., SUGAR LAND, TX. FILED 4-26-2006.



THE FOREIGN WORDING IN THE MARK TRANSLATES INTO ENGLISH AS THE HOUSE.

FOR COOKWARE, NAMELY, POTS, SAUTÉ AND SAUCE PANS, DUTCH OVENS, SKILLETS, STEAMERS, STOCK POTS, CASSEROLES (U.S. CLS. 2, 13, 23, 29, 30, 33, 40 AND 50).

FIRST USE 3-28-2006; IN COMMERCE 3-28-2006.
MATTHEW MCDOWELL, EXAMINING ATTORNEY

CLASS 21—(Continued).

SN 78-905,427. MARKETING AND CREATIVE SALES, INC., CHESTERFIELD, MO. FILED 6-10-2006.

FUR OUT

THE MARK CONSISTS OF STANDARD CHARACTERS WITHOUT CLAIM TO ANY PARTICULAR FONT, STYLE, SIZE, OR COLOR.

FOR PET BRUSHES (U.S. CLS. 2, 13, 23, 29, 30, 33, 40 AND 50).

DAVID COLLIER, EXAMINING ATTORNEY

SN 78-870,203. SMITHKLINE BEECHAM P.L.C., BRENTFORD, MIDDLESEX, UNITED KINGDOM, FILED 4-26-2006.

GEL-X

THE MARK CONSISTS OF STANDARD CHARACTERS WITHOUT CLAIM TO ANY PARTICULAR FONT, STYLE, SIZE, OR COLOR.

FOR TOOTHBRUSHES, TOOTHPICKS, DENTAL FLOSS (U.S. CLS. 2, 13, 23, 29, 30, 33, 40 AND 50).

SHAUNIA WALLACE, EXAMINING ATTORNEY

SN 78-906,887. GROWMAX INVESTMENTS LIMITED, ROAD TOWN, TORTOLA, BR.VIRGIN ISLANDS, FILED 6-13-2006.

QUASAR

THE MARK CONSISTS OF STANDARD CHARACTERS WITHOUT CLAIM TO ANY PARTICULAR FONT, STYLE, SIZE, OR COLOR.

FOR DENTAL FLOSS; DENTAL FLOSS DISPENSERS; ELECTRIC TOOTHBRUSHES; MANUAL TOOTHBRUSHES; TOOTHBRUSH CASES; TOOTHBRUSH HOLDERS; TOOTHBRUSHES (U.S. CLS. 2, 13, 23, 29, 30, 33, 40 AND 50).

FIRST USE 12-20-2005; IN COMMERCE 12-20-2005.
BARNEY CHARLON, EXAMINING ATTORNEY

SN 78-893,360. HOODLOVE LIMITED LIABILITY COMPANY, EAST ORANGE, NJ. FILED 5-25-2006.

HOOD LOVE

THE MARK CONSISTS OF STANDARD CHARACTERS WITHOUT CLAIM TO ANY PARTICULAR FONT, STYLE, SIZE, OR COLOR.

FOR BATH ACCESSORIES, NAMELY, CUP HOLDERS; BOXES FOR DISPENSING PAPER TOWELS; CANDLE HOLDERS NOT OF PRECIOUS METAL; COFFEE CUPS; CUPS; DINNERWARE, NAMELY, PLATES, BOWLS, SAUCERS, CUPS; DISPENSERS FOR PAPER TOWELS; DRINKING CUPS; FRAGRANCE OIL BURNERS; GARBAGE CANS; MUGS; NAPKIN HOLDERS; NAPKIN HOLDERS AND NAPKIN RINGS NOT OF PRECIOUS METAL; PAPER CUPS; SALT AND PEPPER SHAKERS; SOAP DISHES; TOOTHBRUSH HOLDERS; TOOTHBRUSHES (U.S. CLS. 2, 13, 23, 29, 30, 33, 40 AND 50).

BARBARA BROWN, EXAMINING ATTORNEY

SN 78-907,679. BARENTHAL NORTH AMERICA, INC., RUTHERFORD, NJ. FILED 6-14-2006.

GOURMET BUFFET

THE MARK CONSISTS OF STANDARD CHARACTERS WITHOUT CLAIM TO ANY PARTICULAR FONT, STYLE, SIZE, OR COLOR.

FOR COOKWARE AND KITCHEN EQUIPMENT, NAMELY, POTS, PANS, HOLLOWARE, NAMELY, SALT AND PEPPER SHAKERS, SERVING TRAYS NOT MADE OF PRECIOUS METAL, AND BAKING DISHES (U.S. CLS. 2, 13, 23, 29, 30, 33, 40 AND 50).

JESSICA A. POWERS, EXAMINING ATTORNEY

CLASS 21—(Continued).

SN 78-908,200. WHITEHILL ORAL TECHNOLOGIES, INC., STAFFORD, TX. FILED 6-14-2006.

FEEL IT WORKING

THE MARK CONSISTS OF STANDARD CHARACTERS WITHOUT CLAIM TO ANY PARTICULAR FONT, STYLE, SIZE, OR COLOR.

FOR DENTAL FLOSS (U.S. CLS. 2, 13, 23, 29, 30, 33, 40 AND 50).

JOANNA DUKOVIC, EXAMINING ATTORNEY

SN 78-914,900. WHITEHILL ORAL TECHNOLOGIES, INC., STAFFORD, TX. FILED 6-22-2006.

FEEL IT CLEANING

THE MARK CONSISTS OF STANDARD CHARACTERS WITHOUT CLAIM TO ANY PARTICULAR FONT, STYLE, SIZE, OR COLOR.

FOR DENTAL FLOSS (U.S. CLS. 2, 13, 23, 29, 30, 33, 40 AND 50).

JOANNA DUKOVIC, EXAMINING ATTORNEY

SN 78-919,640. HEB GROCERY COMPANY, LP, SAN ANTONIO, TX. FILED 6-29-2006.

LONE STAR STATEMENTS

THE MARK CONSISTS OF STANDARD CHARACTERS WITHOUT CLAIM TO ANY PARTICULAR FONT, STYLE, SIZE, OR COLOR.

FOR COOKWARE, NAMELY POTS AND PANS; TEA POTS NOT OF PRECIOUS METAL; DINNERWARE; SPATULAS; STRAINERS; TONGS; WHISKS (U.S. CLS. 2, 13, 23, 29, 30, 33, 40 AND 50).

EUGENIA MARTIN, EXAMINING ATTORNEY

CLASS 21—(Continued).

SN 79-023,137. SHANXI HONGYI GLASSWARE CO., LTD, CHINA, FILED 10-13-2005.



OWNER OF INTERNATIONAL REGISTRATION 0883005 DATED 10-13-2005, EXPIRES 10-13-2015.

FOR TABLEWARE NOT OF PRECIOUS METAL, NAMELY SERVING DISHES, SERVING PLATTERS, COFFEE AND TEA SERVICES, BUTTER DISHES; LIQUEUR DRINKING GLASSES AND SERVING TRAY SOLD AS A UNIT; UTENSILS NOT OF PRECIOUS METAL FOR HOUSEHOLD PURPOSES, NAMELY GRATERS, STRAINERS, SIEVES, SPATULAS, ROLLING PINS, WHISKS; PAINTED GLASSWARE, NAMELY BOWLS, DRINKING GLASSES, VASES; GLASSWARE FOR DAILY USE, NAMELY CUPS, DISHES, KETTLES, URNS; GLASS TUBES AND RODS FOR HOUSEHOLD PURPOSES; PORCELAIN, TERRA-COTTA AND GLASS WORKS OF ART, NAMELY SCULPTURES, STATUES, FIGURINES, ORNAMENTS, BUSTS; DRINKING VESSELS; DRINKING GLASSES; UNWORKED OR SEMI-WORKED GLASS NOT FOR BUILDING (U.S. CLS. 2, 13, 23, 29, 30, 33, 40 AND 50).

LEIGH LOWRY, EXAMINING ATTORNEY

SN 79-023,567. TERENCE JEFFERY LAPIDGE, AUSTRALIA, FILED 9-28-2005.

Litter Kwitter

THE MARK CONSISTS OF STANDARD CHARACTERS WITHOUT CLAIM TO ANY PARTICULAR FONT, STYLE, SIZE, OR COLOR.

PRIORITY DATE OF 3-30-2005 IS CLAIMED.

OWNER OF INTERNATIONAL REGISTRATION 0884101 DATED 9-28-2005, EXPIRES 9-28-2015.

FOR PLASTIC CAT LITTER TRAY BEING A CAT TOILET TRAINING DEVICE (U.S. CLS. 2, 13, 23, 29, 30, 33, 40 AND 50).

NORA BUCHANAN WILL, EXAMINING ATTORNEY

CLASS 22—CORDAGE AND FIBERS

SN 76-639,378. AIG GROUP, INC., COVINA, CA. FILED 5-24-2005.



FOR TENTS, CAMPING TENTS, SIDEWALK CANOPIES AND AWNINGS MADE OF CANVAS, PORTABLE GAZEBOS MADE OF CANVAS AND PORTABLE CHANGING ROOMS MADE OF CANVAS (U.S. CLS. 1, 2, 7, 19, 22, 42 AND 50).

FIRST USE 1-1-2003; IN COMMERCE 1-1-2003.
RUDY R. SINGLETON, EXAMINING ATTORNEY

CLASS 22—(Continued).

SN 78-570,588. GREAT LAKES CANVAS DESIGN, INC., ALGONAC, MI. FILED 2-18-2005.

DOC SOC

SN 76-641,372. POLYCHEM CORPORATION, MENTOR, OH. FILED 6-22-2005.

FLEXBAND

THE MARK CONSISTS OF STANDARD CHARACTERS WITHOUT CLAIM TO ANY PARTICULAR FONT, STYLE, SIZE, OR COLOR.

FOR CANVAS BAGS FOR STORAGE OF MARINE PRODUCTS AND MARINE VEHICLE ACCESSORIES (U.S. CLS. 1, 2, 7, 19, 22, 42 AND 50).

FIRST USE 7-1-2004; IN COMMERCE 7-1-2004.
BILL DAWE, EXAMINING ATTORNEY

FOR PLASTIC STRAPPING (U.S. CLS. 1, 2, 7, 19, 22, 42 AND 50).

FIRST USE 7-26-1978; IN COMMERCE 7-26-1978.
CHARLES L. JENKINS, EXAMINING ATTORNEY

EASY GARDENER SUN SCREEN CANOPY

SN 78-430,033. EASY GARDNER PRODUCTS, INC., WACO, TX. FILED 6-4-2004.

SN 78-727,230. AZZWEPE HOLDINGS, INC., CALGARY, CANADA, FILED 10-5-2005.



THE MARK CONSISTS OF STANDARD CHARACTERS WITHOUT CLAIM TO ANY PARTICULAR FONT, STYLE, SIZE, OR COLOR.

NO CLAIM IS MADE TO THE EXCLUSIVE RIGHT TO USE "SUN SCREEN CANOPY", APART FROM THE MARK AS SHOWN.

FOR SHADE-PRODUCING PROTECTION DEVICES FOR HOUSE, LAWN AND GARDEN PLANTS, NAMELY, AWNINGS (U.S. CLS. 1, 2, 7, 19, 22, 42 AND 50).

STEPHANIE DAVIS, EXAMINING ATTORNEY

NO CLAIM IS MADE TO THE EXCLUSIVE RIGHT TO USE "SYSTEMS", APART FROM THE MARK AS SHOWN.

FOR TAILGATE LOAD SUPPORTS, NAMELY, STRAPS FOR HANDLING LOADS, USED ON A BICYCLE RACK, ALTERNATIVE VEHICLE RACK, CANOE RACK AND KAYAK RACK (U.S. CLS. 1, 2, 7, 19, 22, 42 AND 50).

FIRST USE 9-1-2005; IN COMMERCE 9-1-2005.
SAIMA MAKHDOOM, EXAMINING ATTORNEY

CLASS 22—(Continued).

SN 78-745,326. JOUBERT PRODUCTIONS SAS, 63600 AMBERT, FRANCE, FILED 11-2-2005.

JOUBERT

THE MARK CONSISTS OF STANDARD CHARACTERS WITHOUT CLAIM TO ANY PARTICULAR FONT, STYLE, SIZE, OR COLOR.

SEC. 2(F).
FOR BUNGEE CORDS, TIE-DOWN STRAPS AND ROPES (U.S. CLS. 1, 2, 7, 19, 22, 42 AND 50).
FIRST USE 0-0-1949; IN COMMERCE 0-0-1962.
PAUL E. FAHRENKOPF, EXAMINING ATTORNEY

CLASS 22—(Continued).

SN 78-829,238. SHINIH ENTERPRISE CO., LTD., PANCHIAO CITY, TAIWAN, FILED 3-4-2006.

CloMax

THE MARK CONSISTS OF STANDARD CHARACTERS WITHOUT CLAIM TO ANY PARTICULAR FONT, STYLE, SIZE, OR COLOR.

FOR NON-WOVEN POLYMERIC FIBERS FOR CONVERSION INTO A VARIETY OF INDUSTRIAL AND CONSUMER GOODS (U.S. CLS. 1, 2, 7, 19, 22, 42 AND 50).
DANIEL RUSSELL, EXAMINING ATTORNEY

SN 78-770,527. HKD INTERNATIONAL (HK) LIMITED, NORTH POINT, HONG KONG, FILED 12-9-2005.



THE MARK CONSISTS, IN PART, OF A DESIGN OF AN ELECTRICAL CORD AND PLUG.

FOR TENTS, NAMELY TENTS FEATURING A WEATHER RESISTANT ACCESS PORT (U.S. CLS. 1, 2, 7, 19, 22, 42 AND 50).
VERNA BETH RIRIE, EXAMINING ATTORNEY

SN 78-829,245. SHINIH ENTERPRISE CO., LTD., PANCHIAO CITY, TAIWAN, FILED 3-4-2006.

CloSole

THE MARK CONSISTS OF STANDARD CHARACTERS WITHOUT CLAIM TO ANY PARTICULAR FONT, STYLE, SIZE, OR COLOR.

FOR NON-WOVEN POLYMERIC FIBERS FOR CONVERSION INTO A VARIETY OF INDUSTRIAL AND CONSUMER GOODS (U.S. CLS. 1, 2, 7, 19, 22, 42 AND 50).
DANIEL RUSSELL, EXAMINING ATTORNEY

SN 78-770,536. HKD INTERNATIONAL (HK) LIMITED, NORTH POINT, HONG KONG, FILED 12-9-2005.

POWER POCKET

THE MARK CONSISTS OF STANDARD CHARACTERS WITHOUT CLAIM TO ANY PARTICULAR FONT, STYLE, SIZE, OR COLOR.

FOR TENTS, NAMELY TENTS FEATURING A WEATHER RESISTANT ACCESS PORT (U.S. CLS. 1, 2, 7, 19, 22, 42 AND 50).
VERNA BETH RIRIE, EXAMINING ATTORNEY

SN 78-829,246. SHINIH ENTERPRISE CO., LTD., PANCHIAO CITY, TAIWAN, FILED 3-4-2006.

CloTech

THE MARK CONSISTS OF STANDARD CHARACTERS WITHOUT CLAIM TO ANY PARTICULAR FONT, STYLE, SIZE, OR COLOR.

FOR NON-WOVEN POLYMERIC FIBERS FOR CONVERSION INTO A VARIETY OF INDUSTRIAL AND CONSUMER GOODS (U.S. CLS. 1, 2, 7, 19, 22, 42 AND 50).
DANIEL RUSSELL, EXAMINING ATTORNEY

CLASS 22—(Continued).

SN 78-861,074. INVISTA NORTH AMERICA S.A.R.L., WILMINGTON, DE. FILED 4-13-2006.



OWNER OF U.S. REG. NOS. 2,485,680, 2,986,365 AND OTHERS.

THE MARK CONSISTS OF AN ELONGATED HORIZONTAL WAVY LINE SEPARATING THE LITERAL ELEMENTS OF THE MARK.

FOR SYNTHETIC FIBERS AND FILAMENTS FOR USE IN THE MANUFACTURE OF FABRICS, TEXTILES, YARNS, AND CARPETS (U.S. CLS. 1, 2, 7, 19, 22, 42 AND 50).

HEATHER THOMPSON, EXAMINING ATTORNEY

SN 78-861,125. INVISTA NORTH AMERICA S.A.R.L., WILMINGTON, DE. FILED 4-13-2006.

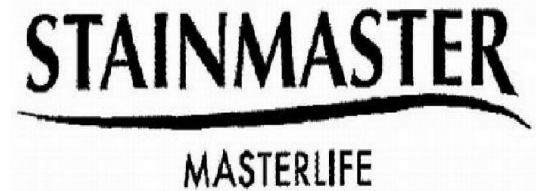

OWNER OF U.S. REG. NOS. 1,971,591, 2,986,365 AND OTHERS.

THE MARK CONSISTS OF AN ELONGATED HORIZONTAL WAVY LINE SEPARATING THE LITERAL ELEMENTS OF THE MARK.

FOR SYNTHETIC FIBERS AND FILAMENTS FOR USE IN THE MANUFACTURE OF FABRICS, TEXTILES, YARNS, AND CARPETS (U.S. CLS. 1, 2, 7, 19, 22, 42 AND 50).

HEATHER THOMPSON, EXAMINING ATTORNEY

SN 78-861,168. INVISTA NORTH AMERICA S.A.R.L., WILMINGTON, DE. FILED 4-13-2006.



OWNER OF U.S. REG. NOS. 2,293,097, 2,986,365 AND OTHERS.

THE MARK CONSISTS OF AN ELONGATED HORIZONTAL WAVY LINE SEPARATING THE LITERAL ELEMENTS OF THE MARK.

FOR SYNTHETIC FIBERS AND FILAMENTS FOR USE IN THE MANUFACTURE OF FABRICS, TEXTILES, YARNS, AND CARPETS (U.S. CLS. 1, 2, 7, 19, 22, 42 AND 50).

HEATHER THOMPSON, EXAMINING ATTORNEY

CLASS 22—(Continued).

SN 78-864,363. MIDRIX, INC., DELMONT, PA. FILED 4-19-2006.

Safe-Clik-N-Grip

THE MARK CONSISTS OF STANDARD CHARACTERS WITHOUT CLAIM TO ANY PARTICULAR FONT, STYLE, SIZE, OR COLOR.

FOR STRAP WITH A BUCKLE AND A HANDLE USED TO SAFELY SUPPORT, LIFT AND TRANSPORT THE CONTENTS SECURED BY THE STRAP, NAMELY, LAPTOP COMPUTERS, BOOKS AND THE LIKE (U.S. CLS. 1, 2, 7, 19, 22, 42 AND 50).

FIRST USE 7-7-2006; IN COMMERCE 7-7-2006.
SUSAN RICHARDS, EXAMINING ATTORNEY

SN 78-871,295. WRIGHTENBERRY HOSIERY MILLS, INC., BURLINGTON, NC. FILED 4-27-2006.

DRI-WRIGHT

THE MARK CONSISTS OF STANDARD CHARACTERS WITHOUT CLAIM TO ANY PARTICULAR FONT, STYLE, SIZE, OR COLOR.

FOR FIBERS FOR TEXTILE USE (U.S. CLS. 1, 2, 7, 19, 22, 42 AND 50).

FIRST USE 3-1-2005; IN COMMERCE 3-1-2005.
JUSTINE D. PARKER, EXAMINING ATTORNEY

CLASS 23—YARNS AND THREADS

SN 78-530,119. FOX, SALLY V., BROOKS, CA. FILED 12-9-2004.

Colorganic

THE MARK CONSISTS OF STANDARD CHARACTERS WITHOUT CLAIM TO ANY PARTICULAR FONT, STYLE, SIZE, OR COLOR.

FOR YARN (U.S. CL. 43).
FIRST USE 1-24-1994; IN COMMERCE 1-24-1994.
TEJBIR SINGH, EXAMINING ATTORNEY

SN 78-634,519. COMTRADE INTERNATIONAL, INC., OAKLAND, NJ. FILED 5-22-2005.

Ramtex

THE MARK CONSISTS OF STANDARD CHARACTERS WITHOUT CLAIM TO ANY PARTICULAR FONT, STYLE, SIZE, OR COLOR.

FOR YARN AND THREAD (U.S. CL. 43).
FIRST USE 4-7-1999; IN COMMERCE 4-7-1999.
DORITT L. CARROLL, EXAMINING ATTORNEY

SN 78-711,794. CASCADE YARNS, INC., TUKWILA, WA. FILED 9-13-2005.

CASCADE 220

THE MARK CONSISTS OF STANDARD CHARACTERS WITHOUT CLAIM TO ANY PARTICULAR FONT, STYLE, SIZE, OR COLOR.

SEC. 2(F) AS TO "220".
FOR YARN; WOOL YARN (U.S. CL. 43).
FIRST USE 1-1-1988; IN COMMERCE 1-1-1988.
KATHLEEN M. VANSTON, EXAMINING ATTORNEY

CLASS 23—(Continued).

SN 78-877,776. INVISTA NORTH AMERICA S.A.R.L., WILMINGTON, DE. FILED 5-5-2006.



supriva

OWNER OF U.S. REG. NO. 2,438,778.
THE MARK CONSISTS OF THE LITERAL ELEMENT CONTAINING A FANCIFUL LETTER I.
FOR SYNTHETIC FIBER THREAD AND YARN (U.S. CL. 43).

FIRST USE 9-1-2003; IN COMMERCE 9-1-2003.
HEATHER THOMPSON, EXAMINING ATTORNEY

SN 78-879,338. INVISTA NORTH AMERICA S.A.R.L., WILMINGTON, DE. FILED 5-9-2006.

SUPRIVA

THE MARK CONSISTS OF STANDARD CHARACTERS WITHOUT CLAIM TO ANY PARTICULAR FONT, STYLE, SIZE, OR COLOR.

OWNER OF U.S. REG. NO. 2,438,778.
FOR SYNTHETIC FIBER THREAD AND YARN (U.S. CL. 43).

FIRST USE 9-1-2003; IN COMMERCE 9-1-2003.
HEATHER THOMPSON, EXAMINING ATTORNEY

CLASS 24—FABRICS

SN 76-657,598. ERES, PARIS, FRANCE, FILED 3-31-2006.

ERES

OWNER OF U.S. REG. NOS. 2,320,998 AND 2,497,205.
"THE FOREIGN WORDING IN THE MARK TRANSLATES INTO ENGLISH AS YOU ARE."
FOR TOWELS (U.S. CLS. 42 AND 50).
CIMMERIAN COLEMAN, EXAMINING ATTORNEY

CLASS 24—(Continued).

SN 78-566,448. IP HOLDINGS LLC, WILMINGTON, DE. FILED 2-14-2005.

**UNDERWEAR FOR YOUR
BED**

THE MARK CONSISTS OF STANDARD CHARACTERS WITHOUT CLAIM TO ANY PARTICULAR FONT, STYLE, SIZE, OR COLOR.

FOR BED SHEETS AND PILLOW CASES (U.S. CLS. 42 AND 50).

FIRST USE 7-15-2002; IN COMMERCE 7-15-2002.
ANGELA M. MICHEL, EXAMINING ATTORNEY

CLASS 24—(Continued).

SN 78-837,846. MAURO HOLDINGS LLC, HILLIARD, OH. FILED 3-15-2006.

Dreamy Bambini

THE MARK CONSISTS OF STANDARD CHARACTERS WITHOUT CLAIM TO ANY PARTICULAR FONT, STYLE, SIZE, OR COLOR.

NO CLAIM IS MADE TO THE EXCLUSIVE RIGHT TO USE "BAMBINI", APART FROM THE MARK AS SHOWN. THE ENGLISH TRANSLATION OF THE ITALIAN WORD BAMBINI IN THE MARK IS CHILDREN.

FOR BED LINEN (U.S. CLS. 42 AND 50).
MICHAEL KAZAZIAN, EXAMINING ATTORNEY

SN 78-569,039. RADTECH, LLC, EARTH CITY, MO. FILED 2-16-2005.

OPTEX

THE MARK CONSISTS OF STANDARD CHARACTERS WITHOUT CLAIM TO ANY PARTICULAR FONT, STYLE, SIZE, OR COLOR.

FOR SYNTHETIC FIBER FABRIC, NAMELY, A NON-WOVEN SUPER-MICROFIBER FABRIC USED FOR THE MANUFACTURE OF CLEANING, CARE AND PROTECTION FABRIC FOR NOTEBOOK AND PERSONAL COMPUTERS, LCD, PERSONAL DIGITAL ASSISTANTS, CELL PHONES, DIGITAL AUDIO AND VIDEO DEVICES, PLAYERS AND DISCS, PLASMA AND CRT FLAT-PANEL DISPLAY SCREENS, EYEGLASS LENSES, OPTICAL LENSES, AND CINEMATOGRAPHIC LENSES (U.S. CLS. 42 AND 50).

FIRST USE 6-28-2002; IN COMMERCE 6-28-2002.
MICHELE SWAIN, EXAMINING ATTORNEY

SN 78-850,624. CAESAREA CREATION INDUSTRIES LTD., OR-AKIVA, ISRAEL, FILED 3-30-2006.



NO CLAIM IS MADE TO THE EXCLUSIVE RIGHT TO USE CAESAREA CREATIONS, APART FROM THE MARK AS SHOWN.

THE COLOR(S) GOLD AND BROWN IS/ARE CLAIMED AS A FEATURE OF THE MARK.

THE MARK CONSISTS OF A LONG AND NARROW GOLD BOX WITH A GOLD AND BROWN CROWN ON ITS TOP AND ACROSS THE CENTER OF A TALLER BROWN BOX.

FOR HOUSEHOLD LINEN, DINING LINENS, KITCHEN LINENS, TABLE LINEN, NAMELY, COASTERS, NAPKINS, PLACE MATS AND TABLE CLOTHS, FABRIC WINDOW COVERINGS AND TREATMENTS, NAMELY, CURTAINS, DRAPERIES, SHEERS, SWAGS AND VALANCES, SHOWER CURTAINS, BATH LINEN, TOWELS, NAMELY, BATH TOWELS, BEACH TOWELS, FACE TOWELS, HAND TOWELS, HOODED TOWELS, KITCHEN TOWELS AND TEA TOWELS, BED LINEN, PILLOW CASES, PILLOW COVERS, PILLOW SHAMS, COMFORTERS, BED BLANKETS, THROWS, BLANKET THROWS (U.S. CLS. 42 AND 50).

KATHERINE STOIDES, EXAMINING ATTORNEY

SN 78-714,564. BRAY, KRISTI L., SAN CLEMENTE, CA. AND GUTIERREZ, HEATHER R., SAN CLEMENTE, CA. FILED 9-16-2005.

MΘΘMΘΘ

FOR NURSING BLANKETS AND BED BLANKETS (U.S. CLS. 42 AND 50).

DEBRA LEE, EXAMINING ATTORNEY

SN 78-854,343. DOWN ETC. LLC, SAN FRANCISCO, CA. FILED 4-5-2006.

down etc. ▲ ■ ●

NO CLAIM IS MADE TO THE EXCLUSIVE RIGHT TO USE "DOWN", APART FROM THE MARK AS SHOWN.

THE MARK CONSISTS OF THE WORDS "DOWN ETC" FOLLOWED BY A TRIANGLE, SQUARE AND CIRCLE. FOR DOWN COMFORTERS; DOWN MATTRESS PADS (U.S. CLS. 42 AND 50).

FIRST USE 8-1-2001; IN COMMERCE 8-1-2001.
ALAIN LAPTER, EXAMINING ATTORNEY

CLASS 24—(Continued).

SN 78-857,920. INVISTA NORTH AMERICA S.A.R.L., WILMINGTON, DE. FILED 4-10-2006.



OWNER OF U.S. REG. NOS. 673,601, 2,327,119 AND OTHERS.

THE COLOR(S) BLUE, BLACK AND WHITE IS/ARE CLAIMED AS A FEATURE OF THE MARK.

THE MARK CONSISTS OF THE LITERAL ELEMENT, LYCRA IN WHITE LETTERING, CONTAINED WITHIN A BLUE, BLACK AND WHITE SHADED TRIANGULAR SHAPE, THE BOTTOM LINE OF WHICH IS CURVED TO REPRESENT A WAVE DESIGN, AND THE XFIT LITERAL ELEMENT WITH THE X IN BLUE AND FIT IN BLACK, DIRECTLY TO THE LEFT AND OUTSIDE OF THE TRIANGULAR SHAPE.

FOR FABRIC FOR THE MANUFACTURE OF CLOTHING (U.S. CLS. 42 AND 50).

HEATHER THOMPSON, EXAMINING ATTORNEY



SN 78-858,028. THE TURKISH TOWEL COMPANY, INC., PEABODY, MA. FILED 4-10-2006.

ROYAL TOWEL MILLS

THE MARK CONSISTS OF STANDARD CHARACTERS WITHOUT CLAIM TO ANY PARTICULAR FONT, STYLE, SIZE, OR COLOR.

OWNER OF U.S. REG. NO. 2,981,514.
NO CLAIM IS MADE TO THE EXCLUSIVE RIGHT TO USE "TOWEL", APART FROM THE MARK AS SHOWN.
FOR TOWELS (U.S. CLS. 42 AND 50).

LINDA E. BLOHM, EXAMINING ATTORNEY



SN 78-858,062. THE TURKISH TOWEL COMPANY, INC., PEABODY, MA. FILED 4-10-2006.

KITCHEN CHIC

THE MARK CONSISTS OF STANDARD CHARACTERS WITHOUT CLAIM TO ANY PARTICULAR FONT, STYLE, SIZE, OR COLOR.

NO CLAIM IS MADE TO THE EXCLUSIVE RIGHT TO USE KITCHEN, APART FROM THE MARK AS SHOWN.
FOR TOWELS (U.S. CLS. 42 AND 50).

LINDA E. BLOHM, EXAMINING ATTORNEY

CLASS 24—(Continued).

SN 78-859,233. PANTONE, INC., CARLSTADT, NJ. FILED 4-11-2006.

PANTONE UNIVERSE

THE MARK CONSISTS OF STANDARD CHARACTERS WITHOUT CLAIM TO ANY PARTICULAR FONT, STYLE, SIZE, OR COLOR.

OWNER OF U.S. REG. NOS. 1,674,917, 1,884,707 AND OTHERS.

FOR BED BLANKETS; BED SHEETS; BED SPREADS; COVERS FOR CUSHIONS; DUVETS; DUVET COVERS; MATTRESS COVERS; PILLOW CASES; PILLOW SHAMS; TOWELS; PLACE MATS NOT OF PAPER; TABLE MATS NOT OF PAPER; TABLE CLOTHS NOT OF PAPER; TEXTILE NAPKINS (U.S. CLS. 42 AND 50).

TINA BROWN, EXAMINING ATTORNEY



SN 78-862,705. RHYNE & SON, INC., RINGGOLD, GA. FILED 4-17-2006.



OWNER OF U.S. REG. NO. 3,032,301.
FOR HOUSEHOLD LINEN (U.S. CLS. 42 AND 50).

JOHN WILKE, EXAMINING ATTORNEY

CLASS 24—(Continued).

SN 78-867,445. SMITH, SHUNA, MERRICK, NY. FILED 4-22-2006.

Babykins

THE MARK CONSISTS OF STANDARD CHARACTERS WITHOUT CLAIM TO ANY PARTICULAR FONT, STYLE, SIZE, OR COLOR.

FOR BATH SHEETS; BATH TOWELS; BEACH TOWELS; BED BLANKETS; BED CANOPIES; BED LINEN; BED PADS; BED SHEETS; BED SHEETS OF PAPER; BED SKIRTS; BED SPREADS; BEDSHEETS; BLANKET THROWS; BOLTING CLOTH; CHILDREN'S BLANKETS; CHILDREN'S TOWELS; CLOTH NAPKINS FOR REMOVING MAKE-UP; CONTOUR SHEETS; CONTOURED MATTRESS COVERS; COTTON BASE MIXED FABRICS; COTTON FABRIC; DRAPERY; FACE TOWELS; FEATHER BEDS; HAND TOWELS; HAND TOWELS OF TEXTILE; HAND-TOWELS MADE OF TEXTILE FABRICS; HANDKERCHIEFS; HOODED TOWELS; LARGE BATH TOWELS; LINEN; MATTRESS COVERS; PILLOW CASES; PILLOW COVERS; PILLOW SHAMS; PILLOWCASES; SILK BED BLANKETS; SILK BLANKETS; SILK CLOTH; SILK FABRIC FOR PRINTING PATTERNS; SILK-COTTON MIXED FABRICS; SILK-WOOL MIXED FABRICS; TEXTILE LABELS; TEXTILE NAPKINS; TOWELS; TOWELS; WOOLEN FABRIC; WOOLLEN BLANKETS (U.S. CLS. 42 AND 50).

FIRST USE 1-10-2006; IN COMMERCE 1-10-2006.
PATRICIA EVANKO, EXAMINING ATTORNEY

SN 78-868,370. INTERLINK PRODUCTS INTERNATIONAL, LINDEN, NJ. FILED 4-24-2006.

WOOLPURE

THE MARK CONSISTS OF STANDARD CHARACTERS WITHOUT CLAIM TO ANY PARTICULAR FONT, STYLE, SIZE, OR COLOR.

FOR COMFORTERS; DUVET COVERS; DUVETS; MATTRESS COVERS; MATTRESS PADS; QUILTS; WOOL BASE MIXED FABRICS; WOOL YARN FABRICS; WOOL-COTTON MIXED FABRICS; WOOLLEN BLANKETS (U.S. CLS. 42 AND 50).

FIRST USE 4-3-2006; IN COMMERCE 4-3-2006.
WENDY GOODMAN, EXAMINING ATTORNEY

CLASS 24—(Continued).

SN 78-869,267. TOVAR, DOROTHY L., PLACERVILLE, CA. FILED 4-25-2006.

WHAT HAPPENS IN VEGAS STAYS IN VEGAS

THE MARK CONSISTS OF STANDARD CHARACTERS WITHOUT CLAIM TO ANY PARTICULAR FONT, STYLE, SIZE, OR COLOR.

OWNER OF U.S. REG. NOS. 2,930,998 AND 2,986,162.

NO CLAIM IS MADE TO THE EXCLUSIVE RIGHT TO USE "VEGAS", APART FROM THE MARK AS SHOWN.
FOR BATH TOWELS; BEACH TOWELS; GOLF TOWELS (U.S. CLS. 42 AND 50).

CAROLYN GRAY, EXAMINING ATTORNEY

SN 78-872,565. BALLESTEROS, EVA, CHULA VISTA, CA. FILED 4-28-2006.

THE NURSING CURTAIN

THE MARK CONSISTS OF STANDARD CHARACTERS WITHOUT CLAIM TO ANY PARTICULAR FONT, STYLE, SIZE, OR COLOR.

NO CLAIM IS MADE TO THE EXCLUSIVE RIGHT TO USE "NURSING", APART FROM THE MARK AS SHOWN.
FOR CHILDREN'S BLANKETS (U.S. CLS. 42 AND 50).

FIRST USE 1-0-2005; IN COMMERCE 9-24-2005.
TINA L. SNAPP, EXAMINING ATTORNEY

SN 78-919,651. HEB GROCERY COMPANY, LP, SAN ANTONIO, TX. FILED 6-29-2006.

LONE STAR STATEMENTS

THE MARK CONSISTS OF STANDARD CHARACTERS WITHOUT CLAIM TO ANY PARTICULAR FONT, STYLE, SIZE, OR COLOR.

FOR OVEN MITTS; HOT PADS (U.S. CLS. 42 AND 50).
EUGENIA MARTIN, EXAMINING ATTORNEY

CLASS 24—(Continued).

SN 79-006,751. SEIREN CO., LTD., JAPAN, FILED 4-19-2004.



OWNER OF INTERNATIONAL REGISTRATION 0837252 DATED 4-19-2004, EXPIRES 4-19-2014.

NO CLAIM IS MADE TO THE EXCLUSIVE RIGHT TO USE "CONDUCTIVE FABRICS", APART FROM THE MARK AS SHOWN.

THE COLORS BLUE AND RED ARE CLAIMED AS A FEATURE OF THE MARK.

THE MARK CONSISTS OF THE TERM SEIREN IN BLUE STYLIZED LETTERS, UNDERLINED, AND BELOW SEIREN THE WORDING CONDUCTIVE FABRICS, ALSO IN BLUE STYLIZED LETTERS. TO THE LEFT OF THIS WORDING IS A DESIGN CONSISTING OF AN IRREGULAR SQUARE COMPOSED OF MANY SMALLER SQUARES, ALL OF THE FOREGOING IN BLUE, WITH ONE SMALL RED SQUARE AT THE LOWER LEFT OF THE LARGER BLUE SQUARE DESIGN.

FOR FABRICS OF ALL TYPES FOR USE IN TRANSMITTING, CONDUCTING, AND/OR SHIELDING ELECTROMAGNETIC WAVES FOR USE IN ELECTRICAL AND ELECTRONIC DEVICES OF ALL TYPES, INCLUDING DIGITAL PRODUCTS, COMPUTERS, CELLULAR PHONES, SHIELDING WINDOWS, PLASMA DISPLAY PANELS, GASKETS FOR COMPUTERS, SHIELDING WALL COVERING MATERIALS, SIMPLIFIED SHIELDING BOXES AND TENTS, SHIELDING TAPES FOR CELLULAR PHONES, CABLE COVERS FOR SEMICONDUCTOR PRODUCING MACHINES, DRAPES, UPHOLSTERY FOR FURNITURE AND MOTOR VEHICLES, SENSORS FOR DETECTING THE PRESENCE OF PASSENGERS AND/OR THE USE OF PASSENGER VEHICULAR SEAT BELTS, ANTISTATIC BRUSHES FOR PERSONAL COMPUTERS, COPYING MACHINES, AND WEARING APPAREL (U.S. CLS. 42 AND 50).

NANCY CLARKE, EXAMINING ATTORNEY

CLASS 25—CLOTHING

SN 76-319,233. KANDY KISS OF CALIFORNIA, INC., PACOIMA, CA. FILED 9-28-2001.

Y.B. NORMAL?

FOR CLOTHING, NAMELY DRESSES, TOPS, SKIRTS, PANTS, AND SHORTS (U.S. CLS. 22 AND 39).

FIRST USE 0-0-1991; IN COMMERCE 0-0-1991.

JACQUELINE A. LAVINE, EXAMINING ATTORNEY

CLASS 25—(Continued).

SN 76-559,271. HOLLYWOOD, FRANK, DUARTE, CA. FILED 11-12-2003.

THE PRINCE OF HAWAII

THE MARK CONSISTS OF STANDARD CHARACTERS WITHOUT CLAIM TO ANY PARTICULAR FONT, STYLE, SIZE, OR COLOR.

FOR CLOTHING, NAMELY, ATHLETIC SHOES, DRESS SHOES, HIGH HEEL SHOES, BEACHWEAR, PANTS, TOPS, SOCKS, JACKETS, BELTS, CRAVATS, BIKINIS, BRASSIERES, COATS, BLAZERS, TIES, STOCKINGS, TROUSERS, LEATHER COATS, SUIT COATS, UNDERWEAR, SHIRTS, T-SHIRTS, JEANS, SHORTS, NIGHTWEAR, NAMELY, SLEEP SHIRTS, NIGHT GOWNS AND NIGHT SHIRTS, HEADGEAR, NAMELY, CAPS AND HATS (U.S. CLS. 22 AND 39).

DAVID MURRAY, EXAMINING ATTORNEY

SN 76-568,024. GARAN SERVICES CORP., WILMINGTON, DE. FILED 12-31-2003.



FOR CLOTHING, NAMELY, TOPS AND BOTTOMS (U.S. CLS. 22 AND 39).

GENE MACIOL, EXAMINING ATTORNEY

SN 76-571,376. MARK LEMP FOOTWEAR, ST. LOUIS, MO. FILED 1-22-2004.

ROSE PETALS

THE MARK CONSISTS OF STANDARD CHARACTERS WITHOUT CLAIM TO ANY PARTICULAR FONT, STYLE, SIZE, OR COLOR.

FOR FOOTWEAR (U.S. CLS. 22 AND 39).

JEFF DEFORD, EXAMINING ATTORNEY

CLASS 25—(Continued).

SN 76-620,250. ANDARI FASHION, INC., EL MONTE, CA.
FILED 11-12-2004.

Sī'ən

A STYLIZED MARK COMPRISES A CAPITALIZED "S", A SPECIAL FONT "I", AN INVERTED "E" AND AN "N", WHEREIN AN APOSTROPHE IS PLACED BETWEEN THE LETTERS "I" AND THE INVERTED "E".

FOR CLOTHINGS, NAMELY, SWEATERS (U.S. CLS. 22 AND 39).

FIRST USE 10-4-2004; IN COMMERCE 10-4-2004.
LA TONIA FISHER, EXAMINING ATTORNEY

SN 76-625,772. TIMBERWOLF VENTURES, INC., JUNEAU, AK. FILED 12-21-2004.

See the Sights. Buy the Shirts.

FOR CLOTHING, NAMELY, SHIRTS, T-SHIRTS, JACKETS AND CAPS (U.S. CLS. 22 AND 39).
FIRST USE 7-1-2002; IN COMMERCE 7-1-2002.
GENE MACIOL, EXAMINING ATTORNEY

SN 76-628,588. LAKAI, LTD., TORRANCE, CA. FILED 1-18-2005.

INSPIRED BY SKATEBOARDING

THE MARK CONSISTS OF STANDARD CHARACTERS WITHOUT CLAIM TO ANY PARTICULAR FONT, STYLE, SIZE, OR COLOR.

FOR T-SHIRTS AND SWEATSHIRTS (U.S. CLS. 22 AND 39).

TASNEEM HUSSAIN, EXAMINING ATTORNEY

CLASS 25—(Continued).

SN 76-634,524. BONAFIDE ENTERPRISES, LAHAINA, HI.
FILED 3-28-2005.



HUMBLE SOULJAH

THE MARK IS A COMBINATION OF TWO CAPITOL LETTERS "H" AND "S". THE "H" IS FROM THE WORD HUMBLE AND THE "S" FROM THE WORD SOULJAH. THESE TWO LETTERS COMBINED CREATE A MARK OF A DIAMOND WITH A TWO LEGGED CROSS THAT EXTENDS OUT OF THE BOTTOM OF THE DIAMOND.

FOR CLOTHING, NAMELY, T-SHIRTS; HEADWEAR, NAMELY, SKULL CAPS, VISORS, AND HATS; FOOTWEAR FLIP FLOPS AND SANDALS (U.S. CLS. 22 AND 39).

ALICE BENMAMAN, EXAMINING ATTORNEY

SN 76-637,306. KEAN, JAMES, MADISON, NJ. AND KEAN, MARTIN, MADISON, NJ. FILED 4-28-2005.

FAV

THE MARK CONSISTS OF STANDARD CHARACTERS WITHOUT CLAIM TO ANY PARTICULAR FONT, STYLE, SIZE, OR COLOR.

FOR CLOTHING, NAMELY T-SHIRTS (U.S. CLS. 22 AND 39).

MICHELE SWAIN, EXAMINING ATTORNEY

SN 76-644,402. PRICELESS ENTERPRISES, INC., NEW SMYRNA BEACH, FL. FILED 8-8-2005.

VIRGIL ISLAND WEAR

NO CLAIM IS MADE TO THE EXCLUSIVE RIGHT TO USE "ISLAND WEAR", APART FROM THE MARK AS SHOWN.

THE NAME(S), PORTRAIT(S), AND/OR SIGNATURE(S) SHOWN IN THE MARK DOES NOT IDENTIFY A PARTICULAR LIVING INDIVIDUAL.

FOR CLOTHING, NAMELY TEE SHIRTS, GOLF SHIRTS, JACKETS, HATS, SHORTS, SWEAT SHIRTS, PANTS, APRONS, CLOTH BIBS, GLOVES, AND UNDERCLOTHES (U.S. CLS. 22 AND 39).

FIRST USE 7-28-2005; IN COMMERCE 7-28-2005.

LOURDES AYALA, EXAMINING ATTORNEY

CLASS 25—(Continued).

SN 76-647,997. SALLY'S SWEET REVENGE, INC., GLENDALE, CA. FILED 10-5-2005.



THE MARK CONSISTS OF A DRAWING OF THE HEAD OF A FEMALE CHARACTER.

FOR CLOTHING, NAMELY, T-SHIRTS, UNDERWEAR, SWEATPANTS AND SWEATSHIRTS; HEADWEAR, NAMELY CAPS (BASED ON USE IN COMMERCE) CLOTHING, NAMELY JACKETS, COATS, PANTS, SHIRTS, SKIRTS, DRESSES, LINGERIE, SWEATERS, SHORTS, BLOUSES, PAJAMAS, ROBES; HEADWEAR, NAMELY HATS (BASED ON INTENT TO USE) (U.S. CLS. 22 AND 39).

FIRST USE 7-9-2003; IN COMMERCE 7-9-2003.
KATHLEEN M. VANSTON, EXAMINING ATTORNEY

SN 76-648,537. BOOT ROYALTY COMPANY, L.P., FORT WORTH, TX. FILED 10-13-2005.



OWNER OF U.S. REG. NOS. 525,522, 1,382,828 AND OTHERS.

THE NAME(S), PORTRAIT(S), AND/OR SIGNATURE(S) SHOWN IN THE MARK IDENTIFIES TONY LAMA JR., WHOSE CONSENT(S) TO REGISTER IS SUBMITTED.

FOR HATS (U.S. CLS. 22 AND 39).
FIRST USE 4-0-2005; IN COMMERCE 4-0-2005.
LINDA LAVACHE, EXAMINING ATTORNEY

SN 76-651,815. CASH LLC, BEAUFORT, SC. FILED 12-13-2005.



FOR T-SHIRTS, CLOTH BIBS, HATS AND PANTS (U.S. CLS. 22 AND 39).

NAAKWAMA ANKRAH, EXAMINING ATTORNEY

CLASS 25—(Continued).

SN 76-657,330. MAGS ENTERTAINMENT, LLC, GREENWOOD, SC. FILED 3-24-2006.

**BEARSHEBA J. BEAR
BJ'S TEDDY BEAR CLUB
AND BIBLE STORIES**

THE MARK CONSISTS OF STANDARD CHARACTERS WITHOUT CLAIM TO ANY PARTICULAR FONT, STYLE, SIZE, OR COLOR.

THE NAME BEARSHEBA J. BEAR DOES NOT IDENTIFY A LIVING INDIVIDUAL.

FOR CLOTHING, NAMELY, SHIRTS, T-SHIRTS, SWEATSHIRTS, TANK TOPS, BLOUSES, SWEATERS, PULLOVERS, PANTS, SWEATPANTS, JEANS, SLACKS, SHORTS, DRESSES, SKIRTS, SLEEPWEAR, PAJAMAS, ROBES, JACKETS, COATS, SHOES, BOOTS, SANDALS, SLIPPERS, BOOTIES, SOCKS, TIGHTS, UNDERWEAR, HATS, CAPS, VISORS, EAR MUFFS, GLOVES, MITTENS, RAINWEAR, SCARVES, SWEAT BANDS, CLOTH BIBS, CLOTH DIAPERS, INFANTWEAR, JUMPERS, PLAY SUITS, UNIFORMS, COVERALLS, SWIMWEAR, MASQUERADE AND HALLOWEEN COSTUMES AND MASKS SOLD IN CONNECTION THEREWITH (U.S. CLS. 22 AND 39).

KATHERINE E. HALMEN, EXAMINING ATTORNEY

SN 76-657,990. MADRID, JERRY, HUNTINGTON BEACH, CA. FILED 4-7-2006.



FOR SHOES FOR USE WITH SKATEBOARDS (U.S. CLS. 22 AND 39).

FIRST USE 12-7-1987; IN COMMERCE 12-7-1987.
TINA BROWN, EXAMINING ATTORNEY

CLASS 25—(Continued).

SN 76-658,225. EDWARDS, WISHART, BROOKLYN, NY.
FILED 4-11-2006.

**BOOT CAMP FITNESS**

THE PORTRAIT SHOWN IN THE MARK IDENTIFIES DARREN TAYLOR, WHOSE CONSENT TO REGISTER IS MADE OF RECORD.

THE MARK CONSISTS OF THE WORDS "BOOT CAMP FITNESS" IN STYLIZED TYPE AND THE DESIGN OF THE UPPER TORSO OF A MUSTACHED MILITARY MAN WEARING SUNGLASSES AND A MILITARY STYLE HAT WITH A STAR EMBLAZONED IN THE CENTER OF THE HAT. THE FIGURE IS SET WITHIN A SOLID BORDER; AND IS SET ABOVE A BANNER WITH A STAR EMBLAZONED IN THE CENTER OF THE BANNER.

FOR CLOTHING, NAMELY, T-SHIRTS, TANK TOPS, SHORTS, AND CAPS (U.S. CLS. 22 AND 39).

FIRST USE 4-0-2000; IN COMMERCE 4-0-2000.
ESTHER A. BORSUK, EXAMINING ATTORNEY

SN 76-658,545. MELLE, CARL A., ALLISON PARK, PA.
FILED 4-17-2006.

FLING FOR THE RING

THE MARK CONSISTS OF STANDARD CHARACTERS WITHOUT CLAIM TO ANY PARTICULAR FONT, STYLE, SIZE, OR COLOR.

FOR CLOTHING, NAMELY HATS, CAPS, T-SHIRTS, SWEATSHIRTS, SPORT SHIRTS, JACKETS, SWEATERS AND COATS SOLD IN RELATION TO A SPORT (U.S. CLS. 22 AND 39).

DEIRDRE ROBERTSON, EXAMINING ATTORNEY

CLASS 25—(Continued).

SN 76-658,557. COLONESE, JOE, COLORADO SPRINGS, CO.
FILED 4-17-2006.

HKY

THE MARK CONSISTS OF STANDARD CHARACTERS WITHOUT CLAIM TO ANY PARTICULAR FONT, STYLE, SIZE, OR COLOR.

FOR MEN'S, WOMEN'S AND CHILDREN'S SPORTSWEAR AND HEADWEAR, NAMELY, BANDANAS, BASEBALL CAPS, BEANIES, FLEECE PULLOVERS, GLOVES, GOLF SHIRTS, HATS, JACKETS, JERSEYS, LACE BOOTS, PANTS, POLO SHIRTS, PULLOVERS, SHIRTS, SKATING OUTFITS, SPORT SHIRTS, SWEAT SHORTS, SWEAT SUITS, VESTS, VISORS, WARM UP SUITS (U.S. CLS. 22 AND 39).

COLLEEN KEARNEY, EXAMINING ATTORNEY

SN 76-659,016. NEW ERA DESIGN, LLC, NEW YORK, NY.
FILED 4-26-2006.

RECESS

THE MARK CONSISTS OF STANDARD CHARACTERS WITHOUT CLAIM TO ANY PARTICULAR FONT, STYLE, SIZE, OR COLOR.

FOR CLOTHING, NAMELY, JEANS, SHIRTS, COATS, JACKETS, RAINCOATS, SWEATERS, PANTS, SHORTS, SOCKS, SHOES, HATS, GLOVES AND SCARVES (U.S. CLS. 22 AND 39).

CAROLYN CATALDO, EXAMINING ATTORNEY

SN 76-660,124. ESEBAG, JIMMY, BEVERLY HILLS, CA.
FILED 5-16-2006.

STREET SAINT

THE MARK CONSISTS OF STANDARD CHARACTERS WITHOUT CLAIM TO ANY PARTICULAR FONT, STYLE, SIZE, OR COLOR.

FOR CLOTHING, NAMELY, PANTS, SHORTS, SWEATPANTS, OVERALLS, SHIRTS, TEE-SHIRTS, SWEATSHIRTS, BLOUSES, SKIRTS, DRESSES, JACKETS, VESTS, COATS, RAINWEAR, SHOES, LINGERIE, SLEEPWEAR, LOUNGEWEAR, SWIMWEAR, GLOVES, SOCKS, HOSIERY, BELTS, SCARVES, HATS, TIES, AND SLIPPERS (U.S. CLS. 22 AND 39).

RONALD MCMORROW, EXAMINING ATTORNEY

CLASS 25—(Continued).

SN 78-193,366. TM ENTERPRISES, CHAPPAQUA, NY. FILED 12-11-2002.

Marisol

FOR (BASED ON USE IN COMMERCE) CLOTHING, NAMELY, BLOUSES, CAMISOLES, DRESSES, HALTER TOPS, JACKETS, JEANS, KNIT SHIRTS, KNIT TOPS, SHIRTS, SHORTS, SKIRTS, SLACKS, SUITS, SWEATERS, SWIM WEAR, T-SHIRTS, TANK TOPS, AND VESTS; (BASED ON INTENT TO USE) BATHROBES, BEACH COVER-UPS, BEACHWEAR, BELTS, BLAZERS, BODY SHAPERS, BODY SUITS, BOXER SHORTS, BRAS, BUSTIERS, CAPS, COATS, HATS, HEADBANDS, HOSIERY, JOGGING SUITS, KNEE HIGHS, LEOTARDS, LINGERIE, LOUNGEWEAR, MITTENS, NEGLIGEEES, NIGHT GOWNS, NIGHT SHIRTS, PAJAMAS, PANTIES, PANTS, PANTYHOSE, SARONGS, SCARVES, SLEEPWEAR, SLIPS, SOCKS, STOCKINGS, SWEAT PANTS, SWEAT SHIRTS, SWEAT SHORTS, SWEAT SUITS, TAP PANTS, TEDDIES, TIES, TIGHTS, UNDERPANTS, UNDERSHIRTS, AND UNDERWEAR (U.S. CLS. 22 AND 39).

FIRST USE 4-1-2000; IN COMMERCE 4-1-2000.
STACY WAHLBERG, EXAMINING ATTORNEY

SN 78-254,616. RIP CURL INTERNATIONAL PTY LTD, TORQUAY, VICTORIA, AUSTRALIA, FILED 5-27-2003.

PEAK

OWNER OF AUSTRALIA REG. NO. 501073, DATED 1-29-1992, EXPIRES 12-8-2009.

OWNER OF U.S. REG. NO. 1,764,576.
FOR WETSUIT AND WETSUIT COMPONENTS, NAMELY, HOODS, BOOTIES, VESTS, SHORTS AND GLOVES (U.S. CLS. 22 AND 39).
MICHAEL LEVY, EXAMINING ATTORNEY

SN 78-429,695. FARHAT, JAMEL, BELL, CA. FILED 6-3-2004.



stampadenimco
AMERICA'S FINEST URBAN DENIM

NO CLAIM IS MADE TO THE EXCLUSIVE RIGHT TO USE AMERICA'S FINEST URBAN DENIM, APART FROM THE MARK AS SHOWN.

THE MARK CONSISTS OF "SDCO." IN A VERTICAL POSITION IN RELATION TO "STAMPADENIMCO.", ALL IN A PARTICULARIZED FONT.

FOR CLOTHING, NAMELY TIES, PANTS, SHIRTS, BOOTS, T-SHIRTS, SUITS, JACKETS, UNDERWEAR, BELTS, SOCKS, HATS, SHOES, SHAWLS, SCARFS, DENIMS, SKIRTS, AND SWEATERS (U.S. CLS. 22 AND 39).

FIRST USE 6-1-2001; IN COMMERCE 6-1-2001.
TRACY CROSS, EXAMINING ATTORNEY

CLASS 25—(Continued).

SN 78-457,440. ROWLEY, CYNTHIA, NEW YORK, NY. FILED 7-27-2004.

SOUVENIR

THE MARK CONSISTS OF STANDARD CHARACTERS WITHOUT CLAIM TO ANY PARTICULAR FONT, STYLE, SIZE, OR COLOR.

FOR CLOTHING FOR WOMEN AND CHILDREN, NAMELY, SHIRTS, BLOUSES, JACKETS, DRESSES, SKIRTS, PANTS, SHORTS, BLAZERS, SWEATERS AND SPORTSWEAR, NAMELY, TOPS, BOTTOMS, SWEAT SUITS AND WORKOUT SUITS; CLOTHING FOR MEN, NAMELY, SHIRTS, PANTS, SHORTS, BLAZERS, SWEATERS AND JACKETS; BELTS, GLOVES AND FOOTWEAR (U.S. CLS. 22 AND 39).

KEVON CHISOLM, EXAMINING ATTORNEY

SN 78-468,837. ANHEUSER-BUSCH, INCORPORATED, ST. LOUIS, MO. FILED 8-17-2004.

GET IN YOUR ELEMENT

THE MARK CONSISTS OF STANDARD CHARACTERS WITHOUT CLAIM TO ANY PARTICULAR FONT, STYLE, SIZE, OR COLOR.

FOR CLOTHING, NAMELY SHIRTS AND HEADWEAR (U.S. CLS. 22 AND 39).

DAVID MURRAY, EXAMINING ATTORNEY

CLASS 25—(Continued).

SN 78-490,683. BORRIELLO, ROSEANN, WOODMERE, NY.
FILED 9-28-2004.

BOO-BOO'S BY RO-RO

THE MARK CONSISTS OF STANDARD CHARACTERS WITHOUT CLAIM TO ANY PARTICULAR FONT, STYLE, SIZE, OR COLOR.

FOR SANDALS (U.S. CLS. 22 AND 39).
FIRST USE 5-25-2004; IN COMMERCE 8-8-2004.
CARRIE ACHEN, EXAMINING ATTORNEY

CLASS 25—(Continued).

SN 78-543,488. GIRALDIN, PATRICK W., LADERA RANCH, CA. FILED 1-6-2005.



THE MARK CONSISTS OF A STYLIZED LETTER "O" THAT HAS A CROSS OVER IT.

FOR CLOTHING, NAMELY, SHIRTS, CAPS, JACKETS, AND SOCKS (U.S. CLS. 22 AND 39).
VERNA BETH RIRIE, EXAMINING ATTORNEY

SN 78-515,349. MONSTER CABLE PRODUCTS, INC., BRISBANE, CA. FILED 11-11-2004.



NO CLAIM IS MADE TO THE EXCLUSIVE RIGHT TO USE SAN FRANCISCO, APART FROM THE MARK AS SHOWN.

THE MARK CONSISTS OF THE WORD MONSTER ABOVE THE WORD PARK OVER A REPRESENTATION OF A STADIUM UNDER WHICH ARE THE WORDS SAN FRANCISCO.

FOR CLOTHING AND HEADGEAR, NAMELY, T-SHIRTS, SWEATSHIRTS, PANTS, SOCKS, CAPS AND BEANIES (U.S. CLS. 22 AND 39).
CHRIS WELLS, EXAMINING ATTORNEY

SN 78-551,722. INNOVATIVE FASHION GROUP CORP., NEW YORK, NY. FILED 1-21-2005.

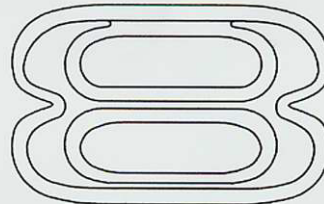

SN 78-520,103. LEGENDARY HOLDINGS, INC., CHULA VISTA, CA. FILED 11-19-2004.

LEGENDARY HEADWEAR

THE MARK CONSISTS OF STANDARD CHARACTERS WITHOUT CLAIM TO ANY PARTICULAR FONT, STYLE, SIZE, OR COLOR.

OWNER OF U.S. REG. NOS. 1,868,440, 2,858,330 AND OTHERS.

NO CLAIM IS MADE TO THE EXCLUSIVE RIGHT TO USE "HEADWEAR", APART FROM THE MARK AS SHOWN.

FOR CLOTHING, NAMELY HATS, CAPS AND VISORS (U.S. CLS. 22 AND 39).
FIRST USE 12-20-1996; IN COMMERCE 12-30-1996.
SHARON MEIER, EXAMINING ATTORNEY

FOR CLOTHING, NAMELY, SHIRTS, T-SHIRTS, PANTS, TOPS, SHORTS, JACKETS, SWEAT SHIRTS, SPORTS BRAS AND MUSCLE TOPS (U.S. CLS. 22 AND 39).

GINA FINK, EXAMINING ATTORNEY

CLASS 25—(Continued).

SN 78-583,699. CALCADOS BEIRA RIO S/A, NOVO HAMBURGO, RS, BRAZIL, FILED 3-9-2005.

VIZZANO

THE MARK CONSISTS OF STANDARD CHARACTERS WITHOUT CLAIM TO ANY PARTICULAR FONT, STYLE, SIZE, OR COLOR.

OWNER OF BRAZIL REG. NO. 819885789, DATED 5-21-2002, EXPIRES 5-21-2012.

FOR CLOTHING, NAMELY, HAND WARMERS, DRESSES, SHORTS, WAIST SLIPS, APRONS, SWIM WEAR, BATH ROBES; BERMUDA SHORTS; JACKETS; CAPS; SCARVES; PANTS; BATHING TRUNKS, COATS; SHIRTS; OVERCOATS; LONG JOHNS; VESTS; BODICES; SLIPS; MEN'S UNDERWEAR; TRENCH COATS; SPORTS WEAR, NAMELY T-SHIRTS, MINI-BLOUSES AND TOPS; SKULL CAPS; TIES; DUST COATS; CAR JACKETS; CASUAL JACKETS; CRAVATS; LINGERIE; GLOVES; OVERALLS; SOCKS; SUIT JACKETS; FUR STOLES, PEIGNOIRS, PAJAMAS, LEGGINGS, PULL-OVERS, UNDERWEAR, SKIRTS, CLOTH COATS, SWEATERS, SUSPENDERS, BRASSIERES, SUITS, TOGAS, TUNICS, SHAWLS, UNIFORMS, SHOES, SANDALS, BOOTS, SLIPPERS (U.S. CLS. 22 AND 39).

ODESSA BIBBINS, EXAMINING ATTORNEY

SN 78-596,624. COMCAST PROGRAMMING DEVELOPMENT, INC., PHILADELPHIA, PA. FILED 3-28-2005.



THE COLOR(S) BLUE AND BLACK IS/ARE CLAIMED AS A FEATURE OF THE MARK.

THE COLOR(S) BLUE THAT APPEARS IN THE WORDS SELECT AND DEMAND AND ON FOUR SEMICIRCLES AND THE COLOR BLACK THAT APPEARS IN THE WORD ON AND THE CIRCLE IS/ARE CLAIMED AS A FEATURE OF THE MARK.

FOR CLOTHING GOODS, NAMELY, CAPS AND HATS, HEADWEAR, JACKETS, SHIRTS, SWEATSHIRTS, TOPS, T-SHIRTS, VESTS, AND VISORS (U.S. CLS. 22 AND 39).

ARETHA SOMERVILLE, EXAMINING ATTORNEY

CLASS 25—(Continued).

SN 78-623,724. TAWIL ASSOCIATES INC., CARTERET, NJ. FILED 5-5-2005.

BABY O'S

THE MARK CONSISTS OF STANDARD CHARACTERS WITHOUT CLAIM TO ANY PARTICULAR FONT, STYLE, SIZE, OR COLOR.

NO CLAIM IS MADE TO THE EXCLUSIVE RIGHT TO USE "BABY", APART FROM THE MARK AS SHOWN.

FOR CLOTHING AND INFANT WEAR, NAMELY - BATHROBES, BEACHWEAR, BLOUSES, BODY SUITS, BOOTIES, CARDIGANS, COATS, COVERALLS, CREEPERS, DRESSES, HATS, JACKETS, JEANS, JOGGING SUITS, JUMPERS, JUMPSUITS, KNIT SHIRTS, KNIT TOPS, OUTERWEAR, NAMELY, COATS AND SWEATERS, OVERALLS, PANTS, SHIRTS, SHORTS, SKIRTS, SLACKS, SOCKS, SWEATERS, SWEAT PANTS, SWEAT SHIRTS, SWEAT SHORTS, SWEAT SUITS, T-SHIRTS, TANK TOPS, UNDERSHIRTS AND UNDERWEAR (U.S. CLS. 22 AND 39).

FIRST USE 5-1-2005; IN COMMERCE 5-1-2005.

JACQUELINE A. LAVINE, EXAMINING ATTORNEY

SN 78-631,061. ENZO TANGELO INC., NEW YORK, NY. FILED 5-16-2005.

N~NER~G

THE MARK CONSISTS OF STANDARD CHARACTERS WITHOUT CLAIM TO ANY PARTICULAR FONT, STYLE, SIZE, OR COLOR.

FOR MEN'S AND WOMEN'S UNDERWEAR APPAREL (U.S. CLS. 22 AND 39).

RONALD AIKENS, EXAMINING ATTORNEY

SN 78-633,996. INBS INC., NEW YORK, NY. FILED 5-20-2005.

KC Stevens

THE MARK CONSISTS OF STANDARD CHARACTERS WITHOUT CLAIM TO ANY PARTICULAR FONT, STYLE, SIZE, OR COLOR.

THE NAME KC STEVENS DOES NOT IDENTIFY A LIVING INDIVIDUAL.

FOR CLOTHING TOPS, TANK TOPS, CAPRI PANTS, PANTS, SKIRTS AND DRESSES, SKIRTS, JACKETS, SHORTS, SHORT SETS, SHORT SLEEVED OR LONG SLEEVED T-SHIRTS, T-SHIRTS, BLOUSES, CARDIGANS, MOCK TURTLE-NECK SWEATERS, SWEATERS, TURTLENECK SWEATERS, V-NECK SWEATERS (U.S. CLS. 22 AND 39).

JOANNA DUKOVIC, EXAMINING ATTORNEY

CLASS 25—(Continued).

SN 78-634,087. TYD, LLC., TOWNSHIP OF WASHINGTON, NJ. FILED 5-20-2005.



THE MARK CONSISTS OF STYLIZED LETTERS T, Y, D WITH THE Y APPEARING AS A PERSON WITH UPRaised ARMS.

FOR HATS, CAPS, T-SHIRTS, TENNIS SHIRTS, GOLF SHIRTS, SHORTS, PANTS, JACKETS, SOCKS, AND BELTS THAT BEAR OUR TRADEMARK (U.S. CLS. 22 AND 39).

FIRST USE 10-15-2004; IN COMMERCE 3-25-2005.
ARETHA SOMERVILLE, EXAMINING ATTORNEY

SN 78-637,958. HALLIWELL, LOGAN, OCEANSIDE, CA. FILED 5-26-2005.

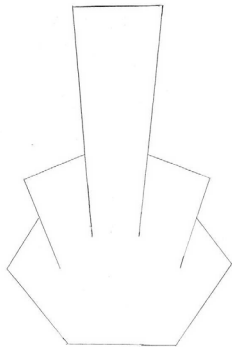

THE MARK CONSISTS OF DESIGN OF GUITAR.

FOR SPORTSWEAR, SKATEBOARD WEAR, GYMNAS-TICS WEAR, AND LEISURE WEAR, NAMELY, SHORTS, BOARD SHORT, WALK SHORTS, VOLLEY SHORTS, WET SUIT SHORTS, PANTS, LONG PANTS, BEACH PANTS, TROUSERS, SLACKS, JEANS, T-SHIRTS, TANK TOPS, SINGLET, SHIRTS AND CASUAL TOPS WITH LONG AND SHORT SLEEVES, SLEEVELESS SHIRTS, SLEEVELESS TOPS, WET SUIT TOPS, JERSEYS, SWEAT SHIRTS, SWEAT TOPS, OVERALLS, DRESSES, SKIRTS, SKORTS, SARONGS TIGHTS, SOCKS, EARMUFFS, MITTENS, GLOVES, WET SUIT GLOVES, SKI GLOVES, JACKETS, PARKAS, WIND RESISTANT JACKETS, SWEAT HOODED PARKAS, COATS, JUMPERS, VESTS, WET SUIT VESTS, SWIM WEAR, BATHING SUITS, BATHING TRUNKS, WET SUITS, WET SUIT BOOTS, WET SUIT HOODS, SWEATERS, PULLOVERS, WARM UP SUITS, TRACK SUITS, RAIN SUITS, FOOTWEAR,

CLASS 25—(Continued).

SLIPPERS, BOOTS, SHOES, BEACH SHOES, THONGED AND STRAPPED SANDALS, SNOW BOOTS, SNOW-BOARD BOOTS, SKI BOOTS, APRES SKI BOOTS, KITE-BOARD BOOTS, SURFBOARD BOOTS, WAKEBOARD BOOTS, ATHLETIC SHOES; HEADGEAR, NAMELY, VISORS, SWEATBANDS, HEADBANDS FOR SWIMMING, SWIMCAPS, HEADBANDS, BEANIES, BANDANAS, HATS, CAPS, HOODS, SURF CAPS, SURF HOODS; RASH GUARDS, NAMELY, RASH SHIRTS, RASH VESTS; SKI WEAR AND SNOWBOARD WEAR, NAMELY, SKI SUITS, SKI PANTS, SKI TROUSERS, SKI JACKETS, SNOWBOARD PANTS, SNOWBOARD TROUSERS AND SNOWBOARD JACKETS; NIGHT CLOTHES AND SLEEPWEAR, NAMELY, PAJAMAS, DRESSING GOWNS, ROBES, BATHROBES, NEGLIGES, NIGHTGOWNS, NIGHT SHIRTS, NIGHT CAPS, NIGHT DRESSES, NIGHTIES, SLEEP MASKS, SLEEP SHIRTS, SLEEPING GARMENTS, LINGERIE; UNDERWEAR, STOCKINGS, PANTYHOSE, BODYSUITS, BOXER SHORTS; APRONS, MONEY BELTS, TIES, BELTS, SCARVES, BRACES (U.S. CLS. 22 AND 39).

RICHARD WHITE, EXAMINING ATTORNEY

SN 78-659,814. SYLLABLES, INC, PALISADES PARK, NJ. FILED 6-28-2005.

DE AAR

THE MARK CONSISTS OF STANDARD CHARACTERS WITHOUT CLAIM TO ANY PARTICULAR FONT, STYLE, SIZE, OR COLOR.

FOR CLOTHING, NAMELY, WOVEN SHIRTS, POLO SHIRTS, SWEATERS, CASUAL TROUSERS, DRESS SHIRTS, JEANS, PANTS, NECKWEAR, TIES, SCARVES, BELTS, SUITS, SPORT COATS, T-SHIRTS, FOOTWEAR, SANDALS, SNEAKERS, UNDERWEAR, JERSEYS, TANK TOPS, HATS, VISORS, BASEBALL HATS, SOCKS, HOSIERY, LEATHER JACKETS, AND SUEDE JACKETS (U.S. CLS. 22 AND 39).

SANI KHOURI, EXAMINING ATTORNEY

SN 78-663,064. WALKER, EDWIN R., WAHIAWA, HI. FILED 7-1-2005.

IOD IRONOVERDOSE

THE MARK CONSISTS OF STANDARD CHARACTERS WITHOUT CLAIM TO ANY PARTICULAR FONT, STYLE, SIZE, OR COLOR.

FOR ANKLE SOCKS, ANKLETS, ATHLETIC UNI-FORMS, BANDANAS, BASEBALL CAPS, VISORS, CAPS WITH VISORS, FLEECE PULLOVERS, GOLF SHIRTS, GYM SHORTS, GYM SUITS, HEAD SWEATBANDS, HEAD WEAR, HEADBANDS, HEADBANDS AGAINST SWEATING, JERSEYS, JOGGING OUTFITS, JOGGING PANTS, JOGGING SUITS, MEN'S SOCKS, POLO SHIRTS, SHIRTS, SHORT TROUSERS, SHORTS, SHORT SLEEVED OR LONG SLEEVED T-SHIRTS, SHORT SLEEVED SHIRTS, SLEEVELESS JERSEYS, SOCKS, SPORT SHIRTS, SPORTS BRAS, SPORTS JACKETS, SPORTS SHIRTS, SPORTS SHIRTS WITH SHORT SLEEVES, SUN VISORS, SWEAT BANDS, SWEAT PANTS, SWEAT SHORTS, SWEAT SUITS, SWEAT-BANDS, SWEAT SOCKS, TANK TOPS, T-SHIRTS, UNDERWEAR, UNIFORMS (U.S. CLS. 22 AND 39).

CAROLINE WOOD, EXAMINING ATTORNEY

CLASS 25—(Continued).

SN 78-663,412. HERRERA, EDWARD G., PICO RIVERA, CA. FILED 7-5-2005.

PRO-BOY

THE MARK CONSISTS OF STANDARD CHARACTERS WITHOUT CLAIM TO ANY PARTICULAR FONT, STYLE, SIZE, OR COLOR.

FOR CLOTHING, NAMELY TANK TOPS, MUSCLE TEES, T-SHIRTS, AND SWEAT SHIRTS (U.S. CLS. 22 AND 39).

RICHARD A. STRASER, EXAMINING ATTORNEY

SN 78-664,958. CLEMENS, DEBBIE, HOUSTON, TX. FILED 7-6-2005.



NO CLAIM IS MADE TO THE EXCLUSIVE RIGHT TO USE "JACKET", APART FROM THE MARK AS SHOWN.

THE COLORS BLACK, RED, GRAY AND PINK ARE CLAIMED AS A FEATURE OF THE MARK.

THE COLOR BLACK APPEARS IN THE WORDING "JACKET"; THE COLOR GRAY APPEARS IN THE "BACKGROUND" WORDING "JACKET"; THE COLOR RED APPEARS IN THE WORDING "HAPPY"; THE COLOR PINK APPEARS IN THE "BACKGROUND" WORDING "HAPPY"; THE COLOR GRAY ALSO APPEARS IN THE DESIGN ELEMENT OF THE MARK.

FOR DENIM JEANS JACKETS IN MULTIPLE COLORS WITH LEATHER, EMBROIDERED IMAGES AND RHINESTONE EMBELLISHMENTS (U.S. CLS. 22 AND 39).

FIRST USE 9-29-2004; IN COMMERCE 9-29-2004.

DAWN HAN, EXAMINING ATTORNEY

SN 78-665,051. M ADKINS, INC., LOS ANGELES, CA. FILED 7-6-2005.

TEENS OF COMEDY

THE MARK CONSISTS OF STANDARD CHARACTERS WITHOUT CLAIM TO ANY PARTICULAR FONT, STYLE, SIZE, OR COLOR.

FOR CLOTHING, NAMELY, T-SHIRTS AND SWEATSHIRTS; AND HEADGEAR, NAMELY, HATS AND CAPS (U.S. CLS. 22 AND 39).

FIRST USE 10-15-2005; IN COMMERCE 10-15-2005.

MICHELLE DUBOIS, EXAMINING ATTORNEY

CLASS 25—(Continued).

SN 78-667,864. REGUINDIN, MARVIN D., DBA THINKING CAP COMMUNICATIONS, SPOKANE, WA. FILED 7-11-2005.



THE COLOR(S) RED; ORANGE, YELLOW; GREEN; BLUE AND PURPLE IS/ARE CLAIMED AS A FEATURE OF THE MARK.

THE COLORS RED, ORANGE, YELLOW, GREEN, BLUE AND PURPLE APPEAR FROM LEFT TO RIGHT ON THE HUMAN FIGURES IN THE MARK; THE COLOR BLUE ALSO APPEARS IN THE WORDING.

FOR CLOTHING AND CLOTHING ACCESSORIES, NAMELY: MEN'S, WOMEN'S AND CHILDREN'S T-SHIRTS, SWEATSHIRTS, CASUAL SHIRTS, GOLF SHIRTS, SWEATERS, CAPS, HATS, AND VISORS (U.S. CLS. 22 AND 39).

FIRST USE 5-16-2005; IN COMMERCE 6-11-2005.

STEVEN R. FINE, EXAMINING ATTORNEY

SN 78-667,980. GOO, DAVID, CAMPBELL, CA. AND GOO, SHIRLEY, CAMPBELL, CA. FILED 7-11-2005.



THE COLOR(S) RED, BLUE, BLACK AND WHITE IS/ARE CLAIMED AS A FEATURE OF THE MARK.

THE MARK CONSISTS OF A BALD ORIENTAL MAN WITH BUDDHA-LIKE FEATURES OUTLINED IN BLACK WITH WHITE BACKGROUND, WEARING A BLUE HAPPY COAT EXHIBITING A RED FLOWER DESIGN, HOLDING A BOWL OF RICE EXHIBITING THE WORDS GOO RICE IN RED WITH RED CHOPSTICKS EXTENDING FROM THE BOWL, AND EXTENDING HIS LEFT FOOT TO REVEAL THE WORDS GOO ENT. IN RED ON THE BOTTOM OF BLUE AND BLACK COLORED SLIPPER.

FOR CLOTHING, NAMELY SHIRTS AND SHORTS (U.S. CLS. 22 AND 39).

FIRST USE 5-10-2004; IN COMMERCE 10-31-2004.

SEAN CROWLEY, EXAMINING ATTORNEY

CLASS 25—(Continued).

SN 78-668,916. DAVE SOPP AND KELLY SOPP, DBA WRY BABY, SAN FRANCISCO, CA. FILED 7-12-2005.

Raise Funny People

THE MARK CONSISTS OF STANDARD CHARACTERS WITHOUT CLAIM TO ANY PARTICULAR FONT, STYLE, SIZE, OR COLOR.

FOR CHILDRENS' CLOTHING AND ACCESSORIES NAMELY SNAPSUITS, TEE SHIRTS, BIBS, DIAPER COVERS, AND HATS (U.S. CLS. 22 AND 39).

FIRST USE 8-1-2003; IN COMMERCE 8-1-2003.
JEFF DEFORD, EXAMINING ATTORNEY

CLASS 25—(Continued).

SN 78-680,011. STUBNER, JULIUS Z., IRVINE, CA. FILED 7-27-2005.

Goddess

BEVERLY HILLS

NO CLAIM IS MADE TO THE EXCLUSIVE RIGHT TO USE "BEVERLY HILLS", APART FROM THE MARK AS SHOWN.

FOR WOMEN'S T-SHIRTS, BLOUSES, SWIMWEAR, SKIRTS, BATHROBES, SHORTS (U.S. CLS. 22 AND 39).

FIRST USE 5-2-2005; IN COMMERCE 5-2-2005.
JENNIFER VASQUEZ, EXAMINING ATTORNEY

SN 78-688,126. BLACK FIVES, INC., GREENWICH, CT. FILED 8-8-2005.

BLACK FIVES ERA

THE MARK CONSISTS OF STANDARD CHARACTERS WITHOUT CLAIM TO ANY PARTICULAR FONT, STYLE, SIZE, OR COLOR.

OWNER OF U.S. REG. NOS. 2,846,722, 2,949,712 AND OTHERS.

FOR CLOTHING, NAMELY, NAMELY, SHIRTS, SHORTS, JERSEYS, UNIFORMS, HATS, CAPS, SCARVES, HEADBANDS, JACKETS, COATS, TOPS, PANTS, SOCKS, SHOES, FOOTWEAR, BOOTS, SLIPPERS, SNEAKERS, ATHLETIC FOOTWEAR, UNDERWEAR, SLEEPWEAR, TIES, BOTTOMS, WRISTBANDS, SWEATBANDS, HOSIERY, SWEAT SHIRTS, SWEAT PANTS, T-SHIRTS, SWIMWEAR, BEACHWEAR, DRESSES, JUMPERS, PLAY SUITS, THERMAL UNDERWEAR, BOXER SHORTS, JEANS, JUMPSUITS, SKIRTS, OVERALLS, LEGGINGS, WARM-UP SUITS, BABY AND TODDLER SUITS, COMPRESSION SHORTS (U.S. CLS. 22 AND 39).

FIRST USE 2-15-2004; IN COMMERCE 2-15-2004.
GEORGE LORENZO, EXAMINING ATTORNEY

SN 78-676,705. RAGIN, SHAROND, NEW YORK, NY. FILED 7-22-2005.

RAGGA MUNDO

THE MARK CONSISTS OF STANDARD CHARACTERS WITHOUT CLAIM TO ANY PARTICULAR FONT, STYLE, SIZE, OR COLOR.

THE ENGLISH TRANSLATION OF "RAGGA MUNDO" IS "REGGAE WORLD".

FOR CLOTHING FOR MEN, WOMEN AND CHILDREN, NAMELY, WARM UP SUITS, JOGGING SUITS, SWEAT SUITS, SWEAT PANTS AND SWEAT SHIRTS, BODY SUITS, LEOTARDS, LEG WARMERS, SWIM WEAR, BATHING SUITS, BEACH AND BATHING COVER UPS, SUITS, SLACKS, TROUSERS, PANTS, JEANS, SHORTS, SWEAT SHORTS, GYM SHORTS, TOPS, JACKETS, COATS, SPORT COATS, SHIRTS, SPORT SHIRTS, T-SHIRTS, KNIT SHIRTS, POLO SHIRTS, PULLOVERS, SWEATERS, VESTS, TANK TOPS, JUMP SUITS, PLAY SUITS, OVERCOATS, PARKAS, WIND RESISTANT JACKETS, LEATHER JACKETS, FOOTWEAR, SHOES, BOOTS, SLIPPERS, ATHLETIC FOOTWEAR, BASKETBALL SHOES, CASUAL FOOTWEAR, SANDALS, HEAD WEAR, HATS, CAPS, VISORS, HOODS, BERETS, HEADBANDS, SWEAT BANDS, WRISTBANDS, EAR MUFFS, NECKWEAR, NECKTIES, NECKERCHIEVES, SCARVES, BANDANNAS, SLEEP WEAR, ROBES, PAJAMAS, NIGHTSHIRTS, RAIN WEAR, GLOVES, MITTENS, GALOSHES, LOUNGE WEAR, UNDERWEAR, BRIEFS, UNDERPANTS, BOXER SHORTS, UNDERSHIRTS, SUSPENDERS, HOSIERY, SOCKS, AND BELTS (U.S. CLS. 22 AND 39).

FIRST USE 5-31-2005; IN COMMERCE 5-31-2005.
LAURIE MAYES, EXAMINING ATTORNEY

SN 78-691,962. OROZCO, ROGER A., CARPINTERIA, CA. AND OROZCO, NORA G., CARPINTERIA, CA. FILED 8-12-2005.

STAGECOACH

THE MARK CONSISTS OF STANDARD CHARACTERS WITHOUT CLAIM TO ANY PARTICULAR FONT, STYLE, SIZE, OR COLOR.

FOR FOOTWEAR (U.S. CLS. 22 AND 39).
FIRST USE 10-15-1996; IN COMMERCE 10-15-1996.
YONG KIM, EXAMINING ATTORNEY

CLASS 25—(Continued).

SN 78-697,949. YAG-HOWARD, CYNDI, NAPLES, FL. FILED 8-22-2005.

SUNSASSY

THE MARK CONSISTS OF STANDARD CHARACTERS WITHOUT CLAIM TO ANY PARTICULAR FONT, STYLE, SIZE, OR COLOR.

FOR SUN PROTECTIVE PRODUCTS, NAMELY CLOTHING, NAMELY SUN SLEEVES, BATHING SUITS, SUSPENDERS, BELTS, SKIRTS, SKORTS, PANTS, FOOTWEAR, SOCKS, HATS, GLOVES, MITTENS, UNDERWEAR, SCARVES, SHORTS, SHORT SETS, CULOTTES, BLOUSES, SHIRTS, T-SHIRTS, BELTS, JACKETS, COATS, RAINWEAR, CAPS, TIES, TOPS, DRESSES, SWIMWEAR, SUNSUITS, SURF WEAR, TRACK SUITS, SWEAT PANTS, SWEAT SHIRTS, SWEAT SUITS, SWEAT BANDS, HEAD BANDS, HEAD BANDS AGAINST SWEATING, WRISTBANDS, TENNIS WEAR, WARM UP SUITS, WRAPS, SLEEPWEAR, SLIPPERS, SHOES, TENNIS SHOES, OVERALLS, HEADWEAR, INFANTWEAR, JEANS, COVERUPS, BOOTS, BOOTIES, BATHROBES, BEACH COVERUPS, BANDANAS, CAMISOLES, CLOTH BIBS, LEOTARDS, VESTS, SWEATERS, SASHES, SHAWLS, STOCKINGS, VEILS, VISORS, WET SUITS, SPORTS JACKETS, AND SUITS (U.S. CLS. 22 AND 39).

ANDREA SAUNDERS, EXAMINING ATTORNEY

SN 78-698,712. SHMASH PRODUCTIONS INC, LOS ANGELES, CA. FILED 8-23-2005.

KRUMP

THE MARK CONSISTS OF STANDARD CHARACTERS WITHOUT CLAIM TO ANY PARTICULAR FONT, STYLE, SIZE, OR COLOR.

FOR ARTICLES OF CLOTHING, NAMELY SHIRTS, SWEATERS, JACKETS, PANTS, TEE SHIRTS, SOCKS, SCARVES, GLOVES, CAPS, VISORS, HEADBANDS AND SWEATBANDS (U.S. CLS. 22 AND 39).

ELIZABETH J. WINTER, EXAMINING ATTORNEY

SN 78-699,709. ALPHA GARMENT, INC., NEW YORK, NY. FILED 8-24-2005.

ZANA DI

THE MARK CONSISTS OF STANDARD CHARACTERS WITHOUT CLAIM TO ANY PARTICULAR FONT, STYLE, SIZE, OR COLOR.

ZANA DI DOES NOT IDENTIFY A LIVING INDIVIDUAL. FOR DRESSES; JACKETS; JEANS; PANTS; SHIRTS; SKIRTS; SWEATERS; VESTS (U.S. CLS. 22 AND 39).

FIRST USE 9-15-1987; IN COMMERCE 9-15-1987.
SHAUNIA WALLACE, EXAMINING ATTORNEY

CLASS 25—(Continued).

SN 78-701,341. DAVID GLUCK & ROBIN DEARBORN CONSULTING, OAKLAND, CA. FILED 8-26-2005.



NO CLAIM IS MADE TO THE EXCLUSIVE RIGHT TO USE KIPPAH, APART FROM THE MARK AS SHOWN.

THE COLORS DARK BLUE, BLUE, RED, GREEN AND YELLOW ARE CLAIMED AS A FEATURE OF THE MARK.

THE COLOR LIGHT BLUE IS SHOWN ON THE WORDS KIPPAH KING. THE DESIGN OF A YARMULKE WITH CONCENTRIC RINGS/LINES, FROM THE OUTSIDE, THE FIRST AND THIRD LINES ARE LIGHT BLUE, THE SECOND LINE IS RED, THE FOURTH LINE GREEN, THE FIFTH LINE IS YELLOW, AND INNER LINE IS DARK BLUE.

THE FOREIGN WORDING IN THE MARK TRANSLATES INTO ENGLISH AS YARMULKE OR SKULL CAP.

FOR CLOTHING, NAMELY, CAPS (U.S. CLS. 22 AND 39).

LINDA E. BLOHM, EXAMINING ATTORNEY

SN 78-702,035. MULITEX LIMITED, KOWLOON, HONG KONG, FILED 8-28-2005.

BEBERT THE RED

THE MARK CONSISTS OF STANDARD CHARACTERS WITHOUT CLAIM TO ANY PARTICULAR FONT, STYLE, SIZE, OR COLOR.

NO CLAIM IS MADE TO THE EXCLUSIVE RIGHT TO USE "RED", APART FROM THE MARK AS SHOWN.

FOR CLOTHING, NAMELY, T-SHIRTS, BLOUSES, UNDERWEAR, SHIRTS, PANTS, LADIES VESTS, SHORTS, BOOTS, SLIPPERS, SHOES, SOCKS, SWEATERS, SWEATSHIRTS, JACKETS, AND CHILDREN'S CLOTHING, NAMELY, T-SHIRTS, UNDERWEAR, SHIRTS, PANTS, SHORTS, BOOTS, SLIPPERS, SHOES, SOCKS, SWEATERS, SWEATSHIRTS, JACKETS (U.S. CLS. 22 AND 39).

MICHAEL LEWIS, EXAMINING ATTORNEY

CLASS 25—(Continued).

SN 78-702,037. MULITEX LIMITED, KOWLOON, HONG KONG, FILED 8-28-2005.

CLASS 25—(Continued).

SN 78-703,696. BUILT NY, INC., NEW YORK, NY. FILED 8-30-2005.

JAMES JORDAN

BUILT NY

THE MARK CONSISTS OF STANDARD CHARACTERS WITHOUT CLAIM TO ANY PARTICULAR FONT, STYLE, SIZE, OR COLOR.

JAMES JORDAN DOES NOT IDENTIFY A PARTICULAR LIVING INDIVIDUAL.

FOR CLOTHING, NAMELY, T-SHIRTS, BLOUSES, UNDERWEAR, SHIRTS, PANTS, LADIES VESTS, SHORTS, BOOTS, SLIPPERS, SHOES, SOCKS, SWEATERS, SWEATSHIRTS, JACKETS, AND CHILDREN'S CLOTHING, NAMELY, T-SHIRTS, UNDERWEAR, SHIRTS, PANTS, SHORTS, BOOTS, SLIPPERS, SHOES, SOCKS, SWEATERS, SWEATSHIRTS, JACKETS (U.S. CLS. 22 AND 39).

MICHAEL LEWIS, EXAMINING ATTORNEY

THE MARK CONSISTS OF STANDARD CHARACTERS WITHOUT CLAIM TO ANY PARTICULAR FONT, STYLE, SIZE, OR COLOR.

OWNER OF U.S. REG. NOS. 2,984,681 AND 3,026,567. NO CLAIM IS MADE TO THE EXCLUSIVE RIGHT TO USE "NY", APART FROM THE MARK AS SHOWN.

FOR CLOTHING, NAMELY, SHIRTS, COATS, PANTS, T-SHIRTS, BLOUSES, HATS, BELTS, SHOES, VESTS, JACKETS, UNDERWEAR, SOCKS, SWEATERS, SCARVES, SHORTS, SKIRTS, JEANS; CHILDREN'S AND INFANTS' CLOTHING, NAMELY, BIBS MADE FROM WOVEN POLYESTER FABRIC AND SYNTHETIC RUBBER, OVERALLS; WETSUITS, FOOTWEAR; SWEATSHIRTS; SWEAT SUITS; BATHING SUITS, NIGHTWEAR, NAMELY PAJAMAS; RAINWEAR (U.S. CLS. 22 AND 39).

FIRST USE 8-11-2005; IN COMMERCE 8-11-2005. JOHN DALIER, EXAMINING ATTORNEY

SN 78-702,057. ZOE LOU, INC., NEW YORK, NY. FILED 8-28-2005.

SN 78-705,393. SPILLER, GLENN, GLENDALE, NY. FILED 9-1-2005.



BE UNREASONABLE

THE MARK CONSISTS OF THE LETTER "I", A DIAMOND SYMBOL AND THE WORD "VEGAS".

FOR CLOTHING, NAMELY, SHIRTS, PANTS, SHORTS, UNDERGARMENTS, JACKETS, SKIRTS, DRESSES; FOOTWEAR FOR MEN AND WOMEN; HEADGEAR, NAMELY, HATS, CAPS, VISORS, BASEBALL HATS, AND HEAD BANDS (U.S. CLS. 22 AND 39).

FIRST USE 6-1-2004; IN COMMERCE 1-15-2005. ODESSA BIBBINS, EXAMINING ATTORNEY

THE MARK CONSISTS OF STANDARD CHARACTERS WITHOUT CLAIM TO ANY PARTICULAR FONT, STYLE, SIZE, OR COLOR.

FOR CLOTHING, NAMELY, PANTS, SHIRTS, SWEATSHIRTS, SWEATPANTS, SKIRTS, DRESSES, SOCKS, HATS, CAPS, TIES, T-SHIRTS, SCARVES, UNDERWEAR, PAJAMAS, COATS, JACKETS, GLOVES AND SHOES. (U.S. CLS. 22 AND 39).

COLLEEN DOMBROW, EXAMINING ATTORNEY

CLASS 25—(Continued).

SN 78-705,400. SPILLER, GLENN, GLENDALE, NY. FILED 9-1-2005.



THE MARK CONSISTS OF STYLIZED MAN.
FOR CLOTHING, NAMELY, PANTS, SHIRTS, SWEATSHIRTS, SWEATPANTS, SKIRTS, DRESSES, SOCKS, HATS, CAPS, TIES, T-SHIRTS, SCARVES, UNDERWEAR, PAJAMAS, COATS, JACKETS, GLOVES AND SHOES (U.S. CLS. 22 AND 39).
KEVON CHISOLM, EXAMINING ATTORNEY

SN 78-705,568. MEINEKE CAR CARE CENTERS, INC., CHARLOTTE, NC. FILED 9-1-2005.



OWNER OF U.S. REG. NOS. 1,207,490, 2,956,651 AND OTHERS.
FOR CLOTHING, NAMELY T-SHIRTS, KNIT SHIRTS, SPORT SHIRTS, SWEATSHIRTS, SWEATERS, JACKETS, SHORTS, SWEATPANTS, HATS, CAPS, AND SCARVES (U.S. CLS. 22 AND 39).
FIRST USE 5-0-2003; IN COMMERCE 5-0-2003.
ROBIN CHOSID, EXAMINING ATTORNEY

SN 78-707,200. K-PAK CLOTHING CORP., LOS ANGELES, CA. FILED 9-6-2005.

VELVET ROOM

THE MARK CONSISTS OF STANDARD CHARACTERS WITHOUT CLAIM TO ANY PARTICULAR FONT, STYLE, SIZE, OR COLOR.
FOR WOMEN'S TANK TOPS, SHIRTS, BLOUSES, SKIRTS, PANTS, SWEATERS, AND JACKETS (U.S. CLS. 22 AND 39).
TRACY CROSS, EXAMINING ATTORNEY

CLASS 25—(Continued).

SN 78-709,895. FINEGOLD, JAMIE A, CONCORD, CA. FILED 9-9-2005.



FOR CLOTHING, NAMELY SLEEPWEAR, JEANS, SHIRTS, SKIRTS, SHORTS, T-SHIRTS, TROUSERS, PANTS, SWEATERS, SWEATSHIRTS, SWEATPANTS AND LINGERIE (U.S. CLS. 22 AND 39).
LESLY LAMOTHE, EXAMINING ATTORNEY

SN 78-710,540. RIDENHOUR, DAVID CRAIG, TAMPA, FL. FILED 9-10-2005.



FOR SHIRTS, SHORTS, PANTS, SHOES, HATS, BATHING SUITS (U.S. CLS. 22 AND 39).
STEVEN JACKSON, EXAMINING ATTORNEY

SN 78-711,259. DEJA BLEU, LLC, SECAUCUS, NJ. FILED 9-12-2005.

UPTOWN BLEU

THE MARK CONSISTS OF STANDARD CHARACTERS WITHOUT CLAIM TO ANY PARTICULAR FONT, STYLE, SIZE, OR COLOR.
FOR BALLOON PANTS; CAPRI PANTS; DENIMS; JOGGING PANTS; PANTS; SWEAT PANTS; TAP PANTS (U.S. CLS. 22 AND 39).
FIRST USE 12-1-2003; IN COMMERCE 12-1-2003.
JAMES GRIFFIN, EXAMINING ATTORNEY

CLASS 25—(Continued).

SN 78-712,610. ENO SPORTS LTD, WANCHAI, HONG KONG, FILED 9-14-2005.

ENO

THE MARK CONSISTS OF STANDARD CHARACTERS WITHOUT CLAIM TO ANY PARTICULAR FONT, STYLE, SIZE, OR COLOR.

THE FOREIGN WORDING IN THE MARK TRANSLATES INTO ENGLISH AS "UNCLE".

FOR CLOTHING, NAMELY, SHIRTS, SWEATSHIRTS, SWEATERS, VESTS, JACKETS, COATS, TURTLENECKS, SHORTS, PANTS, SOCKS, UNDERWEAR, VISORS, HATS, HEADBANDS, EXERCISE CLOTHING, NAMELY, ATHLETIC SHORTS, ATHLETIC SHIRTS, YOGA PANTS, YOGA TANK TOPS, YOGA WARM UP JACKETS, CYCLING SHORTS, CYCLING SHIRTS, RUNNING SHIRTS, RUNNING SHORTS, RUNNING PANTS, TRAINING SHORTS, TRAINING PANTS, TRAINING SHIRTS, MARTIAL ARTS PANTS, MARTIAL ARTS SHIRTS, ATHLETIC BRAS, WARM-UP SUITS, SHOOTING SHIRT, BASKETBALL SHORTS, BASKETBALL SHIRTS, BASKETBALL TANK TOPS, GOLF PANTS, GOLF SHIRTS, GOLF WARM UP SUITS, TENNIS SHORTS, TENNIS SHIRTS, TENNIS WARM UP SUIT, UNITARDS, LEOTARDS, LEGGINGS, UNDERWEAR, COMPRESSION SHIRTS, COMPRESSION SHORTS, COMPRESSION PANTS, T-SHIRTS, TANK TOPS, SHORTS, PANTS, ATHLETIC UNIFORMS AND FOOTWEAR (U.S. CLS. 22 AND 39).

KEVON CHISOLM, EXAMINING ATTORNEY

SN 78-713,644. HALO SEVEN, INC., THOUSAND OAKS, CA. FILED 9-15-2005.

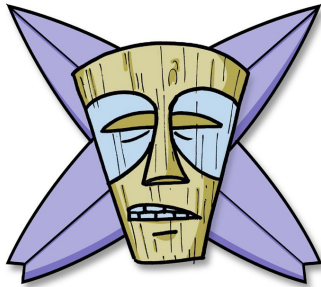

THE COLOR(S) BLUE, PURPLE, TAN AND BLACK IS/ ARE CLAIMED AS A FEATURE OF THE MARK.

THE MARK CONSISTS OF A TAN AND BLUE TIKI MASK IN FRONT OF TWO CROSSED PURPLE SURFBOARDS, ALL WITH BLACK OUTLINING.

FOR CLOTHING AND APPAREL, NAMELY, T-SHIRTS, LONG SLEEVE SHIRTS, SHORT SLEEVE SHIRTS, BASEBALL SHIRTS, TANK TOPS, AND POLO SHIRTS, ATHLETIC UNDERSHIRTS, THERMAL UNDERWEAR, SHORTS, SWIMSUITS, JACKETS, WIND BREAKERS, PULL OVERS, SWEATSHIRTS AND UNDERWEAR (U.S. CLS. 22 AND 39).

KYLE PEETE, EXAMINING ATTORNEY

CLASS 25—(Continued).

SN 78-714,497. SARA DEAN INC., SUGAR LAND, TX. FILED 9-16-2005.

Sara DEAN

THE COLOR(S) RED AND BLACK IS/ARE CLAIMED AS A FEATURE OF THE MARK.

THE DESIGN "SARA" IS RED, THE LETTERING "DEAN" IS BLACK.

FOR JACKETS, PANTS, SHIRTS, CAPS, GLOVES (U.S. CLS. 22 AND 39).

FIRST USE 4-1-2006; IN COMMERCE 4-1-2006.

DOMINIC J. FERRAIUOLO, EXAMINING ATTORNEY

SN 78-715,283. GLITZER, DAVID M., NEW YORK, NY. FILED 9-18-2005.

Coney Island Surf

THE MARK CONSISTS OF STANDARD CHARACTERS WITHOUT CLAIM TO ANY PARTICULAR FONT, STYLE, SIZE, OR COLOR.

NO CLAIM IS MADE TO THE EXCLUSIVE RIGHT TO USE "CONEY ISLAND", APART FROM THE MARK AS SHOWN.

FOR CLOTHING, NAMELY, SHIRTS, PANTS, HATS, SOCKS, SWIMWEAR, UNDERWEAR, JACKETS (U.S. CLS. 22 AND 39).

GRETТА YAO, EXAMINING ATTORNEY

SN 78-716,625. ROBINSON, KEITH, BOLINGBROOK, IL. FILED 9-20-2005.

URE

THE MARK CONSISTS OF STANDARD CHARACTERS WITHOUT CLAIM TO ANY PARTICULAR FONT, STYLE, SIZE, OR COLOR.

FOR CAP VISORS; CAPS; CAPS WITH VISORS; DENIM JACKETS; DENIM JEANS; DOWN JACKETS; KNITTED CAPS; PANTS; SHORT-SLEEVED OR LONG-SLEEVED T-SHIRTS; SPORTS JACKETS; SWEAT PANTS; SWEATERS; T-SHIRTS (U.S. CLS. 22 AND 39).

JENNIFER MCROBBIE, EXAMINING ATTORNEY

CLASS 25—(Continued).

SN 78-716,763. BAE, YOUNG YOUN, JUNGRANG-KU, SEOUL, REPUBLIC OF KOREA, FILED 9-20-2005.



THE COLOR(S) RED IS/ARE CLAIMED AS A FEATURE OF THE MARK.

THE COLOR RED APPEARS OVER THE ENTIRE MARK, BOTH WORDS AND DESIGN.

FOR CLOTHING AND CHILDREN'S CLOTHING, NAMELY, ALOHA SHIRTS, BELTS, BLOUSES, BLUE JEANS, BRASSIERES, BUSINESS SUITS, CARDIGANS, COATS, DRESSES, DRESS SHIRTS, GLOVES, JACKETS, JUMPERS, NECKTIES, PANTS, PARKAS, POLO SHIRTS, SCARVES, SHIRTS, SKIRTS, SOCKS, STOCKINGS, SUITS, SWEATERS, TROUSERS, T-SHIRTS, UNDERPANTS, UNDERWEAR, UNIFORMS, FOOTWEAR, HATS AND VISORS (U.S. CLS. 22 AND 39).

PETER B. BROMAGHIM, EXAMINING ATTORNEY

SN 78-719,799. VMC LLC, LAS VEGAS, NV. FILED 9-23-2005.



FOR MEN'S, WOMEN'S AND CHILDREN'S APPAREL AND CLOTHING OF ALL TYPES, NAMELY, JERSEYS, SWEATBANDS, JUMPSUITS, UNIFORMS, SPORTS PANTS, KNIT SHIRTS, SHIRTS, T-SHIRTS, POLO SHIRTS, TANK-TOPS, BLOUSES, SLACKS, JEANS, SHORTS, BELTS, UNDERWEAR, STOCKINGS, SOCKS, SWIMWEAR, NIGHTWEAR, LEOTARDS, LEGGINGS, COATS, TUXEDOS, JACKETS, PARKAS, OVERCOATS, PULLOVERS, SWEATSHIRTS AND SWEATERS; HEADWEAR AND FOOTWEAR (U.S. CLS. 22 AND 39).

FIRST USE 7-0-1995; IN COMMERCE 7-0-1995.
HANNO RITTNER, EXAMINING ATTORNEY

CLASS 25—(Continued).

SN 78-723,613. ROZIC, ANTHONY, CHICAGO HEIGHTS, IL. FILED 9-29-2005.

I'M BLUNT BUT I'M A GENTLEMAN

THE MARK CONSISTS OF STANDARD CHARACTERS WITHOUT CLAIM TO ANY PARTICULAR FONT, STYLE, SIZE, OR COLOR.

FOR CLOTHING, NAMELY T-SHIRTS (U.S. CLS. 22 AND 39).

BERYL GARDNER, EXAMINING ATTORNEY

SN 78-730,789. GIMENO, JUAN C., COLUMBUS, OH. FILED 10-11-2005.



THE MARK CONSISTS OF FOUR RECTANGLES AND TWO TRIANGLES WITH THE "OILSTYLE" LETTERS ABOVE THE PERSONAL SIGNATURE OF APPLICANT, "JUAN GIMENO".

FOR BALLOON PANTS; CAMP SHIRTS; CAPRI PANTS; CHEF'S HATS; DENIMS; DRESS SHIRTS; FUR HATS; GOLF SHIRTS; HAT BANDS; HATS; HEADGEAR, NAMELY, CAPS, VISORS; JOGGING PANTS; KNIT SHIRTS; LEATHER PANTS; MOCK TURTLE-NECK SWEATERS; NIGHT SHIRTS; NURSE PANTS; OPEN-NECKED SHIRTS; PANTS; PIQUET SHIRTS; POLO SHIRTS; SEDGE HATS; SHIRT FRONTS; SHIRTS; SHIRTS FOR SUITS; SHORT-SLEEVED OR LONG-SLEEVED T-SHIRTS; SHORT-SLEEVED SHIRTS; SKI PANTS; SLEEP SHIRTS; SMALL HATS; SNOW PANTS; SNOWBOARD PANTS; SPORT SHIRTS; SPORTS SHIRTS; SPORTS SHIRTS WITH SHORT SLEEVES; SWEAT PANTS; SWEAT SHIRTS; SWEATERS; T-SHIRTS; TRACK PANTS; TOBOGGAN HATS, PANTS AND CAPS; TRACK PANTS; TURTLENECK SWEATERS; V-NECK SWEATERS; WATERPROOF JACKETS AND PANTS; WIND SHIRTS; WOOLLY HATS (U.S. CLS. 22 AND 39).

KATRINA EDGE, EXAMINING ATTORNEY

SN 78-735,181. RAJ MANUFACTURING, INC., TUSTIN, CA. FILED 10-18-2005.

BEACH LINGO

THE MARK CONSISTS OF STANDARD CHARACTERS WITHOUT CLAIM TO ANY PARTICULAR FONT, STYLE, SIZE, OR COLOR.

FOR BATHING SUITS (U.S. CLS. 22 AND 39).

FIRST USE 7-1-1990; IN COMMERCE 7-1-1990.

PAM WILLIS, EXAMINING ATTORNEY

CLASS 25—(Continued).

SN 78-743,526. WILFONG, CHRIS D, FORT GIBSON, OK, AND WILFONG, ELLEN M, FORT GIBSON, OK. FILED 10-31-2005.

MAKE GOD FAMOUS

THE MARK CONSISTS OF STANDARD CHARACTERS WITHOUT CLAIM TO ANY PARTICULAR FONT, STYLE, SIZE, OR COLOR.

FOR T-SHIRTS, WRISTBANDS, WOOLLY HATS, WOMEN'S SHOES, WIND-JACKETS, WIND COATS, WARM UP SUITS, WAISTBANDS, VISORS, UNIFORMS, UNDERSHIRTS, UNDERPANTS, UNDERCLOTHES, TURTLENECK SWEATERS, TROUSERS, TRAINING SUITS, TRACK PANTS, TRACK SUITS, TOPCOATS, TIGHTS, THONGS IN THE NATURE OF FOOTWEAR, TENNIS SHOES, TANK TOPS, SWIMSUITS, SWIMMING CAPS, SWIMMING TRUNKS, SWEATERS, SWEATBANDS, SWEAT SHIRTS, SWEAT SHORTS, SUNSUITS, STOCKINGS, SPORT SHIRTS, SPORT COATS, SOCKS, SOCCER SHOES, SNEAKERS, SMALL HATS, SLIPPERS, SLEEP WEAR, SLEEVED OR SLEEVELESS JACKETS, SKORTS, SHIRTS, SKI WEAR, SHORT-SLEEVED SHIRTS, SHORT-SLEEVED OR LONG-SLEEVED T-SHIRTS, SHORTS, SHOES, SCHOOL UNIFORMS, SANDALS, ROBES, RAINWEAR, PONCHOS, POLO SHIRTS, PLAY SUITS, PEDAL PUSHERS, NIGHTWEAR, NECKTIES, MITTENS, MINISKIRTS, LONG JACKETS, LEG WARMERS, LEATHER SHOES, LADIES' SUITS, LEATHER HEADWEAR, KNIT SHIRTS, KNITTED CAPS, KERCHIEFS, JUMPERS, JOGGING OUTFITS, JERSEYS CLOTHING, JEANS, JACKETS, INFANTWEAR, HOODS, HOODED SWEATSHIRTS, HEADWEAR, HEADBANDS, HEAD SWEATBANDS, HATS, GYM SUITS, GOLF SHIRTS, GOLF SHOES, GOLF CAPS, GLOVES, FOOTWEAR NOT FOR SPORTS, FOOTWEAR, FLIP FLOPS, FLEECE SHORTS, FLEECE PULLOVERS, DRESSES, DO RAGS, DENIM JACKETS, COVERALLS, COATS, CHILDREN'S HEADWEAR, CAPS WITH VISORS, CAPS, CAMP SHIRTS, CANVAS SHOES, BOOTS, BLOUSES, BERMUDA SHORTS, BELTS, BEANIES, BEACHWEAR, BATHING SUITS, BASEBALL CAPS, BANDANAS, ATHLETIC UNIFORMS, ATHLETIC FOOTWEAR, ANKLETS SOCKS (U.S. CLS. 22 AND 39).

FIRST USE 10-28-2005; IN COMMERCE 10-28-2005.
ALAIN LAPTEK, EXAMINING ATTORNEY

SN 78-743,981. LE CIRQUE CORPORATION, COLUMBIA, SC. FILED 10-31-2005.



"THE FOREIGN WORDING IN THE MARK TRANSLATES INTO ENGLISH AS THE CIRCUS."

FOR CHILDRENS' CLOTHING NAMELY, DRESSES, OVERALLS, SHIRTS, AND ONE PIECE PLAYSUITS (U.S. CLS. 22 AND 39).

FIRST USE 4-16-2004; IN COMMERCE 4-16-2004.
LINDA E. BLOHM, EXAMINING ATTORNEY

CLASS 25—(Continued).

SN 78-744,353. PAIVA, INC., INDIANAPOLIS, IN. FILED 11-1-2005.

IN:EX

THE MARK CONSISTS OF STANDARD CHARACTERS WITHOUT CLAIM TO ANY PARTICULAR FONT, STYLE, SIZE, OR COLOR.

FOR WOMEN'S CLOTHING, NAMELY, SHIRTS, BLOUSES, SWEATERS, PANTS, SHORTS, SKIRTS, DRESSES, SCARVES, HATS, SWIM SUITS, SWEATSHIRTS, SOCKS, TIGHTS, TOPS, SPORT BRAS, UNDERWEAR, BRAS, AND GLOVES; HEAD WEAR, AND FOOTWEAR (U.S. CLS. 22 AND 39).

ELIZABETH J. WINTER, EXAMINING ATTORNEY

SN 78-747,968. UNIVERSITY OF KENTUCKY, LEXINGTON, KY. FILED 11-5-2005.

UK

THE MARK CONSISTS OF STANDARD CHARACTERS WITHOUT CLAIM TO ANY PARTICULAR FONT, STYLE, SIZE, OR COLOR.

OWNER OF U.S. REG. NOS. 1,467,677, 2,806,593 AND OTHERS.

FOR CLOTHING, NAMELY, T-SHIRTS, SWEATSHIRTS, SWEATPANTS, SWEATSUITS, SWIM SUITS, SUSPENDERS, GYM SHORTS, HATS, JACKETS, JOGGING SUITS, SHOES, SANDALS, SHORTS, SOCKS, TANKTOPS, TURTLENECKS, V-NECK SWEATERS, INFANTWEAR, BABY SHOES, BABY SOCKS, SCARVES, SPORT COATS, AND LEATHER JACKETS, NECKTIES, SPORTSHIRTS, POLO SHIRTS, ATHLETIC JERSEYS AND SHORTS, CLOTH BABY BIBS, HOODED SWEATSHIRTS, RUGBY SHIRTS, MUFFLERS, ATHLETIC TRAINING SUITS, PARKAS, PONCHOS, RAINWEAR, EARMUFFS, BOXER SHORTS, AND APRONS; CHILDREN'S CLOTHING, NAMELY, SHIRTS, SHORTS, PANTS, SOCKS, SWEATSHIRTS, SWEATPANTS, ATHLETIC JERSEYS, HATS AND T-SHIRTS (U.S. CLS. 22 AND 39).

FIRST USE 12-31-1986; IN COMMERCE 12-31-1986.
SUNG IN, EXAMINING ATTORNEY

CLASS 25—(Continued).

SN 78-755,769. 12 METER YACHT CHARTERS LLC, WESTON, MA. FILED 11-17-2005.

US 16

THE MARK CONSISTS OF STANDARD CHARACTERS WITHOUT CLAIM TO ANY PARTICULAR FONT, STYLE, SIZE, OR COLOR.

NO CLAIM IS MADE TO THE EXCLUSIVE RIGHT TO USE "US", APART FROM THE MARK AS SHOWN.

FOR CLOTHING, NAMELY, CASUAL WEAR, NAMELY, TOPS, SHORTS, PANTS, T-SHIRTS, SWEAT-SHIRTS; SPORTSWEAR, NAMELY, SHORTS, PANTS, FITNESS TOPS, JOGGING SUITS, SOCKS, JACKETS; ACTIVE WEAR, NAMELY, SWEAT PANTS, BIKE SHORTS, SPANDEX SHORTS AND TOPS; SWIMWEAR; OUTERWEAR, NAMELY, JACKETS, HATS, GLOVES, COATS, RAINWEAR; HOSIERY, BOTH SHEER AND CASUAL; BELTS; NECKWEAR (U.S. CLS. 22 AND 39).

FIRST USE 6-1-2000; IN COMMERCE 6-1-2000.
ANGELA M. MICHELI, EXAMINING ATTORNEY

SN 78-756,187. SILVERTHORNE, ANDREA K., MIAMI BEACH, FL. FILED 11-17-2005.

33139

THE MARK CONSISTS OF STANDARD CHARACTERS WITHOUT CLAIM TO ANY PARTICULAR FONT, STYLE, SIZE, OR COLOR.

FOR APRONS, ASCOTS, BABY BIBS, NAMELY, CLOTH BABY BIBS, BABY BUNTING, BANDANAS, BATHING CAPS, BATHING SUITS, BATHROBES, BEACH COVER-UPS, BEACHWEAR BEANIES, BELTS, OVERALLS, BIKINIS, BLAZERS, BLOOMERS, BLOUSES, BODY SUITS, BONNETS, BOOTS, BOW TIES, BRAS, BRASSIERES, BRIEFS, BUSTIERS, CAMISOLES, CAPRIS, CAPS, CARDIGANS, CHAPS, FUR CLOAKS, COATS, COLLARS, CORSELETS, COVERALLS, CLOTH DIAPERS, DRESSES, DUNGAREES, FLIP FLOPS, FOOTWEAR, GARTERS, NAMELY, ANKLE GARTERS, GARTER BELTS, GLOVES, GOWNS, HATS, HEAD WEAR, HOSIERY, JACKETS, JEANS, JUMPSUITS, LAB COATS, LEOTARDS, LINGERIE, LOUNGEWEAR, MINISKIRTS, MITTENS, MONEY BELTS, MUFFLERS, NECKTIES, NIGHTWEAR, OVERALLS, OVERCOATS, PAJAMAS, PANTIES, PANTS, PANTSUITS, PANTYHOSE, PETTI-COATS, POLO SHIRTS, PONCHOS, PULLOVERS, RAINCOATS, RAINWEAR, ROBES, ROMPERS, SANDALS, SARIS, SARONGS, SASHERS, SCARVES, SHIRTS, SHOES, SHORTS, SHOULDER WRAPS, SHOWER CAPS, SILK SCARVES, SKI WEAR, SKIRTS, SKORTS, SLACKS, SLEEPWEAR, SLIPPERS, SLIPS, SMOCKS, SNEAKERS, SOCKS, STOCKINGS, SUIT COATS, SUITS, SUN VISORS, SUNSUITS, SUSPENDERS, SWEAT PANTS, SWEAT SHIRTS, SWEAT SHORTS, SWEAT SUITS, SWEATBANDS, SWEATERS, SWEATSOCKS, SWIM WEAR, SWIMSUITS, TANK-TOPS, TEDDIES THONGS, TIES, TIGHTS, TOPCOATS, TRENCH COATS, TROUSERS, TRUNKS, T-SHIRTS, TUXEDOS, UNDER GARMENTS, UNDERPANTS, UNDERSHIRTS, UNDERSKIRTS, UNDERWEAR, UNIFORMS, VEILS, VESTS, VISORS, WAIST BELTS, WRAP-AROUNDS, WRAPS, WRISTBANDS (U.S. CLS. 22 AND 39).

MICHAEL LEWIS, EXAMINING ATTORNEY

CLASS 25—(Continued).

SN 78-759,427. COLEMAN, TROY, ATLANTA, GA. FILED 11-22-2005.

HICK CHICK

THE MARK CONSISTS OF STANDARD CHARACTERS WITHOUT CLAIM TO ANY PARTICULAR FONT, STYLE, SIZE, OR COLOR.

FOR SHIRTS, T-SHIRTS (U.S. CLS. 22 AND 39).
FIRST USE 3-0-2002; IN COMMERCE 3-0-2002.
ELIZABETH J. WINTER, EXAMINING ATTORNEY

SN 78-759,431. COLEMAN, TROY, ATLANTA, GA. FILED 11-22-2005.

THE FLESH & DENIM CLOTHING CO.

THE MARK CONSISTS OF STANDARD CHARACTERS WITHOUT CLAIM TO ANY PARTICULAR FONT, STYLE, SIZE, OR COLOR.

NO CLAIM IS MADE TO THE EXCLUSIVE RIGHT TO USE "& DENIM CLOTHING CO.", APART FROM THE MARK AS SHOWN.

FOR SHIRTS, T-SHIRTS (U.S. CLS. 22 AND 39).
FIRST USE 10-0-2005; IN COMMERCE 10-0-2005.
ELIZABETH J. WINTER, EXAMINING ATTORNEY

SN 78-760,195. BUILT NY, INC., NEW YORK, NY. FILED 11-23-2005.

BUILT

THE MARK CONSISTS OF STANDARD CHARACTERS WITHOUT CLAIM TO ANY PARTICULAR FONT, STYLE, SIZE, OR COLOR.

OWNER OF U.S. REG. NOS. 2,984,681 AND 3,026,567.
FOR T-SHIRTS, CHILDREN'S AND INFANTS' CLOTHING, NAMELY, BIBS MADE FROM WOVEN POLYESTER FABRIC AND SYNTHETIC RUBBER (U.S. CLS. 22 AND 39).

FIRST USE 8-11-2005; IN COMMERCE 8-11-2005.
JOHN DALIER, EXAMINING ATTORNEY

CLASS 25—(Continued).

SN 78-768,198. FRUHAUF UNIFORMS, INC., WICHITA, KS. FILED 12-7-2005.

CLASS 25—(Continued).

SN 78-781,180. CLUGSTON, MICHAEL, M., RED LODGE, MT. FILED 12-27-2005.

Free Your Face

BORN ON THE LINE

THE MARK CONSISTS OF STANDARD CHARACTERS WITHOUT CLAIM TO ANY PARTICULAR FONT, STYLE, SIZE, OR COLOR.
FOR MARCHING BAND UNIFORMS (U.S. CLS. 22 AND 39).
FIRST USE 6-1-2004; IN COMMERCE 6-1-2004.
ELIZABETH PIGNATELLO, EXAMINING ATTORNEY

THE MARK CONSISTS OF STANDARD CHARACTERS WITHOUT CLAIM TO ANY PARTICULAR FONT, STYLE, SIZE, OR COLOR.

FOR CLOTHING FOR FORMAL DRESS, CASUAL DRESS, SPORTS, AND RECREATION USE, NAMELY, PANTS, SHIRTS, JACKETS, SWEATERS, CAPS, SWEAT PANTS, SWEAT SUITS, SWEAT SHORTS, SWEAT SHIRTS, SWEAT BANDS, SWIM WEAR, SWIM SUITS, T-SHIRTS, BASEBALL CAPS, BATHING SUITS, BOARD SHORTS, HEAD SWEATBANDS, HEADBANDS, TANK TOPS, JEANS, JERSEYS, TENNIS SHOES, TENNIS WEAR, JOGGING OUTFITS, JOGGING PANTS, JOGGING SUITS, SPORTS JERSEYS, SPORTS SHIRTS, KNITTED CAPS, NECKTIES, VESTS, VISORS, WALKING SHORTS, SPORT SHIRTS, SURF WEAR, UNDERSHIRTS, MEN'S AND WOMEN'S JACKETS, COATS, TROUSERS, POLO SHIRTS, PULLOVERS, ROBES, SKULLCAPS, WIND JACKETS, RUNNING SHOES, SHORTS, SNEAKERS, SNOW BOARDING SUITS, SOCKS, SKI GLOVES, SKI JACKETS, SKI PANTS, SKI SUITS, AND SKI WEAR (U.S. CLS. 22 AND 39).
HANNO RITTNER, EXAMINING ATTORNEY

SN 78-772,711. HUNTER, ERIC, GRANADA HILLS, CA. AND HILL, ROBERT, GRANADA HILLS, CA. FILED 12-13-2005.

SN 78-781,539. RICHARDS, DOYIN, LOS ANGELES, CA. FILED 12-28-2005.

HUNTERHILL



TEULI MOJA

THE MARK CONSISTS OF STANDARD CHARACTERS WITHOUT CLAIM TO ANY PARTICULAR FONT, STYLE, SIZE, OR COLOR.
FOR BELTS; CAPS; COATS FOR MEN AND WOMEN; DRESSES; FOOTWEAR FOR MEN AND WOMEN; HATS; INFANT AND TODDLER ONE PIECE CLOTHING; JERSEYS; LEATHER BELTS; MEN AND WOMEN JACKETS, COATS, TROUSERS, VESTS; MEN'S SUITS, WOMEN'S SUITS; PANTS; SHIRTS; SHOES; SUITS; T-SHIRTS; TIES; TOPS; UNDERWEAR; WOMEN'S SHOES; WOMEN'S UNDERWEAR (U.S. CLS. 22 AND 39).
GINA HAYES, EXAMINING ATTORNEY

THE MARK CONSISTS OF THE STYLIZED LETTERS TM WITH A STAR DESIGN OVER THE RIGHT SIDE OF THE LETTER DESIGN.
THE ENGLISH TRANSLATION OF THE SWAHILI WORDS TEULI MOJA IN THE MARK IS "CHOSEN ONE".
FOR MEN'S, WOMEN'S, AND CHILDREN'S CLOTHING AND APPAREL, NAMELY T-SHIRTS, SWEATSHIRTS, DRESSES, AND TANK TOPS (U.S. CLS. 22 AND 39).
HENRY S. ZAK, EXAMINING ATTORNEY

CLASS 25—(Continued).

SN 78-781,682. WOLF, ALBERT, SAN DIMAS, CA. FILED 12-28-2005.

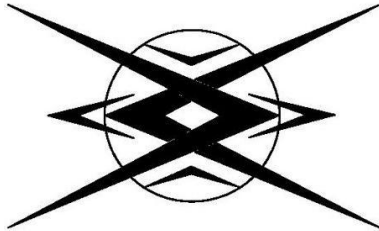

FOR CLOTHING, NAMELY, ATHLETIC FOOTWEAR, BATHROBES, BEACHWEAR, BELTS, BLAZERS, BLOUSES, COATS, DRESSES, HATS, JACKETS, JEANS, PAJAMAS, PANTIES, PANTS, SHIRTS, SHORTS, SLEEPWEAR, SOCKS, SWEATERS, SWIMSUITS, TROUSERS, AND UNDERGARMENTS (U.S. CLS. 22 AND 39).
DAHLIA GEORGE, EXAMINING ATTORNEY

SN 78-783,919. WRIGHT-TUBBS, JENNIFER, PEORIA, IL. FILED 1-3-2006.

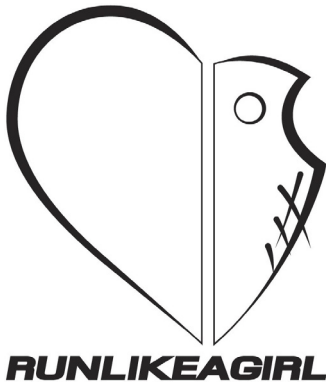

THE MARK CONSISTS OF A HEART-SHAPED DESIGN, DIVIDED VERTICALLY DOWN THE MIDDLE, WITH THE LEFT HALF CONSISTING OF THE LEFT-HALF OF A HEART AND THE RIGHT HALF CONSISTING OF THE SIDE VIEW OF A RUNNING SHOE WITH THE HEEL AT THE TOP AND THE TOE AT THE BOTTOM; TOGETHER WITH THE WORD "RUNLIKEAGIRL".
FOR SPORTS ATTIRE, NAMELY, SHIRTS, HATS, SHORTS, PANTS AND SHOES (U.S. CLS. 22 AND 39).
FIRST USE 3-10-2006; IN COMMERCE 3-10-2006.
SONYA STEPHENS, EXAMINING ATTORNEY

CLASS 25—(Continued).

SN 78-788,460. VELVET, INC., CULVER CITY, CA. FILED 1-10-2006.

GRAHAM & SPENCER

THE MARK CONSISTS OF STANDARD CHARACTERS WITHOUT CLAIM TO ANY PARTICULAR FONT, STYLE, SIZE, OR COLOR.

THE NAME(S), PORTRAIT(S), AND/OR SIGNATURE(S) SHOWN IN THE MARK IDENTIFIES LIVING INDIVIDUALS, WHOSE CONSENT(S) TO REGISTER IS SUBMITTED.

FOR CLOTHING, NAMELY, SHIRTS, PANTS, T-SHIRTS, FOOTWEAR, HEADWEAR, BASEBALL CAPS, SHORTS, SWIMWEAR, LINGERIE, SWEAT SHIRTS, UNDERWEAR, JACKETS, COATS, DRESSES, SKIRTS, BELTS, SOCKS, SCARVES AND GLOVES (U.S. CLS. 22 AND 39).

FIRST USE 12-0-2005; IN COMMERCE 7-0-2006.
ATTIYA MALIK, EXAMINING ATTORNEY

SN 78-798,158. NORTHEAST RALLY GEAR - V, L.L.C, BRYN MAWR, PA. FILED 1-24-2006.

Rally Scarf

THE MARK CONSISTS OF STANDARD CHARACTERS WITHOUT CLAIM TO ANY PARTICULAR FONT, STYLE, SIZE, OR COLOR.

NO CLAIM IS MADE TO THE EXCLUSIVE RIGHT TO USE "SCARF", APART FROM THE MARK AS SHOWN.
FOR SCARVES (U.S. CLS. 22 AND 39).
ELI HELLMAN, EXAMINING ATTORNEY

CLASS 25—(Continued).

SN 78-799,377. MARTIN KSOHOH INC, NEW YORK, NY.
FILED 1-25-2006.

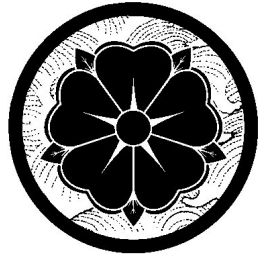

赤**AKASARU**猿

THE ENGLISH TRANSLATION OF THE JAPANESE WORD "AKASARU" IN THE MARK IS "NAKED GORILLA".

THE TWO CHINESE CHARACTERS IN THE MARK TRANSLITERATE TO "CHI YUAN" AND THIS MEANS "NAKED GORILLA" IN ENGLISH.

FOR APPAREL, NAMELY BOTTOMS, NAMELY, JEANS, PANTS, SHORTS; TOPS, NAMELY, SHIRTS, BLOUSES, VESTS, SINGLETS, TURTLENECKS, POLO SHIRTS, TEE SHIRTS, SWEATSHIRTS; OUTERWEAR, NAMELY, COATS, JACKETS, PARKAS; HEADWEAR, NAMELY, HATS, CAPS, VISORS; BELTS, SKIRTS, DRESSES, SUITS, OVERALLS AND FOOTWEAR IN ADULT, CHILDREN'S AND INFANTS' SIZES (U.S. CLS. 22 AND 39).

WOODROW HARTZOG, EXAMINING ATTORNEY

CLASS 25—(Continued).

SN 78-810,297. PLATTEIS, LILOUDMILA, TAMPA, FL. FILED
2-8-2006.

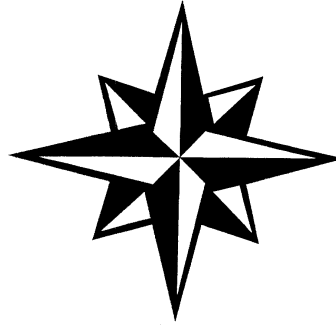

THE APPLICANT CLAIMS COLOR AS A FEATURE OF THE MARK, NAMELY, BLACK AND WHITE.

THE MARK CONSISTS OF NAVIGATION ICON.

FOR ANKLE SOCKS; BASEBALL CAPS; CAMP SHIRTS; CAP VISORS; CAPS; DRESS SHIRTS; DRESSES; GOLF SHIRTS; HATS; JEANS; JOGGING PANTS; KNIT SHIRTS; LEG WARMERS; LEGGINGS; NIGHT SHIRTS; OPEN-NECKED SHIRTS; PANTS; PIQUET SHIRTS; POLO SHIRTS; ROBES; SHIRT FRONTS; SHIRTS; SHIRTS FOR SUITS; SHORT-SLEEVED OR LONG-SLEEVED T-SHIRTS; SHORT-SLEEVED SHIRTS; SKIRTS; SOCKS; SPORT SHIRTS; SPORTS SHIRTS; SPORTS SHIRTS WITH SHORT SLEEVES; SWEAT SHIRTS; T-SHIRTS; TRACK PANTS; UNDERWEAR; WATERPROOF JACKETS AND PANTS; WIND SHIRTS (U.S. CLS. 22 AND 39).

SUZANNE BLANE, EXAMINING ATTORNEY

SN 78-799,378. MARTIN KSOHOH INC, NEW YORK, NY.
FILED 1-25-2006.

AKASARU PREMIUM

THE MARK CONSISTS OF STANDARD CHARACTERS WITHOUT CLAIM TO ANY PARTICULAR FONT, STYLE, SIZE, OR COLOR.

NO CLAIM IS MADE TO THE EXCLUSIVE RIGHT TO USE "PREMIUM", APART FROM THE MARK AS SHOWN.

THE ENGLISH TRANSLATION OF THE WORD AKASARU IN THE MARK IS NAKED GORILLA.

FOR APPAREL NAMELY BOTTOMS, NAMELY, JEANS, PANTS, SHORTS; TOPS, NAMELY, SHIRTS, BLOUSES, VESTS, SINGLETS, TURTLENECKS, POLO SHIRTS, TEE SHIRTS, SWEATSHIRTS; OUTERWEAR, NAMELY, COATS, JACKETS, PARKAS; HEADWEAR, NAMELY, HATS, CAPS, VISORS; BELTS, SKIRTS, DRESSES, SUITS, OVERALLS AND FOOTWEAR IN ADULT, CHILDREN'S AND INFANTS' SIZES (U.S. CLS. 22 AND 39).

WOODROW HARTZOG, EXAMINING ATTORNEY

SN 78-817,910. MOVIE STAR, INC., NEW YORK, NY. FILED
2-17-2006.

CINEMA STUDIO

THE MARK CONSISTS OF STANDARD CHARACTERS WITHOUT CLAIM TO ANY PARTICULAR FONT, STYLE, SIZE, OR COLOR.

OWNER OF U.S. REG. NO. 1,209,847.

FOR WOMEN'S SLEEPWEAR, PAJAMAS, NIGHT-GOWNS, NIGHT SHIRTS, DORM SHIRTS, ROBES, BABYDOLL PAJAMAS, CHEMISES, NEGLIGEEES, AND SEDUCTIVE WEAR, NAMELY, THONGS, GARTER BELTS, GARTERS, TEDDIES, BRASSIERES, BRALLETTES IN THE NATURE OF BRASSIERES OF SMALLER DESIGN, PANTIES, BUSTIERS, BABYDOLL PAJAMA SETS COMPRISED OF TOPS AND PANTIES, AND TWO PIECE PAJAMA SETS COMPRISED OF TOPS AND SHORTS (U.S. CLS. 22 AND 39).

PAUL CROWLEY, EXAMINING ATTORNEY

CLASS 25—(Continued).

SN 78-820,435. VAGIN POUVOIR INC., NEW YORK, NY. FILED 2-22-2006.



THE MARK CONSISTS, IN PART, OF A DESIGN COMPRISED OF ONE STYLIZED AND INTEGRATED "VP" INVERTED ON TOP OF ANOTHER STYLIZED AND INTEGRATED "VP".

THE ENGLISH TRANSLATION OF THE FOREIGN WORDING "VAGIN POUVOIR" IS "VAGINA POWER".

FOR WOMEN'S APPAREL, NAMELY, HOSE, LINGERIE, LINGERIE FOR DAYTIME, ROBES, BODY-SUITS, GYMWEAR, NAMELY, GYM SUITS, GYM SHORTS, LEOTARDS, SPORTS BRAS; SWIMWEAR, BLOUSES, SHIRTS, T-SHIRTS, TOPS, PANTS, LEGGINGS, SKIRTS, SHORTS, SHAWLS, WRAP AROUNDS, DRESSES, LOUNGEWEAR, CHEMISES, JACKETS, AND OVERALLS (U.S. CLS. 22 AND 39).

FIRST USE 2-1-2004; IN COMMERCE 6-1-2005. JEFFERY COWARD, EXAMINING ATTORNEY

CLASS 25—(Continued).

SN 78-821,581. L'S WEAR NY, INC., CENTERPORT, NY. FILED 2-23-2006.

TECKEL

THE MARK CONSISTS OF STANDARD CHARACTERS WITHOUT CLAIM TO ANY PARTICULAR FONT, STYLE, SIZE, OR COLOR.

THE ENGLISH TRANSLATION OF TECKEL IS "DACHSHUND".

FOR CAPS; DRESSES; FOOTWEAR; HATS; HOSE; JACKETS; PANTS; SCARVES; SHIRTS; SHORTS; SOCKS; T-SHIRTS; UNDERWEAR (U.S. CLS. 22 AND 39).

FIRST USE 2-23-2006; IN COMMERCE 2-23-2006. JOHN SCHUYLER YARD, EXAMINING ATTORNEY

SN 78-823,048. SIBERIAN CONSULTING, LLC, PORTSMOUTH, NH. FILED 2-24-2006.

THE SECRET OF SECRETS

THE MARK CONSISTS OF STANDARD CHARACTERS WITHOUT CLAIM TO ANY PARTICULAR FONT, STYLE, SIZE, OR COLOR.

FOR CLOTHING, NAMELY, CAPS, T-SHIRTS, JACKETS, SWEATSHIRTS, SHIRTS, NECKTIES, PANTS, SWEATERS, BANDANAS, SWEATBANDS, AND SCARVES (U.S. CLS. 22 AND 39).

MATTHEW PAPPAS, EXAMINING ATTORNEY

SN 78-821,580. NX, INC., FAIRFAX, VA. FILED 2-23-2006.

ARCTIC GEAR

THE MARK CONSISTS OF STANDARD CHARACTERS WITHOUT CLAIM TO ANY PARTICULAR FONT, STYLE, SIZE, OR COLOR.

NO CLAIM IS MADE TO THE EXCLUSIVE RIGHT TO USE "GEAR", APART FROM THE MARK AS SHOWN.

FOR GIRDLES; GLOVES; HATS; HEADBANDS; HEADWEAR; JACKETS; JERSEYS; LEGGINGS; PANTS; PERSPIRATION ABSORBENT UNDERWEAR CLOTHING; RAIN SUITS; SHIRTS; SHOES; SKIRTS; SKULL CAPS; SOCKS; SWEAT BANDS; SWEAT PANTS; SWEAT SHIRTS; TURTLENECKS; UNDERGARMENTS; UNDERWEAR; VESTS; WRISTBANDS (U.S. CLS. 22 AND 39).

FIRST USE 12-10-2005; IN COMMERCE 12-10-2005. HOWARD B. LEVINE, EXAMINING ATTORNEY



ONE SCOTTSDALE

NO CLAIM IS MADE TO THE EXCLUSIVE RIGHT TO USE "SCOTTSDALE", APART FROM THE MARK AS SHOWN.

FOR CLOTHING, NAMELY, T-SHIRTS, SPORT SHIRTS, JACKETS, HATS, SWEATERS, FOOTWEAR, SHORTS, PANTS, WARM UP SUITS, HEADBANDS AND WRIST BANDS (U.S. CLS. 22 AND 39).

CAROLYN CATALDO, EXAMINING ATTORNEY

CLASS 25—(Continued).

SN 78-823,942. ONE SCOTTSDALE HOLDINGS LLC,
SCOTTSDALE, AZ. FILED 2-27-2006.

ONE SCOTTSDALE

THE MARK CONSISTS OF STANDARD CHARACTERS
WITHOUT CLAIM TO ANY PARTICULAR FONT, STYLE,
SIZE, OR COLOR.

NO CLAIM IS MADE TO THE EXCLUSIVE RIGHT TO
USE "SCOTTSDALE", APART FROM THE MARK AS
SHOWN.

FOR CLOTHING, NAMELY, T-SHIRTS, SPORT
SHIRTS, JACKETS, HATS, SWEATERS, FOOTWEAR,
SHORTS, PANTS, WARM UP SUITS, HEADBANDS
AND WRIST BANDS (U.S. CLS. 22 AND 39).

CAROLYN CATALDO, EXAMINING ATTORNEY

SN 78-827,856. LOPEZ, TANYA, SARASOTA, FL. AND
CAPRIOLA, JONATHAN, SARASOTA, FL. FILED 3-2-
2006.

LASER HATS

THE MARK CONSISTS OF STANDARD CHARACTERS
WITHOUT CLAIM TO ANY PARTICULAR FONT, STYLE,
SIZE, OR COLOR.

NO CLAIM IS MADE TO THE EXCLUSIVE RIGHT TO
USE "HATS", APART FROM THE MARK AS SHOWN.

FOR HATS (U.S. CLS. 22 AND 39).

GIANCARLO CASTRO, EXAMINING ATTORNEY

SN 78-828,430. FUTURE PARADISE INC., NEW YORK, NY.
FILED 3-3-2006.

**NEAR FUTURE BY FUTURE
PARADISE**

THE MARK CONSISTS OF STANDARD CHARACTERS
WITHOUT CLAIM TO ANY PARTICULAR FONT, STYLE,
SIZE, OR COLOR.

OWNER OF U.S. REG. NO. 3,045,090.

FOR CLOTHING, NAMELY, SKIRTS, SASHES, BELTS,
SCARVES, DRESSES, SWEATERS, T-SHIRTS, PANTS,
LINGERIE, SHORTS, SHIRTS, BLOUSES, JACKETS
AND COATS; KNITS, NAMELY, SWEATERS, BLOUSES,
CARDIGANS AND PULLOVERS (U.S. CLS. 22 AND 39).

DAWN HAN, EXAMINING ATTORNEY

CLASS 25—(Continued).

SN 78-830,264. FORTUNE FASHIONS INDUSTRIES, LLC,
VERNON, CA. FILED 3-6-2006.

STAGE DIVE

THE MARK CONSISTS OF STANDARD CHARACTERS
WITHOUT CLAIM TO ANY PARTICULAR FONT, STYLE,
SIZE, OR COLOR.

FOR TOPS, NAMELY T-SHIRTS, AND SHIRTS (U.S.
CLS. 22 AND 39).

FIRST USE 3-27-2006; IN COMMERCE 3-27-2006.

YONG KIM, EXAMINING ATTORNEY

SN 78-830,274. FORTUNE FASHIONS INDUSTRIES, LLC,
VERNON, CA. FILED 3-6-2006.

ELECTRIC VINYL

THE MARK CONSISTS OF STANDARD CHARACTERS
WITHOUT CLAIM TO ANY PARTICULAR FONT, STYLE,
SIZE, OR COLOR.

FOR TOPS NOT OF VINYL, NAMELY, T-SHIRTS AND
SHIRTS (U.S. CLS. 22 AND 39).

FIRST USE 5-12-2006; IN COMMERCE 5-12-2006.

YONG KIM, EXAMINING ATTORNEY

SN 78-836,107. KOTOB, AHMED, SANTA FE SPRINGS, CA.
FILED 3-13-2006.

REDNECK JEANS

THE MARK CONSISTS OF STANDARD CHARACTERS
WITHOUT CLAIM TO ANY PARTICULAR FONT, STYLE,
SIZE, OR COLOR.

NO CLAIM IS MADE TO THE EXCLUSIVE RIGHT TO
USE "JEANS", APART FROM THE MARK AS SHOWN.

FOR CLOTHING, NAMELY, SHIRTS, T-SHIRTS, KNIT
SHIRTS, DENIMS, PANTS, SHORTS, SOCKS, HATS,
SWEATSHIRTS, SWEATERS, COATS AND JACKETS
(U.S. CLS. 22 AND 39).

FIRST USE 5-12-2005; IN COMMERCE 5-12-2005.

CHRISTOPHER OTT, EXAMINING ATTORNEY

CLASS 25—(Continued).

SN 78-838,657. WILLIAMS, DURMAINE S, MOUNT VERNON, TX. AND WILLIAMS, DEBBIE L, MOUNT VERNON, TX. FILED 3-16-2006.

SOULJA LEAGUE

THE MARK CONSISTS OF STANDARD CHARACTERS WITHOUT CLAIM TO ANY PARTICULAR FONT, STYLE, SIZE, OR COLOR.

FOR CAPRI PANTS; DENIM JACKETS; DENIMS; HATS; HEADGEAR, NAMELY, SUN VISOR, BASEBALL CAPS, SWEAT BANDS; JACKETS; LEATHER JACKETS; MEN AND WOMEN JACKETS, COATS, MEN'S SOCKS; OPEN-NECKED SHIRTS; PANTS; POLO SHIRTS; SHIRTS; SHORT-SLEEVED OR LONG-SLEEVED T-SHIRTS; SHORT-SLEEVED SHIRTS; SKIRTS; SKIRTS AND DRESSES; SOCKS; SOCKS AND T-SHIRTS (U.S. CLS. 22 AND 39).

FIRST USE 4-5-2006; IN COMMERCE 5-20-2006.
ELI HELLMAN, EXAMINING ATTORNEY

SN 78-840,622. GURU FASHIONS INC, NEW YORK, NY. FILED 3-18-2006.

LARA DESIGN

THE MARK CONSISTS OF STANDARD CHARACTERS WITHOUT CLAIM TO ANY PARTICULAR FONT, STYLE, SIZE, OR COLOR.

NO CLAIM IS MADE TO THE EXCLUSIVE RIGHT TO USE "DESIGN", APART FROM THE MARK AS SHOWN.

FOR DRESSES; DRESSING GOWNS; EVENING DRESSES; EVENING GOWNS; GOWNS; NIGHT GOWNS; WEDDING DRESSES; WEDDING GOWNS (U.S. CLS. 22 AND 39).

FIRST USE 12-1-2002; IN COMMERCE 12-1-2002.
DAVID MURRAY, EXAMINING ATTORNEY

SN 78-840,630. GURU FASHIONS INC, NEW YORK, NY. FILED 3-18-2006.

LARA COUTURE

THE MARK CONSISTS OF STANDARD CHARACTERS WITHOUT CLAIM TO ANY PARTICULAR FONT, STYLE, SIZE, OR COLOR.

NO CLAIM IS MADE TO THE EXCLUSIVE RIGHT TO USE "COUTURE", APART FROM THE MARK AS SHOWN.

FOR DRESSES; DRESSING GOWNS; EVENING DRESSES; EVENING GOWNS; GOWNS; WEDDING DRESSES; WEDDING GOWNS (U.S. CLS. 22 AND 39).

FIRST USE 12-1-2002; IN COMMERCE 12-1-2002.
DAVID MURRAY, EXAMINING ATTORNEY

CLASS 25—(Continued).

SN 78-845,194. COUCH, JERED, MERIDIAN, ID. FILED 3-24-2006.

CULINARY TEEZE

THE MARK CONSISTS OF STANDARD CHARACTERS WITHOUT CLAIM TO ANY PARTICULAR FONT, STYLE, SIZE, OR COLOR.

FOR CLOTHING FOR CHEFS, NAMELY, SHIRTS, APRONS, HATS, JACKETS, PANTS, SHOES, CHEF HATS AND UNDERWEAR (U.S. CLS. 22 AND 39).

KATHERINE CONNOLLY, EXAMINING ATTORNEY

SN 78-845,764. PARNICO, LLC, LOS ANGELES, CA. FILED 3-24-2006.

De Bra

THE MARK CONSISTS OF STANDARD CHARACTERS WITHOUT CLAIM TO ANY PARTICULAR FONT, STYLE, SIZE, OR COLOR.

NO CLAIM IS MADE TO THE EXCLUSIVE RIGHT TO USE BRA, APART FROM THE MARK AS SHOWN.

FOR BRIEFS; LADIES' UNDERWEAR; UNDERWEAR; WOMEN'S UNDERWEAR (U.S. CLS. 22 AND 39).

FIRST USE 11-15-2005; IN COMMERCE 11-15-2005.
FRED CARL, EXAMINING ATTORNEY

SN 78-846,656. JOHNSON, MARK, MURRIETA, CA. FILED 3-27-2006.

Defy Industries

THE MARK CONSISTS OF STANDARD CHARACTERS WITHOUT CLAIM TO ANY PARTICULAR FONT, STYLE, SIZE, OR COLOR.

NO CLAIM IS MADE TO THE EXCLUSIVE RIGHT TO USE "INDUSTRIES", APART FROM THE MARK AS SHOWN.

FOR BASEBALL CAPS; BOARD SHORTS; CAPS; HATS; SHIRTS; SHIRTS; SHORT SETS; SHORT-SLEEVED OR LONG-SLEEVED T-SHIRTS; SHORTS; SKULL CAPS; SWEAT SHIRTS; T-SHIRTS (U.S. CLS. 22 AND 39).

KATHERINE STOIDES, EXAMINING ATTORNEY

CLASS 25—(Continued).

SN 78-848,241. COOGI PARTNERS, LLC, LAKE SUCCESS, NY. FILED 3-28-2006.

THE LUCKY COUNTRY

THE MARK CONSISTS OF STANDARD CHARACTERS WITHOUT CLAIM TO ANY PARTICULAR FONT, STYLE, SIZE, OR COLOR.

FOR CLOTHING, NAMELY SHIRTS, VESTS, SWEATERS, SHOES, CAPS, BANDANNAS, SHORTS, SWEAT SHIRTS, PANTS, BELTS FOR CLOTHING, SOCKS, SWIMWEAR, JACKETS, RAINWEAR, BLOUSES, DRESSES, FOOTWEAR, HOSIERY, SCARVES, HATS, HEAD BANDS, PAJAMAS AND SLEEPWEAR (U.S. CLS. 22 AND 39).

JASON ROTH, EXAMINING ATTORNEY

SN 78-849,603. LLOYD & ZANNA DESIGN INC., WEST VANCOUVER, CANADA, FILED 3-29-2006.

BARESUIT

THE MARK CONSISTS OF STANDARD CHARACTERS WITHOUT CLAIM TO ANY PARTICULAR FONT, STYLE, SIZE, OR COLOR.

OWNER OF CANADA REG. NO. TMA661,746, DATED 3-29-2006, EXPIRES 3-29-2021.

FOR LOUNGEWEAR, NAMELY, BATHROBES AND JUMPSUITS (U.S. CLS. 22 AND 39).

SHARON MEIER, EXAMINING ATTORNEY

CLASS 25—(Continued).

SN 78-851,138. SYNSHEEN CO., LTD., KYOUNGGI-DO, REPUBLIC OF KOREA, FILED 3-31-2006.

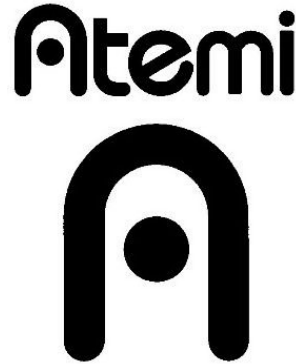

OWNER OF REPUBLIC OF KOREA REG. NO. 618655, DATED 5-20-2005, EXPIRES 5-20-2015.

THE MARK CONSISTS OF A STYLIZED LETTER A REPRESENTED BY AN INVERTED U SHAPE CONTAINING A CIRCLE.

THE ENGLISH TRANSLATION OF THE WORD ATEMI IN THE MARK IS STRIKE OR BLOW.

FOR FOOTWEAR NAMELY, LEATHER SHOES, GOLF SHOES, BASKETBALL SHOES, SHOES, HEELS, RUGBY SHOES, LACE BOOTS, BASEBALL SHOES, TRAINING SHOES, FOOTBALL SHOES, SOCCER SHOES, HOCKEY SHOES, HANDBALL SHOES, GYMNASTIC SHOES, RIDING BOOTS, BOXING SHOES, SANDALS, SKI BOOTS, SLIPPERS; CLOTHING NAMELY, CYCLISTS' JERSEYS, WET SUITS FOR WATER-SKIING, ANORAKS FOR EXERCISES, AEROBIC SUITS, JUDO SUITS, BREECHES (U.S. CLS. 22 AND 39).

JOHN DWYER, EXAMINING ATTORNEY

SN 78-851,168. MINER, DONALD R., CHATSWORTH, CA. FILED 3-31-2006.



NO CLAIM IS MADE TO THE EXCLUSIVE RIGHT TO USE "TEES", APART FROM THE MARK AS SHOWN.

THE MARK CONSISTS OF ARCHED BANNER WITH FURLED ENDS ENCLOSING A STAR.

FOR INFANT AND TODDLER ONE PIECE CLOTHING (U.S. CLS. 22 AND 39).

FIRST USE 4-16-2004; IN COMMERCE 4-16-2004.

WOODROW HARTZOG, EXAMINING ATTORNEY

CLASS 25—(Continued).

SN 78-851,396. HOT ON TIME LLC, GREENWICH, CT.
FILED 3-31-2006.

BELLA

COMFIA

THE MARK CONSISTS OF THE WORDS BELLA COMFIA AND A STYLIZED FEATHER.

THE FOREIGN WORDING IN THE MARK TRANSLATES INTO ENGLISH AS BEAUTIFUL.

FOR FOOTWEAR FOR WOMEN; LADIES' BOOTS; SANDALS; WOMEN'S SHOES (U.S. CLS. 22 AND 39).
ALLISON SCHRODY, EXAMINING ATTORNEY

SN 78-852,347. HALL, JEFFREY, JACKSONVILLE, FL. AND HALL, JOYELLE, JACKSONVILLE, FL. AND SMITH, BARRY, AUGUSTA, GA. AND DREW, MICHAEL, JACKSONVILLE, FL. AND NORMAN, STEPHANI, BETHLEHEM, GA. FILED 4-3-2006.



FOR CLOTHING, NAMELY, WOMEN'S PANTS, JEANS AND SHIRTS (U.S. CLS. 22 AND 39).
YONG KIM, EXAMINING ATTORNEY

SN 78-853,064. MCGHIE, JEREL T., SAN JOSE, CA. FILED 4-4-2006.

Set Me

THE MARK CONSISTS OF STANDARD CHARACTERS WITHOUT CLAIM TO ANY PARTICULAR FONT, STYLE, SIZE, OR COLOR.

FOR VOLLEYBALL CLOTHING, NAMELY, SHIRTS, SHORTS, SHOES, SWEAT SHIRTS, SWEAT PANTS, SWEAT SUITS, SWEAT SHORTS, SWEAT TOPS AND HATS (U.S. CLS. 22 AND 39).

MELISSA VALLILLO, EXAMINING ATTORNEY

CLASS 25—(Continued).

SN 78-853,104. ADG, LLC, SUN VALLEY, CA. FILED 4-4-2006.

RICH PINK GIRL

THE MARK CONSISTS OF STANDARD CHARACTERS WITHOUT CLAIM TO ANY PARTICULAR FONT, STYLE, SIZE, OR COLOR.

NO CLAIM IS MADE TO THE EXCLUSIVE RIGHT TO USE "GIRL", APART FROM THE MARK AS SHOWN.

FOR WOMEN'S CLOTHING, NAMELY, DRESSES, SHIRTS, PANTS, JEANS, JACKETS, COATS, VESTS, SWEATERS, KNIT TOPS, SKIRTS, BLOUSES, SOCKS, STOCKINGS, T-SHIRTS, SWEATSHIRTS AND LINGERIE (U.S. CLS. 22 AND 39).

MARTHA FROMM, EXAMINING ATTORNEY

SN 78-853,168. PJ MAWN EXCAVATING INC, WHITINSVILLE, MA. FILED 4-4-2006.

Dirt Dummy

THE MARK CONSISTS OF STANDARD CHARACTERS WITHOUT CLAIM TO ANY PARTICULAR FONT, STYLE, SIZE, OR COLOR.

FOR SHORT-SLEEVED OR LONG-SLEEVED T-SHIRTS; SWEAT SHIRTS (U.S. CLS. 22 AND 39).

BERNICE HOWSE, EXAMINING ATTORNEY

SN 78-853,399. DIAMOND DECISIONS, INC., CORONA, CA. FILED 4-4-2006.

HONEY DIP

THE MARK CONSISTS OF STANDARD CHARACTERS WITHOUT CLAIM TO ANY PARTICULAR FONT, STYLE, SIZE, OR COLOR.

FOR SLEEPWEAR FEATURING WOMEN'S INTIMATE APPAREL; CASUAL WEAR, NAMELY, T-SHIRTS, SHORTS, JEANS, SWEAT PANTS, SWEAT SHIRTS, AND POLO SHIRTS; UPSCALE APPAREL, NAMELY, SHIRTS, SKIRTS, BLOUSES, PANTS, AND JACKETS; SPORTSWEAR, NAMELY, LEGGINGS, JOGGING BOTTOMS, JOGGING SUITS, AND FOOTWEAR (U.S. CLS. 22 AND 39).

BENJAMIN OKEKE, EXAMINING ATTORNEY

CLASS 25—(Continued).

SN 78-853,616. MCGHIE, JEREL T., SAN JOSE, CA. FILED 4-4-2006.

set me

THE MARK CONSISTS OF STANDARD CHARACTERS WITHOUT CLAIM TO ANY PARTICULAR FONT, STYLE, SIZE, OR COLOR.

FOR VOLLEYBALL CLOTHING, NAMELY, SHIRTS, SHORTS, SHOES, SWEAT SHIRTS, SWEAT PANTS, SWEAT SUITS, SWEAT SHORTS AND SWEAT TOPS (U.S. CLS. 22 AND 39).

MELISSA VALLILLO, EXAMINING ATTORNEY



SN 78-854,184. AMBROSE, KATRELL S., CHARLOTTE, NC. FILED 4-5-2006.



THE NAME VICTOR DOES NOT IDENTIFY A LIVING INDIVIDUAL.

FOR MEN PAJAMAS, UNDERWEAR, ROBES, AND UNDERSHIRTS (U.S. CLS. 22 AND 39).

KATRINA EDGE, EXAMINING ATTORNEY

CLASS 25—(Continued).

SN 78-854,710. Z HOVAK APPAREL, LA CRESCENTA, CA. FILED 4-5-2006.

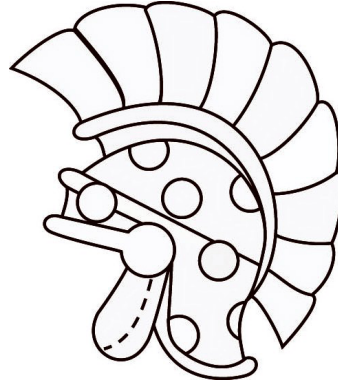

THE LINING IS A FEATURE OF THE MARK AND DOES NOT INDICATE COLOR.

THE MARK CONSISTS OF TROJAN HELMET WITH POLKA DOTS, DETAILED LINES, WITH DASHED LINES ON EAR PIECE.

FOR CLOTHING, NAMELY, T-SHIRTS, SHIRTS, TANK TOPS, SWEATSHIRTS, SWEATERS, JACKETS, COATS, PANTS, JEANS, SHORTS, SWIMWEAR, UNDERWEAR, BOXERS, FOOTWEAR, HEADWEAR, BANDANAS, SCARVES, SOCKS, BELTS, WRISTBANDS, HEADBANDS, BEACHWEAR, SWEATPANTS, LEGGING, OVERALLS, JERSEYS, SKIRTS, SHAWLS, DRESSES, BLOUSES, VEST, SWEATER VESTS, AND GLOVES (U.S. CLS. 22 AND 39).

ANGELA M. MICHELI, EXAMINING ATTORNEY



SN 78-854,755. EARTH SUN MOON TRADING COMPANY, GROVE CITY, PA. FILED 4-5-2006.



NO CLAIM IS MADE TO THE EXCLUSIVE RIGHT TO USE "BRAND", APART FROM THE MARK AS SHOWN.

THE NAME(S), PORTRAIT(S), AND/OR SIGNATURE(S) SHOWN IN THE MARK DOES NOT IDENTIFY A PARTICULAR LIVING INDIVIDUAL.

THE MARK CONSISTS OF A SMILEY FACE WEARING A HAT, WITH THE STYLIZED WORDS "HAPPY ANDY BRAND".

FOR SHIRTS AND HATS (U.S. CLS. 22 AND 39). FIRST USE 1-13-2006; IN COMMERCE 1-13-2006.

PAULA MAYS, EXAMINING ATTORNEY

CLASS 25—(Continued).

SN 78-854,846. JOSEPH, JEFF K, VENICE, CA. FILED 4-5-2006.

cre8tivity

THE MARK CONSISTS OF STANDARD CHARACTERS WITHOUT CLAIM TO ANY PARTICULAR FONT, STYLE, SIZE, OR COLOR.

FOR SHORT-SLEEVED OR LONG-SLEEVED T-SHIRTS (U.S. CLS. 22 AND 39).

KRISTINA KLOIBER, EXAMINING ATTORNEY

SN 78-855,194. LARSON, MALIA D., PLEASANTON, CA. FILED 4-6-2006.

CHILL

THE MARK CONSISTS OF STANDARD CHARACTERS WITHOUT CLAIM TO ANY PARTICULAR FONT, STYLE, SIZE, OR COLOR.

FOR ANKLE SOCKS; BEACH COVERUPS; BEACH FOOTWEAR; BEACH SHOES; CAPS; COVERUPS; FLIP FLOPS; FOOTWEAR FOR WOMEN; JACKETS; JOGGING PANTS; LEGGINGS; SHIRTS; SHORT-SLEEVED OR LONG-SLEEVED T-SHIRTS; SHORT-SLEEVED SHIRTS; SLEEVED OR SLEEVELESS JACKETS; SOCKS; SURF WEAR; SWEAT PANTS; SWEAT SHIRTS; SWIM WEAR; T-SHIRTS; THONGS; WOMEN'S SHOES (U.S. CLS. 22 AND 39).

FIRST USE 7-1-2003; IN COMMERCE 2-1-2004.
MARC LEIPZIG, EXAMINING ATTORNEY

SN 78-855,582. OSTRYNSKI, PAUL F, MIAMI, FL. FILED 4-6-2006.

JOHN★FOOS

THE MARK CONSISTS OF THE WORDS JOHN FOOS IN STYLIZED CAPITAL LETTERS. THERE IS A STAR BETWEEN BOTH WORDS.

FOR FOOTWEAR; SHOES (U.S. CLS. 22 AND 39).
ESTHER A. BORSUK, EXAMINING ATTORNEY

CLASS 25—(Continued).

SN 78-855,897. CONAIR CORPORATION, STAMFORD, CT. FILED 4-6-2006.

TWINKLETTES

THE MARK CONSISTS OF STANDARD CHARACTERS WITHOUT CLAIM TO ANY PARTICULAR FONT, STYLE, SIZE, OR COLOR.

FOR SLIPPERS (U.S. CLS. 22 AND 39).
SCOTT SISUN, EXAMINING ATTORNEY

SN 78-856,085. KURT S. YOO, GARDENA, CA. FILED 4-6-2006.

Hi-Lite

THE MARK CONSISTS OF STANDARD CHARACTERS WITHOUT CLAIM TO ANY PARTICULAR FONT, STYLE, SIZE, OR COLOR.

FOR (BASED ON SECTION 1(B))— ANKLE SOCKS; ANKLETS; ANTI-PERSPIRANT SOCKS; BIKINIS; BRIEFS; DRESS SHIRTS; GOLF SHIRTS; KNIT SHIRTS; KNITTED UNDERWEAR; LADIES' UNDERWEAR; MEN'S SOCKS; NIGHT SHIRTS; OPEN-NECKED SHIRTS; PERSPIRATION ABSORBENT UNDERWEAR CLOTHING; POLO SHIRTS; SHIRTS; SHIRTS FOR SUITS; SHORT-SLEEVED OR LONG-SLEEVED T-SHIRTS; SHORT-SLEEVED SHIRTS; SLEEP SHIRTS; SOCKS; SOCKS AND STOCKINGS; SPORT SHIRTS; SPORTS SHIRTS; SPORTS SHIRTS WITH SHORT SLEEVES; SWEAT SHIRTS; T-SHIRTS; THERMAL SOCKS; THERMAL UNDERWEAR; THONGS; UNDERWEAR; WOMEN'S UNDERWEAR; WOVEN OR KNITTED UNDERWEAR; (BASED ON SECTION 1(A))— BOXER BRIEFS; BOXER SHORTS; TANK TOPS; TANK-TOPS (U.S. CLS. 22 AND 39).

FIRST USE 1-1-2004; IN COMMERCE 4-1-2004.
SHARON MEIER, EXAMINING ATTORNEY

SN 78-856,236. DEJOHNETTE, MYRON, LAS VEGAS, NV. FILED 4-7-2006.



FOR JACKETS, SHIRTS, PANTS, HATS (U.S. CLS. 22 AND 39).
LANA PHAM, EXAMINING ATTORNEY

CLASS 25—(Continued).

SN 78-856,407. TOP LINE SCREEN PRINTING AND EMBROIDERY, INC., ORLANDO, FL. FILED 4-7-2006.

BIG MAN ON CAMPUS

THE MARK CONSISTS OF STANDARD CHARACTERS WITHOUT CLAIM TO ANY PARTICULAR FONT, STYLE, SIZE, OR COLOR.

FOR SHORT-SLEEVED OR LONG-SLEEVED T-SHIRTS (U.S. CLS. 22 AND 39).

NAKIA HENRY, EXAMINING ATTORNEY

SN 78-856,556. NAPLES DIRECT, LLC, SPRINGFIELD, OH. FILED 4-7-2006.

SLIDERS

THE MARK CONSISTS OF STANDARD CHARACTERS WITHOUT CLAIM TO ANY PARTICULAR FONT, STYLE, SIZE, OR COLOR.

FOR ABRASION RESISTANT MOTORCYCLE JEANS, PANTS AND JACKETS (U.S. CLS. 22 AND 39).

FIRST USE 5-31-2005; IN COMMERCE 5-31-2005.

CORY BOONE, EXAMINING ATTORNEY

SN 78-856,941. PRESTON, BRADLEY, PORTOLA, CA. FILED 4-7-2006.

ENSLAVED INDUSTRIES

THE MARK CONSISTS OF STANDARD CHARACTERS WITHOUT CLAIM TO ANY PARTICULAR FONT, STYLE, SIZE, OR COLOR.

NO CLAIM IS MADE TO THE EXCLUSIVE RIGHT TO USE "INDUSTRIES", APART FROM THE MARK AS SHOWN.

FOR BELTS MADE OF LEATHER; BELTS OF TEXTILE; HATS; PANTS; SHIRTS; SWEAT SHIRTS (U.S. CLS. 22 AND 39).

DOMINICK J. SALEMI, EXAMINING ATTORNEY

CLASS 25—(Continued).

SN 78-857,249. FREDERICKSEN, PHNEWFULA, STUDIO CITY, CA. FILED 4-8-2006.

Team Sexy

THE MARK CONSISTS OF STANDARD CHARACTERS WITHOUT CLAIM TO ANY PARTICULAR FONT, STYLE, SIZE, OR COLOR.

FOR CLOTHING, NAMELY, SHIRTS, SHORTS, PANTS, JACKETS, BLOUSES, SKIRTS, DRESSES, SHAWLS, SCARVES, GLOVES, TIES, OVERALLS, T-SHIRTS, JEANS, SWEATSHIRTS, VESTS, RAINWEAR, LINGERIE, LOUNGEWEAR, HOSIERY, SOCKS, BOXER SHORTS, BASEBALL CAPS, HATS, BANDANAS, SWEATERS, JOG SETS COMPRISED OF SHIRTS, SWEATSHIRTS, AND SWEATPANTS, BELTS, BRAS, PANTIES, CAMISOLES, PAJAMAS, NIGHTGOWNS, FOOTWEAR, SLIPPERS, ROBES, TANK TOPS, SWIMWEAR, COATS, HEADBANDS, FUR COATS, JACKET COATS, FUR HATS, FUR STOLEES, FUR GLOVES, FUR MUFFS (U.S. CLS. 22 AND 39).

MARLENE BELL, EXAMINING ATTORNEY

SN 78-857,946. GRUPPO LA PERLA S.P.A., BOLOGNA, ITALY, FILED 4-10-2006.

MALIZIA

THE MARK CONSISTS OF STANDARD CHARACTERS WITHOUT CLAIM TO ANY PARTICULAR FONT, STYLE, SIZE, OR COLOR.

THE ENGLISH TRANSLATION OF THE ITALIAN WORD "MALIZIA" IN THE MARK IS "MISCHIEF."

FOR UNDERWEAR FOR MEN AND WOMEN; BATHING SUITS AND BEACH ROBES FOR MEN AND WOMEN; CORSETS (U.S. CLS. 22 AND 39).

FIRST USE 5-0-1983; IN COMMERCE 11-0-1983.

CHRISTINE COOPER, EXAMINING ATTORNEY

SN 78-858,103. TOPLINE SCREENPRINTING & EMBROIDERY, ORLANDO, FL. FILED 4-10-2006.

MY U

THE MARK CONSISTS OF STANDARD CHARACTERS WITHOUT CLAIM TO ANY PARTICULAR FONT, STYLE, SIZE, OR COLOR.

FOR ANKLE SOCKS; BELTS; CAPS; MEN'S SOCKS; SWEAT SHIRTS; T-SHIRTS; WOOLLEN SOCKS (U.S. CLS. 22 AND 39).

FIRST USE 3-1-2005; IN COMMERCE 3-1-2005.

ALLISON SCHRODY, EXAMINING ATTORNEY

CLASS 25—(Continued).

SN 78-858,400. BOOKER, DAMEON DERMAINE, PLAYA DEL REY, CA. FILED 4-11-2006.

I am not Flammin, I am an Inferno!

THE MARK CONSISTS OF STANDARD CHARACTERS WITHOUT CLAIM TO ANY PARTICULAR FONT, STYLE, SIZE, OR COLOR.
FOR SHIRTS (U.S. CLS. 22 AND 39).
MICHELE SWAIN, EXAMINING ATTORNEY

SN 78-858,639. VIACOM INTERNATIONAL INC., NEW YORK, NY. FILED 4-11-2006.

BEST DAY EVER

THE MARK CONSISTS OF STANDARD CHARACTERS WITHOUT CLAIM TO ANY PARTICULAR FONT, STYLE, SIZE, OR COLOR.
FOR CLOTHING, NAMELY, BATHING SUITS, BELTS, HALLOWEEN COSTUMES, COATS, SOCKS, CLOTHING BELTS, FOOTWEAR, BANDANNAS, DRESSES, GLOVES, GYM SHORTS, EAR MUFFS, NECK WEAR, JACKETS, PAJAMAS, PANTS, SHIRTS, SHORTS, SKI WEAR, SLACKS, SUN VISORS, SUSPENDERS, SWEATERS, TURTLENECKS, UNDERCLOTHES, VESTS, WARM-UP SUITS, HEADWEAR, BATHROBES, BEACHWEAR (U.S. CLS. 22 AND 39).
SUSAN RICHARDS, EXAMINING ATTORNEY

SN 78-858,650. WINGSTREET LLC, LOUISVILLE, KY. FILED 4-11-2006.

USE OF A FORK IS STRICTLY FORBIDDEN

THE MARK CONSISTS OF STANDARD CHARACTERS WITHOUT CLAIM TO ANY PARTICULAR FONT, STYLE, SIZE, OR COLOR.
FOR SHIRTS (U.S. CLS. 22 AND 39).
DAVID TAYLOR, EXAMINING ATTORNEY

CLASS 25—(Continued).

SN 78-858,830. FROST, KEVIN, DBA FROST CLOTHING COMPANY, CEDAR RAPIDS, IA. FILED 4-11-2006.

JOHNNY BALLER

THE MARK CONSISTS OF STANDARD CHARACTERS WITHOUT CLAIM TO ANY PARTICULAR FONT, STYLE, SIZE, OR COLOR.
"JOHNNY BALLER" DOES NOT IDENTIFY A LIVING INDIVIDUAL.
FOR CLOTHING, NAMELY, T-SHIRTS, LONG-SLEEVED T-SHIRTS, SWEATSHIRTS, HOODED SWEATSHIRTS, HATS, STOCKING HATS, SCARVES, JACKETS, SWEATPANTS, SWEATSUITS, WARM-UPS, SHORTS, JERSEYS, UNIFORMS, SWEATBANDS, HEADBANDS, AND WRISTBANDS (U.S. CLS. 22 AND 39).
JEFFERY COWARD, EXAMINING ATTORNEY

SN 78-858,843. FROST, KEVIN, DBA FROST CLOTHING COMPANY, CEDAR RAPIDS, IA. FILED 4-11-2006.

BABY BALLER

THE MARK CONSISTS OF STANDARD CHARACTERS WITHOUT CLAIM TO ANY PARTICULAR FONT, STYLE, SIZE, OR COLOR.
NO CLAIM IS MADE TO THE EXCLUSIVE RIGHT TO USE "BABY", APART FROM THE MARK AS SHOWN.
FOR CLOTHING, NAMELY, T-SHIRTS, LONG-SLEEVED T-SHIRTS, SWEATSHIRTS, HOODED SWEATSHIRTS, HATS, STOCKING HATS, SCARVES, JACKETS, SWEATPANTS, SWEATSUITS, WARM-UPS, SHORTS, JERSEYS, UNIFORMS, SWEATBANDS, HEADBANDS, WRISTBANDS, ROMPERS, CREEPERS, SOCKS, AND SHOES (U.S. CLS. 22 AND 39).
JEFFERY COWARD, EXAMINING ATTORNEY

SN 78-858,849. MIAO, YUNTIAN, MARIETTA, GA. FILED 4-11-2006.

For Your Leisure

THE MARK CONSISTS OF STANDARD CHARACTERS WITHOUT CLAIM TO ANY PARTICULAR FONT, STYLE, SIZE, OR COLOR.
FOR BELTS; BLOUSES; CAPS; COATS; DRESSES; FOOTWEAR; GLOVES; HATS; HOSIERY; JACKETS; JEANS; PANTS; PARKAS; POLO SHIRTS; PULLOVERS; RAINWEAR; SHORTS; SKIRTS; SLACKS; SLEEPWEAR; SOCKS; SWEATERS; T-SHIRTS; TANK TOPS; TOPS; TURTLENECKS; UNDERWEAR; VESTS (U.S. CLS. 22 AND 39).
PAUL E. FAHRENKOPF, EXAMINING ATTORNEY

CLASS 25—(Continued).

SN 78-858,854. MIAO, YUNTIAN, MARIETTA, GA. FILED 4-11-2006.

For Your Love

THE MARK CONSISTS OF STANDARD CHARACTERS WITHOUT CLAIM TO ANY PARTICULAR FONT, STYLE, SIZE, OR COLOR.

FOR BELTS; BLOUSES; CAPS; COATS; DRESSES; FOOTWEAR; GLOVES; HATS; HOSIERY; JACKETS; JEANS; PANTS; PARKAS; POLO SHIRTS; PULLOVERS; RAINWEAR; SHORTS; SKIRTS; SLACKS; SLEEPWEAR; SOCKS; SWEATERS; T-SHIRTS; TANK TOPS; TOPS; TURTLENECKS; UNDERWEAR; VESTS (U.S. CLS. 22 AND 39).

PAUL E. FAHRENKOPF, EXAMINING ATTORNEY

CLASS 25—(Continued).

SN 78-859,237. PANTONE, INC., CARLSTADT, NJ. FILED 4-11-2006.

PANTONE UNIVERSE

THE MARK CONSISTS OF STANDARD CHARACTERS WITHOUT CLAIM TO ANY PARTICULAR FONT, STYLE, SIZE, OR COLOR.

OWNER OF U.S. REG. NOS. 1,674,917, 1,884,707 AND OTHERS.

FOR BOOTS; FLIP FLOPS; GOWNS; HATS; PAJAMAS; PANTS; ROBES; SANDALS; SHIRTS; SHOES; SHORTS; SKIRTS AND DRESSES; SKORTS; SLIPPERS; SMOCKS; SNEAKERS; SOCKS; SWEAT SHIRTS; TENNIS SHOES; T-SHIRTS; TOPS; WRIST BANDS (U.S. CLS. 22 AND 39).

TINA BROWN, EXAMINING ATTORNEY

SN 78-858,859. MIAO, YUNTIAN, MARIETTA, GA. FILED 4-11-2006.

FYL

THE MARK CONSISTS OF STANDARD CHARACTERS WITHOUT CLAIM TO ANY PARTICULAR FONT, STYLE, SIZE, OR COLOR.

FOR BELTS; BLOUSES; CAPS; COATS; DRESSES; FOOTWEAR; GLOVES; HATS; HOSIERY; JACKETS; JEANS; PANTS; PARKAS; POLO SHIRTS; PULLOVERS; RAINWEAR; SHORTS; SKIRTS; SLACKS; SLEEPWEAR; SOCKS; SWEATERS; T-SHIRTS; TANK TOPS; TURTLENECKS; UNDERWEAR; VESTS (U.S. CLS. 22 AND 39).

PAUL E. FAHRENKOPF, EXAMINING ATTORNEY

SN 78-859,594. NATIONAL SPORTSWEAR INCORPORATED, APOPKA, FL. FILED 4-12-2006.



THE MARK CONSISTS OF A STYLIZED LETTER "N" IN THE SHAPE OF A LIGHTNING BOLT.

FOR T-SHIRTS (U.S. CLS. 22 AND 39).

FIRST USE 9-5-2000; IN COMMERCE 9-5-2000.

TANYA AMOS, EXAMINING ATTORNEY

SN 78-858,861. HOT KISS, INC., LOS ANGELES, CA. FILED 4-11-2006.

MODERN LOVE

THE MARK CONSISTS OF STANDARD CHARACTERS WITHOUT CLAIM TO ANY PARTICULAR FONT, STYLE, SIZE, OR COLOR.

FOR DRESSES; PANTS; SHIRTS; SHORTS; T-SHIRTS; TOPS; TROUSERS (U.S. CLS. 22 AND 39).

PAUL E. FAHRENKOPF, EXAMINING ATTORNEY

SN 78-859,710. BURMA-BIBAS, INC., NEW YORK, NY. FILED 4-12-2006.

Hollis River

THE MARK CONSISTS OF STANDARD CHARACTERS WITHOUT CLAIM TO ANY PARTICULAR FONT, STYLE, SIZE, OR COLOR.

FOR CLOTHING, NAMELY, NECKTIES, SHIRTS, JACKETS, SWEATERS, SLACKS, PANTS AND SWIMWEAR (U.S. CLS. 22 AND 39).

ELLEN BURNS, EXAMINING ATTORNEY

CLASS 25—(Continued).

SN 78-859,725. BURMA-BIBAS, INC., NEW YORK, NY.
FILED 4-12-2006.

Batik Bay

THE MARK CONSISTS OF STANDARD CHARACTERS WITHOUT CLAIM TO ANY PARTICULAR FONT, STYLE, SIZE, OR COLOR.

FOR CLOTHING, NAMELY, NECKTIES, SHIRTS, JACKETS, SWEATERS, SLACKS, PANTS AND SWIMWEAR (U.S. CLS. 22 AND 39).

ELLEN BURNS, EXAMINING ATTORNEY

SN 78-859,746. WREN, JOHN, PRAIRIEVILLE, LA. FILED 4-12-2006.



FOR CLOTHING, NAMELY, HATS, T-SHIRTS, TOPS, AND BOTTOMS (U.S. CLS. 22 AND 39).

LEIGH CAROLINE CASE, EXAMINING ATTORNEY

SN 78-860,375. HOLLADAY, DALTON, PASO ROBLES, CA.
FILED 4-12-2006.



THE COLOR(S) WHITE, RED, BLUE, GREEN, GREY, YELLOW, ORANGE, BROWN, TAN & BLACK. IS/ARE CLAIMED AS A FEATURE OF THE MARK.

THE MARK CONSISTS OF SCENERY COMPOSED OF GREEN, BLUE AND BROWN TREES WITH A GREY BOULDER HIGHLIGHTED WITH BLUE AND GREEN WITH A BARE GREY BRANCH STICKING UP OUT OF IT. AND A LITTLE BLUE AND WHITE CREEK IS RUNNING TO THE LEFT OF THE ROCK. THE SCENE IS FLANKED BY TWO STYLIZED COWGIRLS, THEIR SKIN IS TAN THEY HAVE BROWN HAIR AND LIPS AND EYES, THEY ARE LEANING ON BLUE AND GREEN FLOWERS AND LEAVES, THEY HAVE TAN COWBOY HATS ON, THEY ARE WEARING COWBOY BOOTS, THE ONE ON THE RIGHTS ARE YELLOW, WHITE AND BROWN AND THE ONE ON THE LEFTS ARE ORANGE, WHITE AND BROWN, THEY BOTH HAVE THEIR OUTER LEG BENT AND THE FOOT IS PLACED ON THE WALL BEHIND THEM, THEY ARE HOLDING CARDS IN THEIR HAND THE RIGHT'S CARDS ARE SHOWING THE RED AND WHITE BACK OF THE CARDS THE LEFT'S SHOWING THE FACE OF THE CARDS WHITE WITH BLACK SHAPES. THE SKY HAS BLUE GREEN AND YELLOW HIGHLIGHTING

CLASS 25—(Continued).

THE CLOUDS THE WHOLE SCENE IS SET ON A BROWN ANTIQUED BACKGROUND AND THE TOP CENTER OF THE SCENE HAS A CURVED ARC IN RED AND THE ENTIRE SCENE IS OUTLINED IN RED WITH A HEAVIER RED BORDER. THE EDGE OF THE ENTIRE LOGO HAS A BURNED APPEARANCE AND IS BLACK. THE WORDS "OLD CAMOZZI'S" IS WRITTEN IN STYLIZED LETTER AT THE CENTER RED BOTTOM OF THE LOGO IN BLACK LETTERING.

FOR HATS, T-SHIRTS, COATS, JACKETS, SWEATSHIRTS, CAPS (U.S. CLS. 22 AND 39).

FIRST USE 4-1-2006; IN COMMERCE 4-1-2006.

ATTIYA MALIK, EXAMINING ATTORNEY

SN 78-860,492. PHILLIP MILLER, BROOKLYN, NY. FILED 4-12-2006.



FOR CLOTHING, NAMELY, JERSEYS AND SPORTS JERSEYS (U.S. CLS. 22 AND 39).

MARY MUNSON, EXAMINING ATTORNEY

SN 78-860,894. NO PROBLEM, INC., AVON LAKE, OH.
FILED 4-13-2006.

ROCKLID

THE MARK CONSISTS OF STANDARD CHARACTERS WITHOUT CLAIM TO ANY PARTICULAR FONT, STYLE, SIZE, OR COLOR.

FOR HATS (U.S. CLS. 22 AND 39).

BRENDAN REGAN, EXAMINING ATTORNEY

CLASS 25—(Continued).

SN 78-860,909. MASCARENAS, ALICIA, SAN DIEGO, CA.
FILED 4-13-2006.

GROMMOM

THE MARK CONSISTS OF STANDARD CHARACTERS
WITHOUT CLAIM TO ANY PARTICULAR FONT, STYLE,
SIZE, OR COLOR.

FOR BLOUSES; HATS; PANTS; SHIRTS; SHOES;
SHORT-SLEEVED OR LONG-SLEEVED T-SHIRTS;
SKIRTS AND DRESSES; SOCKS; SWEAT SHIRTS (U.S.
CLS. 22 AND 39).

WILLIAM ROSSMAN, EXAMINING ATTORNEY

CLASS 25—(Continued).

SN 78-861,437. MIGHTY FINE, LOS ANGELES, CA. FILED 4-
13-2006.

LUSH

THE MARK CONSISTS OF STANDARD CHARACTERS
WITHOUT CLAIM TO ANY PARTICULAR FONT, STYLE,
SIZE, OR COLOR.

FOR BELTS; CAPS; CHILDREN'S AND INFANTS'
CLOTH BIBS; CLOTH BIBS; INFANT AND TODDLER
ONE PIECE CLOTHING; JACKETS; JERSEYS; KNIT
SHIRTS; MUSCLE TOPS; SWEATERS; T-SHIRTS;
TANK-TOPS; TOPS (U.S. CLS. 22 AND 39).

ELIZABETH J. WINTER, EXAMINING ATTORNEY

SN 78-860,989. GRACIE'S GEAR, INC., APEX, NC. FILED 4-
13-2006.

POWER POUCH

THE MARK CONSISTS OF STANDARD CHARACTERS
WITHOUT CLAIM TO ANY PARTICULAR FONT, STYLE,
SIZE, OR COLOR.

FOR SPORTS BRAS AND SPORTS TOPS (U.S. CLS. 22
AND 39).

FIRST USE 5-25-2006; IN COMMERCE 5-25-2006.
MARK T. MULLEN, EXAMINING ATTORNEY

SN 78-861,454. TMNAB, LLC, NEWPORT BEACH, CA. FILED
4-13-2006.

ALTAMONT APPAREL LTD

THE MARK CONSISTS OF STANDARD CHARACTERS
WITHOUT CLAIM TO ANY PARTICULAR FONT, STYLE,
SIZE, OR COLOR.

NO CLAIM IS MADE TO THE EXCLUSIVE RIGHT TO
USE "APPAREL LTD", APART FROM THE MARK AS
SHOWN.

FOR SHIRTS, VESTS, SWEATSHIRTS, JACKETS,
PANTS, SHORT PANTS, UNDERWEAR, BELTS, HATS
AND SOCKS (U.S. CLS. 22 AND 39).

MATTHEW MCDOWELL, EXAMINING ATTORNEY

SN 78-861,313. CASS AND CREW, LLC, KENNETT SQUARE,
PA. FILED 4-13-2006.

Piece of Cass

THE MARK CONSISTS OF STANDARD CHARACTERS
WITHOUT CLAIM TO ANY PARTICULAR FONT, STYLE,
SIZE, OR COLOR.

FOR UNDERGARMENTS (U.S. CLS. 22 AND 39).
LINDA ESTRADA, EXAMINING ATTORNEY

SN 78-861,474. JAIME, MICHAEL A., LA MARQUE, TX.
FILED 4-13-2006.

skru

THE MARK CONSISTS OF STANDARD CHARACTERS
WITHOUT CLAIM TO ANY PARTICULAR FONT, STYLE,
SIZE, OR COLOR.

FOR CLOTHING, NAMELY, SHIRTS, HEADWEAR,
SHORTS, PANTS, LINGERIE, SWIMWEAR, FOOTWEAR
(U.S. CLS. 22 AND 39).

FIRST USE 2-7-2006; IN COMMERCE 4-10-2006.
KELLY BOULTON, EXAMINING ATTORNEY

CLASS 25—(Continued).

SN 78-861,492. YOR HOLDINGS MANAGEMENT CORPORATION, CHEYENNE, WY. FILED 4-14-2006.

YOR

THE MARK CONSISTS OF STANDARD CHARACTERS WITHOUT CLAIM TO ANY PARTICULAR FONT, STYLE, SIZE, OR COLOR.

FOR CLOTHING ITEMS AND GARMENTS, NAMELY, CAPS, VISORS, T-SHIRTS, JERSEYS, SWEATS, JACKETS, COATS, BELTS, PANTS, AND UNIFORMS (U.S. CLS. 22 AND 39).

WILLIAM BRECKENFELD, EXAMINING ATTORNEY

SN 78-861,513. STONEACRE & FINANCCIAL PARTNERS, LLC, GLOUCESTER, MA. FILED 4-14-2006.

LIVING LEGENDS

THE MARK CONSISTS OF STANDARD CHARACTERS WITHOUT CLAIM TO ANY PARTICULAR FONT, STYLE, SIZE, OR COLOR.

FOR BASEBALL CAPS; FOOTWEAR; GOLF SHIRTS; JACKETS; KNITTED CAPS; PANTS; SHORTS; SWEAT PANTS; SWEAT SHIRTS; SWEATERS; T-SHIRTS; TANK TOPS; VESTS; VISORS (U.S. CLS. 22 AND 39).

JOANNA DUKOVIC, EXAMINING ATTORNEY

SN 78-861,523. CAFGSS CORPORATION, GILBERT, AZ. FILED 4-14-2006.

CAFGSS

THE MARK CONSISTS OF STANDARD CHARACTERS WITHOUT CLAIM TO ANY PARTICULAR FONT, STYLE, SIZE, OR COLOR.

FOR CLOTHING, NAMELY, SHIRTS, SHORTS, HEADWEAR, AND SWEAT SHIRTS (U.S. CLS. 22 AND 39). FIRST USE 7-5-2001; IN COMMERCE 3-8-2005.

JOANNA DUKOVIC, EXAMINING ATTORNEY

CLASS 25—(Continued).

SN 78-861,589. HOODLOVE LIMITED LIABILITY COMPANY, EAST ORANGE, NJ. FILED 4-14-2006.

HOOD LOVE

THE MARK CONSISTS OF STANDARD CHARACTERS WITHOUT CLAIM TO ANY PARTICULAR FONT, STYLE, SIZE, OR COLOR.

FOR ANKLE SOCKS; ANKLETS; ANORAKS; APRONS; ATHLETIC FOOTWEAR; ATHLETIC SHOES; ATHLETIC UNIFORMS; BABY BIBS NOT OF PAPER; BANDANAS; BASEBALL CAPS; BASKETBALL SNEAKERS; BATH SLIPPERS; BATHING CAPS; BATHING SUITS; BATHING TRUNKS; BATHROBES; BEACH FOOTWEAR; BEACH SHOES; BEACHWEAR; BELTS; BELTS MADE OF LEATHER; BELTS OF TEXTILE; BERETS; BERMUDA SHORTS; BIB OVERALLS; BLAZERS; BLOUSES; BOARD SHORTS; BODY SUITS; BOOTIES; BOOTS; BOW TIES; BOXER BRIEFS; BOXER SHORTS; BOXING SHOES; BRAS; BRIEFS; CAMISOLES; CANVAS SHOES; CAPS; CHILDREN'S HEADWEAR; CLOTH BIBS; CLOTH DIAPERS; COATS; COVERALLS; DECK-SHOES; DENIM JACKETS; DOWN JACKETS; DRESS SHIRTS; DRESS SUITS; DRESSES; EAR MUFFS; EVENING DRESSES; EVENING GOWNS; FABRIC BELTS; FLEECE PULL-OVERS; FLEECE SHORTS; FLIP FLOPS; FOOTBALL SHOES; FOOTWEAR FOR MEN; FOOTWEAR FOR TRACK AND FIELD ATHLETICS; FOOTWEAR FOR WOMEN; GALOSHES; GARTER BELTS; GLOVES; GOLF SHIRTS; GYM SHORTS; GYM SUITS; HALTER TOPS; HATS; HEAD SCARVES; HEADBANDS; HEADWEAR; HEAVY JACKETS; HOSIERY; INFANT AND TODDLER ONE PIECE CLOTHING; JACKETS; JEANS; JERSEYS; JOGGING OUTFITS; JUMPERS; KNIT SHIRTS; KNITTED CAPS; LADIES' SUITS; LADIES' UNDERWEAR; LEATHER COATS; LEATHER JACKETS; LEATHER PANTS; LEATHER SHOES; LEG WARMERS; LEGGINGS; LINGERIE; LOUNGEWEAR; MEN'S SOCKS; MITTENS; MUSCLE TOPS; NECKTIES; NECKWEAR; NIGHT GOWNS; OVERALLS; PAJAMAS; PANTS; PANTYHOSE; PARKAS; POLO SHIRTS; PONCHOS; PULL-OVERS; RAIN COATS; RAINWEAR; ROBES; RUGBY TOPS; RUNNING SHOES; SANDALS; SCARVES; SHIRTS; SHIRTS FOR SUITS; SHOES; SHORT-SLEEVED OR LONG-SLEEVED T-SHIRTS; SHORTS; SHOWER CAPS; SKI JACKETS; SKIRTS; SKULL CAPS; SLACKS; SLEEPWEAR; SLIPPERS; SLIPS; SNEAKERS; SOCKS; SPORT COATS; SPORTS BRA; SPORTS JERSEYS; SUITS; SUSPENDERS; SWEAT BANDS; SWEAT PANTS; SWEAT SHIRTS; SWEAT SHORTS; SWEAT SUITS; SWEATERS; SWIMMING TRUNKS; T-SHIRTS; TANK TOPS; TENNIS SHOES; THONGS; TIGHTS; TOPS; TRACK PANTS; TRACK SUITS; TRENCH COATS; TROUSERS; TURTLE-NECK SWEATERS; UNDERWEAR; UNIFORMS; V-NECK SWEATERS; VESTS; WARM UP SUITS; WIND RESISTANT JACKETS; WOOLLY HATS; WRIST BANDS (U.S. CLS. 22 AND 39).

BARBARA BROWN, EXAMINING ATTORNEY

CLASS 25—(Continued).

SN 78-861,830. DINGMAN, MARTIN, LEAD HILL, AR.
FILED 4-14-2006.

MARTIN DINGMAN

THE MARK CONSISTS OF STANDARD CHARACTERS WITHOUT CLAIM TO ANY PARTICULAR FONT, STYLE, SIZE, OR COLOR.

OWNER OF U.S. REG. NOS. 1,994,497 AND 2,013,055.
THE NAME(S), PORTRAIT(S), AND/OR SIGNATURE(S) SHOWN IN THE MARK IDENTIFIES MARTIN DINGMAN, WHOSE CONSENT(S) TO REGISTER IS MADE OF RECORD.

FOR SHOES (U.S. CLS. 22 AND 39).
FIRST USE 1-31-2002; IN COMMERCE 1-31-2002.
JUDITH HELFMAN, EXAMINING ATTORNEY

SN 78-861,974. STANI CORPORATION, ONTARIO, CA.
FILED 4-14-2006.

Universal Healthcare

THE MARK CONSISTS OF STANDARD CHARACTERS WITHOUT CLAIM TO ANY PARTICULAR FONT, STYLE, SIZE, OR COLOR.

FOR UNIFORMS, SMOCKS, SHIRTS, AND DRESSES FOR PROFESSIONAL WOMEN SUCH AS NURSES, RESEARCH WORKERS, PHARMACISTS, COSMETOLOGISTS, MEDICAL ASSISTANTS; AND SHIRT COATS, LAB COATS AND JACKETS FOR PROFESSIONAL MEN SUCH AS MEDICAL DOCTORS, INTERNS, RESEARCH WORKERS, MEDICAL ASSISTANTS, PHARMACISTS AND NON-PROFESSIONALS SUCH AS BARBERS (U.S. CLS. 22 AND 39).

ADA HAN, EXAMINING ATTORNEY

SN 78-862,272. MALIBU TIE, INC., TUSTIN, CA. FILED 4-15-2006.

ZIPPERFECT

THE MARK CONSISTS OF STANDARD CHARACTERS WITHOUT CLAIM TO ANY PARTICULAR FONT, STYLE, SIZE, OR COLOR.

FOR TIES (U.S. CLS. 22 AND 39).
FIRST USE 12-1-1995; IN COMMERCE 12-1-1995.
TINA BROWN, EXAMINING ATTORNEY

CLASS 25—(Continued).

SN 78-862,291. VALOR CLOTHING COMPANY, EAST STROUDSBURG, PA. FILED 4-15-2006.



THE MARK CONSISTS OF A LETTER V WITH AN INVERTED STAR SHAPING THE V.

FOR POLO SHIRTS; SHIRTS; SHORT-SLEEVED SHIRTS; SHORTS; SWEAT SHIRTS; T-SHIRTS; TIES; UNDERWEAR (U.S. CLS. 22 AND 39).

KATHERINE CHANG, EXAMINING ATTORNEY

SN 78-862,356. LARSON, MALIA, PLEASANTON, CA. FILED 4-16-2006.

queen of chill

THE MARK CONSISTS OF STANDARD CHARACTERS WITHOUT CLAIM TO ANY PARTICULAR FONT, STYLE, SIZE, OR COLOR.

FOR ANKLETS; BEACH SHOES; CAPRI PANTS; JACKETS; JOGGING PANTS; PANTS; SHIRTS; SHOES; SHORT-SLEEVED OR LONG-SLEEVED T-SHIRTS; SLEEP SHIRTS; SLEEVED OR SLEEVELESS JACKETS; SOCKS; SURF WEAR; SWEAT PANTS; SWEAT SHIRTS; SWIM WEAR; THONGS; TOPS; WOMEN'S SHOES (U.S. CLS. 22 AND 39).

FIRST USE 7-1-2003; IN COMMERCE 2-1-2004.
MARC LEIPZIG, EXAMINING ATTORNEY

SN 78-862,564. TOMLINSON, LANCE, SAN JOSE, CA. FILED 4-17-2006.

408FIGHTER

THE MARK CONSISTS OF STANDARD CHARACTERS WITHOUT CLAIM TO ANY PARTICULAR FONT, STYLE, SIZE, OR COLOR.

FOR APPAREL, NAMELY BASEBALL HATS, BEANIES, T-SHIRTS, TANK TOPS, SHORTS, SWEAT PANTS AND SWEAT SHIRTS (U.S. CLS. 22 AND 39).

GRETTA YAO, EXAMINING ATTORNEY

CLASS 25—(Continued).

SN 78-862,577. TOMLINSON, LANCE, SAN JOSE, CA. FILED 4-17-2006.

WEST COAST FIGHT GEAR

THE MARK CONSISTS OF STANDARD CHARACTERS WITHOUT CLAIM TO ANY PARTICULAR FONT, STYLE, SIZE, OR COLOR.

NO CLAIM IS MADE TO THE EXCLUSIVE RIGHT TO USE "FIGHT GEAR", APART FROM THE MARK AS SHOWN.

FOR APPAREL, NAMELY BASEBALL HATS, BEANIES, T-SHIRTS, TANK TOPS, SHORTS, SWEAT PANTS AND SWEAT SHIRTS (U.S. CLS. 22 AND 39).

GRETTA YAO, EXAMINING ATTORNEY

SN 78-862,618. SHAW, BRYAN C, RALEIGH, NC. FILED 4-17-2006.



THE APPLICANT CLAIMS COLOR AS A FEATURE OF THE MARK, NAMELY, RED, WHITE, BLUE, AND BLACK.

THE COLOR RED APPEARS IN THE BACKGROUND DESIGN OF THE FLAG. THE COLOR BLUE APPEARS IN THE LINES THAT CROSS EACH OTHER TO FORM AN "X" PATTERN ON THE FLAG DESIGN. THE COLOR WHITE APPEARS IN THE DEPICTION OF THE STARS AND IN THE OUTLINE BORDER OF THE "X" PATTERN ON THE FLAG DESIGN. THE COLOR WHITE ALSO APPEARS IN FLAME-LIKE DESIGNS ON THE RIGHT-HAND-SIDE OF THE FLAG DESIGN AND IN THE UPPER-LEFT-HAND-SIDE OF THE FLAG DESIGN. THE COLOR WHITE ALSO APPEARS IN A PART OF EACH OF THE LETTERS IN THE PHRASE TRY TO TAKE THESE DOWN AND IN THE BACKGROUND BEHIND THE WORDS. THE COLOR BLACK APPEARS IN PART OF EACH OF THE LETTERS IN THE PHRASE TRY TO TAKE THESE DOWN.

FOR PANTIES; PANTIES, SHORTS AND BRIEFS; SHORT-SLEEVED OR LONG-SLEEVED T-SHIRTS; SHORT-SLEEVED SHIRTS; SLEEP SHIRTS; SPORT SHIRTS; SPORTS SHIRTS; SPORTS SHIRTS WITH SHORT SLEEVES; SWEAT SHIRTS; T-SHIRTS; THONGS (U.S. CLS. 22 AND 39).

AMY GEARIN, EXAMINING ATTORNEY

CLASS 25—(Continued).

SN 78-862,677. OZONE DESIGN INC., NEW YORK, NY. FILED 4-17-2006.

SIGNAL SENDER

THE MARK CONSISTS OF STANDARD CHARACTERS WITHOUT CLAIM TO ANY PARTICULAR FONT, STYLE, SIZE, OR COLOR.

FOR APPAREL, NAMELY, SOCKS, HOSIERY, UNDERWEAR, BODY STOCKINGS, T-SHIRTS, LEGGINGS, LEG WARMERS, LEOTARDS, UNITARDS, KNEE-HIGH STOCKINGS, TIGHTS FOR WOMEN, MEN AND CHILDREN OF NYLON, COTTON OR OTHER TEXTILE FIBERS, BODY SUITS (U.S. CLS. 22 AND 39).

LINDA MICKLEBURGH, EXAMINING ATTORNEY

SN 78-862,682. OZONE DESIGN INC., NEW YORK, NY. FILED 4-17-2006.

FLASHWEAR

THE MARK CONSISTS OF STANDARD CHARACTERS WITHOUT CLAIM TO ANY PARTICULAR FONT, STYLE, SIZE, OR COLOR.

FOR APPAREL, NAMELY, SOCKS, HOSIERY, UNDERWEAR, BODY STOCKINGS, T-SHIRTS, LEGGINGS, LEG WARMERS, LEOTARDS, UNITARDS, KNEE-HIGH STOCKINGS, TIGHTS FOR WOMEN, MEN AND CHILDREN OF NYLON, COTTON OR OTHER TEXTILE FIBERS, BODY SUITS (U.S. CLS. 22 AND 39).

LINDA MICKLEBURGH, EXAMINING ATTORNEY

SN 78-862,692. RED FLY ENTERPRISE CORP, HASBROUCK HEIGHTS, NJ. FILED 4-17-2006.

5ive Chic

THE MARK CONSISTS OF STANDARD CHARACTERS WITHOUT CLAIM TO ANY PARTICULAR FONT, STYLE, SIZE, OR COLOR.

FOR CAPRI PANTS; DENIM JACKETS; DENIMS; DOWN JACKETS; DRESS SHIRTS; FUR COATS AND JACKETS; FUR JACKETS; HATS; HEAVY JACKETS; JACKETS; KNIT SHIRTS; LEATHER JACKETS; PANTS; PIQUET SHIRTS; POLO SHIRTS; SHIRTS; SHORT-SLEEVED OR LONG-SLEEVED T-SHIRTS; SHORT-SLEEVED SHIRTS; SKIRTS; SKIRTS AND DRESSES; SLEEP SHIRTS; SPORT SHIRTS; SWEAT PANTS; SWEATERS; TRACK PANTS (U.S. CLS. 22 AND 39).

NAKWAMA ANKRAH, EXAMINING ATTORNEY

CLASS 25—(Continued).

SN 78-862,793. IMPACT SALES & MARKETING, INC.,
BARRINGTON, IL. FILED 4-17-2006.

PLAY 'N' WASH

THE MARK CONSISTS OF STANDARD CHARACTERS
WITHOUT CLAIM TO ANY PARTICULAR FONT, STYLE,
SIZE, OR COLOR.

FOR FOOTWEAR (U.S. CLS. 22 AND 39).
JENNIFER MARTIN, EXAMINING ATTORNEY

SN 78-863,222. CATINDIG, RICKY P., HAGATNA, GUAM,
FILED 4-17-2006.



THE MARK CONSISTS OF STYLIZED WORDS IN A BOX.
THE FOREIGN WORDING IN THE MARK TRANSLATES
INTO ENGLISH AS EXCITED, ANGERED, FIGHTING
(MAD).

FOR BEANIES; CAPS; CLOTH BIBS; HATS; PANTS;
SHORTS; SKIRTS; SOCKS; SWEAT PANTS; SWEAT
SHIRTS; T-SHIRTS; VISORS (U.S. CLS. 22 AND 39).
DARRYL SPRUILL, EXAMINING ATTORNEY

SN 78-863,225. BOYD, LISA S., MILL VALLEY, CA. FILED 4-
17-2006.

cool tots

THE MARK CONSISTS OF STANDARD CHARACTERS
WITHOUT CLAIM TO ANY PARTICULAR FONT, STYLE,
SIZE, OR COLOR.

FOR BOTTOMS; HATS; JACKETS; SCARVES; TOPS;
VESTS (U.S. CLS. 22 AND 39).
FIRST USE 1-1-2005; IN COMMERCE 1-1-2005.
MATTHEW MCDOWELL, EXAMINING ATTORNEY

CLASS 25—(Continued).

SN 78-863,275. JOHNSTON, BRIAN, SANTA CRUZ, CA.
FILED 4-17-2006.

Outcold

THE MARK CONSISTS OF STANDARD CHARACTERS
WITHOUT CLAIM TO ANY PARTICULAR FONT, STYLE,
SIZE, OR COLOR.

FOR CAPS; CLOTHING FOR WEAR IN JUDO PRACTICES;
CLOTHING FOR WEAR IN WRESTLING GAMES;
HOODS; JERSEYS; SHORT SETS; TOPS (U.S.
CLS. 22 AND 39).

FIRST USE 4-1-2005; IN COMMERCE 3-12-2006.
TRACY CROSS, EXAMINING ATTORNEY

SN 78-863,316. BIARS, LEE, BALTIMORE, MD. FILED 4-18-
2006.

Pot Committed

THE MARK CONSISTS OF STANDARD CHARACTERS
WITHOUT CLAIM TO ANY PARTICULAR FONT, STYLE,
SIZE, OR COLOR.

FOR SHIRTS, JACKETS, FLEECE PULLOVERS, HATS,
SWEATPANTS (U.S. CLS. 22 AND 39).
STEVEN PEREZ, EXAMINING ATTORNEY

SN 78-863,388. RONA, INC., MARIETTA, GA. FILED 4-18-
2006.

REGGAE FEVA

THE MARK CONSISTS OF STANDARD CHARACTERS
WITHOUT CLAIM TO ANY PARTICULAR FONT, STYLE,
SIZE, OR COLOR.

FOR CLOTHING, NAMELY JEANS (U.S. CLS. 22 AND
39).

SHARON MEIER, EXAMINING ATTORNEY

CLASS 25—(Continued).

SN 78-863,475. ORANGE CLOTHING CO., MIAMI, FL.
FILED 4-18-2006.

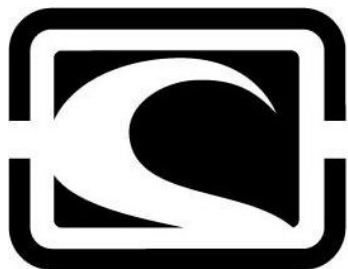

THE MARK CONSISTS OF A CRESTING WAVE INSIDE A BOX WITH ROUNDED CORNERS.

FOR BERMUDA SHORTS; BIKINIS; BOARD SHORTS; BOXER SHORTS; CAP VISORS; CAPS; GLOVES; GYM SHORTS; HATS; JACKETS; PANTS; POLO SHIRTS; SHIRTS; SHORTS; SOCKS; SPORT SHIRTS; SWEAT SHIRTS; SWIM TRUNKS; SWIM WEAR; SWIMSUITS; T-SHIRTS (U.S. CLS. 22 AND 39).

FIRST USE 7-0-2005; IN COMMERCE 7-0-2005.
PAUL CROWLEY, EXAMINING ATTORNEY

SN 78-863,821. HILLIARD, BRIAN WESLEY, SIMPSON-VILLE, SC. FILED 4-18-2006.

LIVE LIFE ALL-IN

THE MARK CONSISTS OF STANDARD CHARACTERS WITHOUT CLAIM TO ANY PARTICULAR FONT, STYLE, SIZE, OR COLOR.

FOR CLOTHING, NAMELY SHORT-SLEEVED AND LONG-SLEEVED T-SHIRTS, GOLF SHIRTS, SWEAT SHIRTS, SHORTS, TANK TOPS, HALTER TOPS, ONE-PIECE GARMENTS FOR INFANTS AND TODDLERS, SWEAT PANTS, HATS, CAPS, VISORS, BANDANAS, PAJAMAS, NIGHTGOWNS, UNDERWEAR, JACKETS, WRISTBANDS, HEADBANDS, AND NECKTIES (U.S. CLS. 22 AND 39).

CATHERINE FAINT, EXAMINING ATTORNEY

SN 78-863,849. NGAMJIRAPHAK, PRINCE, CERRITOS, CA.
FILED 4-18-2006.

NBN  **GEAR**

NO CLAIM IS MADE TO THE EXCLUSIVE RIGHT TO USE "GEAR", APART FROM THE MARK AS SHOWN.

FOR MEN, WOMEN, AND CHILDREN'S APPAREL, NAMELY SHIRTS, T-SHIRTS, POLO SHIRTS, PANTS, SHORTS, JEANS, WARM UP SUITS, JACKETS, CAPS, SOCKS, BOXER BRIEFS, AND SLEEPWEAR (U.S. CLS. 22 AND 39).

FIRST USE 11-0-2005; IN COMMERCE 11-0-2005.
JOHN SCHUYLER YARD, EXAMINING ATTORNEY

CLASS 25—(Continued).

SN 78-863,927. LUCAS, GAVIN, LAS VEGAS, NV. FILED 4-18-2006.

IMPERIAL CROWN

THE MARK CONSISTS OF STANDARD CHARACTERS WITHOUT CLAIM TO ANY PARTICULAR FONT, STYLE, SIZE, OR COLOR.

FOR CLOTHING, NAMELY, SHIRTS, T-SHIRTS, TOPS, SHORTS, PANTS, SWEATSHIRTS, FOOTWEAR, HEADWEAR AND JACKETS (U.S. CLS. 22 AND 39).

SONYA STEPHENS, EXAMINING ATTORNEY

SN 78-864,024. TADDEO, PIETRO, CEDAR KNOLLS, NJ.
FILED 4-18-2006.

PIETRO TADDEO IMPORTS

THE MARK CONSISTS OF STANDARD CHARACTERS WITHOUT CLAIM TO ANY PARTICULAR FONT, STYLE, SIZE, OR COLOR.

NO CLAIM IS MADE TO THE EXCLUSIVE RIGHT TO USE IMPORTS, APART FROM THE MARK AS SHOWN.

FOR BELTS; CAPS; FOULARDS; HOODS; JERSEYS; LEATHER BELTS; MANTLES; MUFFLERS; SHIRTS; SHORT SETS; SHOULDER WRAPS; SWADDLING CLOTHES; TIES; TOPS; WRAPS (U.S. CLS. 22 AND 39).

FIRST USE 7-6-2005; IN COMMERCE 7-6-2005.

PAUL E. FAHRENKOPF, EXAMINING ATTORNEY

SN 78-864,186. COCHRAN, SAMYA, SCOTTSDALE, AZ.
FILED 4-18-2006.

Firedaughter

THE MARK CONSISTS OF STANDARD CHARACTERS WITHOUT CLAIM TO ANY PARTICULAR FONT, STYLE, SIZE, OR COLOR.

FOR CLOTHING FOR INFANTS, TODDLERS, AND WOMEN, NAMELY, T-SHIRTS, ONE PIECE GARMENTS FOR INFANTS AND TODDLERS, DRESSES, PANTS, TANK TOPS, AND HATS, ALL DESIGNED FOR THE CHILDREN AND WIVES OF FIREFIGHTERS (U.S. CLS. 22 AND 39).

ATTIYA MALIK, EXAMINING ATTORNEY

CLASS 25—(Continued).

SN 78-864,282. GIRARD, GERIK, WAKEFIELD, RI. FILED 4-18-2006.

STRESS IS EVIL

THE MARK CONSISTS OF STANDARD CHARACTERS WITHOUT CLAIM TO ANY PARTICULAR FONT, STYLE, SIZE, OR COLOR.

FOR CLOTHING, NAMELY T-SHIRTS, SHIRTS, TANKTOPS, PANTS, SHORTS, SWEATSHIRTS AND HEADWEAR, NAMELY CAPS, HATS AND HEADBANDS (U.S. CLS. 22 AND 39).

SAMUEL E. SHARPER JR., EXAMINING ATTORNEY

SN 78-864,290. FIX, MICHELLE M., NEW YORK, NY. AND DUNLEAVY, VINCENT A., NEW YORK, NY. FILED 4-18-2006.

No Filter.

THE MARK CONSISTS OF STANDARD CHARACTERS WITHOUT CLAIM TO ANY PARTICULAR FONT, STYLE, SIZE, OR COLOR.

FOR BELTS; BOXER SHORTS; CAPS; COATS; HATS; INFANTWEAR; JACKETS; PAJAMAS; PANTS; RAIN-COATS; ROBES; SCARVES; SHIRTS; SKIRTS; SLIPPERS; SOCKS; SWEATERS; T-SHIRTS; UNDERSHIRTS; UNDERWEAR (U.S. CLS. 22 AND 39).

NANCY CLARKE, EXAMINING ATTORNEY

SN 78-864,424. BEALE STREET GRILL INC., THE, BATH, ME. FILED 4-19-2006.



OWNER OF U.S. REG. NOS. 2,720,423, 2,896,996 AND 2,896,997.

THE MARK CONSISTS OF THE WORDS BEALE STREET BARBEQUE WITH A FIGURE HOLDING A MUSICAL INSTRUMENT AND LEANING AGAINST A LAMPOST.

FOR CLOTHING, NAMELY T-SHIRTS (U.S. CLS. 22 AND 39).

FIRST USE 0-0-1996; IN COMMERCE 0-0-1996.

ANNE E. GUSTASON, EXAMINING ATTORNEY

CLASS 25—(Continued).

SN 78-864,444. BELLI, GIANLUCA, HALLANDALE BEACH, FL. FILED 4-19-2006.



THE MARK CONSISTS OF AN APPLE WITH A BITE ON THE LEFT SIDE AND THE SIGN "DOCTOR SIN" INSIDE THE APPLE.

FOR CLOTHING, NAMELY T-SHIRTS, SHIRTS, PANTS, SKIRTS, DRESSES, BLOUSES WITH CONDOM IN THE LABEL (U.S. CLS. 22 AND 39).

FIRST USE 9-1-2004; IN COMMERCE 3-1-2005.

CAROLINE WOOD, EXAMINING ATTORNEY

SN 78-864,456. TLS INTERNATIONAL, LLC, NEEDHAM, MA. FILED 4-19-2006.

STEFENO

FOR HEADWEAR, NAMELY HATS (U.S. CLS. 22 AND 39).

BRIDGETT SMITH, EXAMINING ATTORNEY

SN 78-864,532. LMH, INC., WILMINGTON, DE. FILED 4-19-2006.

Best Beginnings

THE MARK CONSISTS OF STANDARD CHARACTERS WITHOUT CLAIM TO ANY PARTICULAR FONT, STYLE, SIZE, OR COLOR.

OWNER OF U.S. REG. NO. 1,985,858.

FOR CLOTHING, NAMELY SLEEPWEAR, COVERALLS, SHIRTS, PANTS, AND KIMONOS (U.S. CLS. 22 AND 39).

FIRST USE 1-1-1994; IN COMMERCE 1-1-1994.

ANDREA SAUNDERS, EXAMINING ATTORNEY

CLASS 25—(Continued).

SN 78-864,885. LONTEX CORPORATION, NORRISTOWN, PA. FILED 4-19-2006.

COOL COMPRESSION

THE MARK CONSISTS OF STANDARD CHARACTERS WITHOUT CLAIM TO ANY PARTICULAR FONT, STYLE, SIZE, OR COLOR.

NO CLAIM IS MADE TO THE EXCLUSIVE RIGHT TO USE "COMPRESSION", APART FROM THE MARK AS SHOWN.

FOR MEN'S, WOMEN'S AND CHILDREN'S CLOTHING, NAMELY, SOCKS, UNDERWEAR INCLUDING BOXER SHORTS, BRIEFS, BIKINI UNDERPANTS, AND LONG JOHNS, TSHIRTS, POLO SHIRTS, SWIMWEAR, COMPRESSION SHIRTS, COMPRESSION SHORTS, COMPRESSION TIGHTS, SWEATPANTS, SWEATSHIRTS, BODY ARMOR CARRIER COMPRESSION SHIRTS FOR MILITARY AND LAW ENFORCEMENT PERSONNEL, SPORTS BRAS, HALTER TOPS, SINGLET, CAPS, HATS, HEADBANDS, BANDANAS, BALACLAVAS, SNEAKERS AND SHOES (U.S. CLS. 22 AND 39).

BARBARA A. LOUGHRAN, EXAMINING ATTORNEY

SN 78-864,931. MARTINEZ, DAMIAN Y., LOMITA, CA. FILED 4-19-2006.

CONFIDENCE IS QUEEN-C.I.Q.

THE MARK CONSISTS OF STANDARD CHARACTERS WITHOUT CLAIM TO ANY PARTICULAR FONT, STYLE, SIZE, OR COLOR.

FOR SHIRTS, HATS, PANTS, SHOES, BELTS (U.S. CLS. 22 AND 39).

CIMMERIAN COLEMAN, EXAMINING ATTORNEY

SN 78-865,177. CALCADOS AZALEIA S.A., PAROBE - RS, BRAZIL, FILED 4-19-2006.



FOR CLOTHING, NAMELY, SWIM WEAR, T-SHIRTS, JOGGING SUITS, TRUNKS AND SHORTS; FOOTWEAR, NAMELY, SANDALS, SNEAKERS, CLEATS, SLIPPERS, TENNIS SHOES; CAPS, SOCKS (U.S. CLS. 22 AND 39).

JOHN KELLY, EXAMINING ATTORNEY

CLASS 25—(Continued).

SN 78-865,190. PALM, CRAIG, RANCHO SANTA MARGARITA, CA. FILED 4-19-2006.

Mekilla

THE MARK CONSISTS OF STANDARD CHARACTERS WITHOUT CLAIM TO ANY PARTICULAR FONT, STYLE, SIZE, OR COLOR.

FOR BEANIES; BOARD SHORTS; HATS; SHORT-SLEEVED OR LONG-SLEEVED T-SHIRTS; SWEAT SHIRTS; T-SHIRTS (U.S. CLS. 22 AND 39).

PAULA MAYS, EXAMINING ATTORNEY

SN 78-865,503. VIACOM INTERNATIONAL INC., NEW YORK, NY. FILED 4-20-2006.

NICK MOODS

THE MARK CONSISTS OF STANDARD CHARACTERS WITHOUT CLAIM TO ANY PARTICULAR FONT, STYLE, SIZE, OR COLOR.

OWNER OF U.S. REG. NOS. 1,399,356, 2,893,829 AND OTHERS.

FOR CLOTHING, NAMELY, BATHING SUITS, BELTS, HALLOWEEN COSTUMES, COATS, SOCKS, CLOTHING BELTS, FOOTWEAR, BANDANNAS, DRESSES, GLOVES, GYM SHORTS, EAR MUFFS, NECK WEAR, JACKETS, PAJAMAS, PANTS, SHIRTS, SHORTS, SKI WEAR, SLACKS, SUN VISORS, SUSPENDERS, SWEATERS, TURTLENECKS, UNDERCLOTHES, VESTS, WARM-UP SUITS, HEADWEAR, BATHROBES, BEACHWEAR (U.S. CLS. 22 AND 39).

MARK PILARO, EXAMINING ATTORNEY

SN 78-865,636. KOTONI TRADING, INC., MONTEREY PARK, CA. FILED 4-20-2006.



THE MARK CONSISTS OF STANDARD CHARACTERS WITHOUT CLAIM TO ANY PARTICULAR FONT, STYLE, SIZE, OR COLOR.

FOR FOOTWEAR FOR MEN (U.S. CLS. 22 AND 39).

MARIA-VICTORIA SUAREZ, EXAMINING ATTORNEY

CLASS 25—(Continued).

SN 78-865,640. KONIS, WENDY M., LAS VEGAS, NV. FILED 4-20-2006.

Kelly Tee's

THE MARK CONSISTS OF STANDARD CHARACTERS WITHOUT CLAIM TO ANY PARTICULAR FONT, STYLE, SIZE, OR COLOR.

NO CLAIM IS MADE TO THE EXCLUSIVE RIGHT TO USE "TEES", APART FROM THE MARK AS SHOWN.

FOR TEE SHIRTS, SHIRTS, PANTS, DRESSES, SKIRTS, HEADWEAR (U.S. CLS. 22 AND 39).
MARIA-VICTORIA SUAREZ, EXAMINING ATTORNEY

SN 78-865,689. PACIFIC MARKETING WORKS, INC., DBA 2K BY GINGHAM, LOS ANGELES, CA. FILED 4-20-2006.

FUN BEEZ

THE MARK CONSISTS OF STANDARD CHARACTERS WITHOUT CLAIM TO ANY PARTICULAR FONT, STYLE, SIZE, OR COLOR.

FOR BELTS; BLOUSES; CAPS; COATS; DRESSES; HATS; JACKETS; PANTS; SHIRTS; SKIRTS; SOCKS; SWEAT SHIRTS; SWEATERS; TOPS; UNDERWEAR (U.S. CLS. 22 AND 39).

HEATHER SAPP, EXAMINING ATTORNEY

SN 78-865,812. MORTON, VICTORIA M., CLEARWATER, FL. FILED 4-20-2006.

RECKLESS LADY

THE MARK CONSISTS OF STANDARD CHARACTERS WITHOUT CLAIM TO ANY PARTICULAR FONT, STYLE, SIZE, OR COLOR.

NO CLAIM IS MADE TO THE EXCLUSIVE RIGHT TO USE "LADY", APART FROM THE MARK AS SHOWN.

FOR BODY SHAPERS; BODY SUITS; BRAS; BUS-TIERS; CAMISOLES; CORSETS; FOUNDATION GAR-MENTS; GARTER BELTS; GIRDLES; HOSIERY; LINGERIE; LOUNGEWEAR; NEGLIGÉES; NIGHT GOWNS; NIGHT SHIRTS; PAJAMAS; PANTIES; PANTY-HOSE; STOCKINGS; TAP PANTS; TEDDIES; THONGS; UNDERWEAR (U.S. CLS. 22 AND 39).

FIRST USE 10-20-2005; IN COMMERCE 10-20-2005.
ESTHER BELENKER, EXAMINING ATTORNEY

CLASS 25—(Continued).

SN 78-865,852. DPC MARKETING, INC., LAS VEGAS, NV. FILED 4-20-2006.



THE STIPLING IS A FEATURE OF THE MARK.
THE COLOR(S) RED AND BLACK IS/ARE CLAIMED AS A FEATURE OF THE MARK.

THE MARK CONSISTS OF A BLACK LOWERCASE D, P, AND C ON TOP OF EACH OTHER TO CREATE A DESIGN WITH A RED DOT IN THE MIDDLE OF THE LETTERS, SLIGHTLY SMEARED IN PLACES TO LOOK LIKE WET OR DRIPPING PAINT.

FOR CLOTHING, NAMELY SHIRTS, HATS, AND SHORTS (U.S. CLS. 22 AND 39).

FIRST USE 6-1-2002; IN COMMERCE 6-1-2002.
PAULA MAYS, EXAMINING ATTORNEY

SN 78-866,148. MASONLEE, INC., LOS ANGELES, CA. FILED 4-20-2006.

MicheLLe Mason

THE MARK CONSISTS OF STANDARD CHARACTERS WITHOUT CLAIM TO ANY PARTICULAR FONT, STYLE, SIZE, OR COLOR.

THE NAME(S), PORTRAIT(S), AND/OR SIGNATURE(S) SHOWN IN THE MARK IDENTIFIES MICHELLE MASON, WHOSE CONSENT(S) TO REGISTER IS SUBMITTED.

FOR CLOTHING, NAMELY JACKETS, SWEATERS, TOPS, BOTTOMS, SKIRTS, PANTS, DRESSES, SUITS, SHIRTS, COATS, BLOUSES, TRENCH COATS, JEANS AND LINGERIE; HEADWEAR, NAMELY SCARVES, HATS AND CAPS; SWIMWEAR, BELTS, GLOVES; FOOT-WEAR, NAMELY SHOES, BOOTS, SOCKS AND SANDALS (U.S. CLS. 22 AND 39).

FIRST USE 1-8-1998; IN COMMERCE 1-8-1998.
ROBIN CHOSID, EXAMINING ATTORNEY

CLASS 25—(Continued).

SN 78-866,168. DINGMAN, MARTIN, LEAD HILL, AR.
FILED 4-20-2006.



OWNER OF U.S. REG. NO. 2,013,055.
THE MARK CONSISTS OF THE OUTLINE OF A DIAMOND WITH THE INTERTWINED INITIALS MD IN THE CENTER OVERLAYING A BACKGROUND IN HORIZONTAL STRIPES.

FOR SHOES (U.S. CLS. 22 AND 39).
FIRST USE 1-31-2002; IN COMMERCE 1-31-2002.
JUDITH HELFMAN, EXAMINING ATTORNEY

SN 78-866,711. JIB HUNT, LLC, NEW YORK, NY. FILED 4-21-2006.



THE MARK CONSISTS OF A STYLIZED J AND H WHICH FORM A CIRCLE NEXT TO A DOT.

FOR CAPS ; JACKETS; JEANS; PANTS; POLO SHIRTS; SHIRTS; SHORTS; SWEAT SHIRTS; SWEATERS; T-SHIRTS (U.S. CLS. 22 AND 39).

FIRST USE 2-1-2005; IN COMMERCE 7-1-2005.
CAROLYN CATALDO, EXAMINING ATTORNEY

CLASS 25—(Continued).

SN 78-866,725. OFFICIAL SPORTS INTERNATIONAL, INC.,
WARSAW, IN. FILED 4-21-2006.

OFFICIAL SPORTS

THE MARK CONSISTS OF STANDARD CHARACTERS WITHOUT CLAIM TO ANY PARTICULAR FONT, STYLE, SIZE, OR COLOR.

OWNER OF U.S. REG. NO. 3,050,579.

NO CLAIM IS MADE TO THE EXCLUSIVE RIGHT TO USE SPORTS, APART FROM THE MARK AS SHOWN.

FOR SOCCER AND REFEREE APPAREL NAMELY, SHIRTS, SHORTS, SOCKS, WARM-UP SUITS, RAINWEAR, T-SHIRTS, AND JACKETS (U.S. CLS. 22 AND 39).
FIRST USE 6-8-1984; IN COMMERCE 6-3-1985.
TARAH HARDY, EXAMINING ATTORNEY

SN 78-866,821. ABERCROMBIE & FITCH TRADING CO.,
NEW ALBANY, OH. FILED 4-21-2006.

SARANAC BOOT

THE MARK CONSISTS OF STANDARD CHARACTERS WITHOUT CLAIM TO ANY PARTICULAR FONT, STYLE, SIZE, OR COLOR.

NO CLAIM IS MADE TO THE EXCLUSIVE RIGHT TO USE "BOOT", APART FROM THE MARK AS SHOWN.

FOR CLOTHING, NAMELY, JEANS (U.S. CLS. 22 AND 39).

FIRST USE 6-0-2004; IN COMMERCE 6-0-2004.

RONALD AIKENS, EXAMINING ATTORNEY

SN 78-866,840. ABERCROMBIE & FITCH TRADING CO.,
NEW ALBANY, OH. FILED 4-21-2006.

KILBURN LOW RISE BOOT

THE MARK CONSISTS OF STANDARD CHARACTERS WITHOUT CLAIM TO ANY PARTICULAR FONT, STYLE, SIZE, OR COLOR.

NO CLAIM IS MADE TO THE EXCLUSIVE RIGHT TO USE "LOW RISE BOOT", APART FROM THE MARK AS SHOWN.

FOR CLOTHING, NAMELY, JEANS (U.S. CLS. 22 AND 39).

FIRST USE 6-0-2005; IN COMMERCE 6-0-2005.

RONALD AIKENS, EXAMINING ATTORNEY

CLASS 25—(Continued).

SN 78-866,848. ABERCROMBIE & FITCH TRADING CO.,
NEW ALBANY, OH. FILED 4-21-2006.

EMMA LOW RISE BOOT

THE MARK CONSISTS OF STANDARD CHARACTERS
WITHOUT CLAIM TO ANY PARTICULAR FONT, STYLE,
SIZE, OR COLOR.

NO CLAIM IS MADE TO THE EXCLUSIVE RIGHT TO
USE "LOW RISE BOOT", APART FROM THE MARK AS
SHOWN.

FOR CLOTHING, NAMELY, JEANS (U.S. CLS. 22 AND
39).

FIRST USE 12-0-2004; IN COMMERCE 12-0-2004.
RONALD AIKENS, EXAMINING ATTORNEY

SN 78-866,855. ABERCROMBIE & FITCH TRADING CO.,
NEW ALBANY, OH. FILED 4-21-2006.

BAXTER LOW RISE SLIM BOOT

THE MARK CONSISTS OF STANDARD CHARACTERS
WITHOUT CLAIM TO ANY PARTICULAR FONT, STYLE,
SIZE, OR COLOR.

NO CLAIM IS MADE TO THE EXCLUSIVE RIGHT TO
USE "LOW RISE SLIM BOOT", APART FROM THE MARK
AS SHOWN.

FOR CLOTHING, NAMELY, JEANS (U.S. CLS. 22 AND
39).

FIRST USE 7-0-2005; IN COMMERCE 7-0-2005.
RONALD AIKENS, EXAMINING ATTORNEY

SN 78-867,361. ABERCROMBIE & FITCH TRADING CO.,
NEW ALBANY, OH. FILED 4-21-2006.

MADISON LOW RISE FLARE

THE MARK CONSISTS OF STANDARD CHARACTERS
WITHOUT CLAIM TO ANY PARTICULAR FONT, STYLE,
SIZE, OR COLOR.

NO CLAIM IS MADE TO THE EXCLUSIVE RIGHT TO
USE "LOW RISE FLARE", APART FROM THE MARK AS
SHOWN.

FOR CLOTHING, NAMELY, JEANS (U.S. CLS. 22 AND
39).

FIRST USE 12-0-2004; IN COMMERCE 12-0-2004.
RONALD AIKENS, EXAMINING ATTORNEY

CLASS 25—(Continued).

SN 78-867,362. ABERCROMBIE & FITCH TRADING CO.,
NEW ALBANY, OH. FILED 4-21-2006.

ERIN LOW RISE SKINNY

THE MARK CONSISTS OF STANDARD CHARACTERS
WITHOUT CLAIM TO ANY PARTICULAR FONT, STYLE,
SIZE, OR COLOR.

NO CLAIM IS MADE TO THE EXCLUSIVE RIGHT TO
USE "LOW RISE SKINNY", APART FROM THE MARK AS
SHOWN.

FOR CLOTHING, NAMELY, JEANS (U.S. CLS. 22 AND
39).

FIRST USE 12-0-2005; IN COMMERCE 12-0-2005.
RONALD AIKENS, EXAMINING ATTORNEY

SN 78-867,414. 3925234 CANADA INC., MONTREAL, QUE-
BEC, CANADA, FILED 4-22-2006.

DEVOTED

THE MARK CONSISTS OF STANDARD CHARACTERS
WITHOUT CLAIM TO ANY PARTICULAR FONT, STYLE,
SIZE, OR COLOR.

OWNER OF CANADA REG. NO. TMA654878, DATED 12-
13-2005, EXPIRES 12-13-2020.

FOR LADIES AND MEN'S CLOTHING AND ACCES-
SORIES, NAMELY, TOPS, SHIRTS, PANTS, JACKETS,
SKIRTS, COATS, HATS, SCARVES AND PONCHOS (U.S.
CLS. 22 AND 39).

AMY HELLA, EXAMINING ATTORNEY

SN 78-867,467. TAKAYAMA, DONALD, CARLSBAD, CA.
AND TAKAYAMA, DIANE, CARLSBAD, CA. FILED 4-22-
2006.

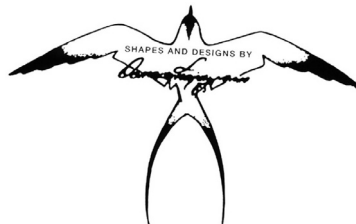

NO CLAIM IS MADE TO THE EXCLUSIVE RIGHT TO
USE "SHAPES AND DESIGNS BY", APART FROM THE
MARK AS SHOWN.

THE MARK CONSISTS OF A LINE DRAWING OF A
FRIGATE BIRD WITH OUTSTREACHED WINGS AND
LONG FORKED TAIL. THE WORDS "SHAPES AND DE-
SIGNS BY" ARE SUPERIMPOSED ON THE BIRD'S BACK
ALONG WITH THE SIGNATURE OF DONALD TAKAYA-
MA.

FOR HATS; T-SHIRTS (U.S. CLS. 22 AND 39).
FIRST USE 6-0-1985; IN COMMERCE 6-0-1985.
KRISTINA KLOIBER, EXAMINING ATTORNEY

CLASS 25—(Continued).

SN 78-867,644. FONG, RAYMOND, LONG BEACH, CA.
FILED 4-24-2006.



THE MARK CONSISTS OF THE LETTER "B" ON THE LEFT SIDE OF A "STAR WITHIN A CIRCLE" FOLLOWED BY THE LETTER "G" ON THE RIGHT SIDE". PLACED BELOW THE "BSTARG" IMAGE IS A STYLIZED FONT OF THE WORDS "BATTLE" NEXT TO A "STAR WITHIN A CIRCLE" FOLLOWED BY THE WORD "GARAGE" ON THE RIGHT SIDE OF THE STAR.

FOR HATS; JACKETS; PANTS; SHIRTS; SHOES; SHORTS; SWEAT SHIRTS (U.S. CLS. 22 AND 39).
FIRST USE 7-11-2004; IN COMMERCE 8-24-2004.
CAROLYN CATALDO, EXAMINING ATTORNEY

SN 78-868,065. BUCALO, GLADYS L., AVENTURA, FL.
FILED 4-24-2006.

PEP UP SHOES

THE MARK CONSISTS OF STANDARD CHARACTERS WITHOUT CLAIM TO ANY PARTICULAR FONT, STYLE, SIZE, OR COLOR.

NO CLAIM IS MADE TO THE EXCLUSIVE RIGHT TO USE "SHOES", APART FROM THE MARK AS SHOWN.
FOR FOOTWEAR (U.S. CLS. 22 AND 39).
WENDY JUN, EXAMINING ATTORNEY

SN 78-868,352. MELLICK, SANDRA, CARLSBAD, CA. AND OLSON, SUSAN, BEND, OR. FILED 4-24-2006.

Babblin' Baby

THE MARK CONSISTS OF STANDARD CHARACTERS WITHOUT CLAIM TO ANY PARTICULAR FONT, STYLE, SIZE, OR COLOR.

NO CLAIM IS MADE TO THE EXCLUSIVE RIGHT TO USE "BABY", APART FROM THE MARK AS SHOWN.
FOR INFANT AND TODDLER ONE PIECE CLOTHING (U.S. CLS. 22 AND 39).
ESTHER BELENKER, EXAMINING ATTORNEY

CLASS 25—(Continued).

SN 78-868,387. LAGRUA, JOSEPH, COUDERSPORT, PA.
FILED 4-24-2006.

**Hard Tellin...Not Knowin
and Hard Telling...Not
Knowing**

THE MARK CONSISTS OF STANDARD CHARACTERS WITHOUT CLAIM TO ANY PARTICULAR FONT, STYLE, SIZE, OR COLOR.

FOR HATS; SWEAT SHIRTS; T-SHIRTS (U.S. CLS. 22 AND 39).
MARIA-VICTORIA SUAREZ, EXAMINING ATTORNEY

SN 78-868,505. K GAL STUDIO, INC., CHICAGO, IL. FILED 4-24-2006.

Oil on Denim

THE MARK CONSISTS OF STANDARD CHARACTERS WITHOUT CLAIM TO ANY PARTICULAR FONT, STYLE, SIZE, OR COLOR.

NO CLAIM IS MADE TO THE EXCLUSIVE RIGHT TO USE DENIM, APART FROM THE MARK AS SHOWN.
FOR CLOTHING, NAMELY JEANS ADORNED WITH PAINTED ARTWORK (U.S. CLS. 22 AND 39).
JOHN HWANG, EXAMINING ATTORNEY

SN 78-868,866. NOTCO, INC., NORTH HOLLYWOOD, CA.
FILED 4-25-2006.

THE FEETISH CLUB

THE MARK CONSISTS OF STANDARD CHARACTERS WITHOUT CLAIM TO ANY PARTICULAR FONT, STYLE, SIZE, OR COLOR.

FOR FOOTWEAR (U.S. CLS. 22 AND 39).
LAURIE MAYES, EXAMINING ATTORNEY

CLASS 25—(Continued).

SN 78-869,291. ESEBAG, JIMMY, BEVERLY HILLS, CA. FILED 4-25-2006.



THE MARK CONSISTS OF STYLIZED LETTERS "ST".
FOR BELTS; BLOUSES; COATS; DRESSES; GLOVES;
HATS; HOSIERY; JACKETS; LOUNGEWEAR; OVER-
ALLS; PANTS; RAINWEAR; SCARVES; SHIRTS; SHOES;
SHORTS; SKIRTS; SLEEPWEAR; SLIPPERS; SOCKS;
SWEAT PANTS; SWEAT SHIRTS; SWIM WEAR; TIES;
VESTS (U.S. CLS. 22 AND 39).

RONALD MCMORROW, EXAMINING ATTORNEY

SN 78-869,381. CAPORI USA INC., NEW YORK, NY. FILED 4-25-2006.



THE MARK CONSISTS OF THE WORD "MASIMO" WITH
THE LETTER "I" IN THE CONTOUR OF A BUILDING.

FOR CLOTHING, NAMELY, SPORTS COATS, SPORT
SHIRTS, SPORTS JACKETS, SPORTS JERSEYS AND
BRECHES FOR SPORTS, SWIMSUITS, UNDERWEAR,
DRESSES, JACKETS, SUITS, PANTS, COATS, OVER-
COATS, PARKAS, WARM UP SUITS, SHIRTS, TANK
TOPS, SHORTS, SKIRTS, T-SHIRTS, TROUSERS, VESTS,
WIND VESTS, RAINCOATS, RAIN SUITS, BELTS,
GLOVES, NECKTIES, SCARVES; FOOTWEAR,
NAMELY, SHOES, BOOTS, ATHLETIC SHOES,
LEATHER SHOES, SANDALS, SLIPPERS, SOCKS
STOCKINGS; HEADGEAR, NAMELY, CAPS AND HATS
(U.S. CLS. 22 AND 39).

FIRST USE 4-7-2006; IN COMMERCE 4-7-2006.

ALLISON HOLTZ, EXAMINING ATTORNEY

CLASS 25—(Continued).

SN 78-869,400. BLOCSTAR, INC., LOS FELIZ, CA. FILED 4-25-2006.

blocstar

THE MARK CONSISTS OF STANDARD CHARACTERS
WITHOUT CLAIM TO ANY PARTICULAR FONT, STYLE,
SIZE, OR COLOR.

FOR AFTER SKI BOOTS; ANKLE SOCKS; ANTI-
PERSPIRANT SOCKS; APRES-SKI SHOES; ATHLETIC
FOOTWEAR; ATHLETIC SHOES; ATHLETIC UNI-
FORMS; BABY BIBS NOT OF PAPER; BABY DOLL
PYJAMAS; BANDANAS; BASEBALL CAPS; BASKET-
BALL SNEAKERS; BATHING SUITS; BATHING SUITS
FOR MEN; BATHING TRUNKS; BATHROBES; BEACH
FOOTWEAR; BEACHWEAR; BEANIES; BELTS; BELTS
MADE OF LEATHER; BELTS OF TEXTILE; BERETS; BIB
OVERALLS; BICYCLE GLOVES; BICYCLING GLOVES;
BIKINIS; BLAZERS; BLOUSES; BOARD SHORTS;
BOARDSHORTS; BONNETS; BOOTIES; BOOTS; BOT-
TOMS; BOW TIES; BOXER BRIEFS; BOXER SHORTS;
BRIEFS; BRIEFS; CAMISOLES; CAMP SHIRTS; CANVAS
SHOES; CAPRI PANTS; CAPRIS; CAPS; CAPS WITH
VISORS; CARDIGANS; CHILDREN'S AND INFANTS'
CLOTH BIBS; CHILDREN'S CLOTH EATING BIBS;
CHILDREN'S HEADWEAR; CLOTH BIBS; CLOTH BIBS
FOR USE BY SENIOR CITIZENS OR PHYSICALLY- OR
MENTALLY-CHALLENGED PERSONS; COATS; COATS
FOR MEN AND WOMEN; COATS MADE OF COTTON;
COATS OF DENIM; COVERALLS; CYCLISTS' JERSEYS;
DENIM JACKETS; DENIMS; DICKIES; DOWN JACKETS;
DRESS SHIRTS; DRESS SUITS; DRESSES; DRESSING
GOWNS; EAR MUFFS; EMBOSSED SOLES AND HEELS
OF RUBBER OR OF PLASTIC MATERIALS; EVENING
DRESSES; EVENING GOWNS; FABRIC BELTS; FLEECE
PULLOVERS; FLIP FLOPS; FOOTWEAR; FOOTWEAR;
FOOTWEAR FOR MEN; FOOTWEAR FOR MEN AND
WOMEN; FOOTWEAR FOR TRACK AND FIELD ATH-
LETICS; FOOTWEAR FOR WOMEN; FOOTWEAR NOT
FOR SPORTS; FUR COATS; FUR COATS AND JACKETS;
FUR HATS; FUR JACKETS; FUR MUFFS; G-STRINGS;
GALOSHES; GLOVES; GOLF CAPS; GOLF SHIRTS;
GOLF TROUSERS; GYM SHORTS; GYM SUITS; HAL-
TER TOPS; HAT BANDS; HATS; HEAD SCARVES; HEAD
SWEATBANDS; HEAD WEAR; HEADBANDS; HEAD-
BANDS AGAINST SWEATING; HEADWEAR; HEAVY
JACKETS; HOODS; INFANT AND TODDLER ONE
PIECE CLOTHING; INFANT SLEEPERS; INFANTS'
SHOES AND BOOTS; INFANTS' TROUSERS; INFANT-
WEAR; JACKETS; JEANS; JERSEYS; JOGGING OUT-
FITS; JOGGING PANTS; JOGGING SUITS; KERCHIEFS;
KNIT SHIRTS; KNITTED CAPS; LADIES' UNDERWEAR;
LEATHER BELTS; LEATHER COATS; LEATHER HEAD-
WEAR; LEATHER JACKETS; LEATHER PANTS;
LEATHER SHOES; LEATHER SLIPPERS; LEG-WAR-
MERS; LEOTARDS AND TIGHTS FOR WOMEN, MEN
AND CHILDREN OF NYLON, COTTON OR OTHER
TEXTILE FIBERS; LIGHT-REFLECTING COATS;
LIGHT-REFLECTING JACKETS; LINGERIE; LOUNGE-
WEAR; MARTIAL ARTS UNIFORMS; MEN AND WOMEN
JACKETS, COATS, TROUSERS, VESTS; MEN'S
SOCKS; MEN'S SUITS; MEN'S SUITS, WOMEN'S SUITS;
MINISKIRTS; MITTENS; MOTORCYCLE GLOVES;
MUFFLERS; MUFFLERS; MUSCLE TOPS; NECK
BANDS; NECKERCHIEFS; NECKERCHIEFS; NECK-
TIES; NECKWEAR; NIGHT GOWNS; NIGHT SHIRTS;
NIGHTCAPS; NIGHTWEAR; OPEN-NECKED SHIRTS;
OVER COATS; OVERALLS; OVERCOATS; PAJAMAS;
PANTIES, SHORTS AND BRIEFS; PANTS; PARKAS;
POCKET KERCHIEFS; POLO SHIRTS; PONCHOS;
QUILTED VESTS; RAINWEAR; RASH GUARDS; RUB-
BER SHOES; RUGBY TOPS; RUNNING SHOES; SAN-
DALS; SCHOOL UNIFORMS; SHIRTS; SHIRTS FOR
SUITS; SHOES; SHORT TROUSERS; SHORT-SLEEVED
OR LONG-SLEEVED T-SHIRTS; SHORT-SLEEVED
SHIRTS; SHORTS; SILK SCARVES; SKATING OUTFITS;
SKI AND SNOWBOARD SHOES AND PARTS THEREOF;
SKI BOOT BAGS; SKI GLOVES; SKI JACKETS; SKI
MASKS; SKI PANTS; SKI SUITS; SKI SUITS FOR

CLASS 25—(Continued).

COMPETITION; SKI WEAR; SKIRTS; SKIRTS AND DRESSES; SKULL CAPS; SLACKS; SLEEP SHIRTS; SLEEPING GARMENTS; SLEEPWEAR; SLEEVED OR SLEEVELESS JACKETS; SLEEVELESS JERSEYS; SMALL HATS; SMOCKS; SNEAKERS; SNOW BOARDING SUITS; SNOW PANTS; SNOW SUITS; SNOWBOARD BOOTS; SNOWBOARD GLOVES; SNOWBOARD PANTS; SOCCER BOOTS; SOCCER SHOES; SOCKS; SOCKS AND STOCKINGS; SPORT COATS; SPORT SHIRTS; SPORTS BRA; SPORTS JACKETS; SPORTS JERSEYS; SPORTS JERSEYS AND BREECHES FOR SPORTS; SPORTS OVER UNIFORMS; SPORTS SHIRTS; SPORTS SHIRTS WITH SHORT SLEEVES; SUEDE JACKETS; SUIT COATS; SUITS; SUITS OF LEATHER; SUN VISORS; SURF WEAR; SUSPENDER BELTS FOR MEN; SUSPENDER BELTS FOR WOMEN; SUSPENDERS; SWADDLING CLOTHES; SWEAT BANDS; SWEAT PANTS; SWEAT SHIRTS; SWEAT SHORTS; SWEAT SUITS; SWEAT-BANDS; SWEATERS; SWEATSOCKS; SWIM CAPS; SWIM TRUNKS; SWIM WEAR; SWIM WEAR FOR GENTLEMEN AND LADIES; SWIMMING CAPS; SWIMMING CAPS; SWIMMING TRUNKS; SWIMSUITS; T-SHIRTS; TANK TOPS; TANK-TOPS; TANKINIS; TENNIS SHOES; TENNIS WEAR; THERMAL SOCKS; THERMAL UNDERWEAR; THONGS; THONGS; TIES; TRACK PANTS; TRACK SUITS; TRACKSUITS; TRAINING SHOES; TRAINING SUITS; TRENCH COATS; TROUSERS; TROUSERS FOR SWEATING; TROUSERS OF LEATHER; TRUNKS; TURBANS; TURTLENECK SWEATERS; TURTLENECKS; TUXEDOS; UNDER GARMENTS; UNDERCLOTHES; UNDERGARMENTS; UNDERPANTS; UNDERSHIRTS; UNDERSKIRTS; UNDERWEAR; UNIFORMS; V-NECK SWEATERS; VEILS; VESTED SUITS; VESTS; VISORS; WALKING SHORTS; WARM UP SUITS; WATERPROOF JACKETS AND PANTS; WET SUIT GLOVES; WET SUITS; WIND COATS; WIND RESISTANT JACKETS; WIND-JACKETS; WOMEN'S SHOES; WOMEN'S UNDERWEAR; WOOLLEN SOCKS; WOOLLY HATS; WORK SHOES AND BOOTS; WORKING OVERALLS; WOVEN OR KNITTED UNDERWEAR; WRIST BANDS; WRISTBANDS; WRISTBANDS CONTAINING A COOLING SUBSTANCE TO COOL THE WEARER; ZOOT SUITS (U.S. CLS. 22 AND 39).

MARY ROSSMAN, EXAMINING ATTORNEY

SN 78-869,425. GALMAX INDUSTRIES, LLC, LAS VEGAS, NV. FILED 4-25-2006.



NO CLAIM IS MADE TO THE EXCLUSIVE RIGHT TO USE DOT COM, APART FROM THE MARK AS SHOWN.

THE MARK CONSISTS OF CROWN DESIGN CENTERED BETWEEN TWO HORIZONTAL WAVES OVER THE WORDS POKER KING. HORIZONTAL LINE AT BOTTOM WITH WORDS DOT COM IN CENTER OF LINE.

FOR COATS; DRESS SHIRTS; JACKETS; OPEN-NECKED SHIRTS; POLO SHIRTS; SHIRTS; SWEAT SHIRTS; SWEATERS; T-SHIRTS; WIND COATS (U.S. CLS. 22 AND 39).

FIRST USE 3-29-2006; IN COMMERCE 3-29-2006.

TONJA GASKINS, EXAMINING ATTORNEY

CLASS 25—(Continued).

SN 78-869,443. TAKENADVANTAGEOF, INC., SAN DIEGO, CA. FILED 4-25-2006.

TakenAdvantageOf

THE MARK CONSISTS OF STANDARD CHARACTERS WITHOUT CLAIM TO ANY PARTICULAR FONT, STYLE, SIZE, OR COLOR.

FOR HATS; JEANS; SHIRTS; SHORTS; SKIRTS (U.S. CLS. 22 AND 39).

BARBARA A. LOUGHRAN, EXAMINING ATTORNEY

SN 78-869,449. SCHMIDT, JOE E., DAVENPORT, IA. FILED 4-25-2006.



THE COLOR(S) DARK BROWN, LIGHT BROWN, WHITE, YELLOW AND GOLD IS/ARE CLAIMED AS A FEATURE OF THE MARK.

THE COLOR DARK BROWN APPEARS IN THE WORDS HOW CAN I SERVE THE AND TODAY, IN THE OUTLINE OF THE CROSS, EXCEPT FOR THE FAR RIGHT AND LEFT PORTIONS OF THE HORIZONTAL BAR OF THE CROSS, AND IN THE MIDDLE THIRD OF THE VERTICAL BAR OF THE CROSS; THE COLOR LIGHT BROWN APPEARS IN THE FAR RIGHT AND LEFT PORTIONS OF THE HORIZONTAL BAR OF THE CROSS, IN THE UPPER AND LOWER THIRDS OF THE VERTICAL BAR OF THE CROSS, AND IN THE OUTLINE OF THE CLOTH DRAPED OVER THE CROSS; THE COLOR WHITE APPEARS IN THE WORD LORD AND IN THE CLOTH DRAPED OVER THE CROSS; THE COLOR YELLOW APPEARS IN THE BACKGROUND OF THE MARK, AND THE COLOR GOLD APPEARS IN THE STARBURST DESIGN AND IN THE OUTLINE OF THE WORD LORD.

THE MARK CONSISTS OF A LITERAL ELEMENT INCLUDING A STYLIZED "I" INTENDED TO FORM A DRAPED CRUCIFIX ON A GOLD STARBURST BACKGROUND AND THE LETTERS "LORD" HIGHLIGHTED IN GOLD.

FOR CLOTHING, NAMELY SHIRTS AND HATS (U.S. CLS. 22 AND 39).

ESTHER BELENKER, EXAMINING ATTORNEY

CLASS 25—(Continued).

SN 78-869,466. POWERS, MICHAEL D., SAN FRANCISCO, CA. FILED 4-25-2006.

SEX SQUAD

THE MARK CONSISTS OF STANDARD CHARACTERS WITHOUT CLAIM TO ANY PARTICULAR FONT, STYLE, SIZE, OR COLOR.
FOR SHIRTS, HATS AND JACKETS (U.S. CLS. 22 AND 39).

DARRYL SPRUILL, EXAMINING ATTORNEY

CLASS 25—(Continued).

SN 78-869,681. ROADRUNNER APPAREL INC., LACHINE, QUEBEC, CANADA, FILED 4-26-2006.

SWIMSAVER

THE MARK CONSISTS OF STANDARD CHARACTERS WITHOUT CLAIM TO ANY PARTICULAR FONT, STYLE, SIZE, OR COLOR.

FOR SWIMWEAR (U.S. CLS. 22 AND 39).

RAMONA ORTIGA, EXAMINING ATTORNEY

SN 78-869,551. STULBERGER, JONATHAN, CHATSWORTH, CA. FILED 4-25-2006.

KUSH KILLS

THE MARK CONSISTS OF STANDARD CHARACTERS WITHOUT CLAIM TO ANY PARTICULAR FONT, STYLE, SIZE, OR COLOR.

OWNER OF U.S. REG. NO. 3,033,283.

SEC. 2(F).

FOR HATS; SWEAT SHIRTS; T-SHIRTS (U.S. CLS. 22 AND 39).

FIRST USE 12-8-2000; IN COMMERCE 1-20-2001.

HEATHER THOMPSON, EXAMINING ATTORNEY

SN 78-869,712. PARROTT AND JONES OUTDOOR PRODUCTS, LLC, WHITE BLUFF, TN. FILED 4-26-2006.

HUNTIN' & LOVIN' IT

THE MARK CONSISTS OF STANDARD CHARACTERS WITHOUT CLAIM TO ANY PARTICULAR FONT, STYLE, SIZE, OR COLOR.

FOR MEN'S, WOMEN'S, AND CHILDREN'S CLOTHING, NAMELY, HATS, T-SHIRTS, AND WRISTBANDS (U.S. CLS. 22 AND 39).

DARRYL SPRUILL, EXAMINING ATTORNEY

SN 78-869,602. SADLER, CORY DEAN, PLACENTIA, CA. FILED 4-26-2006.

Coerce

THE MARK CONSISTS OF STANDARD CHARACTERS WITHOUT CLAIM TO ANY PARTICULAR FONT, STYLE, SIZE, OR COLOR.

FOR CLOTHING; NAMELY-SHIRTS, SHORTS, SWEATSHIRTS, T-SHIRTS, JACKETS, CAPS, HATS (U.S. CLS. 22 AND 39).

FIRST USE 4-26-2001; IN COMMERCE 4-26-2001.

WON TEAK OH, EXAMINING ATTORNEY

SN 78-869,760. ROCH, ANGELA MARIA JIMENEZ, ESCAZU, COSTA RICA, FILED 4-26-2006.

PUTA RICA

THE MARK CONSISTS OF STANDARD CHARACTERS WITHOUT CLAIM TO ANY PARTICULAR FONT, STYLE, SIZE, OR COLOR.

THE FOREIGN WORDING IN THE MARK TRANSLATES INTO ENGLISH AS RICH WHORE.

FOR LINGERIE, STOCKINGS (U.S. CLS. 22 AND 39).

SONYA STEPHENS, EXAMINING ATTORNEY

CLASS 25—(Continued).

SN 78-870,179. VICTORIA'S SECRET STORES BRAND MANAGEMENT, INC., REYNOLDSBURG, OH. FILED 4-26-2006.

SIMPLY V

THE MARK CONSISTS OF STANDARD CHARACTERS WITHOUT CLAIM TO ANY PARTICULAR FONT, STYLE, SIZE, OR COLOR.

FOR BRAS; BRASSIERES; LINGERIE; PANTIES; UNDERWEAR (U.S. CLS. 22 AND 39).

SARAH WAYDA, EXAMINING ATTORNEY

CLASS 25—(Continued).

SN 78-870,468. LEE, JOHANNES, LOS ANGELES, CA. FILED 4-26-2006.



THE MARK CONSISTS OF ANIMATED SPIDER HEAD WITH FIVE EYES BITING ON A CIGAR WITH HIS TEETH.

FOR (BASED ON USE IN COMMERCE) DENIMS; PANTS; SHIRT FRONTS; SHIRTS; SHORT-SLEEVED OR LONG-SLEEVED T-SHIRTS; SHORT-SLEEVED SHIRTS; SPORT SHIRTS; SPORTS SHIRTS; SPORTS SHIRTS WITH SHORT SLEEVES; SWEAT SHIRTS; T-SHIRTS; (BASED ON INTENT TO USE) BELTS; BELTS MADE OF LEATHER; HATS; HEADGEAR, NAMELY, BEANIES, SWEAT BANDS; LEATHER BELTS; SWEAT PANTS; WAIST BELTS (U.S. CLS. 22 AND 39).

FIRST USE 2-1-2006; IN COMMERCE 2-1-2006.

NAKIA HENRY, EXAMINING ATTORNEY

SN 78-870,406. SARNECKI, ANDREW T., HERMOSA BEACH, CA. FILED 4-26-2006.



THE MARK CONSISTS OF A STYLIZED DESIGN IN THE SHAPE OF A TREE.

FOR ATHLETIC FOOTWEAR, BANDANAS, BASEBALL CAP, BATHING CAPS, BATHING SUITS, BATHING TRUNKS, BEACH COVERUPS, BEACH SHOES, BEACHWEAR, BEANIES, BERETS, BERMUDA SHORTS, BIKINIS, BODY SUITS, BOXER BRIEFS, BOXER SHORTS, CAPS, FLEECE PULLOVER, FOOTWEAR, GALOSHES, GLOVES, GYM SHORTS, GYM SUITS, HALTER TOPS, HATS, HEAD BANDS, HOODED SWEATSHIRTS, INFANT WEAR, JACKETS, KNIT SHIRTS, LOUNGE WEAR, PAJAMAS, PARKAS, PONCHOS, RAINWEAR, RASH GUARDS, SANDALS, SCARVES, SHIRTS, SHORTS, SLEEP SHIRT, SLIPPERS, SNEAKERS, SOCKS, SPORT SHIRTS, SUN VISORS, SURF WEAR, SWEATERS, SWEAT SOCKS, SWIM CAPS, SWIM TRUNKS, SWIM WEAR, SWIM SUITS, TANK TOPS, THONGS, TOPS, T-SHIRTS, UNDERSHIRTS, V-NECK SWEATER, WALKING SHORTS, WETSUITS, WIND RESISTANT JACKETS, WIND RESISTANT SHIRTS, WRIST BANDS, WATER SOCKS, BELTS, TRACK SUITS, PULLOVERS (U.S. CLS. 22 AND 39).

FIRST USE 9-1-2003; IN COMMERCE 9-1-2005.

PAULA MAHONEY, EXAMINING ATTORNEY

SN 78-871,615. MC COY, ANGELINA, LOS ANGELES, CA. FILED 4-27-2006.

Angelina Mc Coy

THE MARK CONSISTS OF STANDARD CHARACTERS WITHOUT CLAIM TO ANY PARTICULAR FONT, STYLE, SIZE, OR COLOR.

FOR CLOTHING, NAMELY MEN'S, WOMEN'S, MISSY'S, JUNIORS', JEANS, PANTS, TROUSERS, CAPRIS, LEGGINGS, SHORTS, SKORTS, OVERALLS, SHORTS, SKIRTS, DRESSES, TOPS, T-SHIRTS, SWEATSHIRTS, BLOUSES, SHIRTS, JACKETS, COATS, SWEATERS, VESTS, CARDIGANS, SCARVES, BANDANAS, BELTS, HATS, CAPS AND HEADWEAR (U.S. CLS. 22 AND 39).

JIM RINGLE, EXAMINING ATTORNEY

CLASS 25—(Continued).

SN 78-871,756. HOODLOVE LIMITED LIABILITY COMPANY, EAST ORANGE, NJ. FILED 4-28-2006.



THE MARK CONSISTS OF THE WORDS HOOD LOVE AND HL IN A STYLIZED DESIGN.

FOR ANKLE SOCKS; ANKLETS; ANORAKS; APRONS; ATHLETIC FOOTWEAR; ATHLETIC SHOES; ATHLETIC UNIFORMS; BABY BIBS NOT OF PAPER; BANDANAS; BASEBALL CAPS; BASKETBALL SNEAKERS; BATH SLIPPERS; BATHING CAPS; BATHING SUITS; BATHING TRUNKS; BATHROBES; BEACH FOOTWEAR; BEACH SHOES; BEACHWEAR; BELTS; BELTS MADE OF LEATHER; BELTS OF TEXTILE; BERETS; BERMUDA SHORTS; BIB OVERALLS; BLAZERS; BLOUSES; BOARD SHORTS; BODY SUITS; BOOTIES; BOOTS; BOW TIES; BOXER BRIEFS; BOXER SHORTS; BOXING SHOES; BRAS; BRIEFS; CAMISOLES; CANVAS SHOES; CAPS; CHILDREN'S HEADWEAR; CLOTH BIBS; CLOTH DIAPERS; COATS; COVERALLS; DECK-SHOES; DENIM JACKETS; DOWN JACKETS; DRESS SHIRTS; DRESS SUITS; DRESSES; EAR MUFFS; EVENING DRESSES; EVENING GOWNS; FABRIC BELTS; FLEECE PULL-OVERS; FLEECE SHORTS; FLIP FLOPS; FOOTBALL SHOES; FOOTWEAR FOR MEN; FOOTWEAR FOR TRACK AND FIELD ATHLETICS; FOOTWEAR FOR WOMEN; GALOSHES; GARTER BELTS; GLOVES; GOLF SHIRTS; GYM SHORTS; GYM SUITS; HALTER TOPS; HATS; HEAD SCARVES; HEADBANDS; HEADWEAR; HEAVY JACKETS; HOSIERY; INFANT AND TODDLER ONE PIECE CLOTHING; JACKETS; JEANS; JERSEYS; JOGGING OUTFITS; JUMPERS; KNIT SHIRTS; KNITTED CAPS; LADIES' SUITS; LADIES' UNDERWEAR; LEATHER COATS; LEATHER JACKETS; LEATHER PANTS; LEATHER SHOES; LEG WARMERS; LEGGINGS; LINGERIE; LOUNGEWEAR; MEN'S SOCKS; MITTENS; MUSCLE TOPS; NECKTIES; NECKWEAR; NIGHT GOWNS; OVERALLS; PAJAMAS; PANTS; PANTYHOSE; PARKAS; POLO SHIRTS; PONCHOS; PULL-OVERS; RAIN COATS; RAINWEAR; ROBES; RUGBY TOPS; RUNNING SHOES; SANDALS; SCARVES; SHIRTS; SHIRTS FOR SUITS; SHOES; SHORT-SLEEVED OR LONG-SLEEVED T-SHIRTS; SHORTS; SHOWER CAPS; SKI JACKETS; SKIRTS; SKULL CAPS; SLACKS; SLEEPWEAR; SLIPPERS; SLIPS; SNEAKERS; SOCKS; SPORT COATS; SPORTS BRA; SPORTS JERSEYS; SUITS; SUSPENDERS; SWEAT BANDS; SWEAT PANTS; SWEAT SHIRTS; SWEAT SHORTS; SWEAT SUITS; SWEATERS; SWIMMING TRUNKS; T-SHIRTS; TANK TOPS; TENNIS SHOES; THONGS; TIGHTS; TOPS; TRACK PANTS; TRACK SUITS; TRENCH COATS; TROUSERS; TURTLE-NECK SWEATERS; UNDERWEAR; UNIFORMS; V-NECK SWEATERS; VESTS; WARM UP SUITS; WIND RESISTANT JACKETS; WOOLLY HATS; WRIST BANDS (U.S. CLS. 22 AND 39).

BARBARA BROWN, EXAMINING ATTORNEY

CLASS 25—(Continued).

SN 78-872,176. STEPHAN ENTERPRISES INC., PIERCETON, IN. FILED 4-28-2006.

COR-SOCKAGE

THE MARK CONSISTS OF STANDARD CHARACTERS WITHOUT CLAIM TO ANY PARTICULAR FONT, STYLE, SIZE, OR COLOR.

FOR CLOTHING, NAMELY, SOCKS FOR BABIES THAT CAN BE FOLDED OR ARRANGED TO LOOK LIKE A FLOWER CORSAGE (U.S. CLS. 22 AND 39).

SHARON MEIER, EXAMINING ATTORNEY

SN 78-872,178. NON SERVITUS, MANCHESTER, MA. FILED 4-28-2006.

Non Servitus

THE MARK CONSISTS OF STANDARD CHARACTERS WITHOUT CLAIM TO ANY PARTICULAR FONT, STYLE, SIZE, OR COLOR.

THE FOREIGN WORDING IN THE MARK TRANSLATES INTO ENGLISH AS NOT A SLAVE.

FOR JEANS; T-SHIRTS; TOPS (U.S. CLS. 22 AND 39).

SHARON MEIER, EXAMINING ATTORNEY

SN 78-872,683. UNIVERSAL CITY STUDIOS LLLP, UNIVERSAL CITY, CA. FILED 4-28-2006.

UNIVERSAL 360

THE MARK CONSISTS OF STANDARD CHARACTERS WITHOUT CLAIM TO ANY PARTICULAR FONT, STYLE, SIZE, OR COLOR.

FOR ADULT AND YOUTH SHIRTS, T-SHIRTS, SWEATSHIRTS, CAPS AND HATS (U.S. CLS. 22 AND 39).

DEIRDRE ROBERTSON, EXAMINING ATTORNEY

CLASS 25—(Continued).

SN 78-873,568. WALKER, ANDREW, SAN DIEGO, CA. AND FOLLIS, JOHNNY JAMES, SAN DIEGO, CA. FILED 5-1-2006.



THE MARK CONSISTS OF FANCIFUL ABSTRACT DESIGN OF GEOMETRIC SHAPES WITH ROUNDED EDGES. FOR CLOTHING FOR WEAR IN JUDO PRACTICES; CLOTHING FOR WEAR IN WRESTLING GAMES; CLOTHING, NAMELY, WRAP-AROUNDS; HOODS; INFANT AND TODDLER ONE PIECE CLOTHING; JERSEYS; NON-DISPOSABLE CLOTH TRAINING PANTS; PERSPIRATION ABSORBENT UNDERWEAR CLOTHING; SHIFTS; SHORT SETS; TIES; TOPS; WRAPS (U.S. CLS. 22 AND 39).

FIRST USE 7-29-2003; IN COMMERCE 9-1-2003.
BARBARA A. LOUGHRAN, EXAMINING ATTORNEY

SN 78-875,025. GODIVA BRANDS, INC., NEWARK, DE. FILED 5-3-2006.



OWNER OF U.S. REG. NOS. 836,376, 1,798,864 AND OTHERS.

THE MARK CONSISTS OF AN ARTISTIC RENDITION OF A LADY ON HORSEBACK AND THE WORDS "GODIVA CHOCOLATIER" WRITTEN IN A STYLIZED MANNER.

FOR HATS; POLO SHIRTS; SWEAT SHIRTS; T-SHIRTS (U.S. CLS. 22 AND 39).

MATTHEW MCDOWELL, EXAMINING ATTORNEY

CLASS 25—(Continued).

SN 78-876,325. REDCATS USA, L.P., INDIANAPOLIS, IN. FILED 5-4-2006.

COMFORT CHOICE

THE MARK CONSISTS OF STANDARD CHARACTERS WITHOUT CLAIM TO ANY PARTICULAR FONT, STYLE, SIZE, OR COLOR.

FOR BEACHWEAR; BODY SUITS; BRAS; CAMISOLES; CAPRIS; DUSTERS; FOOTWEAR; GIRDLES; HOSIERY; JUMPSUITS; LEGGINGS; LINGERIE; LOUNGEWEAR; NIGHT GOWNS; PANTIES; PANTS; PEIGNOIRS; ROBES; ROMPERS; SHOES; SHORTS; SLEEPWEAR; SLIPS; SOCKS; SWEATERS; SWIM WEAR; T-SHIRTS (U.S. CLS. 22 AND 39).

ALLISON SCHRODY, EXAMINING ATTORNEY

SN 78-877,414. REDCATS USA, L.P., INDIANAPOLIS, IN. FILED 5-5-2006.

WEATHER SOLUTIONS

THE MARK CONSISTS OF STANDARD CHARACTERS WITHOUT CLAIM TO ANY PARTICULAR FONT, STYLE, SIZE, OR COLOR.

FOR ANORAKS; BLAZERS; BOOTS; CAPES; COATS; GLOVES; HATS; JACKETS; LEATHER COATS; LEATHER JACKETS; MITTENS; PARKAS; PONCHOS; SCARVES; SKI WEAR; SNOW SUITS; SURF WEAR; SWEAT PANTS; SWEAT SHIRTS; SWEATERS; TUNICS; VESTS (U.S. CLS. 22 AND 39).

ALLISON SCHRODY, EXAMINING ATTORNEY

SN 78-879,224. GALMAX INDUSTRIES, LLC, LAS VEGAS, NV. FILED 5-8-2006.

POKER KING

THE MARK CONSISTS OF STANDARD CHARACTERS WITHOUT CLAIM TO ANY PARTICULAR FONT, STYLE, SIZE, OR COLOR.

FOR COATS; DRESS SHIRTS; JACKETS; OPEN-NECKED SHIRTS; POLO SHIRTS; SHIRTS; SWEAT SHIRTS; SWEATERS; T-SHIRTS (U.S. CLS. 22 AND 39).

FIRST USE 3-29-2006; IN COMMERCE 3-29-2006.

TONJA GASKINS, EXAMINING ATTORNEY

CLASS 25—(Continued).

SN 78-879,303. BLACK HOLE INDUSTRIES, SOQUEL, CA.
FILED 5-9-2006.

Debutant

THE MARK CONSISTS OF STANDARD CHARACTERS WITHOUT CLAIM TO ANY PARTICULAR FONT, STYLE, SIZE, OR COLOR.

FOR CLOTHING, NAMELY, HATS, SHIRTS, BELTS, PANTS, JEANS, SHOES, DRESSES, COATS, JACKETS, SWIM WEAR, SOCKS AND UNDERGARMENTS (U.S. CLS. 22 AND 39).

CHRISTINE COOPER, EXAMINING ATTORNEY

SN 78-879,446. A&H SPORTSWEAR CO., INC., BROOKLYN, NY. FILED 5-9-2006.

CLUB MILANO

THE MARK CONSISTS OF STANDARD CHARACTERS WITHOUT CLAIM TO ANY PARTICULAR FONT, STYLE, SIZE, OR COLOR.

THE ENGLISH TRANSLATION OF THE WORD MILANO IN THE MARK IS MILAN.

FOR MEN'S, BOYS' AND TODDLERS' APPAREL, NAMELY, SHIRTS, SWEATERS, TOPS, JACKETS, PANTS, SHORTS AND COORDINATE SETS CONSISTING OF TOPS AND BOTTOMS THAT MATCH (U.S. CLS. 22 AND 39).

FIRST USE 3-0-2005; IN COMMERCE 3-0-2005.

JUSTINE D. PARKER, EXAMINING ATTORNEY

SN 78-879,618. SEARS BRANDS, LLC, HOFFMAN ESTATES, IL. FILED 5-9-2006.

ELK WOODS

THE MARK CONSISTS OF STANDARD CHARACTERS WITHOUT CLAIM TO ANY PARTICULAR FONT, STYLE, SIZE, OR COLOR.

OWNER OF U.S. REG. NO. 1,398,634.

FOR FOOTWEAR (U.S. CLS. 22 AND 39).

FIRST USE 11-6-1985; IN COMMERCE 11-6-1985.

REBECCA POVARCHUK, EXAMINING ATTORNEY

CLASS 25—(Continued).

SN 78-879,783. BAKERS FOOTWEAR GROUP, INC., ST. LOUIS, MO. FILED 5-9-2006.

NO PARKING

THE MARK CONSISTS OF STANDARD CHARACTERS WITHOUT CLAIM TO ANY PARTICULAR FONT, STYLE, SIZE, OR COLOR.

APPLICANT AND NOVUS, INC. ENTERED INTO A CONCURRENT USE AGREEMENT ON JUNE 23, 1999, PURSUANT TO WHICH APPLICANT AND NOVUS, INC. AGREED THAT APPLICANT HAS THE EXCLUSIVE RIGHT TO USE THE MARK THROUGHOUT THE UNITED STATES AND ITS TERRITORIES. THE APPLICANT ACKNOWLEDGES THAT SUBJECT TO THE PROVISIONS OF THE CONCURRENT USE AGREEMENT EXECUTED ON JUNE 23, 1999, NOVUS, INC. HAS THE EXCLUSIVE USE OF THE MARK IN THE COMMONWEALTH OF PUERTO RICO AND THE US VIRGIN ISLANDS.

OWNER OF U.S. REG. NOS. 1,943,049 AND 2,536,954.

FOR FOOTWEAR, NAMELY, SANDALS, BOOTS, SNEAKERS, AND SHOES (U.S. CLS. 22 AND 39).

FIRST USE 2-14-1995, THE MARK WAS FIRST USED ANYWHERE IN A DIFFERENT FORM OTHER THAN THAT SOUGHT TO BE REGISTERED ON 02/14/1995; IN COMMERCE 2-14-1995, THE MARK WAS FIRST USED IN COMMERCE IN A DIFFERENT FORM OTHER THAN THAT SOUGHT TO BE REGISTERED ON 02/14/1995..

ANDREA SAUNDERS, EXAMINING ATTORNEY

SN 78-882,177. CAVENDER INVESTMENT, LLC, TYLER, TX. FILED 5-12-2006.



NO CLAIM IS MADE TO THE EXCLUSIVE RIGHT TO USE "RANCHWEAR" AND "AUTHENTIC RANCHWEAR", APART FROM THE MARK AS SHOWN.

THE COLORS TAN, BEIGE, DARK BROWN, WHITE ARE CLAIMED AS A FEATURE OF THE MARK.

THE WORDS RAFTER C RANCHWEAR AND AUTHENTIC RANCHWEAR AND THE HORIZONTAL LINES ARE DARK BROWN, THE LETTER C AND CHEVRON ARE BEIGE, THE CIRCLE IS WHITE WITH A DARK BROWN CENTER AND BORDER, THE STARS ARE DARK BROWN AND TAN, ALL ON A TAN RECTANGULAR BACKGROUND.

FOR CLOTHING, NAMELY, WESTERN SHIRTS AND CAPS (U.S. CLS. 22 AND 39).

FIRST USE 4-1-1995; IN COMMERCE 4-1-1995.

JOHN WILKE, EXAMINING ATTORNEY

CLASS 25—(Continued).

SN 78-883,544. PAYLESS SHOESOURCE WORLDWIDE, INC., TOPEKA, KS. FILED 5-15-2006.

FLIP OUTS BY PAYLESS

THE MARK CONSISTS OF STANDARD CHARACTERS WITHOUT CLAIM TO ANY PARTICULAR FONT, STYLE, SIZE, OR COLOR.

OWNER OF U.S. REG. NOS. 1,731,803, 1,958,918 AND OTHERS.

FOR FOOTWEAR (U.S. CLS. 22 AND 39).
JAMES MACFARLANE, EXAMINING ATTORNEY

SN 78-885,232. TOP LINE SCREEN PRINTING AND EMBROIDERY, INC., ORLANDO, FL. FILED 5-16-2006.

B.M.O.C.

THE MARK CONSISTS OF STANDARD CHARACTERS WITHOUT CLAIM TO ANY PARTICULAR FONT, STYLE, SIZE, OR COLOR.

FOR SHORT-SLEEVED OR LONG-SLEEVED T-SHIRTS; T-SHIRTS (U.S. CLS. 22 AND 39).
NAKIA HENRY, EXAMINING ATTORNEY

SN 78-886,340. LARSON, MALIA, PLEASANTON, CA. FILED 5-17-2006.

Chill Goddess

THE MARK CONSISTS OF STANDARD CHARACTERS WITHOUT CLAIM TO ANY PARTICULAR FONT, STYLE, SIZE, OR COLOR.

FOR DRESSES; PANTS; TOPS (U.S. CLS. 22 AND 39).
FIRST USE 5-10-2006; IN COMMERCE 5-15-2006.
MARC LEIPZIG, EXAMINING ATTORNEY

CLASS 25—(Continued).

SN 78-892,527. DAVIS JILES, LLC, BENTONVILLE, AR. FILED 5-25-2006.

Fresh Cherries

THE MARK CONSISTS OF STANDARD CHARACTERS WITHOUT CLAIM TO ANY PARTICULAR FONT, STYLE, SIZE, OR COLOR.

FOR APPAREL, NAMELY SHIRTS, T-SHIRTS, SWEAT SHIRTS, AND HATS (U.S. CLS. 22 AND 39).
IRA J. GOODSaid, EXAMINING ATTORNEY

SN 78-893,649. DADA CORPORATION, SEOUL, REPUBLIC OF KOREA, FILED 5-26-2006.

PXK
PAXKO

OWNER OF U.S. REG. NO. 2,285,146.

THE MARK CONSISTS OF PXK AND PAXKO. PAXKO IS SMALLER THAN PXK AND IS LOCATED UNDER PXK.

FOR CLOTHING NAMELY, HATS, CAPS AND HEADWEAR, HEADBANDS, JERSEYS, JACKETS, JEANS, CASUAL WEAR NAMELY, SHORTS, PANTS, T-SHIRTS, OVERCOATS, SHOES (U.S. CLS. 22 AND 39).
SHARON MEIER, EXAMINING ATTORNEY

SN 78-893,662. DARZENTA, CONSTANTIN, SANDWICH, MA. FILED 5-26-2006.

LA COI MONDAIN

THE MARK CONSISTS OF STANDARD CHARACTERS WITHOUT CLAIM TO ANY PARTICULAR FONT, STYLE, SIZE, OR COLOR.

THE ENGLISH TRANSLATION OF THE FRENCH WORDING "LA COI MONDAIN" IS "THE QUIET SOCIALITE".

FOR LINGERIE (U.S. CLS. 22 AND 39).
SARA THOMAS, EXAMINING ATTORNEY

CLASS 25—(Continued).

SN 78-900,267. FOOD PANTRY, LTD., HONOLULU, HI.
FILED 6-5-2006.



FOR CLOTHING FOR MEN, WOMEN AND CHILDREN, NAMELY, T-SHIRTS WITH SHORT AND LONG SLEEVES, TANK TOPS, CAMISOLES, SWEATSHIRTS, SHORTS, JACKETS, CAPS, HATS, AND VISORS (U.S. CLS. 22 AND 39).

MATTHEW MCDOWELL, EXAMINING ATTORNEY

SN 78-900,275. FOOD PANTRY, LTD., HONOLULU, HI.
FILED 6-5-2006.



FOR CLOTHING FOR MEN, WOMEN AND CHILDREN, NAMELY, SWEATSHIRTS, T-SHIRTS, SUITS, TROUSERS, SHORT TROUSERS, JEANS, SHIRTS, SHORT-SLEEVED SHIRTS, TANK-TOPS, CORSETS, POLO SHIRTS, CARDIGANS, PULLOVERS, JERSEYS, JUMPERS, JACKETS, SKIRTS, DRESSES, VESTS, BELTS, SOCKS, OVERCOATS, WATERPROOF CLOTHING, NAMELY, OVERCOATS, RAINCOATS, ANORAKS; SWIM WEAR, BATHING SUITS, UNDERSHORTS, NAUTICAL CLOTHING, NAMELY, WET SUITS, PERFORMANCE BIBS AND BRACES IN THE NATURE OF SUSPENDERS, PERFORMANCE PANTS; GLOVES, NECKTIES; HEADGEAR FOR WEAR, NAMELY, HATS, BERETS, CAPS, CAP PEAKS, VISORS; PAJAMAS, SLIPPERS, SHOES, BOOTS, SANDALS, SPORT SHOES, BEACH SHOES (U.S. CLS. 22 AND 39).

MATTHEW MCDOWELL, EXAMINING ATTORNEY

CLASS 25—(Continued).

SN 78-900,495. DESIGNS APPAREL, INC., CANTON, MA.
FILED 6-5-2006.

JARED M.

THE MARK CONSISTS OF STANDARD CHARACTERS WITHOUT CLAIM TO ANY PARTICULAR FONT, STYLE, SIZE, OR COLOR.

OWNER OF U.S. REG. NOS. 2,066,172 AND 2,821,037.

THE NAME JARED M. IDENTIFIES A LIVING INDIVIDUAL WHOSE CONSENT IS OF RECORD.

FOR SUITS, JACKETS, VESTS, COATS, PANTS, SHORTS, TIES, SHIRTS, SWEATERS, PAJAMAS, ROBES, HATS, DRESSES, SKIRTS, BLOUSES, UNDERWEAR, WARM-UP SUITS, RUNNING OR JOGGING SUITS, SOCKS AND SHOES (U.S. CLS. 22 AND 39).

FIRST USE 6-0-1994; IN COMMERCE 6-0-1994.

DEBRA LEE, EXAMINING ATTORNEY

SN 78-901,350. CHIX APPEAL, INC., DESTIN, FL. FILED 6-6-2006.

LOVE YOUR TEAM

THE MARK CONSISTS OF STANDARD CHARACTERS WITHOUT CLAIM TO ANY PARTICULAR FONT, STYLE, SIZE, OR COLOR.

NO CLAIM IS MADE TO THE EXCLUSIVE RIGHT TO USE "TEAM", APART FROM THE MARK AS SHOWN.

FOR CLOTHING, NAMELY, BLOUSES, BOTTOMS, DRESSES, TOPS, JACKETS, JEANS, LOUNGEWEAR, PANTS, SHIRTS, SHORTS, SKIRTS, SLEEPWEAR, SWEATERS, TROUSERS, FOOTWEAR, HEADWEAR, BASEBALL CAPS, AND HOODED SWEATSHIRTS (U.S. CLS. 22 AND 39).

DARRYL SPRULL, EXAMINING ATTORNEY

CLASS 25—(Continued).

SN 78-902,382. PROLINK SPORTS MARKETING, INC., EAST AURORA, NY. FILED 6-7-2006.

DO YOUR BEST NEVER QUIT

THE MARK CONSISTS OF STANDARD CHARACTERS WITHOUT CLAIM TO ANY PARTICULAR FONT, STYLE, SIZE, OR COLOR.

FOR CLOTHING, NAMELY, HOSIERY, FOOTWEAR, BASKETBALL SHOES, BASKETBALL SNEAKERS, T-SHIRTS, SHIRTS, POLO SHIRTS, SWEATSHIRTS, SWEATPANTS, PANTS, TANK TOPS, JERSEYS, SHORTS, PAJAMAS, SPORT SHIRTS, RUGBY SHIRTS, SWEATERS, BELTS, TIES, NIGHTSHIRTS, HATS, CAPS, VISORS, WARM-UP SUITS, WARM-UP PANTS, WARM-UP TOPS, JACKETS, WIND RESISTANT JACKETS, PARKAS, COATS, BABY BIBS NOT OF PAPER, HEAD BANDS, WRIST BANDS, APRONS, UNDERGARMENTS, BOXER SHORTS, SLACKS, CAPS, EAR MUFFS, GLOVES, MITTENS, SCARVES, WOVEN AND KNIT SHIRTS, JERSEY DRESSES, DRESSES, CHEERLEADING DRESSES AND UNIFORMS, SWIM WEAR, BATHING SUITS, SWIMSUITS, BIKINIS, SWIM TRUNKS, BATHING TRUNKS, BOARD SHORTS, WET SUITS, BEACH COVER-UPS, BATHING SUIT COVER-UPS, BATHING SUIT WRAPS, SANDALS, BEACH SANDALS, BEACH HATS, SUN VISORS, SWIM CAPS, BATHING CAPS, SOCKS (U.S. CLS. 22 AND 39).

JENNIFER DIXON, EXAMINING ATTORNEY

SN 78-903,277. MALIA LARSON, PLEASANTON, CA. FILED 6-7-2006.

CHILL STUDIO

THE MARK CONSISTS OF STANDARD CHARACTERS WITHOUT CLAIM TO ANY PARTICULAR FONT, STYLE, SIZE, OR COLOR.

NO CLAIM IS MADE TO THE EXCLUSIVE RIGHT TO USE "STUDIO", APART FROM THE MARK AS SHOWN.

FOR DRESSES; FOOTWEAR; PANTS; SKIRTS; TOPS (U.S. CLS. 22 AND 39).

FIRST USE 6-1-2006; IN COMMERCE 6-1-2006.
MARC LEIPZIG, EXAMINING ATTORNEY

SN 78-903,311. LARSON, MALIA, PLEASANTON, CA. FILED 6-7-2006.

Get Your Chill On

THE MARK CONSISTS OF STANDARD CHARACTERS WITHOUT CLAIM TO ANY PARTICULAR FONT, STYLE, SIZE, OR COLOR.

FOR DRESSES; FOOTWEAR; PANTS; SKIRTS; TOPS (U.S. CLS. 22 AND 39).

FIRST USE 6-1-2006; IN COMMERCE 6-1-2006.
MARC LEIPZIG, EXAMINING ATTORNEY

CLASS 25—(Continued).

SN 78-907,103. 3074153 CANADA INC., QUÉBEC, CANADA, FILED 6-13-2006.

BLONDO

THE MARK CONSISTS OF STANDARD CHARACTERS WITHOUT CLAIM TO ANY PARTICULAR FONT, STYLE, SIZE, OR COLOR.

FOR WINTER BOOTS (U.S. CLS. 22 AND 39).
FIRST USE 2-28-1974; IN COMMERCE 2-28-1974.
TONI HICKEY, EXAMINING ATTORNEY

SN 78-911,368. IMPACT SALES & MARKETING, INC., BARRINGTON, IL. FILED 6-19-2006.

VESUVIO

THE MARK CONSISTS OF STANDARD CHARACTERS WITHOUT CLAIM TO ANY PARTICULAR FONT, STYLE, SIZE, OR COLOR.

FOR FOOTWEAR (U.S. CLS. 22 AND 39).
FIRST USE 5-15-2006; IN COMMERCE 5-15-2006.
JENNIFER MARTIN, EXAMINING ATTORNEY

SN 78-918,563. CADBURY ADAMS CANADA INC., TORONTO, CANADA, FILED 6-28-2006.

SOUR PATCH

THE MARK CONSISTS OF STANDARD CHARACTERS WITHOUT CLAIM TO ANY PARTICULAR FONT, STYLE, SIZE, OR COLOR.

OWNER OF U.S. REG. NOS. 2,304,261, 2,927,021 AND OTHERS.

FOR CLOTHING, NAMELY TOPS, T-SHIRTS, PANTS AND LOUNGEWEAR, HEADWEAR AND FOOTWEAR (U.S. CLS. 22 AND 39).

PAMELA HIRSCHMAN, EXAMINING ATTORNEY

CLASS 25—(Continued).

SN 78-923,320. HBI BRANDED APPAREL ENTERPRISES, LLC, WINSTON-SALEM, NC. FILED 7-6-2006.

POWERBACK

THE MARK CONSISTS OF STANDARD CHARACTERS WITHOUT CLAIM TO ANY PARTICULAR FONT, STYLE, SIZE, OR COLOR.
FOR BRAS; TOPS (U.S. CLS. 22 AND 39).
LEIGH LOWRY, EXAMINING ATTORNEY

SN 78-926,418. HBI BRANDED APPAREL LIMITED, INC., WINSTON-SALEM, NC. FILED 7-11-2006.

COMFORTHERM

THE MARK CONSISTS OF STANDARD CHARACTERS WITHOUT CLAIM TO ANY PARTICULAR FONT, STYLE, SIZE, OR COLOR.
FOR BOTTOMS; THERMAL UNDERWEAR; TOPS (U.S. CLS. 22 AND 39).
FIRST USE 8-31-2004; IN COMMERCE 8-31-2004.
LEIGH LOWRY, EXAMINING ATTORNEY

SN 78-935,045. HBI BRANDED APPAREL ENTERPRISES, LLC, WINSTON-SALEM, NC. FILED 7-21-2006.

STOP THE SLIP

THE MARK CONSISTS OF STANDARD CHARACTERS WITHOUT CLAIM TO ANY PARTICULAR FONT, STYLE, SIZE, OR COLOR.
FOR STRAPS SOLD AS A COMPONENT OF BRAS (U.S. CLS. 22 AND 39).
FIRST USE 2-15-2004; IN COMMERCE 2-15-2004.
LEIGH LOWRY, EXAMINING ATTORNEY

CLASS 25—(Continued).

SN 78-935,080. HBI BRANDED APPAREL ENTERPRISES, LLC, WINSTON-SALEM, NC. FILED 7-21-2006.

THIS END UP

THE MARK CONSISTS OF STANDARD CHARACTERS WITHOUT CLAIM TO ANY PARTICULAR FONT, STYLE, SIZE, OR COLOR.
FOR SHAPEWEAR, NAMELY, BOTTOMS, BRIEFS, THIGH SHAPERS, CAPRIS, TOPS, TANK TOPS, AND CAMISOLES (U.S. CLS. 22 AND 39).
LEIGH LOWRY, EXAMINING ATTORNEY

SN 78-937,594. HBI BRANDED APPAREL ENTERPRISES, LLC, WINSTON-SALEM, NC. FILED 7-26-2006.

LIVE BEAUTIFULLY

THE MARK CONSISTS OF STANDARD CHARACTERS WITHOUT CLAIM TO ANY PARTICULAR FONT, STYLE, SIZE, OR COLOR.
FOR BRAS; PANTIES; SHAPEWEAR, NAMELY, THIGH SHAPERS, BODY BRIEFERS, BODY SUITS, ALL-IN-ONES, BRIEFS AND GIRDLES; SLEEPWEAR (U.S. CLS. 22 AND 39).
LEIGH LOWRY, EXAMINING ATTORNEY

SN 78-941,706. COURCHEVEL, LLC., WILMINGTON, DE. FILED 7-31-2006.



FOR CLOTHING, NAMELY SHIRTS, T-SHIRTS, PULL-OVERS, SWEATERS, SWEATSHIRTS, JACKETS, AND COATS; HEADGEAR, NAMELY CAPS AND HATS (U.S. CLS. 22 AND 39).
CHARISMA HAMPTON, EXAMINING ATTORNEY

CLASS 25—(Continued).

SN 78-963,029. LONTEX CORPORATION, NORRISTOWN, PA. FILED 8-29-2006.



NO CLAIM IS MADE TO THE EXCLUSIVE RIGHT TO USE "COMPRESSION", APART FROM THE MARK AS SHOWN.

THE MARK CONSISTS OF THE WORDS COOL COMPRESSION NEXT TO THE STYLIZED CONFIGURATION OF A MAN.

FOR MEN'S, WOMEN'S AND CHILDREN'S CLOTHING, NAMELY, SOCKS, UNDERWEAR INCLUDING BOXER SHORTS, BRIEFS, BIKINI UNDERPANTS, AND LONG JOHNS, TSHIRTS, POLO SHIRTS, SWIMWEAR, COMPRESSION SHIRTS, COMPRESSION SHORTS, COMPRESSION TIGHTS, SWEATPANTS, SWEATSHIRTS, BODY ARMOR CARRIER COMPRESSION SHIRTS FOR MILITARY AND LAW ENFORCEMENT PERSONNEL, SPORTS BRAS, HALTER TOPS, SINGLET, CAPS, HATS, HEADBANDS, BANDANAS, BALACLAVAS, SNEAKERS AND SHOES (U.S. CLS. 22 AND 39).

BARBARA A. LOUGHRAN, EXAMINING ATTORNEY

SN 78-972,068. HBI BRANDED APPAREL ENTERPRISES, LLC, WINSTON-SALEM, NC. FILED 9-12-2006.

POWERLITE

THE MARK CONSISTS OF STANDARD CHARACTERS WITHOUT CLAIM TO ANY PARTICULAR FONT, STYLE, SIZE, OR COLOR.

FOR BRAS; TANK TOPS (U.S. CLS. 22 AND 39).
LEIGH LOWRY, EXAMINING ATTORNEY

SN 79-001,370. NORDDEUTSCHE WÄSCHEFABRIK GMBH, FED REP GERMANY, FILED 12-12-2003.

OWNER OF INTERNATIONAL REGISTRATION 0817308 DATED 12-12-2003, EXPIRES 12-12-2013.

THE COLOR(S) BLUE, RED, WHITE IS/ARE CLAIMED AS A FEATURE OF THE MARK.

THE COLORS BLUE, RED AND WHITE APPEAR AS FOLLOWS: THE WORDS KINGS ROAD ARE WRITTEN IN WHITE WITH RED UNDERLINING AND APPEAR ON A DARK BLUE BACKGROUND.

FOR CLOTHING, NAMELY SHIRTS, JACKETS, KNIT WEAR, COATS, TROUSERS, T-SHIRTS, SOCKS (U.S. CLS. 22 AND 39).

EUGENIA MARTIN, EXAMINING ATTORNEY

CLASS 25—(Continued).

SN 79-008,761. QUIRAL, S.A., SPAIN, FILED 8-13-2004.

SPRINGFIELD

PRIORITY DATE OF 4-5-2004 IS CLAIMED.
OWNER OF INTERNATIONAL REGISTRATION 0842865 DATED 8-13-2004, EXPIRES 8-13-2014.

FOR MEN'S, WOMEN'S AND CHILDREN'S READY-TO-WEAR CLOTHING, NAMELY, PANTS, SHIRTS, JACKETS, SWEATERS, SUITS, SHORTS, DRESSES; NON-ORTHOPEDIC FOOTWEAR AND HEADWEAR (U.S. CLS. 22 AND 39).

ROBERT LORENZO, EXAMINING ATTORNEY

SN 79-016,102. PETIT BATEAU, FRANCE, FILED 9-7-2005.



PRIORITY DATE OF 9-2-2005 IS CLAIMED.
OWNER OF INTERNATIONAL REGISTRATION 0864220 DATED 9-7-2005, EXPIRES 9-7-2015.

FOR READY-MADE CLOTHING FOR MEN, WOMEN AND CHILDREN, NAMELY, KNITTED SHIRTS AND CAPS; HOSIERY; UNDERWEAR, PAJAMAS, DRESSING GOWNS; SWEATERS, SKIRTS, DRESSES, PANTS, TROUSERS, JACKETS, COATS, FUR CLOTHING, NAMELY, JACKETS, HATS, COATS; SUITS, SHIRTS, LAYETTES, NECKTIES, SHAWLS, SCARVES, STOLAS, SASHES FOR WEAR, BELTS, GLOVES, HEADWEAR, NAMELY, CAPS, HATS, BERETS; SOCKS, STOCKINGS, TIGHTS; FOOTWEAR, SLIPPERS, BOOTS; BATHING SUITS AND TRUNKS; WATERPROOF CLOTHING, NAMELY, JACKETS AND PANTS (U.S. CLS. 22 AND 39).

KIMBERLY PERRY, EXAMINING ATTORNEY

CLASS 25—(Continued).

SN 79-016,243. MIGUEL ISAIAS REGALADO PAREJA, SPAIN, FILED 7-20-2005.

Pikey Max

OWNER OF INTERNATIONAL REGISTRATION 0864575 DATED 7-20-2005, EXPIRES 7-20-2015.

FOR CLOTHING, NAMELY, SHIRTS, SKIRTS, PANTS, SHORTS, SWEATSHIRTS, SOCKS, TRACK SUITS, JACKETS, SWEATERS, GLOVES, SCARVES, AND SWIMWEAR; FOOTWEAR; HEADWEAR (U.S. CLS. 22 AND 39).

TRAVIS WHEATLEY, EXAMINING ATTORNEY

CLASS 26—(Continued).

SN 76-659,073. HJOUJ, NATHEER S., ST. LOUIS, MO. FILED 4-24-2006.

PRINCESS

THE MARK CONSISTS OF STANDARD CHARACTERS WITHOUT CLAIM TO ANY PARTICULAR FONT, STYLE, SIZE, OR COLOR.

FOR WIGS AND HAIR EXTENSIONS (U.S. CLS. 37, 39, 40, 42 AND 50).

JENNY PARK, EXAMINING ATTORNEY

SN 78-695,701. PHAT FASHIONS LLC, NEW YORK, NY. FILED 8-18-2005.

CLASS 26—FANCY GOODS

SN 76-658,329. GENMORE ZIPPER CORPORATION, TAIPEI HSIEN, TAIWAN, FILED 4-12-2006.

秀
SCIL

THE FOREIGN CHARACTER IN THE MARK TRANSLITERATES TO "SCIL" AND THIS MEANS "ELEGANT", "WITH GRACE" IN ENGLISH.

FOR ZIPPERS, ZIPPER SLIDES AND ZIPPER PULLS, ZIPPER FASTENERS AND PARTS THEREOF (U.S. CLS. 37, 39, 40, 42 AND 50).

FIRST USE 6-0-1991; IN COMMERCE 6-0-1991.
ELI HELLMAN, EXAMINING ATTORNEY

SN 76-659,072. HJOUJ, NATHEER S., ST. LOUIS, MO. FILED 4-24-2006.

NU FASHION

THE MARK CONSISTS OF STANDARD CHARACTERS WITHOUT CLAIM TO ANY PARTICULAR FONT, STYLE, SIZE, OR COLOR.

NO CLAIM IS MADE TO THE EXCLUSIVE RIGHT TO USE "FASHION", APART FROM THE MARK AS SHOWN.

FOR WIGS AND HAIR EXTENSIONS (U.S. CLS. 37, 39, 40, 42 AND 50).

JENNY PARK, EXAMINING ATTORNEY



FOR HAIR ACCESSORIES, NAMELY, BOBBY PINS, CURLING PINS, WAVING PINS FOR THE HAIR, HAIR TIES, HAIR ORNAMENTS, HAIR PINS, BARRETTES, HAIR BANDS, HAIR RIBBONS, HAIR BOWS, PONYTAIL HOLDERS, HAIR BOWS WITH CLIPS, HAIR CLIPS, HAIR FASTENERS, HAIR BUCKLES, HAIR ROLLER CLIPS AND PINS, HAIR NETS, HAIR WRAPS, CLAM CLIPS FOR HAIR, CLAW CLIPS, TWISTERS, HAIR SCRUNCHIES, SNAP CLIPS, HAIR CURL CLIPS, SLEEP CLIPS, SALON CLIPS, HAIR FROSTING CAPS, NON-ELECTRIC HAIR CURLERS AND ROLLERS, BRAIDS, BRAIDING PINS, AND ORNAMENTAL COMBS WORN ON HAIR; ORNAMENTAL NOVELTY BUTTON AND PINS; CLOTHING AND SHIRT BUTTONS; ZIPPER PULLS AND ZIPPERS; SNAP FASTENERS; CLOTHING BUCKLES; CLASPS FOR CLOTHING; BELT CLASPS; BELT BUCKLES NOT OF PRECIOUS METAL; CLOTH PATCHES FOR CLOTHING; ORNAMENTAL CLOTH PATCHES; EMBROIDERED PATCHES FOR CLOTHING; EMBROIDERED EMBLEMS; PATCHES FOR REPAIRING TEXTILE ARTICLES; HAT PINS; HAT ORNAMENTS NOT OF PRECIOUS METAL; ORNAMENTAL BOWS OF TEXTILE FOR DECORATION; SAFETY PINS; RIBBONS; ORNAMENTAL RIBBONS MADE OF TEXTILES; RIBBONS FOR WRAPPING AND GIFT WRAPPING; ELASTIC RIBBONS; SEWING BOXES; ARTIFICIAL PLANTS AND FLOWERS (U.S. CLS. 37, 39, 40, 42 AND 50).

SUSAN STIGLITZ, EXAMINING ATTORNEY

CLASS 26—(Continued).

SN 78-830,603. SONSHAPES, INC., SAN JOSE, CA. FILED 3-6-2006.



THE COLOR(S) BLUE, SILVER, YELLOW AND TAN IS/ ARE CLAIMED AS A FEATURE OF THE MARK.

THE MARK CONSISTS OF THE RAISED WORD SONSHAPES IN A SOFT DARK BLUE TO SOFT SILVER METALLIC GRADIENT USING CRETINO FONT WITH A YELLOW STARBURST ON A KHAKI (DARK BROWNISH GREEN) OVAL BEHIND THE LETTERS "SON".

FOR CROCHET HOOKS; HAIR ORNAMENTS; HAIR ORNAMENTS IN THE FORM OF COMBS; HAT ORNAMENTS NOT OF PRECIOUS METAL; KNITTING NEEDLES; ORNAMENTAL COMBS FOR JAPANESE HAIR STYLING (U.S. CLS. 37, 39, 40, 42 AND 50).

FIRST USE 2-22-2004; IN COMMERCE 2-22-2004.
RICHARD WHITE, EXAMINING ATTORNEY

SN 78-857,426. FOMEDOMES, LLC, COLUMBUS, OH. FILED 4-10-2006.

TAILLIGHTS

THE MARK CONSISTS OF STANDARD CHARACTERS WITHOUT CLAIM TO ANY PARTICULAR FONT, STYLE, SIZE, OR COLOR.

FOR HAIR ACCESSORIES, NAMELY, SCRUNCHIES, BARRETTES, PONYTAIL HOLDERS, BOBBY PINS, CLAM CLIPS, HAIR BANDS, HAIR BOWS, HAIR ORNAMENTS IN THE FORM OF COMBS, AND RIBBONS (U.S. CLS. 37, 39, 40, 42 AND 50).

PAM WILLIS, EXAMINING ATTORNEY

SN 78-859,868. HIRSCHBERG SCHUTZ & CO., INC., WARREN, NJ. FILED 4-12-2006.

CELL STONES

THE MARK CONSISTS OF STANDARD CHARACTERS WITHOUT CLAIM TO ANY PARTICULAR FONT, STYLE, SIZE, OR COLOR.

NO CLAIM IS MADE TO THE EXCLUSIVE RIGHT TO USE "STONES", APART FROM THE MARK AS SHOWN.

FOR ARTS AND CRAFTS FINDINGS, NAMELY, SELF-ADHESIVE ACRYLIC RHINESTONES, ARTIFICIAL GEMSTONES, BEADS FOR DECORATIONS, AND DESIGNS, SOLD AS A UNIT (U.S. CLS. 37, 39, 40, 42 AND 50).

FIRST USE 8-0-2005; IN COMMERCE 8-0-2005.
ALICE SUE CARRUTHERS, EXAMINING ATTORNEY

CLASS 26—(Continued).

SN 78-862,691. DELORI DESIGNS LLC, COLBERT, WA. FILED 4-17-2006.

DeLori Designs

THE MARK CONSISTS OF STANDARD CHARACTERS WITHOUT CLAIM TO ANY PARTICULAR FONT, STYLE, SIZE, OR COLOR.

NO CLAIM IS MADE TO THE EXCLUSIVE RIGHT TO USE "DESIGNS", APART FROM THE MARK AS SHOWN.

FOR BELT BUCKLES NOT OF PRECIOUS METAL (U.S. CLS. 37, 39, 40, 42 AND 50).

FIRST USE 7-0-2005; IN COMMERCE 2-20-2006.
TRACY CROSS, EXAMINING ATTORNEY

SN 78-862,717. DELORI DESIGNS LLC, COLBERT, WA. FILED 4-17-2006.

BUCKLE BABES

THE MARK CONSISTS OF STANDARD CHARACTERS WITHOUT CLAIM TO ANY PARTICULAR FONT, STYLE, SIZE, OR COLOR.

NO CLAIM IS MADE TO THE EXCLUSIVE RIGHT TO USE "BUCKLE", APART FROM THE MARK AS SHOWN.

FOR BELT BUCKLES NOT OF PRECIOUS METAL (U.S. CLS. 37, 39, 40, 42 AND 50).

FIRST USE 1-28-2006; IN COMMERCE 1-28-2006.
TRACY CROSS, EXAMINING ATTORNEY

SN 78-862,790. HOMEGOODS, INC., FRAMINGHAM, MA. FILED 4-17-2006.

MON AMI

THE MARK CONSISTS OF STANDARD CHARACTERS WITHOUT CLAIM TO ANY PARTICULAR FONT, STYLE, SIZE, OR COLOR.

OWNER OF U.S. REG. NO. 2,912,736.

THE ENGLISH TRANSLATION OF MON AMI IS MY FRIEND.

FOR ARTIFICIAL FLOWERS AND FOLIAGE, AND ARTIFICIAL FLORAL ARRANGEMENTS (U.S. CLS. 37, 39, 40, 42 AND 50).

MICHAEL WEBSTER, EXAMINING ATTORNEY

CLASS 26—(Continued).

SN 78-862,795. HOMEGOODS, INC., FRAMINGHAM, MA. FILED 4-17-2006.

WATER.WOOD.SKY

THE MARK CONSISTS OF STANDARD CHARACTERS WITHOUT CLAIM TO ANY PARTICULAR FONT, STYLE, SIZE, OR COLOR.
FOR ARTIFICIAL FLOWERS AND FOLIAGE, AND ARTIFICIAL FLORAL ARRANGEMENTS (U.S. CLS. 37, 39, 40, 42 AND 50).
MICHAEL WEBSTER, EXAMINING ATTORNEY

SN 78-867,019. PRONATURAL HAIR, INC., HUNTSVILLE, AL. FILED 4-21-2006.

EXTENDER

THE MARK CONSISTS OF STANDARD CHARACTERS WITHOUT CLAIM TO ANY PARTICULAR FONT, STYLE, SIZE, OR COLOR.
FOR HAIRPIECES; TOUPEES, WIGS (U.S. CLS. 37, 39, 40, 42 AND 50).
TONJA GASKINS, EXAMINING ATTORNEY

SN 78-871,081. LOCKHEED MARTIN CORPORATION, BETHESDA, MD. FILED 4-27-2006.

LIGHTNING II

THE MARK CONSISTS OF STANDARD CHARACTERS WITHOUT CLAIM TO ANY PARTICULAR FONT, STYLE, SIZE, OR COLOR.
FOR DECORATIVE CLOTH SHOULDER PATCHES, EMBROIDERED PATCHES FOR CLOTHING (U.S. CLS. 37, 39, 40, 42 AND 50).
ESTHER BELENKER, EXAMINING ATTORNEY

CLASS 26—(Continued).

SN 78-910,271. CELEBRITY SIGNATURES INTERNATIONAL, INC., KANSAS CITY, MO. FILED 6-16-2006.

**hairdo do great hair every
day**

THE MARK CONSISTS OF STANDARD CHARACTERS WITHOUT CLAIM TO ANY PARTICULAR FONT, STYLE, SIZE, OR COLOR.
FOR WIGS, HAIRPIECES, HAIR EXTENSIONS, AND ADD-IN AND ADD-ON HAIR ACCESSORIES CONSTRUCTED PRIMARILY OF SYNTHETIC AND/OR HUMAN HAIR (U.S. CLS. 37, 39, 40, 42 AND 50).
PAUL E. FAHRENKOPF, EXAMINING ATTORNEY

CLASS 27—FLOOR COVERINGS

SN 78-850,590. CAESAREA CREATION INDUSTRIES LTD., OR-AKIVA, ISRAEL, FILED 3-30-2006.



NO CLAIM IS MADE TO THE EXCLUSIVE RIGHT TO USE CAESAREA CREATIONS, APART FROM THE MARK AS SHOWN.
THE COLOR(S) GOLD AND BROWN IS/ARE CLAIMED AS A FEATURE OF THE MARK.
THE MARK CONSISTS OF A LONG AND NARROW GOLD BOX WITH A GOLD AND BROWN CROWN ON ITS TOP AND ACROSS THE CENTER OF A TALLER BROWN BOX.
FOR FLOOR COVERINGS, CARPETS, RUGS, CARPET BACKING AND CARPET PADDING (U.S. CLS. 19, 20, 37, 42 AND 50).
FIRST USE 7-10-2001; IN COMMERCE 7-10-2001.
KATHERINE STOIDES, EXAMINING ATTORNEY

SN 78-860,970. HENAN PROSPER USA, INC., RANCHO CUCAMONGA, CA. FILED 4-13-2006.

SHEAR STYLE

THE MARK CONSISTS OF STANDARD CHARACTERS WITHOUT CLAIM TO ANY PARTICULAR FONT, STYLE, SIZE, OR COLOR.
NO CLAIM IS MADE TO THE EXCLUSIVE RIGHT TO USE "STYLE", APART FROM THE MARK AS SHOWN.
FOR SHEEPSKIN RUGS (U.S. CLS. 19, 20, 37, 42 AND 50).
FIRST USE 5-10-2005; IN COMMERCE 5-10-2005.
DAVID C. REIHNER, EXAMINING ATTORNEY

CLASS 27—(Continued).

SN 78-861,105. INVISTA NORTH AMERICA S.A.R.L., WILMINGTON, DE. FILED 4-13-2006.



OWNER OF U.S. REG. NOS. 2,485,680, 2,986,365 AND OTHERS.

THE MARK CONSISTS OF AN ELONGATED HORIZONTAL WAVY LINE SEPARATING THE LITERAL ELEMENTS OF THE MARK.

FOR CARPET PADDING; CARPETS; FLOOR COVERINGS; VINYL FLOOR COVERINGS (U.S. CLS. 19, 20, 37, 42 AND 50).

HEATHER THOMPSON, EXAMINING ATTORNEY

SN 78-861,134. INVISTA NORTH AMERICA S.A.R.L., WILMINGTON, DE. FILED 4-13-2006.

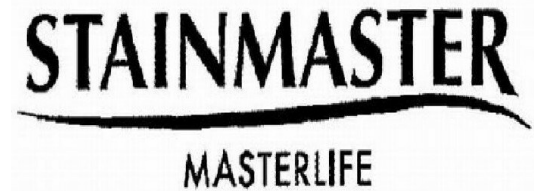

OWNER OF U.S. REG. NOS. 1,971,591, 2,986,365 AND OTHERS.

THE MARK CONSISTS OF AN ELONGATED HORIZONTAL WAVY LINE SEPARATING THE LITERAL ELEMENTS OF THE MARK.

FOR CARPET PADDING; CARPETS; FLOOR COVERINGS; VINYL FLOOR COVERINGS (U.S. CLS. 19, 20, 37, 42 AND 50).

HEATHER THOMPSON, EXAMINING ATTORNEY

SN 78-861,182. INVISTA NORTH AMERICA S.A.R.L., WILMINGTON, DE. FILED 4-13-2006.



OWNER OF U.S. REG. NOS. 2,129,204, 2,986,365 AND OTHERS.

THE MARK CONSISTS OF AN ELONGATED HORIZONTAL WAVY LINE SEPARATING THE LITERAL ELEMENTS OF THE MARK.

FOR CARPET PADDING; CARPETS; FLOOR COVERINGS; VINYL FLOOR COVERINGS (U.S. CLS. 19, 20, 37, 42 AND 50).

HEATHER THOMPSON, EXAMINING ATTORNEY

CLASS 27—(Continued).

SN 78-864,420. PEPSICO, INC., PURCHASE, NY. FILED 4-19-2006.



OWNER OF U.S. REG. NOS. 820,362, 2,982,214 AND OTHERS.

THE APPLICANT CLAIMS COLOR AS A FEATURE OF THE MARK, NAMELY, GREEN, RED, WHITE AND BLACK ARE CLAIMED AS A FEATURE OF THE MARK.

THE MARK CONSISTS OF THE WORDS MOUNTAIN AND DEW IN STYLIZED LETTERS. THE WORD MOUNTAIN IS GREEN AND THE WORD DEW IS RED. THE WORDS ARE WITHIN AN OVAL-LIKE DESIGN THAT CONTAINS THE COLORS WHITE, LIGHT AND DARK GREEN WITH A BLACK OUTLINE.

FOR RUGS (U.S. CLS. 19, 20, 37, 42 AND 50).

THEODORE MCBRIDE, EXAMINING ATTORNEY

SN 78-876,173. INVISTA NORTH AMERICA S.A.R.L., WILMINGTON, DE. FILED 5-4-2006.

ALWAYS STYLISH. ALWAYS BEAUTIFUL.

THE MARK CONSISTS OF STANDARD CHARACTERS WITHOUT CLAIM TO ANY PARTICULAR FONT, STYLE, SIZE, OR COLOR.

FOR CARPET PADDING; CARPETS; FLOOR COVERINGS; VINYL FLOOR COVERINGS (U.S. CLS. 19, 20, 37, 42 AND 50).

FIRST USE 3-1-2006; IN COMMERCE 3-1-2006.

HEATHER THOMPSON, EXAMINING ATTORNEY

CLASS 27—(Continued).

SN 78-877,691. INVISTA NORTH AMERICA S.A.R.L., WILMINGTON, DE. FILED 5-5-2006.



OWNER OF U.S. REG. NO. 2,438,778.
 THE MARK CONSISTS OF THE LITERAL ELEMENT CONTAINING A FANCIFUL LETTER I.
 FOR CARPETS; RUGS (U.S. CLS. 19, 20, 37, 42 AND 50).
 FIRST USE 9-1-2003; IN COMMERCE 9-1-2003.
 HEATHER THOMPSON, EXAMINING ATTORNEY

SN 78-879,336. INVISTA NORTH AMERICA S.A.R.L., WILMINGTON, DE. FILED 5-9-2006.

SUPRIVA

THE MARK CONSISTS OF STANDARD CHARACTERS WITHOUT CLAIM TO ANY PARTICULAR FONT, STYLE, SIZE, OR COLOR.

OWNER OF U.S. REG. NO. 2,438,778.
 FOR CARPETS; RUGS (U.S. CLS. 19, 20, 37, 42 AND 50).
 FIRST USE 9-1-2003; IN COMMERCE 9-1-2003.
 HEATHER THOMPSON, EXAMINING ATTORNEY

SN 78-879,410. INVISTA NORTH AMERICA S.A.R.L., WILMINGTON, DE. FILED 5-9-2006.

STAINMASTER

GRAND LUXURA CARPET

OWNER OF U.S. REG. NOS. 2,129,204, 2,327,094 AND 2,973,928.

NO CLAIM IS MADE TO THE EXCLUSIVE RIGHT TO USE "CARPET", APART FROM THE MARK AS SHOWN.

THE MARK CONSISTS OF AN ELONGATED HORIZONTAL WAVY LINE SEPARATING THE LITERAL ELEMENTS OF THE MARK.

FOR CARPET PADDING; CARPETS; FLOOR COVERINGS; VINYL FLOOR COVERINGS (U.S. CLS. 19, 20, 37, 42 AND 50).

FIRST USE 3-1-2006; IN COMMERCE 3-1-2006.
 HEATHER THOMPSON, EXAMINING ATTORNEY

CLASS 27—(Continued).

SN 78-895,379. INVISTA NORTH AMERICA S.A.R.L., WILMINGTON, DE. FILED 5-30-2006.

STAINMASTER

ULTRA LIFE CARPET

OWNER OF U.S. REG. NOS. 2,129,204, 2,986,365 AND OTHERS.

NO CLAIM IS MADE TO THE EXCLUSIVE RIGHT TO USE "CARPET", APART FROM THE MARK AS SHOWN.

THE MARK CONSISTS OF AN ELONGATED HORIZONTAL WAVY LINE SEPARATING THE LITERAL ELEMENTS OF THE MARK.

FOR CARPETS (U.S. CLS. 19, 20, 37, 42 AND 50).
 FIRST USE 4-0-2006; IN COMMERCE 4-0-2006.
 HEATHER THOMPSON, EXAMINING ATTORNEY

CLASS 28—TOYS AND SPORTING GOODS

SN 76-588,835. SJS PAINTBALL, LP, RICHARDSON, TX. FILED 4-23-2004.

HAMMERHEAD

THE MARK CONSISTS OF STANDARD CHARACTERS WITHOUT CLAIM TO ANY PARTICULAR FONT, STYLE, SIZE, OR COLOR.

FOR PAINTBALL GUN BARRELS, MARKERS, BALL SIZERS AND BALL GAUGES (U.S. CLS. 22, 23, 38 AND 50).

FIRST USE 1-16-2003; IN COMMERCE 1-16-2003.
 TOMAS V. VLCEK, EXAMINING ATTORNEY

SN 76-630,112. HORELICK, MICHAEL, SANTA MONICA, CA. FILED 2-1-2005.

TUNNEL

FOR SKATEBOARDS AND SKATEBOARD WHEELS (U.S. CLS. 22, 23, 38 AND 50).

FIRST USE 6-1-1975; IN COMMERCE 6-1-1975.
 KELLEY WELLS, EXAMINING ATTORNEY

CLASS 28—(Continued).

SN 76-646,303. HOME FOCUS DEVELOPMENT LTD., ROAD TOWN, TORTOLA, BR.VIRGIN ISLANDS, FILED 9-6-2005.

CANDY LIP GLOSS

THE MARK CONSISTS OF STANDARD CHARACTERS WITHOUT CLAIM TO ANY PARTICULAR FONT, STYLE, SIZE, OR COLOR.

FOR BOARD GAMES, CARD GAMES, ACTION TYPE TARGET GAMES, AND PARLOR GAMES; BEANBAGS; TOY BUILDING BLOCKS; PAPER CARDBOARD AND PLASTIC CAPS FOR TOY GUNS, HOLDERS FOR TOY CAP GUN CAPS, AND TOY CAP GUNS; MECHANICAL ACTION TOYS; KITES; ELECTRIC ACTION FIGURES WITH LIGHTS AND SOUNDS; COLLECTIBLE ITEMS, PLASTIC TOY FIGURINES IN VARIOUS SIZES, TOY FINGER RINGS, TOY NECKLACES, TOY KEY RINGS, TOY BRACELETS; YO-YO'S; SPIN TOPS; PLASTIC TOYS, NAMELY BALLS, RINGS, TOY JEWELRY, TOY COSMETIC CONTAINERS, TOY COSMETIC APPLICATORS, TOY DISPENSERS FOR CANDY, TOY DISPENSERS FOR FOOD PRODUCTS; TOYS INCORPORATING MAGNETS, NAMELY MAGNETIC TOY COSMETIC APPLICATORS AND MAGNETIC TOY COSMETIC CONTAINERS, MAGNETIC TOY CANDY DISPENSERS, MAGNETIC TOY FOOD DISPENSERS, MAGNETIC TOY CANDY CONTAINERS; TOY BOXES; PLUSH TOYS; FLYING DISCS; GLASS ORNAMENTS AND DECORATIONS FOR CHRISTMAS TREES; COSTUME MASKS; STUFFED TOY ANIMALS IN VARIOUS SIZES; EQUIPMENT SOLD AS A UNIT FOR PLAYING CARD GAMES; GAME BOARDS FOR TRADING CARD GAMES; TOY STAMPS WITH FIGURES; TOY AND WATER PISTOLS, GUNS, AND CANNONS; DOLLS AND BABY DOLLS; BALLOONS; BATHTUB TOYS; SKATEBOARDS, ICE SKATES, ROLLER SKATES, AND INLINE SKATES; SURF BOARDS AND SWIM BOARDS; BALLS, NAMELY BEACH BALLS, BASKET BALLS, BASE BALLS, FOOT BALLS, TENNIS BALLS, SPONGE BALLS; ELECTRONIC TOYS IN THE NATURE OF TOYS HAVING LIGHTS, NAMELY LIGHT UP TOY COSMETIC APPLICATORS, LIGHT UP TOY COSMETIC CONTAINERS AND LIGHT UP TOYS FOR DISPENSING CANDY AND FOOD PRODUCTS; TOY COSMETIC CONTAINERS HAVING LIGHTS; TOY COSMETIC APPLICATORS HAVING LIGHTS, TOY CANDY DISPENSERS HAVING LIGHTS; JIGSAW PUZZLES, AND OTHER GAMES AND TOYS, NAMELY TOY COSMETIC APPLICATORS, TOY COSMETIC CONTAINERS AND TOYS FOR DISPENSING CANDY AND FOOD PRODUCTS (U.S. CLS. 22, 23, 38 AND 50).

MARTHA SANTOMARTINO, EXAMINING ATTORNEY

SN 76-648,599. ONANIAN, RICHARD A., ARLINGTON, MA. FILED 10-17-2005.

FACTS-IN-FIVE

THE MARK CONSISTS OF STANDARD CHARACTERS WITHOUT CLAIM TO ANY PARTICULAR FONT, STYLE, SIZE, OR COLOR.

FOR EQUIPMENT SOLD AS A UNIT FOR PLAYING A WORD QUIZ GAME (U.S. CLS. 22, 23, 38 AND 50). FIRST USE 11-20-2004; IN COMMERCE 11-20-2004. COLLEEN DOMBROW, EXAMINING ATTORNEY

CLASS 28—(Continued).

SN 76-653,896. STRIKEOUT STRIPPERZ LLC, COLUMBIANA, OH. FILED 1-25-2006.

Strikeoutstrippz

THE MARK CONSISTS OF STANDARD CHARACTERS WITHOUT CLAIM TO ANY PARTICULAR FONT, STYLE, SIZE, OR COLOR.

FOR ATHLETIC TRAINING EQUIPMENT, NAMELY, BASEBALL PRACTICE PITCHING GLOVES (U.S. CLS. 22, 23, 38 AND 50).

VIVIAN MICZNIK FIRST, EXAMINING ATTORNEY

SN 76-653,919. STRIKEOUT STRIPPERZ LLC, COLUMBIANA, OH. FILED 1-25-2006.

RocketStrippz

THE MARK CONSISTS OF STANDARD CHARACTERS WITHOUT CLAIM TO ANY PARTICULAR FONT, STYLE, SIZE, OR COLOR.

FOR ATHLETIC TRAINING EQUIPMENT, NAMELY, BASEBALL PRACTICE PITCHING GLOVES (U.S. CLS. 22, 23, 38 AND 50).

VIVIAN MICZNIK FIRST, EXAMINING ATTORNEY

SN 76-657,331. MAGS ENTERTAINMENT, LLC, GREENWOOD, SC. FILED 3-24-2006.

**BEARSHEBA J. BEAR
BJ'S TEDDY BEAR CLUB
AND BIBLE STORIES**

THE MARK CONSISTS OF STANDARD CHARACTERS WITHOUT CLAIM TO ANY PARTICULAR FONT, STYLE, SIZE, OR COLOR.

NO CLAIM IS MADE TO THE EXCLUSIVE RIGHT TO USE "BEAR", "TEDDY BEAR", AND "BIBLE STORIES", APART FROM THE MARK AS SHOWN.

THE NAME BEARSHEBA J. BEAR DOES NOT IDENTIFY A LIVING INDIVIDUAL.

FOR TOYS, GAMES, PLAYTHINGS AND SPORTING GOODS, NAMELY, TEDDY BEARS, STUFFED TOY ANIMALS, PLUSH TOYS, TOY ANIMAL FIGURES AND PLAY SETS AND ACCESSORIES THEREFOR, ACTION FIGURES AND ACCESSORIES THEREFOR, DOLLS, BEANBAG DOLLS, DOLL PLAYSETS, DOLL CLOTHING, PUPPETS, HOBBY CRAFT KITS FOR MAKING TOY FIGURES; INFANT CRIB TOYS, CHILD'S MULTIPLE ACTIVITY TOYS, BALLOONS, TOY BANKS, BATHTUB TOYS, RIDE-ON TOYS, TOY CONSTRUCTION BLOCKS, FLYING DISCS, PARLOR GAMES, BOARD GAMES, CARD GAMES, MANIPULATIVE GAMES, PARTY GAMES NAMELY TRIVIA GAMES, ROLE-PLAYING GAMES, ACTION-TYPE TARGET GAMES, ROCKING HORSES, JIGSAW PUZZLES, MANIPULATIVE PUZZLES, KITES, MUSICAL TOYS

CLASS 28—(Continued).

NAMELY TOY WHISTLES, PARTY FAVORS IN THE NATURE OF SMALL TOYS, TOY CAP PISTOLS, TOY GUNS, WATER SQUIRTING TOYS, WIND-UP TOYS, TOY SANDBOXES AND SAND TOYS, TOY BUCKET AND SHOVEL SETS, SWIMMING FLOATS FOR RECREATIONAL USE, INFLATABLE PUNCHING TOYS, JUMP ROPES, MUSICAL TOYS, CHRISTMAS TREE ORNAMENTS, YO-YOS, TOY VEHICLES, NAMELY, TOY CARS, TOY TRUCKS, TOY AIRPLANES, TOY BOATS, TOY SPACESHIPS AND TOY TRAINS, TOY MODEL HOBBY-CRAFT KITS, BUBBLE MAKING WANDS AND SOLUTIONS SETS, FACE MASKS, COSTUME MASKS; TOY FILM CARTRIDGES AND VIEWERS NAMELY TOY HAND HELD SLIDE VIEWERS AND REELS; TOY PLAY HOUSES AND PLAY TENTS, BALLS, NAMELY, PLAYGROUND BALLS, BEACH BALLS, SOCCER BALLS, BASEBALLS, FOOTBALLS, BASKETBALLS, FOAM BALLS, RUBBER BALLS AND PLASTIC BALLS, ELECTRONIC BATTERY-OPERATED ACTION TOYS, HAND HELD UNITS FOR PLAYING ELECTRONIC GAMES (U.S. CLS. 22, 23, 38 AND 50).

KATHERINE E. HALMEN, EXAMINING ATTORNEY

CLASS 28—(Continued).

SN 76-658,837. HASBRO, INC., PAWTUCKET, RI. FILED 4-20-2006.

TIE ONE ON

THE MARK CONSISTS OF STANDARD CHARACTERS WITHOUT CLAIM TO ANY PARTICULAR FONT, STYLE, SIZE, OR COLOR.

FOR PARLOR GAMES (U.S. CLS. 22, 23, 38 AND 50).
KEVON CHISOLM, EXAMINING ATTORNEY

SN 76-658,327. ENERMAX TECHNOLOGY CORPORATION, TAOYUAN, TAIWAN, FILED 4-12-2006.



FOR VOLLEYBALL, BASKETBALL; GOLF BALL, GOLF BAG; SQUASH RACKET; HOCKEY PUCK; ROLLER SKATE; CHEST EXPANDER; STATIONARY EXERCISE BIKE; BODY-BUILDING APPARATUS, NAMELY, ROWING MACHINES, STEP MACHINES, TREADMILLS, WEIGHT LIFTING BENCHES, BAR BELLS AND DUMB BELLS (U.S. CLS. 22, 23, 38 AND 50).

FIRST USE 2-28-2006; IN COMMERCE 2-28-2006.
ELLEN PERKINS, EXAMINING ATTORNEY

SN 78-195,027. MATTEL, INC., EL SEGUNDO, CA. FILED 12-16-2002.

HOLIDAY JOY

FOR TOYS, GAMES AND PLAYTHINGS, NAMELY, DOLLS, DOLL CLOTHING AND DOLL ACCESSORIES (U.S. CLS. 22, 23, 38 AND 50).

CHRISTOPHER OTT, EXAMINING ATTORNEY

SN 76-658,433. TORNABENE, DEAN G., MARINA DEL REY, CA. FILED 4-14-2006.

AB CROSS

THE MARK CONSISTS OF STANDARD CHARACTERS WITHOUT CLAIM TO ANY PARTICULAR FONT, STYLE, SIZE, OR COLOR.

NO CLAIM IS MADE TO THE EXCLUSIVE RIGHT TO USE "AB", APART FROM THE MARK AS SHOWN.

FOR MANUALLY OPERATED EXERCISE EQUIPMENT TO EXERCISE THE ABDOMINAL AREA AND UPPER BODY AREA OF A HUMAN BEING (U.S. CLS. 22, 23, 38 AND 50).

MARGERY A. TIERNEY, EXAMINING ATTORNEY

SN 78-235,251. MELAS, INC., SALEM, IL. FILED 4-8-2003.

SLAM SERIES

NO CLAIM IS MADE TO THE EXCLUSIVE RIGHT TO USE "SERIES", APART FROM THE MARK AS SHOWN. FOR BASKETBALL GOAL SETS (U.S. CLS. 22, 23, 38 AND 50).

FIRST USE 12-0-1995; IN COMMERCE 12-0-1995.
SHARI SHEFFIELD, EXAMINING ATTORNEY

CLASS 28—(Continued).

SN 78-336,484. SUSANNA RUSSO-BARONE, WHITBY, ONTARIO, CANADA, FILED 12-4-2003.

CLASS 28—(Continued).

SN 78-400,044. SPIN MASTER LTD., TORONTO, CANADA, FILED 4-12-2004.

MAGIC HAIR BEADER

Z'MUZZIEZ

THE MARK CONSISTS OF STANDARD CHARACTERS WITHOUT CLAIM TO ANY PARTICULAR FONT, STYLE, SIZE, OR COLOR.

PRIORITY CLAIMED UNDER SEC. 44(D) ON CANADA APPLICATION NO. 1180407, FILED 6-6-2003, REG. NO. TMA668,127, DATED 7-18-2006, EXPIRES 7-18-2021.

FOR PLUSH TOYS AND DOLLS MADE OF PLUSH FABRIC AND NATURAL AND SYNTHETIC SKINS (U.S. CLS. 22, 23, 38 AND 50).

MICHELE SWAIN, EXAMINING ATTORNEY

THE MARK CONSISTS OF STANDARD CHARACTERS WITHOUT CLAIM TO ANY PARTICULAR FONT, STYLE, SIZE, OR COLOR.

PRIORITY CLAIMED UNDER SEC. 44(D) ON CANADA APPLICATION NO. 1204211, FILED 1-26-2004, REG. NO. TMA639648, DATED 5-11-2005, EXPIRES 5-11-2020.

NO CLAIM IS MADE TO THE EXCLUSIVE RIGHT TO USE "HAIR BEADER", APART FROM THE MARK AS SHOWN.

FOR NOVELTY KITS FOR APPLYING BEADS TO HAIR, PRIMARILY COMPRISING A TOY HAND TOOL IN THE NATURE OF A HAIR CLASPER, HAIR CLASPS, BEADS AND A BEADER HOOK (U.S. CLS. 22, 23, 38 AND 50).

ELLEN B. AWRICH, EXAMINING ATTORNEY

SN 78-364,151. K-2 CORPORATION, VASHON, WA. FILED 2-6-2004.

SN 78-522,048. THE UNITED STATES PLAYING CARD COMPANY, CINCINNATI, OH. FILED 11-23-2004.

CINCH

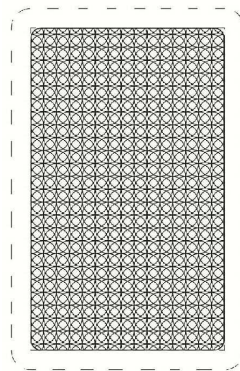

THE MARK CONSISTS OF STANDARD CHARACTERS WITHOUT CLAIM TO ANY PARTICULAR FONT, STYLE, SIZE, OR COLOR.

FOR SPORTS EQUIPMENT, NAMELY SNOWBOARD BINDINGS (U.S. CLS. 22, 23, 38 AND 50).

FIRST USE 2-2-2004; IN COMMERCE 2-2-2004.
CATHERINE FAINT, EXAMINING ATTORNEY

THE MARK CONSISTS OF THE DESIGN FOR THE BACK OF THE PLAYING CARDS.

FOR PLAYING CARDS (U.S. CLS. 22, 23, 38 AND 50).
DORITT L. CARROLL, EXAMINING ATTORNEY

CLASS 28—(Continued).

SN 78-523,259. ACADIA SPORTS, INC., IRVING, TX. FILED 11-27-2004.



NO CLAIM IS MADE TO THE EXCLUSIVE RIGHT TO USE "SPORTS", APART FROM THE MARK AS SHOWN.

THE COLOR(S) BLUE AND GOLD IS/ARE CLAIMED AS A FEATURE OF THE MARK.

THE MARK CONSISTS OF A LOGO OF INTERSECTING RINGS IN BLUE AND GOLD. THE WORD PORTION OF THE MARK APPEARS TO THE RIGHT OF THE LOGO, WITH THE WORD ACADIA IN GOLD AND THE WORD SPORTS IN BLUE.

FOR FISHING EQUIPMENT NAMELY RODS, REELS, TACKLE, TACKLE BOXES, FISHING LINE AND FISHING ROD CASES (U.S. CLS. 22, 23, 38 AND 50).

FIRST USE 11-22-2004; IN COMMERCE 9-27-2005.
GISELLE AGOSTO, EXAMINING ATTORNEY

CLASS 28—(Continued).

SN 78-651,145. S.R. MICKELBERG COMPANY, INC., DBA SRM ENTERTAINMENT LTD., JENKINSTOWN, PA. FILED 6-15-2005.

ARMATRON

THE MARK CONSISTS OF STANDARD CHARACTERS WITHOUT CLAIM TO ANY PARTICULAR FONT, STYLE, SIZE, OR COLOR.

FOR TOYS NAMELY BATTERY OPERATED TOY ROBOT ARM CONSISTING OF MECHANICAL GRIP, TELESCOPING, PIVOTING, TWISTING, LIGHTS AND SOUNDS FOR BOTH TABLETOP AND PORTABLE, MOBILE, TETHERED AND REMOTE APPLICATIONS (U.S. CLS. 22, 23, 38 AND 50).

FIRST USE 4-11-2002; IN COMMERCE 4-11-2002.
STEVEN PEREZ, EXAMINING ATTORNEY

SN 78-565,610. MITSUSHIBA INTERNATIONAL, INC., FULLERTON, CA. FILED 2-11-2005.

Big Ezee

FOR GOLF CLUB HEADS, HEAD COVERS, GRIPS AND SHAFTS; GOLF BAGS AND BALLS (U.S. CLS. 22, 23, 38 AND 50).

FIRST USE 2-1-2005; IN COMMERCE 2-1-2005.
IRA J. GOODSaid, EXAMINING ATTORNEY

SN 78-651,182. S.R. MICKELBERG COMPANY, INC., DBA SRM ENTERTAINMENT LTD., JENKINTOWN, PA. FILED 6-15-2005.

FLASHIN' FASHION

THE MARK CONSISTS OF STANDARD CHARACTERS WITHOUT CLAIM TO ANY PARTICULAR FONT, STYLE, SIZE, OR COLOR.

FOR TOYS NAMELY BATTERY OPERATED ACTION TOYS FOR GIRLS (U.S. CLS. 22, 23, 38 AND 50).

FIRST USE 1-1-2004; IN COMMERCE 1-1-2004.
STEVEN PEREZ, EXAMINING ATTORNEY

SN 78-579,162. MATTEL, INC., EL SEGUNDO, CA. FILED 3-3-2005.

ALPINE RESCUE

THE MARK CONSISTS OF STANDARD CHARACTERS WITHOUT CLAIM TO ANY PARTICULAR FONT, STYLE, SIZE, OR COLOR.

NO CLAIM IS MADE TO THE EXCLUSIVE RIGHT TO USE "RESCUE", APART FROM THE MARK AS SHOWN.

FOR TOYS, GAMES AND PLAYTHINGS, NAMELY, TOY VEHICLES AND ACCESSORIES THEREFOR (U.S. CLS. 22, 23, 38 AND 50).

TONJA GASKINS, EXAMINING ATTORNEY

SN 78-655,746. GLOD, DAVID, ST. CHARLES, IL. FILED 6-22-2005.

HP5

THE MARK CONSISTS OF STANDARD CHARACTERS WITHOUT CLAIM TO ANY PARTICULAR FONT, STYLE, SIZE, OR COLOR.

FOR GOLF CLUBS AND COMPONENTS THEREOF, NAMELY, GOLF CLUB HEADS, GOLF CLUB SHAFTS AND HAND GRIPS FOR GOLF CLUBS (U.S. CLS. 22, 23, 38 AND 50).

MICHAEL LEWIS, EXAMINING ATTORNEY

CLASS 28—(Continued).

SN 78-666,815. RAWLINGS SPORTING GOODS COMPANY, INC., FENTON, MO. FILED 7-8-2005.

CLASS 28—(Continued).

SN 78-681,852. WESTERN BINGO SUPPLIES, INC., DBA TRADE PRODUCTS, LYNNWOOD, WA. FILED 7-29-2005.

INNOVATION AT PLAY

THE MARK CONSISTS OF STANDARD CHARACTERS WITHOUT CLAIM TO ANY PARTICULAR FONT, STYLE, SIZE, OR COLOR.

FOR HOUSEMARK FOR SPORTING GOODS, NAMELY, BASEBALLS, BASEBALL BATS, BASEBALL BAT SLEEVES, BASEBALL GLOVES, BASEBALL MITTS, BASEBALL BATTING GLOVES, BASEBALL GLOVE LACES, BASEBALL LEG GUARDS, BASEBALL MASKS, BASEBALL BODY PROTECTORS, BASEBALL SLIDING PADS, BASEBALL UMPIRE BODY PROTECTORS, SOFTBALLS, SOFTBALL BATS, SOFTBALL BAT SLEEVES, SOFTBALL GLOVES AND MITTS, SOFTBALL LEG GUARDS, SOFTBALL MASKS, SOFTBALL BODY PROTECTORS, BASKETBALLS, BASKETBALL NETS, BASKETBALL CARRIERS, FOOTBALLS, FOOTBALL SHOULDER PADS, FOOTBALL INJURY PROTECTIVE PADS, FOOTBALL THIGH GUARDS, FOOTBALL HIP PADS, FOOTBALL KNEE PADS, FOOTBALL ELBOW PADS, FOOTBALL BLOCKING PADS, FOOTBALL SHIN GUARDS, FOOTBALL RECEIVER'S GLOVES, FOOTBALL KICKING TEES, BASEBALL BAT BAGS, BASEBALL BALL BAGS, BASEBALL BAT HOLDERS, BASEBALL EQUIPMENT BAGS, SOFTBALL BAT BAGS, SOFTBALL BALL BAGS, SOFTBALL BAT HOLDERS, SOFTBALL EQUIPMENT BAGS, BASEBALL UMPIRE'S BALL BAGS, BASKETBALL BALL BAGS, VOLLEYBALLS AND SOCCER BALLS (U.S. CLS. 22, 23, 38 AND 50).

DAWN HAN, EXAMINING ATTORNEY

FLASH SEAL

THE MARK CONSISTS OF STANDARD CHARACTERS WITHOUT CLAIM TO ANY PARTICULAR FONT, STYLE, SIZE, OR COLOR.

FOR GAMING TICKETS, NAMELY, DISPOSABLE TICKET SETS FOR PLAYING GAMES OF CHANCE (U.S. CLS. 22, 23, 38 AND 50).

FIRST USE 4-0-1997; IN COMMERCE 4-0-1997.

GENE MACIOL, EXAMINING ATTORNEY

SN 78-689,499. GLOBAL SPORTS CONSULTANTS, LLC, DBA JET SET SPORTS, FAR HILLS, NJ. FILED 8-10-2005.

SN 78-674,912. MGA ENTERTAINMENT, INC., VAN NUYS, CA. FILED 7-20-2005.

JET SET SPORTS

MIMI MANGO CALICO

THE MARK CONSISTS OF STANDARD CHARACTERS WITHOUT CLAIM TO ANY PARTICULAR FONT, STYLE, SIZE, OR COLOR.

NO CLAIM IS MADE TO THE EXCLUSIVE RIGHT TO USE "MANGO CALICO", APART FROM THE MARK AS SHOWN.

FOR TOYS, GAMES AND PLAYTHINGS, NAMELY, BEAN BAG DOLLS; DOLLS; DOLL ACCESSORIES; DOLL CLOTHING, AND DOLL PLAYSETS; PLUSH TOYS (U.S. CLS. 22, 23, 38 AND 50).

KRISTIN DAHLING, EXAMINING ATTORNEY

THE MARK CONSISTS OF STANDARD CHARACTERS WITHOUT CLAIM TO ANY PARTICULAR FONT, STYLE, SIZE, OR COLOR.

NO CLAIM IS MADE TO THE EXCLUSIVE RIGHT TO USE "SPORTS", APART FROM THE MARK AS SHOWN.

FOR SPORTS AND ATHLETIC EQUIPMENT, NAMELY SNOW SKIS, SKI POLES, FLYING DISCS, BEACH BALLS, BASEBALLS, SOFT BALLS, TENNIS BALLS, RACQUETBALLS, BASKETBALLS, GOLF BALLS, SOCCER BALLS, BASEBALL BATS, BASEBALL GLOVES, GOLF BAGS, SCUBA EQUIPMENT CONSISTING OF FINS, FLIPPERS, AND SPRING-ACTIVATED SPEAR GUNS, RACKET BALL RACKETS AND CASES AND TENNIS RACKETS AND CASES (U.S. CLS. 22, 23, 38 AND 50).

JOHN DALIER, EXAMINING ATTORNEY

CLASS 28—(Continued).

SN 78-693,677. DEUTSCHE TELEKOM AG, BONN, FED REP GERMANY, FILED 8-16-2005.

PRIORITY CLAIMED UNDER SEC. 44(D) ON FED REP GERMANY APPLICATION NO. 30509334.7/3, FILED 2-17-2005, REG. NO. 30509334, DATED 11-14-2005, EXPIRES 2-28-2015.

OWNER OF U.S. REG. NO. 2,508,277 AND OTHERS.
FOR TOYS, NAMELY, BOARD GAMES, PARLOR GAMES, CARD GAMES, TOY ACTION FIGURES, WIND-UP TOYS, STUFFED TOYS, ELECTRICAL AND MECHANICAL ACTION TOYS, GYMNASTIC APPARATUS AND SPORTING ARTICLES, NAMELY, CYCLING EQUIPMENT AND ACCESSORIES, NAMELY STATIONARY CYCLES, FOOTBALL EQUIPMENT AND ACCESSORIES, NAMELY, FOOTBALLS, FOOTBALL SHOULDER PADS, FOOTBALL GIRDLES, FOOTBALL BODY PROTECTORS, FOOTBALL KNEE, ELBOW, CHEST AND LEG PADS, SOCCER EQUIPMENT AND ACCESSORIES, NAMELY, SOCCER BALLS, SOCCER BALL GOAL NETS, SOCCER BALL KNEE PADS, BASEBALL EQUIPMENT AND ACCESSORIES, NAMELY BASEBALLS, BASEBALL BATS, BASEBALL BASES, BASEBALL MITTS, BASEBALL GLOVES, BASKETBALL EQUIPMENT AND ACCESSORIES, NAMELY, BASKETBALLS, BASKETBALL GOALS, BASKETBALL NETS, AND ALL PARTS RELATED THERETO (U.S. CLS. 22, 23, 38 AND 50).

SHARI SHEFFIELD, EXAMINING ATTORNEY

SN 78-694,314. GANZ, WOODBRIDGE, CANADA, FILED 8-17-2005.

LIL' KINZ

THE MARK CONSISTS OF STANDARD CHARACTERS WITHOUT CLAIM TO ANY PARTICULAR FONT, STYLE, SIZE, OR COLOR.

FOR PLUSH TOYS (U.S. CLS. 22, 23, 38 AND 50).
FIRST USE 10-20-2005; IN COMMERCE 10-20-2005.
ANTHONY RINKER, EXAMINING ATTORNEY

CLASS 28—(Continued).

SN 78-697,256. TRUE TEMPER SPORTS, INC., MEMPHIS, TN. FILED 8-22-2005.

N-GEN

THE MARK CONSISTS OF STANDARD CHARACTERS WITHOUT CLAIM TO ANY PARTICULAR FONT, STYLE, SIZE, OR COLOR.

FOR GOLF CLUB SHAFTS (U.S. CLS. 22, 23, 38 AND 50).

MELISSA VALLILLO, EXAMINING ATTORNEY

SN 78-702,300. AMZ DESIGN CO., LTD., CHIBA, JAPAN, FILED 8-29-2005.

koume

THE MARK CONSISTS OF STANDARD CHARACTERS WITHOUT CLAIM TO ANY PARTICULAR FONT, STYLE, SIZE, OR COLOR.

PRIORITY CLAIMED UNDER SEC. 44(D) ON JAPAN APPLICATION NO. 2005-074383, FILED 8-9-2005, REG. NO. 4939398, DATED 3-24-2006, EXPIRES 3-24-2016.

THE FOREIGN WORDING IN THE MARK TRANSLATES INTO ENGLISH AS "LITTLE PLUM".

FOR FISHING LINES; FISHING LURES; FISHING REELS; FISHING RODS (U.S. CLS. 22, 23, 38 AND 50).

CAROLYN CATALDO, EXAMINING ATTORNEY

SN 78-703,033. MOTORSPORTS AUTHENTICS, LLC, CONCORD, NC. FILED 8-30-2005.

PREFERRED SERIES

THE MARK CONSISTS OF STANDARD CHARACTERS WITHOUT CLAIM TO ANY PARTICULAR FONT, STYLE, SIZE, OR COLOR.

NO CLAIM IS MADE TO THE EXCLUSIVE RIGHT TO USE "SERIES", APART FROM THE MARK AS SHOWN.

SEC. 2(F).
FOR MINIATURE REPLICA AUTOMOBILES (U.S. CLS. 22, 23, 38 AND 50).

FIRST USE 2-28-2001; IN COMMERCE 2-28-2001.

DAYNA BROWNE, EXAMINING ATTORNEY

CLASS 28—(Continued).

SN 78-704,545. DAVIS, ERIC, WILMINGTON, NC. FILED 8-31-2005.



NO CLAIM IS MADE TO THE EXCLUSIVE RIGHT TO USE "SKATEBOARDS", APART FROM THE MARK AS SHOWN.

THE MARK CONSISTS OF A GROTESQUE HUMAN BEING SHOWN UPSIDE DOWN WITH A SKATEBOARD, AND THE WORDING RELIC SKATEBOARDS.

FOR SKATEBOARDS AND SKATEBOARD COMPONENTS, NAMELY SKATEBOARD DECKS AND SKATEBOARD WHEELS (U.S. CLS. 22, 23, 38 AND 50).

FIRST USE 8-29-2005; IN COMMERCE 8-29-2005.
ANDREW RHIM, EXAMINING ATTORNEY

SN 78-706,754. WOODROW, HARRISON, NEWPORT BEACH, CA. FILED 9-4-2005.

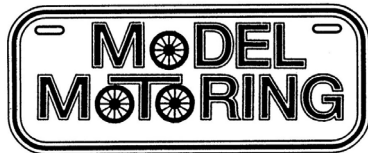

NO CLAIM IS MADE TO THE EXCLUSIVE RIGHT TO USE "MODEL", APART FROM THE MARK AS SHOWN.

FOR TOY MODEL RACING CARS, AUTOMOBILES, AND SPEEDWAYS MADE OF PLASTIC, WOOD OR OTHER MATERIALS (U.S. CLS. 22, 23, 38 AND 50).

FIRST USE 7-21-1996; IN COMMERCE 7-21-1996.
ANGELA M. MICHELI, EXAMINING ATTORNEY

SN 78-707,168. MEGA BRANDS INC., MONTREAL, QUEBEC, CANADA, FILED 9-6-2005.

PLASMA EGGS

THE MARK CONSISTS OF STANDARD CHARACTERS WITHOUT CLAIM TO ANY PARTICULAR FONT, STYLE, SIZE, OR COLOR.

NO CLAIM IS MADE TO THE EXCLUSIVE RIGHT TO USE "EGGS", APART FROM THE MARK AS SHOWN.

FOR CONSTRUCTION AND ROLE PLAY TOYS; ACTION FIGURES (U.S. CLS. 22, 23, 38 AND 50).

JULIE GUTTADAURO, EXAMINING ATTORNEY

CLASS 28—(Continued).

SN 78-716,685. ACUSHNET COMPANY, FAIRHAVEN, MA. FILED 9-20-2005.



OWNER OF U.S. REG. NOS. 1,602,461, 2,624,539 AND 2,744,734.

FOR GOLF GLOVES (U.S. CLS. 22, 23, 38 AND 50).
MICHAEL W. BAIRD, EXAMINING ATTORNEY

SN 78-721,136. MATTEL, INC., EL SEGUNDO, CA. FILED 9-27-2005.

EDANA

THE MARK CONSISTS OF STANDARD CHARACTERS WITHOUT CLAIM TO ANY PARTICULAR FONT, STYLE, SIZE, OR COLOR.

FOR TOYS, GAMES AND PLAYTHINGS, NAMELY, DOLLS, DOLL CLOTHING AND DOLL ACCESSORIES, TOY FIGURES AND ACCESSORIES THEREFOR (U.S. CLS. 22, 23, 38 AND 50).

YONG KIM, EXAMINING ATTORNEY

SN 78-721,424. KING PAR CORPORATION, FLUSHING, MI. FILED 9-27-2005.

ROLLIN

THE MARK CONSISTS OF STANDARD CHARACTERS WITHOUT CLAIM TO ANY PARTICULAR FONT, STYLE, SIZE, OR COLOR.

FOR GOLF CLUBS (U.S. CLS. 22, 23, 38 AND 50).

FIRST USE 1-10-2004; IN COMMERCE 1-10-2004.
AMY GEARIN, EXAMINING ATTORNEY

CLASS 28—(Continued).

SN 78-729,245. HICO, INC., ENCINO, CA. FILED 10-7-2005.

INVISIBLE TRAINER

THE MARK CONSISTS OF STANDARD CHARACTERS WITHOUT CLAIM TO ANY PARTICULAR FONT, STYLE, SIZE, OR COLOR.

FOR FITNESS GOODS AND EQUIPMENT, NAMELY, RESISTANCE BANDS AND CORDS THAT MAY BE WORN UNDERNEATH CLOTHING (U.S. CLS. 22, 23, 38 AND 50).

SHAUNIA WALLACE, EXAMINING ATTORNEY

SN 78-736,697. SMITH, DOUG, GROVELAND, IL. FILED 10-19-2005.

Big Dog Treestands

THE MARK CONSISTS OF STANDARD CHARACTERS WITHOUT CLAIM TO ANY PARTICULAR FONT, STYLE, SIZE, OR COLOR.

NO CLAIM IS MADE TO THE EXCLUSIVE RIGHT TO USE "TREESTANDS", APART FROM THE MARK AS SHOWN.

FOR CAMOUFLAGE NETTING USED IN HUNTING; FIELD BLINDS USED IN HUNTING; HUNTING ARROW POINTS; HUNTING BLINDS; HUNTING BOWS; HUNTING CAMOUFLAGE USED AS HUNTING BLINDS; HUNTING DECOY BAGS; HUNTING GAME CALLS; HUNTING STANDS; LURES FOR HUNTING; TREESTANDS FOR HUNTING; AND WATERFOWL HUNTING DECOYS (U.S. CLS. 22, 23, 38 AND 50).

FIRST USE 12-1-2005; IN COMMERCE 12-1-2005.

REBECCA GAN, EXAMINING ATTORNEY

SN 78-741,515. MATTEL, INC., EL SEGUNDO, CA. FILED 10-27-2005.

LZ CHOPPER

THE MARK CONSISTS OF STANDARD CHARACTERS WITHOUT CLAIM TO ANY PARTICULAR FONT, STYLE, SIZE, OR COLOR.

NO CLAIM IS MADE TO THE EXCLUSIVE RIGHT TO USE "CHOPPER", APART FROM THE MARK AS SHOWN.

FOR TOYS, GAMES AND PLAYTHINGS, NAMELY, TOY VEHICLES AND ACCESSORIES THEREFOR (U.S. CLS. 22, 23, 38 AND 50).

ANDREA EVANS, EXAMINING ATTORNEY

CLASS 28—(Continued).

SN 78-744,957. MATTEL, INC., EL SEGUNDO, CA. FILED 11-1-2005.

TAWNY

THE MARK CONSISTS OF STANDARD CHARACTERS WITHOUT CLAIM TO ANY PARTICULAR FONT, STYLE, SIZE, OR COLOR.

OWNER OF U.S. REG. NO. 1,544,621.
FOR TOYS, GAMES AND PLAYTHINGS, NAMELY, TOY ANIMAL FIGURES AND ACCESSORIES THEREFOR (U.S. CLS. 22, 23, 38 AND 50).

FIRST USE 9-14-2006; IN COMMERCE 9-14-2006.

TANYA AMOS, EXAMINING ATTORNEY

SN 78-766,162. CRAPPIEROCKET LLC, HILLSBORO, MO. FILED 12-4-2005.



NO CLAIM IS MADE TO THE EXCLUSIVE RIGHT TO USE "ORIGINAL" AND "CUSTOM MADE HYBRID JIGS", APART FROM THE MARK AS SHOWN.

THE NAME(S), PORTRAIT(S), AND/OR SIGNATURE(S) SHOWN IN THE MARK IDENTIFIES C. W. WILSON, WHOSE CONSENT(S) TO REGISTER IS SUBMITTED.

THE COLORS BLACK, WHITE, DARK BLUE, LIGHT BLUE, TURQUOISE, DARK GREEN, LIGHT GREEN, GRAY, RED, PINK, PURPLE, AND YELLOW ARE CLAIMED AS A FEATURE OF THE MARK.

THE MARK CONSISTS OF THE WORDING "C.W. WILSON'S ORIGINAL" IN BLACK CENTERED ABOVE THE WORDING "CRAPPIEROCKET" APPEARING IN MULTI-COLORED LETTERS AND THE WORDING "CUSTOM MADE HYBRID JIGS" APPEARING IN BLACK. THE LETTERS OF THE WORDING "CRAPPIEROCKET" ARE COLORED AS FOLLOWS: THE INITIAL "C" APPEARS IN RED AND PINK; THE "R" AND "A" APPEAR IN PURPLE; THE TWO "P'S" APPEAR IN PURPLE AND DARK BLUE; THE "IE" APPEARS IN LIGHT BLUE; THE "RO" APPEARS IN LIGHT GREEN; THE "C" APPEARS IN LIGHT GREEN AND YELLOW; THE "K" APPEARS IN YELLOW; THE "E" APPEARS IN YELLOW AND RED; AND THE FINAL "T" APPEARS IN RED. THE WORDING IS CONTAINED IN AN OVAL CARRIER HAVING A DARK BLUE BORDER, FILLED WITH LIGHT BLUE, GRAY AND WHITE. THE COLOR GRAY APPEARS AS SHADING AROUND THE SIDES OF THE CARRIER. TWO FISH FEATURING DARK GREEN, GRAY, AND WHITE COLORING AND A TURQUOISE OUTLINE APPEAR ON EITHER SIDE OF THE OVAL CARRIER. THE MARK'S BACKDROP CONSISTS OF A SNOW-COVERED MOUNTAIN SCENE COLORED IN WHITE WITH BLACK AND GRAY FORMING ROCKS AND SHADING. ABOVE THE MOUNTAIN IS A DARK BLUE SKY, AND A WHITE OUTLINE APPEARS ABOVE THE MOUNTAIN DESIGN.

FOR ARTIFICIAL FISHING LURES (U.S. CLS. 22, 23, 38 AND 50).

FIRST USE 11-7-2005; IN COMMERCE 11-7-2005.

DEBRA LEE, EXAMINING ATTORNEY

CLASS 28—(Continued).

SN 78-766,418. HUANG, CHIEN-WEN, TAINAN CITY, TAIWAN, FILED 12-5-2005.

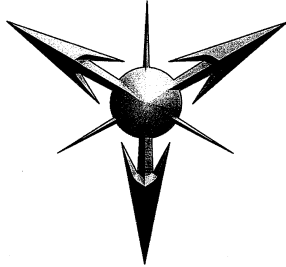

THE STIPPLING IS FOR SHADING PURPOSES ONLY. THE MARK CONSISTS OF A CONICAL CENTRALLY LOCATED CONTOUR HAVING THREE ARROW DESIGNS PASSING THERE THROUGH EQUIDISTANTLY LOCATED AROUND THE CENTRAL AXIS.

FOR PAINTBALL GUNS; PAINTBALL EQUIPMENT AND ACCESSORIES, NAMELY, PAINTBALLS, PAINTBALL FEED ADAPTORS, PAINTBALL MARKER BARRELS, PAINTBALL MARKER EXPANSION CHAMBERS, NON-TELESCOPIC PAINTBALL MARKER SIGHTS, PAINTBALL MARKER BARREL PLUGS, PAINTBALL FILLER ADAPTERS, PAINTBALL MARKERS, PAINTBALL CAPSULES, AND PAINTBALL LOADERS (U.S. CLS. 22, 23, 38 AND 50).

FIRST USE 11-9-2005; IN COMMERCE 11-9-2005.
JERI J. FICKES, EXAMINING ATTORNEY

SN 78-793,782. DON CLEMENTE, INC., RIVERSIDE, CA. FILED 1-18-2006.

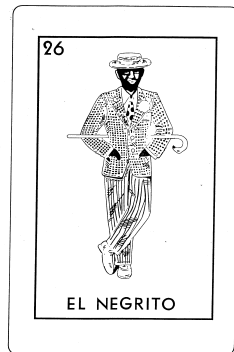

THE ENGLISH TRANSLATION OF THE SPANISH WORDING "EL NEGRITO" IS "THE BLACK MAN".

FOR BINGO CARDS; BINGO GAME PLAYING EQUIPMENT; EQUIPMENT SOLD AS A UNIT FOR PLAYING BINGO BOARD GAME; AND LOTTERY CARDS IN THE NATURE OF A BINGO-TYPE GAME (U.S. CLS. 22, 23, 38 AND 50).

FIRST USE 7-12-1912; IN COMMERCE 7-12-1912.
DAVID MILLER, EXAMINING ATTORNEY

CLASS 28—(Continued).

SN 78-815,446. THINKING TECHNOLOGY INC., NASSAU, BAHAMAS, FILED 2-15-2006.

iDANCER

THE MARK CONSISTS OF STANDARD CHARACTERS WITHOUT CLAIM TO ANY PARTICULAR FONT, STYLE, SIZE, OR COLOR.

FOR TOYS, NAMELY BATTERY OPERATED DOLLS, FIGURES, ANIMALS, CREATURES, STRUCTURES OR OBJECTS, FICTIONAL OR REAL, WHICH REACT TO EXTERNAL OR INTERNAL SOURCES OF SOUND, OR TO ELECTRONIC SIGNALS CORRESPONDING TO SOUND, TO GENERATE MOVEMENT, SOUND, LIGHT, OR COMBINATIONS OF THE ABOVE (U.S. CLS. 22, 23, 38 AND 50).

DAWN FELDMAN, EXAMINING ATTORNEY

SN 78-822,996. PURE FISHING, INC., SPIRIT LAKE, IA. FILED 2-24-2006.

NATURAL ATTRACTION

THE MARK CONSISTS OF STANDARD CHARACTERS WITHOUT CLAIM TO ANY PARTICULAR FONT, STYLE, SIZE, OR COLOR.

FOR SOFT ARTIFICIAL BAIT FOR FISHING (U.S. CLS. 22, 23, 38 AND 50).

BRENDAN REGAN, EXAMINING ATTORNEY

SN 78-822,999. PURE FISHING, INC., SPIRIT LAKE, IA. FILED 2-24-2006.

NATURAL ADVANTAGE

THE MARK CONSISTS OF STANDARD CHARACTERS WITHOUT CLAIM TO ANY PARTICULAR FONT, STYLE, SIZE, OR COLOR.

FOR SOFT ARTIFICIAL BAIT FOR FISHING (U.S. CLS. 22, 23, 38 AND 50).

BRENDAN REGAN, EXAMINING ATTORNEY

CLASS 28—(Continued).

SN 78-827,005. PURE FISHING, INC., SPIRIT LAKE, IA.
FILED 3-2-2006.

PRECISIONTECH

THE MARK CONSISTS OF STANDARD CHARACTERS
WITHOUT CLAIM TO ANY PARTICULAR FONT, STYLE,
SIZE, OR COLOR.

FOR FISHING RODS AND PRE-ASSEMBLED COMBI-
NATION FISHING ROD AND FISHING REEL (U.S. CLS.
22, 23, 38 AND 50).

BRENDAN REGAN, EXAMINING ATTORNEY

CLASS 28—(Continued).

SN 78-839,466. MARKO PRODUCTS, INC., CORONA, CA.
FILED 3-16-2006.

MARKO FOAM

THE MARK CONSISTS OF STANDARD CHARACTERS
WITHOUT CLAIM TO ANY PARTICULAR FONT, STYLE,
SIZE, OR COLOR.

NO CLAIM IS MADE TO THE EXCLUSIVE RIGHT TO
USE "FOAM", APART FROM THE MARK AS SHOWN.

FOR SURFBOARD BLANKS (U.S. CLS. 22, 23, 38 AND
50).

SHANNON TWOHIG, EXAMINING ATTORNEY

SN 78-831,747. MCDONIAL, ROBERT, OZARK, MO. FILED
3-7-2006.

SPORT SHORTZ

THE MARK CONSISTS OF STANDARD CHARACTERS
WITHOUT CLAIM TO ANY PARTICULAR FONT, STYLE,
SIZE, OR COLOR.

NO CLAIM IS MADE TO THE EXCLUSIVE RIGHT TO
USE "SPORT", APART FROM THE MARK AS SHOWN.

FOR PLUSH TOYS; TOY FIGURES (U.S. CLS. 22, 23, 38
AND 50).

FIRST USE 11-22-2005; IN COMMERCE 12-5-2005.

MEGAN WHITNEY, EXAMINING ATTORNEY

SN 78-840,241. HEADRICK, STEPHEN, CELINA, TN. FILED
3-17-2006.

PUNISHER LURES

THE MARK CONSISTS OF STANDARD CHARACTERS
WITHOUT CLAIM TO ANY PARTICULAR FONT, STYLE,
SIZE, OR COLOR.

NO CLAIM IS MADE TO THE EXCLUSIVE RIGHT TO
USE "LURES", APART FROM THE MARK AS SHOWN.

FOR ARTIFICIAL FISHING LURES (U.S. CLS. 22, 23,
38 AND 50).

FIRST USE 1-1-2004; IN COMMERCE 1-1-2004.

AMY MCMENAMIN, EXAMINING ATTORNEY

SN 78-839,430. MARKO PRODUCTS, INC., CORONA, CA.
FILED 3-16-2006.

EPOXY ARMY

THE MARK CONSISTS OF STANDARD CHARACTERS
WITHOUT CLAIM TO ANY PARTICULAR FONT, STYLE,
SIZE, OR COLOR.

NO CLAIM IS MADE TO THE EXCLUSIVE RIGHT TO
USE "EPOXY", APART FROM THE MARK AS SHOWN.

FOR SURFBOARD BLANKS (U.S. CLS. 22, 23, 38 AND
50).

SHANNON TWOHIG, EXAMINING ATTORNEY

SN 78-840,273. HEADRICK, STEPHEN, CELINA, TN. FILED
3-17-2006.

FISH DOPE

THE MARK CONSISTS OF STANDARD CHARACTERS
WITHOUT CLAIM TO ANY PARTICULAR FONT, STYLE,
SIZE, OR COLOR.

NO CLAIM IS MADE TO THE EXCLUSIVE RIGHT TO
USE "FISH", APART FROM THE MARK AS SHOWN.

FOR ARTIFICIAL FISHING LURES (U.S. CLS. 22, 23,
38 AND 50).

FIRST USE 3-4-2002; IN COMMERCE 3-4-2002.

AMY MCMENAMIN, EXAMINING ATTORNEY

CLASS 28—(Continued).

SN 78-844,235. ROUTZONG, JAMES E, GLOUCESTER, MA. FILED 3-23-2006.

DON'T TIP THE WAITER

THE MARK CONSISTS OF STANDARD CHARACTERS WITHOUT CLAIM TO ANY PARTICULAR FONT, STYLE, SIZE, OR COLOR.

FOR BOARD GAMES; ACTION SKILL GAMES (U.S. CLS. 22, 23, 38 AND 50).

CHRISTINE COOPER, EXAMINING ATTORNEY

CLASS 28—(Continued).

SN 78-846,663. TEAM EFFORT, INC., CLARION, IA. FILED 3-27-2006.

THE 19° DIFFERENCE

THE MARK CONSISTS OF STANDARD CHARACTERS WITHOUT CLAIM TO ANY PARTICULAR FONT, STYLE, SIZE, OR COLOR.

NO CLAIM IS MADE TO THE EXCLUSIVE RIGHT TO USE "19", APART FROM THE MARK AS SHOWN.

FOR GOLF DIVOT REPAIR TOOLS (U.S. CLS. 22, 23, 38 AND 50).

KATHERINE STOIDES, EXAMINING ATTORNEY

SN 78-845,266. TRI-BAG LIMITED, BEDFORDSHIRE, UNITED KINGDOM, FILED 3-24-2006.



FOR GOLF BAGS; GOLF BAGS WITH OR WITHOUT WHEELS; BAG STANDS FOR GOLF BAGS; CADDIE BAGS FOR GOLF CLUBS; GOLF CLUB BAGS; GOLF TEE BAGS; STANDS FOR GOLF BAGS; TROLLEY BAGS FOR GOLF EQUIPMENT; PARTS AND FITTINGS FOR ALL THE AFORESAID GOODS (U.S. CLS. 22, 23, 38 AND 50).

KELLY MCCOY, EXAMINING ATTORNEY

SN 78-850,139. BERNSTEIN, BRETT, M, PHILADELPHIA, PA. FILED 3-30-2006.



NO CLAIM IS MADE TO THE EXCLUSIVE RIGHT TO USE "PAPER MINIS", APART FROM THE MARK AS SHOWN.

THE APPLICANT CLAIMS COLOR AS A FEATURE OF THE MARK, NAMELY, DARK BLUE, BEIGE, WHITE.

THE MARK CONSISTS OF THE WORD DISPOSABLE IS WHITE WITH A DARK BLUE OUTLINE, THE WORD HEROES IS DARK BLUE. BOTH WORDS LIE WITHIN A DARK BLUE BORDER WITH A BEIGE BACKGROUND. THE WORDS PAPER MINIS ARE WHITE AND LIE ON A DARK BLUE BACKGROUND THAT IS PART OF THE BORDER.

FOR BOARD GAMES; ROLE PLAYING GAMES (U.S. CLS. 22, 23, 38 AND 50).

FIRST USE 1-26-2002; IN COMMERCE 1-26-2002.

DARRYL SPRUILL, EXAMINING ATTORNEY

SN 78-846,366. KELLY, DAVID F., KINGWOOD, TX. FILED 3-26-2006.

SUPER-TAC

THE MARK CONSISTS OF STANDARD CHARACTERS WITHOUT CLAIM TO ANY PARTICULAR FONT, STYLE, SIZE, OR COLOR.

FOR HANDLES FOR GOLF CLUBS (U.S. CLS. 22, 23, 38 AND 50).

DEZMONA MIZELLE, EXAMINING ATTORNEY

SN 78-850,370. B45 INCORPORATED, QUÉBEC, CANADA, FILED 3-30-2006.

B45

THE MARK CONSISTS OF STANDARD CHARACTERS WITHOUT CLAIM TO ANY PARTICULAR FONT, STYLE, SIZE, OR COLOR.

FOR BASEBALL BATS (U.S. CLS. 22, 23, 38 AND 50).

FIRST USE 3-11-2004; IN COMMERCE 5-28-2004.

TRAVIS WHEATLEY, EXAMINING ATTORNEY

CLASS 28—(Continued).

SN 78-851,084. WHITLEY, THAD, LAKE ELSINORE, CA.
FILED 3-31-2006.

GAME TEETH

THE MARK CONSISTS OF STANDARD CHARACTERS WITHOUT CLAIM TO ANY PARTICULAR FONT, STYLE, SIZE, OR COLOR.

NO CLAIM IS MADE TO THE EXCLUSIVE RIGHT TO USE "TEETH", APART FROM THE MARK AS SHOWN.
FOR NOVELTY TEETH (U.S. CLS. 22, 23, 38 AND 50).
TRAVIS WHEATLEY, EXAMINING ATTORNEY

SN 78-851,909. CHEN, HSIU CHI, CALIMESA, CA. FILED 4-1-2006.



The logo for XJET features a large, bold, black 'X' followed by the word 'JET' in a bold, italicized, black sans-serif font.

FOR BADMINTON RACKET STRINGS; BADMINTON RACKETS; BADMINTON SHUTTLECOCKS; RACKET GRIP TAPE; TENNIS RACKET COVERS; TENNIS RACKET STRINGS; TENNIS RACQUETS (U.S. CLS. 22, 23, 38 AND 50).

FIRST USE 7-15-2005; IN COMMERCE 7-15-2005.
JAY BESCH, EXAMINING ATTORNEY

SN 78-851,991. BELLON, RICHARD LEE, CARLSBAD, CA.
AND BELLON, MICHAEL LEE, CARLSBAD, CA. FILED 4-1-2006.

ACTION SPORTS PARKS & TOYS

THE MARK CONSISTS OF STANDARD CHARACTERS WITHOUT CLAIM TO ANY PARTICULAR FONT, STYLE, SIZE, OR COLOR.

NO CLAIM IS MADE TO THE EXCLUSIVE RIGHT TO USE "TOYS", APART FROM THE MARK AS SHOWN.

FOR BENDABLE TOYS; CASES FOR TOY STRUCTURES; CASES FOR TOY VEHICLES; ELECTRIC ACTION TOYS; ELECTRONICALLY OPERATED TOY MOTOR VEHICLES; FANTASY CHARACTER TOYS; LEVER ACTION TOYS; MECHANICAL ACTION TOYS; MECHANICAL TOYS; MOLDED TOY FIGURES; TOY ACTION FIGURES; TOY ACTION FIGURES AND ACCESSORIES THEREFOR; TOY AIRPLANES; TOY ANIMALS AND ACCESSORIES THEREFORE; TOY ARMOR; TOY BOXES; TOY FIGURES; TOY FURNITURE; TOY HOUSES; TOY MODEL CARS; TOY MODEL VEHICLES AND RELATED ACCESSORIES SOLD AS UNITS; TOY VEHICLES; TOY VEHICLES AND ACCESSORIES THEREFOR (U.S. CLS. 22, 23, 38 AND 50).

HENRY S. ZAK, EXAMINING ATTORNEY

CLASS 28—(Continued).

SN 78-854,435. OPPEN, KARL, GRANADA HILLS, CA.
FILED 4-5-2006.

TREE BLOCKS

THE MARK CONSISTS OF STANDARD CHARACTERS WITHOUT CLAIM TO ANY PARTICULAR FONT, STYLE, SIZE, OR COLOR.

NO CLAIM IS MADE TO THE EXCLUSIVE RIGHT TO USE "BLOCKS", APART FROM THE MARK AS SHOWN.

FOR DOLL FURNITURE; DOLL HOUSE FURNISHINGS; DOLL HOUSES; DOLLS; PLAY WANDS; PLAY-GROUND BALLS; TOY BUILDING BLOCKS (U.S. CLS. 22, 23, 38 AND 50).

FIRST USE 1-7-1996; IN COMMERCE 3-25-1996.

MATTHEW MCDOWELL, EXAMINING ATTORNEY

SN 78-855,833. FREESWIM POOLS, INC., GEORGETOWN, TX. FILED 4-6-2006.



NO CLAIM IS MADE TO THE EXCLUSIVE RIGHT TO USE "POOLS", APART FROM THE MARK AS SHOWN.

THE COLOR(S) BLUE AND WHITE IS/ARE CLAIMED AS A FEATURE OF THE MARK.

THE MARK CONSISTS OF BLUE CIRCLES OF ASCENDING SIZE FORMING AN ARC OVER THE TERM "INFINITE" WHICH IS IN WHITE LETTERS OUTLINED IN BLUE; THE TERM "POOLS" IS ALSO IN WHITE LETTERS OUTLINED IN BLUE AND IS POSITIONED IN THE LARGEST CIRCLE.

FOR SWIMMING MACHINE USED FOR EXERCISE, THERAPY, REHABILITATION AND RECREATION (U.S. CLS. 22, 23, 38 AND 50).

FIRST USE 7-1-2004; IN COMMERCE 7-9-2004.

CAROLYN CATALDO, EXAMINING ATTORNEY

SN 78-856,725. SOUTHERN HENS, INC., MOSELLE, MS.
FILED 4-7-2006.

Bayou Bait

THE MARK CONSISTS OF STANDARD CHARACTERS WITHOUT CLAIM TO ANY PARTICULAR FONT, STYLE, SIZE, OR COLOR.

NO CLAIM IS MADE TO THE EXCLUSIVE RIGHT TO USE "BAIT", APART FROM THE MARK AS SHOWN.

FOR PACKAGED FREEZE-DRIED FISHING BAIT (U.S. CLS. 22, 23, 38 AND 50).

ELIZABETH HUGHITT, EXAMINING ATTORNEY

CLASS 28—(Continued).

SN 78-857,262. WEST, LINDSAY LOUISE, ATHENS, GA. FILED 4-8-2006.

THUMBODY

THE MARK CONSISTS OF STANDARD CHARACTERS WITHOUT CLAIM TO ANY PARTICULAR FONT, STYLE, SIZE, OR COLOR.

FOR COLLECTIBLE CHARACTER FIGURES MADE OF VINYL (U.S. CLS. 22, 23, 38 AND 50).

MARLENE BELL, EXAMINING ATTORNEY

SN 78-857,744. DUFFTY, KEANAN, NEW YORK, NY. FILED 4-10-2006.

KEANAN DUFFTY

THE MARK CONSISTS OF STANDARD CHARACTERS WITHOUT CLAIM TO ANY PARTICULAR FONT, STYLE, SIZE, OR COLOR.

THE NAME(S), PORTRAIT(S), AND/OR SIGNATURE(S) SHOWN IN THE MARK IDENTIFIES A LIVING INDIVIDUAL, WHOSE CONSENT(S) TO REGISTER IS SUBMITTED.

FOR TOYS AND PLAYTHINGS, NAMELY, PLAYING CARDS, PLAY FIGURES, TOY FIGURES, POSITIONABLE TOY FIGURES, BOBBLE HEAD TOY FIGURES, BOBBLE HEAD ACTION FIGURES, ACTION FIGURES AND ACCESSORIES THEREFOR, PLAYSETS FOR ACTION FIGURES, TOY ACTION FIGURES, TOY ACTION FIGURES AND ACCESSORIES THEREFOR, MODELED PLASTIC TOY FIGURINES, PLASTIC CHARACTER TOYS, RUBBER CHARACTER TOYS, CASES FOR ACTION FIGURES, ELECTRIC AND MECHANICAL ACTION TOYS, MECHANICAL TOYS, BATTERY OPERATED ACTION TOYS, AERODYNAMIC FLYING DISCS FOR PLAYING TOSSTYPE GAMES, WIND-UP WALKING TOYS, BENDABLE TOYS, PUNCHING TOYS, COLLECTABLE TOY FIGURES, ELECTRIC ACTION TOYS, FANTASY CHARACTER TOYS, CONSTRUCTION TOYS, ELECTRONICALLY OPERATED TOY MOTOR VEHICLES, INFLATABLE TOYS, PLUSH TOYS, SOFT SCULPTURE PLUSH TOYS, SOFT SCULPTURE TOYS, SQUEEZABLE SQUEAKING TOYS, SQUEEZE TOYS, POP UP TOYS, MUSICAL TOYS, MUSIC BOX TOYS, PRINTING TOYS, PULL TOYS, PUSH TOYS, RIDE-ON TOYS, SAND TOYS, SANDBOX TOYS, BATH TOYS, SKETCHING TOYS, PARTY FAVORS IN THE NATURE OF SMALL TOYS AND NOISEMAKERS, CASES FOR TOY STRUCTURES, CASES FOR TOY VEHICLES, TOY BANKS, TOY BOXES, STUFFED TOYS, STUFFED TOY ANIMALS, TEDDY BEARS, DOLLS AND ACCESSORIES THEREFOR, DOLLS AND PLAYSETS THEREFOR, DOLL COSTUMES, DOLL CLOTHING, DOLL CASES, DOLL HOUSES, DOLL FURNITURE, DOLL HOUSE FURNISHINGS, PUPPETS, BALLOONS, ACTION SKILL GAMES, BOARD GAMES, PARLOR GAMES, BACKGAMMON GAME SETS, POKER CHIPS, PUZZLES, JIGSAW PUZZLES, MANIPULATIVE AND CUBE PUZZLES, MANIPULATIVE GAMES, CARD GAMES, KITES, KITE STRING, KITE TAILS, KITE REELS, KITE LINES, KITE HANDLES, KITE PARTS, BEAN BAGS, DICE AND YO-YOS; INFLATABLE MATTRESSES FOR RECREATIONAL USE; INFLATABLE INNER TUBES FOR AQUATIC RECREATIONAL USE; FLOATING RECREATIONAL LOUNGE CHAIRS AND SWIM FLOATS FOR RECREATIONAL USE; INFLATABLE

CLASS 28—(Continued).

POOL TOYS AND INFLATABLE SWIMMING POOLS; WATER SKIS, SKATEBOARDS, INLINE SKATES AND TOY SCOOTERS; TOY WEAPONS, TOY BELTS, WATER SQUIRTING TOYS, TOY WRESTLING GEAR SETS AND TOY WRESTLING RINGS; BASKETBALL TABLE TOP GAMES, PADDLE BALL GAMES, BINGO GAME PLAYING EQUIPMENT, GAME EQUIPMENT IN THE NATURE OF CHIPS, BILLIARD BALLS, CUES AND CUE HOLDERS; BILLIARD GAME PLAYING EQUIPMENT; BILLIARD TABLES; BOWLING BALLS, AND ACCESSORIES THEREFOR, NAMELY, BOWLING BAGS, GLOVES AND PINS; SPORTING GOODS, NAMELY, BEACH BALLS, BASKETBALLS, BASEBALLS, SOFTBALLS, SPORT BALLS, BASEBALL AND SOFTBALL BATS, GOLF CLUBS, GOLF CLUB SHAFTS, GOLF IRONS, GOLF PUTTERS, GOLF CLUB HEADS, GOLF CLUB INSERTS, GOLF BALLS, GOLF BALL SLEEVES, GOLF ACCESSORY POUCHES, GOLF BAGS, GOLF PUTTER COVERS, HEAD COVERS FOR GOLF CLUBS, GOLF BAG MARKERS, GOLF BAG PEGS, GOLF BAG COVERS, GOLF BAG TAGS, GOLF GLOVES, GOLF BALL RETRIEVERS, GOLF FLAGS, GOLF TEES, GOLF TEE MARKERS, GOLF TOWEL CLIPS FOR ATTACHMENT TO GOLF BAGS, NON-MOTORIZED GOLF CARTS, ATHLETIC SUPPORTERS, ATHLETIC TAPE, SHOULDER PAD ELASTIC FOR ATHLETIC USE, SHOULDER PAD LACES AND LACELOCKS FOR ATHLETIC USE, THROAT PROTECTORS FOR ATHLETIC USE, ELBOW GUARDS AND PADS FOR ATHLETIC USE, HAND PADS FOR ATHLETIC USE, KNEE GUARDS AND PADS FOR ATHLETIC USE, LEG GUARDS AND WEIGHTS FOR ATHLETIC USE, HAND PADS FOR ATHLETIC USE, KNEE GUARDS AND PADS FOR ATHLETIC USE, LEG GUARDS AND WEIGHTS FOR ATHLETIC USE, SHIN GUARDS AND PADS FOR ATHLETIC USE; BARBELLS AND DUMBBELLS; ARCADE GAMES, NON-ELECTRONIC PINBALL GAMES AND GAMING TABLES; HAND HELD UNIT FOR PLAYING VIDEO GAMES AND ACCESSORIES THEREFOR, HAND HELD UNIT FOR PLAYING ELECTRONIC GAMES AND COIN-OPERATED VIDEO GAMES; HAND-HELD LCD GAME MACHINES AND HAND HELD ACTION SKILL GAMES; STAND ALONE VIDEO OUTPUT GAME MACHINES; STAND ALONE VIDEO GAME MACHINES; COIN-OPERATED VIDEO GAMES; ELECTRONIC EDUCATIONAL GAME MACHINES FOR CHILDREN; EQUIPMENT SOLD AS A UNIT FOR PLAYING BOARD GAMES, CARD GAMES, MEMORY GAMES, AND ACTION-TYPE TARGET GAMES; AUDIO AND VIDEO TOY PROJECTORS AND ACCESSORIES THEREFOR; CHRISTMAS TREE ACCESSORIES, NAMELY, ORNAMENTS, STOCKINGS, TREE SKIRTS, TINSEL, BELLS, NON-ILLUMINATING AND NON-ELECTRIC TREE DECORATIONS; CHILDREN'S PLAY COSMETICS; FACE MASKS; TOY WATCHES, TOY SNOW GLOBES, TOY MUSICAL INSTRUMENTS, AND TOY PEDAL CARS; TOY GUM MAKERS AND TOY BUBBLE GUM DISPENSERS; TOY CANDY DISPENSERS AND HOLDERS; TOY MODEL HOBBY CRAFT KITS; TOY MODEL VEHICLES AND RELATED ACCESSORIES THEREFOR SOLD AS UNITS; TOY MODELING COMPOUND AND ACCESSORIES THEREFOR; PROMOTIONAL GAME MATERIALS AND GAME CARDS; ROLE PLAYING GAMES AND ROLE PLAYING GAME EQUIPMENT SOLD AS A UNIT; TOY IN THE NATURE OF A BATTERY-POWERED COMPUTER GAME WITH LCD SCREEN WHICH FEATURES ANIMATION AND SOUND EFFECTS (U.S. CLS. 22, 23, 38 AND 50).

JENNIFER KRISP, EXAMINING ATTORNEY

CLASS 28—(Continued).

SN 78-858,387. KING, JASON HARVEY, SHADY SIDE, MD.
FILED 4-11-2006.

ScrollQuest

THE MARK CONSISTS OF STANDARD CHARACTERS
WITHOUT CLAIM TO ANY PARTICULAR FONT, STYLE,
SIZE, OR COLOR.
FOR PUZZLES (U.S. CLS. 22, 23, 38 AND 50).
MICHELE SWAIN, EXAMINING ATTORNEY

CLASS 28—(Continued).

SN 78-859,736. GLOBAL VR INC., SAN JOSE, CA. FILED 4-12-
2006.

Prize Monster

THE MARK CONSISTS OF STANDARD CHARACTERS
WITHOUT CLAIM TO ANY PARTICULAR FONT, STYLE,
SIZE, OR COLOR.
FOR COIN-OPERATED VIDEO GAMES (U.S. CLS. 22,
23, 38 AND 50).
ELLEN BURNS, EXAMINING ATTORNEY

SN 78-858,491. PATCH PRODUCTS, INC., BELOIT, WI.
FILED 4-11-2006.

SHAKEDOWN

THE MARK CONSISTS OF STANDARD CHARACTERS
WITHOUT CLAIM TO ANY PARTICULAR FONT, STYLE,
SIZE, OR COLOR.
FOR PARLOR GAME (U.S. CLS. 22, 23, 38 AND 50).
MARILYN IZZI, EXAMINING ATTORNEY

SN 78-859,499. PURE FISHING, INC., SPIRIT LAKE, IA.
FILED 4-12-2006.

SEA DOUGH

THE MARK CONSISTS OF STANDARD CHARACTERS
WITHOUT CLAIM TO ANY PARTICULAR FONT, STYLE,
SIZE, OR COLOR.
NO CLAIM IS MADE TO THE EXCLUSIVE RIGHT TO
USE "DOUGH", APART FROM THE MARK AS SHOWN.
FOR ARTIFICIAL SOFT FISHING BAIT (U.S. CLS. 22,
23, 38 AND 50).
FIRST USE 3-1-2005; IN COMMERCE 6-1-2005.
BRENDAN REGAN, EXAMINING ATTORNEY

SN 78-860,005. TIDELINE INTERNATIONAL COMPANY,
PORTLAND, OR. FILED 4-12-2006.

REBOUNDER BALL

THE MARK CONSISTS OF STANDARD CHARACTERS
WITHOUT CLAIM TO ANY PARTICULAR FONT, STYLE,
SIZE, OR COLOR.
NO CLAIM IS MADE TO THE EXCLUSIVE RIGHT TO
USE "BALL", APART FROM THE MARK AS SHOWN.
FOR BALLS, NAMELY, BASEBALLS, SOFTBALLS,
AND CRICKET BALLS FABRICATED OF RESILIENT
MATERIAL (U.S. CLS. 22, 23, 38 AND 50).
JENNIFER VASQUEZ, EXAMINING ATTORNEY

SN 78-860,635. SMITH, ANTRON, PLYMOUTH, MA. FILED
4-13-2006.

SAGGIN

THE MARK CONSISTS OF STANDARD CHARACTERS
WITHOUT CLAIM TO ANY PARTICULAR FONT, STYLE,
SIZE, OR COLOR.
FOR BAGS SPECIALLY ADAPTED FOR SPORTS
EQUIPMENT; BOARDS USED IN THE PRACTICE OF
WATER SPORTS; SNOW BOARDS; WEIGHT LIFTING
BELTS (U.S. CLS. 22, 23, 38 AND 50).
SEAN CROWLEY, EXAMINING ATTORNEY

CLASS 28—(Continued).

SN 78-860,713. HOBBY LOBBY INTERNATIONAL, INC., BRENTWOOD, TN. FILED 4-13-2006.

SENIOR TELEMASTER

THE MARK CONSISTS OF STANDARD CHARACTERS WITHOUT CLAIM TO ANY PARTICULAR FONT, STYLE, SIZE, OR COLOR.

OWNER OF U.S. REG. NO. 1,477,891.
FOR MINIATURE AIRPLANE KIT AND RELATED ACCESSORIES SOLD AS UNITS (U.S. CLS. 22, 23, 38 AND 50).

FIRST USE 3-30-1973; IN COMMERCE 3-30-1973.
YONG KIM, EXAMINING ATTORNEY

SN 78-860,719. HOBBY LOBBY INTERNATIONAL, INC., BRENTWOOD, TN. FILED 4-13-2006.

MINI TELEMASTER

THE MARK CONSISTS OF STANDARD CHARACTERS WITHOUT CLAIM TO ANY PARTICULAR FONT, STYLE, SIZE, OR COLOR.

OWNER OF U.S. REG. NO. 1,477,891.
NO CLAIM IS MADE TO THE EXCLUSIVE RIGHT TO USE "MINI", APART FROM THE MARK AS SHOWN.
FOR MINIATURE AIRPLANE KIT AND RELATED ACCESSORIES SOLD AS UNITS (U.S. CLS. 22, 23, 38 AND 50).

FIRST USE 8-7-2003; IN COMMERCE 8-7-2003.
YONG KIM, EXAMINING ATTORNEY

SN 78-860,724. HOBBY LOBBY INTERNATIONAL, INC., BRENTWOOD, TN. FILED 4-13-2006.

TELEMASTER ELECTRO

THE MARK CONSISTS OF STANDARD CHARACTERS WITHOUT CLAIM TO ANY PARTICULAR FONT, STYLE, SIZE, OR COLOR.

OWNER OF U.S. REG. NO. 1,477,891.
FOR MINIATURE AIRPLANE AND RELATED ACCESSORIES SOLD AS UNITS AND REQUIRING FEW STEPS FOR ASSEMBLY (U.S. CLS. 22, 23, 38 AND 50).
FIRST USE 2-2-2006; IN COMMERCE 2-2-2006.
YONG KIM, EXAMINING ATTORNEY

CLASS 28—(Continued).

SN 78-860,726. HOBBY LOBBY INTERNATIONAL, INC., BRENTWOOD, TN. FILED 4-13-2006.

TELEMASTER 40

THE MARK CONSISTS OF STANDARD CHARACTERS WITHOUT CLAIM TO ANY PARTICULAR FONT, STYLE, SIZE, OR COLOR.

OWNER OF U.S. REG. NO. 1,477,891.
NO CLAIM IS MADE TO THE EXCLUSIVE RIGHT TO USE "40", APART FROM THE MARK AS SHOWN.

FOR MINIATURE AIRPLANE KIT AND RELATED ACCESSORIES SOLD AS UNITS (U.S. CLS. 22, 23, 38 AND 50).

FIRST USE 1-1-1983; IN COMMERCE 1-1-1983.
YONG KIM, EXAMINING ATTORNEY

SN 78-861,842. CARPENTER, DALE, GILBERT, AZ. FILED 4-14-2006.

CUSTOM PRODUCTS

THE MARK CONSISTS OF STANDARD CHARACTERS WITHOUT CLAIM TO ANY PARTICULAR FONT, STYLE, SIZE, OR COLOR.

OWNER OF U.S. REG. NO. 2,994,162.
NO CLAIM IS MADE TO THE EXCLUSIVE RIGHT TO USE "PRODUCTS", APART FROM THE MARK AS SHOWN.
SEC. 2(F).

FOR PAINTBALL MARKER ACCESSORIES, NAMELY, TWIST LOCK FEED NECKS, FEED NECKS, THREADED CAPS, DUST CAPS, AIR SYSTEM ADAPTERS ("ASA"), PRESSURE GAUGES, POD PACKS, PODS, RAILS, ADAPTERS, TRIGGERS, DIRECT MOUNT ASA, SNATCH GRIPS, BUTTONS, KNOBS, ADJUSTABLE CAPS, FILL NIPPLES, COLLET SLEEVES, CONTROL BORES, BARREL KITS, BARREL SAFETY DEVICES, BARREL STORAGE BAGS (U.S. CLS. 22, 23, 38 AND 50).

FIRST USE 7-1-1999; IN COMMERCE 7-1-1999.
MARILYN IZZI, EXAMINING ATTORNEY

SN 78-861,965. VIEJAS BAND OF KUMEYAAY INDIANS, ALPINE, CA. FILED 4-14-2006.

NIGHTFIRE

THE MARK CONSISTS OF STANDARD CHARACTERS WITHOUT CLAIM TO ANY PARTICULAR FONT, STYLE, SIZE, OR COLOR.

FOR ACTION FIGURES; PLUSH TOYS (U.S. CLS. 22, 23, 38 AND 50).

KATHERINE CONNOLLY, EXAMINING ATTORNEY

CLASS 28—(Continued).

SN 78-862,064. BENKERT, JONAH, SAN FRANCISCO, CA.
FILED 4-14-2006.

COMPWALL

THE MARK CONSISTS OF STANDARD CHARACTERS
WITHOUT CLAIM TO ANY PARTICULAR FONT, STYLE,
SIZE, OR COLOR.

FOR ARTIFICIAL CLIMBING WALLS (U.S. CLS. 22,
23, 38 AND 50).

FIRST USE 12-1-1994; IN COMMERCE 12-1-1994.
PAUL E. FAHRENKOPF, EXAMINING ATTORNEY

SN 78-862,135. DAVIS JILES, LLC, BENTONVILLE, AR.
FILED 4-14-2006.

Reel Rides

THE MARK CONSISTS OF STANDARD CHARACTERS
WITHOUT CLAIM TO ANY PARTICULAR FONT, STYLE,
SIZE, OR COLOR.

NO CLAIM IS MADE TO THE EXCLUSIVE RIGHT TO
USE "RIDES", APART FROM THE MARK AS SHOWN.

FOR TOY MODEL CARS (U.S. CLS. 22, 23, 38 AND 50).
IRA J. GOODSaid, EXAMINING ATTORNEY

SN 78-862,228. TRIBUTE SKATEBOARDS LLC, PORTLAND,
OR. FILED 4-14-2006.

TRIBUTE

THE MARK CONSISTS OF STANDARD CHARACTERS
WITHOUT CLAIM TO ANY PARTICULAR FONT, STYLE,
SIZE, OR COLOR.

FOR SKATEBOARD DECKS, SKATEBOARD WHEELS;
ACCESSORIES FOR SKATEBOARDS, NAMELY, BALL
BEARINGS FOR SKATEBOARDS AND NUTS AND
BOLTS FOR SKATEBOARDS (U.S. CLS. 22, 23, 38 AND
50).

TANYA AMOS, EXAMINING ATTORNEY

CLASS 28—(Continued).

SN 78-862,445. CORNETT, ROBERT D, WORTHINGTON,
OH. FILED 4-17-2006.

BOOBER BOBBERS

THE MARK CONSISTS OF STANDARD CHARACTERS
WITHOUT CLAIM TO ANY PARTICULAR FONT, STYLE,
SIZE, OR COLOR.

NO CLAIM IS MADE TO THE EXCLUSIVE RIGHT TO
USE "BOBBERS", APART FROM THE MARK AS SHOWN.
FOR FISHING FLOAT (U.S. CLS. 22, 23, 38 AND 50).

FIRST USE 7-1-2005; IN COMMERCE 1-12-2006.
MICHAEL LEWIS, EXAMINING ATTORNEY

SN 78-862,500. TOWNSEND III, MARVIN A., CHESAPEAKE,
VA. FILED 4-17-2006.



NO CLAIM IS MADE TO THE EXCLUSIVE RIGHT TO
USE "HITTING DISC", APART FROM THE MARK AS
SHOWN.

THE NAME TOWNY TOWNSEND IDENTIFIES A LIVING
INDIVIDUAL WHOSE CONSENT IS OF RECORD.

THE MARK CONSISTS OF A CIRCLE WITH THE
WORDING TOWNY TOWNSEND ALONG THE INNER
TOP OF THE CIRCLE AND THE WORDING HITTING DISC
ALONG THE INNER BOTTOM OF THE CIRCLE. A
STYLIZED MAN SWINGING A BAT APPEARS IN THE
CENTER.

FOR BASEBALL TRAINING APPARATUS, NAMELY
HITTING TRAINING DEVICES (U.S. CLS. 22, 23, 38 AND
50).

SANDRA MANIOS, EXAMINING ATTORNEY

CLASS 28—(Continued).

SN 78-862,599. COBRA GOLF INCORPORATED, CARLSBAD, CA. FILED 4-17-2006.

5900 IL

THE MARK CONSISTS OF STANDARD CHARACTERS WITHOUT CLAIM TO ANY PARTICULAR FONT, STYLE, SIZE, OR COLOR.

FOR GOLF EQUIPMENT, NAMELY, GOLF CLUBS (U.S. CLS. 22, 23, 38 AND 50).

MEGAN WHITNEY, EXAMINING ATTORNEY

CLASS 28—(Continued).

SN 78-862,772. TIDELINE INTERNATIONAL COMPANY, PORTLAND, OR. FILED 4-17-2006.

THE REBOUNDER

THE MARK CONSISTS OF STANDARD CHARACTERS WITHOUT CLAIM TO ANY PARTICULAR FONT, STYLE, SIZE, OR COLOR.

FOR BALLS, NAMELY, BASEBALLS, SOFTBALLS, AND CRICKET BALLS FABRICATED OF RESILIENT MATERIAL (U.S. CLS. 22, 23, 38 AND 50).

JENNIFER VASQUEZ, EXAMINING ATTORNEY

SN 78-862,766. COBRA GOLF INCORPORATED, CARLSBAD, CA. FILED 4-17-2006.

5900

THE MARK CONSISTS OF STANDARD CHARACTERS WITHOUT CLAIM TO ANY PARTICULAR FONT, STYLE, SIZE, OR COLOR.

FOR GOLF EQUIPMENT, NAMELY, GOLF CLUBS (U.S. CLS. 22, 23, 38 AND 50).

MEGAN WHITNEY, EXAMINING ATTORNEY

SN 78-863,488. RAND INTERNATIONAL, INC., FARMINGDALE, NY. FILED 4-18-2006.

FEARSOME UGLIES

THE MARK CONSISTS OF STANDARD CHARACTERS WITHOUT CLAIM TO ANY PARTICULAR FONT, STYLE, SIZE, OR COLOR.

FOR PLASTIC TOYS, NAMELY HUMAN BODY PARTS AND TOY ANIMALS, NAMELY, MONSTERS, INSECTS, BUGS, LIZARDS, WATER ANIMALS AND SNAKES (U.S. CLS. 22, 23, 38 AND 50).

KELLY BOULTON, EXAMINING ATTORNEY

SN 78-862,771. COBRA GOLF INCORPORATED, CARLSBAD, CA. FILED 4-17-2006.

6000

THE MARK CONSISTS OF STANDARD CHARACTERS WITHOUT CLAIM TO ANY PARTICULAR FONT, STYLE, SIZE, OR COLOR.

FOR GOLF EQUIPMENT, NAMELY, GOLF CLUBS (U.S. CLS. 22, 23, 38 AND 50).

MEGAN WHITNEY, EXAMINING ATTORNEY

SN 78-864,032. FERGUSON, ROB, MCHENRY, IL. FILED 4-18-2006.

EZ-LATS PLUS

THE MARK CONSISTS OF STANDARD CHARACTERS WITHOUT CLAIM TO ANY PARTICULAR FONT, STYLE, SIZE, OR COLOR.

FOR MANUALLY-OPERATED EXERCISE EQUIPMENT (U.S. CLS. 22, 23, 38 AND 50).

LEIGH LOWRY, EXAMINING ATTORNEY

CLASS 28—(Continued).

SN 78-864,204. OVERFIELD, MATTHEW, C, BUFFALO, NY.
FILED 4-18-2006.

Chewker

THE MARK CONSISTS OF STANDARD CHARACTERS WITHOUT CLAIM TO ANY PARTICULAR FONT, STYLE, SIZE, OR COLOR.

FOR BOARD GAMES (U.S. CLS. 22, 23, 38 AND 50).
KENNETH E. SHARPERSON, EXAMINING ATTORNEY

SN 78-864,287. TAKAYAMA, DONALD, CARLSBAD, CA.
AND TAKAYAMA, DIANE, CARLSBAD, CA. FILED 4-18-2006.

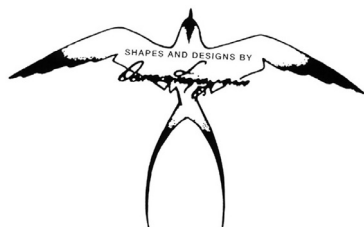

NO CLAIM IS MADE TO THE EXCLUSIVE RIGHT TO USE "SHAPES AND DESIGNS BY", APART FROM THE MARK AS SHOWN.

THE MARK CONSISTS OF A LINE DRAWING OF A FRIGATE BIRD WITH OUTSTREACHED WINGS AND LONG FORKED TAIL. THE WORDS "SHAPES AND DESIGNS BY" ARE SUPERIMPOSED ON THE BIRDS BACK ALONG WITH THE SIGNATURE OF DONALD TAKAYAMA.

FOR SKATEBOARDS; SURFBOARD FINS; SURFBOARDS (U.S. CLS. 22, 23, 38 AND 50).

FIRST USE 6-0-1976; IN COMMERCE 6-0-1976.
KRISTINA KLOIBER, EXAMINING ATTORNEY

SN 78-865,156. PANCIL, LLC, LA JOLLA, CA. FILED 4-19-2006.

Where Children Have Fun Learning To Read

THE MARK CONSISTS OF STANDARD CHARACTERS WITHOUT CLAIM TO ANY PARTICULAR FONT, STYLE, SIZE, OR COLOR.

FOR BOARD GAMES (U.S. CLS. 22, 23, 38 AND 50).
WENDY GOODMAN, EXAMINING ATTORNEY

CLASS 28—(Continued).

SN 78-865,674. FERNANDES, ANTHONY, J., NEWPORT, RI.
FILED 4-20-2006.

CRAZY ENGLISH

THE MARK CONSISTS OF STANDARD CHARACTERS WITHOUT CLAIM TO ANY PARTICULAR FONT, STYLE, SIZE, OR COLOR.

FOR EQUIPMENT SOLD AS A UNIT FOR PLAYING CARD GAMES (U.S. CLS. 22, 23, 38 AND 50).
KATINA MISTER, EXAMINING ATTORNEY

SN 78-866,324. J.J.T., INC., LAS VEGAS, NV. FILED 4-20-2006.

NEVADA STYLE

THE MARK CONSISTS OF STANDARD CHARACTERS WITHOUT CLAIM TO ANY PARTICULAR FONT, STYLE, SIZE, OR COLOR.

OWNER OF U.S. REG. NO. 3,013,608.

NO CLAIM IS MADE TO THE EXCLUSIVE RIGHT TO USE "NEVADA", APART FROM THE MARK AS SHOWN.

FOR TOY MONEY BOXES HAVING THE APPEARANCE OF A GAMING MACHINE (U.S. CLS. 22, 23, 38 AND 50).

ELIZABETH PIGNATELLO, EXAMINING ATTORNEY

SN 78-866,345. GFX CONSTRUCTION INC., MORGAN HILL, CA. FILED 4-20-2006.

PUCK OFF

THE MARK CONSISTS OF STANDARD CHARACTERS WITHOUT CLAIM TO ANY PARTICULAR FONT, STYLE, SIZE, OR COLOR.

FOR COIN-OPERATED VIDEO GAMES (U.S. CLS. 22, 23, 38 AND 50).

JULIE WATSON, EXAMINING ATTORNEY

CLASS 28—(Continued).

SN 78-866,375. NUGENT, GORDON W., WILTON, CT. FILED 4-20-2006.

BridgeBalls

THE MARK CONSISTS OF STANDARD CHARACTERS WITHOUT CLAIM TO ANY PARTICULAR FONT, STYLE, SIZE, OR COLOR.

FOR EQUIPMENT SOLD AS A UNIT FOR PLAYING CARD GAMES (U.S. CLS. 22, 23, 38 AND 50).
CHRISTOPHER BUONGIORNO, EXAMINING ATTORNEY

CLASS 28—(Continued).

SN 78-867,150. RAWLINGS SPORTING GOODS COMPANY, INC., ALBANY, NY. FILED 4-21-2006.

BEDLAM

THE MARK CONSISTS OF STANDARD CHARACTERS WITHOUT CLAIM TO ANY PARTICULAR FONT, STYLE, SIZE, OR COLOR.

FOR SPORTING GOODS, NAMELY, ATHLETIC PROTECTIVE LACROSSE GLOVES (U.S. CLS. 22, 23, 38 AND 50).
SHARON MEIER, EXAMINING ATTORNEY

SN 78-867,017. ROGER CLEVELAND GOLF COMPANY, INC., HUNTINGTON BEACH, CA. FILED 4-21-2006.

THE NEW SHAPE OF DISTANCE

THE MARK CONSISTS OF STANDARD CHARACTERS WITHOUT CLAIM TO ANY PARTICULAR FONT, STYLE, SIZE, OR COLOR.

FOR GOLF CLUBS AND GOLF CLUB HEADS (U.S. CLS. 22, 23, 38 AND 50).
HOWARD SMIGA, EXAMINING ATTORNEY

SN 78-867,649. SALE, E. GRAHAM, VAN NUYS, CA. FILED 4-24-2006.

BONELESS CHUCK

THE MARK CONSISTS OF STANDARD CHARACTERS WITHOUT CLAIM TO ANY PARTICULAR FONT, STYLE, SIZE, OR COLOR.

FOR BEAN BAG DOLLS (U.S. CLS. 22, 23, 38 AND 50).
FIRST USE 6-15-1990; IN COMMERCE 6-15-1990.
CAROLYN CATALDO, EXAMINING ATTORNEY

SN 78-867,133. RAWLINGS SPORTING GOODS COMPANY, INC., ALBANY, NY. FILED 4-21-2006.

VAULT

THE MARK CONSISTS OF STANDARD CHARACTERS WITHOUT CLAIM TO ANY PARTICULAR FONT, STYLE, SIZE, OR COLOR.

FOR SPORTING GOODS, NAMELY, ATHLETIC PROTECTIVE LACROSSE GLOVES; LACROSSE STICKS; LAROSSE HANDLES, LACROSSE HEADS (U.S. CLS. 22, 23, 38 AND 50).
SHARON MEIER, EXAMINING ATTORNEY

SN 78-867,728. YEAR FLOW SPORTS CO., INC., PERKASIE, PA. FILED 4-24-2006.

MIRAGE

THE MARK CONSISTS OF STANDARD CHARACTERS WITHOUT CLAIM TO ANY PARTICULAR FONT, STYLE, SIZE, OR COLOR.

FOR BASEBALLS, SOFTBALLS, SOCCER BALLS, AND VOLLEYBALLS (U.S. CLS. 22, 23, 38 AND 50).
FIRST USE 2-12-2004; IN COMMERCE 2-12-2004.
JIM RINGLE, EXAMINING ATTORNEY

CLASS 28—(Continued).

SN 78-867,734. RAWLINGS SPORTING GOODS COMPANY, INC., ALBANY, NY. FILED 4-24-2006.

FANATIC

THE MARK CONSISTS OF STANDARD CHARACTERS WITHOUT CLAIM TO ANY PARTICULAR FONT, STYLE, SIZE, OR COLOR.

FOR SPORTING GOODS, NAMELY, ATHLETIC PROTECTIVE LACROSSE GLOVES (U.S. CLS. 22, 23, 38 AND 50).

SHARON MEIER, EXAMINING ATTORNEY

SN 78-867,737. RAWLINGS SPORTING GOODS COMPANY, INC., ALBANY, NY. FILED 4-24-2006.

SERENITY

THE MARK CONSISTS OF STANDARD CHARACTERS WITHOUT CLAIM TO ANY PARTICULAR FONT, STYLE, SIZE, OR COLOR.

FOR LACROSSE EQUIPMENT, NAMELY, LACROSSE HEADS, LACROSSE STICKS (U.S. CLS. 22, 23, 38 AND 50).

SHARON MEIER, EXAMINING ATTORNEY

SN 78-867,740. RAWLINGS SPORTING GOODS COMPANY, INC., ALBANY, NY. FILED 4-24-2006.

INTUITION

THE MARK CONSISTS OF STANDARD CHARACTERS WITHOUT CLAIM TO ANY PARTICULAR FONT, STYLE, SIZE, OR COLOR.

FOR LACROSSE EQUIPMENT, NAMELY, LACROSSE HEADS, LACROSSE STICKS (U.S. CLS. 22, 23, 38 AND 50).

SHARON MEIER, EXAMINING ATTORNEY

CLASS 28—(Continued).

SN 78-868,540. THE DOUBLEDECKER TOY, LLC., MILWAUKEE, WI. FILED 4-24-2006.

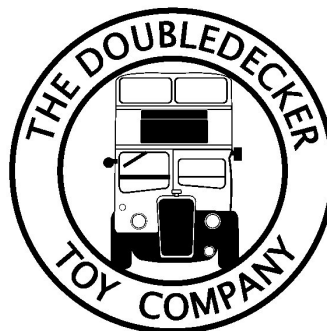

NO CLAIM IS MADE TO THE EXCLUSIVE RIGHT TO USE "TOY COMPANY", APART FROM THE MARK AS SHOWN.

FOR CHILDREN'S TOYS, NAMELY, BATH TOYS, INFANTS TOYS, DRAWING TOYS, PLUSH TOYS, PULL TOYS, PUSH TOYS, RIDE-ON TOYS, MUSICAL TOYS, STACKING TOYS, TOY BUILDING BLOCKS, TOY VEHICLES (U.S. CLS. 22, 23, 38 AND 50).

WENDY JUN, EXAMINING ATTORNEY

SN 78-869,119. PENN, AUDREY, OLNEY, MD. FILED 4-25-2006.

CHESTER RACCOON

THE MARK CONSISTS OF STANDARD CHARACTERS WITHOUT CLAIM TO ANY PARTICULAR FONT, STYLE, SIZE, OR COLOR.

NO CLAIM IS MADE TO THE EXCLUSIVE RIGHT TO USE "RACCOON", APART FROM THE MARK AS SHOWN.

FOR ACTION FIGURES, ACTION FIGURES AND ACCESSORIES THEREFOR, ACTION SKILL GAMES, BALLOONS, BATH TOYS, BOARD GAMES, CARD GAMES, CHILDREN'S MULTIPLE ACTIVITY TOYS, CHRISTMAS TREE DECORATIONS, CONSTRUCTION TOYS, DOLLS, DOLL ACCESSORIES AND CLOTHING, DRAWING TOYS, ELECTRONIC EDUCATIONAL GAME MACHINES FOR CHILDREN, FLYING DISKS, HAND-HELD UNITS FOR PLAYING ELECTRONIC GAMES, INFANT TOYS, INFLATABLE TOYS, JUMP ROPES, KITES, MANIPULATIVE GAMES, MECHANICAL TOYS, MUSICAL TOYS, PARTY FAVORS IN THE NATURE OF SMALL TOYS, PLAY FIGURES, PLUSH TOYS, PULL TOYS, PUPPETS, PUZZLES, SAND TOYS, SPORT BALLS, STUFFED TOYS, TOY MOBILES, TOY MODEL HOBBY-CRAFT KITS, TOY VEHICLES, YO-YOS (U.S. CLS. 22, 23, 38 AND 50).

PETER CHENG, EXAMINING ATTORNEY

CLASS 28—(Continued).

SN 78-869,380. GALMAX INDUSTRIES, LLC, LAS VEGAS, NV. FILED 4-25-2006.



NO CLAIM IS MADE TO THE EXCLUSIVE RIGHT TO USE "POKER" AND "DOT COM", APART FROM THE MARK AS SHOWN.

THE MARK CONSISTS OF CROWN DESIGN CENTERED BETWEEN TWO HORIZONTAL WAVES OVER THE WORDS POKER KING. HORIZONTAL LINE AT BOTTOM WITH WORDS DOT COM IN CENTER OF LINE.

FOR CARD GAMES; GAME EQUIPMENT, NAMELY, CHIPS; GAME TABLES; GAMING EQUIPMENT, NAMELY, POKER CHIPS; PLAYING CARDS (U.S. CLS. 22, 23, 38 AND 50).

TONJA GASKINS, EXAMINING ATTORNEY

SN 78-869,801. POP'S FISHING SUPPLY, LLC, BROOK-LAWN, NJ. FILED 4-26-2006.

OCEAN GIRL

THE MARK CONSISTS OF STANDARD CHARACTERS WITHOUT CLAIM TO ANY PARTICULAR FONT, STYLE, SIZE, OR COLOR.

FOR FISHING SUPPLIES, NAMELY, FISHING RODS, FISHING REELS AND TACKLE BOXES (U.S. CLS. 22, 23, 38 AND 50).

MARTHA SANTOMARTINO, EXAMINING ATTORNEY

SN 78-869,894. DEEGAN, BRIAN, CORONA, CA. FILED 4-26-2006.

HEVY HITTERS

THE MARK CONSISTS OF STANDARD CHARACTERS WITHOUT CLAIM TO ANY PARTICULAR FONT, STYLE, SIZE, OR COLOR.

FOR HAND-HELD UNIT FOR PLAYING VIDEO GAMES; STAND-ALONE VIDEO GAME MACHINES; ACTION FIGURES AND ACCESSORIES THEREFOR; TOY MODEL VEHICLES, NAMELY, MOTORCROSS BIKES AND MOTORCYCLES, AND RELATED ACCESSORIES SOLD AS UNITS; TOY MODEL CARS AND MOTORCYCLES; REMOTE CONTROL TOYS, NAMELY, MOTORCYCLES AND MOTORCROSS BIKES; SKATEBOARDS; AND SNOWBOARDS (U.S. CLS. 22, 23, 38 AND 50).

SHARON MEIER, EXAMINING ATTORNEY

CLASS 28—(Continued).

SN 78-870,049. LEADERSHIP NOW, INC., COLUMBUS, GA. FILED 4-26-2006.

LEADERSHIP

THE MARK CONSISTS OF STANDARD CHARACTERS WITHOUT CLAIM TO ANY PARTICULAR FONT, STYLE, SIZE, OR COLOR.

FOR BOARD GAMES (U.S. CLS. 22, 23, 38 AND 50).
DOMINIC J. FERRAIUOLO, EXAMINING ATTORNEY

SN 78-870,263. TARA TOY CORPORATION, HAUPPAUGE, NY. FILED 4-26-2006.

PONY LUV

THE MARK CONSISTS OF STANDARD CHARACTERS WITHOUT CLAIM TO ANY PARTICULAR FONT, STYLE, SIZE, OR COLOR.

OWNER OF U.S. REG. NO. 2,442,948.

NO CLAIM IS MADE TO THE EXCLUSIVE RIGHT TO USE "PONY", APART FROM THE MARK AS SHOWN.

FOR TOY PONIES (U.S. CLS. 22, 23, 38 AND 50).

FIRST USE 0-0-1997; IN COMMERCE 0-0-1997.

MARGARET POWER, EXAMINING ATTORNEY

SN 78-870,389. KZ GOLF, INC., NORTH HOLLYWOOD, CA. FILED 4-26-2006.

GEMINI

THE MARK CONSISTS OF STANDARD CHARACTERS WITHOUT CLAIM TO ANY PARTICULAR FONT, STYLE, SIZE, OR COLOR.

FOR GOLF EQUIPMENT, NAMELY, GOLF BAGS; GOLF BALLS; GOLF CLUB HEADS; GOLF CLUB INSERTS; GOLF CLUB SHAFTS; GOLF CLUBS; GRIP TAPE FOR GOLF CLUBS; HAND GRIPS FOR GOLF CLUBS; GOLF GLOVES; GOLF ACCESSORY POUCHES; GOLF BAG COVERS; GOLF BAG TAGS; GOLF BALL MARKERS; GOLF IRONS; GOLF PUTTER COVERS; GOLF PUTTERS; GOLF TEE MARKERS; GOLF TEES (U.S. CLS. 22, 23, 38 AND 50).

FIRST USE 8-0-2004; IN COMMERCE 8-0-2004.

LINDA M. KING, EXAMINING ATTORNEY

CLASS 28—(Continued).

SN 78-871,658. ACTION CONCEPTS FAST FORWARD, LTD., DBA FAST FORWARD, FORT WORTH, TX. FILED 4-27-2006.



FOR SPORTING GOODS, NAMELY, SKATEBOARDS, SKATEBOARD TRUCKS, SKATEBOARD WHEELS, SKATEBOARD DECKS, SKATEBOARD ACCESSORIES, NAMELY, BEARINGS, NUTS AND BOLTS, GRIP TAPE, RISERS, SHOCK PADS, BUSHINGS AND SKATEBOARD ADJUSTMENT TOOLS (U.S. CLS. 22, 23, 38 AND 50).
FIRST USE 12-28-2004; IN COMMERCE 12-28-2004.
PAUL E. FAHRENKOPF, EXAMINING ATTORNEY

SN 78-872,326. JASMAN ASIA LTD., KOWLOON, HONG KONG, FILED 4-28-2006.

MIGHTY MEN & MONSTER MAKER

THE MARK CONSISTS OF STANDARD CHARACTERS WITHOUT CLAIM TO ANY PARTICULAR FONT, STYLE, SIZE, OR COLOR.
FOR HOBBY CRAFT SETS FOR CREATING DRAWINGS (U.S. CLS. 22, 23, 38 AND 50).
BERYL GARDNER, EXAMINING ATTORNEY

SN 78-872,613. VIEJAS BAND OF KUMEYAAY INDIANS, ALPINE, CA. FILED 4-28-2006.

Mud Thug

THE MARK CONSISTS OF STANDARD CHARACTERS WITHOUT CLAIM TO ANY PARTICULAR FONT, STYLE, SIZE, OR COLOR.
FOR ACTION FIGURES; PLUSH TOYS (U.S. CLS. 22, 23, 38 AND 50).
KATHERINE CONNOLLY, EXAMINING ATTORNEY

CLASS 28—(Continued).

SN 78-872,735. SHUFFLE MASTER INC., LAS VEGAS, NV. FILED 4-28-2006.

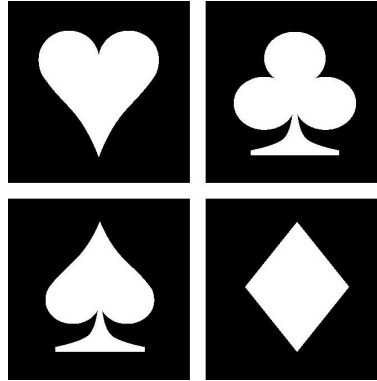

THE MARK CONSISTS OF FOUR PLAYING CARD SUITS (IE, HEARTS, CLOVER, SPADES, AND DIAMONDS), EACH FORMED BY CONTRAST OR SHADING IN A PORTION OF AN INDIVIDUAL SQUARE, WHEREIN THE INDIVIDUAL SQUARES ARE ARRANGED TO FORM A LARGER SQUARE WITH A BORDER LINE BETWEEN EACH INDIVIDUAL SQUARE.

FOR CASINO GAMING EQUIPMENT, NAMELY AUTOMATIC CARD SHUFFLERS (U.S. CLS. 22, 23, 38 AND 50).
FIRST USE 4-30-2004; IN COMMERCE 4-30-2004.
CAROLYN CATALDO, EXAMINING ATTORNEY

SN 78-874,920. HORIZON DARTS, INC., KANSAS CITY, KS. FILED 5-2-2006.

BARRACUDA

THE MARK CONSISTS OF STANDARD CHARACTERS WITHOUT CLAIM TO ANY PARTICULAR FONT, STYLE, SIZE, OR COLOR.
FOR HAND THROWN DARTS (U.S. CLS. 22, 23, 38 AND 50).
FIRST USE 9-1-1986; IN COMMERCE 9-1-1986.
RONALD MCMORROW, EXAMINING ATTORNEY

SN 78-874,958. PERRINE, KIMBERLY, S., MADEIRA BEACH, FL. FILED 5-3-2006.

"PELICLAUSE"

THE MARK CONSISTS OF STANDARD CHARACTERS WITHOUT CLAIM TO ANY PARTICULAR FONT, STYLE, SIZE, OR COLOR.
FOR CHRISTMAS TREE ORNAMENTS (U.S. CLS. 22, 23, 38 AND 50).
FIRST USE 8-22-1983; IN COMMERCE 8-22-1983.
SARAH WAYDA, EXAMINING ATTORNEY

CLASS 28—(Continued).

SN 78-875,604. THE HARTZ MOUNTAIN CORPORATION,
SECAUCUS, NJ. FILED 5-3-2006.

AQUA ROCKER

THE MARK CONSISTS OF STANDARD CHARACTERS
WITHOUT CLAIM TO ANY PARTICULAR FONT, STYLE,
SIZE, OR COLOR.
FOR PET TOYS (U.S. CLS. 22, 23, 38 AND 50).
RON FAIRBANKS, EXAMINING ATTORNEY

CLASS 28—(Continued).

SN 78-880,724. JAKKS PACIFIC, INC., MALIBU, CA. FILED
5-10-2006.

INSTA-FLIGHT

THE MARK CONSISTS OF STANDARD CHARACTERS
WITHOUT CLAIM TO ANY PARTICULAR FONT, STYLE,
SIZE, OR COLOR.
FOR KITES (U.S. CLS. 22, 23, 38 AND 50).
ADA HAN, EXAMINING ATTORNEY

SN 78-876,327. RAWLINGS SPORTING GOODS COMPANY,
INC., TULLAHOA, TN. FILED 5-4-2006.

MUTANT

THE MARK CONSISTS OF STANDARD CHARACTERS
WITHOUT CLAIM TO ANY PARTICULAR FONT, STYLE,
SIZE, OR COLOR.
FOR SPORTING GOODS, NAMELY, BASEBALL BATS
AND SOFTBALL BATS (U.S. CLS. 22, 23, 38 AND 50).
SHARON MEIER, EXAMINING ATTORNEY

SN 78-880,902. GALMAX INDUSTRIES, LLC, LAS VEGAS,
NV. FILED 5-10-2006.

SN 78-876,929. JAKKS PACIFIC, INC., MALIBU, CA. FILED
5-4-2006.

POKER KING**ROAD CHAMPS XS XTREME
SPORTS**

THE MARK CONSISTS OF STANDARD CHARACTERS
WITHOUT CLAIM TO ANY PARTICULAR FONT, STYLE,
SIZE, OR COLOR.
OWNER OF U.S. REG. NOS. 1,105,221, 2,504,277 AND
OTHERS.
FOR TOY VEHICLES AND ACCESSORIES THEREFOR
(U.S. CLS. 22, 23, 38 AND 50).
ADA HAN, EXAMINING ATTORNEY

THE MARK CONSISTS OF STANDARD CHARACTERS
WITHOUT CLAIM TO ANY PARTICULAR FONT, STYLE,
SIZE, OR COLOR.
NO CLAIM IS MADE TO THE EXCLUSIVE RIGHT TO
USE POKER, APART FROM THE MARK AS SHOWN.
FOR GAMING EQUIPMENT, NAMELY, POKER
CHIPS; GAMING TABLES; PLAYING CARDS (U.S.
CLS. 22, 23, 38 AND 50).
TONJA GASKINS, EXAMINING ATTORNEY

CLASS 28—(Continued).

SN 78-891,104. HOODLOVE LIMITED LIABILITY COMPANY, EAST ORANGE, NJ. FILED 5-25-2006.

HOOD LOVE

THE MARK CONSISTS OF STANDARD CHARACTERS WITHOUT CLAIM TO ANY PARTICULAR FONT, STYLE, SIZE, OR COLOR.

FOR ACTION SKILL GAMES; AMUSEMENT GAME MACHINES; ARCADE GAMES; BASEBALL BATS; BASEBALL BATTING GLOVES; BASEBALL MITTS; BASEBALLS; BASKET BALLS; BASKETBALL TABLE TOP GAMES; BATHTUB TOYS; BEACH BALLS; BENDABLE TOYS; BILLIARD GAME PLAYING EQUIPMENT; BLOW-OUTS; BOARD GAMES; CARD GAMES; COIN-OPERATED VIDEO GAMES; CONSTRUCTION TOYS; CRIB TOYS; DICE GAMES; DRAWING TOYS; ELECTRONIC DART GAMES; FLYING SAUCERS; FOOT BALLS; FOOTBALLS; INFANT ACTION CRIB TOYS; INFANT TOYS; INFLATABLE TOYS; PADDLE BALL GAMES; PARTY FAVORS IN THE NATURE OF CRACKERS AND NOISEMAKERS; PARTY FAVORS IN THE NATURE OF SMALL TOYS; PARTY GAMES; PINBALL GAMES; SKETCHING TOYS; SQUEEZE TOYS; STACKING TOYS; STUFFED TOY ANIMALS; STUFFED TOY BEARS; STUFFED TOYS; TARGET GAMES; TOY AIRPLANES; TOY ANIMALS AND ACCESSORIES THEREFORE; TOY BAKEWARE AND COOKWARE; TOY BANKS; TOY CLOCKS AND WATCHES; TRADING CARD GAMES (U.S. CLS. 22, 23, 38 AND 50).
BARBARA BROWN, EXAMINING ATTORNEY

SN 78-893,265. PRINCE LIONHEART, INC., SANTA MARIA, CA. FILED 5-25-2006.

SLUMBER BEAR

THE MARK CONSISTS OF STANDARD CHARACTERS WITHOUT CLAIM TO ANY PARTICULAR FONT, STYLE, SIZE, OR COLOR.

NO CLAIM IS MADE TO THE EXCLUSIVE RIGHT TO USE "BEAR", APART FROM THE MARK AS SHOWN.

FOR INFANT/BABY TOY WHICH PRODUCES INTRAMETERINE RECORDED WOMB SOUNDS (U.S. CLS. 22, 23, 38 AND 50).

TARAH HARDY, EXAMINING ATTORNEY

CLASS 28—(Continued).

SN 78-898,801. TRI-BAG LIMITED, BEDFORDSHIRE, UNITED KINGDOM, FILED 6-2-2006.



FOR GOLF BAGS; GOLF BAGS WITH OR WITHOUT WHEELS; BAG STANDS FOR GOLF BAGS; CADDIE BAGS FOR GOLF CLUBS; GOLF CLUB BAGS; GOLF TEE BAGS; STANDS FOR GOLF BAGS; TROLLEY BAGS FOR GOLF EQUIPMENT; PARTS AND FITTINGS FOR ALL THE AFORESAID GOODS (U.S. CLS. 22, 23, 38 AND 50).

KELLY MCCOY, EXAMINING ATTORNEY

SN 78-899,819. SMALL WORLD TOYS, CULVER CITY, CA. FILED 6-2-2006.

LIFT AND LEARN

THE MARK CONSISTS OF STANDARD CHARACTERS WITHOUT CLAIM TO ANY PARTICULAR FONT, STYLE, SIZE, OR COLOR.

FOR TOYS AND GAMES, NAMELY PUZZLES (U.S. CLS. 22, 23, 38 AND 50).

FIRST USE 10-0-1983; IN COMMERCE 10-0-1983.

DOMINICK J. SALEMI, EXAMINING ATTORNEY

SN 78-902,911. O. MUSTAD & SON (U.S.A.) INC., AUBURN, NY. FILED 6-7-2006.

ACCU-BRAID

THE MARK CONSISTS OF STANDARD CHARACTERS WITHOUT CLAIM TO ANY PARTICULAR FONT, STYLE, SIZE, OR COLOR.

FOR FISHING LINES; FISHING TACKLE (U.S. CLS. 22, 23, 38 AND 50).

JENNY PARK, EXAMINING ATTORNEY

CLASS 28—(Continued).

SN 78-910,273. WHAM-O, INC., EMERYVILLE, CA. FILED 6-16-2006.

PLUTO PLATTER

THE MARK CONSISTS OF STANDARD CHARACTERS WITHOUT CLAIM TO ANY PARTICULAR FONT, STYLE, SIZE, OR COLOR.

FOR FLYING DISCS AND SAUCERS USED IN SPORT AND RECREATIONAL ACTIVITIES AND GAMES (U.S. CLS. 22, 23, 38 AND 50).

ALLISON HOLTZ, EXAMINING ATTORNEY

SN 78-912,565. ROGER CLEVELAND GOLF COMPANY, INC., HUNTINGTON BEACH, CA. FILED 6-20-2006.

TRU GROOVE

THE MARK CONSISTS OF STANDARD CHARACTERS WITHOUT CLAIM TO ANY PARTICULAR FONT, STYLE, SIZE, OR COLOR.

FOR GOLF CLUBS, NAMELY WEDGES, AND GOLF CLUB HEADS (U.S. CLS. 22, 23, 38 AND 50).

HOWARD SMIGA, EXAMINING ATTORNEY

SN 78-931,402. JAKKS PACIFIC, INC., MALIBU, CA. FILED 7-17-2006.

BOARDIN' BRODY

THE MARK CONSISTS OF STANDARD CHARACTERS WITHOUT CLAIM TO ANY PARTICULAR FONT, STYLE, SIZE, OR COLOR.

FOR DOLLS AND ACCESSORIES THEREFOR (U.S. CLS. 22, 23, 38 AND 50).

ADA HAN, EXAMINING ATTORNEY

CLASS 28—(Continued).

SN 78-931,404. JAKKS PACIFIC, INC., MALIBU, CA. FILED 7-17-2006.

BRODY

THE MARK CONSISTS OF STANDARD CHARACTERS WITHOUT CLAIM TO ANY PARTICULAR FONT, STYLE, SIZE, OR COLOR.

FOR DOLLS AND ACCESSORIES THEREFOR (U.S. CLS. 22, 23, 38 AND 50).

ADA HAN, EXAMINING ATTORNEY

CLASS 29—MEATS AND PROCESSED FOODS

SN 76-600,483. NUOVA CASTELLI S.P.A., 42100 REGGIO EMILIA, ITALY, FILED 7-2-2004.



NO CLAIM IS MADE TO THE EXCLUSIVE RIGHT TO USE "DAL 1892, BUTTER OF PARMA", "SELEZIONE", "INDUSTRIE ALIMENTARI S.P.A.", "REGGIO EMILIA" AND "SPECIALITA CASEARIE", APART FROM THE MARK AS SHOWN.

THE ENGLISH TRANSLATION OF THE WORD DAL 1892, SELEZIONE, INDUSTRIE ALIMENTARI, AND SPECIALITA CASEARIE IN THE MARK IS SINCE 1892, SELECTION, FOOD INDUSTRY AND DAIRY SPECIALTIES.

FOR BUTTER (U.S. CL. 46).

ANGELA M. MICHELI, EXAMINING ATTORNEY

CLASS 29—(Continued).

SN 76-621,575. BONANZA MEAT COMPANY, INC., VERNON, CA. FILED 11-22-2004.



NO CLAIM IS MADE TO THE EXCLUSIVE RIGHT TO USE "BEEF NATURALLY RAISED BEEF", APART FROM THE MARK AS SHOWN.

FOR FRESH AND FROZEN MEAT, NAMELY BEEF (U.S. CL. 46).
YONG KIM, EXAMINING ATTORNEY

SN 76-625,977. SAFEWAY INC., PLEASANTON, CA. FILED 12-29-2004.

IT'S LIKE DINING OUT AT HOME

THE MARK CONSISTS OF STANDARD CHARACTERS WITHOUT CLAIM TO ANY PARTICULAR FONT, STYLE, SIZE, OR COLOR.

FOR PREPARED FOOD, NAMELY HOT AND COLD SOUPS (U.S. CL. 46).

FIRST USE 9-15-2004; IN COMMERCE 9-15-2004.
IRENE D. WILLIAMS, EXAMINING ATTORNEY

SN 76-637,977. SPECIALTY BRANDS, L.P., ONTARIO, CA. FILED 5-6-2005.

FIESTA BAKES

THE MARK CONSISTS OF STANDARD CHARACTERS WITHOUT CLAIM TO ANY PARTICULAR FONT, STYLE, SIZE, OR COLOR.

FOR MEXICAN STYLE ENTREES CONSISTING PRIMARILY OF MEAT, CHEESE AND/OR VEGETABLES WITH TORTILLAS AND/OR SAUCE (U.S. CL. 46).

SHARI SHEFFIELD, EXAMINING ATTORNEY

CLASS 29—(Continued).

SN 76-647,197. TREASURE FOODS, INC., SALT LAKE CITY, UT. FILED 9-21-2005.

TREASURE FOODS

THE MARK CONSISTS OF STANDARD CHARACTERS WITHOUT CLAIM TO ANY PARTICULAR FONT, STYLE, SIZE, OR COLOR.

NO CLAIM IS MADE TO THE EXCLUSIVE RIGHT TO USE "FOODS", APART FROM THE MARK AS SHOWN, FOR HONEY BUTTER, FRUIT AND WHIPPED TOPPINGS (U.S. CL. 46).

FIRST USE 2-19-1988; IN COMMERCE 2-19-1988.
SANI KHOURI, EXAMINING ATTORNEY

SN 76-658,816. P.T. DIPASENA CITRA DARMAJA, JAKARTA, INDONESIA, FILED 4-21-2006.



THE MARK CONSISTS OF A LOTUS FLOWER NEXT TO THE WORD LOTUS IN STYLIZED LETTERS.

FOR FROZEN SHRIMP (U.S. CL. 46).
FIRST USE 10-12-1992; IN COMMERCE 10-12-1992.
ROBERT STRUCK, EXAMINING ATTORNEY

SN 78-319,836. PHILOSOPHY FOODS, INC., HIGHLAND PARK, IL. FILED 10-28-2003.



NO CLAIM IS MADE TO THE EXCLUSIVE RIGHT TO USE FOOD, APART FROM THE MARK AS SHOWN.

THE MARK CONSISTS OF A YELLOW SUN AROUND THE NAME OF THE COMPANY AS WELL AS PEOPLE EMBRACING WITHIN THE SUN DESIGN.

FOR SOUPS, CHOWDERS, CHILI (U.S. CL. 46).
TONI HICKEY, EXAMINING ATTORNEY

CLASS 29—(Continued).

SN 78-439,509. GUTIERREZ, CARLOS REYNOSO, ZAPO-
PAN, JALISCO, MEXICO, FILED 6-22-2004.

CAREY

THE MARK CONSISTS OF STANDARD CHARACTERS
WITHOUT CLAIM TO ANY PARTICULAR FONT, STYLE,
SIZE, OR COLOR.

FOR CANNED COOKED MEAT; CANNED FRUITS
AND VEGETABLES (U.S. CL. 46).
IRA J. GOODSaid, EXAMINING ATTORNEY

CLASS 29—(Continued).

SN 78-624,467. NUTRABELLA, LLC, SAN MATEO, CA.
FILED 5-6-2005.

BABY NEEDS CHOCOLATE

THE MARK CONSISTS OF STANDARD CHARACTERS
WITHOUT CLAIM TO ANY PARTICULAR FONT, STYLE,
SIZE, OR COLOR.

FOR PROTEIN-ENRICHED, NUTRIENT-DENSE
SNACK BARS FOR WOMEN BEFORE, DURING AND
AFTER PREGNANCY (U.S. CL. 46).
KALIE KUNG, EXAMINING ATTORNEY

SN 78-648,488. C.K.F. FOODS, INC., MOUNT PROSPECT, IL.
FILED 6-10-2005.

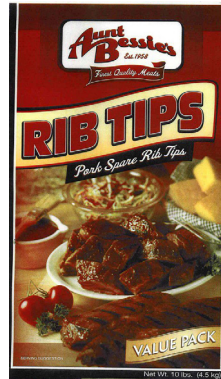

SN 78-582,529. SHOGUN ENTERPRISES INC., DBA I LOVE
SUSHI, BELLEVUE, WA. FILED 3-8-2005.

I LOVE TOFU

THE MARK CONSISTS OF STANDARD CHARACTERS
WITHOUT CLAIM TO ANY PARTICULAR FONT, STYLE,
SIZE, OR COLOR.

NO CLAIM IS MADE TO THE EXCLUSIVE RIGHT TO
USE "TOFU", APART FROM THE MARK AS SHOWN.

FOR BEAN CURD; PROCESSED BEAN CURD AND
FOOD CONTAINING OR MADE OF BEAN CURD,
NAMESLY, DEEP-FRIED TOFU, STEAMED TOFU, TOFU
MOUSSE, TOFU SALAD (U.S. CL. 46).
INGRID C. EULIN, EXAMINING ATTORNEY

OWNER OF U.S. REG. NOS. 2,051,556 AND 2,626,024.
NO CLAIM IS MADE TO THE EXCLUSIVE RIGHT TO
USE "EST. 1958", "FINEST QUALITY MEATS", "PORK
SPARE RIB TIPS", AND "VALUE PACK", APART FROM
THE MARK AS SHOWN.

THE COLOR(S) WHITE, YELLOW, ORANGE, RED,
GREEN, BROWN, SILVER, BLACK IS/ARE CLAIMED AS
A FEATURE OF THE MARK.

THE COLOR BROWN APPEARS IN THE FOOD ON AND
NEXT TO THE PLATE, AS SHADOWING/SHADING FOR
THE STYLIZED WORDS PORK SPARE RIB TIPS, AS AN
OUTLINE OF THE GOLD BANNER FOR THE STYLIZED
WORDS VALUE PACK, AS SHADOWING/SHADING FOR
THE STYLIZED WORDS VALUE PACK, AS SHADOWING/
SHADING BETWEEN THE BOWL OF COLESLAW AND
TRAY OF CORNBREAD, AND IN THE LOWER LEFT
CORNER BELOW THE TOMATOES. THE COLOR BLACK
APPEARS ON THE FOOD ON AND NEXT TO THE PLATE,
AS AN OUTLINE FOR THE STYLIZED WORDS AUNT
'BESSIE'S, AS AN OUTLINE FOR THE WHITE BANNER
FOR THE STYLIZED WORDS AUNT BESSIE'S EST. 1958, AS
SHADOWING/SHADING FOR THE STYLIZED WORD
FINEST QUALITY MEATS, AS SHADOWING/SHADING FOR
THE STYLIZED WORDS RIB TIPS, AS AN OUTLINE FOR
THE BANNER FOR THE STYLIZED WORDS RIB TIPS, AS A
BACKGROUND IN THE BANNER FOR THE STYLIZED
WORDS PORK SPARE RIB TIPS, AND AS SHADOWING/
SHADING FOR THE STYLIZED WORDS VALUE PACK.
THE COLOR WHITE APPEARS IN THE BACKGROUND OF
THE RECTANGULAR BANNER WITH ROUNDED COR-
NERS FOR THE STYLIZED WORDS AUNT BESSIE'S EST.
1958, IN THE STYLIZED WORDS FINEST QUALITY
MEATS, AN OUTLINE FOR THE RED BANNER FOR THE
STYLIZED WORDS FINEST QUALITY MEATS, AS SHA-
DOWING/SHADING FOR THE STYLIZED WORDS RIB
TIPS, IN THE STYLIZED WORDS PORK SPARE RIB TIPS,
IN THE STYLIZED WORDS VALUE PACK, ON THE PLATE,
ON THE RIM OF THE SAUCE CUP, AND ON PARTS OF

CLASS 29—(Continued).

THE CHECKERED NAPKIN ON AND NEXT TO THE TRAY (BASKET). THE COLOR SILVER APPEARS IN THE FORK, IN THE GLASS BOWL CONTAINING THE COLESLAW, AND BETWEEN THE BRISTLES AND HANDLE OF THE BRUSH. THE COLOR ORANGE APPEARS IN THE CARROTS IN THE COLESLAW. THE COLOR GOLD APPEARS IN THE BANNER FOR THE STYLIZED WORDS VALUE PACK, IN THE BANNER FOR THE STYLIZED WORDS RIB TIPS, ON THE HANDLE OF THE BRUSH, ON THE TRAY (BASKET), AND ON THE FOOD (CORNBREAD) ON THE TRAY (BASKET). THE COLOR YELLOW APPEARS ON THE BRISTLES OF THE BRUSH, ON THE SAUCE CUP, ON THE TABLE NEXT TO THE PLATE, ON THE FOOD (CORNBREAD) IN THE TRAY (BASKET), AND IN THE BANNER FOR THE STYLIZED WORDS RIB TIPS. THE COLOR GREEN APPEARS IN PARSLEY ON AND NEXT TO THE PLATE, ON THE STEMS OF THE TOMATOES, ON THE CHECKERED NAPKIN ON TRAY (BASKET), AND IN THE COLESLAW. THE COLOR RED APPEAR IN THE TOMATOES, IN THE STYLIZED WORDS AUNT BESSIE'S EST. 1958, IN THE BANNER FOR THE STYLIZED WORDS FINEST QUALITY MEATS, IN THE STYLIZED WORDS RIB TIPS, IN THE SAUCE IN THE CUP, IN THE COLESLAW, IN THE SAUCE IN THE CUP, IN THE COLESLAW, AND AS BACKGROUND ABOVE AND TO THE RIGHT OF THE BANNER FOR RIB TIPS AND ABOVE THE TRAY (BASKET) WITH THE CORNBREAD.

FOR PORK; PORK SPARE RIB TIPS; MEAT; FROZEN ENTREES CONSISTING PRIMARILY OF MEAT; PREPARED ENTREES CONSISTING PRIMARILY OF MEAT; PACKAGED ENTREES CONSISTING PRIMARILY OF MEAT; FROZEN MEAT; PREPARED MEAT; AND PROCESSED MEAT, NAMELY, PORK (U.S. CL. 46).

ANNE MADDEN, EXAMINING ATTORNEY

SN 78-663,450. JONMOR INVESTMENTS, INC., WILMINGTON, DE. FILED 7-5-2005.



OWNER OF U.S. REG. NO. 1,672,694.
NO CLAIM IS MADE TO THE EXCLUSIVE RIGHT TO USE "PREMIUM DELI MEATS", "QUALITY SINCE 1883", OR "LEGENDARY TASTE", APART FROM THE MARK AS SHOWN.

FOR MEAT (U.S. CL. 46).
FIRST USE 5-0-2004; IN COMMERCE 5-0-2004.
REBECCA HAN, EXAMINING ATTORNEY

CLASS 29—(Continued).

SN 78-672,252. C.I. AGRODEX, S.A., BARRANQUILLA, COLOMBIA, FILED 7-18-2005.



"THE COLOR(S) ORANGE, BLACK, WHITE AND LIGHT ORANGE IS/ARE CLAIMED AS A FEATURE OF THE MARK."

"THE MARK CONSISTS OF A TRIANGULAR DESIGN IN ORANGE, WITH A WHITE LETTER "S" AND A LIGHT ORANGE CURVE DESIGN APPEARING THEREIN; THE WORDINGS "AN" AND "ILVESTRE" ARE IN BLACK."

"THE FOREIGN WORDING IN THE MARK TRANSLATES INTO ENGLISH AS SAINT SILVESTER."

FOR FROZEN FRUITS AND FROZEN VEGETABLES (U.S. CL. 46).

FIRST USE 11-30-2001; IN COMMERCE 11-30-2001.
DAWN HAN, EXAMINING ATTORNEY

SN 78-692,106. FABIANI, TANIA, NEW YORK, NY. FILED 8-13-2005.



THE MARK CONSISTS OF STYLIZED LETTERS OF THE NAME NOORT.

FOR OLIVE OIL (U.S. CL. 46).
FIRST USE 12-1-2004; IN COMMERCE 12-1-2004.
CHERYL CLAYTON, EXAMINING ATTORNEY

SN 78-693,297. CSC BRANDS LP, CAMDEN, NJ. FILED 8-16-2005.

TACKLING HUNGER

THE MARK CONSISTS OF STANDARD CHARACTERS WITHOUT CLAIM TO ANY PARTICULAR FONT, STYLE, SIZE, OR COLOR.

FOR SOUPS AND CHILIS (U.S. CL. 46).
FIRST USE 8-31-1999; IN COMMERCE 8-31-1999.
DOMINIC J. FERRAUOLO, EXAMINING ATTORNEY

CLASS 29—(Continued).

SN 78-693,782. FERDINANDO GIORDANO S.P.A., VALLE TALLORIA DI DIANO D'ALBA, CUNEO, ITALY, FILED 8-16-2005.

GIORDANO

THE MARK CONSISTS OF STANDARD CHARACTERS WITHOUT CLAIM TO ANY PARTICULAR FONT, STYLE, SIZE, OR COLOR.

FOR OLIVE OIL (U.S. CL. 46).
FIRST USE 2-0-2006; IN COMMERCE 2-0-2006.
SHARI SHEFFIELD, EXAMINING ATTORNEY

SN 78-696,017. WISCON CORP, MELROSE PK, IL. FILED 8-18-2005.

RED COW

THE MARK CONSISTS OF STANDARD CHARACTERS WITHOUT CLAIM TO ANY PARTICULAR FONT, STYLE, SIZE, OR COLOR.

SEC. 2(F).
FOR CHEESE (U.S. CL. 46).
FIRST USE 3-14-1996; IN COMMERCE 3-14-1996.
BRIDGETT SMITH, EXAMINING ATTORNEY

SN 78-696,395. ORLANDO FOODS CORPORATION, MAYWOOD, NJ. FILED 8-19-2005.

Smatras
TOP OF THE LINE

OWNER OF U.S. REG. NO. 1,451,064.
NO CLAIM IS MADE TO THE EXCLUSIVE RIGHT TO USE "TOP OF THE LINE", APART FROM THE MARK AS SHOWN.

THE MARK CONSISTS OF A STYLIZED BOW TIE. FOR CANNED, COOKED OR OTHERWISE PROCESSED TOMATOES; OLIVE OIL; PROCESSED PEPPERS; PROCESSED VEGETABLES AND FRUITS (U.S. CL. 46).

FIRST USE 4-0-1986; IN COMMERCE 4-0-1986.
ANNE E. GUSTASON, EXAMINING ATTORNEY

CLASS 29—(Continued).

SN 78-700,437. EUPHRATES, INC., JOHNSTOWN, NY. FILED 8-25-2005.

TODAY'S GREEK

THE MARK CONSISTS OF STANDARD CHARACTERS WITHOUT CLAIM TO ANY PARTICULAR FONT, STYLE, SIZE, OR COLOR.

NO CLAIM IS MADE TO THE EXCLUSIVE RIGHT TO USE "GREEK", APART FROM THE MARK AS SHOWN. FOR DAIRY PRODUCTS, NAMELY CHEESE, YOGURT, AND YOGURT DRINKS; PROCESSED PEPPERS, OLIVES, AND NUTS; OLIVE PRODUCTS, NAMELY PROCESSED GREEK OLIVES, KALAMATA OLIVES, GREEN OLIVES, OIL-CURED OLIVES, AND OLIVE OIL (U.S. CL. 46).

JAMES GRIFFIN, EXAMINING ATTORNEY

SN 78-702,003. A & H PRODUCTS, INC., DBA ABELES & HEYMANN, BRONX, NY. FILED 8-28-2005.

Abeles & Heymann

THE MARK CONSISTS OF STANDARD CHARACTERS WITHOUT CLAIM TO ANY PARTICULAR FONT, STYLE, SIZE, OR COLOR.

THE NAMES SHOWN IN THE MARK DOES NOT IDENTIFY A PARTICULAR LIVING INDIVIDUAL.

SEC. 2(F).
FOR MEAT, FISH, POULTRY; MEAT EXTRACTS; PROCESSED MEAT AND MEAT PRODUCTS, NAMELY BEEF FRY, BOLOGNA, CERVELAT (A VARIETY OF SMOKED SAUSAGE), CORNED BEEF, FRANKFURTER, KNOCKWURST, LIVERWURST, PASTRAMI, SALAMI, SMOKED MEAT, BISON, JELLIES, JAMS, EGGS, EDIBLE OILS AND FATS (U.S. CL. 46).

FIRST USE 1-1-1955; IN COMMERCE 1-1-1955.
TRACY CROSS, EXAMINING ATTORNEY

CLASS 29—(Continued).

SN 78-716,392. PERDUE HOLDINGS, INC., WILMINGTON, DE. FILED 9-20-2005.



OWNER OF U.S. REG. NOS. 1,071,896 AND 2,565,144. THE MARK CONSISTS OF STYLIZED "OVEN STUFFER" WITH RIBBON DESIGN. FOR POULTRY; POULTRY, NAMELY, FRESH CHICKEN (U.S. CL. 46). FIRST USE 5-6-2005; IN COMMERCE 5-6-2005. JOHN SCHUYLER YARD, EXAMINING ATTORNEY

SN 78-727,327. NUU-CHAH-NULTH SHELLFISH DEVELOPMENT CORPORATION, QUALICUM BEACH, BRITISH COLUMBIA, CANADA, FILED 10-5-2005.

NOOTKA

THE MARK CONSISTS OF STANDARD CHARACTERS WITHOUT CLAIM TO ANY PARTICULAR FONT, STYLE, SIZE, OR COLOR. PRIORITY CLAIMED UNDER SEC. 44(D) ON CANADA APPLICATION NO. 1253113, FILED 4-6-2005, REG. NO. TMA668566, DATED 7-25-2006, EXPIRES 7-25-2021. FOR SEAFOOD (U.S. CL. 46). FIRST USE 11-24-2004; IN COMMERCE 8-31-2005. JENNY PARK, EXAMINING ATTORNEY

SN 78-754,480. CLINICAL PRODUCTS, LLC, NASHVILLE, TN. FILED 11-15-2005.

CONTROLBAR

THE MARK CONSISTS OF STANDARD CHARACTERS WITHOUT CLAIM TO ANY PARTICULAR FONT, STYLE, SIZE, OR COLOR. FOR PROTEIN BASED, NUTRIENT-DENSE SNACK BARS (U.S. CL. 46). FIRST USE 10-10-2003; IN COMMERCE 10-10-2003. MARC LEIPZIG, EXAMINING ATTORNEY

CLASS 29—(Continued).

SN 78-763,746. MOSKOWITZ, JOSEPH, SEARINGTOWN, NY. FILED 11-30-2005.

THINK SERRANO THINK REDONDO

THE MARK CONSISTS OF STANDARD CHARACTERS WITHOUT CLAIM TO ANY PARTICULAR FONT, STYLE, SIZE, OR COLOR.

THE ENGLISH TRANSLATION OF THE WORDS SERRANO AND REDONDO IN THE MARK ARE MOUNTAIN AND ROUND.

FOR PROCESSED MEATS (U.S. CL. 46). FIRST USE 11-6-2005; IN COMMERCE 11-6-2005. ANDREA K. NADELMAN, EXAMINING ATTORNEY

SN 78-785,979. AMERICAN EAGLE FOOD PRODUCTS INC., CEDAR GROVE, NJ. FILED 1-5-2006.

Sun Sational Snacks

THE MARK CONSISTS OF STANDARD CHARACTERS WITHOUT CLAIM TO ANY PARTICULAR FONT, STYLE, SIZE, OR COLOR.

NO CLAIM IS MADE TO THE EXCLUSIVE RIGHT TO USE "SNACKS", APART FROM THE MARK AS SHOWN.

FOR DEHYDRATED FRUIT SNACKS; DRIED FRUIT MIXES; DRIED FRUITS; PROCESSED EDIBLE SEEDS; PROCESSED NUTS; PROCESSED PUMPKIN SEEDS; ROASTED NUTS; SHELLED NUTS; SNACK MIX CONSISTING PRIMARILY OF PROCESSED FRUITS, PROCESSED NUTS AND/OR RAISINS (U.S. CL. 46). FIRST USE 12-1-2001; IN COMMERCE 6-21-2002. ARETHA SOMERVILLE, EXAMINING ATTORNEY

SN 78-789,621. TROPICAL NUT & FRUIT, INC., COLUMBUS, OH. FILED 1-11-2006.



THE COLOR GRAY IS INTENDED TO INDICATE SHADING OR CONTRAST ONLY.

THE MARK CONSISTS OF, IN PART, A DESIGN OF A PALM TREE SUPERIMPOSED OVER A CIRCULAR SUN, WITH THE STYLIZED WORD "TROPICAL" SUPERIMPOSED OVER THE PALM TREE AND SUN NEAR THE BOTTOM OF THE SUN. BENEATH THE PALM TREE/SUN

CLASS 29—(Continued).

IS A KETTLE WITH A HANDLE ATTACHED TO THE SIDES. THE HANDLE IS VERTICALLY EXTENDED TO FORM A HALF CIRCLE ABOVE THE KETTLE. THE TOP OF THE HALF CIRCLE FORMED BY THE HANDLE IS ECLIPSED BY THE PALM TREE/SUN PORTION OF THE DESIGN. THE STYLIZED WORDS "KETTLE COOKED" ARE SUPERIMPOSED OVER THE VERTICALLY EXTENDED HANDLE AND ARE POSITIONED BELOW THE PALM TREE/SUN AND ABOVE THE KETTLE. WITHIN THE KETTLE AND EMANATING THEREFROM IN VARIOUS DIRECTIONS ARE INDIVIDUAL PIECES OF SNACK FOOD.

FOR PROCESSED NUTS (U.S. CL. 46).
FIRST USE 2-27-2006; IN COMMERCE 3-13-2006.
SKYE YOUNG, EXAMINING ATTORNEY

SN 78-835,210. MAREBLU MANUFACTURER, INC., ANAHEIM, CA. FILED 3-12-2006.

MAREBLUNATURALS

THE MARK CONSISTS OF STANDARD CHARACTERS WITHOUT CLAIM TO ANY PARTICULAR FONT, STYLE, SIZE, OR COLOR.

FOR SNACKS IN FORM OF PROCESSED NUTS, NAMELY CLUSTERED ALMONDS, WALNUTS, PECANS, PEANUTS, CASHEWS, PINE NUTS, SUNFLOWER SEEDS, SESAME SEEDS, BLACK SESAME SEEDS, PUMPKINS SEEDS, MANGO AND PEANUTS MIX, APRICOT AND PEANUT MIX, NORI AND PEANUT MIX, AND COCONUT AND ALMOND MIX; SNACKS IN FORM OF CHOCOLATE MIXED WITH A VARIETY OF PROCESSED NUTS AND DRIED FRUITS (U.S. CL. 46).

FIRST USE 0-0-2005; IN COMMERCE 0-0-2005.
DAVID MURRAY, EXAMINING ATTORNEY

SN 78-839,919. ALEXIA FOODS, INC., BROOKLYN, NY. FILED 3-17-2006.

ALEXIA OVEN ROASTED

THE MARK CONSISTS OF STANDARD CHARACTERS WITHOUT CLAIM TO ANY PARTICULAR FONT, STYLE, SIZE, OR COLOR.

OWNER OF U.S. REG. NOS. 2,740,755, 2,843,522 AND OTHERS.

NO CLAIM IS MADE TO THE EXCLUSIVE RIGHT TO USE "OVEN ROASTED", APART FROM THE MARK AS SHOWN.

FOR PROCESSED POTATOES (U.S. CL. 46).
STEVEN PEREZ, EXAMINING ATTORNEY

CLASS 29—(Continued).

SN 78-840,108. MARQUEZ, JOSE R., MERRICK, NY. FILED 3-17-2006.

CATRACHO

THE MARK CONSISTS OF STANDARD CHARACTERS WITHOUT CLAIM TO ANY PARTICULAR FONT, STYLE, SIZE, OR COLOR.

THE ENGLISH TRANSLATION OF CATRACHO IS HONDURAN MALE.

FOR PROCESSED AND DRIED RED BEANS (U.S. CL. 46).

FIRST USE 4-30-2003; IN COMMERCE 4-30-2003.
DOMINIC J. FERRAIUOLO, EXAMINING ATTORNEY

SN 78-840,136. MARQUEZ, JOSE R., MERRICK, NY. FILED 3-17-2006.

ZAPOTITAN COSECHA NUEVA

THE MARK CONSISTS OF STANDARD CHARACTERS WITHOUT CLAIM TO ANY PARTICULAR FONT, STYLE, SIZE, OR COLOR.

NO CLAIM IS MADE TO THE EXCLUSIVE RIGHT TO USE "ZAPOTITAN", APART FROM THE MARK AS SHOWN.

THE FOREIGN WORDING IN THE MARK TRANSLATES INTO ENGLISH AS NEW HARVEST.

FOR PROCESSED AND DRIED RED BEANS (U.S. CL. 46).

FIRST USE 12-31-2005; IN COMMERCE 12-31-2005.
DOMINIC J. FERRAIUOLO, EXAMINING ATTORNEY

CLASS 29—(Continued).

SN 78-841,942. FOOD WITH CARE, INC., ORLANDO, FL.
FILED 3-21-2006.

FOOD WITH CARE

THE MARK CONSISTS OF STANDARD CHARACTERS WITHOUT CLAIM TO ANY PARTICULAR FONT, STYLE, SIZE, OR COLOR.

NO CLAIM IS MADE TO THE EXCLUSIVE RIGHT TO USE "FOOD", APART FROM THE MARK AS SHOWN.

FOR PACKAGED ENTREES AND MEALS CONSISTING PRIMARILY OF POULTRY, MEAT, AND FISH; PACKAGED ENTREES AND MEALS CONSISTING PRIMARILY OF POULTRY, MEAT, AND FISH, WITH NUTRITIONAL ENHANCEMENT; PACKAGED ENTREES AND MEALS CONSISTING PRIMARILY OF POULTRY, MEAT, AND FISH, WITH PREPARATION ACCORDING TO THE MEDICAL CONDITION OF THE CONSUMER; PACKAGED MEALS AND ENTREES CONSISTING PRIMARILY OF POULTRY, MEAT, AND FISH, AND COOKED VEGETABLES; PACKAGED MEALS AND ENTREES CONSISTING PRIMARILY OF POULTRY, MEAT, AND FISH, AND COOKED VEGETABLES, WITH NUTRITIONAL ENHANCEMENT; PACKAGED MEALS AND ENTREES CONSISTING PRIMARILY OF POULTRY, MEAT, AND FISH, AND COOKED VEGETABLES, WITH PREPARATION ACCORDING TO THE MEDICAL CONDITION OF THE CONSUMER; COOKED AND UNCOOKED POULTRY, MEAT, AND FISH, WITH NUTRITIONAL ENHANCEMENT; COOKED AND UNCOOKED POULTRY, MEAT, AND FISH, WITH PREPARATION ACCORDING TO THE MEDICAL CONDITION OF THE CONSUMER; FROZEN MEALS AND ENTREES CONSISTING PRIMARILY OF POULTRY, MEAT, AND FISH; FROZEN MEALS AND ENTREES CONSISTING PRIMARILY OF POULTRY, MEAT, AND FISH, WITH NUTRITIONAL ENHANCEMENT; AND FROZEN MEALS AND ENTREES CONSISTING PRIMARILY OF POULTRY, MEAT, AND FISH, WITH PREPARATION ACCORDING TO THE MEDICAL CONDITION OF THE CONSUMER (U.S. CL. 46).

FIRST USE 11-8-1995; IN COMMERCE 6-1-1997.
GRETTA YAO, EXAMINING ATTORNEY

SN 78-842,772. ALEXIA FOODS, INC., BROOKLYN, NY.
FILED 3-21-2006.

ALEXIA POTATO PUFFS

THE MARK CONSISTS OF STANDARD CHARACTERS WITHOUT CLAIM TO ANY PARTICULAR FONT, STYLE, SIZE, OR COLOR.

OWNER OF U.S. REG. NOS. 2,841,189, 3,136,842 AND OTHERS.

NO CLAIM IS MADE TO THE EXCLUSIVE RIGHT TO USE "POTATO PUFFS", APART FROM THE MARK AS SHOWN.

FOR POTATO BASED SNACK FOODS; POTATO PUFFS (U.S. CL. 46).

STEVEN PEREZ, EXAMINING ATTORNEY

CLASS 29—(Continued).

SN 78-847,594. RICH-SEAPAK, ST. SIMONS ISLAND, GA.
FILED 3-28-2006.

PLATEMAKERS

THE MARK CONSISTS OF STANDARD CHARACTERS WITHOUT CLAIM TO ANY PARTICULAR FONT, STYLE, SIZE, OR COLOR.

FOR FROZEN SHRIMP AND FROZEN SHRIMP ENTREES (U.S. CL. 46).

ROBERT STRUCK, EXAMINING ATTORNEY

SN 78-849,836. UNIVERSAL FOOD & BEVERAGE COMPANY, ST. CHARLES, IL. FILED 3-30-2006.

NATURE'S HEARTLAND

THE MARK CONSISTS OF STANDARD CHARACTERS WITHOUT CLAIM TO ANY PARTICULAR FONT, STYLE, SIZE, OR COLOR.

FOR DAIRY PRODUCTS, EXCLUDING ICE CREAM, ICE MILK AND FROZEN YOGURT. (U.S. CL. 46).

ANDREA SAUNDERS, EXAMINING ATTORNEY

SN 78-852,377. HENRY, BRIAN D. PAWLEYS ISLAND, SC. AND HENRY, NELSON C. PAWLEYS ISLAND, SC. FILED 4-3-2006.

Palmetto Cheese

THE MARK CONSISTS OF STANDARD CHARACTERS WITHOUT CLAIM TO ANY PARTICULAR FONT, STYLE, SIZE, OR COLOR.

NO CLAIM IS MADE TO THE EXCLUSIVE RIGHT TO USE CHEESE, APART FROM THE MARK AS SHOWN.

FOR PIMENTO CHEESE SPREAD (U.S. CL. 46).

JEFF DEFORD, EXAMINING ATTORNEY

CLASS 29—(Continued).

SN 78-855,886. ANG, PETER, VOORHEES, NJ. FILED 4-6-2006.

MEATROPOLIS

THE MARK CONSISTS OF STANDARD CHARACTERS WITHOUT CLAIM TO ANY PARTICULAR FONT, STYLE, SIZE, OR COLOR.

FOR BOTTLED COOKED MEAT; CANNED COOKED MEAT; CHOW MEIN; DRIED MEAT; FLAKES OF DRIED FISH MEAT (KÉZURI-BUSHI); FOOD PACKAGE COMBINATIONS CONSISTING PRIMARILY OF CHEESE, MEAT AND/OR PROCESSED FRUIT; FORMED TEXTURED VEGETABLE PROTEIN FOR USE AS A MEAT EXTENDER OR MEAT SUBSTITUTE; FORMED TEXTURED VEGETABLE PROTEIN TO BE USED AS AN EXTENDER OR MEAT SUBSTITUTE; FRANKFURTERS; FRIED MEAT; HAMBURGER; HOT DOGS; LUNCHEON MEATS; MEAT; MEAT BOILED DOWN IN SOY SAUCE (TSUKUDANI MEAT); MEAT EXTRACT; MEAT JELLIES; MEAT JUICES; MEAT PASTE; MEAT SUBSTITUTES; MEAT, FROZEN; MEAT-BASED MOUSSE; MEAT-BASED SPREADS; PREPARED MEAT; PROCESSED MEAT; PROCESSED MEAT, NAMELY, KIDNEYS; TEXTURED VEGETABLE PROTEIN FOR USE AS A MEAT EXTENDER; UNFORMED TEXTURED VEGETABLE PROTEIN FOR USE AS A MEAT EXTENDER (U.S. CL. 46).

WILLIAM BRECKENFELD, EXAMINING ATTORNEY

SN 78-856,646. MAPLE ISLAND, INC., NORTH ST. PAUL, MN. FILED 4-7-2006.

MILK STREAM

THE MARK CONSISTS OF STANDARD CHARACTERS WITHOUT CLAIM TO ANY PARTICULAR FONT, STYLE, SIZE, OR COLOR.

NO CLAIM IS MADE TO THE EXCLUSIVE RIGHT TO USE "MILK", APART FROM THE MARK AS SHOWN.

FOR POWDERED DAIRY-BASED BEVERAGE MIXES (U.S. CL. 46).

MARGARET POWER, EXAMINING ATTORNEY

CLASS 29—(Continued).

SN 78-857,093. FOSTER POULTRY FARMS, DBA FOSTER FARMS, LIVINGSTON, CA. FILED 4-7-2006.

FARM WISE ORGANICS

THE MARK CONSISTS OF STANDARD CHARACTERS WITHOUT CLAIM TO ANY PARTICULAR FONT, STYLE, SIZE, OR COLOR.

NO CLAIM IS MADE TO THE EXCLUSIVE RIGHT TO USE "FARM AND ORGANICS", APART FROM THE MARK AS SHOWN.

FOR FRESH AND FROZEN CHICKEN AND TURKEY (U.S. CL. 46).

KEVON CHISOLM, EXAMINING ATTORNEY

SN 78-857,348. GOODMAN, DANIEL STEVEN, DBA FARMERS ACRE FOOD COMPANY, INGLEWOOD, CA. FILED 4-9-2006.



FOR FROZEN, REFRIGERATED, READY TO EAT, AND PREPARED FOOD PRODUCTS, NAMELY, BEEF, PORK, CHICKEN, TURKEY, UNCOOKED HAMBURGER PATTIES, AND FROZEN, PRESERVED, DRIED, COOKED, AND GRILLED VEGETABLES (U.S. CL. 46).

FIRST USE 3-8-2006; IN COMMERCE 4-1-2006.

MICHAEL GAAFAR, EXAMINING ATTORNEY

SN 78-860,396. HORMAN, MICHAEL, MODESTO, CA. FILED 4-12-2006.

WESTERN SKY'S JERKY CO.

THE MARK CONSISTS OF STANDARD CHARACTERS WITHOUT CLAIM TO ANY PARTICULAR FONT, STYLE, SIZE, OR COLOR.

NO CLAIM IS MADE TO THE EXCLUSIVE RIGHT TO USE "JERKY CO.", APART FROM THE MARK AS SHOWN.

FOR JERKY (U.S. CL. 46).

FIRST USE 7-1-1997; IN COMMERCE 7-1-1997.

ELIZABETH PIGNATELLO, EXAMINING ATTORNEY

CLASS 29—(Continued).

SN 78-861,335. NOBLE HOUSE SEAFOODS, LLC, SAN PEDOR, CA. FILED 4-13-2006.

NOBLE HOUSE SEAFOODS

THE MARK CONSISTS OF STANDARD CHARACTERS WITHOUT CLAIM TO ANY PARTICULAR FONT, STYLE, SIZE, OR COLOR.

NO CLAIM IS MADE TO THE EXCLUSIVE RIGHT TO USE "SEAFOODS", APART FROM THE MARK AS SHOWN. FOR SHRIMP (U.S. CL. 46).
H. M. FISHER, EXAMINING ATTORNEY

SN 78-861,386. ADMIRALTY ISLAND FISHERIES, INC., DBA AQUA STAR, SEATTLE, WA. FILED 4-13-2006.

STAR CRACKED

THE MARK CONSISTS OF STANDARD CHARACTERS WITHOUT CLAIM TO ANY PARTICULAR FONT, STYLE, SIZE, OR COLOR.

FOR FROZEN SEAFOOD (U.S. CL. 46).
AISHA CLARKE, EXAMINING ATTORNEY

SN 78-861,400. ADMIRALTY ISLAND FISHERIES, INC., DBA AQUA STAR, SEATTLE, WA. FILED 4-13-2006.

STAR SPLIT

THE MARK CONSISTS OF STANDARD CHARACTERS WITHOUT CLAIM TO ANY PARTICULAR FONT, STYLE, SIZE, OR COLOR.

FOR FROZEN SEAFOOD (U.S. CL. 46).
AISHA CLARKE, EXAMINING ATTORNEY

SN 78-861,404. ADMIRALTY ISLAND FISHERIES, INC., DBA AQUA STAR, SEATTLE, WA. FILED 4-13-2006.

HEALTHY STAR

THE MARK CONSISTS OF STANDARD CHARACTERS WITHOUT CLAIM TO ANY PARTICULAR FONT, STYLE, SIZE, OR COLOR.

FOR FROZEN SEAFOOD (U.S. CL. 46).
AISHA CLARKE, EXAMINING ATTORNEY

CLASS 29—(Continued).

SN 78-861,948. CONAGRA FOODS PACKAGED FOODS COMPANY, INC., OMAHA, NE. FILED 4-14-2006.

SPIT RESPONSIBLY

THE MARK CONSISTS OF STANDARD CHARACTERS WITHOUT CLAIM TO ANY PARTICULAR FONT, STYLE, SIZE, OR COLOR.

FOR PROCESSED SUNFLOWER SEEDS (U.S. CL. 46).
FIRST USE 1-1-2005; IN COMMERCE 1-1-2005.
LINDA MICKLEBURGH, EXAMINING ATTORNEY

SN 78-862,971. 2 JERKS JERKY, SAN BERNARDINO, CA. FILED 4-17-2006.

2 JERKS Jerky

THE MARK CONSISTS OF STANDARD CHARACTERS WITHOUT CLAIM TO ANY PARTICULAR FONT, STYLE, SIZE, OR COLOR.

NO CLAIM IS MADE TO THE EXCLUSIVE RIGHT TO USE "JERKY", APART FROM THE MARK AS SHOWN.

FOR JERKY (U.S. CL. 46).
JESSICA A. POWERS, EXAMINING ATTORNEY

SN 78-863,073. MUSCO FOOD CORP., MASPETH, NY. FILED 4-17-2006.

SICURO'S

THE MARK CONSISTS OF STANDARD CHARACTERS WITHOUT CLAIM TO ANY PARTICULAR FONT, STYLE, SIZE, OR COLOR.

SEC. 2(F).
FOR CHEESE (U.S. CL. 46).
FIRST USE 0-0-1946; IN COMMERCE 0-0-1946.
JOHN WILKE, EXAMINING ATTORNEY

CLASS 29—(Continued).

SN 78-863,696. BURCON NUTRASCIENCE CORPORATION, VANCOUVER, B.C., CANADA, FILED 4-18-2006.

A NEW WORLD IN PROTEIN

THE MARK CONSISTS OF STANDARD CHARACTERS WITHOUT CLAIM TO ANY PARTICULAR FONT, STYLE, SIZE, OR COLOR.
 NO CLAIM IS MADE TO THE EXCLUSIVE RIGHT TO USE "PROTEIN", APART FROM THE MARK AS SHOWN.
 FOR PROTEIN FOR USE AS A FOOD INGREDIENT (U.S. CL. 46).
 NORA BUCHANAN WILL, EXAMINING ATTORNEY

SN 78-864,247. FRESNO COOPERATIVE RAISIN GROWERS, INC., FRESNO, CA. FILED 4-18-2006.

Try-Mor

THE MARK CONSISTS OF STANDARD CHARACTERS WITHOUT CLAIM TO ANY PARTICULAR FONT, STYLE, SIZE, OR COLOR.
 FOR RAISINS (U.S. CL. 46).
 FIRST USE 11-14-1951; IN COMMERCE 11-14-1951.
 NICHOLAS ALTREE, EXAMINING ATTORNEY

SN 78-865,978. MAPLE LEAF TECHNOLOGIES, INC., WILMINGTON, DE. FILED 4-20-2006.



NO CLAIM IS MADE TO THE EXCLUSIVE RIGHT TO USE "DUCK", APART FROM THE MARK AS SHOWN.
 FOR POULTRY, NAMELY, DUCKLING AND DUCK; DUCKLING AND DUCK PRODUCTS, NAMELY, DUCKLING AND DUCK MEAT (U.S. CL. 46).
 CYNTHIA SLOAN, EXAMINING ATTORNEY

CLASS 29—(Continued).

SN 78-866,481. MAPLE LEAF TECHNOLOGIES, INC., WILMINGTON, DE. FILED 4-21-2006.

MILFORD VALLEY FARMS

THE MARK CONSISTS OF STANDARD CHARACTERS WITHOUT CLAIM TO ANY PARTICULAR FONT, STYLE, SIZE, OR COLOR.
 NO CLAIM IS MADE TO THE EXCLUSIVE RIGHT TO USE "FARMS", APART FROM THE MARK AS SHOWN.
 FOR POULTRY, NAMELY, CHICKEN; CHICKEN PRODUCTS, NAMELY, CHICKEN MEAT (U.S. CL. 46).
 CYNTHIA SLOAN, EXAMINING ATTORNEY

SN 78-867,570. MCMAY, LLC, DBA WHOLE HOG CAFE, LITTLE ROCK, AR. FILED 4-23-2006.

It's all about the meat

THE MARK CONSISTS OF STANDARD CHARACTERS WITHOUT CLAIM TO ANY PARTICULAR FONT, STYLE, SIZE, OR COLOR.
 FOR BEEF; CHICKEN; CORNED BEEF; PORK; POULTRY, NAMELY, CHICKEN; PREPARED BEEF (U.S. CL. 46).
 JANICE KIM, EXAMINING ATTORNEY

SN 78-868,154. WHOLESOME & HEARTY FOODS COMPANY, IRVINE, CA. FILED 4-24-2006.

VEGGIE POWER

THE MARK CONSISTS OF STANDARD CHARACTERS WITHOUT CLAIM TO ANY PARTICULAR FONT, STYLE, SIZE, OR COLOR.
 NO CLAIM IS MADE TO THE EXCLUSIVE RIGHT TO USE "VEGGIE", APART FROM THE MARK AS SHOWN.
 FOR MEAT SUBSTITUTES (U.S. CL. 46).
 BERYL GARDNER, EXAMINING ATTORNEY

CLASS 29—(Continued).

SN 78-868,172. WHOLESOME & HEARTY FOODS COMPANY, IRVINE, CA. FILED 4-24-2006.

AIR VEGGIE

THE MARK CONSISTS OF STANDARD CHARACTERS WITHOUT CLAIM TO ANY PARTICULAR FONT, STYLE, SIZE, OR COLOR.

NO CLAIM IS MADE TO THE EXCLUSIVE RIGHT TO USE "VEGGIE", APART FROM THE MARK AS SHOWN. FOR MEAT SUBSTITUTES (U.S. CL. 46). BERYL GARDNER, EXAMINING ATTORNEY

SN 78-868,185. WHOLESOME & HEARTY FOODS COMPANY, IRVINE, CA. FILED 4-24-2006.

SERVE UP CHANGE

THE MARK CONSISTS OF STANDARD CHARACTERS WITHOUT CLAIM TO ANY PARTICULAR FONT, STYLE, SIZE, OR COLOR.

FOR MEAT SUBSTITUTES (U.S. CL. 46). BERYL GARDNER, EXAMINING ATTORNEY

SN 78-868,200. WHOLESOME & HEARTY FOODS COMPANY, IRVINE, CA. FILED 4-24-2006.

ACT POSITIVE

THE MARK CONSISTS OF STANDARD CHARACTERS WITHOUT CLAIM TO ANY PARTICULAR FONT, STYLE, SIZE, OR COLOR.

FOR MEAT SUBSTITUTES (U.S. CL. 46). BERYL GARDNER, EXAMINING ATTORNEY

CLASS 29—(Continued).

SN 78-868,206. WHOLESOME & HEARTY FOODS COMPANY, IRVINE, CA. FILED 4-24-2006.

GARDENSTEAK

THE MARK CONSISTS OF STANDARD CHARACTERS WITHOUT CLAIM TO ANY PARTICULAR FONT, STYLE, SIZE, OR COLOR.

OWNER OF U.S. REG. NOS. 1,409,666, 1,987,820 AND 2,182,470.

FOR MEAT SUBSTITUTES (U.S. CL. 46). BERYL GARDNER, EXAMINING ATTORNEY

SN 78-869,402. GALMAX INDUSTRIES, LLC, LAS VEGAS, NV. FILED 4-25-2006.



NO CLAIM IS MADE TO THE EXCLUSIVE RIGHT TO USE DOT COM, APART FROM THE MARK AS SHOWN.

THE MARK CONSISTS OF CROWN DESIGN CENTERED BETWEEN TWO HORIZONTAL WAVES OVER THE WORDS POKER KING. HORIZONTAL LINE AT BOTTOM WITH WORDS DOT COM IN CENTER OF LINE.

FOR FRUIT AND SOY BASED SNACK FOOD; PROTEIN BASED, NUTRIENT-DENSE SNACK BARS; SOY-BASED FOOD BARS; SOY-BASED SNACK FOODS (U.S. CL. 46).

TONJA GASKINS, EXAMINING ATTORNEY

SN 78-869,620. WILD BILL'S FOODS, INC., LANCASTER, PA. FILED 4-26-2006.

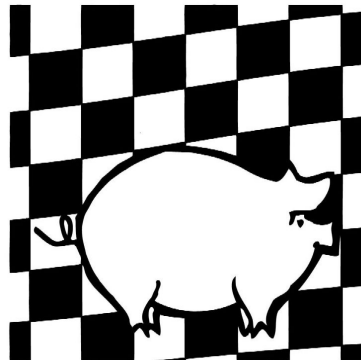

THE MARK CONSISTS OF A REPEATING CHECKERBOARD DESIGN THAT EXTENDS ACROSS THE PACKAGING FOR THE GOODS. THERE IS A TRANSPARENT PANEL IN THE SHAPE OF A PIG.

FOR SMOKED, DRIED, PULLED PORK (U.S. CL. 46). CHARLES L. JENKINS, EXAMINING ATTORNEY

CLASS 29—(Continued).

SN 78-869,621. WILD BILL'S FOODS, INC., LANCASTER, PA. FILED 4-26-2006.

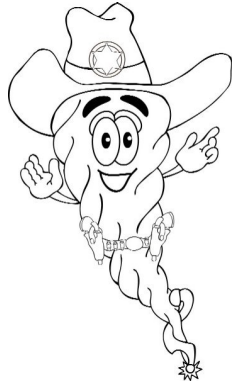

THE MARK CONSISTS OF A STYLIZED TORNADO DESIGN. THE TORNADO POSSESSES THE FOLLOWING CHARACTERISTICS: A SMILING FACE, ARMS WITH GLOVED HANDS, A COWBOY HAT WITH A SHERIFF'S STAR, A GUN BELT WITH TWO HOLSTERED PISTOLS, AND A SINGLE SPUR.

FOR MEAT SNACKS (U.S. CL. 46).
CHARLES L. JENKINS, EXAMINING ATTORNEY

SN 78-871,211. MEAD JOHNSON & COMPANY, EVANSVILLE, IN. FILED 4-27-2006.

INCREDIMILK

THE MARK CONSISTS OF STANDARD CHARACTERS WITHOUT CLAIM TO ANY PARTICULAR FONT, STYLE, SIZE, OR COLOR.

FOR MILK THAT IS NUTRITIONALLY ENHANCED AND MILK-BASED PRODUCTS THAT ARE NUTRITIONALLY ENHANCED, NAMELY, MILK-BASED BEVERAGES CONTAINING VITAMINS, MINERALS, FOOD, DIETARY, AND NUTRITIONAL SUPPLEMENTS (U.S. CL. 46).

MATTHEW MCDOWELL, EXAMINING ATTORNEY

CLASS 29—(Continued).

SN 78-871,767. MEAD JOHNSON & COMPANY, EVANSVILLE, IN. FILED 4-28-2006.

MILKTASTIC

THE MARK CONSISTS OF STANDARD CHARACTERS WITHOUT CLAIM TO ANY PARTICULAR FONT, STYLE, SIZE, OR COLOR.

FOR MILK THAT IS NUTRITIONALLY ENHANCED AND MILK-BASED PRODUCTS THAT ARE NUTRITIONALLY ENHANCED, NAMELY, MILK-BASED BEVERAGES CONTAINING VITAMINS, MINERALS, FOOD, DIETARY, AND NUTRITIONAL SUPPLEMENTS (U.S. CL. 46).

MATTHEW MCDOWELL, EXAMINING ATTORNEY

SN 78-871,770. MEAD JOHNSON & COMPANY, EVANSVILLE, IN. FILED 4-28-2006.

GROWSSENTIALS

THE MARK CONSISTS OF STANDARD CHARACTERS WITHOUT CLAIM TO ANY PARTICULAR FONT, STYLE, SIZE, OR COLOR.

FOR MILK THAT IS NUTRITIONALLY ENHANCED AND MILK-BASED PRODUCTS THAT ARE NUTRITIONALLY ENHANCED, NAMELY, MILK-BASED BEVERAGES CONTAINING VITAMINS, MINERALS, FOOD, DIETARY, AND NUTRITIONAL SUPPLEMENTS (U.S. CL. 46).

MATTHEW MCDOWELL, EXAMINING ATTORNEY

SN 78-871,776. MEAD JOHNSON & COMPANY, EVANSVILLE, IN. FILED 4-28-2006.

MILKSENTIALS

THE MARK CONSISTS OF STANDARD CHARACTERS WITHOUT CLAIM TO ANY PARTICULAR FONT, STYLE, SIZE, OR COLOR.

FOR MILK THAT IS NUTRITIONALLY ENHANCED AND MILK-BASED PRODUCTS THAT ARE NUTRITIONALLY ENHANCED, NAMELY, MILK-BASED BEVERAGES CONTAINING VITAMINS, MINERALS, FOOD, DIETARY, AND NUTRITIONAL SUPPLEMENTS (U.S. CL. 46).

MATTHEW MCDOWELL, EXAMINING ATTORNEY

CLASS 29—(Continued).

SN 78-883,814. HEALTHSIMPLE TOOLS, LLC, MINNEAPOLIS, MN. FILED 5-15-2006.

HEALTHSIMPLE

THE MARK CONSISTS OF STANDARD CHARACTERS WITHOUT CLAIM TO ANY PARTICULAR FONT, STYLE, SIZE, OR COLOR.

FOR FOOD PRODUCTS, NAMELY, MILK, MILK PRODUCTS EXCLUDING ICE CREAM, ICE MILK AND FROZEN YOGURT; CHEESE, COTTAGE CHEESE, YOGURT, EGGS, MEAT, FISH AND POULTRY; PROCESSED FRUITS AND PROCESSED VEGETABLES; JELLIES, JAMS, FRUIT SAUCES, NAMELY, CRANBERRY SAUCE AND APPLESAUCE; EDIBLE OILS AND FATS; NUTRITION BAR, NAMELY, PROTEIN BASED NUTRIENT-DENSE SNACK BARS; PACKAGED MEALS CONSISTING PRIMARILY OF MEAT, FISH, POULTRY OR VEGETABLES; FROZEN MEALS CONSISTING PRIMARILY OF MEAT, FISH, POULTRY OR VEGETABLE; SOUP, SOUP MIXES; FRUIT BASED SNACK FOODS, POTATO BASED SNACK FOODS, SOY BASED SNACK FOODS AND VEGETABLE BASED SNACK FOODS (U.S. CL. 46).

RUDY R. SINGLETON, EXAMINING ATTORNEY

SN 78-888,222. ODWALLA, INC., HALF MOON BAY, CA. FILED 5-19-2006.

MATCHA-LICIOUS

THE MARK CONSISTS OF STANDARD CHARACTERS WITHOUT CLAIM TO ANY PARTICULAR FONT, STYLE, SIZE, OR COLOR.

FOR SOYMILK BEVERAGES CONTAINING MATCHA GREEN TEA (U.S. CL. 46).

JOHN LINCOSKI, EXAMINING ATTORNEY

SN 78-892,518. SARA LEE CORPORATION, WINSTON-SALEM, NC. FILED 5-25-2006.



OWNER OF U.S. REG. NOS. 1,664,229, 1,813,074 AND OTHERS.

NO CLAIM IS MADE TO THE EXCLUSIVE RIGHT TO USE "SINCE 1944", APART FROM THE MARK AS SHOWN. FOR PROCESSED MEATS, NAMELY PORK, BEEF AND POULTRY (U.S. CL. 46).

FIRST USE 3-22-2006; IN COMMERCE 3-22-2006.

LEIGH LOWRY, EXAMINING ATTORNEY

CLASS 29—(Continued).

SN 78-912,027. QUANTUM FOODS, INC., BOLINGBROOK, IL. FILED 6-20-2006.

THE NEW TASTE OF TENDER

THE MARK CONSISTS OF STANDARD CHARACTERS WITHOUT CLAIM TO ANY PARTICULAR FONT, STYLE, SIZE, OR COLOR.

FOR PROCESSED MEATS, BEEF, PORK, POULTRY AND SEAFOOD SOLD IN PORTIONS (U.S. CL. 46).

MARK SPARACINO, EXAMINING ATTORNEY

SN 78-926,420. KRAFT FOODS HOLDINGS, INC., NORTHFIELD, IL. FILED 7-11-2006.



OWNER OF U.S. REG. NOS. 2,366,818, 2,437,332 AND OTHERS.

THE MARK CONSISTS OF ANTHROPOMORPHIZED PEANUT FIGURE FEATURING A TOP HAT, CANE AND MONOCLE.

FOR SHELLED NUTS (U.S. CL. 46).

FIRST USE 6-0-1916; IN COMMERCE 6-0-1916.

ROBERT LAVACHE, EXAMINING ATTORNEY

SN 78-927,618. CONAGRA FOODS PACKAGED FOODS COMPANY, INC., OMAHA, NE. FILED 7-12-2006.

SNACKTIVITY

THE MARK CONSISTS OF STANDARD CHARACTERS WITHOUT CLAIM TO ANY PARTICULAR FONT, STYLE, SIZE, OR COLOR.

FOR PROCESSED EDIBLE SEEDS, NAMELY SUNFLOWER SEEDS, SUNFLOWER KERNELS, AND PUMPKIN SEEDS (U.S. CL. 46).

LINDA MICKLEBURGH, EXAMINING ATTORNEY

CLASS 29—(Continued).

SN 78-976,518. BED BATH & BEYOND PROCUREMENT CO. INC., FARMINGDALE, NY. FILED 9-3-2004.

GIMMEE SNACKS!

THE MARK CONSISTS OF STANDARD CHARACTERS WITHOUT CLAIM TO ANY PARTICULAR FONT, STYLE, SIZE, OR COLOR.

NO CLAIM IS MADE TO THE EXCLUSIVE RIGHT TO USE "SNACKS", APART FROM THE MARK AS SHOWN.

FOR TRAIL MIX NAMELY SNACK MIXES PRIMARILY COMPOSED OF PROCESSED NUTS AND DRIED FRUIT WITH PRETZELS, CRACKERS, PROCESSED CEREAL, CHOCOLATE PIECES, CANDY PIECES, WHEAT-BASED CHIPS, CORN CHIPS, RYE-BASED CHIPS, BAGEL CHIPS, AND SNACK CHIPS, NAMELY POTATO CHIPS AND VEGETABLE CHIPS (U.S. CL. 46).

FIRST USE 6-6-2005; IN COMMERCE 6-6-2005.
MAUREEN DALL, EXAMINING ATTORNEY

SN 79-018,233. LIDL STIFTUNG & CO. KG, NECKARSULM, FED REP GERMANY, FILED 11-8-2005.

KASSALAS

THE MARK CONSISTS OF STANDARD CHARACTERS WITHOUT CLAIM TO ANY PARTICULAR FONT, STYLE, SIZE, OR COLOR.

PRIORITY DATE OF 5-19-2005 IS CLAIMED.

OWNER OF INTERNATIONAL REGISTRATION 0869669 DATED 11-8-2005, EXPIRES 11-8-2015.

FOR MILK AND MILK PRODUCTS, NAMELY, CHEESE, BUTTER, YOGURT, CREAM, CURD (U.S. CL. 46).

ANN E. SAPPENFIELD, EXAMINING ATTORNEY

CLASS 30—STAPLE FOODS

SN 76-189,598. SAKATA RICE SNACKS AUSTRALIA PTY LTD., LAVERTON NORTH, VICTORIA 3026, AUSTRALIA, FILED 1-4-2001.



SAKATA

FOR RICE SNACKS; RICE-BASED SNACK FOODS; RICE CRACKER BISCUITS; RICE PORRIDGE; FROZEN, PREPARED, AND PACKAGED ENTREES CONSISTING PRIMARILY OF RICE; FROZEN, PREPARED, AND PACKAGED MEALS CONSISTING PRIMARILY OF RICE; FLOUR; FLOUR-BASED CHIPS; GRAIN-BASED CHIPS; AND CEREAL-BASED SNACK FOODS, NAMELY, BREAD STICKS AND PRETZELS (U.S. CL. 46).

FIRST USE 0-0-2001; IN COMMERCE 0-0-2001.
DEBRA LEE, EXAMINING ATTORNEY

SN 76-334,974. MARY'S GOURMET INC., AURORA, ONTARIO, CANADA, FILED 11-6-2001.

Mary's
GOURMET

PRIORITY CLAIMED UNDER SEC. 44(D) ON CANADA APPLICATION NO. 1,102,393, FILED 5-7-2001, REG. NO. TMA605097, DATED 3-15-2004, EXPIRES 3-15-2019.

NO CLAIM IS MADE TO THE EXCLUSIVE RIGHT TO USE "GOURMET", APART FROM THE MARK AS SHOWN. FOR CONFECTIONS, NAMELY FLORENTINE CANDIES (U.S. CL. 46).

FIRST USE 7-0-2001; IN COMMERCE 7-0-2001.
DORITT L. CARROLL, EXAMINING ATTORNEY

SN 76-447,701. LA GUADALUPANA WHOLESALE CO., INC., CHICAGO, IL. FILED 9-6-2002.

LA LUPITA

FOR FROZEN MEXICAN FOOD, NAMELY, BURRITOS, TACOS, ENCHILADA, AND TAMALES (U.S. CL. 46).

FIRST USE 1-30-1995; IN COMMERCE 4-1-2000.
ANN E. SAPPENFIELD, EXAMINING ATTORNEY

CLASS 30—(Continued).

SN 76-644,050. TODINNO S.A.C., LIMA 15, PERU, FILED 8-2-2005.

¡CUÁNTA PASA, CUÁNTA FRUTA!

THE FOREIGN WORDING IN THE MARK TRANSLATES INTO ENGLISH AS MUCH RAISIN, MUCH FRUIT.

FOR PRODUCTS DERIVED FROM FLOUR, NAMELY PANETONNE, NOUGAT, SLICED BREAD, HAMBURGER AND HOTDOG ROLLS, FRUIT CAKES, STUFFED SPONGE CAKES WITH MARMALADE; PRODUCTS DERIVED FROM BATTERS, NAMELY POUND CAKES, CAKES AND TART; CONFECTIONARY FRUIT JELLIES (U.S. CL. 46).

FIRST USE 0-0-1980; IN COMMERCE 10-0-2003.
ESTHER A. BORSUK, EXAMINING ATTORNEY

CLASS 30—(Continued).

SN 76-653,038. LONG KOW BEAN THREAD MFG. CO., LTD., TAIPEI, TAIWAN, FILED 1-6-2006.



OWNER OF TAIWAN REG. NO. 413884, DATED 9-16-1988, EXPIRES 11-30-2015.

STIPPLING SHOWN IN THE DRAWINGS IS A FEATURE OF THE MARK.

THE MARK CONSISTS OF A DRAGON ON AN OVAL BACKGROUND WITH CHINESE SYMBOLS FOR "DRAGON'S MOUTH" ABOVE AND "LONG KOW" BELOW.

THE NON-LATIN CHARACTERS IN THE MARK TRANSLITERATE TO "LONG KOW," AND THIS MEANS "DRAGON'S MOUTH" IN ENGLISH.

FOR BEAN VERMICELLI, SHEET NOODLE MADE FROM BEAN, RICE NOODLES, NOODLES, STEAMED DUMPLINGS, INSTANT SPAGHETTI, INSTANT NOODLES, BEAN-STARCH NOODLES, SOMEN NOODLES, STUFFED THIN DUMPLINGS, WHEAT NOODLES, HAND-PULLED NOODLES, NOODLES MADE FROM BEANS, FRIED NOODLES, SHEET NOODLE MADE FROM RICE, FROZEN STEAMED DUMPLINGS, FROZEN STUFFED THIN DUMPLINGS, SPAGHETTI, INSTANT NOODLES WITH MINCED PORK, CHICKEN NOODLES, SLICED NOODLES, NOODLES WITH PORK SPARERIBS, BEEF NOODLES (U.S. CL. 46).

ANNE MADDEN, EXAMINING ATTORNEY

SN 76-645,375. THE SUGAR ASSOCIATION, INC., WASHINGTON, DC. FILED 8-18-2005.

**CANYON**

SN 76-654,036. CANYON SPECIALTY FOODS, INC., DALLAS, TX. FILED 1-24-2006.

THE MARK CONSISTS OF STANDARD CHARACTERS WITHOUT CLAIM TO ANY PARTICULAR FONT, STYLE, SIZE, OR COLOR.

OWNER OF U.S. REG. NO. 1,971,007.

FOR SAUCES, SALSA (U.S. CL. 46).

FIRST USE 10-0-1998; IN COMMERCE 10-0-1998.

ANN E. SAPPENFIELD, EXAMINING ATTORNEY

FOR SUGAR (U.S. CL. 46).
ROBIN CHOSID, EXAMINING ATTORNEY

CLASS 30—(Continued).

SN 76-654,796. KINGSTON-MIAMI TRADING CO., MIAMI, FL. FILED 2-7-2006.

CHEF PEARL CHUNG

THE MARK CONSISTS OF STANDARD CHARACTERS WITHOUT CLAIM TO ANY PARTICULAR FONT, STYLE, SIZE, OR COLOR.

THE NAME IN THE MARK DOES NOT IDENTIFY A LIVING INDIVIDUAL.

FOR SAUCES (U.S. CL. 46).

FIRST USE 12-0-1999; IN COMMERCE 12-0-1999.

WILLIAM P. SHANAHAN, EXAMINING ATTORNEY

CLASS 30—(Continued).

SN 78-523,920. MORINAGA & CO., LTD., TOKYO, JAPAN, FILED 11-29-2004.



OWNER OF U.S. REG. NO. 2,626,396.

NO CLAIM IS MADE TO THE EXCLUSIVE RIGHT TO USE "FRUIT CHEWS GRAPE", APART FROM THE MARK AS SHOWN.

THE COLOR(S) PURPLE, GREEN, BLUE, WHITE, VIOLET, RED, ORANGE, YELLOW IS/ARE CLAIMED AS A FEATURE OF THE MARK.

THE MARK CONSISTS OF A VIOLET RECTANGLE ON WHICH THE WORDS HI-CHEW APPEAR IN BLUE LETTERS WITH WHITE MARGINS OVER AN OVAL SHAPE SHADED IN YELLOW, RED, VIOLET AND ORANGE WITH WHITE BORDERS; NEXT TO THE WORDING HI-CHEW THERE ARE BUNCHES OF PURPLE GRAPES WITH GREEN LEAVES; UNDERNEATH THE WORDS HI-CHEW THE WORDS FRUIT CHEWS AND GRAPE APPEAR IN WHITE.

FOR BISCUITS; CHOCOLATE; CARAMEL; SNACKS, NAMELY, CEREAL BASED SNACKS; CANDY; CHEWING GUM; FROZEN CONFECTIONERIES; CAKE PASTE; COOKIE; NOUGAT (U.S. CL. 46).

SANI KHOURI, EXAMINING ATTORNEY

SN 78-367,782. RUSSELL STOVER CANDIES, INC., KANSAS CITY, MO. FILED 2-13-2004.

CALORIE OPTIONS

THE MARK CONSISTS OF STANDARD CHARACTERS WITHOUT CLAIM TO ANY PARTICULAR FONT, STYLE, SIZE, OR COLOR.

NO CLAIM IS MADE TO THE EXCLUSIVE RIGHT TO USE "CALORIE", APART FROM THE MARK AS SHOWN.

FOR REDUCED CALORIE CANDY AND FLAVORING SYRUP (U.S. CL. 46).

RONALD AIKENS, EXAMINING ATTORNEY

SN 78-523,925. MORINAGA & CO., LTD., TOKYO, JAPAN, FILED 11-29-2004.



OWNER OF U.S. REG. NO. 2,626,396.

NO CLAIM IS MADE TO THE EXCLUSIVE RIGHT TO USE "FRUIT CHEWS GREEN APPLE", APART FROM THE MARK AS SHOWN.

THE COLOR(S) GREEN, BLUE, WHITE, VIOLET, RED, ORANGE, YELLOW IS/ARE CLAIMED AS A FEATURE OF THE MARK.

THE MARK CONSISTS OF A GREEN RECTANGLE ON WHICH THE WORDS HI-CHEW APPEAR IN BLUE LETTERS WITH WHITE MARGINS OVER AN OVAL SHAPE SHADED IN YELLOW, RED, VIOLET AND ORANGE WITH WHITE BORDERS; NEXT TO THE WORDING HI-CHEW THERE ARE GREEN APPLES WITH GREEN LEAVES AND BROWN STEMS; UNDERNEATH THE WORDS HI-CHEW THE WORDS FRUIT CHEWS AND GREEN APPLE APPEAR IN WHITE.

FOR BISCUITS; CHOCOLATE; CARAMEL; SNACKS, NAMELY, CEREAL BASED SNACKS; CANDY; CHEWING GUM; FROZEN CONFECTIONERIES; CAKE PASTE; COOKIE; NOUGAT (U.S. CL. 46).

SANI KHOURI, EXAMINING ATTORNEY

CLASS 30—(Continued).

SN 78-603,377. SEI MEE TEA LLC, ENTERPRISE, OR. FILED 4-6-2005.

SEI MEE TEA

THE MARK CONSISTS OF STANDARD CHARACTERS WITHOUT CLAIM TO ANY PARTICULAR FONT, STYLE, SIZE, OR COLOR.

NO CLAIM IS MADE TO THE EXCLUSIVE RIGHT TO USE "TEA", APART FROM THE MARK AS SHOWN.

FOR GREEN TEA (U.S. CL. 46).

FIRST USE 11-1-2004; IN COMMERCE 11-1-2004.

ANN E. SAPPENFIELD, EXAMINING ATTORNEY

SN 78-604,519. LIN, HUI, SHENZHEN, CHINA, AND LIM, CHWOON ANG, HONG KONG, HONG KONG, FILED 4-8-2005.



FOR COFFEE; SOYA COFFEE; TEA; COCOA; ESPRESSO BEVERAGES; COFFEE SUBSTITUTES; COFFEE-BASED BEVERAGES; CHOCOLATE FOOD BEVERAGES NOT BEING DAIRY-BASED OR VEGETABLE BASED; COCOA-BASED BEVERAGES; SUGAR; PACKAGED PREPARED FOOD COMBINATIONS CONSISTING PRIMARILY OF BREAD, CRACKERS/AND OR COOKIES; SANDWICHES; MEAT PIES; PASTRIES; CAKES; MUFFINS; SCONES; PANCAKES; BREAD; BUNS; COOKIES; BISCUITS; WAFFLES; READY TO EAT, CEREAL DERIVED FOOD BARS; CHOCOLATE; ICE CREAM; FROZEN CONFECTIONS; BEVERAGES MADE OF TEA (U.S. CL. 46).

COLLEEN KEARNEY, EXAMINING ATTORNEY

CLASS 30—(Continued).

SN 78-611,518. BEIHOFF, DANIEL B., EAGLE RIVER, WI. FILED 4-19-2005.



NO CLAIM IS MADE TO THE EXCLUSIVE RIGHT TO USE "EAGLE RIVER ROASTERS" AND "SPECIALTY COFFEE & TEA", APART FROM THE MARK AS SHOWN.

THE MARK CONSISTS OF AN EAGLE HOLDING A COFFEE CUP WITH THE WORDS "EAGLE RIVER ROASTERS" ABOVE IT AND THE WORDS "SPECIALTY COFFEE & TEA" BELOW IT.

FOR COFFEE AND TEA (U.S. CL. 46).

FIRST USE 7-15-2004; IN COMMERCE 7-15-2004.

MONIQUE MILLER, EXAMINING ATTORNEY

SN 78-653,510. TANDOI FILIPPO E ADALBERTO F.LLI S.R.L., CORATO (BA), ITALY, FILED 6-17-2005.

SOLOGRANO

THE COLOR(S) GREEN, WHITE, AND RED IS/ARE CLAIMED AS A FEATURE OF THE MARK.

THE MARK CONSISTS OF THE COLORS GREEN, WHITE AND RED APPEARING IN ORDER IN THE DESIGN CONSISTING OF THREE HORIZONTAL RIBBON SHAPED BOXES, AND THE COLOR GREEN APPEARS IN THE WORDING SOLOGRANO.

FOR FLOUR, PASTA, SPAGHETTI; CRACKERS; BREAD, ROLLS, BUNS; PASTRIES, BISCUITS, PIES; PIZZA (U.S. CL. 46).

JENNIFER KRISP, EXAMINING ATTORNEY

SN 78-667,368. NOBLE, PATRICK PETER, LAUDERDALE-BY-THE-SEA, FL. FILED 7-11-2005.

JAMAICAN BLUE CREAM COFFEE

THE MARK CONSISTS OF STANDARD CHARACTERS WITHOUT CLAIM TO ANY PARTICULAR FONT, STYLE, SIZE, OR COLOR.

NO CLAIM IS MADE TO THE EXCLUSIVE RIGHT TO USE "JAMAICAN" AND "CREAM COFFEE", APART FROM THE MARK AS SHOWN.

FOR COFFEE; FLAVORED COFFEE; COFFEE AND ESPRESSO BEVERAGES, BEVERAGES MADE WITH A BASE OF COFFEE AND/OR ESPRESSO, READY-TO-DRINK COFFEE (U.S. CL. 46).

FIRST USE 6-15-2005; IN COMMERCE 6-15-2005.

YONG KIM, EXAMINING ATTORNEY

CLASS 30—(Continued).

SN 78-667,432. TSAI'S INTERNATIONAL TRADE CORPORATION, LIVERMORE, CA. FILED 7-11-2005.



FOR ROASTED COFFEE, POWDERED COFFEE, GRANULATED COFFEE, COFFEE IN DRINKS; COFFEE BEANS, INSTANT COFFEE, PREPARED COFFEE AND COFFEE-BASED BEVERAGES (U.S. CL. 46).

FIRST USE 1-15-2005; IN COMMERCE 1-15-2005.
ROBERT C. CLARK JR., EXAMINING ATTORNEY

SN 78-692,717. APA INTERNATIONAL, LLC, NEW YORK, NY. FILED 8-15-2005.

CAFÉ SKINNY

THE MARK CONSISTS OF STANDARD CHARACTERS WITHOUT CLAIM TO ANY PARTICULAR FONT, STYLE, SIZE, OR COLOR.

NO CLAIM IS MADE TO THE EXCLUSIVE RIGHT TO USE CAFÉ, APART FROM THE MARK AS SHOWN.

FOR ROASTED COFFEE (U.S. CL. 46).
TINA L. SNAPP, EXAMINING ATTORNEY

SN 78-703,230. REALLY RAW HONEY, INC., BALTIMORE, MD. FILED 8-30-2005.

**REALLY RAW HONEY BUZZER!!
GET YOUR BUZZ RIGHT NOW!**

THE MARK CONSISTS OF STANDARD CHARACTERS WITHOUT CLAIM TO ANY PARTICULAR FONT, STYLE, SIZE, OR COLOR.

OWNER OF U.S. REG. NO. 1,874,053.

NO CLAIM IS MADE TO THE EXCLUSIVE RIGHT TO USE "REALLY RAW HONEY", APART FROM THE MARK AS SHOWN.

FOR HONEY IN PORTABLE CONTAINERS (U.S. CL. 46).

FIRST USE 9-1-2004; IN COMMERCE 9-1-2004.
ESTHER A. BORSUK, EXAMINING ATTORNEY

CLASS 30—(Continued).

SN 78-705,375. KING'S COUNTRY SHOPPES, INC., DBA KING'S FAMILY RESTAURANTS, MCKEESPORT, PA. FILED 9-1-2005.



FOR BROWNIES FEATURING A FROWNING FACE DESIGN SOLD IN RESTAURANTS FOR CONSUMPTION ON AND OFF PREMISES; BROWNIE ICE CREAM SUNDAES COMPRISING BROWNIES, ICE CREAM AND HOT FUDGE (U.S. CL. 46).

FIRST USE 7-21-2005; IN COMMERCE 7-21-2005.
SONYA STEPHENS, EXAMINING ATTORNEY

SN 78-706,868. NAKATOMI, JUDY A., LEUCADIA, CA. FILED 9-5-2005.

Kanaya Fine Tea

THE MARK CONSISTS OF STANDARD CHARACTERS WITHOUT CLAIM TO ANY PARTICULAR FONT, STYLE, SIZE, OR COLOR.

NO CLAIM IS MADE TO THE EXCLUSIVE RIGHT TO USE "FINE TEA", APART FROM THE MARK AS SHOWN.

THE ENGLISH TRANSLATION OF THE WORD KANAYA IN THE MARK IS "GOLDEN VALLEY".

FOR JAPANESE GREEN TEA (U.S. CL. 46).
TINA L. SNAPP, EXAMINING ATTORNEY

SN 78-707,201. PINNACLE FOODS GROUP INC., MOUNTAIN LAKES, NJ. FILED 9-6-2005.

MAGIC STICKS

THE MARK CONSISTS OF STANDARD CHARACTERS WITHOUT CLAIM TO ANY PARTICULAR FONT, STYLE, SIZE, OR COLOR.

NO CLAIM IS MADE TO THE EXCLUSIVE RIGHT TO USE "STICKS", APART FROM THE MARK AS SHOWN.

FOR FROZEN MEALS CONSISTING PRIMARILY OF FRENCH TOAST; FROZEN FRENCH TOAST (U.S. CL. 46).

TRACY CROSS, EXAMINING ATTORNEY

CLASS 30—(Continued).

SN 78-715,716. SOCIETE DES PRODUITS NESTLE, S.A., 1800 VEVEY, SWITZERLAND, FILED 9-19-2005.



FOR ICE CREAM, REDUCED FAT, LOW FAT AND FAT FREE ICE CREAM; ICE CREAM CONFECTIONS; ICE CREAM NOVELTIES; FROZEN DAIRY AND NON-DAIRY NOVELTIES, NAMELY, FROZEN DAIRY AND NON-DAIRY CONFECTIONS; ICE MILK; SORBETS; SHERBETS; FROZEN YOGURT; FAT FREE FROZEN YOGURT (U.S. CL. 46).

ANDREW RHIM, EXAMINING ATTORNEY

CLASS 30—(Continued).

SN 78-725,628. D.M.C. SRL, SAN VENDEMIANO (TV), ITALY, FILED 10-3-2005.



MANUEL
Caffé

NO CLAIM IS MADE TO THE EXCLUSIVE RIGHT TO USE "CAFFE", APART FROM THE MARK AS SHOWN. THE FOREIGN WORDING IN THE MARK TRANSLATES INTO ENGLISH AS CAFE.

FOR COFFEE (U.S. CL. 46).

FIRST USE 0-0-1975; IN COMMERCE 3-0-2004.

SANI KHOURI, EXAMINING ATTORNEY

SN 78-735,721. MORRIS NATIONAL, INC., AZUSA, CA. FILED 10-18-2005.

SN 78-717,779. LIQUID GOLD CORP., STUART, FL. FILED 9-21-2005.

Poli Tea



NO CLAIM IS MADE TO THE EXCLUSIVE RIGHT TO USE "THE JELLY CANDY FACTORY", APART FROM THE MARK AS SHOWN.

THE COLOR(S) RED, WHITE, BLUE, BROWN AND WOOD-GRAIN IS/ARE CLAIMED AS A FEATURE OF THE MARK.

THE MARK CONSISTS OF THE WORDS THE AND CANDY FACTORY IN WHITE ON A BLUE BACKGROUND; THE TERM JELLY IS IN RED; THE SIGN IS WOOD-GRAIN COLORED WITH A BROWN BORDER.

FOR CANDY (U.S. CL. 46).

FIRST USE 3-30-2004; IN COMMERCE 5-27-2004.

RONALD MCMORROW, EXAMINING ATTORNEY

THE MARK CONSISTS OF STANDARD CHARACTERS WITHOUT CLAIM TO ANY PARTICULAR FONT, STYLE, SIZE, OR COLOR.

NO CLAIM IS MADE TO THE EXCLUSIVE RIGHT TO USE "TEA", APART FROM THE MARK AS SHOWN.

FOR TEA FOR FOOD PURPOSES WITH SUGAR CANE AND NATURALLY OCCURRING POLICOSANOLS (U.S. CL. 46).

KATHLEEN M. VANSTON, EXAMINING ATTORNEY

CLASS 30—(Continued).

SN 78-770,504. SUN GARDEN-GANGI CANNING COMPANY, LLC, ATWATER, CA. FILED 12-9-2005.

EMILIO'S

THE MARK CONSISTS OF STANDARD CHARACTERS WITHOUT CLAIM TO ANY PARTICULAR FONT, STYLE, SIZE, OR COLOR.

"THE NAME(S), PORTRAIT(S), AND/OR SIGNATURE(S) SHOWN IN THE MARK DOES NOT IDENTIFY A PARTICULAR LIVING INDIVIDUAL."

FOR CANNED HOLLANDAISE SAUCE (U.S. CL. 46).
FIRST USE 11-30-1949; IN COMMERCE 11-30-1949.
BILL DAWE, EXAMINING ATTORNEY

SN 78-770,548. SUN GARDEN-GANGI CANNING COMPANY, LLC, ATWATER, CA. FILED 12-9-2005.

AUNT PENNY'S

THE MARK CONSISTS OF STANDARD CHARACTERS WITHOUT CLAIM TO ANY PARTICULAR FONT, STYLE, SIZE, OR COLOR.

"THE NAME(S), PORTRAIT(S), AND/OR SIGNATURE(S) SHOWN IN THE MARK DOES NOT IDENTIFY A PARTICULAR LIVING INDIVIDUAL."

FOR CANNED WHITE SAUCE, CANNED CHEESE SAUCE AND CANNED HOLLANDAISE SAUCE (U.S. CL. 46).

FIRST USE 3-23-1942; IN COMMERCE 3-23-1942.
BILL DAWE, EXAMINING ATTORNEY

SN 78-793,925. FERDINANDO GIORDANO S.P.A., 12050 VALLE TALLORIA DI DIANO D'ALBA, ITALY, FILED 1-18-2006.

GIORDANO

THE MARK CONSISTS OF STANDARD CHARACTERS WITHOUT CLAIM TO ANY PARTICULAR FONT, STYLE, SIZE, OR COLOR.

FOR DURUM WHEAT SEMOLINA PASTA, ALMOND BISCUITS NAMELY CANTUCCI; SAUCES MADE OF BASIL; BALSAMIC VINEGAR (U.S. CL. 46).

FIRST USE 2-0-2006; IN COMMERCE 2-0-2006.
SHARI SHEFFIELD, EXAMINING ATTORNEY

CLASS 30—(Continued).

SN 78-803,820. OLSEN, FAWN, WEISER, ID. FILED 1-31-2006.



NO CLAIM IS MADE TO THE EXCLUSIVE RIGHT TO USE "CLASSIC CANDIES" AND "GOURMET CHOCOLATES & CANDIES HANDMADE IN WEISER, IDAHO 83672", APART FROM THE MARK AS SHOWN.

FOR HAND MADE CANDIES AND CHOCOLATES (U.S. CL. 46).

FIRST USE 10-24-1986; IN COMMERCE 10-24-1986.
TIMOTHY FINNEGAN, EXAMINING ATTORNEY

SN 78-805,005. HILL, C. G., ERIE, CO. FILED 2-2-2006.

Something Better Sauce

THE MARK CONSISTS OF STANDARD CHARACTERS WITHOUT CLAIM TO ANY PARTICULAR FONT, STYLE, SIZE, OR COLOR.

NO CLAIM IS MADE TO THE EXCLUSIVE RIGHT TO USE "SAUCE", APART FROM THE MARK AS SHOWN.

FOR FOOD SAUCE, NAMELY, SAUCE FOR MEATS, MAYONNAISE, SALAD DRESSINGS, MUSTARD (U.S. CL. 46).

ANDREW RHIM, EXAMINING ATTORNEY

SN 78-816,073. THE QUAKER OATS COMPANY, CHICAGO, IL. FILED 2-16-2006.

TODDYNHO

THE MARK CONSISTS OF STANDARD CHARACTERS WITHOUT CLAIM TO ANY PARTICULAR FONT, STYLE, SIZE, OR COLOR.

FOR CHOCOLATE FLAVORED BEVERAGES NOT BEING DAIRY-BASED OR VEGETABLE BASED (U.S. CL. 46).

FIRST USE 2-10-2001; IN COMMERCE 2-10-2001.
DAWN HAN, EXAMINING ATTORNEY

CLASS 30—(Continued).

SN 78-819,170. BRANDMARK, LLC, LAKELAND, TN. FILED 2-20-2006.

DEVILICIOUS

THE MARK CONSISTS OF STANDARD CHARACTERS WITHOUT CLAIM TO ANY PARTICULAR FONT, STYLE, SIZE, OR COLOR.

FOR CHOCOLATE; CANDIES; CHOCOLATE TRUFFLES; COCOA; COCOA-BASED BEVERAGES CONTAINING MILK; COCOA POWDERS AND CONCENTRATES FOR THE MIXING OF DRINKS; COCOA EXTRACTS FOR HUMAN CONSUMPTION; CHOCOLATE-BASED BEVERAGES NOT BEING DAIRY-BASED OR VEGETABLE-BASED; SUGAR; RICE; TAPIOCA; SAGO; HONEY; TREACLE; YEAST; BAKING POWDER; FLOUR; BREAD; BAKERY PRODUCTS; CAKES; SNACK CAKES; MUFFINS; SCONES; PUDDING; CREAM-FILLED BAKERY PRODUCTS; BREAD ROLLS; FUDGE; TARTS; PIES; MOUSSE CONFECTIONS; FLAVORED CUSTARD; ICE CREAMS AND FROZEN CONFECTIONS; ICING; ICES; WAFFLES; FROZEN YOGURT; MILKSHAKES; SHERBET; POPCORN; PASTRIES; CONFECTIONERIES, NAMELY, CANDY AND GUM; SWEETS AND SNACKS, NAMELY, BISCUITS, BROWNIES, BUTTER BISCUITS, BUNS, COOKIES, CREAM-FILLED COOKIES, BONBONS, BUBBLE GUM, CANDIES, CHOCOLATE AND CHOCOLATE CANDIES, CHOCOLATE BARS, CANDY MINTS, CARAMEL CANDIES, COCOA CANDIES, AND GRANOLA-BASED SNACK BARS; CEREAL-BASED SNACK BARS; PRODUCTS FOR FLAVORING OR SEASONING FOODSTUFFS, NAMELY, FLAVORINGS AND SEASONINGS FOR NON-NUTRITIONAL PURPOSES; COFFEE; COFFEE BEANS; GROUND COFFEE BEANS; ROASTED COFFEE BEANS; COFFEE-BASED BEVERAGES; ARTIFICIAL COFFEE; COFFEE SUBSTITUTES AND SWEETENERS; AND ESPRESSO (U.S. CL. 46).

MYRIAH HABEEB, EXAMINING ATTORNEY

SN 78-819,988. FINE COCOA PRODUCTS CORPORATION, SOUTH HACKENSACK, NJ. FILED 2-21-2006.



NO CLAIM IS MADE TO THE EXCLUSIVE RIGHT TO USE "ORGANIC" AND "COCOA", APART FROM THE MARK AS SHOWN.

FOR COCOA, COCOA ROASTED, POWDERED, GRANULATED, OR IN DRINKS, COCOA-BASED INGREDIENTS IN CONFECTIONERY PRODUCTS, CHOCOLATE, CHOCOLATE PASTE, CHOCOLATE BARS, CHOCOLATE POWDER, MILK CHOCOLATE, COCOA MIXES (U.S. CL. 46).

CATHERINE FAINT, EXAMINING ATTORNEY

CLASS 30—(Continued).

SN 78-823,199. CAMERON, GORDON, A., WASHINGTON, DC. FILED 2-24-2006.

Capitol Punishment

THE MARK CONSISTS OF STANDARD CHARACTERS WITHOUT CLAIM TO ANY PARTICULAR FONT, STYLE, SIZE, OR COLOR.

FOR BARBECUE SAUCE; CHILI SAUCE; DRY SEASONING MIXES FOR MEATS, POULTRY, SEAFOOD; HOT SAUCE; SALSA; SAUCES FOR BARBECUED MEAT (U.S. CL. 46).

FIRST USE 1-22-2006; IN COMMERCE 2-7-2006.

SUNG IN, EXAMINING ATTORNEY

SN 78-826,792. TROPICAL FOODS COMPANY, INC., COWPENS, SC. FILED 3-1-2006.



THE MARK CONSISTS OF TWO HUMAN FIGURES, ONE KNEELING AND ONE STANDING WITH A LONG STICK PASSING THROUGH BOTH HANDS. BETWEEN THE TWO FIGURES IS A MEDIUM SIZE BOWL OR CONTAINER OF WHICH THE TWO FIGURES APPEAR TO BE WORKING IN. SURROUNDING THE TWO HUMAN FIGURES AND THE BOWL IS A MORE THAN SEMI CIRCLE BORDER. BELOW THE FIGURES AND ATTACHED TO THE MORE THAN SEMI CIRCLE BORDER IS THE WORD "TROIWAY" WHICH IS CONTAINED IN A ENCLOSED RETANGLUAR SHAPE.

FOR FLOUR FOR FOOD, FLOUR FOR MAKING DUMPLINGS OF GLUTINOUS RICE, TAPIOCA FLOUR FOR FOOD, POTATO FLOUR FOR FOOD, PLANTAIN FUFU FLOUR FOR FOOD, COCOYAM FUFU FLOUR FOR FOOD, CORN MEAL FOR FOOD, YAM FLOUR FOR FOOD (U.S. CL. 46).

FIRST USE 12-13-1986; IN COMMERCE 4-15-1987.

LAURIE KAUFMAN, EXAMINING ATTORNEY

CLASS 30—(Continued).

SN 78-838,795. MARKER, JOHN C., LOUISVILLE, KY. FILED 3-16-2006.

KENTUCKY HORSE DROPPINGS

THE MARK CONSISTS OF STANDARD CHARACTERS WITHOUT CLAIM TO ANY PARTICULAR FONT, STYLE, SIZE, OR COLOR.

NO CLAIM IS MADE TO THE EXCLUSIVE RIGHT TO USE "KENTUCKY", APART FROM THE MARK AS SHOWN.

FOR CANDY; CHOCOLATE CANDIES (U.S. CL. 46).
SEAN CROWLEY, EXAMINING ATTORNEY

SN 78-846,650. BENHAM, ROGER, SAN DIEGO, CA. FILED 3-27-2006.

RICE WITH ATTITUDE

THE MARK CONSISTS OF STANDARD CHARACTERS WITHOUT CLAIM TO ANY PARTICULAR FONT, STYLE, SIZE, OR COLOR.

NO CLAIM IS MADE TO THE EXCLUSIVE RIGHT TO USE "RICE", APART FROM THE MARK AS SHOWN.

FOR SPECIALLY PREPARED FOODS FOR CONSUMPTION ON OR OFF THE PREMISES, NAMELY SUSHI, RICE BALLS, RICE ROLLS, RICE CROQUETS, WHEAT-FLOUR CROQUETS, OAT CROQUETS, CORN CROQUETS, POTATO CROQUETS, RICE, PIES, GRAIN BASED, CHOCOLATE BASED, OAT BASED AND GRANOLA BASED READY TO EAT FOOD BARS, CEREAL BASED SNACK FOODS, RICE BASED SNACK FOODS, CORN BASED SNACK FOODS, BAKERY GOODS, PASTRIES, WHEAT BASED CRACKERS, TOASTED CORN SNACKS, CORN CHIPS, GRAIN BASED CHIPS, BISCUITS, CANDY, PUFFED CORN SNACKS, PUFFED RICE SNACKS, BAGELS, BRAN, BREAD, BREAD STICKS, BREAKFAST CEREALS, CAKES, DOUGH, AND PRETZELS (U.S. CL. 46).

KATHERINE STOIDES, EXAMINING ATTORNEY

CLASS 30—(Continued).

SN 78-849,742. CADBURY LIMITED, BIRMINGHAM, UNITED KINGDOM, FILED 3-30-2006.

CREME EGG

THE MARK CONSISTS OF STANDARD CHARACTERS WITHOUT CLAIM TO ANY PARTICULAR FONT, STYLE, SIZE, OR COLOR.

OWNER OF UNITED KINGDOM REG. NO. 1581339, DATED 10-31-1994, EXPIRES 10-31-2014.

OWNER OF U.S. REG. NO. 1,525,984.

SEC. 2(F).

FOR CHOCOLATE CONFECTIONERY; CHOCOLATE CONFECTIONERY CONTAINING FONDANT AND BEING EGG SHAPED (U.S. CL. 46).

FIRST USE 1-7-1980; IN COMMERCE 1-7-1980.

DEIRDRE ROBERTSON, EXAMINING ATTORNEY

SN 78-849,841. LOAFFERS LLC, WALLA WALLA, WA. FILED 3-30-2006.

NEVER YESTERDAY'S BREAD

THE MARK CONSISTS OF STANDARD CHARACTERS WITHOUT CLAIM TO ANY PARTICULAR FONT, STYLE, SIZE, OR COLOR.

NO CLAIM IS MADE TO THE EXCLUSIVE RIGHT TO USE "BREAD", APART FROM THE MARK AS SHOWN.

FOR BAGELS, BAGUETTES, BAKERY GOODS, BREAD, BUNS, BREAD ROLLS, BREAD STICKS, COOKIES, CROISSANTS, PITA BREAD (U.S. CL. 46).

SETH A. RAPPAPORT, EXAMINING ATTORNEY

SN 78-850,899. JARDINE FOODS, INC., BUDA, TX. FILED 3-31-2006.

FRESH & FEISTY

THE MARK CONSISTS OF STANDARD CHARACTERS WITHOUT CLAIM TO ANY PARTICULAR FONT, STYLE, SIZE, OR COLOR.

NO CLAIM IS MADE TO THE EXCLUSIVE RIGHT TO USE "FRESH", APART FROM THE MARK AS SHOWN.

FOR SALSA (U.S. CL. 46).

FIRST USE 3-0-2006; IN COMMERCE 3-0-2006.

MARLENE BELL, EXAMINING ATTORNEY

CLASS 30—(Continued).

SN 78-852,583. MAZZOCCA, MAFALDA, SEWELL, NJ.
FILED 4-3-2006.

GOURMET VENETIAN BAGELS

THE MARK CONSISTS OF STANDARD CHARACTERS WITHOUT CLAIM TO ANY PARTICULAR FONT, STYLE, SIZE, OR COLOR.

NO CLAIM IS MADE TO THE EXCLUSIVE RIGHT TO USE "GOURMET OR BAGELS", APART FROM THE MARK AS SHOWN.

FOR BAGELS (U.S. CL. 46).

DAVID H. STINE, EXAMINING ATTORNEY

SN 78-853,934. KISSAN RICE MILLS, TARAORI, DIST.
KARNAL, INDIA, FILED 4-4-2006.



FOR PROCESSED GRAINS; PROCESSED WHEAT; RICE; DESSERTS, NAMELY, BAKERY DESSERTS AND DAIRY-BASED DESSERTS, NAMELY, CHILLED OR WARM CAKE OR DUMPLING HAVING A MILK-BASED FILLING; FLOUR; SAUCES; CHUTNEY; BAKERY GOODS; BISCUITS; COOKIES; SPICES; BREAD; FROZEN AND PREPARED MEALS CONSISTING PRIMARILY OF PASTA AND RICE (U.S. CL. 46).

TRACY CROSS, EXAMINING ATTORNEY

SN 78-855,063. SAVAGE, COLETTE, LOS ANGELES, CA.
FILED 4-5-2006.

BLACKBERRY POND TEA COMPANY

THE MARK CONSISTS OF STANDARD CHARACTERS WITHOUT CLAIM TO ANY PARTICULAR FONT, STYLE, SIZE, OR COLOR.

NO CLAIM IS MADE TO THE EXCLUSIVE RIGHT TO USE "BLACKBERRY" AND "TEA COMPANY", APART FROM THE MARK AS SHOWN.

FOR ORGANIC TEA, COFFEE, AND GIFT BASKETS CONTAINING TEA AND COFFEE (U.S. CL. 46).

FIRST USE 1-1-1999; IN COMMERCE 1-1-1999.

JASON TURNER, EXAMINING ATTORNEY

CLASS 30—(Continued).

SN 78-855,367. FRITO-LAY NORTH AMERICA, INC., PLANO, TX. FILED 4-6-2006.

MONCHOS

THE MARK CONSISTS OF STANDARD CHARACTERS WITHOUT CLAIM TO ANY PARTICULAR FONT, STYLE, SIZE, OR COLOR.

OWNER OF U.S. REG. NO. 765,613.

FOR COOKIES (U.S. CL. 46).

FRANK LATTUCA, EXAMINING ATTORNEY

SN 78-855,449. UNIFARMED S.N.C., ADRANO (CT) 95031,
ITALY, FILED 4-6-2006.



THE COLOR(S) YELLOW, GOLD, RED, BLUE AND WHITE IS/ARE CLAIMS AS A FEATURE OF THE MARK.

THE MARK CONSISTS OF THE STYLIZED RED WORD 'VIDAFREE' SURROUNDED BY A BLUE AND WHITE OVAL SHAPE THROUGH WHICH A GOLD SMILING SUN BURSTS, ALL AGAINST A SQUARE YELLOW BACKGROUND.

THE FOREIGN WORDING IN THE MARK TRANSLATES INTO ENGLISH AS LIFE.

FOR BISCUITS; BREAD; BREAD AND BUNS; PASTA; PASTA SHELLS; PREPARED PASTA; ROLLS; WHOLE-MEAL BREAD (U.S. CL. 46).

CAROLINE WOOD, EXAMINING ATTORNEY

SN 78-856,283. PROFERA, INC., SCRANTON, PA. FILED 4-7-2006.

NUTRILICIOUS

THE MARK CONSISTS OF STANDARD CHARACTERS WITHOUT CLAIM TO ANY PARTICULAR FONT, STYLE, SIZE, OR COLOR.

FOR PIZZAS (U.S. CL. 46).

DANIEL BRODY, EXAMINING ATTORNEY

CLASS 30—(Continued).

SN 78-856,289. GODIVA BRANDS, INC., NEWARK, DE.
FILED 4-7-2006.

AMERICAN PIES

THE MARK CONSISTS OF STANDARD CHARACTERS
WITHOUT CLAIM TO ANY PARTICULAR FONT, STYLE,
SIZE, OR COLOR.

FOR CHOCOLATE; CHOCOLATE CANDIES; CHOCOLATE
TRUFFLES (U.S. CL. 46).

MATTHEW MCDOWELL, EXAMINING ATTORNEY

SN 78-856,933. SHOCK COFFEE, LLC, WOODSIDE, NY.
FILED 4-7-2006.

SHOCK BALLS

THE MARK CONSISTS OF STANDARD CHARACTERS
WITHOUT CLAIM TO ANY PARTICULAR FONT, STYLE,
SIZE, OR COLOR.

NO CLAIM IS MADE TO THE EXCLUSIVE RIGHT TO
USE "BALLS", APART FROM THE MARK AS SHOWN.
FOR CONFECTIONARY, NAMELY, CANDY AND
GUM (U.S. CL. 46).

DOMINICK J. SALEMI, EXAMINING ATTORNEY

SN 78-859,163. TJERRILD, JAMES W., FRESNO, CA. FILED
4-11-2006.



NO CLAIM IS MADE TO THE EXCLUSIVE RIGHT TO
USE "CHOCOLATE FLAVORED WAFERS", APART FROM
THE MARK AS SHOWN.

FOR CHOCOLATE, CHOCOLATE CANDY, AND CHOCOLATE
FLAVORED CANDY (U.S. CL. 46).

FIRST USE 5-7-2004; IN COMMERCE 6-22-2004.

FRANK LATTUCA, EXAMINING ATTORNEY

CLASS 30—(Continued).

SN 78-859,892. BURLINGTON SPICE COMPANY, WEST
PALM BEACH, FL. FILED 4-12-2006.

YES MOMMY!

THE MARK CONSISTS OF STANDARD CHARACTERS
WITHOUT CLAIM TO ANY PARTICULAR FONT, STYLE,
SIZE, OR COLOR.

FOR FOOD PRODUCTS, NAMELY SPICES AND SEA-
SONINGS (U.S. CL. 46).

FIRST USE 5-7-2006; IN COMMERCE 5-7-2006.

JENNIFER WILLISTON, EXAMINING ATTORNEY

SN 78-861,530. RICHARDS, SUSAN M., OREGON, WI. FILED
4-14-2006.

BEE BARF HONEY COMPANY

THE MARK CONSISTS OF STANDARD CHARACTERS
WITHOUT CLAIM TO ANY PARTICULAR FONT, STYLE,
SIZE, OR COLOR.

NO CLAIM IS MADE TO THE EXCLUSIVE RIGHT TO
USE "HONEY COMPANY", APART FROM THE MARK AS
SHOWN.

FOR HONEY (U.S. CL. 46).

FIRST USE 10-10-2004; IN COMMERCE 10-10-2004.

JENNY PARK, EXAMINING ATTORNEY

SN 78-861,803. WORLD'S FINEST CHOCOLATE, INC., CHI-
CAGO, IL. FILED 4-14-2006.

CHOCOLATE CHECKERS

THE MARK CONSISTS OF STANDARD CHARACTERS
WITHOUT CLAIM TO ANY PARTICULAR FONT, STYLE,
SIZE, OR COLOR.

NO CLAIM IS MADE TO THE EXCLUSIVE RIGHT TO
USE "CHOCOLATE", APART FROM THE MARK AS
SHOWN.

FOR CANDY (U.S. CL. 46).

SAMUEL E. SHARPER JR., EXAMINING ATTORNEY

CLASS 30—(Continued).

SN 78-862,192. WATTU, RONALD, ORANGE, MA. FILED 4-14-2006.

CHOPPUCCINO

THE MARK CONSISTS OF STANDARD CHARACTERS WITHOUT CLAIM TO ANY PARTICULAR FONT, STYLE, SIZE, OR COLOR.

FOR BEVERAGES MADE OF COFFEE; BEVERAGES MADE OF TEA; CHOCOLATE; COCOA BEVERAGES WITH MILK; COFFEE; COFFEE; COFFEE-BASED BEVERAGE CONTAINING MILK; ESPRESSO; FLAVORINGS FOR BEVERAGES; FROZEN CONFECTIONS; GROUND COFFEE BEANS; ICE CREAM; MILK SHAKES; PREPARED COCOA AND COCOA-BASED BEVERAGES; PREPARED COFFEE AND COFFEE-BASED BEVERAGES; ROASTED COFFEE BEANS; TEA-BASED BEVERAGES WITH FRUIT FLAVORING (U.S. CL. 46).

AISHA CLARKE, EXAMINING ATTORNEY

CLASS 30—(Continued).

SN 78-863,043. M. ZANETTI INDUSTRIES S.A., LUXEMBOURG, LUXEMBOURG, FILED 4-17-2006.



OWNER OF LUXEMBOURG REG. NO. 619415, DATED 12-23-1997, EXPIRES 12-23-2007.

OWNER OF U.S. REG. NO. 2,374,764.

THE ENGLISH TRANSLATION OF THE FOREIGN WORDING IN THE MARK IS OUR GUIDING MOTHER.

FOR GREEN COFFEE (U.S. CL. 46).

CORY BOONE, EXAMINING ATTORNEY

SN 78-863,373. SILVER, BARNARD STEWART, SALT LAKE CITY, UT. FILED 4-18-2006.

SN 78-863,016. NATURE'S HAND, INC., CHICAGO, IL. FILED 4-17-2006.



OWNER OF U.S. REG. NOS. 960,557 AND 978,261. NO CLAIM IS MADE TO THE EXCLUSIVE RIGHT TO USE "SINCE 1971", APART FROM THE MARK AS SHOWN.

THE COLOR(S) BROWN AND TAN IS/ARE CLAIMED AS A FEATURE OF THE MARK.

THE MARK CONSISTS OF THE TAN WORDING NATURE'S HAND SINCE 1971 WITH TAN LINES TO THE RIGHT AND LEFT OF THE WORDING SINCE 1971, AND THE DESIGN OF A STYLIZED TAN HAND OVER A TAN STALK OF WHEAT FORMING THE APOSTROPHE IN THE TERM "NATURE'S". THE WORDING AND DESIGN ARE CONTAINED WITHIN A BROWN BACKGROUND IN AN ALTERNATING BROWN, TAN, BROWN DESIGN PATTERN CONSISTING OF A HALF OVAL ON TOP OF A RECTANGLE WITH TWO SQUARES OMITTED IN THE LOWER LEFT AND RIGHT CORNERS. PORTIONS OF THE HAND, THE STALK OF WHEAT, THE INNER DESIGN, AND THE WORDING ARE OUTLINED IN A DARK BROWN COLOR.

FOR GRANOLA (U.S. CL. 46).

JEFFERY COWARD, EXAMINING ATTORNEY

FRUCTALYN

THE MARK CONSISTS OF STANDARD CHARACTERS WITHOUT CLAIM TO ANY PARTICULAR FONT, STYLE, SIZE, OR COLOR.

FOR NATURAL SWEETENER (U.S. CL. 46).

FIRST USE 4-15-2006; IN COMMERCE 4-15-2006.

ELIZABETH J. WINTER, EXAMINING ATTORNEY

SN 78-863,381. SPECIALTY NUTRITION GROUP, INC., BOCA RATON, FL. FILED 4-18-2006.

PURPOSE

THE MARK CONSISTS OF STANDARD CHARACTERS WITHOUT CLAIM TO ANY PARTICULAR FONT, STYLE, SIZE, OR COLOR.

FOR BEVERAGES MADE OF TEA; BLACK TEA; FRUIT TEAS; GREEN TEA; HERBAL TEA; TEA; TEA-BASED BEVERAGES WITH FRUIT FLAVORING (U.S. CL. 46).

MARILYN IZZI, EXAMINING ATTORNEY

CLASS 30—(Continued).

SN 78-863,478. MALT-O-MEAL COMPANY, MINNEAPOLIS, MN. FILED 4-18-2006.

CEREAL SNACKERS

THE MARK CONSISTS OF STANDARD CHARACTERS WITHOUT CLAIM TO ANY PARTICULAR FONT, STYLE, SIZE, OR COLOR.

NO CLAIM IS MADE TO THE EXCLUSIVE RIGHT TO USE "CEREAL", APART FROM THE MARK AS SHOWN. FOR BREAKFAST CEREAL (U.S. CL. 46).
KATINA MISTER, EXAMINING ATTORNEY

SN 78-863,490. PHILLIPS, LILLIAN, NEW YORK, NY. FILED 4-18-2006.

INTERNAL SUNSHINE

THE MARK CONSISTS OF STANDARD CHARACTERS WITHOUT CLAIM TO ANY PARTICULAR FONT, STYLE, SIZE, OR COLOR.

FOR DRY BREAKFAST CEREAL (U.S. CL. 46).
PAMELA HIRSCHMAN, EXAMINING ATTORNEY

SN 78-863,546. STEVE'S AUTHENTIC INC., BROOKLYN, NY. FILED 4-18-2006.

THE SWINGLE

THE MARK CONSISTS OF STANDARD CHARACTERS WITHOUT CLAIM TO ANY PARTICULAR FONT, STYLE, SIZE, OR COLOR.

FOR CHOCOLATE DIPPED PIECE OF FROZEN KEY LIME PIE ON A STICK (U.S. CL. 46).
FIRST USE 8-6-2002; IN COMMERCE 8-6-2002.
GEORGE LORENZO, EXAMINING ATTORNEY

CLASS 30—(Continued).

SN 78-863,549. CADBURY ADAMS CANADA INC., TORONTO, CANADA, FILED 4-18-2006.

SOUR PATCH XPLODERZ

THE MARK CONSISTS OF STANDARD CHARACTERS WITHOUT CLAIM TO ANY PARTICULAR FONT, STYLE, SIZE, OR COLOR.

OWNER OF U.S. REG. NOS. 2,304,261, 2,595,207 AND 2,927,021.

NO CLAIM IS MADE TO THE EXCLUSIVE RIGHT TO USE "SOUR", APART FROM THE MARK AS SHOWN. FOR CONFECTIONERY, NAMELY CANDY (U.S. CL. 46).

PAMELA HIRSCHMAN, EXAMINING ATTORNEY

SN 78-863,710. LITTLE CUPCAKE CORP., BROOKLYN, NY. FILED 4-18-2006.



NO CLAIM IS MADE TO THE EXCLUSIVE RIGHT TO USE "CUPCAKE BAKESHOP", APART FROM THE MARK AS SHOWN.

THE COLOR(S) PINK, WHITE, YELLOW, BLACK AND GREEN IS/ARE CLAIMED AS A FEATURE OF THE MARK.

THE COLOR PINK APPEARS IN THE BACKGROUND STRIPES, CUPCAKE ICING AND OUTLINING; THE COLOR WHITE APPEARS AS THE BACKGROUND COLOR; THE COLOR YELLOW APPEARS IN THE CUPCAKE; THE COLOR BLACK APPEARS IN THE WORDING; AND THE COLOR GREEN APPEARS IN THE SPRINKLES.

FOR CUPCAKES, CAKES, PIES, COOKIES, PUDDINGS, PASTRIES (U.S. CL. 46).

FIRST USE 4-1-2005; IN COMMERCE 6-1-2005.
KELLY BOULTON, EXAMINING ATTORNEY

SN 78-863,757. TAO CORPORATION, DALLAS, TX. FILED 4-18-2006.

ALBORADA

THE MARK CONSISTS OF STANDARD CHARACTERS WITHOUT CLAIM TO ANY PARTICULAR FONT, STYLE, SIZE, OR COLOR.

THE FOREIGN WORDING IN THE MARK TRANSLATES INTO ENGLISH AS REVEILLE, DAWN SONG OR DAWN ATTACK.

FOR BEVERAGES MADE OF COFFEE; COFFEE; COFFEE BEANS; COFFEE-BASED BEVERAGE CONTAINING MILK; GROUND COFFEE BEANS; INSTANT COFFEE; PREPARED COFFEE AND COFFEE-BASED BEVERAGES; ROASTED COFFEE BEANS (U.S. CL. 46).

PAUL F. GAST, EXAMINING ATTORNEY

CLASS 30—(Continued).

SN 78-864,672. AMERICAN HOLDINGS, INC., ATLANTA, GA. FILED 4-19-2006.

TEA FOR THOUGHT

THE MARK CONSISTS OF STANDARD CHARACTERS WITHOUT CLAIM TO ANY PARTICULAR FONT, STYLE, SIZE, OR COLOR.

NO CLAIM IS MADE TO THE EXCLUSIVE RIGHT TO USE TEA, APART FROM THE MARK AS SHOWN.

FOR TEA; NAMELY TEA AND HERBAL TEA-BASED BEVERAGES; TEA AND HERBAL TEA-BASED BEVERAGES AND CONCENTRATES, WITH FRUIT FLAVORING; FROZEN CONFECTIONS WITH TEA, HERBAL TEA AND/OR FRUIT FLAVORING, HERBAL AND NON-HERBAL TEA; ICED TEA; READY-TO-DRINK TEA; POWDER ICED TEA MIX; TEA BAGS; SPECIALTY TEA; AND FUNCTIONAL TEA (U.S. CL. 46).

CATHERINE FAINT, EXAMINING ATTORNEY

SN 78-864,970. BOOT CONSULTING COMPANY, INC., MILL VALLEY, CA. FILED 4-19-2006.

Intimi

THE MARK CONSISTS OF STANDARD CHARACTERS WITHOUT CLAIM TO ANY PARTICULAR FONT, STYLE, SIZE, OR COLOR.

FOR COFFEE; COFFEE BEANS; GROUND COFFEE BEANS (U.S. CL. 46).

PAULA MAYS, EXAMINING ATTORNEY

SN 78-865,703. CSM LTD. HLD., MACOMB, MI. FILED 4-20-2006.

Just A Rub

THE MARK CONSISTS OF STANDARD CHARACTERS WITHOUT CLAIM TO ANY PARTICULAR FONT, STYLE, SIZE, OR COLOR.

FOR SPICE, DRY RUB, SEASONING (U.S. CL. 46).

KAPIL BHANOT, EXAMINING ATTORNEY

CLASS 30—(Continued).

SN 78-865,970. PARDES, DEBORAH, SAN FRANCISCO, CA. FILED 4-20-2006.

One Good Thing

THE MARK CONSISTS OF STANDARD CHARACTERS WITHOUT CLAIM TO ANY PARTICULAR FONT, STYLE, SIZE, OR COLOR.

FOR GRAIN-BASED CHIPS (U.S. CL. 46).

JOHN E. MICHOS, EXAMINING ATTORNEY

SN 78-866,555. GARDNER PIE COMPANY, AKRON, OH. FILED 4-21-2006.



REBECCA'S
TRIED AND TREASURED

THE MARK CONSISTS OF A BAKED PIE WITH FRESH FRUIT SURROUNDING THE BASE OF THE PIE. FOR FRUIT PIES (U.S. CL. 46).

FIRST USE 1-15-2006; IN COMMERCE 1-15-2006.

TARAH HARDY, EXAMINING ATTORNEY

SN 78-866,925. COMFORT FOODS, INC., N. ANDOVER, MA. FILED 4-21-2006.

BAY TRADERS

THE MARK CONSISTS OF STANDARD CHARACTERS WITHOUT CLAIM TO ANY PARTICULAR FONT, STYLE, SIZE, OR COLOR.

FOR COFFEE (U.S. CL. 46).

DAVID COLLIER, EXAMINING ATTORNEY

CLASS 30—(Continued).

SN 78-867,711. VIEJO, CYNTHIA L., CHARLOTTESVILLE, VA. FILED 4-24-2006.

BAGELINI

THE MARK CONSISTS OF STANDARD CHARACTERS WITHOUT CLAIM TO ANY PARTICULAR FONT, STYLE, SIZE, OR COLOR.
FOR BAGEL SANDWICHES (U.S. CL. 46).
JIM RINGLE, EXAMINING ATTORNEY

SN 78-868,136. WESTERN FAMILY FOODS, INC., TIGARD, OR. FILED 4-24-2006.

DEMI CAFF

THE MARK CONSISTS OF STANDARD CHARACTERS WITHOUT CLAIM TO ANY PARTICULAR FONT, STYLE, SIZE, OR COLOR.
FOR COFFEE (U.S. CL. 46).
MICHAEL WIENER, EXAMINING ATTORNEY

SN 78-868,489. FINJAN & ZARF, LLC, SEATTLE, WA. FILED 4-24-2006.

BOROGOVE

THE MARK CONSISTS OF STANDARD CHARACTERS WITHOUT CLAIM TO ANY PARTICULAR FONT, STYLE, SIZE, OR COLOR.
FOR COFFEE (U.S. CL. 46).
FIRST USE 3-6-2006; IN COMMERCE 3-6-2006.
GEORGE LORENZO, EXAMINING ATTORNEY

CLASS 30—(Continued).

SN 78-868,543. FREELAND FOODS INC., MOUNTAIN VIEW, CA. FILED 4-24-2006.

REAL LIVE CHOCOLATE

THE MARK CONSISTS OF STANDARD CHARACTERS WITHOUT CLAIM TO ANY PARTICULAR FONT, STYLE, SIZE, OR COLOR.

NO CLAIM IS MADE TO THE EXCLUSIVE RIGHT TO USE "CHOCOLATE", APART FROM THE MARK AS SHOWN.

FOR CHOCOLATE (U.S. CL. 46).
FIRST USE 12-31-2004; IN COMMERCE 12-31-2004.
ALLISON HOLTZ, EXAMINING ATTORNEY

SN 78-868,688. FRITO-LAY NORTH AMERICA, INC., PLANO, TX. FILED 4-25-2006.

EL SABOR QUE NOS UNE

THE MARK CONSISTS OF STANDARD CHARACTERS WITHOUT CLAIM TO ANY PARTICULAR FONT, STYLE, SIZE, OR COLOR.

THE ENGLISH TRANSLATION OF THE WORD "EL SABOR QUE NOS UNE" IN THE MARK IS "THE TASTE THAT BRINGS US TOGETHER".

FOR COOKIES; CRACKERS; PASTA (U.S. CL. 46).
FRANK LATTUCA, EXAMINING ATTORNEY

SN 78-869,264. REUNION ISLAND COFFEE LIMITED, OAKVILLE, ONTARIO, CANADA, FILED 4-25-2006.



NO CLAIM IS MADE TO THE EXCLUSIVE RIGHT TO USE "AUTHENTIC DONUT SHOP BLEND", APART FROM THE MARK AS SHOWN.

FOR ROASTED GROUND COFFEE AND ROASTED WHOLE BEAN COFFEE (U.S. CL. 46).
FIRST USE 11-1-2004; IN COMMERCE 11-1-2004.
DAVID COLLIER, EXAMINING ATTORNEY

CLASS 30—(Continued).

SN 78-869,715. STRAWBERRY HILL POVITICA, INC., LENEXA, KS. FILED 4-26-2006.

THE WORLD'S POVITICA

THE MARK CONSISTS OF STANDARD CHARACTERS WITHOUT CLAIM TO ANY PARTICULAR FONT, STYLE, SIZE, OR COLOR.

NO CLAIM IS MADE TO THE EXCLUSIVE RIGHT TO USE "POVITICA", APART FROM THE MARK AS SHOWN, FOR TRADITIONAL CROATIAN SWEET GOURMET BREAD (U.S. CL. 46).

FIRST USE 1-1-1993; IN COMMERCE 1-1-1993.
CAROLYN CATALDO, EXAMINING ATTORNEY

SN 78-870,212. STURM FOODS, INC, MANAWA, WI. FILED 4-26-2006.

COZY COUNTRY

THE MARK CONSISTS OF STANDARD CHARACTERS WITHOUT CLAIM TO ANY PARTICULAR FONT, STYLE, SIZE, OR COLOR.

FOR POWDERED MIXES FOR COCOA AND CAPPUCINO (U.S. CL. 46).

SUZANNE BLANE, EXAMINING ATTORNEY

SN 78-870,638. T T T SPICE COMPANY, HESPERIA, CA. FILED 4-26-2006.



NO CLAIM IS MADE TO THE EXCLUSIVE RIGHT TO USE "SPICE MIX", APART FROM THE MARK AS SHOWN. THE COLORS BLACK, RED, ORANGE, AND YELLOW ARE CLAIMED AS A FEATURE OF THE MARK.

THE MARK CONSISTS OF A BLACK SCORPION OUTLINED IN YELLOW, FLOATING OVER ORANGE, RED, AND YELLOW FLAMES. THE WORD SCORPION APPEARS IN ORANGE AND THE WORDS SPICE MIX APPEAR IN YELLOW. THE BACKGROUND APPEARS IN BLACK.

FOR CHILI SEASONING (U.S. CL. 46).
FIRST USE 5-1-2003; IN COMMERCE 10-15-2004.
AMY ALFIERI, EXAMINING ATTORNEY

CLASS 30—(Continued).

SN 78-870,760. STUTZMAN, BARB, CLARINDA, IA. FILED 4-27-2006.

DIP STICKS

THE MARK CONSISTS OF STANDARD CHARACTERS WITHOUT CLAIM TO ANY PARTICULAR FONT, STYLE, SIZE, OR COLOR.

FOR COOKIES, NAMELY COOKIES FORMED ABOUT A PRETZEL (U.S. CL. 46).

FIRST USE 4-26-2006; IN COMMERCE 4-26-2006.
GINA FINK, EXAMINING ATTORNEY

SN 78-870,850. SNIKIDDY, LLC, BETHESDA, MD. FILED 4-27-2006.

Banana Nibbles

THE MARK CONSISTS OF STANDARD CHARACTERS WITHOUT CLAIM TO ANY PARTICULAR FONT, STYLE, SIZE, OR COLOR.

NO CLAIM IS MADE TO THE EXCLUSIVE RIGHT TO USE "BANANA", APART FROM THE MARK AS SHOWN.

FOR FOOD PACKAGE COMBINATIONS CONSISTING PRIMARILY OF BREAD, CRACKERS AND/OR COOKIES; WHEAT-BASED SNACK FOODS (U.S. CL. 46).
FRED MANDIR, EXAMINING ATTORNEY

SN 78-872,174. KENNY, FRANK, SAN DIEGO, CA. FILED 4-28-2006.

CAPTAIN TEAO**TEA FOR KIDS**

NO CLAIM IS MADE TO THE EXCLUSIVE RIGHT TO USE "TEA FOR KIDS", APART FROM THE MARK AS SHOWN.

THE MARK CONSISTS OF STYLIZED WORDS AND AN IMAGE OF A "SUPER HERO" FEATURING THE LETTERS "CT" AND "TFK".

FOR TEA (U.S. CL. 46).
FIRST USE 3-27-2006; IN COMMERCE 3-27-2006.
MATTHEW MCDOWELL, EXAMINING ATTORNEY

CLASS 30—(Continued).

SN 78-878,070. THE THD GROUP LLC, OAKVILLE, ONTARIO, CANADA, FILED 5-5-2006.

NOTHING CHILLS LIKE IT

THE MARK CONSISTS OF STANDARD CHARACTERS WITHOUT CLAIM TO ANY PARTICULAR FONT, STYLE, SIZE, OR COLOR.

FOR COLD COFFEE BASED BEVERAGES (U.S. CL. 46).

FIRST USE 5-1-2005; IN COMMERCE 5-1-2005.
JUDITH HELFMAN, EXAMINING ATTORNEY

SN 78-878,348. AMERICAN HOLDINGS, INC., ATLANTA, GA. FILED 5-7-2006.

90210

THE MARK CONSISTS OF STANDARD CHARACTERS WITHOUT CLAIM TO ANY PARTICULAR FONT, STYLE, SIZE, OR COLOR.

FOR TEA; NAMELY TEA AND HERBAL TEA-BASED BEVERAGES; TEA AND HERBAL TEA-BASED BEVERAGES AND CONCENTRATES, WITH FRUIT FLAVORING; FROZEN CONFECTIONS WITH TEA, HERBAL TEA AND/OR FRUIT FLAVORING; HERBAL AND NON-HERBAL TEA; ICED TEA; READY-TO-DRINK TEA; POWDER ICED TEA MIX; TEA BAGS; SPECIALTY TEA; FUNCTIONAL TEA; GREEN TEA; BLACK TEA; WHITE TEA; AND RED TEA (U.S. CL. 46).

CATHERINE FAINT, EXAMINING ATTORNEY

SN 78-883,824. HEALTHSIMPLE TOOLS, LLC, MINNEAPOLIS, MN. FILED 5-15-2006.

HEALTHSIMPLE

THE MARK CONSISTS OF STANDARD CHARACTERS WITHOUT CLAIM TO ANY PARTICULAR FONT, STYLE, SIZE, OR COLOR.

FOR FOOD PRODUCTS, NAMELY, TEA, COCOA, COFFEE, PROCESSED CEREAL AND BREAKFAST CEREAL; NUTRITION BARS, NAMELY, READY TO EAT CEREAL DERIVED FOOD BARS; BREADS, CRACKERS, PASTRIES; PACKAGED MEALS CONSISTING PRIMARILY OF RICE OR PASTA; FROZEN MEALS CONSISTING PRIMARILY OF RICE OR PASTA; MIXES FOR MAKING BAKERY GOODS; CEREAL BASED SNACK FOODS, CORN BASED SNACK FOODS, RICE BASED SNACK FOODS; WHEAT BASED SNACK FOOD; FRUIT SAUCES EXCLUDING CRANBERRY AND APPLE SAUCE; MILK PRODUCTS, NAMELY, ICE CREAM, ICE MILK AND FROZEN YOGURT (U.S. CL. 46).

RUDY R. SINGLETON, EXAMINING ATTORNEY

CLASS 30—(Continued).

SN 78-886,049. MALT-O-MEAL COMPANY, MINNEAPOLIS, MN. FILED 5-17-2006.

REAL DEAL

THE MARK CONSISTS OF STANDARD CHARACTERS WITHOUT CLAIM TO ANY PARTICULAR FONT, STYLE, SIZE, OR COLOR.

FOR BREAKFAST CEREAL (U.S. CL. 46).
KATINA MISTER, EXAMINING ATTORNEY

SN 78-886,905. MARS, INCORPORATED, MCLEAN, VA. FILED 5-18-2006.

DOVE SHARE THE MOMENT

THE MARK CONSISTS OF STANDARD CHARACTERS WITHOUT CLAIM TO ANY PARTICULAR FONT, STYLE, SIZE, OR COLOR.

OWNER OF U.S. REG. NOS. 1,415,202, 2,963,876 AND OTHERS.

FOR CONFECTIONERY, NAMELY CANDY (U.S. CL. 46).

JENNIFER KRISP, EXAMINING ATTORNEY

SN 78-887,731. MARS, INCORPORATED, MCLEAN, VA. FILED 5-19-2006.

DOVE...WHAT SHE REALLY WANTS!

THE MARK CONSISTS OF STANDARD CHARACTERS WITHOUT CLAIM TO ANY PARTICULAR FONT, STYLE, SIZE, OR COLOR.

OWNER OF U.S. REG. NOS. 1,415,202, 2,963,876 AND OTHERS.

FOR CONFECTIONERY, NAMELY, CANDY (U.S. CL. 46).

JENNIFER KRISP, EXAMINING ATTORNEY

CLASS 30—(Continued).

SN 78-893,696. S.T. MANAGEMENT GROUP, INC., NEW YORK, NY. FILED 5-26-2006.

FREEZATTA

THE MARK CONSISTS OF STANDARD CHARACTERS WITHOUT CLAIM TO ANY PARTICULAR FONT, STYLE, SIZE, OR COLOR.

FOR FROZEN BEVERAGES MADE WITH A BASE OF COFFEE (U.S. CL. 46).

STANLEY I. OSBORNE, EXAMINING ATTORNEY

CLASS 30—(Continued).

SN 78-911,341. CONAGRA BRANDS, INC., OMAHA, NE. FILED 6-19-2006.

SMART MENU

THE MARK CONSISTS OF STANDARD CHARACTERS WITHOUT CLAIM TO ANY PARTICULAR FONT, STYLE, SIZE, OR COLOR.

OWNER OF U.S. REG. NOS. 2,825,599 AND 2,925,660.

FOR PIZZA CONTAINING A SOY-BASED OR VEGETABLE-BASED MEAT SUBSTITUTE; BURRITOS CONTAINING A SOY-BASED OR VEGETABLE-BASED MEAT SUBSTITUTE (U.S. CL. 46).

KELLY BOULTON, EXAMINING ATTORNEY

SN 78-897,313. MALT-O-MEAL COMPANY, MINNEAPOLIS, MN. FILED 5-31-2006.

WHEAT-FULS

THE MARK CONSISTS OF STANDARD CHARACTERS WITHOUT CLAIM TO ANY PARTICULAR FONT, STYLE, SIZE, OR COLOR.

OWNER OF U.S. REG. NO. 2,116,741.

FOR BREAKFAST CEREAL (U.S. CL. 46).

KATINA MISTER, EXAMINING ATTORNEY

SN 78-925,568. CONAGRA FOODS PACKAGED FOODS COMPANY, INC., OMAHA, NE. FILED 7-10-2006.



OWNER OF U.S. REG. NO. 2,320,457.

FOR PREPARED PIZZA, BREADSTICKS, AND POCKET SANDWICHES (U.S. CL. 46).

FIRST USE 4-8-1998; IN COMMERCE 4-8-1998.

LINDA MICKLEBURGH, EXAMINING ATTORNEY

SN 78-903,248. VENTURA FOODS, LLC, BREA, CA. FILED 6-7-2006.

SONA

THE MARK CONSISTS OF STANDARD CHARACTERS WITHOUT CLAIM TO ANY PARTICULAR FONT, STYLE, SIZE, OR COLOR.

FOR SOY SAUCE (U.S. CL. 46).

FIRST USE 3-30-1965; IN COMMERCE 3-30-1965.

ANGELA M. MICHELI, EXAMINING ATTORNEY

SN 78-927,017. CONAGRA FOODS PACKAGED FOODS COMPANY, INC., OMAHA, NE. FILED 7-11-2006.



OWNER OF U.S. REG. NO. 2,320,457.

FOR PREPARED PIZZA, BREAD STICKS AND POCKET SANDWICHES (U.S. CL. 46).

FIRST USE 11-3-2000; IN COMMERCE 11-3-2000.

LINDA MICKLEBURGH, EXAMINING ATTORNEY

CLASS 30—(Continued).

SN 78-948,502. UNIMERC, S.A. DE C.V., CORTES, HONDURAS, FILED 8-9-2006.

Tomatissimo!

THE COLORS RED AND YELLOW ARE CLAIMED AS A FEATURE OF THE MARK.

THE MARK IS COMPRISED OF THE WORD TOMATISSIMO AND EXCLAMATION POINT WITH RED LETTERS AND EXCLAMATION POINT IN A CURSIVE FORMAT SURROUNDED BY A YELLOW BACKGROUND.

FOR BEVERAGES MADE OF COFFEE; BEVERAGES MADE OF TEA; BONBONS MADE OF SUGAR; CAFFEINE-FREE COFFEE; COFFEE; COFFEE; COFFEE BEANS; COFFEE FLAVORED SYRUP USED IN MAKING FOOD BEVERAGES; COFFEE-BASED BEVERAGE CONTAINING MILK; FLAVORINGS FOR BEVERAGES; FLAVOURINGS OF TEA; GROUND COFFEE BEANS; HERBAL FOOD BEVERAGES; INSTANT COFFEE; PREPARED COCOA AND COCOA-BASED BEVERAGES; PREPARED COFFEE AND COFFEE-BASED BEVERAGES; READY-MADE SAUCES; ROASTED COFFEE BEANS; SUGAR-COATED COFFEE BEANS (U.S. CL. 46).
KATHLEEN M. VANSTON, EXAMINING ATTORNEY

SN 79-008,731. GRANDS MOULINS DE PARIS, FRANCE, FILED 12-20-2004.

DELIFRANCE

OWNER OF INTERNATIONAL REGISTRATION 0482645 DATED 2-3-1984, EXPIRES 2-3-2014.

OWNER OF U.S. REG. NO. 2,233,850.
FOR FLOURS; CEREAL PREPARATIONS NAMELY BREAD, BISCUITS, CAKES, PASTRIES, BREADS AND PASTRIES KNOWN AS VIENNESE PASTRIES, CEREAL BASED SNACK FOODS, THAT ARE FRESH OR DEEP-FROZEN, COOKED OR PRECOOKED (U.S. CL. 46).
LINDA ORNDORFF, EXAMINING ATTORNEY

SN 79-010,134. LAFFORT OENOLOGIE, FRANCE, FILED 2-4-2005.

F 15

THE MARK CONSISTS OF STANDARD CHARACTERS WITHOUT CLAIM TO ANY PARTICULAR FONT, STYLE, SIZE, OR COLOR.

PRIORITY DATE OF 9-2-2004 IS CLAIMED.
OWNER OF INTERNATIONAL REGISTRATION 0847146 DATED 2-4-2005, EXPIRES 2-4-2015.
FOR YEAST (U.S. CL. 46).
AISHA CLARKE, EXAMINING ATTORNEY

CLASS 30—(Continued).

SN 79-019,245. LANCANG RIVER BEER ENTERPRISE GROUP CO, LTD. YUNNAN, CHINA, FILED 11-21-2005.



OWNER OF INTERNATIONAL REGISTRATION 0872224 DATED 11-21-2005, EXPIRES 11-21-2015.

NO CLAIM IS MADE TO THE EXCLUSIVE RIGHT TO USE "LANCANG RIVER" AND THE CHINESE CHARACTERS THAT TRANSLITERATE TO LAN, CANG, AND JIANG AND TRANSLATE TO "LANCANG RIVER", APART FROM THE MARK AS SHOWN.

THE TRANSLATION OF THE FIRST CHINESE CHARACTER IS "BILLOWS" THE TRANSLATION OF THE SECOND CHINESE CHARACTER IS "DARK BLUE", THE TRANSLATION OF THE THIRD CHINESE CHARACTER IS "RIVER", THE TRANSLATION OF THE FOURTH CHINESE CHARACTER IS "GIVE BIRTH TO, GROW" AND THE TRANSLATION OF THE LAST CHINESE CHARACTER IS "GREEN"; THE COMBINATION OF THE FIRST THREE CHINESE CHARACTERS MEANS "LANCANG RIVER", A MAJOR RIVER IN SOUTHWEST CHINA; THE COMBINATION OF LAST TWO CHINESE CHARACTERS HAS NO MEANING.

LAN, CANG, JIANG, SHENG, LU.
FOR TEA; TEA SUBSTITUTES; ICED TEA; TEA-BASED BEVERAGES, NAMELY, BEVERAGES MADE OF TEA; COFFEE; SUGAR; UNROASTED COFFEE (U.S. CL. 46).

SHARON MEIER, EXAMINING ATTORNEY

SN 79-020,279. PRE GEL S.P.A., ITALY, FILED 8-4-2005.

Fresh Made
Original
GELATO

PRIORITY DATE OF 7-8-2005 IS CLAIMED.
OWNER OF INTERNATIONAL REGISTRATION 0875159 DATED 8-4-2005, EXPIRES 8-4-2015.

NO CLAIM IS MADE TO THE EXCLUSIVE RIGHT TO USE "FRESH MADE ORIGINAL GELATO", APART FROM THE MARK AS SHOWN.

THE COLOR(S) SHADES OF YELLOW, SHADES OF RED, AND SHADES OF BLUE ARE CLAIMED AS A FEATURE OF THE MARK.

THE MARK IS COMPRISED OF THE WORDING "FRESH MADE ORIGINAL GELATO" PRINTED IN FANCIFUL CHARACTERS ON THREE LEVELS AND ASSOCIATED TO AN OVAL PRINTED IN THE SHADES OF BLUE; THE

CLASS 30—(Continued).

WORDING "FRESH MADE" IS PRINTED WITH THE OUTLINE OF THE LETTERS IN THE SHADES OF BLUE AND THE INSIDE IN THE SHADES OF YELLOW AND RED; THE WORDING "ORIGINAL" IS PRINTED INSIDE THE OVAL IN THE SHADES OF RED WITH LETTER "G" OVERLAPPING THE LETTERS "EL" OF "GELATO" AND THE LETTER "I" PROTRUDING OUTSIDE THE ABOVE MENTIONED OVAL AND OVERLAPPING THE LETTERS "DE" OF "MADE"; THE WORDING "GELATO" IS PRINTED IN THE BOTTOM AND IS CUT BY THE OVAL.

FOR COFFEE, TEA, COCOA, SUGAR, RICE, TAPIOCA, SAGO, ARTIFICIAL COFFEE; FLOUR AND PREPARATIONS MADE FROM CEREALS, NAMELY BREAKFAST CEREALS, CEREAL BASED SNACK FOOD, PROCESSED CEREALS, READY TO EAT, CEREAL DERIVED FOODBARS; BREAD, PASTRY AND CONFECTIONERY, NAMELY COCOA-BASED INGREDIENT IN CONFECTIONERY PRODUCTS, CONFECTIONERY CHIPS FOR BAKING, CRYSTAL SUGAR, CRYSTAL SUGAR PIECES, FROZEN YOGURT, FRUIT JELLIES, PEANUT BUTTER CONFECTIONERY CHIPS, PEPPERMINT FOR CONFECTIONERY; ICES; HONEY, TREACLE; YEAST, BAKING-POWDER; SALT, MUSTARD; VINEGAR, CONDIMENTS, NAMELY SAUCES; SPICES, ICE; SEMI-FINISHED FOOD PRODUCTS FOR MAKING ICE CREAMS, NAMELY ICE CREAM MIXES, ICE CREAM POWDERS, STARCH-BASED BINDING AGENTS FOR ICE CREAM, ICE CREAM FLAVORINGS AND PASTRIES (U.S. CL. 46).

VERNA BETH RIRIE, EXAMINING ATTORNEY

SN 79-024,608. BEIJING WUYUTAI TEA CO., LTD., CHINA, FILED 4-13-2006.

OWNER OF INTERNATIONAL REGISTRATION 0886883 DATED 4-13-2006, EXPIRES 4-13-2016.

THE MARK CONSISTS OF THREE CHINESE CHARACTERS.

THE CHINESE CHARACTERS IN THE MARK TRANSLITERATE TO WU YU TAI, AND WU IS THE APPLICANT'S LAST NAME; YU MEANS AFFLUENT OR RICH IN ENGLISH; AND TAI MEANS PEACEFUL AND SAFE IN ENGLISH.

FOR TEA (U.S. CL. 46).
ELI HELLMAN, EXAMINING ATTORNEY

CLASS 31—NATURAL AGRICULTURAL PRODUCTS

SN 76-658,784. DAVID AUSTIN ROSES LIMITED, ALBRIGHTON, WOLVERHAMPTON, ENGLAND, FILED 4-21-2006.

SCARBOROUGH FAIR

THE MARK CONSISTS OF STANDARD CHARACTERS WITHOUT CLAIM TO ANY PARTICULAR FONT, STYLE, SIZE, OR COLOR.

FOR LIVE ROSE PLANTS (U.S. CLS. 1 AND 46).
FIRST USE 7-0-2005; IN COMMERCE 1-23-2006.
JENNY PARK, EXAMINING ATTORNEY

CLASS 31—(Continued).

SN 76-658,785. DAVID AUSTIN ROSES LIMITED, ALBRIGHTON, WOLVERHAMPTON, ENGLAND, FILED 4-21-2006.

JUBILEE CELEBRATION

THE MARK CONSISTS OF STANDARD CHARACTERS WITHOUT CLAIM TO ANY PARTICULAR FONT, STYLE, SIZE, OR COLOR.

FOR LIVE ROSE PLANTS (U.S. CLS. 1 AND 46).
FIRST USE 7-0-2005; IN COMMERCE 12-27-2005.
JENNY PARK, EXAMINING ATTORNEY

SN 76-660,033. MAUI LAND & PINEAPPLE COMPANY, INC., LAHAINA, HI. FILED 5-15-2006.

Authentic to Nature, Our Culture, Our Customers

THE MARK CONSISTS OF STANDARD CHARACTERS WITHOUT CLAIM TO ANY PARTICULAR FONT, STYLE, SIZE, OR COLOR.

FOR FRESH FRUITS, RAW FRUITS, UNPROCESSED FRUITS, FRESH VEGETABLES, RAW VEGETABLES, UNPROCESSED VEGETABLES (U.S. CLS. 1 AND 46).
FIRST USE 12-5-2005; IN COMMERCE 12-5-2005.
NAAKWAMA ANKRAH, EXAMINING ATTORNEY

SN 78-540,024. DOGSTERS, LLC, MILFORD, CT. FILED 12-30-2004.

OMEGA TWISTS

THE MARK CONSISTS OF STANDARD CHARACTERS WITHOUT CLAIM TO ANY PARTICULAR FONT, STYLE, SIZE, OR COLOR.

NO CLAIM IS MADE TO THE EXCLUSIVE RIGHT TO USE "TWISTS", APART FROM THE MARK AS SHOWN.
FOR ANIMAL FOODSTUFFS, NAMELY, PET FOOD, BEVERAGES FOR ANIMALS, PET BISCUITS, AND EDIBLE PET TREATS (U.S. CLS. 1 AND 46).
DARRYL SPRULL, EXAMINING ATTORNEY

CLASS 31—(Continued).

SN 78-606,608. CANINE COOKIE CUPBOARD, POLO, MO. FILED 4-12-2005.



NO CLAIM IS MADE TO THE EXCLUSIVE RIGHT TO USE "CANINE COOKIE", APART FROM THE MARK AS SHOWN.

THE COLORS PURPLE, GRAY, DARK AND LIGHT BROWN, WHITE, GOLD, BLACK AND BLUE ARE CLAIMED AS A FEATURE OF THE MARK.

BLACK IS USED AS AN OUTLINE FOR ELEMENTS OF THE DESIGN, THE DOG APPEARS IN DARK AND LIGHT BROWN WITH GOLD AND WHITE HIGHLIGHTS, THE CHEF'S HAT IS WHITE WITH BLUE SHADOWS, THE OVEN MITTS ARE PURPLE AS IS A BOWL ON THE COUNTER, THE COOKIE SHEET AND WORDING AND COUNTERTOP ARE GRAY, THE CABINETS ARE DARK BROWN AND THE COOKIES ARE LIGHT BROWN.

"THE MARK CONSISTS OF DOG WITH CHEF'S HAT, DOG IS WINKING, HOLDING A COOKIE SHEET WITH APRON THAT SAYS "KISS THE CHEF".

FOR HOME-BAKED DOG TREATS (U.S. CLS. 1 AND 46).

FIRST USE 3-31-2005; IN COMMERCE 4-4-2005.
JERI J. FICKES, EXAMINING ATTORNEY

CLASS 31—(Continued).

SN 78-685,782. NINO FRUIT (NINOFRUIT) COMPANY S.A., GUAYAQUIL, ECUADOR, FILED 8-4-2005.



NO CLAIM IS MADE TO THE EXCLUSIVE RIGHT TO USE "FRUIT", APART FROM THE MARK AS SHOWN.

THE COLORS GREEN, YELLOW AND BLACK ARE CLAIMED AS A FEATURE OF THE MARK.

THE WORD NINO APPEARS IN BLACK, THE WORD FRUIT APPEARS IN GREEN, THE DOTS ALTERNATE IN BLACK AND GREEN, AND THE FIGURE IS OUTLINED IN BLACK WITH THE COLOR YELLOW ON THE HEAD AND THE COLOR GREEN ON THE BODY.

THE MARK CONSISTS OF THE WORDS NINO FRUIT, DOTS AROUND THE WORD FRUIT, AND THE DESIGN OF A CHILD.

FOR FRUITS, NAMELY, FRESH FRUIT (U.S. CLS. 1 AND 46).

FIRST USE 10-3-2002; IN COMMERCE 12-15-2002.
LEIGH CAROLINE CASE, EXAMINING ATTORNEY

SN 78-652,924. GRASSLANZ TECHNOLOGY LIMITED, PALMERSTON NORTH, NEW ZEALAND, FILED 6-17-2005.

AR1

THE MARK CONSISTS OF STANDARD CHARACTERS WITHOUT CLAIM TO ANY PARTICULAR FONT, STYLE, SIZE, OR COLOR.

FOR AGRICULTURAL, HORTICULTURAL AND FORESTRY PRODUCTS, NAMELY GRAINS FOR PLANTING, SEEDS AND LIVING PLANTS, EXCLUDING SEEDS AND CULTIVARS OF LIVE HERBAGE PLANTS (U.S. CLS. 1 AND 46).

MARIAM MAHMOUDI, EXAMINING ATTORNEY

SN 78-806,555. JAKE'S BAKERY, LLC, NEW CITY, NY. FILED 2-3-2006.



THE MARK CONSISTS OF A SMILING DOG FACE. FOR DOG BISCUITS AND TREATS (U.S. CLS. 1 AND 46).

FIRST USE 9-1-2005; IN COMMERCE 12-16-2005.
DAYNA BROWNE, EXAMINING ATTORNEY

CLASS 31—(Continued).

SN 78-820,352. INTERNATIONAL PLANT SELECTION,
MONTELMAR, FRANCE, FILED 2-22-2006.

CLASS 31—(Continued).

SN 78-851,570. BARENBRUG USA, INC., TANGENT, OR.
FILED 3-31-2006.

CARMINGO

THE MARK CONSISTS OF STANDARD CHARACTERS
WITHOUT CLAIM TO ANY PARTICULAR FONT, STYLE,
SIZE, OR COLOR.

FOR FRUIT TREES AND FRESH FRUITS, NAMELY
LIVE APRICOT TREES AND FRESH APRICOTS (U.S.
CLS. 1 AND 46).

ANDREA EVANS, EXAMINING ATTORNEY

WINTER WONDERLAWN

THE MARK CONSISTS OF STANDARD CHARACTERS
WITHOUT CLAIM TO ANY PARTICULAR FONT, STYLE,
SIZE, OR COLOR.

OWNER OF U.S. REG. NOS. 554,773 AND 642,779.

FOR GRASS SEED (U.S. CLS. 1 AND 46).

TANYA AMOS, EXAMINING ATTORNEY

SN 78-842,124. WILD BIRDS UNLIMITED, INC., CARMEL,
IN. FILED 3-21-2006.

BARK BUTTER

THE MARK CONSISTS OF STANDARD CHARACTERS
WITHOUT CLAIM TO ANY PARTICULAR FONT, STYLE,
SIZE, OR COLOR.

NO CLAIM IS MADE TO THE EXCLUSIVE RIGHT TO
USE "BARK", APART FROM THE MARK AS SHOWN.

FOR FOOD FOR ANIMALS (U.S. CLS. 1 AND 46).

FIRST USE 3-6-2006; IN COMMERCE 3-6-2006.

SHAUNIA WALLACE, EXAMINING ATTORNEY

SN 78-855,279. THE IAMS COMPANY, CINCINNATI, OH.
FILED 4-6-2006.

SN 78-846,249. MICKELSON, JAMES, GLEN, FOLSOM, CA.
FILED 3-25-2006.

EUKANUBA CUSTOMIZED NUTRITION

Silver Skin

THE MARK CONSISTS OF STANDARD CHARACTERS
WITHOUT CLAIM TO ANY PARTICULAR FONT, STYLE,
SIZE, OR COLOR.

FOR MULCH (U.S. CLS. 1 AND 46).

FIRST USE 1-1-2006; IN COMMERCE 1-1-2006.

WOODROW HARTZOG, EXAMINING ATTORNEY

THE MARK CONSISTS OF STANDARD CHARACTERS
WITHOUT CLAIM TO ANY PARTICULAR FONT, STYLE,
SIZE, OR COLOR.

OWNER OF U.S. REG. NOS. 970,296 AND 2,392,936.

NO CLAIM IS MADE TO THE EXCLUSIVE RIGHT TO
USE "CUSTOMIZED NUTRITION", APART FROM THE
MARK AS SHOWN.

FOR FOODSTUFFS FOR ANIMALS (U.S. CLS. 1 AND
46).

WILLIAM ROSSMAN, EXAMINING ATTORNEY

CLASS 31—(Continued).

SN 78-856,916. SOCIETE DES PRODUITS NESTLE S.A., VEVEY, SWITZERLAND, FILED 4-7-2006.



THE COLOR(S) RED, YELLOW, GREEN, ORANGE, BEIGE AND WHITE IS/ARE CLAIMED AS A FEATURE OF THE MARK.

THE MARK CONSISTS OF DEPICTIONS OF MEAT AND VEGETABLES, NAMELY, CUBES OF RED MEAT, YELLOW EARS OF CORN EMERGING FROM THEIR GREEN HUSKS, ORANGE CARROTS WITH GREEN STEMS AND LEAFLETS, STALKS OF BEIGE WHEAT CROSSED AT THEIR STEMS, AND GREEN PEA PODS WITH SEVERAL LOOSE GREEN PEAS, ALL APPEARING TO FLOAT OVER A WHITE FIELD.

FOR PET FOOD (U.S. CLS. 1 AND 46).
FIRST USE 5-24-2001; IN COMMERCE 5-24-2001.
ALEXANDER L. POWERS, EXAMINING ATTORNEY

CLASS 31—(Continued).

AND OCCUPYING ABOUT THE BOTTOM QUARTER OF THE SEMI-CIRCULAR DESIGN, AND DEPICTIONS OF MEAT AND VEGETABLES, NAMELY, CUBES OF RED MEAT, A YELLOW EAR OF CORN EMERGING FROM ITS GREEN HUSK, ORANGE CARROTS WITH GREEN LEAFLETS, STALKS OF BEIGE WHEAT CROSSED AT THEIR STEMS, AND GREEN PEA PODS WITH SEVERAL LOOSE GREEN PEAS, ALL APPEARING TO FLOAT OVER A WHITE FIELD THAT OCCUPIES THE REGION ABOVE AND TO THE LEFT OF THE SEMI-CIRCULAR DESIGN.

FOR PET FOOD (U.S. CLS. 1 AND 46).
FIRST USE 5-24-2001; IN COMMERCE 5-24-2001.
ALEXANDER L. POWERS, EXAMINING ATTORNEY

SN 78-857,756. BAILEY NURSERIES, INC., ST. PAUL, MN. FILED 4-10-2006.

POLAR JOY

THE MARK CONSISTS OF STANDARD CHARACTERS WITHOUT CLAIM TO ANY PARTICULAR FONT, STYLE, SIZE, OR COLOR.

FOR LIVE ROSE PLANTS (U.S. CLS. 1 AND 46).
JAMES MACFARLANE, EXAMINING ATTORNEY

SN 78-856,922. SOCIETE DES PRODUITS NESTLE S.A., VEVEY, SWITZERLAND, FILED 4-7-2006.

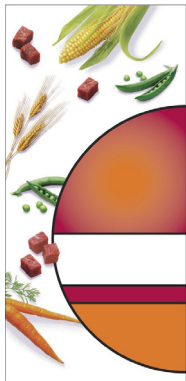

THE COLOR(S) RED, YELLOW, GREEN, ORANGE, BEIGE AND WHITE IS/ARE CLAIMED AS A FEATURE OF THE MARK.

THE MARK CONSISTS OF A SEMI-CIRCULAR DESIGN HAVING FOUR DISTINCT FIELDS, SAID FOUR FIELDS BEING SEPARATED FROM ONE ANOTHER ALONG HORIZONTAL BORDERS, THE TOP-MOST FIELD OCCUPYING ABOUT THE TOP HALF OF THE SEMI-CIRCULAR DESIGN AND BEING GENERALLY RED IN COLOR EXCEPT FOR A CENTRAL PORTION OF THE TOP-MOST FIELD WHICH IS ORANGE IN COLOR, THE SECOND FIELD FROM THE TOP BEING WHITE IN COLOR AND OCCUPYING ABOUT THE NEXT QUARTER OF THE SEMI-CIRCULAR DESIGN, THE THIRD FIELD FROM THE TOP BEING RED IN COLOR AND OCCUPYING A NARROW HORIZONTAL BAND BELOW THE SECOND FIELD, AND THE BOTTOM-MOST FIELD BEING ORANGE IN COLOR

SN 78-858,374. CLEO'S BARKERY, LLC, HARTSDALE, NY. FILED 4-10-2006.



THE COLORS ORANGE, PINK, PURPLE, YELLOW, BLACK, BLUE, RED, WHITE, BROWN, AND GREEN ARE CLAIMED AS FEATURES OF THE MARK.

THE COLORS BLACK, BROWN, AND WHITE APPEAR IN THE DOG DESIGN ELEMENT, THE COLORS RED, ORANGE, YELLOW, PINK, PURPLE, BLACK, AND BLUE APPEAR IN THE DOG'S HAT, THE COLORS BLUE, PINK AND WHITE APPEAR IN THE DOG'S BANDANA, THE COLORS YELLOW, PURPLE, BLACK, BLUE, PINK, ORANGE, AND GREEN APPEAR IN THE WRAPPED GIFT DESIGN, AND THE WORDING "CLEO'S BARKERY" APPEARS IN THE COLOR PINK.

FOR PET TREATS, NAMELY, GOURMET HOME-MADE ALL-MEAT BIRTHDAY CAKES FOR DOGS AND CUPCAKES FOR PETS (U.S. CLS. 1 AND 46).
ALLISON SCHRODY, EXAMINING ATTORNEY

CLASS 31—(Continued).

SN 78-859,931. THE IAMS COMPANY, CINCINNATI, OH.
FILED 4-12-2006.

CLEAN GREEN

THE MARK CONSISTS OF STANDARD CHARACTERS
WITHOUT CLAIM TO ANY PARTICULAR FONT, STYLE,
SIZE, OR COLOR.

FOR FOODSTUFFS FOR ANIMALS (U.S. CLS. 1 AND
46).

WILLIAM ROSSMAN, EXAMINING ATTORNEY

SN 78-861,436. EDUARDO ALFREDO POLO FERNÁNDEZ,
SAUGUS, CA. FILED 4-13-2006.



NO CLAIM IS MADE TO THE EXCLUSIVE RIGHT TO
USE "FLORAL FARMS", APART FROM THE MARK AS
SHOWN.

THE COLORS RED, GREEN, BLACK AND WHITE ARE
CLAIMED AS A FEATURE OF THE MARK.

THE COLOR RED APPEARS IN THE THREE STYLIZED
FLOWER PETALS, THE COLOR GREEN APPEARS IN THE
WORD "ABSOLUTE", AND THE COLOR BLACK APPEARS
IN THE WORDING "FLORAL FARMS". THE ENTIRE
MARK APPEARS ON A WHITE BACKGROUND.

THE MARK CONSISTS, IN PART, OF THE STYLIZED
DESIGN OF A FLOWER.

FOR CUT FLOWERS; LIVE FLOWERS (U.S. CLS. 1
AND 46).

ELIZABETH J. WINTER, EXAMINING ATTORNEY

SN 78-861,825. PENNINGTON SEED, INC., MADISON, GA.
FILED 4-14-2006.

FEEDING FRENZY

THE MARK CONSISTS OF STANDARD CHARACTERS
WITHOUT CLAIM TO ANY PARTICULAR FONT, STYLE,
SIZE, OR COLOR.

FOR WILDLIFE SEED MIXTURE USED IN DEER
FOOD PLOTS (U.S. CLS. 1 AND 46).

SANDRA MANIOS, EXAMINING ATTORNEY

CLASS 31—(Continued).

SN 78-861,854. SORENSEN, MARK, FRESNO, CA. AND
SORENSEN, KIMBERLY, FRESNO, CA. FILED 4-14-2006.



NO CLAIM IS MADE TO THE EXCLUSIVE RIGHT TO
USE "BLUEBERRIES CALIFORNIA GROWN", APART
FROM THE MARK AS SHOWN.

THE COLOR(S) BLACK, LIGHT BLUE, LIGHT GREEN,
AND WHITE IS/ARE CLAIMED AS A FEATURE OF THE
MARK.

THE COLOR LIGHT GREEN DEPICTS THE LETTERING
OF THE WORDS "SORENSEN'S" AND "CALIFORNIA
GROWN", THE HORIZONTAL LINES, AND THE BLUE-
BERRY LEAVES OF THE MARK. THE COLOR LIGHT
BLUE DEPICTS THE WORDS "TRIPLE DELIGHT", THE
BORDER, THE HORIZONTAL LINE THAT CONNECTS TO
THE BORDER, AND THE BLUEBERRIES OF THE MARK.
THE COLOR WHITE DEPICTS THE WORD "BLUEBER-
RIES" AND THE BACKGROUND OF THE MARK. THE
COLOR BLACK DEPICTS THE SHADOWING OF THE
WORD "BLUEBERRIES", THE DOTS ON THE BLUEBER-
RIES, THE VEINS ON THE BLUEBERRY LEAVES, AND
THE BLUEBERRY BRANCH.

FOR PACKAGED FRESH BLUEBERRIES FOR HU-
MAN CONSUMPTION (U.S. CLS. 1 AND 46).

FIRST USE 5-0-2000; IN COMMERCE 5-0-2000.

JAMES MACFARLANE, EXAMINING ATTORNEY

SN 78-862,099. D.M. ADAMS, INC., BUTLER, PA. FILED 4-14-
2006.



NO CLAIM IS MADE TO THE EXCLUSIVE RIGHT TO
USE "ORIGINAL ORGANIC", "CANINE COOKIE DOUGH"
AND "CHEESY GARLIC", APART FROM THE MARK AS
SHOWN.

THE COLOR(S) PURPLE, PEACH, AND WHITE IS/ARE
CLAIMS AS A FEATURE OF THE MARK.

THE MARK CONSISTS OF A BASE HORIZONTAL BAR
BEARING THE TEXT "CHEEZY GARLIC"; ABOVE THE
BAR TWO ROWS OF SMALL COLORED SQUARES IN A
CHECKERBOARD-LIKE PATTERN HAVING SMALL PAW
PRINTS IN THE OPEN SPACES BETWEEN THE COLORED
SQUARES; ABOVE THAT IS A LARGE SEMICIRCLE

CLASS 31—(Continued).

HAVING ALONG ITS INTERIOR BASE LINE THE TEXT "K9 COOKIE DOUGH" AND ABOVE THAT A CENTERED LARGE SHADOWED PAW PRINT; ALONG THE TOP OUTER EDGE OF THE SEMICIRCLE IS THE TEXT "SAYDE'S ORIGINAL ORGANIC". COLORING IS: PURPLE FOR: SEMICIRCLE FILL; SMALL PAW PRINTS; AND TEXT OF "SAYDE'S ORIGINAL ORGANIC" AND "CHEEZY GARLIC". PEACH FOR: COLORED SQUARES; HORIZONTAL BAR; SHADOW OF LARGE PAW PRINT; AND TEXT OF "K9 COOKIE DOUGH". WHITE FOR: LARGE PAW PRINT. FOR DOG TREATS (U.S. CLS. 1 AND 46).
TRICIA SONNEBORN, EXAMINING ATTORNEY

SN 78-862,158. D.M. ADAMS, INC., BUTLER, PA. FILED 4-14-2006.



NO CLAIM IS MADE TO THE EXCLUSIVE RIGHT TO USE "ORIGINAL ORGANIC", "CANINE COOKIE DOUGH" AND "INC.", APART FROM THE MARK AS SHOWN.

THE COLOR(S) RUBINE RED, ORANGE, AND WHITE IS/ARE CLAIMED AS A FEATURE OF THE MARK.

THE MARK CONSISTS OF A LINE OF TEXT "D.M. ADAMS, INC."; ABOVE THE LINE OF TEXT TWO ROWS OF SMALL COLORED SQUARES IN A CHECKERBOARD-LIKE PATTERN HAVING SMALL PAW PRINTS IN THE OPEN SPACES BETWEEN THE COLORED SQUARES; ABOVE THAT IS A LARGE SEMICIRCLE HAVING ALONG ITS INTERIOR BASE LINE THE TEXT "K9 COOKIE DOUGH" AND ABOVE THAT A CENTERED LARGE SHADOWED PAW PRINT; ALONG THE TOP OUTER EDGE OF THE SEMICIRCLE IS THE TEXT "SAYDE'S ORIGINAL ORGANIC". COLORING IS: RUBINE RED FOR: SMALL PAW PRINTS; SHADOW OF LARGE PAW PRINT; AND TEXT OF "SAYDE'S ORIGINAL ORGANIC" AND "D.M. ADAMS" AND "K9 COOKIE DOUGH". ORANGE FOR: SEMICIRCLE FILL; AND COLORED SQUARES. WHITE FOR: LARGE PAW PRINT.

FOR DOG TREATS (U.S. CLS. 1 AND 46).
TRICIA SONNEBORN, EXAMINING ATTORNEY

SN 78-862,172. D.M. ADAMS, INC., BUTLER, PA. FILED 4-14-2006.



NO CLAIM IS MADE TO THE EXCLUSIVE RIGHT TO USE "ORIGINAL ORGANIC" AND "CANINE COOKIE DOUGH", APART FROM THE MARK AS SHOWN.

THE COLOR(S) GOLD, RED, AND WHITE IS/ARE CLAIMS AS A FEATURE OF THE MARK.

THE MARK CONSISTS OF A BASE HORIZONTAL BAR BEARING THE TEXT "MUTTER BUTTER"; ABOVE THE BAR TWO ROWS OF SMALL COLORED SQUARES IN A CHECKERBOARD-LIKE PATTERN HAVING SMALL PAW

CLASS 31—(Continued).

PRINTS IN THE OPEN SPACES BETWEEN THE COLORED SQUARES; ABOVE THAT IS A LARGE SEMICIRCLE HAVING ALONG ITS INTERIOR BASE LINE THE TEXT "K9 COOKIE DOUGH" AND ABOVE THAT A CENTERED LARGE SHADOWED PAW PRINT; ALONG THE TOP OUTER EDGE OF THE SEMICIRCLE IS THE TEXT "SAYDE'S ORIGINAL ORGANIC". COLORING IS: RED FOR: SEMICIRCLE FILL; SMALL PAW PRINTS; AND TEXT OF "SAYDE'S ORIGINAL ORGANIC" AND "MUTTER BUTTER". GOLD FOR: COLORED SQUARES; HORIZONTAL BAR; SHADOW OF LARGE PAW PRINT; AND TEXT OF "K9 COOKIE DOUGH". WHITE FOR: LARGE PAW PRINT. FOR DOG TREATS (U.S. CLS. 1 AND 46).
TRICIA SONNEBORN, EXAMINING ATTORNEY

SN 78-862,187. D.M. ADAMS, INC., BUTLER, PA. FILED 4-14-2006.



NO CLAIM IS MADE TO THE EXCLUSIVE RIGHT TO USE "ORIGINAL ORGANIC", "CANINE COOKIE DOUGH" AND "PUMPKIN", APART FROM THE MARK AS SHOWN.

THE COLOR(S) ORANGE, TURQUOISE, AND WHITE IS/ARE CLAIMED AS A FEATURE OF THE MARK.

THE MARK CONSISTS OF A BASE HORIZONTAL BAR BEARING THE TEXT "PAWSITIVELY PUMPKIN"; ABOVE THE BAR ARE TWO ROWS OF SMALL COLORED SQUARES IN A CHECKERBOARD-LIKE PATTERN HAVING SMALL PAW PRINTS IN THE OPEN SPACES BETWEEN THE COLORED SQUARES; ABOVE THAT IS A LARGE SEMICIRCLE HAVING ALONG ITS INTERIOR BASE LINE THE TEXT "K9 COOKIE DOUGH" AND ABOVE THAT A CENTERED LARGE SHADOWED PAW PRINT; ALONG THE TOP OUTER EDGE OF THE SEMICIRCLE IS THE TEXT "SAYDE'S ORIGINAL ORGANIC". COLORING IS: ORANGE FOR: SMALL PAW PRINTS; SHADOW OF LARGE PAW PRINT; AND TEXT OF "SAYDE'S ORIGINAL ORGANIC" AND "PAWSITIVELY PUMPKIN" AND "K9 COOKIE DOUGH". TURQUOISE FOR: SEMICIRCLE FILL; COLORED SQUARES; AND HORIZONTAL BAR. WHITE FOR: LARGE PAW PRINT.

FOR DOG TREATS (U.S. CLS. 1 AND 46).
TRICIA SONNEBORN, EXAMINING ATTORNEY

SN 78-863,615. LOBUE BROS., INC., LINDSAY, CA. FILED 4-18-2006.

SUN GROVE

THE MARK CONSISTS OF STANDARD CHARACTERS WITHOUT CLAIM TO ANY PARTICULAR FONT, STYLE, SIZE, OR COLOR.

OWNER OF U.S. REG. NO. 2,026,802.
FOR FRUITS, NAMELY, FRESH CITRUS (U.S. CLS. 1 AND 46).

FIRST USE 4-1-1950; IN COMMERCE 4-1-1950.
KELLY BOULTON, EXAMINING ATTORNEY

CLASS 31—(Continued).

SN 78-863,738. PROGRESSIVE PRODUCE CORPORATION,
LOS ANGELES, CA. FILED 4-18-2006.

SNACKAWAY FRESH

THE MARK CONSISTS OF STANDARD CHARACTERS
WITHOUT CLAIM TO ANY PARTICULAR FONT, STYLE,
SIZE, OR COLOR.

NO CLAIM IS MADE TO THE EXCLUSIVE RIGHT TO
USE "FRESH", APART FROM THE MARK AS SHOWN.
FOR FRESH FRUITS AND VEGETABLES (U.S. CLS. 1
AND 46).

FIRST USE 4-3-2006; IN COMMERCE 4-3-2006.
JESSICA A. POWERS, EXAMINING ATTORNEY

SN 78-867,173. MCMULLIN, BRUCE, MIDVALE, UT. AND
MCMULLIN, DUSTY, MIDVALE, UT. AND MCMULLIN,
PETER, MIDVALE, UT. FILED 4-21-2006.

Sea Buck

THE MARK CONSISTS OF STANDARD CHARACTERS
WITHOUT CLAIM TO ANY PARTICULAR FONT, STYLE,
SIZE, OR COLOR.

FOR ANIMAL FEED SUPPLEMENT FOR EQUINE,
CATTLE AND SMALL ANIMALS, INCLUDING DOMES-
TICATED ANIMALS (U.S. CLS. 1 AND 46).

DAVID TAYLOR, EXAMINING ATTORNEY

SN 78-867,238. MCMULLIN, BRUCE, MIDVALE, UT. AND
MCMULLIN, DUSTY, MIDVALE, UT. AND MCMULLIN,
PETER, MIDVALE, UT. FILED 4-21-2006.

SeaBuck

THE MARK CONSISTS OF STANDARD CHARACTERS
WITHOUT CLAIM TO ANY PARTICULAR FONT, STYLE,
SIZE, OR COLOR.

FOR ANIMAL FEED SUPPLEMENT FOR EQUINE,
CATTLE AND SMALL ANIMALS, INCLUDING DOMES-
TICATED ANIMALS (U.S. CLS. 1 AND 46).

DAVID TAYLOR, EXAMINING ATTORNEY

CLASS 31—(Continued).

SN 78-869,659. PERKINS DIRECT STEP, LLC, LABELLE, FL.
FILED 4-26-2006.

SPECMAKER

THE MARK CONSISTS OF STANDARD CHARACTERS
WITHOUT CLAIM TO ANY PARTICULAR FONT, STYLE,
SIZE, OR COLOR.

FOR LIVE PLANTS, NAMELY, WALTER'S VIBUR-
NUM (U.S. CLS. 1 AND 46).

MICHAEL GAAFAR, EXAMINING ATTORNEY

SN 78-870,739. RIDGE-SWEET MELON GROWERS, INC.,
COTTONWOOD, CA. FILED 4-27-2006.

RIDGE-SWEET

THE MARK CONSISTS OF STANDARD CHARACTERS
WITHOUT CLAIM TO ANY PARTICULAR FONT, STYLE,
SIZE, OR COLOR.

FOR FRESH FRUIT (U.S. CLS. 1 AND 46).

FIRST USE 6-30-1986; IN COMMERCE 6-30-1986.

MARY MUNSON, EXAMINING ATTORNEY

SN 78-871,218. TIMBERWOLF ORGANICS, INC., DUNDEE,
FL. FILED 4-27-2006.

TIMBERWOLF ORGANICS

THE MARK CONSISTS OF STANDARD CHARACTERS
WITHOUT CLAIM TO ANY PARTICULAR FONT, STYLE,
SIZE, OR COLOR.

NO CLAIM IS MADE TO THE EXCLUSIVE RIGHT TO
USE "ORGANICS", APART FROM THE MARK AS SHOWN.
FOR ANIMAL FOODSTUFFS; NUTRITIONAL ADDI-
TIVES FOR ANIMAL FOODSTUFFS, NOT FOR MEDI-
CAL PURPOSES (U.S. CLS. 1 AND 46).

FIRST USE 12-31-1995; IN COMMERCE 12-31-1998.

DAVID TAYLOR, EXAMINING ATTORNEY

CLASS 31—(Continued).

SN 78-871,863. 971016 ONTARIO LIMITED, RUTHVEN,
ONTARIO, CANADA, FILED 4-28-2006.

GRAPEROMA

THE MARK CONSISTS OF STANDARD CHARACTERS
WITHOUT CLAIM TO ANY PARTICULAR FONT, STYLE,
SIZE, OR COLOR.
FOR FRESH TOMATOES (U.S. CLS. 1 AND 46).
DAHLIA GEORGE, EXAMINING ATTORNEY

SN 78-871,875. 971016 ONTARIO LIMITED, RUTHVEN,
ONTARIO, CANADA, FILED 4-28-2006.

GRAPE-A-ROMA

THE MARK CONSISTS OF STANDARD CHARACTERS
WITHOUT CLAIM TO ANY PARTICULAR FONT, STYLE,
SIZE, OR COLOR.
FOR FRESH TOMATOES (U.S. CLS. 1 AND 46).
DAHLIA GEORGE, EXAMINING ATTORNEY

SN 78-873,197. HIGHLINE PRODUCE LIMITED, LEAMING-
TON, ONTARIO, CANADA, FILED 5-1-2006.

**Porteenies Portabella
Mushrooms**

THE MARK CONSISTS OF STANDARD CHARACTERS
WITHOUT CLAIM TO ANY PARTICULAR FONT, STYLE,
SIZE, OR COLOR.
NO CLAIM IS MADE TO THE EXCLUSIVE RIGHT TO
USE "PORTABELLA MUSHROOMS", APART FROM THE
MARK AS SHOWN.
FOR FRESH MUSHROOMS (U.S. CLS. 1 AND 46).
FIRST USE 1-1-2001; IN COMMERCE 1-1-2001.
JOHN WILKE, EXAMINING ATTORNEY

CLASS 31—(Continued).

SN 78-878,047. THE HARTZ MOUNTAIN CORPORATION,
SECAUCUS, NJ. FILED 5-5-2006.

VMX PETVANTAGE MOVIE SNAX

THE MARK CONSISTS OF STANDARD CHARACTERS
WITHOUT CLAIM TO ANY PARTICULAR FONT, STYLE,
SIZE, OR COLOR.
NO CLAIM IS MADE TO THE EXCLUSIVE RIGHT TO
USE "MOVIE SNAX", APART FROM THE MARK AS
SHOWN.
FOR EDIBLE PET TREATS (U.S. CLS. 1 AND 46).
DEZMONA MIZELLE, EXAMINING ATTORNEY

SN 78-890,158. PENNINGTON SEED, INC. OF NEBRASKA,
MADISON, GA. FILED 5-23-2006.

DREAM BUCKS

THE MARK CONSISTS OF STANDARD CHARACTERS
WITHOUT CLAIM TO ANY PARTICULAR FONT, STYLE,
SIZE, OR COLOR.
FOR WILDLIFE SEED (U.S. CLS. 1 AND 46).
SANDRA MANIOS, EXAMINING ATTORNEY

SN 78-912,501. TIMBERWOLF ORGANICS, INC., DUNDEE,
FL. FILED 6-20-2006.

SERENGETI

THE MARK CONSISTS OF STANDARD CHARACTERS
WITHOUT CLAIM TO ANY PARTICULAR FONT, STYLE,
SIZE, OR COLOR.
FOR ANIMAL FOODSTUFFS; NUTRITIONAL ADDI-
TIVES FOR ANIMAL FOODSTUFFS, NOT FOR MEDI-
CAL PURPOSES (U.S. CLS. 1 AND 46).
FIRST USE 12-31-2005; IN COMMERCE 12-31-2005.
DAVID TAYLOR, EXAMINING ATTORNEY

CLASS 31—(Continued).

SN 79-017,851. BIOGENKOJI RESEARCH INSTITUTE, JAPAN, FILED 10-6-2005.

TOMOKO

THE MARK CONSISTS OF STANDARD CHARACTERS WITHOUT CLAIM TO ANY PARTICULAR FONT, STYLE, SIZE, OR COLOR.

PRIORITY DATE OF 5-2-2005 IS CLAIMED. OWNER OF INTERNATIONAL REGISTRATION 0868787 DATED 10-6-2005, EXPIRES 10-6-2015.

FOR ANIMAL FOODSTUFFS, ADDITIVES TO FODDER, NOT FOR MEDICAL PURPOSES (U.S. CLS. 1 AND 46).

LINDA MICKLEBURGH, EXAMINING ATTORNEY

CLASS 32—(Continued).

SN 76-646,781. SMOOTOPIA, LLC, MIAMI BEACH, FL. FILED 9-14-2005.

SOUTH PEACH

THE MARK CONSISTS OF STANDARD CHARACTERS WITHOUT CLAIM TO ANY PARTICULAR FONT, STYLE, SIZE, OR COLOR.

FOR NON-ALCOHOLIC BEVERAGES, NAMELY, FRUIT SMOOTHIES, FRUIT JUICES, FRUIT BASED DRINKS, SOFT DRINKS, ALL FOR CONSUMPTION ON OR OFF THE PREMISES; FRUIT PUREE AND OTHER FRUIT BASES FOR USE IN SMOOTHIES (U.S. CLS. 45, 46 AND 48).

PATRICIA EVANKO, EXAMINING ATTORNEY

CLASS 32—LIGHT BEVERAGES

SN 76-646,779. SMOOTOPIA, LLC, MIAMI BEACH, FL. FILED 9-14-2005.

MORE FRUIT MORE FLAVOR

THE MARK CONSISTS OF STANDARD CHARACTERS WITHOUT CLAIM TO ANY PARTICULAR FONT, STYLE, SIZE, OR COLOR.

FOR NON-ALCOHOLIC BEVERAGES, NAMELY, FRUIT SMOOTHIES, FRUIT JUICES, FRUIT BASED DRINKS, SOFT DRINKS, ALL FOR CONSUMPTION ON OR OFF THE PREMISES; FRUIT PUREE AND OTHER FRUIT BASES FOR USE IN SMOOTHIES (U.S. CLS. 45, 46 AND 48).

PATRICIA EVANKO, EXAMINING ATTORNEY

SN 76-646,782. SMOOTOPIA, LLC, MIAMI BEACH, FL. FILED 9-14-2005.

BEAM ME UP BLUEBERRY

SN 76-646,780. SMOOTOPIA, LLC, MIAMI BEACH, FL. FILED 9-14-2005.

BANAVALANCHE

THE MARK CONSISTS OF STANDARD CHARACTERS WITHOUT CLAIM TO ANY PARTICULAR FONT, STYLE, SIZE, OR COLOR.

FOR NON-ALCOHOLIC BEVERAGES, NAMELY, FRUIT SMOOTHIES, FRUIT JUICES, FRUIT BASED DRINKS, SOFT DRINKS, ALL FOR CONSUMPTION ON OR OFF THE PREMISES; FRUIT PUREE AND OTHER FRUIT BASES FOR USE IN SMOOTHIES (U.S. CLS. 45, 46 AND 48).

PATRICIA EVANKO, EXAMINING ATTORNEY

THE MARK CONSISTS OF STANDARD CHARACTERS WITHOUT CLAIM TO ANY PARTICULAR FONT, STYLE, SIZE, OR COLOR.

NO CLAIM IS MADE TO THE EXCLUSIVE RIGHT TO USE "BLUEBERRY", APART FROM THE MARK AS SHOWN.

FOR NON-ALCOHOLIC BEVERAGES, NAMELY, FRUIT SMOOTHIES, FRUIT JUICES, FRUIT BASED DRINKS, SOFT DRINKS, ALL FOR CONSUMPTION ON OR OFF THE PREMISES; FRUIT PUREE AND OTHER FRUIT BASES FOR USE IN SMOOTHIES (U.S. CLS. 45, 46 AND 48).

PATRICIA EVANKO, EXAMINING ATTORNEY

CLASS 32—(Continued).

SN 76-650,215. AZTECA PRODUCTS, INC., LAREDO, TX. FILED 11-14-2005.



NO CLAIM IS MADE TO THE EXCLUSIVE RIGHT TO USE COLA AND AUTENTICAMENTE MEXICANO, APART FROM THE MARK AS SHOWN.

THE COLOR(S) GREEN, RED, YELLOW AND WHITE IS/ ARE CLAIMED AS A FEATURE OF THE MARK.

THE COLOR GREEN APPEARS IN THE UPPER AND LOWER BAND, RED IN THE RECTANGULAR BACKGROUND, WHITE IN THE WORDS AZTECA COLA, AND YELLOW IN THE WORDS AUTENTICAMENTE MEXICANO.

THE WORD AUTENTICAMENTE MEXICANO IN THE MARK IS "AUTHENTICALLY MEXICAN".

FOR NON-ALCOHOLIC DRINKS, NAMELY, CARBONATED SOFT DRINKS (U.S. CLS. 45, 46 AND 48).

FIRST USE 5-30-2005; IN COMMERCE 5-30-2005.
ALICE BENMAMAN, EXAMINING ATTORNEY

CLASS 32—(Continued).

SN 78-570,356. THE CONCENTRATE MANUFACTURING COMPANY OF IRELAND, TA SEVEN-UP INTERNATIONAL, HAMILTON, BERMUDA, FILED 2-18-2005.

MANZANITA SOL.
CAE EN LA NUEVA
TENTACIÓN

THE MARK CONSISTS OF STANDARD CHARACTERS WITHOUT CLAIM TO ANY PARTICULAR FONT, STYLE, SIZE, OR COLOR.

THE FOREIGN WORDING IN THE MARK TRANSLATES INTO ENGLISH AS MANZANITA SOL. FALL INTO THE NEW TEMPTATION. THE TRANSLATION OF MANZANITA SOL IS LITTLE APPLE SUN.

FOR SOFT DRINKS (U.S. CLS. 45, 46 AND 48).
JENNIFER DIXON, EXAMINING ATTORNEY

SN 78-592,550. OTTAKRINGER BRAUEREI AG, WIEN, AUSTRIA, FILED 3-22-2005.

SN 78-415,017. LABATT BREWING COMPANY LIMITED, TORONTO, ONTARIO, CANADA, FILED 5-7-2004.

ALL THE GREAT
TASTE YOU EXPECT

THE MARK CONSISTS OF STANDARD CHARACTERS WITHOUT CLAIM TO ANY PARTICULAR FONT, STYLE, SIZE, OR COLOR.

PRIORITY CLAIMED UNDER SEC. 44(D) ON CANADA APPLICATION NO. 1196043, FILED 11-12-2003.

FOR ALCOHOLIC BEVERAGES, NAMELY BEER (U.S. CLS. 45, 46 AND 48).

TRACY WHITAKER-BOWN, EXAMINING ATTORNEY

GOLDFASSL

THE MARK CONSISTS OF STANDARD CHARACTERS WITHOUT CLAIM TO ANY PARTICULAR FONT, STYLE, SIZE, OR COLOR.

OWNER OF AUSTRIA REG. NO. 58009, DATED 9-2-1966, EXPIRES 9-30-2016.

FOR BEER (U.S. CLS. 45, 46 AND 48).
KEVON CHISOLM, EXAMINING ATTORNEY

CLASS 32—(Continued).

SN 78-604,499. LIN, HUI, SHENZHEN, CHINA, AND LIM, CHWOON ANG, HONG KONG, HONG KONG, FILED 4-8-2005.

KOSMO

THE MARK CONSISTS OF STANDARD CHARACTERS WITHOUT CLAIM TO ANY PARTICULAR FONT, STYLE, SIZE, OR COLOR.

FOR NON-ALCOHOLIC DRINKS, NAMELY SOFT DRINKS; FRUIT DRINKS AND FRUIT JUICES; SYRUPS FOR BEVERAGES; AND PREPARATIONS FOR MAKING FRUIT DRINKS (U.S. CLS. 45, 46 AND 48).

COLLEEN KEARNEY, EXAMINING ATTORNEY

SN 78-604,527. LIN, HUI, SHENZHEN, CHINA, AND LIM, CHWOON ANG, HONG KONG, HONG KONG, FILED 4-8-2005.



FOR NON-ALCOHOLIC DRINKS, NAMELY SOFT DRINKS; FRUIT DRINKS AND FRUIT JUICES; SYRUPS FOR BEVERAGES; AND PREPARATIONS FOR MAKING FRUIT DRINKS (U.S. CLS. 45, 46 AND 48).

COLLEEN KEARNEY, EXAMINING ATTORNEY

CLASS 32—(Continued).

SN 78-648,345. LO HECHO EN MEXICO, MONTEBELLO, CA. FILED 6-10-2005.

CANTARITOS

THE MARK CONSISTS OF STANDARD CHARACTERS WITHOUT CLAIM TO ANY PARTICULAR FONT, STYLE, SIZE, OR COLOR.

THE FOREIGN WORDING IN THE MARK TRANSLATES INTO ENGLISH AS "LITTLE CONTAINERS" OR "LITTLE JUGS".

FOR NON-ALCOHOLIC BEVERAGES NAMELY NATURALLY AND ARTIFICIALLY FLAVORED DRINKING WATER; SOFT DRINKS (U.S. CLS. 45, 46 AND 48).

SEAN CROWLEY, EXAMINING ATTORNEY

SN 78-674,103. STAMPEDE BREWING CO., INC., DALLAS, TX. FILED 7-20-2005.



THE MARK CONSISTS OF STANDARD CHARACTERS WITHOUT CLAIM TO ANY PARTICULAR FONT, STYLE, SIZE, OR COLOR.

FOR BEER (U.S. CLS. 45, 46 AND 48).

BERYL GARDNER, EXAMINING ATTORNEY

SN 78-705,952. BGB INTERNATIONAL HOLDING AKTIENGESELLSCHAFT, VADUZ FL-9490 FURSTENTUM, LIECHTENSTEIN, FILED 9-2-2005.

藍妹

"THE NON-LATIN CHARACTER(S) IN THE MARK TRANSLITERATES INTO NAM MUI , AND THIS MEANS BLUE GIRL IN ENGLISH."

FOR BEER, LOW-ALCOHOL BEER; NON-ALCOHOLIC BEER (U.S. CLS. 45, 46 AND 48).

BARBARA A. LOUGHRAN, EXAMINING ATTORNEY

CLASS 32—(Continued).

SN 78-714,230. EON BEVERAGE GROUP, INC., BEDFORD, TX. FILED 9-15-2005.

Rudy Forty-Fied

THE MARK CONSISTS OF STANDARD CHARACTERS WITHOUT CLAIM TO ANY PARTICULAR FONT, STYLE, SIZE, OR COLOR.

FOR FRUIT JUICES AND DRINKS; VEGETABLE JUICES (U.S. CLS. 45, 46 AND 48).

AMY HELLA, EXAMINING ATTORNEY

CLASS 32—(Continued).

SN 78-778,638. ENVASADORA GUGAR, S.A. DE C.V., TLALIXTAC DE CABRERA, OAXCA, MEXICO, FILED 12-21-2005.



SN 78-720,769. DR PEPPER/SEVEN UP, INC., PLANO, TX. FILED 9-26-2005.

ISLAND CITRUS GUAVA

THE MARK CONSISTS OF STANDARD CHARACTERS WITHOUT CLAIM TO ANY PARTICULAR FONT, STYLE, SIZE, OR COLOR.

NO CLAIM IS MADE TO THE EXCLUSIVE RIGHT TO USE "CITRUS GUAVA", APART FROM THE MARK AS SHOWN.

FOR FRUIT FLAVORED DRINK CONTAINING WATER (U.S. CLS. 45, 46 AND 48).

JAMES STEIN, EXAMINING ATTORNEY

OWNER OF MEXICO REG. NO. 397996, DATED 4-10-1991, RENEWED AS REG. NO. 397996, DATED 5-21-2001, EXPIRES 4-10-2011.

FOR CONCENTRATES, SYRUPS OR POWDERS USED IN THE PREPARATION OF SOFT DRINKS; DRINKING WATER; FLAVORED WATERS; FRUIT JUICE BASES; MINERAL WATER; SODA WATER; SOY-BASED BEVERAGES NOT BEING MILK SUBSTITUTES; SYRUPS FOR BEVERAGES (U.S. CLS. 45, 46 AND 48).

GEOFFREY FOSDICK, EXAMINING ATTORNEY

SN 78-731,584. FRUGOSA, S.A. DE C. V., 55340 XALOSTOC, ESTADO DE MEXICO, MEXICO, FILED 10-12-2005.

JUMEX AMI NARANJADA

THE MARK CONSISTS OF STANDARD CHARACTERS WITHOUT CLAIM TO ANY PARTICULAR FONT, STYLE, SIZE, OR COLOR.

OWNER OF U.S. REG. NOS. 973,533, 2,718,757 AND 2,746,272.

NO CLAIM IS MADE TO THE EXCLUSIVE RIGHT TO USE NARANJADA, APART FROM THE MARK AS SHOWN.

THE ENGLISH TRANSLATION OF THE SPANISH WORD "NARANJADA" IS "ORANGEADE".

FOR FRUIT DRINKS (U.S. CLS. 45, 46 AND 48).

JASON TURNER, EXAMINING ATTORNEY

SN 78-804,013. MCKENZIE, JOEL DANIEL, SOUTHAMPTON, NY. FILED 2-1-2006.



NO CLAIM IS MADE TO THE EXCLUSIVE RIGHT TO USE "LONG ISLAND" "HAMPTONS" OR "CO.", APART FROM THE MARK AS SHOWN.

FOR SOFT DRINKS (U.S. CLS. 45, 46 AND 48).

JUSTINE D. PARKER, EXAMINING ATTORNEY

CLASS 32—(Continued).

SN 78-824,644. LLERA, SLAVADOR ALFREDO GONZALEZ, GUADALAJARA, MEXICO, FILED 2-27-2006.

FEROZ

THE MARK CONSISTS OF STANDARD CHARACTERS WITHOUT CLAIM TO ANY PARTICULAR FONT, STYLE, SIZE, OR COLOR.

THE FOREIGN WORDING IN THE MARK TRANSLATES INTO ENGLISH AS FEROCIOUS.

FOR APPLE JUICE BEVERAGES; CONCENTRATES, SYRUPS OR POWDERS USED IN THE PREPARATION OF SOFT DRINKS; DISTILLED DRINKING WATER; DRINKING WATER; FLAVORED WATERS; FRUIT DRINKS; FRUIT FLAVORED SOFT DRINKS; FRUIT JUICE CONCENTRATES; FRUIT JUICES; FRUIT-FLAVORED DRINKS; HERBAL JUICES; MALT BEER; MALT LIQUOR ; MINERAL WATER; NON-ALCOHOLIC BEER; PALE BEER; POP ; PORTER ; SODA WATER; SOFT DRINKS; SOFT DRINKS FLAVORED WITH TEA; SPORTS DRINKS; SPRING WATER; SYRUP FOR MAKING LEMONADE; SYRUPS FOR BEVERAGES; SYRUPS FOR MAKING SOFT DRINKS; TABLE WATER (U.S. CLS. 45, 46 AND 48).

FIRST USE 8-20-2002; IN COMMERCE 10-21-2005.
DOMINIC FATHY, EXAMINING ATTORNEY

SN 78-827,161. SHARK USA INCORPORATED, TORRANCE, CA. FILED 3-2-2006.

KEEP MOVING

THE MARK CONSISTS OF STANDARD CHARACTERS WITHOUT CLAIM TO ANY PARTICULAR FONT, STYLE, SIZE, OR COLOR.

FOR CARBONATED AND NON-CARBONATED SOFT DRINKS; ENERGY DRINKS, ENHANCED WITH VITAMINS, MINERALS, NUTRIENTS, AMINO ACIDS, OR HERBS AND AERATED WATER (U.S. CLS. 45, 46 AND 48).

ASMAT KHAN, EXAMINING ATTORNEY

SN 78-833,225. OSKAR BLUES, LLC, LYONS, CO. FILED 3-9-2006.

Old Chub

THE MARK CONSISTS OF STANDARD CHARACTERS WITHOUT CLAIM TO ANY PARTICULAR FONT, STYLE, SIZE, OR COLOR.

FOR BEER; SCOTTISH STYLE BREWED ALE (U.S. CLS. 45, 46 AND 48).

FIRST USE 10-10-2003; IN COMMERCE 10-10-2003.
JENNIFER KRISP, EXAMINING ATTORNEY

CLASS 32—(Continued).

SN 78-842,198. ANDREASYN, ANDREAS, NORTH HOLLYWOOD, CA. FILED 3-21-2006.



THE COLORS ORANGE, BLUE, PURPLE, GREEN, BROWN, YELLOW, BLACK AND WHITE ARE CLAIMED AS A FEATURE OF THE MARK.

THE MARK CONSISTS OF TWO DEER DRINKING FROM A BODY OF WATER IN A FOREST WITH A WATERFALL. THE COLOR ORANGE APPEARS IN THE TWO DEER AND IN THE BACKGROUND OF THE IMAGE, THE COLOR BLUE APPEARS IN THE WATER AND SKY, THE COLOR GREEN APPEARS IN THE GRASS, THE COLOR BROWN APPEARS IN THE TREE, THE COLORS YELLOW, PURPLE, BLACK, AND WHITE APPEAR IN THE BACKGROUND OF THE IMAGE.

FOR NATURAL MINERAL WATER (U.S. CLS. 45, 46 AND 48).

FIRST USE 5-5-2000; IN COMMERCE 5-5-2000.
LAURIE KAUFMAN, EXAMINING ATTORNEY

SN 78-853,025. UNIVERSAL FOOD & BEVERAGE COMPANY, ST. CHARLES, IL. FILED 4-3-2006.

GRAYSON SPRINGS MOUNTAIN WATER

THE MARK CONSISTS OF STANDARD CHARACTERS WITHOUT CLAIM TO ANY PARTICULAR FONT, STYLE, SIZE, OR COLOR.

OWNER OF U.S. REG. NOS. 2,363,563 AND 2,363,564. NO CLAIM IS MADE TO THE EXCLUSIVE RIGHT TO USE "SPRINGS MOUNTAIN WATER", APART FROM THE MARK AS SHOWN.

FOR BOTTLED DRINKING WATER (U.S. CLS. 45, 46 AND 48).

ANDREA SAUNDERS, EXAMINING ATTORNEY

CLASS 32—(Continued).

SN 78-856,769. UNIMERC, S.A. DE C.V., CORTES, HONDURAS, FILED 4-7-2006.

MARINATTO

THE MARK CONSISTS OF STANDARD CHARACTERS WITHOUT CLAIM TO ANY PARTICULAR FONT, STYLE, SIZE, OR COLOR.

THE ENGLISH TRANSLATION OF MARINATTO IS PICKLED OR MARINATED.

FOR CONCENTRATES, SYRUPS OR POWDERS USED IN THE PREPARATION OF SOFT DRINKS; DRINKING WATER; MINERAL WATER; SELTZER WATER; SODA WATER; SPARKLING WATER; SPRING WATER; SYRUP FOR MAKING LEMONADE; SYRUPS FOR BEVERAGES; SYRUPS FOR MAKING SOFT DRINKS (U.S. CLS. 45, 46 AND 48).

KATHLEEN M. VANSTON, EXAMINING ATTORNEY

SN 78-863,600. GREAT DIVIDE BREWING COMPANY, DENVER, CO. FILED 4-18-2006.

HERCULES

THE MARK CONSISTS OF STANDARD CHARACTERS WITHOUT CLAIM TO ANY PARTICULAR FONT, STYLE, SIZE, OR COLOR.

FOR ALE; BEER (U.S. CLS. 45, 46 AND 48).
FIRST USE 1-20-2004; IN COMMERCE 2-6-2004.
PAUL F. GAST, EXAMINING ATTORNEY

SN 78-863,989. ANHEUSER-BUSCH, INCORPORATED, ST. LOUIS, MO. FILED 4-18-2006.

RED BRIDGE

THE MARK CONSISTS OF STANDARD CHARACTERS WITHOUT CLAIM TO ANY PARTICULAR FONT, STYLE, SIZE, OR COLOR.

FOR BEER (U.S. CLS. 45, 46 AND 48).
PAULA MAYS, EXAMINING ATTORNEY

CLASS 32—(Continued).

SN 78-865,451. GLOBAL BEVERAGE ENTERPRISES INC., FT. LAUDERDALE, FL. FILED 4-20-2006.

CHAMPAGNE OF THE ISLANDS

THE MARK CONSISTS OF STANDARD CHARACTERS WITHOUT CLAIM TO ANY PARTICULAR FONT, STYLE, SIZE, OR COLOR.

FOR NON ALCHOLIC BEVERAGES NAMELY CARBONATED BEVERAGES (U.S. CLS. 45, 46 AND 48).

FIRST USE 4-1-2006; IN COMMERCE 4-1-2006.

GILBERT SWIFT, EXAMINING ATTORNEY

SN 78-866,013. GRUPO CERVEZAS ALHAMBRA, S.L., 18012 GRANADA, SPAIN, FILED 4-20-2006.

ALHAMBRA

THE MARK CONSISTS OF STANDARD CHARACTERS WITHOUT CLAIM TO ANY PARTICULAR FONT, STYLE, SIZE, OR COLOR.

OWNER OF U.S. REG. NOS. 2,981,391 AND 2,985,762.

FOR BEERS (U.S. CLS. 45, 46 AND 48).

FIRST USE 0-0-1925; IN COMMERCE 4-0-1999.

GINA HAYES, EXAMINING ATTORNEY

SN 78-867,251. AMERICAN GENERAL DRINKING WATER, INC., INDUSTRY, CA. FILED 4-21-2006.

YANKEE MOUNTAIN

THE MARK CONSISTS OF STANDARD CHARACTERS WITHOUT CLAIM TO ANY PARTICULAR FONT, STYLE, SIZE, OR COLOR.

FOR DRINKING WATER (U.S. CLS. 45, 46 AND 48).

MARTHA SANTOMARTINO, EXAMINING ATTORNEY

CLASS 32—(Continued).

SN 78-867,830. EDGAR, DANIEL B., SCHNECKSVILLE, PA. FILED 4-24-2006.

Game Oil

THE MARK CONSISTS OF STANDARD CHARACTERS WITHOUT CLAIM TO ANY PARTICULAR FONT, STYLE, SIZE, OR COLOR.

FOR NON-ALCOHOLIC DRINKS, NAMELY, MINERAL WATERS, AERATED WATERS, FLAVORED WATERS, SOFT DRINKS, SPORTS DRINKS, ENERGY DRINKS, ISOTONIC DRINKS, HYPERTONIC DRINKS, HYPOTONIC DRINKS, CARBONATED SOFT DRINKS, PUNCHES, FRUIT DRINKS AND FRUIT JUICES; SODA WATERS AND SELTZER WATERS ENHANCED WITH VITAMINS, MINERALS NUTRIENTS, AMINO ACIDS AND/OR HERBS; POWDERS, CONCENTRATES, AND SYRUPS FOR MAKING SAME (U.S. CLS. 45, 46 AND 48).
TIMOTHY FINNEGAN, EXAMINING ATTORNEY

SN 78-868,640. ANHEUSER-BUSCH, INCORPORATED, ST. LOUIS, MO. FILED 4-25-2006.

HUDDLE UP AND...

THE MARK CONSISTS OF STANDARD CHARACTERS WITHOUT CLAIM TO ANY PARTICULAR FONT, STYLE, SIZE, OR COLOR.

FOR BEER (U.S. CLS. 45, 46 AND 48).
PAULA MAYS, EXAMINING ATTORNEY

CLASS 32—(Continued).

SN 78-868,737. FREELIFE INTERNATIONAL, LLC, MILFORD, CT. FILED 4-25-2006.



OWNER OF U.S. REG. NOS. 2,904,019, 2,942,083 AND 2,996,108.

NO CLAIM IS MADE TO THE EXCLUSIVE RIGHT TO USE "HIMALAYAN GOJI JUICE", APART FROM THE MARK AS SHOWN.

FOR FRUIT-BASED BEVERAGES THAT ARE ALSO NUTRITIONALLY FORTIFIED AND SPORTS DRINKS (U.S. CLS. 45, 46 AND 48).

FIRST USE 10-10-2003; IN COMMERCE 10-10-2003.
MONIQUE MILLER, EXAMINING ATTORNEY

SN 78-869,270. TOVAR, DOROTHY L., PLACERVILLE, CA. FILED 4-25-2006.

WHAT HAPPENS IN VEGAS STAYS IN VEGAS

THE MARK CONSISTS OF STANDARD CHARACTERS WITHOUT CLAIM TO ANY PARTICULAR FONT, STYLE, SIZE, OR COLOR.

OWNER OF U.S. REG. NOS. 2,930,998 AND 2,986,162.
NO CLAIM IS MADE TO THE EXCLUSIVE RIGHT TO USE "VEGAS", APART FROM THE MARK AS SHOWN.
FOR DRINKING WATER (U.S. CLS. 45, 46 AND 48).
CAROLYN GRAY, EXAMINING ATTORNEY

SN 78-869,427. KREJCI, SEAN V., SAN DIEGO, CA. FILED 4-25-2006.

dopa energy drink

THE MARK CONSISTS OF STANDARD CHARACTERS WITHOUT CLAIM TO ANY PARTICULAR FONT, STYLE, SIZE, OR COLOR.

NO CLAIM IS MADE TO THE EXCLUSIVE RIGHT TO USE ENERGY DRINK, APART FROM THE MARK AS SHOWN.

FOR ENERGY DRINKS (U.S. CLS. 45, 46 AND 48).
TONJA GASKINS, EXAMINING ATTORNEY

CLASS 32—(Continued).

SN 78-869,488. H2O BOTTLING, LLC, EUGENE, OR. FILED 4-25-2006.

TRUE H2O

THE MARK CONSISTS OF STANDARD CHARACTERS WITHOUT CLAIM TO ANY PARTICULAR FONT, STYLE, SIZE, OR COLOR.

OWNER OF U.S. REG. NO. 2,523,481.
NO CLAIM IS MADE TO THE EXCLUSIVE RIGHT TO USE "H2O", APART FROM THE MARK AS SHOWN.
SEC. 2(F) AS TO "TRUE".
FOR DRINKING WATER (U.S. CLS. 45, 46 AND 48).
H. M. FISHER, EXAMINING ATTORNEY

CLASS 32—(Continued).

SN 78-883,869. BBC BRANDS, LLC, BOSTON, MA. FILED 5-15-2006.

VARIETY IS THE SPICE OF LIFE

THE MARK CONSISTS OF STANDARD CHARACTERS WITHOUT CLAIM TO ANY PARTICULAR FONT, STYLE, SIZE, OR COLOR.

FOR ALE; BEER (U.S. CLS. 45, 46 AND 48).
JANICE KIM, EXAMINING ATTORNEY

SN 78-869,940. CHAMPION PERFORMANCE PRODUCTS, INC., DBA CHAMPION NUTRITION, CONCORD, CA. FILED 4-26-2006.

REVENGE

THE MARK CONSISTS OF STANDARD CHARACTERS WITHOUT CLAIM TO ANY PARTICULAR FONT, STYLE, SIZE, OR COLOR.

FOR SPORT AND ENERGY DRINK MIXES (U.S. CLS. 45, 46 AND 48).
FIRST USE 12-31-1999; IN COMMERCE 12-31-1999.
KRISTINA KLOIBER, EXAMINING ATTORNEY

SN 78-890,232. ANHEUSER-BUSCH, INCORPORATED, ST. LOUIS, MO. FILED 5-23-2006.

REAL MEN OF COMEDY

THE MARK CONSISTS OF STANDARD CHARACTERS WITHOUT CLAIM TO ANY PARTICULAR FONT, STYLE, SIZE, OR COLOR.

FOR BEER (U.S. CLS. 45, 46 AND 48).
PAULA MAYS, EXAMINING ATTORNEY

SN 78-883,828. HEALTHSIMPLE TOOLS, LLC, MINNEAPOLIS, MN. FILED 5-15-2006.

HEALTHSIMPLE

THE MARK CONSISTS OF STANDARD CHARACTERS WITHOUT CLAIM TO ANY PARTICULAR FONT, STYLE, SIZE, OR COLOR.

FOR NON-ALCOHOLIC BEVERAGES, NAMELY, CARBONATED BEVERAGES, FRUIT JUICES, FRUIT DRINKS, WHEY BEVERAGES, VEGETABLE JUICES; ENERGY DRINKS AND SPORTS DRINKS; AND SYRUPS, CONCENTRATES AND POWDERS FOR MAKING BEVERAGES; FLAVORED WATERS, MINERAL AND AERATED WATERS, SOFT DRINKS, ENERGY DRINKS, SPORTS DRINKS (U.S. CLS. 45, 46 AND 48).
RUDY R. SINGLETON, EXAMINING ATTORNEY

SN 78-895,364. BYB BRANDS, INC., CHARLOTTE, NC. FILED 5-30-2006.

SCALDED DOG

THE MARK CONSISTS OF STANDARD CHARACTERS WITHOUT CLAIM TO ANY PARTICULAR FONT, STYLE, SIZE, OR COLOR.

FOR NON-ALCOHOLIC BEVERAGES, NAMELY, ENERGY DRINKS (U.S. CLS. 45, 46 AND 48).
JENNIFER MARTIN, EXAMINING ATTORNEY

CLASS 32—(Continued).

SN 78-903,251. WEINER, RUSSELL G., LAS VEGAS, NV.
FILED 6-7-2006.

GIGANTE

THE MARK CONSISTS OF STANDARD CHARACTERS WITHOUT CLAIM TO ANY PARTICULAR FONT, STYLE, SIZE, OR COLOR.

THE FOREIGN WORDING IN THE MARK TRANSLATES INTO ENGLISH AS GIGANTIC.

FOR SPORTS DRINKS, NAMELY, ENERGY DRINKS (U.S. CLS. 45, 46 AND 48).

CHRISTOPHER BUONGIORNO, EXAMINING ATTORNEY

SN 78-903,252. WEINER, RUSSELL G., LAS VEGAS, NV.
FILED 6-7-2006.

ROCKSTAR GIGANTE

THE MARK CONSISTS OF STANDARD CHARACTERS WITHOUT CLAIM TO ANY PARTICULAR FONT, STYLE, SIZE, OR COLOR.

OWNER OF U.S. REG. NOS. 2,613,067, 3,071,688 AND OTHERS.

THE FOREIGN WORDING IN THE MARK TRANSLATES INTO ENGLISH AS GIGANTIC.

FOR SPORTS DRINKS, NAMELY, ENERGY DRINKS (U.S. CLS. 45, 46 AND 48).

CHRISTOPHER BUONGIORNO, EXAMINING ATTORNEY

SN 78-911,496. SOUTH BEACH BEVERAGE COMPANY, INC., NORWALK, CT. FILED 6-19-2006.

SOBE ESSENTIAL ENERGY

THE MARK CONSISTS OF STANDARD CHARACTERS WITHOUT CLAIM TO ANY PARTICULAR FONT, STYLE, SIZE, OR COLOR.

OWNER OF U.S. REG. NOS. 2,153,152, 2,345,815 AND OTHERS.

NO CLAIM IS MADE TO THE EXCLUSIVE RIGHT TO USE "ENERGY", APART FROM THE MARK AS SHOWN.

FOR SOFT DRINKS AND ENERGY DRINKS (U.S. CLS. 45, 46 AND 48).

DARRYL SPRUILL, EXAMINING ATTORNEY

CLASS 32—(Continued).

SN 78-933,640. MEAD JOHNSON & COMPANY, EVANSVILLE, IN. FILED 7-20-2006.

INCREDIJUICE

THE MARK CONSISTS OF STANDARD CHARACTERS WITHOUT CLAIM TO ANY PARTICULAR FONT, STYLE, SIZE, OR COLOR.

FOR NUTRITIONALLY ENHANCED FRUIT JUICES AND FRUIT JUICE-BASED PRODUCTS, NAMELY, FRUIT JUICE-BASED BEVERAGES CONTAINING VITAMINS, MINERALS, FOOD, DIETARY, AND NUTRITIONAL SUPPLEMENTS (U.S. CLS. 45, 46 AND 48).

MATTHEW MCDOWELL, EXAMINING ATTORNEY

SN 78-948,267. DEEGAN, BRIAN, TEMECULA, CA. FILED 8-9-2006.

HEVY HITTERS

THE MARK CONSISTS OF STANDARD CHARACTERS WITHOUT CLAIM TO ANY PARTICULAR FONT, STYLE, SIZE, OR COLOR.

FOR ENERGY DRINKS (U.S. CLS. 45, 46 AND 48).

SHARON MEIER, EXAMINING ATTORNEY

SN 78-968,877. COLORSTAR HOLDING B.V., AMSTERDAM, NETHERLANDS, FILED 9-7-2006.

AquaMio

THE MARK CONSISTS OF STANDARD CHARACTERS WITHOUT CLAIM TO ANY PARTICULAR FONT, STYLE, SIZE, OR COLOR.

FOR CONCENTRATES, SYRUPS OR POWDERS USED IN THE PREPARATION OF SOFT DRINKS; DRINKING WATER; FLAVORED WATERS; FRUIT FLAVORED SOFT DRINKS; MINERAL WATER; SODA WATER; SOFT DRINKS; SPARKLING WATER; SPORTS DRINKS; STILL WATER; TABLE WATER (U.S. CLS. 45, 46 AND 48).

JASON LOTT, EXAMINING ATTORNEY

CLASS 32—(Continued).

SN 79-009,752. SAI YING KO, BEIJING, CHINA, FILED 3-4-2005.

SurvivAll

THE MARK CONSISTS OF STANDARD CHARACTERS WITHOUT CLAIM TO ANY PARTICULAR FONT, STYLE, SIZE, OR COLOR.

PRIORITY DATE OF 11-12-2004 IS CLAIMED.

OWNER OF INTERNATIONAL REGISTRATION 0845981 DATED 3-4-2005, EXPIRES 3-4-2015.

FOR BEVERAGES, NAMELY, ENERGY DRINKS, FRUIT DRINKS, VEGETABLE JUICE, MINERAL WATERS WITH VITAMINS AND OTHER NUTRIENTS, SPORTS DRINKS, ISOTONIC DRINKS (U.S. CLS. 45, 46 AND 48).

WENDY GOODMAN, EXAMINING ATTORNEY

CLASS 33—(Continued).

SN 76-649,307. COGGAN, MARNE, PETALUMA, CA. AND FRIEDENBERG, DEBRA, PETALUMA, CA. FILED 10-27-2005.

SONATERA VINEYARD

THE MARK CONSISTS OF STANDARD CHARACTERS WITHOUT CLAIM TO ANY PARTICULAR FONT, STYLE, SIZE, OR COLOR.

OWNER OF U.S. REG. NO. 2,689,181.

NO CLAIM IS MADE TO THE EXCLUSIVE RIGHT TO USE "VINEYARD", APART FROM THE MARK AS SHOWN. FOR WINE (U.S. CLS. 47 AND 49).

FIRST USE 4-28-2004; IN COMMERCE 4-28-2004.

SANJEEV VOHRA, EXAMINING ATTORNEY

SN 79-022,848. ING. IVAN DUCKO, SK-831 02 BRATISLAVA, SLOVAKIA, FILED 11-9-2005.

ALCOHOL KILLER

THE MARK CONSISTS OF STANDARD CHARACTERS WITHOUT CLAIM TO ANY PARTICULAR FONT, STYLE, SIZE, OR COLOR.

PRIORITY DATE OF 5-12-2005 IS CLAIMED.

OWNER OF INTERNATIONAL REGISTRATION 0882405 DATED 11-9-2005, EXPIRES 11-9-2015.

FOR NON-ALCOHOLIC BEVERAGES, NAMELY, CARBONATED BEVERAGES, NON-CARBONATED BEVERAGES, ENERGY DRINKS, FLAVORED WATERS, FRUIT DRINKS, FRUIT-FLAVORED DRINKS, ISOTONIC DRINKS, SPORTS DRINKS, SOFT DRINKS, CONCENTRATES, SYRUPS AND POWDERS USED IN THE PREPARATION OF SOFT DRINKS, AND SOFT DRINKS, NAMELY SOFT DRINKS WHICH HELP TO REDUCE ALCOHOL IN SYSTEM (U.S. CLS. 45, 46 AND 48).

DAYNA BROWNE, EXAMINING ATTORNEY

SN 76-653,392. BONTEL, U.S.A., NEW YORK, NY. FILED 1-17-2006.

SICULI

THE MARK CONSISTS OF STANDARD CHARACTERS WITHOUT CLAIM TO ANY PARTICULAR FONT, STYLE, SIZE, OR COLOR.

FOR WINES (U.S. CLS. 47 AND 49).

FIRST USE 1-9-2006; IN COMMERCE 1-9-2006.

PETER B. BROMAGHIM, EXAMINING ATTORNEY

CLASS 33—WINES AND SPIRITS

SN 76-581,414. KANGAROO RIDGE WINE COMPANY, PTY LIMITED, TANUNDA 5352 SA, AUSTRALIA, FILED 3-15-2004.

THE AUSSIE

FOR WINE (U.S. CLS. 47 AND 49).

RONALD AIKENS, EXAMINING ATTORNEY

SN 76-653,422. BONTEL, U.S.A., NEW YORK, NY. FILED 1-17-2006.

SICANI

THE MARK CONSISTS OF STANDARD CHARACTERS WITHOUT CLAIM TO ANY PARTICULAR FONT, STYLE, SIZE, OR COLOR.

FOR WINES (U.S. CLS. 47 AND 49).

FIRST USE 1-17-2006; IN COMMERCE 1-17-2006.

PETER B. BROMAGHIM, EXAMINING ATTORNEY

CLASS 33—(Continued).

SN 78-356,103. AKCINE BENDROVE "STUMBRAS", KAUNAS, LITHUANIA, FILED 1-23-2004.



NO CLAIM IS MADE TO THE EXCLUSIVE RIGHT TO USE "VODKA, DEGTINE, AND PAGAMINTA IR IPILSTYTA LIETUVOJE", APART FROM THE MARK AS SHOWN.

THE COLOR(S) BLACK, RED, WHITE AND YELLOW IS/ARE CLAIMED AS A FEATURE OF THE MARK.

THE BOTTLE CAP CONSISTS OF ORNAMENTED SIGN AND THE WORDS PREZIDENTO DEGTINE WRITTEN IN SPECIAL TYPE. THE COLORS BLACK, RED AND WHITE APPEAR ON A BOTTLE CAP. THE BLACK COLOR APPEARS ON THE FRONT FACE OF THE BOTTLE IN DECORATED MEDALLION AND PICTURE OF THE BUILDING. THE RED COLOR APPEARS ON THE FRONT FACE OF BOTTLE ON DECORATED MEDALLION AND ON PEDESTAL. YELLOW COLOR APPEARS ON THE FRONT FACE OF THE BOTTLE ON ORNAMENTED WINDOW, MEDALLION, LIONS AND MEDALS BELOW THE WINDOW.

THE MARK CONSISTS OF IN PART OF A CONFIGURATION OF A BOTTLE, WHICH IS A CONTAINER FOR THE GOODS HAVING SPECIAL CYLINDRICAL FORM OF TRUNCATED AND UPTURNED CONE, RIBBED WITH BROADEN BRIMS NEAR NECK AND BASE, COMPRISING ON ITS FRONT FACE AN ORNAMENTED WINDOW THROUGH WHICH A PICTURE OF BUILDING APPEARS WITH A MAGNIFYING EFFECT, UNIMPAIRED BY THE TRANSPARENT LIQUID AND PACKAGING. OVER WINDOW, A DECORATED MEDALLION WITH THE STYLIZED AUROCHS INSIDE THE CIRCLE AND WORD STUMBRAS WRITTEN IN SPECIAL TYPE APPEAR. UNDER THE WINDOW, THE SIGN WITH TWO LIONS ON BOTH SIDES OF PEDESTAL IS DEPICTED AND WORDS VODKA AND PREZIDENTO APPEAR ON CENTRAL PART OF PEDESTAL. UNDER THE PEDESTAL THE WORD DEGTINE IS WRITTEN IN SPECIAL TYPE AND SIX MEDALS BELOW IT. IN THE LOWEST PART OF THE CONE, WORDS PAGAMINTA IR ISPILSTYTA LIETUVOJE ARE WRITTEN IN SPECIAL TYPE. THE BOTTLE CAP CONSISTS OF ORNAMENTED SIGN AND THE WORDS PREZIDENTO DEGTINE WRITTEN IN SPECIAL TYPE. THE COLORS BLACK, RED AND WHITE APPEAR ON A BOTTLE CAP. THE BLACK COLOR APPEARS ON THE FRONT FACE OF THE BOTTLE IN DECORATED MEDALLION AND PICTURE OF THE BUILDING. THE RED COLOR APPEARS ON THE FRONT FACE OF THE BOTTLE ON DECORATED MEDALLION AND ON PEDESTAL. YELLOW COLOR APPEARS ON THE FRONT FACE OF THE BOTTLE ON ORNAMENTED WINDOW, MEDALLION, LIONS AND MEDALS BELOW THE WINDOW.

THE FOREIGN WORDING IN THE MARK TRANSLATES INTO ENGLISH AS STUMBRAS-AUROCHS; PREZIDENTO-PRESIDENT'S; DEGTINE-VODKA; PAGAMINTA IR IPILSTYTA LIETUVOJE - MADE AND BOTTLED IN LITHUANIA.

THE NON-LATIN CHARACTER(S) IN THE MARK TRANSLITERATES INTO DEGTINE, ISPILSTYTA, AND THIS MEANS VODKA, BOTTLED IN ENGLISH.

FOR VODKA (U.S. CLS. 47 AND 49).
FIRST USE 12-0-1995; IN COMMERCE 8-0-2002.
PRISCILLA MILTON, EXAMINING ATTORNEY

CLASS 33—(Continued).

SN 78-494,269. PHILLIPS FARMS LLC, LODI, CA. FILED 10-4-2004.

RAPTURE

THE MARK CONSISTS OF STANDARD CHARACTERS WITHOUT CLAIM TO ANY PARTICULAR FONT, STYLE, SIZE, OR COLOR.

FOR WINE (U.S. CLS. 47 AND 49).
JASON LOTT, EXAMINING ATTORNEY

SN 78-536,199. MOET HENNESSY ASIA PACIFIC PTE LTD, #17-07 UE SQUARE, SINGAPORE, FILED 12-21-2004.

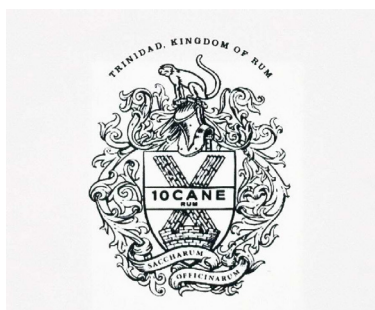

NO CLAIM IS MADE TO THE EXCLUSIVE RIGHT TO USE "RUM," "TRINIDAD," AND "SACCHARUM OFFICINARUM", APART FROM THE MARK AS SHOWN.

THE MARK CONSISTS OF A CREST LABEL WITH 10 CANE AND THE WORD RUM APPEARING UNDERNEATH; THE WORDS TRINIDAD, KINGDOM OF RUM, SACCHARUM OFFICINARUM; MONKEY DESIGN ON TOP OF CREST.

FOR SPIRITS AND LIQUEURS, NAMELY RUM AND RUM-BASED ALCOHOLIC BEVERAGES, PREPARED ALCOHOLIC COCKTAILS, FRUIT FLAVOURED ALCOHOLIC BEVERAGES (U.S. CLS. 47 AND 49).

GRETTA YAO, EXAMINING ATTORNEY

CLASS 33—(Continued).

SN 78-541,942. JACKSON WINE ESTATES INTERNATIONAL LIMITED, LOUGHLINSTOWN, COUNTY DUBLIN, IRELAND, FILED 1-4-2005.

DANCING DEVIL

THE MARK CONSISTS OF STANDARD CHARACTERS WITHOUT CLAIM TO ANY PARTICULAR FONT, STYLE, SIZE, OR COLOR.

PRIORITY CLAIMED UNDER SEC. 44(D) ON IRELAND APPLICATION NO. 200500005, FILED 1-4-2005, REG. NO. 231006, DATED 1-4-2005, EXPIRES 1-4-2015.

FOR WINE (U.S. CLS. 47 AND 49).
ALLISON SCHRODY, EXAMINING ATTORNEY

SN 78-604,360. SHELDON WINES, SALINAS, CA. FILED 4-7-2005.

Vinolocity

THE MARK CONSISTS OF STANDARD CHARACTERS WITHOUT CLAIM TO ANY PARTICULAR FONT, STYLE, SIZE, OR COLOR.

FOR RHONE STYLE BLENDED WINE (U.S. CLS. 47 AND 49).

FIRST USE 6-19-2002; IN COMMERCE 12-9-2004.
JIM RINGLE, EXAMINING ATTORNEY

SN 78-608,325. GEMTREE VINEYARDS PTY LTD, MCLAREN VALE, AUSTRALIA, FILED 4-13-2005.

UNCUT

THE MARK CONSISTS OF STANDARD CHARACTERS WITHOUT CLAIM TO ANY PARTICULAR FONT, STYLE, SIZE, OR COLOR.

FOR WINES, SPIRITS AND LIQUEURS (U.S. CLS. 47 AND 49).

KAELIE KUNG, EXAMINING ATTORNEY

CLASS 33—(Continued).

SN 78-629,522. OBSHCHESTVO S OGRANICHENNOY OTVETSTVENNOSTYU "MEZON GRIZ", KAZAN, RUSSIAN FED., FILED 5-13-2005.

AKDOV

THE MARK CONSISTS OF STANDARD CHARACTERS WITHOUT CLAIM TO ANY PARTICULAR FONT, STYLE, SIZE, OR COLOR.

PRIORITY CLAIMED UNDER SEC. 44(D) ON RUSSIAN FED. APPLICATION NO. 2005707961, FILED 4-8-2005, REG. NO. 296289, DATED 10-3-2006, EXPIRES 4-8-2015.

FOR VODKA (U.S. CLS. 47 AND 49).
STEPHANIE DAVIS, EXAMINING ATTORNEY

SN 78-632,198. PACIFIC FOODS OF OREGON, INC., TUALATIN, OR. FILED 5-18-2005.

ECKO

THE MARK CONSISTS OF STANDARD CHARACTERS WITHOUT CLAIM TO ANY PARTICULAR FONT, STYLE, SIZE, OR COLOR.

FOR PREPARED ALCOHOLIC COCKTAIL WITH A MALT BASE (U.S. CLS. 47 AND 49).

MARK SPARACINO, EXAMINING ATTORNEY

SN 78-636,521. NOTA BENE CELLARS, LTD., SEATTLE, WA. FILED 5-24-2005.

Abbinare

THE MARK CONSISTS OF STANDARD CHARACTERS WITHOUT CLAIM TO ANY PARTICULAR FONT, STYLE, SIZE, OR COLOR.

"THE FOREIGN WORDING IN THE MARK TRANSLATES INTO ENGLISH AS LINKED TOGETHER."

FOR WINE (U.S. CLS. 47 AND 49).

FIRST USE 12-27-2004; IN COMMERCE 4-2-2005.

AISHA CLARKE, EXAMINING ATTORNEY

CLASS 33—(Continued).

SN 78-662,486. HISTORIC WINES OF THE CAPE (PTY) LIMITED, CAPE TOWN, SOUTH AFRICA, FILED 7-1-2005.



OWNER OF SOUTH AFRICA REG. NO. 2000/25447, DATED 12-21-2000, EXPIRES 12-21-2010.

THE MARK CONSISTS OF THE WORDS LEOPARD'S LEAP PRESENTED IN A SCRIPT FORM AND THE DESIGN OF THREE LEOPARDS. THE SPOTS OF THE LEOPARDS ARE A FEATURE OF THE MARK AND DO NOT INDICATE SHADING. GRAY IS FOR SHADING PURPOSES AND IS NOT CLAIMED.

FOR WINES (U.S. CLS. 47 AND 49).
ALICE BENMAMAN, EXAMINING ATTORNEY

SN 78-670,351. WEST COAST CORPORATION INTERNATIONAL HOLDINGS (PTY) LTD, VREDENDAL 8160, SOUTH AFRICA, FILED 7-14-2005.



NO CLAIM IS MADE TO THE EXCLUSIVE RIGHT TO USE "SOUTH AFRICA", APART FROM THE MARK AS SHOWN.

THE MARK CONSISTS OF THE WORD GOIYA AND THE WORDS SOUTH AFRICA APPEARING IN A RECTANGULAR FIGURE WITH A SPIRAL FIGURE APPEARING ABOVE THE WORD GOIYA AND OF A FURTHER RECTANGULAR FIGURE APPEARING BELOW THE FIRST RECTANGULAR FIGURE AND CONTAINING A HIGHLY STYLIZED REPRESENTATION OF A HUMAN.

FOR WINES (U.S. CLS. 47 AND 49).
FIRST USE 6-30-2000; IN COMMERCE 6-30-2001.
LA TONIA FISHER, EXAMINING ATTORNEY

CLASS 33—(Continued).

SN 78-681,310. HIGH ENERGY HOLDINGS, LLC, WASHINGTON, DC. FILED 7-29-2005.

THE WORLD'S PERFECT PARTY
SPIRIT

THE MARK CONSISTS OF STANDARD CHARACTERS WITHOUT CLAIM TO ANY PARTICULAR FONT, STYLE, SIZE, OR COLOR.

FOR VODKA (U.S. CLS. 47 AND 49).
FIRST USE 3-17-2006; IN COMMERCE 3-17-2006.
CARRIE ACHEN, EXAMINING ATTORNEY

SN 78-681,538. BROWN-FORMAN CORPORATION, LOUISVILLE, KY. FILED 7-29-2005.



OWNER OF U.S. REG. NOS. 750,984 AND 2,858,065.
THE MARK CONSISTS OF A STALLION REARING WITH A LETTER "C" ON THE LEFT SIDE AND A LETTER "M" ON THE RIGHT SIDE OF THE STALLION.
FOR ALCOHOLIC BEVERAGES, NAMELY, DISTILLED SPIRITS (U.S. CLS. 47 AND 49).
FIRST USE 7-25-2005; IN COMMERCE 7-25-2005.
DEBRA LEE, EXAMINING ATTORNEY

SN 78-684,049. STEWART, DONALD, J., MERCED, CA. FILED 8-2-2005.

CORCOVADO

THE MARK CONSISTS OF STANDARD CHARACTERS WITHOUT CLAIM TO ANY PARTICULAR FONT, STYLE, SIZE, OR COLOR.

THE FOREIGN WORDING IN THE MARK TRANSLATES INTO ENGLISH AS HEART WHERE ARE YOU GOING.
FOR VODKA (U.S. CLS. 47 AND 49).
STEPHANIE DAVIS, EXAMINING ATTORNEY

CLASS 33—(Continued).

SN 78-695,271. DE BORTOLI WINES PTY LTD, BILBUL, NEW SOUTH WALES 2680, AUSTRALIA, FILED 8-18-2005.

WILLOWBANK

THE MARK CONSISTS OF STANDARD CHARACTERS WITHOUT CLAIM TO ANY PARTICULAR FONT, STYLE, SIZE, OR COLOR.

OWNER OF AUSTRALIA REG. NO. B624343, DATED 3-9-1994, EXPIRES 3-9-2011.

FOR WINES; FORTIFIED WINES; ALCOHOLIC BEVERAGES MADE OF FRUIT; DISTILLED SPIRITS; LIQUEURS (U.S. CLS. 47 AND 49).

SUE LAWRENCE, EXAMINING ATTORNEY

SN 78-700,687. MARK ANTHONY PROPERTIES LTD., VANCOUVER, BRITISH COLUMBIA, CANADA, FILED 8-25-2005.

49 NORTH

THE MARK CONSISTS OF STANDARD CHARACTERS WITHOUT CLAIM TO ANY PARTICULAR FONT, STYLE, SIZE, OR COLOR.

OWNER OF CANADA REG. NO. TMA561829, DATED 5-13-2002, EXPIRES 5-13-2017.

FOR WINES (U.S. CLS. 47 AND 49).

ANNE FARRELL, EXAMINING ATTORNEY

SN 78-707,115. WHITE ROCK DISTILLERIES, INC., LEWISTON, ME. FILED 9-6-2005.



QUINTESSENTIAL

OWNER OF U.S. REG. NO. 2,376,974.
FOR ALCOHOLIC BEVERAGES, NAMELY GIN (U.S. CLS. 47 AND 49).
FIRST USE 7-10-2005; IN COMMERCE 7-10-2005.
JULIE WATSON, EXAMINING ATTORNEY

CLASS 33—(Continued).

SN 78-710,091. NEVIS BLUFF WINES LIMITED, CROMWELL, NEW ZEALAND, FILED 9-9-2005.



PRIORITY CLAIMED UNDER SEC. 44(D) ON NEW ZEALAND APPLICATION NO. 735257, FILED 9-6-2005, REG. NO. 735257, DATED 4-6-2006, EXPIRES 9-6-2015.

FOR WINES, SPARKLING WINES, FORTIFIED WINES, LIQUEURS (U.S. CLS. 47 AND 49).

TIMOTHY FINNEGAN, EXAMINING ATTORNEY

SN 78-712,551. PHANTOM WINES, LLC, ST. HELENA, CA. FILED 9-14-2005.

LAVA ROCK VINEYARDS

THE MARK CONSISTS OF STANDARD CHARACTERS WITHOUT CLAIM TO ANY PARTICULAR FONT, STYLE, SIZE, OR COLOR.

NO CLAIM IS MADE TO THE EXCLUSIVE RIGHT TO USE "VINEYARDS", APART FROM THE MARK AS SHOWN.

FOR WINE (U.S. CLS. 47 AND 49).

ARETHA SOMERVILLE, EXAMINING ATTORNEY

SN 78-716,978. OPICI IMPORT CO. INC., GLEN ROCK, NJ. FILED 9-20-2005.

RMO ESTATES

THE MARK CONSISTS OF STANDARD CHARACTERS WITHOUT CLAIM TO ANY PARTICULAR FONT, STYLE, SIZE, OR COLOR.

NO CLAIM IS MADE TO THE EXCLUSIVE RIGHT TO USE "ESTATES", APART FROM THE MARK AS SHOWN.

FOR WINE (U.S. CLS. 47 AND 49).

CARRIE ACHEN, EXAMINING ATTORNEY

CLASS 33—(Continued).

SN 78-723,776. BEBIDAS INTELIGENTES, S.A. DE C.V., ATIZAPAN DE ZARAGOZA, MEXICO, FILED 9-29-2005.

CUACO

THE MARK CONSISTS OF STANDARD CHARACTERS WITHOUT CLAIM TO ANY PARTICULAR FONT, STYLE, SIZE, OR COLOR.

THE FOREIGN WORDING IN THE MARK TRANSLATES INTO ENGLISH AS HORSE.

FOR ALCOHOLIC BEVERAGES, NAMELY TEQUILA AND AGAVE-BASED ALCOHOLIC BEVERAGES (U.S. CLS. 47 AND 49).

JULIE GUTTADAURO, EXAMINING ATTORNEY

SN 78-727,620. VINIGALICIA, S.L., CHANTADA, LUGO, SPAIN, FILED 10-6-2005.

CERVANTINO

THE MARK CONSISTS OF STANDARD CHARACTERS WITHOUT CLAIM TO ANY PARTICULAR FONT, STYLE, SIZE, OR COLOR.

FOR ALCOHOLIC BEVERAGES OTHER THAN BEER, NAMELY, WINES (U.S. CLS. 47 AND 49).

AMY ALFIERI, EXAMINING ATTORNEY

SN 78-749,343. BANFI PRODUCTS CORPORATION, OLD BROOKVILLE, NY. FILED 11-8-2005.

SANTA COSTANZA

THE MARK CONSISTS OF STANDARD CHARACTERS WITHOUT CLAIM TO ANY PARTICULAR FONT, STYLE, SIZE, OR COLOR.

THE FOREIGN WORDING IN THE MARK TRANSLATES INTO ENGLISH AS SAINT CONSTANCE.

FOR WINES (U.S. CLS. 47 AND 49).

BARBARA GAYNOR, EXAMINING ATTORNEY

CLASS 33—(Continued).

SN 78-837,787. MELENDEZ, JOSE, FORTVILLE, IN. FILED 3-15-2006.

EL CENOTE

THE MARK CONSISTS OF STANDARD CHARACTERS WITHOUT CLAIM TO ANY PARTICULAR FONT, STYLE, SIZE, OR COLOR.

THE FOREIGN WORDING IN THE MARK TRANSLATES INTO ENGLISH AS "THE HOLE IN THE GROUND".

FOR ALCOHOLIC BEVERAGES, NAMELY, TEQUILA (U.S. CLS. 47 AND 49).

BRENDAN REGAN, EXAMINING ATTORNEY

SN 78-837,801. MELENDEZ, JOSE, FORTVILLE, IN. FILED 3-15-2006.

EL CENUUELO

THE MARK CONSISTS OF STANDARD CHARACTERS WITHOUT CLAIM TO ANY PARTICULAR FONT, STYLE, SIZE, OR COLOR.

THE FOREIGN WORDING IN THE MARK TRANSLATES INTO ENGLISH AS "THE DECOY".

FOR ALCOHOLIC BEVERAGES, NAMELY, TEQUILA (U.S. CLS. 47 AND 49).

BRENDAN REGAN, EXAMINING ATTORNEY

SN 78-837,812. MELENDEZ, JOSE, FORTVILLE, IN. FILED 3-15-2006.

LA CUNADA

THE MARK CONSISTS OF STANDARD CHARACTERS WITHOUT CLAIM TO ANY PARTICULAR FONT, STYLE, SIZE, OR COLOR.

THE FOREIGN WORDING IN THE MARK TRANSLATES INTO ENGLISH AS "THE SISTER-IN-LAW".

FOR ALCOHOLIC BEVERAGES, NAMELY, TEQUILA (U.S. CLS. 47 AND 49).

BRENDAN REGAN, EXAMINING ATTORNEY

CLASS 33—(Continued).

SN 78-837,881. MELENDEZ, JOSE, FORTVILLE, IN. FILED 3-15-2006.

Cuna de Oro

THE MARK CONSISTS OF STANDARD CHARACTERS WITHOUT CLAIM TO ANY PARTICULAR FONT, STYLE, SIZE, OR COLOR.

THE FOREIGN WORDING IN THE MARK TRANSLATES INTO ENGLISH AS "GOLDEN CRIB".

FOR ALCOHOLIC BEVERAGES, NAMELY, TEQUILA (U.S. CLS. 47 AND 49).

BRENDAN REGAN, EXAMINING ATTORNEY

CLASS 33—(Continued).

SN 78-837,921. MELENDEZ, JOSE, FORTVILLE, IN. FILED 3-15-2006.

Sin Cadenas

THE MARK CONSISTS OF STANDARD CHARACTERS WITHOUT CLAIM TO ANY PARTICULAR FONT, STYLE, SIZE, OR COLOR.

THE FOREIGN WORDING IN THE MARK TRANSLATES INTO ENGLISH AS "WITHOUT CHAINS".

FOR ALCOHOLIC BEVERAGES, NAMELY, TEQUILA (U.S. CLS. 47 AND 49).

BRENDAN REGAN, EXAMINING ATTORNEY

SN 78-837,894. MELENDEZ, JOSE, FORTVILLE, IN. FILED 3-15-2006.

Amor por Mexico

THE MARK CONSISTS OF STANDARD CHARACTERS WITHOUT CLAIM TO ANY PARTICULAR FONT, STYLE, SIZE, OR COLOR.

THE FOREIGN WORDING IN THE MARK TRANSLATES INTO ENGLISH AS "LOVE FOR MEXICO".

FOR ALCOHOLIC BEVERAGES, NAMELY, TEQUILA (U.S. CLS. 47 AND 49).

BRENDAN REGAN, EXAMINING ATTORNEY

SN 78-837,939. MELENDEZ, JOSE, FORTVILLE, IN. FILED 3-15-2006.

El Tesoro de Gamaliel

THE MARK CONSISTS OF STANDARD CHARACTERS WITHOUT CLAIM TO ANY PARTICULAR FONT, STYLE, SIZE, OR COLOR.

THE FOREIGN WORDING IN THE MARK TRANSLATES INTO ENGLISH AS "THE TREASURE OF GAMALIEL".

FOR ALCOHOLIC BEVERAGES, NAMELY, TEQUILA (U.S. CLS. 47 AND 49).

BRENDAN REGAN, EXAMINING ATTORNEY

SN 78-837,904. MELENDEZ, JOSE, FORTVILLE, IN. FILED 3-15-2006.

El Tesoro del Rodeo

THE MARK CONSISTS OF STANDARD CHARACTERS WITHOUT CLAIM TO ANY PARTICULAR FONT, STYLE, SIZE, OR COLOR.

THE FOREIGN WORDING IN THE MARK TRANSLATES INTO ENGLISH AS "THE TREASURE OF THE RODEO".

FOR ALCOHOLIC BEVERAGES, NAMELY, TEQUILA (U.S. CLS. 47 AND 49).

BRENDAN REGAN, EXAMINING ATTORNEY

SN 78-837,958. MELENDEZ, JOSE, FORTVILLE, IN. FILED 3-15-2006.

El Tesoro de Job

THE MARK CONSISTS OF STANDARD CHARACTERS WITHOUT CLAIM TO ANY PARTICULAR FONT, STYLE, SIZE, OR COLOR.

THE FOREIGN WORDING IN THE MARK TRANSLATES INTO ENGLISH AS "THE TREASURE OF JOB".

FOR ALCOHOLIC BEVERAGES, NAMELY, TEQUILA (U.S. CLS. 47 AND 49).

BRENDAN REGAN, EXAMINING ATTORNEY

CLASS 33—(Continued).

SN 78-845,298. WELL BLACK LLC, NEW YORK, NY. FILED 3-24-2006.

BLACKWELL JAMAICAN RUM

THE MARK CONSISTS OF STANDARD CHARACTERS WITHOUT CLAIM TO ANY PARTICULAR FONT, STYLE, SIZE, OR COLOR.

NO CLAIM IS MADE TO THE EXCLUSIVE RIGHT TO USE "JAMAICAN RUM", APART FROM THE MARK AS SHOWN.

FOR RUM AND RUM-BASED DRINKS (U.S. CLS. 47 AND 49).

MELISSA VALLILLO, EXAMINING ATTORNEY

SN 78-847,059. LABRASSEUR, FREDERICK J., EAGLE POINT, OR. AND LABRASSEUR, CANDACE A., EAGLE POINT, OR. FILED 3-27-2006.

LaBrasseur Vineyard

THE MARK CONSISTS OF STANDARD CHARACTERS WITHOUT CLAIM TO ANY PARTICULAR FONT, STYLE, SIZE, OR COLOR.

NO CLAIM IS MADE TO THE EXCLUSIVE RIGHT TO USE "VINEYARD", APART FROM THE MARK AS SHOWN. THE ENGLISH TRANSLATION OF LABRASSEUR IS THE BREWER.

FOR WINES (U.S. CLS. 47 AND 49).

REBECCA POVARCHUK, EXAMINING ATTORNEY

SN 78-847,796. UNITED STATES DISTILLED PRODUCTS COMPANY, PRINCETON, MN. FILED 3-28-2006.

TROPICAL PALMS

THE MARK CONSISTS OF STANDARD CHARACTERS WITHOUT CLAIM TO ANY PARTICULAR FONT, STYLE, SIZE, OR COLOR.

FOR RUM (U.S. CLS. 47 AND 49).

DAVID MILLER, EXAMINING ATTORNEY

CLASS 33—(Continued).

SN 78-847,848. UNITED STATES DISTILLED PRODUCTS COMPANY, PRINCETON, MN. FILED 3-28-2006.

ARTIC BLU

THE MARK CONSISTS OF STANDARD CHARACTERS WITHOUT CLAIM TO ANY PARTICULAR FONT, STYLE, SIZE, OR COLOR.

FOR VODKA (U.S. CLS. 47 AND 49).

DAVID MILLER, EXAMINING ATTORNEY

SN 78-847,858. UNITED STATES DISTILLED PRODUCTS COMPANY, PRINCETON, MN. FILED 3-28-2006.

ARCTIC BLU

THE MARK CONSISTS OF STANDARD CHARACTERS WITHOUT CLAIM TO ANY PARTICULAR FONT, STYLE, SIZE, OR COLOR.

FOR VODKA (U.S. CLS. 47 AND 49).

DAVID MILLER, EXAMINING ATTORNEY

SN 78-850,518. CORPORATIVO LAS AMERICAS SA DE CV, MEXICO, MEXICO, FILED 3-30-2006.

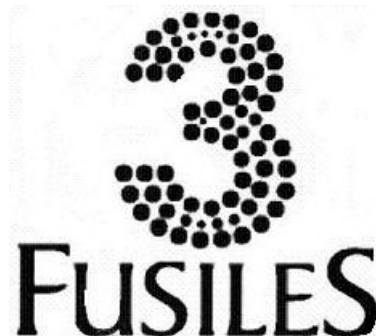

THE MARK CONSISTS OF THE NUMBER 3 FORMED BY MANY DOTS, IN THE BOTTOM APPEARS THE WORD "FUSILES".

THE FOREIGN WORDING IN THE MARK TRANSLATES INTO ENGLISH AS "3 RIFLES".

FOR TEQUILA (U.S. CLS. 47 AND 49).

LA TONIA FISHER, EXAMINING ATTORNEY

CLASS 33—(Continued).

SN 78-853,063. GLOBELINK, LLC, LA JOLLA, CA. FILED 4-4-2006.

China Beauty

THE MARK CONSISTS OF STANDARD CHARACTERS WITHOUT CLAIM TO ANY PARTICULAR FONT, STYLE, SIZE, OR COLOR.

NO CLAIM IS MADE TO THE EXCLUSIVE RIGHT TO USE "CHINA", APART FROM THE MARK AS SHOWN.

FOR GRAPE WINE, NATURAL SPARKLING WINES, RED WINE, TABLE WINES, WHITE WINE, WINE, WINES, ALL PRODUCED IN CHINA (U.S. CLS. 47 AND 49).

LYDIA BELZER, EXAMINING ATTORNEY

SN 78-854,577. MIURA VINEYARDS, LLC, SANTA ROSA, CA. FILED 4-5-2006.

ARNOA

THE MARK CONSISTS OF STANDARD CHARACTERS WITHOUT CLAIM TO ANY PARTICULAR FONT, STYLE, SIZE, OR COLOR.

FOR WINES (U.S. CLS. 47 AND 49).

FIRST USE 6-1-2005; IN COMMERCE 6-1-2005.

GEORGE LORENZO, EXAMINING ATTORNEY

SN 78-854,910. RED SEA TRADING, LLC, TEWKSBURY, MA. FILED 4-5-2006.

HAMMER + SICKLE

THE MARK CONSISTS OF STANDARD CHARACTERS WITHOUT CLAIM TO ANY PARTICULAR FONT, STYLE, SIZE, OR COLOR.

FOR VODKA (U.S. CLS. 47 AND 49).

CHARISMA HAMPTON, EXAMINING ATTORNEY

CLASS 33—(Continued).

SN 78-856,312. TSFAT SPIRITS OF ISRAEL, LLC, MINNETONKA, MN. FILED 4-7-2006.

AVIV

THE MARK CONSISTS OF STANDARD CHARACTERS WITHOUT CLAIM TO ANY PARTICULAR FONT, STYLE, SIZE, OR COLOR.

THE ENGLISH TRANSLATION OF THE WORD "AVIV" IN THE MARK IS "SPRING".

FOR DISTILLED SPIRITS (U.S. CLS. 47 AND 49).

GILBERT SWIFT, EXAMINING ATTORNEY

SN 78-856,653. DYNAMIC MARKETING GROUP, LLC, SADDLE BROOK, NJ. FILED 4-7-2006.

MARTUNI

THE MARK CONSISTS OF STANDARD CHARACTERS WITHOUT CLAIM TO ANY PARTICULAR FONT, STYLE, SIZE, OR COLOR.

FOR ALCOHOLIC BEVERAGES, NAMELY, DISTILLED SPIRITS (U.S. CLS. 47 AND 49).

LINDA MICKLEBURGH, EXAMINING ATTORNEY

SN 78-856,695. SEGGERMAN, FREDERICK B., DBA FREDERICK B. SEGGERMAN SELECTIONS, HADDAM, CT. FILED 4-7-2006.

LA COSECHA

THE MARK CONSISTS OF STANDARD CHARACTERS WITHOUT CLAIM TO ANY PARTICULAR FONT, STYLE, SIZE, OR COLOR.

OWNER OF U.S. REG. NO. 1,978,197.

THE FOREIGN WORDING IN THE MARK TRANSLATES INTO ENGLISH AS "THE HARVEST".

FOR WINE (U.S. CLS. 47 AND 49).

FIRST USE 3-1-2003; IN COMMERCE 3-1-2003.

KATHERINE M. DUBRAY, EXAMINING ATTORNEY

CLASS 33—(Continued).

SN 78-856,748. NEAL FAMILY VINEYARDS LLC, ST. HELENA, CA. FILED 4-7-2006.

LIGHTNING RIDGE

THE MARK CONSISTS OF STANDARD CHARACTERS WITHOUT CLAIM TO ANY PARTICULAR FONT, STYLE, SIZE, OR COLOR.
FOR WINE (U.S. CLS. 47 AND 49).
LA TONIA FISHER, EXAMINING ATTORNEY

CLASS 33—(Continued).

SN 78-857,245. BFC TEQUILA LIMITED, DUBLIN 22, IRELAND, FILED 4-8-2006.

TRANSCEND THE TYPICAL

THE MARK CONSISTS OF STANDARD CHARACTERS WITHOUT CLAIM TO ANY PARTICULAR FONT, STYLE, SIZE, OR COLOR.
FOR ALCOHOLIC BEVERAGES, NAMELY, DISTILLED SPIRITS (U.S. CLS. 47 AND 49).
MARLENE BELL, EXAMINING ATTORNEY

SN 78-858,158. GANDONA, INC., NAPA, CA. FILED 4-10-2006.

GANDONA

THE MARK CONSISTS OF STANDARD CHARACTERS WITHOUT CLAIM TO ANY PARTICULAR FONT, STYLE, SIZE, OR COLOR.
FOR WINE (U.S. CLS. 47 AND 49).
GEORGE LORENZO, EXAMINING ATTORNEY

SN 78-859,281. KOBRAND CORPORATION, NEW YORK, NY. FILED 4-11-2006.

ALIZE ROSE

THE MARK CONSISTS OF STANDARD CHARACTERS WITHOUT CLAIM TO ANY PARTICULAR FONT, STYLE, SIZE, OR COLOR.

OWNER OF U.S. REG. NOS. 1,397,073 AND 3,118,024.
NO CLAIM IS MADE TO THE EXCLUSIVE RIGHT TO USE "ROSE", APART FROM THE MARK AS SHOWN.
THE FOREIGN WORDING IN THE MARK TRANSLATES INTO ENGLISH AS "SOFT" AS APPLIED TO TRADEWINDS.

FOR LIQUEURS (U.S. CLS. 47 AND 49).
TINA BROWN, EXAMINING ATTORNEY

SN 78-857,090. BLUEROCK VINEYARD, LLC, TIBURON, CA. FILED 4-7-2006.



THE COLOR(S) BLACK, BLUE AND SILVER IS/ARE CLAIMED AS A FEATURE OF THE MARK.

THE MARK CONSISTS OF A RECTANGULAR HORIZONTAL LABEL POSITIONED ON THE TOP 1/3 OF THE BODY OF A WINE BOTTLE, SUCH LABEL BEING IRIDESCENT BLUE IN COLOR WITH BLACK STRIPES LOCATED AT THE TOP AND BOTTOM BORDERS OF THE LABEL AND THE WORDS "BLUE" AND "ROCK" APPEARING IN SILVER IRIDESCENT LETTERING IN THE MIDDLE OF THE LABEL WITH A SILVER IRIDESCENT EIGHT-POINTED STAR LOCATED BETWEEN THE TWO WORDS, AND A BLUE STRIPE LOCATED ON THE NECK OF THE WINE BOTTLE POSITIONED DIRECTLY BELOW THE LIP OF THE WINE BOTTLE. THE SHAPE OF THE WINE BOTTLE IS INDICATED IN DOTTED LINES TO SHOW THAT IT IS NOT PART OF THE MARK AND ONLY SERVES TO SHOW POSITIONING OF THE LABEL AND THE BLUE STRIPE ON THE BOTTLE.

FOR WINE (U.S. CLS. 47 AND 49).
FIRST USE 10-31-2001; IN COMMERCE 10-31-2001.
KEVON CHISOLM, EXAMINING ATTORNEY

CLASS 33—(Continued).

SN 78-859,285. KOBRAND CORPORATION, NEW YORK, NY. FILED 4-11-2006.

ALIZE MANGO

THE MARK CONSISTS OF STANDARD CHARACTERS WITHOUT CLAIM TO ANY PARTICULAR FONT, STYLE, SIZE, OR COLOR.

OWNER OF U.S. REG. NOS. 1,397,073 AND 3,118,024.

NO CLAIM IS MADE TO THE EXCLUSIVE RIGHT TO USE "MANGO", APART FROM THE MARK AS SHOWN.

THE FOREIGN WORDING IN THE MARK TRANSLATES INTO ENGLISH AS "SOFT" AS APPLIED TO TRADEWINDS.

FOR LIQUEURS (U.S. CLS. 47 AND 49).

TINA BROWN, EXAMINING ATTORNEY

SN 78-860,091. WINEXPERT INC., ST. CATHARINE'S, ONTARIO, CANADA, FILED 4-12-2006.

SELECTION INTERNATIONAL

THE MARK CONSISTS OF STANDARD CHARACTERS WITHOUT CLAIM TO ANY PARTICULAR FONT, STYLE, SIZE, OR COLOR.

OWNER OF U.S. REG. NOS. 2,860,063, 2,864,912 AND 2,895,249.

FOR WINE MAKING KITS CONSISTING PRIMARILY OF FRUIT JUICE OR FRUIT JUICE CONCENTRATES AND CHEMICAL ADDITIVES, AND WHICH MAY CONTAIN DRIED FLOWERS AND HERBS, WOOD CHIPS, ACTIVE DRY WINE YEAST, CLARIFYING AGENTS, FINING AGENTS, STABILIZERS, SULPHUR DIOXIDE, LIQUID INVERT SUGAR, DIAMMONIUM PHOSPHATE, CITRIC ACID, MALIC ACID, TARTARIC ACID, BENTONITE, POTASSIUM SORBATE, YEAST, POTASSIUM METABISULPHITE, OAK EXTRACT, OAK CHIPS, ELDERFLOWERS, ELDERBERRIES, TANNIN, SODIUM BENZOATE, GLUCOSE, ISINGLASS, CHITOSAN, KIESELSOL, LABELS, GRAPE JUICE, CRUSHED GRAPES (U.S. CLS. 47 AND 49).

FIRST USE 12-31-1997; IN COMMERCE 12-31-1997.

DANIEL RUSSELL, EXAMINING ATTORNEY

SN 78-860,199. TIMES TEN CELLARS, LP, DALLAS, TX. FILED 4-12-2006.

CATHEDRAL MOUNTAIN VINEYARD

THE MARK CONSISTS OF STANDARD CHARACTERS WITHOUT CLAIM TO ANY PARTICULAR FONT, STYLE, SIZE, OR COLOR.

NO CLAIM IS MADE TO THE EXCLUSIVE RIGHT TO USE "VINEYARD", APART FROM THE MARK AS SHOWN.

FOR WINE (U.S. CLS. 47 AND 49).

MELISSA VALLILLO, EXAMINING ATTORNEY

CLASS 33—(Continued).

SN 78-860,208. TIMES TEN CELLARS, LP, DALLAS, TX. FILED 4-12-2006.



FOR WINE (U.S. CLS. 47 AND 49).

FIRST USE 8-2-2005; IN COMMERCE 8-2-2005.

MELISSA VALLILLO, EXAMINING ATTORNEY

SN 78-860,888. MAPLE CREEK WINERY LLC, YORKVILLE, CA. FILED 4-13-2006.

BUCKIN' BLANCO

THE MARK CONSISTS OF STANDARD CHARACTERS WITHOUT CLAIM TO ANY PARTICULAR FONT, STYLE, SIZE, OR COLOR.

NO CLAIM IS MADE TO THE EXCLUSIVE RIGHT TO USE "BLANCO", APART FROM THE MARK AS SHOWN.

THE ENGLISH TRANSLATION OF "BLANCO" IS WHITE.

FOR WINE (U.S. CLS. 47 AND 49).

FIRST USE 4-4-2006; IN COMMERCE 4-4-2006.

SAMUEL E. SHARPER JR., EXAMINING ATTORNEY

SN 78-860,890. TEQUILA DON JULIO, S.A. DE C.V., JALISCO, MEXICO, FILED 4-13-2006.

DON JULIO REAL

THE MARK CONSISTS OF STANDARD CHARACTERS WITHOUT CLAIM TO ANY PARTICULAR FONT, STYLE, SIZE, OR COLOR.

OWNER OF U.S. REG. NOS. 2,088,472, 3,049,490 AND OTHERS.

THE NAME DON JULIO GONZALEZ ESTRADA IDENTIFIES A LIVING INDIVIDUAL WHOSE CONSENT IS OF RECORD.

FOR ALCOHOLIC BEVERAGES, NAMELY TEQUILA (U.S. CLS. 47 AND 49).

FIRST USE 11-0-2003; IN COMMERCE 11-0-2003.

SAMUEL E. SHARPER JR., EXAMINING ATTORNEY

CLASS 33—(Continued).

SN 78-861,388. BUONCRISTIANI, JASON T., NAPA, CA.
FILED 4-13-2006.

GEMELLA

THE MARK CONSISTS OF STANDARD CHARACTERS
WITHOUT CLAIM TO ANY PARTICULAR FONT, STYLE,
SIZE, OR COLOR.

THE FOREIGN WORDING IN THE MARK TRANSLATES
INTO ENGLISH AS TWIN.

FOR WINE (U.S. CLS. 47 AND 49).

STEVEN R. FINE, EXAMINING ATTORNEY

CLASS 33—(Continued).

SN 78-861,464. VIGNOBLES HENRI DUBOSCQ ET FILS,
SAINT-ESTEPHE, FRANCE, FILED 4-13-2006.

CHATEAU HAUT-MARBUZET

THE MARK CONSISTS OF STANDARD CHARACTERS
WITHOUT CLAIM TO ANY PARTICULAR FONT, STYLE,
SIZE, OR COLOR.

NO CLAIM IS MADE TO THE EXCLUSIVE RIGHT TO
USE "CHATEAU", APART FROM THE MARK AS SHOWN.
FOR WINES (U.S. CLS. 47 AND 49).

FIRST USE 0-0-1932; IN COMMERCE 0-0-1932.

JUDITH HELFMAN, EXAMINING ATTORNEY

SN 78-861,411. BUONCRISTIANI WINE CO., LLC, NAPA, CA.
FILED 4-13-2006.

O.P.C.

THE MARK CONSISTS OF STANDARD CHARACTERS
WITHOUT CLAIM TO ANY PARTICULAR FONT, STYLE,
SIZE, OR COLOR.

FOR WINE (U.S. CLS. 47 AND 49).

FIRST USE 0-0-1999; IN COMMERCE 11-0-2001.

ANDREA EVANS, EXAMINING ATTORNEY

SN 78-862,163. AROFF, PATRICK, SANTA MONICA, CA.
FILED 4-14-2006.



FOR DISTILLED LIQUOR AND SPIRITS (U.S. CLS. 47
AND 49).

JESSICA A. POWERS, EXAMINING ATTORNEY

SN 78-861,457. BIZEUL, HERVE, VINGRAU, FRANCE,
FILED 4-13-2006.

WALDEN

THE MARK CONSISTS OF STANDARD CHARACTERS
WITHOUT CLAIM TO ANY PARTICULAR FONT, STYLE,
SIZE, OR COLOR.

FOR WINES (U.S. CLS. 47 AND 49).

FIRST USE 0-0-2004; IN COMMERCE 0-0-2004.

MATTHEW MCDOWELL, EXAMINING ATTORNEY

SN 78-862,664. UNFILTERED NAPA LLC, NAPA, CA. FILED
4-17-2006.

THROWBACK

THE MARK CONSISTS OF STANDARD CHARACTERS
WITHOUT CLAIM TO ANY PARTICULAR FONT, STYLE,
SIZE, OR COLOR.

FOR WINE (U.S. CLS. 47 AND 49).

JUSTINE D. PARKER, EXAMINING ATTORNEY

CLASS 33—(Continued).

SN 78-862,809. DELTA DAWN PTY LTD., WYBONG UPPER VALLEY, AUSTRALIA, FILED 4-17-2006.

Barn Buster

THE MARK CONSISTS OF STANDARD CHARACTERS WITHOUT CLAIM TO ANY PARTICULAR FONT, STYLE, SIZE, OR COLOR.

FOR WINE (U.S. CLS. 47 AND 49).
FIRST USE 4-1-2006; IN COMMERCE 4-1-2006.
STEVEN PEREZ, EXAMINING ATTORNEY

CLASS 33—(Continued).

SN 78-862,852. DELTA DAWN PTY LTD., UPPER HUNTER VALLEY, AUSTRALIA, FILED 4-17-2006.

Hell Raiser

THE MARK CONSISTS OF STANDARD CHARACTERS WITHOUT CLAIM TO ANY PARTICULAR FONT, STYLE, SIZE, OR COLOR.

FOR WINE (U.S. CLS. 47 AND 49).
FIRST USE 4-1-2006; IN COMMERCE 4-1-2006.
STEVEN PEREZ, EXAMINING ATTORNEY

SN 78-862,829. DELTA DAWN PTY LTD., UPPER HUNTER VALLEY, AUSTRALIA, FILED 4-17-2006.

Rip Snorter

THE MARK CONSISTS OF STANDARD CHARACTERS WITHOUT CLAIM TO ANY PARTICULAR FONT, STYLE, SIZE, OR COLOR.

FOR WINE (U.S. CLS. 47 AND 49).
FIRST USE 4-1-2006; IN COMMERCE 4-1-2006.
STEVEN PEREZ, EXAMINING ATTORNEY

SN 78-863,070. JAMMET, ANDRE MICHEL, NEW YORK, NY, AND JAMMET, RITA BEDR, NEW YORK, NY, FILED 4-17-2006.

LA CARAVELLE

THE MARK CONSISTS OF STANDARD CHARACTERS WITHOUT CLAIM TO ANY PARTICULAR FONT, STYLE, SIZE, OR COLOR.

THE FOREIGN WORDING IN THE MARK TRANSLATES INTO ENGLISH AS THE CARAVEL.
FOR WINES AND SPIRITS (U.S. CLS. 47 AND 49).
FIRST USE 12-24-1997; IN COMMERCE 12-24-1997.
JOHN WILKE, EXAMINING ATTORNEY

SN 78-862,841. DELTA DAWN PTY LTD., UPPER HUNTER VALLEY, AUSTRALIA, FILED 4-17-2006.

Hay Burner

THE MARK CONSISTS OF STANDARD CHARACTERS WITHOUT CLAIM TO ANY PARTICULAR FONT, STYLE, SIZE, OR COLOR.

FOR WINE (U.S. CLS. 47 AND 49).
FIRST USE 4-1-2006; IN COMMERCE 4-1-2006.
STEVEN PEREZ, EXAMINING ATTORNEY

SN 78-864,054. SMITH & HOOK WINERY, INC., SOLEDAD, CA. FILED 4-18-2006.

LUCIENNE

THE MARK CONSISTS OF STANDARD CHARACTERS WITHOUT CLAIM TO ANY PARTICULAR FONT, STYLE, SIZE, OR COLOR.

FOR WINE (U.S. CLS. 47 AND 49).
DAYNA BROWNE, EXAMINING ATTORNEY

CLASS 33—(Continued).

SN 78-864,226. WILD HORSE VALLEY RANCH, INC., NAPA, CA. FILED 4-18-2006.

WHVR

THE MARK CONSISTS OF STANDARD CHARACTERS WITHOUT CLAIM TO ANY PARTICULAR FONT, STYLE, SIZE, OR COLOR.
FOR WINE (U.S. CLS. 47 AND 49).
SHARON MEIER, EXAMINING ATTORNEY

CLASS 33—(Continued).

SN 78-865,036. LEVINE, DONNA, A., CASTLE ROCK, DE. FILED 4-19-2006.

THE ONLY CAB ON THE ROAD

THE MARK CONSISTS OF STANDARD CHARACTERS WITHOUT CLAIM TO ANY PARTICULAR FONT, STYLE, SIZE, OR COLOR.
FOR WINE (U.S. CLS. 47 AND 49).
ALICE BENMAMAN, EXAMINING ATTORNEY

SN 78-864,228. SCV LES VIGNERONS DE BAIXAS - VIGNOBLES DOM BRIAL, BAIXAS, FRANCE, FILED 4-18-2006.



THE COLOR(S) RED IS/ARE CLAIMED AS A FEATURE OF THE MARK.
THE MARK CONSISTS OF THE TERM ROZY IN THE COLOR RED.
FOR WINES (U.S. CLS. 47 AND 49).
SHARON MEIER, EXAMINING ATTORNEY

SN 78-865,124. SOUTHERN COMFORT PROPERTIES, INC., SAN RAFAEL, CA. FILED 4-19-2006.

START THINGS UP WITH SOCO

THE MARK CONSISTS OF STANDARD CHARACTERS WITHOUT CLAIM TO ANY PARTICULAR FONT, STYLE, SIZE, OR COLOR.
OWNER OF U.S. REG. NO. 2,254,264.
FOR ALCOHOLIC BEVERAGES, NAMELY, DISTILLED SPIRITS (U.S. CLS. 47 AND 49).
STANLEY I. OSBORNE, EXAMINING ATTORNEY

SN 78-864,507. DISTILLED RESOURCES, INCORPORATED, RIGBY, ID. FILED 4-19-2006.



NO CLAIM IS MADE TO THE EXCLUSIVE RIGHT TO USE "DISTILLED RESOURCES INC." AND THE OUTLINE OF THE STATE OF IDAHO, APART FROM THE MARK AS SHOWN.
FOR DISTILLED SPIRITS (U.S. CLS. 47 AND 49).
JOHN SCHUYLER YARD, EXAMINING ATTORNEY

SN 78-865,447. FOLIO WINE COMPANY, LLC, NAPA, CA. FILED 4-20-2006.

Blue Note

THE MARK CONSISTS OF STANDARD CHARACTERS WITHOUT CLAIM TO ANY PARTICULAR FONT, STYLE, SIZE, OR COLOR.
FOR WINE (U.S. CLS. 47 AND 49).
PAULA MAYS, EXAMINING ATTORNEY

CLASS 33—(Continued).

SN 78-865,675. SUNSTATE PTY. LTD., DUNSBOROUGH, AUSTRALIA, FILED 4-20-2006.

WILLS DOMAIN

THE MARK CONSISTS OF STANDARD CHARACTERS WITHOUT CLAIM TO ANY PARTICULAR FONT, STYLE, SIZE, OR COLOR.

OWNER OF AUSTRALIA REG. NO. 873810, DATED 4-27-2001, EXPIRES 4-27-2011.
FOR WINE (U.S. CLS. 47 AND 49).
KATINA MISTER, EXAMINING ATTORNEY

CLASS 33—(Continued).

SN 78-868,548. SANDWICH ISLANDS DISTILLING CORPORATION, PEWEE VALLEY, KY. FILED 4-24-2006.

Pau

THE MARK CONSISTS OF STANDARD CHARACTERS WITHOUT CLAIM TO ANY PARTICULAR FONT, STYLE, SIZE, OR COLOR.

FOR VODKA (U.S. CLS. 47 AND 49).
ALLISON HOLTZ, EXAMINING ATTORNEY

SN 78-868,011. UNITED STATES DISTILLED PRODUCTS COMPANY, PRINCETON, MN. FILED 4-24-2006.

TROPIC ISLE PALMS

THE MARK CONSISTS OF STANDARD CHARACTERS WITHOUT CLAIM TO ANY PARTICULAR FONT, STYLE, SIZE, OR COLOR.

FOR RUM (U.S. CLS. 47 AND 49).
DAVID MILLER, EXAMINING ATTORNEY

SN 78-871,303. SOYUZ - VICTAN GROUP LTD, DOUGLAS, ISLE OF MAN, FILED 4-27-2006.

THE SILK VODKA

THE MARK CONSISTS OF STANDARD CHARACTERS WITHOUT CLAIM TO ANY PARTICULAR FONT, STYLE, SIZE, OR COLOR.

NO CLAIM IS MADE TO THE EXCLUSIVE RIGHT TO USE "VODKA", APART FROM THE MARK AS SHOWN.
FOR VODKA (U.S. CLS. 47 AND 49).
TINA BROWN, EXAMINING ATTORNEY

SN 78-868,126. WINESTYLES, INC., MARGATE, FL. FILED 4-24-2006.

WINESTYLES

THE MARK CONSISTS OF STANDARD CHARACTERS WITHOUT CLAIM TO ANY PARTICULAR FONT, STYLE, SIZE, OR COLOR.

OWNER OF U.S. REG. NO. 2,878,856.
FOR WINE (U.S. CLS. 47 AND 49).
FIRST USE 11-30-2005; IN COMMERCE 11-30-2005.
JASON ROTH, EXAMINING ATTORNEY

SN 78-871,314. SOYUZ - VICTAN GROUP LTD, DOUGLAS, ISLE OF MAN, FILED 4-27-2006.

**YOU JUST KNOW WHEN IT IS
SILK**

THE MARK CONSISTS OF STANDARD CHARACTERS WITHOUT CLAIM TO ANY PARTICULAR FONT, STYLE, SIZE, OR COLOR.

FOR VODKA (U.S. CLS. 47 AND 49).
TINA BROWN, EXAMINING ATTORNEY

CLASS 33—(Continued).

SN 78-871,455. C. MONDAVI & SONS, ST. HELENA, CA.
FILED 4-27-2006.

TRUST IN A FAMILY NAME

THE MARK CONSISTS OF STANDARD CHARACTERS
WITHOUT CLAIM TO ANY PARTICULAR FONT, STYLE,
SIZE, OR COLOR.

FOR WINE (U.S. CLS. 47 AND 49).
FIRST USE 12-0-2000; IN COMMERCE 12-0-2000.
ROBERT C. CLARK JR., EXAMINING ATTORNEY

CLASS 33—(Continued).

SN 78-875,237. BISON CAPITAL, VENICE, FL. FILED 5-3-
2006.

Canada Goose

THE MARK CONSISTS OF STANDARD CHARACTERS
WITHOUT CLAIM TO ANY PARTICULAR FONT, STYLE,
SIZE, OR COLOR.

NO CLAIM IS MADE TO THE EXCLUSIVE RIGHT TO
USE "CANADA", APART FROM THE MARK AS SHOWN.
FOR WHISKY (U.S. CLS. 47 AND 49).
WENDY GOODMAN, EXAMINING ATTORNEY

SN 78-882,200. VINO 100, LLC, BALA CYNWYD, PA. FILED
5-12-2006.

SN 78-871,604. KAUTZ VINEYARDS, INC, DBA IRONSTONE
VINEYARDS CORPORATION, MURPHYS, CA. FILED 4-
27-2006.

**Andean Archer**

THE MARK CONSISTS OF STANDARD CHARACTERS
WITHOUT CLAIM TO ANY PARTICULAR FONT, STYLE,
SIZE, OR COLOR.

NO CLAIM IS MADE TO THE EXCLUSIVE RIGHT TO
USE "ANDEAN", APART FROM THE MARK AS SHOWN.
FOR WINES (U.S. CLS. 47 AND 49).
JIM RINGLE, EXAMINING ATTORNEY

SN 78-883,568. ELVIS PRESLEY ENTERPRISES, INC., MEM-
PHIS, TN. FILED 5-15-2006.

OWNER OF U.S. REG. NO. 2,945,700.
NO CLAIM IS MADE TO THE EXCLUSIVE RIGHT TO
USE "VINEYARDS" AND "2005", "MERLOT", "LODI APPE-
LATION", APART FROM THE MARK AS SHOWN.

THE COLOR(S) TAN, RED, PURPLE, BROWN, BLACK
AND WHITE IS/ARE CLAIMED AS A FEATURE OF THE
MARK.

THE COLOR TAN APPEARS IN THE BACKGROUND OF
THE LABEL, THE COLOR RED APPEARS IN THE LEAF
DESIGN, THE COLOR PURPLE APPEARS IN THE GRAPES
DESIGN, THE COLOR TAN APPEARS IN THE TERM IV,
THE COLOR BROWN APPEAR IN THE TERM IRONSTONE
WITH BLACK SHADING, THE COLOR BLACK APPEARS
IN THE TERMS VINEYARDS, 2005, MERLOT, LODI AP-
PELLATION AND IN THE DETAIL DESIGN AT THE TOP
AND BOTTOM OF THE LABEL AND THE COLOR WHITE
APPEARS IN THE LINES AND DOTS IN THE DETAIL
DESIGN AT THE TOP AND BOTTOM OF THE LABEL.

FOR WINES (U.S. CLS. 47 AND 49).
CAROLINE WOOD, EXAMINING ATTORNEY

THE KING

THE MARK CONSISTS OF STANDARD CHARACTERS
WITHOUT CLAIM TO ANY PARTICULAR FONT, STYLE,
SIZE, OR COLOR.

FOR WINE (U.S. CLS. 47 AND 49).
FIRST USE 2-24-2004; IN COMMERCE 2-24-2004.
SETH A. RAPPAPORT, EXAMINING ATTORNEY

CLASS 33—(Continued).

SN 78-886,400. ANHEUSER-BUSCH, INCORPORATED, ST. LOUIS, MO. FILED 5-18-2006.

PIER 21

THE MARK CONSISTS OF STANDARD CHARACTERS WITHOUT CLAIM TO ANY PARTICULAR FONT, STYLE, SIZE, OR COLOR.

FOR ALCOHOLIC TEA-BASED BEVERAGE (U.S. CLS. 47 AND 49).

PAULA MAYS, EXAMINING ATTORNEY

SN 78-898,926. DIAGEO BRANDS B.V., 1014 BG AMSTERDAM, NETHERLANDS, FILED 6-2-2006.



OWNER OF U.S. REG. NOS. 753,435 AND 2,958,058. THE COLOR(S) RED, YELLOW, GOLD AND BLACK IS/ARE CLAIMED AS A FEATURE OF THE MARK.

THE MARK CONSISTS OF A J&B IN RED WITH A YELLOW BACKGROUND WITH GOLD AND BLACK BORDERS.

THE MARK CONSISTS OF A J&B IN RED WITH A YELLOW BACKGROUND WITH GOLD AND BLACK BORDERS.

FOR ALCOHOLIC BEVERAGES, NAMELY DISTILLED SPIRITS (U.S. CLS. 47 AND 49).

ANDREA EVANS, EXAMINING ATTORNEY

CLASS 33—(Continued).

SN 79-012,932. LAROCHE, FRANCE, FILED 6-17-2005.

PUNTO NIÑO

PRIORITY DATE OF 6-6-2005 IS CLAIMED. OWNER OF INTERNATIONAL REGISTRATION 0855622 DATED 6-17-2005, EXPIRES 6-17-2015.

THE ENGLISH TRANSLATION OF THE WORDING PUNTO NIÑO IN THE MARK IS POINT CHILD.

FOR ALCOHOLIC BEVERAGES, NAMELY ALCOHOLIC BITTERS, ALCOHOLIC ESSENCES, ALCOHOLIC PUNCH, PREPARED COCKTAILS, APERITIFS, DISTILLED SPIRITS, EAU-DE-VIE, ALCOHOLIC BEVERAGES CONTAINING FRUITS, ALCOHOLIC FRUIT EXTRACTS, WINES, AND DIGESTIFS, NAMELY BRANDIES AND LIQUEURS (U.S. CLS. 47 AND 49).

SUNG IN, EXAMINING ATTORNEY

SN 79-012,934. LAROCHE, FRANCE, FILED 6-17-2005.

PUNTO ALTO

PRIORITY DATE OF 6-6-2005 IS CLAIMED. OWNER OF INTERNATIONAL REGISTRATION 0855624 DATED 6-17-2005, EXPIRES 6-17-2015.

THE ENGLISH TRANSLATION OF THE WORDING PUNTO ALTO IN THE MARK IS POINT HIGH.

FOR ALCOHOLIC BEVERAGES, NAMELY ALCOHOLIC BITTERS, ALCOHOLIC ESSENCES, ALCOHOLIC PUNCH, PREPARED COCKTAILS, APERITIFS, DISTILLED SPIRITS, EAU-DE-VIE, ALCOHOLIC BEVERAGES CONTAINING FRUITS, ALCOHOLIC FRUIT EXTRACTS, WINES, AND DIGESTIFS, NAMELY BRANDIES AND LIQUEURS (U.S. CLS. 47 AND 49).

SUNG IN, EXAMINING ATTORNEY

CLASS 33—(Continued).

SN 79-014,187. SCI DES BROIX, FRANCE, FILED 7-11-2005.



PRIORITY DATE OF 1-12-2005 IS CLAIMED.
OWNER OF INTERNATIONAL REGISTRATION 0858764
DATED 7-11-2005, EXPIRES 7-11-2015.

NO CLAIM IS MADE TO THE EXCLUSIVE RIGHT TO
USE THE NON-LATIN CHARACTERS THAT MEAN "OF
MOSCOW", APART FROM THE MARK AS SHOWN.

THE COLOR(S) RED, WHITE, YELLOW, ORANGE AND
BLUE IS/ARE CLAIMED AS A FEATURE OF THE MARK.

THE MARK CONSISTS OF THE CYRILLIC TERM MEAN-
ING "OF MOSCOW" IN RED WITHIN A WHITE RECTAN-
GLE OUTLINED IN YELLOW AND ORANGE BRANDED
ACROSS A RED LABEL TRIMMED AND OUTLINED IN
YELLOW. A FANCIFUL DESIGN OF A PERSON RIDING A
HORSE SHOWN IN YELLOW AND RED AND THREE
WAVY LINES IN YELLOW APPEAR ABOVE THE WORD-
ING WHILE A DESIGN CONSISTING OF SEVEN CIRCLES
AND THREE CURVED LINES SHOWN IN YELLOW AND A
BLUE GEOMETRIC SHAPE OUTLINED IN YELLOW AP-
PEAR BELOW THE SAME.

THE FOREIGN WORDING IN THE MARK TRANSLATES
INTO ENGLISH AS OF MOSCOW.

THE NON-LATIN CHARACTERS IN THE MARK TRANS-
LITERATE TO MOSKOVSKY.

FOR BRANDY AND COGNAC (U.S. CLS. 47 AND 49).
DAVID YONTEF, EXAMINING ATTORNEY

SN 79-014,737. PETER LEHMANN WINES LIMITED, AUS-
TRALIA, FILED 8-5-2005.

PETER LEHMANN

THE MARK CONSISTS OF STANDARD CHARACTERS
WITHOUT CLAIM TO ANY PARTICULAR FONT, STYLE,
SIZE, OR COLOR.

OWNER OF INTERNATIONAL REGISTRATION 0860163
DATED 8-5-2005, EXPIRES 8-5-2015.

OWNER OF U.S. REG. NOS. 2,201,093 AND 2,989,804.
FOR WINE (U.S. CLS. 47 AND 49).

RON FAIRBANKS, EXAMINING ATTORNEY

CLASS 33—(Continued).

SN 79-016,291. JUAN PINTO CARRASCO Y BODEGA
COOPERATIVA SAN ROQUE DE LA ENCINA, CASTRIL-
LO DE LA VEGA; E-09391 (BURGOS), SPAIN, FILED 6-3-
2005.

MONTE-PINADILLO

THE MARK CONSISTS OF STANDARD CHARACTERS
WITHOUT CLAIM TO ANY PARTICULAR FONT, STYLE,
SIZE, OR COLOR.

OWNER OF INTERNATIONAL REGISTRATION 0864735
DATED 6-3-2005, EXPIRES 6-3-2015.

THE ENGLISH TRANSLATION OF THE WORD
"MONTE" IN THE MARK IS "MOUNT".

FOR WINE (U.S. CLS. 47 AND 49).
MAUREEN DALL, EXAMINING ATTORNEY

SN 79-018,356. BORCO-MARKEN-IMPORT MATTHIENEN
GMBH & CO. KG, FED REP GERMANY, FILED 9-29-2005.

Sierra Milenario

THE MARK CONSISTS OF STANDARD CHARACTERS
WITHOUT CLAIM TO ANY PARTICULAR FONT, STYLE,
SIZE, OR COLOR.

PRIORITY DATE OF 5-12-2005 IS CLAIMED.
OWNER OF INTERNATIONAL REGISTRATION 0869993
DATED 9-29-2005, EXPIRES 9-29-2015.

THE ENGLISH TRANSLATION OF THE WORD MILE-
NARIO IN THE MARK IS MILLENNIAL.

FOR SPIRITS OF MEXICAN ORIGIN, NAMELY TE-
QUILA (U.S. CLS. 47 AND 49).

ERNEST SHOSHO, EXAMINING ATTORNEY

SN 79-019,866. FERNANDO BANÚS RICOMA, INGENIO
(GRAN CANARIA), SPAIN, AND ESTEBAN BANÚS
RICOMA, INGENIO (GRAN CANARIA), SPAIN, FILED
11-30-2005.

BLAT

PRIORITY DATE OF 6-16-2005 IS CLAIMED.
OWNER OF INTERNATIONAL REGISTRATION 0873888
DATED 11-30-2005, EXPIRES 11-30-2015.

FOR VODKA, EAUX-DE-VIE, KIRSCH, RUM, LI-
QUEURS, AND DISTILLED SPIRITS (U.S. CLS. 47 AND
49).

GRETTA YAO, EXAMINING ATTORNEY

CLASS 33—(Continued).

SN 79-023,538. HOWARD PARK WINES PTY LTD, AUSTRALIA, FILED 9-29-2005.

STRAIT JACKET

THE MARK CONSISTS OF STANDARD CHARACTERS WITHOUT CLAIM TO ANY PARTICULAR FONT, STYLE, SIZE, OR COLOR.

PRIORITY DATE OF 9-28-2005 IS CLAIMED.

OWNER OF INTERNATIONAL REGISTRATION 0883821 DATED 9-29-2005, EXPIRES 9-29-2015.

FOR WINES; WINE COOLERS BEING DRINKS MADE FROM WINE, FRUIT JUICE AND CARBONATED WATER; PORT WINE; ALCOHOLIC BEVERAGES WITH A WINE BASE (U.S. CLS. 47 AND 49).

RAY THOMAS, EXAMINING ATTORNEY

CLASS 34—(Continued).

SN 78-461,803. WEINER, RUSSELL G., LAS VEGAS, NV. FILED 8-4-2004.

ROCKSTAR

THE MARK CONSISTS OF STANDARD CHARACTERS WITHOUT CLAIM TO ANY PARTICULAR FONT, STYLE, SIZE, OR COLOR.

FOR TOBACCO (U.S. CLS. 2, 8, 9 AND 17).

RONALD MCMORROW, EXAMINING ATTORNEY

SN 78-551,150. KRETEK INTERNATIONAL, INC., MOORPARK, CA. FILED 1-20-2005.

CUBAN DREAMS

THE MARK CONSISTS OF STANDARD CHARACTERS WITHOUT CLAIM TO ANY PARTICULAR FONT, STYLE, SIZE, OR COLOR.

NO CLAIM IS MADE TO THE EXCLUSIVE RIGHT TO USE "CUBAN", APART FROM THE MARK AS SHOWN.

FOR TOBACCO PRODUCTS, NAMELY, ROLLING PAPERS FOR TOBACCO AND CIGARETTES, CIGARETTE LIGHTERS NOT OF PRECIOUS METAL, PIPES FOR SMOKING, PIPE CLEANERS FOR SMOKING, MATCHES, AND TOBACCO POUCHES; TOBACCO PRODUCTS FROM CUBAN SEED TOBACCO, NAMELY CIGARETTES, CIGARS, CIGARILLOS, AND BIDIS (U.S. CLS. 2, 8, 9 AND 17).

ALICIA COLLINS, EXAMINING ATTORNEY

CLASS 34—SMOKERS' ARTICLES

SN 76-647,740. KLAIPS, JEFF, NAPERVILLE, IL. FILED 9-30-2005.

VOODOO SMOKE

THE MARK CONSISTS OF STANDARD CHARACTERS WITHOUT CLAIM TO ANY PARTICULAR FONT, STYLE, SIZE, OR COLOR.

NO CLAIM IS MADE TO THE EXCLUSIVE RIGHT TO USE "SMOKE", APART FROM THE MARK AS SHOWN.

FOR CIGARS (U.S. CLS. 2, 8, 9 AND 17).

IRENE D. WILLIAMS, EXAMINING ATTORNEY

SN 76-658,851. MUSIC CITY MARKETING, INC., NASHVILLE, TN. FILED 4-24-2006.

Castleford



OWNER OF U.S. REG. NO. 2,307,987.
FOR TOBACCO POUCHES AND CIGAR ACCESSORIES; NAMELY, CIGAR CUTTERS AND CIGAR TUBES (U.S. CLS. 2, 8, 9 AND 17).

FIRST USE 8-0-2004; IN COMMERCE 8-0-2004.

RUDY R. SINGLETON, EXAMINING ATTORNEY

SN 78-701,337. BRITISH AMERICAN TOBACCO (BRANDS) LIMITED, LONDON, UNITED KINGDOM, FILED 8-26-2005.

DU MAURIER

THE MARK CONSISTS OF STANDARD CHARACTERS WITHOUT CLAIM TO ANY PARTICULAR FONT, STYLE, SIZE, OR COLOR.

SEC. 2(F).

FOR CIGARETTES (U.S. CLS. 2, 8, 9 AND 17).

FIRST USE 0-0-1930; IN COMMERCE 0-0-2000.

JERI J. FICKES, EXAMINING ATTORNEY

CLASS 34—(Continued).

SN 78-705,672. CIGAR KING, LTD., SCOTTSDALE, AZ.
FILED 9-1-2005.

HAVANA SOUL

THE MARK CONSISTS OF STANDARD CHARACTERS WITHOUT CLAIM TO ANY PARTICULAR FONT, STYLE, SIZE, OR COLOR.

NO CLAIM IS MADE TO THE EXCLUSIVE RIGHT TO USE "HAVANA", APART FROM THE MARK AS SHOWN.

FOR CIGARS MADE WITH CUBAN SEED TOBACCO (U.S. CLS. 2, 8, 9 AND 17).

FIRST USE 6-30-2005; IN COMMERCE 6-30-2005.
DAVID C. REIHNER, EXAMINING ATTORNEY

SN 78-705,677. CIGAR KING, LTD., SCOTTSDALE, AZ.
FILED 9-1-2005.

HABANA LEON

THE MARK CONSISTS OF STANDARD CHARACTERS WITHOUT CLAIM TO ANY PARTICULAR FONT, STYLE, SIZE, OR COLOR.

NO CLAIM IS MADE TO THE EXCLUSIVE RIGHT TO USE "HABANA", APART FROM THE MARK AS SHOWN.

THE FOREIGN WORDING IN THE MARK TRANSLATES INTO ENGLISH AS LION.

FOR CIGARS MADE WITH CUBAN SEED TOBACCO (U.S. CLS. 2, 8, 9 AND 17).

FIRST USE 6-30-2005; IN COMMERCE 6-30-2005.
DAVID C. REIHNER, EXAMINING ATTORNEY

SN 78-747,532. FUENTE MARKETING LTD., TORTOLA,
BR.VIRGIN ISLANDS, FILED 11-4-2005.

BBMF

THE MARK CONSISTS OF STANDARD CHARACTERS WITHOUT CLAIM TO ANY PARTICULAR FONT, STYLE, SIZE, OR COLOR.

FOR CIGARS; SMOKER'S ARTICLES, NAMELY, CIGAR HUMIDIFIERS, ASHTRAYS NOT MADE OF PRECIOUS METAL; CIGAR CUTTERS; CIGAR PROTECTORS; LIGHTERS NOT MADE OF PRECIOUS METAL; AND MATCHES (U.S. CLS. 2, 8, 9 AND 17).

FIRST USE 8-8-2005; IN COMMERCE 8-8-2005.
DAVID TAYLOR, EXAMINING ATTORNEY

CLASS 34—(Continued).

SN 78-761,423. JAPAN TOBACCO INC., TOKYO, JAPAN,
FILED 11-28-2005.

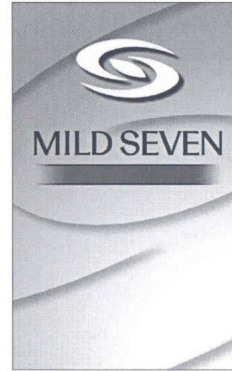

OWNER OF U.S. REG. NOS. 1,987,522, 2,110,932 AND 2,384,786.

NO CLAIM IS MADE TO THE EXCLUSIVE RIGHT TO USE "MILD", APART FROM THE MARK AS SHOWN.

FOR CIGARETTES; RAW OR MANUFACTURED TOBACCO; SMOKERS' ARTICLES, NAMELY, CIGARETTE PAPER, CIGARETTE FILTERS, CIGARETTE CASES NOT OF PRECIOUS METAL, CIGARETTE HOLDERS NOT OF PRECIOUS METAL; MATCHES (U.S. CLS. 2, 8, 9 AND 17).

FIRST USE 10-17-2005; IN COMMERCE 10-17-2005.
DOMINIC FATHY, EXAMINING ATTORNEY

SN 78-855,104. TTNB INC, SUNNY ISLES BEACH, FL. FILED
4-5-2006.

WARRIOR

THE MARK CONSISTS OF STANDARD CHARACTERS WITHOUT CLAIM TO ANY PARTICULAR FONT, STYLE, SIZE, OR COLOR.

FOR TOBACCO (U.S. CLS. 2, 8, 9 AND 17).
SCOTT SISUN, EXAMINING ATTORNEY

SN 78-856,522. PRESSON, GREGORY, J., SCHWENKSVILLE,
PA. FILED 4-7-2006.

The Dip you don't need to quit

THE MARK CONSISTS OF STANDARD CHARACTERS WITHOUT CLAIM TO ANY PARTICULAR FONT, STYLE, SIZE, OR COLOR.

FOR TOBACCO SUBSTITUTE (U.S. CLS. 2, 8, 9 AND 17).

MELVIN AXILBUND, EXAMINING ATTORNEY

CLASS 34—(Continued).

SN 78-856,764. MATINEE COMPANY INC., MONTREAL, QUEBEC, CANADA, FILED 4-7-2006.



NO CLAIM IS MADE TO THE EXCLUSIVE RIGHT TO USE "SLIMS: EXTRA MILD", APART FROM THE MARK AS SHOWN.

THE MARK CONSISTS OF THE WORDS MATINÉE SLIMS IN LOWER STYLIZED TITLE CASE LETTERS ABOVE THE WORDS EXTRA MILD IN CAPITAL LETTERS. TO THE RIGHT OF THE WORDS EXTRA MILD APPEARS THE DESIGN OF A FLYING HORSE SUPERIMPOSED ON A CIRCLE WITH A BORDER. ARCHED LINES EMANATE FROM THE FLYING HORSE PORTION OF THE DESIGN.

FOR MANUFACTURED TOBACCO PRODUCTS, NAMELY, CIGARETTES AND FINE CUT TOBACCO (U.S. CLS. 2, 8, 9 AND 17).

FIRST USE 6-0-2001; IN COMMERCE 2-0-2002.
CAROLYN GRAY, EXAMINING ATTORNEY

SN 78-860,168. MEDALLION INC., MONTREAL, QUEBEC, CANADA, FILED 4-12-2006.

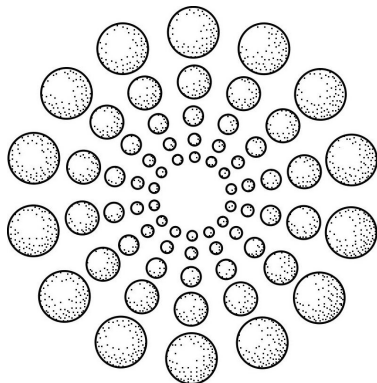

THE STIPPLING IS FOR SHADING PURPOSES ONLY. FOR MANUFACTURED TOBACCO PRODUCTS; NAMELY, CIGARETTES AND FINE CUT TOBACCO (U.S. CLS. 2, 8, 9 AND 17).

FIRST USE 5-0-1977; IN COMMERCE 3-0-2003.
MEGAN WHITNEY, EXAMINING ATTORNEY

CLASS 34—(Continued).

SN 78-860,744. FUENTE MARKETING LTD., TORTOLA, BR. VIRGIN ISLANDS, FILED 4-13-2006.

CFC

THE MARK CONSISTS OF STANDARD CHARACTERS WITHOUT CLAIM TO ANY PARTICULAR FONT, STYLE, SIZE, OR COLOR.

FOR ASHTRAYS; CIGAR BANDS; CIGAR BOXES NOT OF PRECIOUS METAL; CIGAR CUTTERS; CIGAR HUMIDIFIERS; CIGAR TUBES; CIGARETTE LIGHTERS NOT OF PRECIOUS METAL; CIGARS; LIGHTERS NOT OF PRECIOUS METAL; MATCHES (U.S. CLS. 2, 8, 9 AND 17).

MELISSA VALLILLO, EXAMINING ATTORNEY

SN 78-868,801. GAIA'S DELIGHTS, INC., CHICAGO, IL. FILED 4-25-2006.

DAGANDA

THE MARK CONSISTS OF STANDARD CHARACTERS WITHOUT CLAIM TO ANY PARTICULAR FONT, STYLE, SIZE, OR COLOR.

FOR NON-TOBACCO SMOKING PRODUCT, NAMELY, AN HERBAL TOBACCO SUBSTITUTE, NOT FOR MEDICAL USE (U.S. CLS. 2, 8, 9 AND 17).

FIRST USE 5-1-2005; IN COMMERCE 5-1-2005.
SEAN CROWLEY, EXAMINING ATTORNEY

SN 78-869,389. DHANRAJ IMPORTS, INC., RIVERSIDE, CA. FILED 4-25-2006.

CROSSFIRE

THE MARK CONSISTS OF STANDARD CHARACTERS WITHOUT CLAIM TO ANY PARTICULAR FONT, STYLE, SIZE, OR COLOR.

FOR CIGARETTES (U.S. CLS. 2, 8, 9 AND 17).
JOHN GARTNER, EXAMINING ATTORNEY

CLASS 34—(Continued).

SN 78-869,740. HOLT'S COMPANY, PHILADELPHIA, PA.
FILED 4-26-2006.

CLASS 35—(Continued).

SERVICE MARKS

ESTATE SUN GROWN

THE MARK CONSISTS OF STANDARD CHARACTERS WITHOUT CLAIM TO ANY PARTICULAR FONT, STYLE, SIZE, OR COLOR.

NO CLAIM IS MADE TO THE EXCLUSIVE RIGHT TO USE "SUN GROWN", APART FROM THE MARK AS SHOWN.

FOR CIGAR BANDS; CIGAR BOXES NOT OF PRECIOUS METAL; CIGAR CUTTERS; CIGAR TUBES; CIGARS; HUMIDORS; SMOKING TOBACCO (U.S. CLS. 2, 8, 9 AND 17).

FIRST USE 3-0-2003; IN COMMERCE 7-0-2005.
LINDA ESTRADA, EXAMINING ATTORNEY

CLASS 35—ADVERTISING AND BUSINESS

SN 76-331,760. PRISZM BRANDZ LP, MARKHAM, ONTARIO L3R 0P6, CANADA, FILED 10-30-2001.

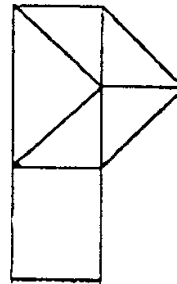

PRIORITY CLAIMED UNDER SEC. 44(D) ON CANADA APPLICATION NO. 1,101,619, FILED 4-30-2001, REG. NO. TMA670644, DATED 8-22-2006, EXPIRES 8-22-2021.

FOR BUSINESS CONSULTATION AND BUSINESS MANAGEMENT SERVICES PROVIDED TO RESTAURANTS; RESTAURANT FRANCHISING, NAMELY, OFFERING TECHNICAL ASSISTANCE IN THE ESTABLISHMENT AND/OR OPERATION OF RESTAURANTS, RESTAURANT MANAGEMENT SERVICES (U.S. CLS. 100, 101 AND 102).

NICHOLAS ALTREE, EXAMINING ATTORNEY

SN 78-871,097. DHANRAJ IMPORTS, INC., RIVERSIDE, CA.
FILED 4-27-2006.

CONNECT

THE MARK CONSISTS OF STANDARD CHARACTERS WITHOUT CLAIM TO ANY PARTICULAR FONT, STYLE, SIZE, OR COLOR.

FOR CIGARETTES (U.S. CLS. 2, 8, 9 AND 17).
FIRST USE 12-1-2004; IN COMMERCE 6-1-2005.
JOHN GARTNER, EXAMINING ATTORNEY

SN 76-331,761. PRISZM BRANDZ LP, MARKHAM, ONTARIO L3R 0P6, CANADA, FILED 10-30-2001.



PRIORITY CLAIMED UNDER SEC. 44(D) ON CANADA APPLICATION NO. 1,101,621, FILED 4-30-2001, REG. NO. TMA670643, DATED 8-22-2006, EXPIRES 8-22-2021.

FOR BUSINESS CONSULTATION AND BUSINESS MANAGEMENT SERVICES PROVIDED TO RESTAURANTS; RESTAURANT FRANCHISING, NAMELY, OFFERING TECHNICAL ASSISTANCE IN THE ESTABLISHMENT AND/OR OPERATION OF RESTAURANTS, RESTAURANT MANAGEMENT SERVICES (U.S. CLS. 100, 101 AND 102).

NICHOLAS ALTREE, EXAMINING ATTORNEY

CLASS 35—(Continued).

SN 76-615,327. GIRLTALK, LLC, LOUISVILLE, KY. FILED 10-12-2004.



FOR RETAIL STORE SERVICES IN THE FIELD OF GIFT, CRAFT AND JEWELRY ITEMS (U.S. CLS. 100, 101 AND 102).

FIRST USE 4-19-2003; IN COMMERCE 4-19-2003.
SEAN CROWLEY, EXAMINING ATTORNEY

SN 76-622,643. TOUGH JEANS LIMITED, KOWLOON BAY, KOWLOON, HONG KONG, FILED 12-1-2004.

⊕ TOUGH Jeansmith

PRIORITY CLAIMED UNDER SEC. 44(D) ON HONG KONG APPLICATION NO. 300316566, FILED 11-10-2004, REG. NO. 300316566, DATED 11-10-2004, EXPIRES 11-10-2014. OWNER OF U.S. REG. NOS. 2,880,889, 2,894,356 AND 2,932,522.

NO CLAIM IS MADE TO THE EXCLUSIVE RIGHT TO USE "TOUGH", APART FROM THE MARK AS SHOWN.

"THE NAME(S), PORTRAIT(S), AND/OR SIGNATURE(S) SHOWN IN THE MARK DOES NOT IDENTIFY A PARTICULAR LIVING INDIVIDUAL."

FOR WHOLESALE DISTRIBUTORSHIP AND RETAIL STORE SERVICES FEATURING WATCHES, COSTUME JEWELRY, HAIR ACCESSORIES, HANDBAGS, PURSES, WALLETS, KEY CASES, BUSINESS CARD CASES, CREDIT CARD CASES, MAKE-UP CASES SOLD EMPTY, BRIEFCASES, SUITCASES, TRUNKS, ATHLETIC BAGS, ALL PURPOSE SPORTS BAGS, BEACH BAGS, CARRY-ON BAGS, CLUTCHBAGS, COSMETIC BAGS SOLD EMPTY, DUFFEL BAGS, GARMENT BAGS FOR TRAVEL, GYM BAGS, LEATHER BAGS OR POUCHES FOR MERCHANDISE PACKAGING, LEATHER SHOPPING BAGS, OVERNIGHT BAGS, ROLL BAGS, SCHOOL BOOK BAGS, SHOE BAGS FOR TRAVEL, SHOPPING BAGS WITH WHEELS ATTACHED, SHOULDER BAGS, SUIT BAGS, TEXTILE SHOPPING BAGS, TOOL BAGS SOLD EMPTY, TOTE BAGS, TRAVELING BAGS, WRIST MOUNTING CARRYALL BAGS, WAIST BAGS, BACKPACKS, CARRY-ON BAGS WITH WHEELS ATTACHED, LEATHER ATTACHE CASES, HIP BAGS, KNAPSACKS, UMBRELLAS, BELTS, HATS, CAPS, SCARVES, SHOES, SANDALS, JEANS, T-SHIRTS, DRESSES, SKIRTS, SHIRTS, SHORTS, CARDIGANS, SWEATERS, PULL-OVERS, JACKETS, WINDBREAKERS, OVERCOATS, SUITS, PANTS, VESTS, COATS, JUMPERS AND OVERALLS; ADVERTISING AND ADVERTISEMENT SERVICES, DIRECT MAIL ADVERTISING, DEMONSTRATION OF GOODS FOR PROMOTIONAL PURPOSES, DISTRIBUTION OF SAMPLES, IMPORT-EXPORT AGENCIES, PUBLICITY AGENT SERVICES, SHOP WINDOW DISPLAY ARRANGEMENT SERVICES, PREPARING AUDIO-VISUAL DISPLAYS IN THE FIELD OF FASHION FOR BUSINESSES (U.S. CLS. 100, 101 AND 102).

JASON TURNER, EXAMINING ATTORNEY

CLASS 35—(Continued).

SN 76-625,644. ENTENMANN'S PRODUCTS, INC., NORTH-LAKE, IL. FILED 12-27-2004.



"THE FOREIGN WORDING IN THE MARK TRANSLATES INTO ENGLISH AS FOR A BETTER NEIGHBORHOOD."

FOR CHARITABLE SERVICES, NAMELY ORGANIZING AND CONDUCTING VOLUNTEER PROGRAMS AND COMMUNITY SERVICE PROJECTS (U.S. CLS. 100, 101 AND 102).

FIRST USE 11-12-2002; IN COMMERCE 11-12-2002.
ESTHER A. BORSUK, EXAMINING ATTORNEY

SN 76-636,443. SIMPLY WINE, LLC, FERNDALE, MI. FILED 4-19-2005.

SIMPLY WINE

NO CLAIM IS MADE TO THE EXCLUSIVE RIGHT TO USE "WINE", APART FROM THE MARK AS SHOWN.

FOR RETAIL STORE SERVICES FEATURING WINE (U.S. CLS. 100, 101 AND 102).

FIRST USE 9-1-2002; IN COMMERCE 9-1-2002.

ARETHA SOMERVILLE, EXAMINING ATTORNEY

SN 76-639,210. SUN SAFETY ALLIANCE, INC., ALEXANDRIA, VA. FILED 5-23-2005.

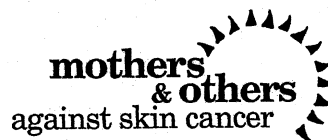

NO CLAIM IS MADE TO THE EXCLUSIVE RIGHT TO USE "SKIN CANCER", APART FROM THE MARK AS SHOWN.

FOR PROMOTING PUBLIC AWARENESS REGARDING THE IMPORTANCE OF SUN CARE SAFETY THROUGH DISTRIBUTION OF A NEWSLETTER AND PROMOTING LOCAL EFFORTS TO PROMOTE SUN SAFETY; PROMOTING PUBLIC AWARENESS OF THE NEED FOR PEOPLE TO PROTECT THEMSELVES AND THEIR FAMILIES FROM THE NEGATIVE EFFECTS OF THE SUN (U.S. CLS. 100, 101 AND 102).

FIRST USE 3-17-2005; IN COMMERCE 3-17-2005.

TRAVIS WHEATLEY, EXAMINING ATTORNEY

CLASS 35—(Continued).

SN 76-640,039. UNIVERSAL EVENT MANAGEMENT, LLC, BRAINTREE, MA. FILED 6-3-2005.



NO CLAIM IS MADE TO THE EXCLUSIVE RIGHT TO USE "EVENT MANAGEMENT", APART FROM THE MARK AS SHOWN.

THE COLORS BLACK AND BLUE ARE CLAIMED AS A FEATURE OF THE MARK.

THE COLOR BLACK APPEARS IN THE WORDING COMPRISING THE MARK AND IN THE DESIGN OF THE GLOBE AND THE COLOR BLUE APPEARS IN THE CHECK MARK AND IN THE RECTANGLE ABOVE THE WORDING INCLUDED IN THE MARK.

FOR PROMOTING AND CONDUCTING TRADE SHOWS IN THE FIELD OF COMPUTER PRODUCTS AND SERVICES (U.S. CLS. 100, 101 AND 102).

FLORENTINA BLANDU, EXAMINING ATTORNEY

CLASS 35—(Continued).

SN 76-642,632. T. W. WANG, INC., WHITESTONE, NY. FILED 7-11-2005.



NO CLAIM IS MADE TO THE EXCLUSIVE RIGHT TO USE THE NON-LATIN CHARACTERS THAT MEAN "JOURNAL BOOKSTORE", APART FROM THE MARK AS SHOWN.

THE CHINESE CHARACTERS TRANSLATE TO WORLD JOURNAL BOOKSTORE.

THE NON-LATIN CHARACTERS IN THE MARK TRANSLITERATE TO "SHIH JIE SHU CHU" AND THIS MEANS "WORLD JOURNAL BOOKSTORE" IN ENGLISH.

FOR RETAIL STORE SERVICES IN THE FIELD OF CHINESE PAMPHLETS, MAGAZINES AND PERIODICALS (U.S. CLS. 100, 101 AND 102).

FIRST USE 3-6-1986; IN COMMERCE 3-6-1986.

IRENE D. WILLIAMS, EXAMINING ATTORNEY

SN 76-643,513. HART PRODUCTIONS, INC., CINCINNATI, OH. FILED 7-25-2005.

SN 76-640,360. DO IT BEST CORP., FORT WAYNE, IN. FILED 6-7-2005.



OWNER OF U.S. REG. NOS. 1,360,969, 2,012,101 AND OTHERS.

FOR RENDERING TECHNICAL AID AND ASSISTANCE IN ESTABLISHMENT AND OPERATION OF RETAIL HARDWARE, LUMBER, BUILDING MATERIAL AND HOME CENTER STORES; AND RETAIL STORE SERVICES IN THE FIELD OF HARDWARE, LUMBER AND BUILDING MATERIAL SUPPLIES AND HOME CENTER STORES (U.S. CLS. 100, 101 AND 102).

FIRST USE 10-31-1981; IN COMMERCE 10-31-1981.

GRETTA YAO, EXAMINING ATTORNEY



THE MARK CONSISTS OF A LOWERCASE "HP" INSIDE A HEART DESIGN.

FOR ARRANGING AND CONDUCTING CONSUMER TRADE SHOW EXHIBITIONS TO PROMOTE THE GOODS AND SERVICES OF OTHERS, IN THE FIELDS OF GARDENING, LANDSCAPING, FLOWERS, VEGETABLES, TREES, PLANTS, HOME GOODS, INTERIOR DESIGN, PATIO AND ROOM ADDITIONS, HOME REDECORATION AND CONSTRUCTION, HOLIDAY DECORATIONS, SPORTING GOODS, GOLF, HUNTING, FISHING, VACATIONS, TRAVEL, RESORTS, BOATS AND MOTOR VEHICLES (U.S. CLS. 100, 101 AND 102).

FIRST USE 1-0-1975; IN COMMERCE 1-0-1975.

MICHAEL KEATING, EXAMINING ATTORNEY

CLASS 35—(Continued).

SN 76-645,147. THE SUGAR ASSOCIATION, INC., WASHINGTON, DC. FILED 8-18-2005.



FOR ASSOCIATION SERVICES, NAMELY, PROMOTING THE INTERESTS OF GROWERS, PRODUCERS, AND REFINERS OF CANE AND BEET SUGAR, AND MANUFACTURERS OF SUGAR-BASED PRODUCTS (U.S. CLS. 100, 101 AND 102).

FIRST USE 9-0-2000; IN COMMERCE 9-0-2000.
ROBIN CHOSID, EXAMINING ATTORNEY

SN 76-647,338. INNIS MAGGIORE GROUP, INC., CANTON, OH. FILED 9-23-2005.

POSITIONING IS OUR POSITION

THE MARK CONSISTS OF STANDARD CHARACTERS WITHOUT CLAIM TO ANY PARTICULAR FONT, STYLE, SIZE, OR COLOR.

NO CLAIM IS MADE TO THE EXCLUSIVE RIGHT TO USE "POSITIONING", APART FROM THE MARK AS SHOWN.

FOR ADVERTISING, MARKETING AND PUBLIC RELATIONS SERVICES FOR OTHERS, NAMELY, MARKET RESEARCH, DIRECT MARKETING, MEDIA PLANNING AND PLACEMENT OF ADVERTISEMENTS, WEBSITE MARKETING, BRAND DEVELOPMENT, AND SALES PROMOTION SERVICES FOR OTHERS (U.S. CLS. 100, 101 AND 102).

FIRST USE 9-12-2005; IN COMMERCE 9-12-2005.
JOHN KELLY, EXAMINING ATTORNEY

SN 76-647,543. LEGENDARY GAMES, INC., DERBY, KS. FILED 9-27-2005.



OWNER OF U.S. REG. NOS. 2,161,638 AND 2,161,639.
NO CLAIM IS MADE TO THE EXCLUSIVE RIGHT TO USE "FARKEL", APART FROM THE MARK AS SHOWN.
FOR COMPUTERIZED ON-LINE RETAILING SERVICES IN THE FIELD OF PARLOR GAMES (U.S. CLS. 100, 101 AND 102).

FIRST USE 10-29-2004; IN COMMERCE 10-29-2004.
CHARLOTTE CORWIN, EXAMINING ATTORNEY

CLASS 35—(Continued).

SN 76-648,107. TEXAS DEPARTMENT OF TRANSPORTATION, AUSTIN, TX. FILED 10-7-2005.

REGISTERED TEXAN

THE MARK CONSISTS OF STANDARD CHARACTERS WITHOUT CLAIM TO ANY PARTICULAR FONT, STYLE, SIZE, OR COLOR.

FOR PROMOTING THE REGISTRATION OF VEHICLES IN TEXAS AND THE PUBLIC AWARENESS OF THE NEED FOR SUCH REGISTRATION THROUGH THE DEVELOPMENT AND DISSEMINATION OF EDUCATIONAL MATERIALS AND PUBLIC SERVICE ANNOUNCEMENTS, AND THE DEVELOPMENT, PLANNING AND IMPLEMENTATION OF REGISTRATION PROGRAMS; DISSEMINATION OF DIRECT MAIL (U.S. CLS. 100, 101 AND 102).

FIRST USE 9-18-2005; IN COMMERCE 9-18-2005.
BONNIE LUKEN, EXAMINING ATTORNEY

SN 76-648,928. TOWER PRODUCTS INCORPORATED, SAUGERTIES, NY. FILED 10-21-2005.

TECNEC

THE MARK CONSISTS OF STANDARD CHARACTERS WITHOUT CLAIM TO ANY PARTICULAR FONT, STYLE, SIZE, OR COLOR.

OWNER OF U.S. REG. NOS. 1,991,272 AND 2,880,654.
FOR DISTRIBUTORSHIPS IN THE FIELD OF ELECTRONIC, VIDEO, AUDIO AND BROADCAST PARTS, NAMELY, INTERFACE UNITS, COUPLERS, CABLE AND CABLE CONNECTORS (U.S. CLS. 100, 101 AND 102).

FIRST USE 11-7-1994; IN COMMERCE 11-7-1994.
DANNEAN HETZEL, EXAMINING ATTORNEY

SN 76-650,941. CONSOLIDATED ELECTRICAL DISTRIBUTORS, INC., WESTLAKE VILLAGE, CA. FILED 11-25-2005.

CONSOLIDATED ELECTRICAL DISTRIBUTORS

THE MARK CONSISTS OF STANDARD CHARACTERS WITHOUT CLAIM TO ANY PARTICULAR FONT, STYLE, SIZE, OR COLOR.

NO CLAIM IS MADE TO THE EXCLUSIVE RIGHT TO USE "ELECTRICAL DISTRIBUTORS", APART FROM THE MARK AS SHOWN.

SEC. 2(F).
FOR WHOLESALE DISTRIBUTORSHIPS FEATURING ELECTRICAL SUPPLIES (U.S. CLS. 100, 101 AND 102).
FIRST USE 12-15-1967; IN COMMERCE 12-15-1967.
JILL PRATER, EXAMINING ATTORNEY

CLASS 35—(Continued).

SN 76-651,878. ORIOS LTD., GILBRALTAR, UNITED KINGDOM, FILED 12-14-2005.

FLORA2000

THE MARK CONSISTS OF STANDARD CHARACTERS WITHOUT CLAIM TO ANY PARTICULAR FONT, STYLE, SIZE, OR COLOR.

FOR ON-LINE RETAIL STORES FEATURING FLORAL PRODUCTS, NAMELY FLOWER ARRANGEMENTS AND BOUQUETS AND SOFT GIFTS, NAMELY CHOCOLATES AND SOFT TOYS, IN PARTICULAR TEDDY BEARS (U.S. CLS. 100, 101 AND 102).

NAKIA HENRY, EXAMINING ATTORNEY

CLASS 35—(Continued).

SN 76-653,250. CARROLL, JOSEPH BLAISE, HONOLULU, HI. FILED 1-12-2006.



NO CLAIM IS MADE TO THE EXCLUSIVE RIGHT TO USE "APPAREL", APART FROM THE MARK AS SHOWN.

FOR RETAIL STORE SERVICES AND ONLINE RETAIL STORE SERVICES FEATURING GOLF BAGS (U.S. CLS. 100, 101 AND 102).

SEAN CROWLEY, EXAMINING ATTORNEY

SN 76-652,223. BIOHRT TECHNOLOGIES, INC., HERMOSA BEACH, CA. FILED 12-20-2005.

BIOHRT

FOR DOCTOR REFERRAL SERVICES (U.S. CLS. 100, 101 AND 102).

ALEX KEAM, EXAMINING ATTORNEY

SN 76-654,888. SNEILING STAFFING, LLC, DALLAS, TX. FILED 2-10-2006.

iTHRIVE

THE MARK CONSISTS OF STANDARD CHARACTERS WITHOUT CLAIM TO ANY PARTICULAR FONT, STYLE, SIZE, OR COLOR.

FOR PERSONNEL AGENCY SERVICES, NAMELY PERSONNEL PLACEMENT AND RECRUITMENT SERVICES (U.S. CLS. 100, 101 AND 102).

RONALD AIKENS, EXAMINING ATTORNEY

SN 76-652,339. BOARD OF REGENTS OF THE UNIVERSITY SYSTEM OF GEORGIA, ATLANTA, GA. FILED 12-22-2005.

FOR PROVIDING COMMUNITY BASED CAREGIVER SUPPORT BY PROMOTING PUBLIC AWARENESS OF CAREGIVER ISSUES AND BY PROMOTING THE INTERESTS OF CAREGIVERS IN THE FIELDS OF PUBLIC POLICY LEGISLATION AND REGULATION (U.S. CLS. 100, 101 AND 102).

FIRST USE 1-1-2001; IN COMMERCE 1-1-2001.
AMEETA JORDAN, EXAMINING ATTORNEY

SN 76-655,656. STRATHMORE PARTNERS LP, CONCORD, NH. FILED 2-24-2006.

BJ'S HOME IMPROVEMENT

THE MARK CONSISTS OF STANDARD CHARACTERS WITHOUT CLAIM TO ANY PARTICULAR FONT, STYLE, SIZE, OR COLOR.

OWNER OF U.S. REG. NO. 1,751,720.

NO CLAIM IS MADE TO THE EXCLUSIVE RIGHT TO USE "HOME IMPROVEMENT", APART FROM THE MARK AS SHOWN.

FOR REFERRAL OF HOMEOWNERS TO CONTRACTORS, NAMELY, MATCHING INDEPENDENT CONTRACTORS THAT PERFORM HOME IMPROVEMENT AND/OR HOME REPAIR SERVICES WITH HOMEOWNERS THAT DESIRE SUCH HOME IMPROVEMENT AND/OR HOME REPAIR SERVICES (U.S. CLS. 100, 101 AND 102).

FIRST USE 8-16-2005; IN COMMERCE 8-16-2005.
MYRIAH HABEEB, EXAMINING ATTORNEY

CLASS 35—(Continued).

SN 76-656,044. CRAIG, NAHSHON L., NEW YORK, NY.
FILED 3-3-2006.

QUESTONE ENTERTAINMENT GROUP LLC

THE MARK CONSISTS OF STANDARD CHARACTERS WITHOUT CLAIM TO ANY PARTICULAR FONT, STYLE, SIZE, OR COLOR.

NO CLAIM IS MADE TO THE EXCLUSIVE RIGHT TO USE "ENTERTAINMENT GROUP LLC", APART FROM THE MARK AS SHOWN.

FOR PERSONAL MANAGEMENT FOR MUSICAL AND ARTISTIC PERFORMERS; TALENT AGENCY REPRESENTATION SERVICES FOR CREATIVE TALENT, NAMELY, WRITERS, ACTORS, COMEDIANS, DIRECTORS, PRODUCERS, COMPUTER SOFTWARE DEVELOPERS, INVENTORS OF NEW TECHNOLOGIES, AND INDIVIDUALS, GROUPS AND ENTITIES IN THE FIELDS OF MUSICAL PERFORMANCE, ORCHESTRAL PERFORMANCE, THEATRICAL PRODUCTIONS AND PERFORMANCE, MIME, DANCE, COMEDY AND DIGITAL MEDIA; ARRANGING MUSICAL, ENTERTAINMENT AND MULTI-MEDIA PRODUCTIONS FOR MARKETING AND TOURING; ARRANGING FOR MARKETING, DISTRIBUTION AND SYNDICATION OF TELEVISION PROGRAMS, MOTION PICTURES, AND TELEVISION AND MOTION PICTURE SCRIPTS (U.S. CLS. 100, 101 AND 102).

KATHERINE CHANG, EXAMINING ATTORNEY

SN 76-656,345. SNELLING STAFFING, LLC, DALLAS, TX.
FILED 3-9-2006.

THRIVE

THE MARK CONSISTS OF STANDARD CHARACTERS WITHOUT CLAIM TO ANY PARTICULAR FONT, STYLE, SIZE, OR COLOR.

FOR PERSONNEL AGENCY SERVICES, NAMELY PERSONNEL PLACEMENT AND RECRUITMENT SERVICES (U.S. CLS. 100, 101 AND 102).

FIRST USE 1-31-2006; IN COMMERCE 1-31-2006.
RONALD AIKENS, EXAMINING ATTORNEY

SN 76-656,402. MORROW & COMPANY, L.L.C., WICHITA, KS. FILED 3-10-2006.

ACCOUNTING FOR YOUR NEEDS

THE MARK CONSISTS OF STANDARD CHARACTERS WITHOUT CLAIM TO ANY PARTICULAR FONT, STYLE, SIZE, OR COLOR.

NO CLAIM IS MADE TO THE EXCLUSIVE RIGHT TO USE "ACCOUNTING", APART FROM THE MARK AS SHOWN.

FOR ACCOUNTING SERVICES (U.S. CLS. 100, 101 AND 102).

FIRST USE 1-13-2005; IN COMMERCE 1-13-2005.
ROBERT C. CLARK JR., EXAMINING ATTORNEY

CLASS 35—(Continued).

SN 76-656,848. SNELLING STAFFING, LLC, DALLAS, TX.
FILED 3-17-2006.

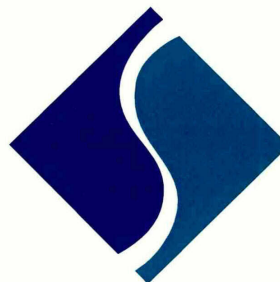

OWNER OF U.S. REG. NO. 2,076,247.
THE COLOR(S) PURPLE AND TEAL IS/ARE CLAIMED AS A FEATURE OF THE MARK.

THE PURPLE COLOR APPEARS TO THE LEFT OF THE "S" SHAPED GAP, AND THE TEAL COLOR APPEARS TO THE RIGHT OF THE "S" SHAPED GAP.

FOR PERSONNEL AGENCY SERVICES, NAMELY PERSONNEL PLACEMENT AND RECRUITMENT SERVICES (U.S. CLS. 100, 101 AND 102).

RONALD AIKENS, EXAMINING ATTORNEY

SN 76-657,245. IPO DEVELOPMENT CORPORATION, FRANKLIN, TN. FILED 3-24-2006.

IPO DEVELOPMENT CORPORATION

THE MARK CONSISTS OF STANDARD CHARACTERS WITHOUT CLAIM TO ANY PARTICULAR FONT, STYLE, SIZE, OR COLOR.

OWNER OF U.S. REG. NO. 2,294,813.
NO CLAIM IS MADE TO THE EXCLUSIVE RIGHT TO USE "CORPORATION", APART FROM THE MARK AS SHOWN.

SEC. 2(F).
FOR BUSINESS PLANNING FEATURING ORGANIZATIONAL DEVELOPMENT, POOLING OF INTERESTS AND COMBINATIONS (U.S. CLS. 100, 101 AND 102).

FIRST USE 2-10-1997; IN COMMERCE 2-10-1997.
MARIAM MAHMOUDI, EXAMINING ATTORNEY

CLASS 35—(Continued).

SN 76-657,446. MOON OVER MIAMI, INC., MIAMI BEACH, FL. FILED 3-29-2006.



NO CLAIM IS MADE TO THE EXCLUSIVE RIGHT TO USE "MIAMI", APART FROM THE MARK AS SHOWN.

FOR RETAIL STORE, MAIL ORDER CATALOG, AND ELECTRONIC RETAILING SERVICES VIA GLOBAL COMPUTER NETWORK, FEATURING BEACH GEAR, BEACH TOWELS, HATS, T-SHIRTS, CLOTHING, SHORTS, SANDALS, SOUVENIRS, NOVELTY ITEMS, FRAGRANCES, JEWELRY, ARTWORK, WATCHES, CLOCKS, HANDBAGS, ACCESSORIES, COLLECTIBLES, MEMORABILIA AND MUSIC (U.S. CLS. 100, 101 AND 102).

FIRST USE 5-30-1996; IN COMMERCE 5-30-1996.
ANGELA M. MICHELI, EXAMINING ATTORNEY

SN 76-657,562. CITY OF SCOTTSDALE, SCOTTSDALE, AZ. FILED 3-30-2006.



THE COLOR(S) MAUVE, BLUE, ORANGE, WHITE, GOLD, RED, GRAY, AND BLACK IS/ARE CLAIMED AS A FEATURE OF THE MARK.

THE MARK CONSISTS OF A STYLIZED CARTOON CHARACTER DEPICTING A RECYCLING BIN IN THE FORM OF A MAUVE COWBOY WITH BLACK AND WHITE EYES AND TEETH HOLDING A BLUE CAN AND AN ORANGE ROLL OF PAPER AND ATTIRED IN A WHITE COWBOY HAT, WHITE GLOVES WITH BLUE RIBBONS, A BLUE HAT BAND, A GOLD, BLUE AND WHITE BADGE AND A RED NECKERCHIEF, THE WHEELS ARE GRAY BLACK AND WHITE WITH A GOLD STAR PROTRUDING FROM THE RIGHT-SIDE WHEEL. THE OUTLINE OF THE CHARACTER IS IN BLACK.

FOR PROMOTING PUBLIC AWARENESS OF THE NEED FOR RECYCLING (U.S. CLS. 100, 101 AND 102).

FIRST USE 12-31-1996; IN COMMERCE 12-31-2003.
SANI KHOURI, EXAMINING ATTORNEY

CLASS 35—(Continued).

SN 76-657,905. LEE'S LOGISTICS, L.L.C., WEST SACRAMENTO, CA. FILED 4-5-2006.

LEE'S LOGISTICS, L.L.C.

THE MARK CONSISTS OF STANDARD CHARACTERS WITHOUT CLAIM TO ANY PARTICULAR FONT, STYLE, SIZE, OR COLOR.

NO CLAIM IS MADE TO THE EXCLUSIVE RIGHT TO USE LOGISTICS, L.L.C., APART FROM THE MARK AS SHOWN.

FOR BOOK KEEPING SERVICES (U.S. CLS. 100, 101 AND 102).

STANLEY I. OSBORNE, EXAMINING ATTORNEY

SN 76-658,424. SIMYAR, ROBERT H., PHOENIX, AZ. FILED 4-14-2006.

FTVGIRLS

THE MARK CONSISTS OF STANDARD CHARACTERS WITHOUT CLAIM TO ANY PARTICULAR FONT, STYLE, SIZE, OR COLOR.

FOR RETAIL STORE SERVICES FEATURING DVDS, DOWNLOADABLE VIDEO RECORDINGS AND DOWNLOADABLE AUDIO AND VIDEO RECORDINGS; AND ADVERTISING, MARKETING AND PROMOTION SERVICES (U.S. CLS. 100, 101 AND 102).

FIRST USE 8-23-2002; IN COMMERCE 8-23-2002.
LAURIE MAYES, EXAMINING ATTORNEY

SN 76-658,459. SIMYAR, ROBERT H., PHOENIX, AZ. FILED 4-14-2006.

FTV FIRST TIME VIDEOS

THE MARK CONSISTS OF STANDARD CHARACTERS WITHOUT CLAIM TO ANY PARTICULAR FONT, STYLE, SIZE, OR COLOR.

NO CLAIM IS MADE TO THE EXCLUSIVE RIGHT TO USE "VIDEOS", APART FROM THE MARK AS SHOWN.

FOR RETAIL STORE SERVICES FEATURING DVDS, DOWNLOADABLE VIDEO RECORDINGS AND DOWNLOADABLE AUDIO AND VIDEO RECORDINGS; AND ADVERTISING, MARKETING AND PROMOTION SERVICES (U.S. CLS. 100, 101 AND 102).

FIRST USE 8-23-2002; IN COMMERCE 8-23-2002.
LAURIE MAYES, EXAMINING ATTORNEY

CLASS 35—(Continued).

SN 76-658,515. NEW YORK DESIGN CENTER, INC., NEW YORK, NY. FILED 4-17-2006.

Designer's Saturday

THE MARK CONSISTS OF STANDARD CHARACTERS WITHOUT CLAIM TO ANY PARTICULAR FONT, STYLE, SIZE, OR COLOR.

NO CLAIM IS MADE TO THE EXCLUSIVE RIGHT TO USE "DESIGNER'S", APART FROM THE MARK AS SHOWN.

FOR ARRANGING AND CONDUCTING TRADE SHOW EXHIBITIONS IN THE FIELD OF INTERIOR DESIGN (U.S. CLS. 100, 101 AND 102).

FIRST USE 0-0-1968; IN COMMERCE 0-0-1968.

DOMINIC J. FERRAIUOLO, EXAMINING ATTORNEY

SN 76-658,584. INGLES MARKETS, INC., ASHEVILLE, NC. FILED 4-17-2006.

THE I MARKET

THE MARK CONSISTS OF STANDARD CHARACTERS WITHOUT CLAIM TO ANY PARTICULAR FONT, STYLE, SIZE, OR COLOR.

OWNER OF U.S. REG. NOS. 1,027,004, 2,866,902 AND 2,990,407.

NO CLAIM IS MADE TO THE EXCLUSIVE RIGHT TO USE "MARKET", APART FROM THE MARK AS SHOWN.

FOR RETAIL STORE SERVICES, NAMELY, OPERATION OF RETAIL CONVENIENCE STORES (U.S. CLS. 100, 101 AND 102).

MAUREEN DALL, EXAMINING ATTORNEY

SN 76-658,585. INGLES MARKETS, INC., ASHEVILLE, NC. FILED 4-17-2006.

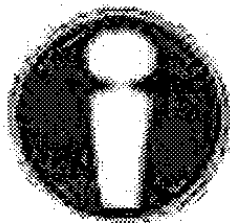

OWNER OF U.S. REG. NOS. 1,027,004, 2,866,902 AND 2,990,407.

FOR RETAIL STORE SERVICES, NAMELY, OPERATION OF RETAIL CONVENIENCE STORES (U.S. CLS. 100, 101 AND 102).

MAUREEN DALL, EXAMINING ATTORNEY

CLASS 35—(Continued).

SN 76-658,713. CONTINENTAL PROMOTION GROUP, INC., TAMPA, FL. FILED 4-19-2006.

FULFILLING THE PROMISE OF PROMOTION

THE MARK CONSISTS OF STANDARD CHARACTERS WITHOUT CLAIM TO ANY PARTICULAR FONT, STYLE, SIZE, OR COLOR.

FOR PROMOTING THE SALE OF GOODS AND SERVICES OF OTHERS THROUGH THE DEVELOPMENT OF CUSTOMIZED PROMOTIONAL CAMPAIGNS, THE MANAGEMENT AND FULFILLMENT OF CONSUMER REBATE PROMOTIONS, PREPAID PROMOTIONAL CARD MANAGEMENT SERVICES, THE FULFILLMENT OF PREMIUM, SAMPLE AND GIFT CARD PROMOTIONS, THE ADMINISTRATION OF SWEEPSTAKES, GAMES, AND CONTESTS, THE ADMINISTRATION OF CONSUMER RETENTION PROGRAMS, THE ADMINISTRATION OF BUSINESS-TO-BUSINESS TRADE PERFORMANCE INCENTIVE PROMOTIONS, AND CALL CENTER, DATA PROCESSING AND CUSTOMER SUPPORT SERVICES (U.S. CLS. 100, 101 AND 102).

FIRST USE 4-5-2005; IN COMMERCE 4-5-2005.

KAPIL BHANOT, EXAMINING ATTORNEY

SN 76-658,726. VALUE ASSET LEASING, INC., FREDERICK, MD. FILED 4-18-2006.



THE MARK IS A STYLIZED REPRESENTATION OF A STICK FIGURE REPRESENTING A PROUD MAN.

FOR EMPLOYMENT AGENCY SERVICES (U.S. CLS. 100, 101 AND 102).

FIRST USE 1-1-2000; IN COMMERCE 1-1-2000.

JULIE GUTTADAURO, EXAMINING ATTORNEY

SN 76-658,760. THERAMATCH REGISTRY CORP., GLEN HEAD, NY. FILED 4-20-2006.



FOR MAINTAINING A REGISTRY OF MEDICAL HEALTHCARE PROFESSIONALS (U.S. CLS. 100, 101 AND 102).

FIRST USE 3-23-2006; IN COMMERCE 3-23-2006.

PAULA MAYS, EXAMINING ATTORNEY

CLASS 35—(Continued).

SN 76-658,953. EPMO SOLUTIONS, LLC, PORTLAND, OR.
FILED 4-24-2006.

PM HELPDESK

THE MARK CONSISTS OF STANDARD CHARACTERS WITHOUT CLAIM TO ANY PARTICULAR FONT, STYLE, SIZE, OR COLOR.

NO CLAIM IS MADE TO THE EXCLUSIVE RIGHT TO USE "PM", APART FROM THE MARK AS SHOWN.

FOR BUSINESS CONSULTING SERVICES, NAMELY, PROJECT MANAGEMENT CONSULTING (U.S. CLS. 100, 101 AND 102).

DAVID COLLIER, EXAMINING ATTORNEY

SN 76-659,039. FRESH INTELLECTUAL PROPERTIES, INC.,
WILMINGTON, DE. FILED 4-25-2006.

FIELDS OF THE WORLD

THE MARK CONSISTS OF STANDARD CHARACTERS WITHOUT CLAIM TO ANY PARTICULAR FONT, STYLE, SIZE, OR COLOR.

FOR ONLINE RETAIL STORE SERVICES AND TELEPHONE AND MAIL ORDER CATALOG SERVICES FEATURING FLORAL ARRANGEMENTS AND BOUTIQUES (U.S. CLS. 100, 101 AND 102).

FIRST USE 4-3-2006; IN COMMERCE 4-3-2006.
HEATHER SAPP, EXAMINING ATTORNEY

SN 76-659,130. US INTERNATIONAL MEDIA, LLC, LOS ANGELES, CA. FILED 4-21-2006.

PERFECT PLACE MEDIA

THE MARK CONSISTS OF STANDARD CHARACTERS WITHOUT CLAIM TO ANY PARTICULAR FONT, STYLE, SIZE, OR COLOR.

NO CLAIM IS MADE TO THE EXCLUSIVE RIGHT TO USE MEDIA, APART FROM THE MARK AS SHOWN.

FOR ADVERTISING SERVICES, NAMELY, PROMOTING THE GOODS AND SERVICES OF OTHERS THROUGH THE APPEARANCE OF PRODUCTS AND SERVICES IN MOVIES, TELEVISION PROGRAMS AND OTHER AUDIO-VISUAL MEDIA (U.S. CLS. 100, 101 AND 102).

JAMES GRIFFIN, EXAMINING ATTORNEY

CLASS 35—(Continued).

SN 76-661,858. STRATHMORE PARTNERS LP, CONCORD, NH. FILED 6-20-2006.

BJ'S MEMBER PRICING

THE MARK CONSISTS OF STANDARD CHARACTERS WITHOUT CLAIM TO ANY PARTICULAR FONT, STYLE, SIZE, OR COLOR.

OWNER OF U.S. REG. NO. 1,751,720.

NO CLAIM IS MADE TO THE EXCLUSIVE RIGHT TO USE "MEMBER PRICING", APART FROM THE MARK AS SHOWN.

FOR RETAIL FOOD AND GENERAL MERCHANDISE CLUB BUYING SERVICES (U.S. CLS. 100, 101 AND 102).
FIRST USE 10-19-2005; IN COMMERCE 10-19-2005.

MYRIAH HABEEB, EXAMINING ATTORNEY

SN 76-977,905. TECHNICOLOR VIDEOCASSETTE B.V., HELMOND, NETHERLANDS, FILED 12-6-2004.

TECHNICOLOR

THE MARK CONSISTS OF STANDARD CHARACTERS WITHOUT CLAIM TO ANY PARTICULAR FONT, STYLE, SIZE, OR COLOR.

OWNER OF U.S. REG. NOS. 267,288, 2,654,929 AND OTHERS.

FOR PROVIDING BROADCAST FACILITY BUSINESS MANAGEMENT; AND BUSINESS MANAGEMENT OF DIGITAL DISTRIBUTION OF CONTENT FOR MOTION PICTURES (U.S. CLS. 100, 101 AND 102).

STEVEN JACKSON, EXAMINING ATTORNEY

SN 78-310,746. MESTRA AG, 4153 REINACH BL1, SWITZERLAND, FILED 10-8-2003.

E-DIRECT

FOR ORDERING SERVICE ALLOWING CUSTOMERS TO ORDER AND PURCHASE SIMPLE PROCESS CONTROL AND MEASUREMENT INSTRUMENTS FROM THE MANUFACTURER VIA MAIL ORDER, TELEPHONE OR A GLOBAL COMPUTER NETWORK (U.S. CLS. 100, 101 AND 102).

FIRST USE 0-0-1998; IN COMMERCE 0-0-1998.

IRENE D. WILLIAMS, EXAMINING ATTORNEY

SN 78-315,029. MONSTER (CALIFORNIA), INC., EL SEGUNDO, CA. FILED 10-17-2003.

MONSTER

OWNER OF U.S. REG. NOS. 1,980,988, 2,692,520 AND OTHERS.

FOR BUSINESS AND CAREER NETWORKING SERVICES (U.S. CLS. 100, 101 AND 102).

FIRST USE 0-0-2004; IN COMMERCE 0-0-2004.

ANN E. SAPPENFIELD, EXAMINING ATTORNEY

CLASS 35—(Continued).

SN 78-378,863. RSC THE QUALITY MEASUREMENT COMPANY, EVANSVILLE, IN. FILED 3-4-2004.

ARS CONTEXT

THE MARK CONSISTS OF STANDARD CHARACTERS WITHOUT CLAIM TO ANY PARTICULAR FONT, STYLE, SIZE, OR COLOR.

OWNER OF U.S. REG. NOS. 2,078,587, 2,905,719 AND OTHERS.

NO CLAIM IS MADE TO THE EXCLUSIVE RIGHT TO USE "CONTEXT", APART FROM THE MARK AS SHOWN.

FOR CONSULTING SERVICES IN THE FIELD OF ADVERTISING; PROVIDING AN ONLINE DATABASE FEATURING TELEVISION AND PRINT MEDIA ADVERTISING; AND PROVIDING INFORMATION IN THE FIELD OF ADVERTISING, NAMELY, DATA AND ANALYSIS OF COMPETITIVE ADVERTISING (U.S. CLS. 100, 101 AND 102).

FIRST USE 10-22-2003; IN COMMERCE 10-22-2003.
BRIAN PINO, EXAMINING ATTORNEY

SN 78-449,857. P.C. RICHARD & SON LONG ISLAND CORP., FARMINGDALE, NY. FILED 7-13-2004.

NOBODY BEATS

THE MARK CONSISTS OF STANDARD CHARACTERS WITHOUT CLAIM TO ANY PARTICULAR FONT, STYLE, SIZE, OR COLOR.

OWNER OF U.S. REG. NOS. 1,395,362, 1,905,190 AND OTHERS.

FOR RETAIL STORE SERVICES IN THE FIELDS OF CONSUMER ELECTRONICS AND ACCESSORIES, COMPUTER HARDWARE AND SOFTWARE, PRERECORDED MOVIES AND MUSIC, AND HOUSEHOLD APPLIANCES (U.S. CLS. 100, 101 AND 102).

FIRST USE 3-14-1993; IN COMMERCE 3-14-1993.
KHANH LE, EXAMINING ATTORNEY

CLASS 35—(Continued).

SN 78-456,181. VERRAS MEDICAL, INC., SAN MATEO, CA. FILED 7-24-2004.

IAMETER

THE MARK CONSISTS OF STANDARD CHARACTERS WITHOUT CLAIM TO ANY PARTICULAR FONT, STYLE, SIZE, OR COLOR.

FOR MEDICAL DATA SUPPORT SERVICES IN THE NATURE OF INTERACTIVE RECORD-KEEPING SERVICES FOR USE IN REGULATORY COMPLIANCE BY HOSPITALS AND FOR THE FACILITATION OF QUALITY IMPROVEMENT; DATA COMPILING AND ANALYZING TO PROVIDE CODED MEDICAL RECORDS DATA AND STATISTICAL ALGORITHMS FOR QUALIFYING AND QUANTIFYING PATIENT SEVERITY ASSESSMENTS; BUSINESS CONSULTATION SERVICES FACILITATING QUALITY IMPROVEMENT PROCESSES FOR PHYSICIANS AND HOSPITALS TO IMPROVE THE CLINICAL QUALITY AND COST EFFICIENCIES OF HOSPITAL PERFORMANCE (U.S. CLS. 100, 101 AND 102).

FIRST USE 0-0-1983; IN COMMERCE 0-0-1983.
ANN E. SAPPENFIELD, EXAMINING ATTORNEY

SN 78-486,405. FLEMING CORPORATION OF KANSAS, PITTSBURG, KS. FILED 9-20-2004.

FLEMING

THE MARK CONSISTS OF STANDARD CHARACTERS WITHOUT CLAIM TO ANY PARTICULAR FONT, STYLE, SIZE, OR COLOR.

FOR RETAIL STORE SERVICES FEATURING CONVENIENCE STORE ITEMS AND GASOLINE (U.S. CLS. 100, 101 AND 102).

IRA J. GOODSaid, EXAMINING ATTORNEY

CLASS 35—(Continued).

SN 78-505,311. INTERDENT, INC., EL SEGUNDO, CA.
FILED 10-25-2004.



OWNER OF U.S. REG. NOS. 2,251,610 AND 2,553,126.
THE MARK CONSISTS OF THE WORD INTERDENT
ENCOMPASSED BY AN ELLIPSE.

FOR DENTAL PRACTICE MANAGEMENT SERVICES,
NAMELY, NON-DENTAL PERSONNEL HIRING AND
ADMINISTRATION, PATIENT SCHEDULING AND
BILLING, NAMELY, PREPARATION OF FINANCIAL
STATEMENTS, PAYMENT OF PAYABLES AND BILL-
ING RECEIVABLES; COOPERATIVE ADVERTISING
AND MARKETING SERVICES, AND BUYING CLUBS
(U.S. CLS. 100, 101 AND 102).

FIRST USE 4-1-1999; IN COMMERCE 4-1-1999.
PRISCILLA MILTON, EXAMINING ATTORNEY

CLASS 35—(Continued).

SN 78-527,958. AMERICAN PACIFIC INDUSTRIES, INC.,
VALENCIA, CA. FILED 12-6-2004.

AMERICAN PACIFIC
INDUSTRIES

THE MARK CONSISTS OF STANDARD CHARACTERS
WITHOUT CLAIM TO ANY PARTICULAR FONT, STYLE,
SIZE, OR COLOR.

NO CLAIM IS MADE TO THE EXCLUSIVE RIGHT TO
USE "AMERICAN" AND "INDUSTRIES", APART FROM
THE MARK AS SHOWN.

FOR WHOLESALE DISTRIBUTORSHIP FEATURING
TIRES (U.S. CLS. 100, 101 AND 102).

ROBERT C. CLARK JR., EXAMINING ATTORNEY

SN 78-518,298. AGM DEVELOPMENT, INC., FENTON, MO.
FILED 11-17-2004.

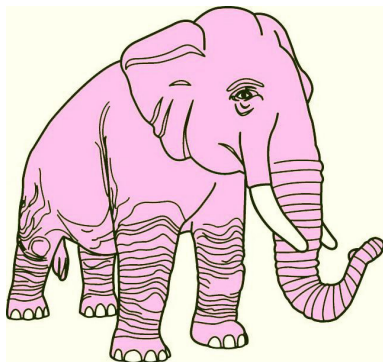

THE COLOR(S) PINK AND WHITE IS/ARE CLAIMED AS
A FEATURE OF THE MARK.

THE MARK CONSISTS OF A THREE-DIMENSIONAL
DESIGN OF A PINK ELEPHANT WITH WHITE TUSKS
AND WHITE CLAWS.

FOR RETAIL STORE SERVICES FEATURING CON-
VENIENCE STORE ITEMS, LIQUOR, BEER, TOBACCO
PRODUCTS, AND GASOLINE (U.S. CLS. 100, 101 AND
102).

FIRST USE 7-0-1982; IN COMMERCE 7-0-1982.
MICHELLE DUBOIS, EXAMINING ATTORNEY

SN 78-551,145. AMERICAN INSTITUTE OF GASTRIC
BANDING, LTD., RICHARDSON, TX. FILED 1-20-2005.

American Institute of
GASTRIC BANDING

NO CLAIM IS MADE TO THE EXCLUSIVE RIGHT TO
USE "AMERICAN INSTITUTE OF GASTRIC BANDING",
APART FROM THE MARK AS SHOWN.

FOR COOPERATIVE ADVERTISING AND MARKET-
ING SERVICES, NAMELY, PROVIDING PHYSICIAN
REFERRALS FEATURING PHYSICIAN CONTACT IN-
FORMATION VIA A GLOBAL COMPUTER NETWORK,
PROVIDING CONSUMER INFORMATION IN THE
FIELD OF GASTRIC BANDING PROCEDURES VIA A
GLOBAL COMPUTER NETWORK, AND PROVIDING
MARKETING INFORMATION IN THE FIELD OF GAS-
TRIC BANDING PROCEDURES VIA A GLOBAL COM-
PUTER NETWORK; ASSOCIATION SERVICES,
NAMELY, PROMOTING THE INTERESTS OF A NET-
WORK OF HEALTH CARE PROFESSIONALS SPECIA-
LIZING IN TREATMENT OBESITY USING GASTRIC
BANDING TECHNIQUES (U.S. CLS. 100, 101 AND 102).

FIRST USE 7-1-2004; IN COMMERCE 7-1-2004.
LINDA ESTRADA, EXAMINING ATTORNEY

CLASS 35—(Continued).

SN 78-552,478. CHESAPEAKE WILDLIFE HERITAGE, INC., EASTON, MD. FILED 1-24-2005.



THE STIPPLING IS FOR SHADING PURPOSES ONLY. THE MARK CONSISTS OF A DESIGN OF A GOOSE, CATTAILS AND A SUN.

FOR PROMOTING PUBLIC AWARENESS OF THE NEED FOR CREATING, RESTORING AND PROTECTING WILDLIFE HABITATS, ESTABLISHING SUSTAINABLE AGRICULTURE, AND CONSTRUCTING AND MANAGING WETLAND HABITAT AND SHALLOW IMPOUNDMENTS FOR WILDLIFE (U.S. CLS. 100, 101 AND 102).

FIRST USE 12-31-1984; IN COMMERCE 12-31-1984. SHAUNIA WALLACE, EXAMINING ATTORNEY

CLASS 35—(Continued).

SN 78-590,976. FARAINO, PAMELA L., DBA ADDRESS THE MESS, VIRGINIA BEACH, VA. FILED 3-19-2005.

Address The Mess

THE MARK CONSISTS OF STANDARD CHARACTERS WITHOUT CLAIM TO ANY PARTICULAR FONT, STYLE, SIZE, OR COLOR.

FOR CONSULTING AND PROFESSIONAL SERVICES IN THE FIELD OF ORGANIZING, NAMELY PROVIDING ORGANIZING SERVICES FOR BELONGINGS AND SPACES IN A RESIDENCE OR OFFICE, NAMELY PERSONAL POSSESSIONS, PAPERS, AND TIME (U.S. CLS. 100, 101 AND 102).

FIRST USE 3-27-2003; IN COMMERCE 2-4-2005. TIMOTHY FINNEGAN, EXAMINING ATTORNEY

SN 78-591,036. DOGFLY ENTERTAINMENT, INC., TARZANA, CA. FILED 3-19-2005.

SN 78-590,582. LINK ARTIST RESOURCES, DALLAS, TX. FILED 3-18-2005.

LINK
ARTIST RESOURCES

NO CLAIM IS MADE TO THE EXCLUSIVE RIGHT TO USE "ARTIST RESOURCES", APART FROM THE MARK AS SHOWN.

THE COLOR(S) PINK, RED AND DARK BROWN IS/ARE CLAIMED AS A FEATURE OF THE MARK.

THE LETTERS L, N, AND K IN THE WORD LINK APPEAR IN THE COLOR RED. THE LETTER I IN THE WORD LINK APPEARS IN THE COLOR PINK. THE WORDS ARTIST RESOURCES APPEAR IN THE COLOR DARK BROWN.

FOR PERSONAL MANAGEMENT SERVICES FOR ON-SET CREATIVE ARTISTS (U.S. CLS. 100, 101 AND 102). MARK T. MULLEN, EXAMINING ATTORNEY

Strip Cards

THE MARK CONSISTS OF STANDARD CHARACTERS WITHOUT CLAIM TO ANY PARTICULAR FONT, STYLE, SIZE, OR COLOR.

NO CLAIM IS MADE TO THE EXCLUSIVE RIGHT TO USE "CARDS", APART FROM THE MARK AS SHOWN.

FOR RETAIL STORE SERVICES, FEATURING COMPACT DISCS, DIGITAL TRADING CARDS RECORDED ON MAGNETIC MEDIA, AND DVDS ALL FEATURING PERSONAL CONTACT AND BUSINESS INFORMATION OF ADULT ENTERTAINERS, NAMELY, STRIPPERS (U.S. CLS. 100, 101 AND 102).

BERYL GARDNER, EXAMINING ATTORNEY

CLASS 35—(Continued).

SN 78-593,314. LABOR ADVERTISING NETWORK, INC., ST. LOUIS, MO. FILED 3-23-2005.



NO CLAIM IS MADE TO THE EXCLUSIVE RIGHT TO USE "LABOR ADVERTISING NETWORK", APART FROM THE MARK AS SHOWN.

FOR MARKETING SERVICES FOR THIRD PARTIES, NAMELY, CREATING ADVERTISING AND MARKETING MATERIALS FOR PRINT MEDIA, FOR DIRECT MAIL MEDIA, FOR RADIO, FOR TELEVISION AND FOR A WORLD-WIDE COMPUTER NETWORK AND MANAGING THE PRODUCTION AND DISTRIBUTION OF MARKETING MATERIALS (U.S. CLS. 100, 101 AND 102).

FIRST USE 9-0-2002; IN COMMERCE 9-0-2002.
CURTIS FRENCH, EXAMINING ATTORNEY

SN 78-594,241. CHRISTIANITY TODAY INTERNATIONAL, CAROL STREAM, IL. FILED 3-24-2005.

SERMON NOTES

NO CLAIM IS MADE TO THE EXCLUSIVE RIGHT TO USE "SERMON NOTES", APART FROM THE MARK AS SHOWN.

THE COLOR(S) GREEN AND GRAY IS/ARE CLAIMED AS A FEATURE OF THE MARK.

THE WORDING AND DESIGN ELEMENTS APPEAR IN GREEN WITH GRAY SHADOWING.

FOR ONLINE SUBSCRIPTION SERVICE FEATURING INFORMATION IN THE FIELD OF MINISTERIAL SERVICES, NAMELY, TRANSCRIPTS AND OUTLINES RELATING TO PREACHING AND ITS PRACTICES (U.S. CLS. 100, 101 AND 102).

FIRST USE 10-31-1996; IN COMMERCE 4-30-1997.
STEVEN PEREZ, EXAMINING ATTORNEY

SN 78-611,761. BASS PRO TRADEMARKS, L.L.C., SPRINGFIELD, MO. FILED 4-19-2005.

**BASS PRO SHOPS YOUR
ADVENTURE STARTS HERE**

THE MARK CONSISTS OF STANDARD CHARACTERS WITHOUT CLAIM TO ANY PARTICULAR FONT, STYLE, SIZE, OR COLOR.

OWNER OF U.S. REG. NOS. 1,116,517, 2,193,039 AND OTHERS.

NO CLAIM IS MADE TO THE EXCLUSIVE RIGHT TO USE "PRO SHOPS", APART FROM THE MARK AS SHOWN. FOR RETAIL SPORTING GOODS STORE SERVICES (U.S. CLS. 100, 101 AND 102).

FIRST USE 6-0-2004; IN COMMERCE 6-0-2004.
KEVON CHISOLM, EXAMINING ATTORNEY

CLASS 35—(Continued).

SN 78-612,722. ONE STOP UNDERCAR, INC. SANTA ANA, CA. FILED 4-20-2005.

**One Stop
Parts Source**

OWNER OF U.S. REG. NO. 2,390,854.

NO CLAIM IS MADE TO THE EXCLUSIVE RIGHT TO USE "PARTS SOURCE", APART FROM THE MARK AS SHOWN.

FOR WHOLESALE DISTRIBUTORSHIPS IN THE FIELD OF AUTOMOTIVE PARTS AND ACCESSORIES (U.S. CLS. 100, 101 AND 102).

FIRST USE 1-1-2005; IN COMMERCE 1-1-2005.
KRISTIN DAHLING, EXAMINING ATTORNEY

SN 78-613,280. INTERNATIONAL TACTICAL PRODUCTS, INC., BRUNSWICK, GA. FILED 4-20-2005.



NO CLAIM IS MADE TO THE EXCLUSIVE RIGHT TO USE "COP SHOP", APART FROM THE MARK AS SHOWN.

THE COLORS GRAY AND BLACK ARE CLAIMED AS A FEATURE OF THE MARK

THE MARK CONSISTS OF TWO BLACK RECTANGLES WITH THE WORD SCS IN THE TOP RECTANGLE AND THE WORDS SALLY'S COP SHOP IN THE BOTTOM RECTANGLE. THE BACKGROUND OF THE MARK IS GREY. THERE ARE TWO BLACK STRIPES THAT EXTEND FROM EITHER END OF THE SCS COMPONENT.

FOR RETAIL STORE SERVICES FEATURING CLOTHING, UNIFORMS AND OTHER ACCESSORIES FOR LAW ENFORCEMENT OFFICIALS; ON-LINE RETAIL STORE SERVICES FEATURING CLOTHING, UNIFORMS AND OTHER ACCESSORIES FOR LAW ENFORCEMENT OFFICIALS (U.S. CLS. 100, 101 AND 102).

FIRST USE 12-1-2004; IN COMMERCE 12-1-2004.
CHRIS WELLS, EXAMINING ATTORNEY

CLASS 35—(Continued).

SN 78-616,819. LOEFFLER, FRANK, BURLINGAME, CA. FILED 4-26-2005.



FOR BUSINESS CONSULTING FOR INTERNET SERVICES AND ONLINE RETAIL STORE SERVICES FEATURING COMPUTER PRODUCTS (U.S. CLS. 100, 101 AND 102).

FIRST USE 8-19-2003; IN COMMERCE 9-13-2003.
JOHN E. MICHOS, EXAMINING ATTORNEY

SN 78-618,387. COMICS MY WAY, ELK GROVE, CA. FILED 4-27-2005.

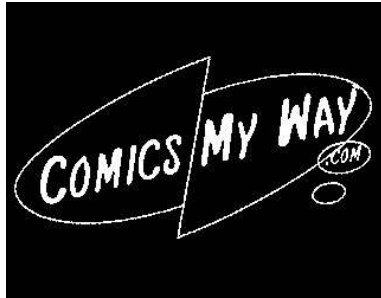

NO CLAIM IS MADE TO THE EXCLUSIVE RIGHT TO USE "COMICS" AND ".COM", APART FROM THE MARK AS SHOWN.

FOR ON-LINE RETAIL STORE SERVICES FEATURING COMIC BOOKS, GRAPHIC NOVELS, ANIME DVD'S, AND ANIME BOOKS (U.S. CLS. 100, 101 AND 102).

JOHN DWYER, EXAMINING ATTORNEY

SN 78-624,149. CASTLE BRANDS INC., NEW YORK, NY. FILED 5-5-2005.

CASTLE BRANDS

THE MARK CONSISTS OF STANDARD CHARACTERS WITHOUT CLAIM TO ANY PARTICULAR FONT, STYLE, SIZE, OR COLOR.

OWNER OF U.S. REG. NO. 2,904,897.

NO CLAIM IS MADE TO THE EXCLUSIVE RIGHT TO USE "BRANDS", APART FROM THE MARK AS SHOWN.

FOR DISTRIBUTORSHIP SERVICES IN THE FIELD OF ALCOHOLIC BEVERAGES OTHER THAN WINES (U.S. CLS. 100, 101 AND 102).

FIRST USE 2-12-2004; IN COMMERCE 2-12-2004.
JOHN DALIER, EXAMINING ATTORNEY

CLASS 35—(Continued).

SN 78-635,603. SUITED & BOOTED LLC, INGLEWOOD, CA. FILED 5-24-2005.



FOR MANAGEMENT OF PERFORMING ARTISTS, NAMELY PERSONAL, BUSINESS AND CAREER MANAGEMENT SERVICES AND REPRESENTATION SERVICES (U.S. CLS. 100, 101 AND 102).

FIRST USE 12-1-2004; IN COMMERCE 12-1-2004.
JEFFERY COWARD, EXAMINING ATTORNEY

SN 78-635,952. BOYER, TERRI, PRAIRIEVILLE, LA. FILED 5-24-2005.

DESIGN WITH YOU

THE MARK CONSISTS OF STANDARD CHARACTERS WITHOUT CLAIM TO ANY PARTICULAR FONT, STYLE, SIZE, OR COLOR.

FOR ONLINE RETAIL STORE SERVICES FEATURING INSTRUCTIONAL VIDEOS PERTAINING TO INTERIOR DESIGN AND HOME DECORATING (U.S. CLS. 100, 101 AND 102).

SEAN CROWLEY, EXAMINING ATTORNEY

SN 78-638,783. STAR CREATIONS, INC., BROOKLYN, NY. FILED 5-27-2005.

MADISON

THE MARK CONSISTS OF STANDARD CHARACTERS WITHOUT CLAIM TO ANY PARTICULAR FONT, STYLE, SIZE, OR COLOR.

FOR RETAIL STORE SERVICES, MAIL ORDER SERVICES, AND RETAIL SERVICES OFFERED THROUGH A GLOBAL COMPUTER NETWORK, ALL OF WHICH FEATURE MAJOR HOUSEHOLD APPLIANCES, KITCHEN ACCESSORIES, BARBEQUE GRILLS AND ACCESSORIES, OUTDOOR APPLIANCES (U.S. CLS. 100, 101 AND 102).

ANNE FARRELL, EXAMINING ATTORNEY

CLASS 35—(Continued).

SN 78-644,334. PHARMATECH SOLUTIONS, INC., WILMINGTON, NC. FILED 6-6-2005.

EPOC

THE MARK CONSISTS OF STANDARD CHARACTERS WITHOUT CLAIM TO ANY PARTICULAR FONT, STYLE, SIZE, OR COLOR.

FOR MEDICAL RESEARCH RECRUITING SERVICES FOR CLINICAL TRIALS (U.S. CLS. 100, 101 AND 102).
RONALD AIKENS, EXAMINING ATTORNEY

SN 78-647,141. DEAFMART TECHNOLOGIES, INC., SPRINGWATER, NY. FILED 6-9-2005.

DEAFMART TECHNOLOGIES

THE MARK CONSISTS OF STANDARD CHARACTERS WITHOUT CLAIM TO ANY PARTICULAR FONT, STYLE, SIZE, OR COLOR.

NO CLAIM IS MADE TO THE EXCLUSIVE RIGHT TO USE "TECHNOLOGIES", APART FROM THE MARK AS SHOWN.

FOR RETAIL STORE SERVICES FEATURING COMMUNICATION DEVICES AND SERVICE PLANS RELATED THERETO (U.S. CLS. 100, 101 AND 102).

FIRST USE 8-31-2004; IN COMMERCE 8-31-2004.
CHARLES L. JENKINS, EXAMINING ATTORNEY

SN 78-647,915. THE DETAILED HOME, INC., MIAMI BEACH, FL. FILED 6-10-2005.

MAKE ROOM FOR BABY

THE MARK CONSISTS OF STANDARD CHARACTERS WITHOUT CLAIM TO ANY PARTICULAR FONT, STYLE, SIZE, OR COLOR.

FOR DISTRIBUTORSHIP SERVICES FEATURING INFANT AND CHILD CLOTHING AND FURNITURE DECORATIONS, ACCESSORIES AND TOYS, CRIB SETS AND CRIB SET KITS, BABY COMB AND BRUSH SETS, TISSUE BOX COVERS, WASTE BASKETS AND WASTE BASKET KITS, LAUNDRY BASKETS, INFANT AND CHILD CLOTHING AND HEAD GEAR, CANOPY KITS, CURTAIN PATTERNS, SHADES, VALANCES, CORNICES AND LAMPSHADES AND LAMPSHADE KITS (U.S. CLS. 100, 101 AND 102).

STEPHANIE DAVIS, EXAMINING ATTORNEY

CLASS 35—(Continued).

SN 78-648,778. DESIGN 166 CORP., NEW YORK, NY. FILED 6-11-2005.

autre couture

THE MARK CONSISTS OF STANDARD CHARACTERS WITHOUT CLAIM TO ANY PARTICULAR FONT, STYLE, SIZE, OR COLOR.

NO CLAIM IS MADE TO THE EXCLUSIVE RIGHT TO USE "COUTURE", APART FROM THE MARK AS SHOWN. THE FOREIGN WORDING AUTRE IN THE MARK TRANSLATES INTO ENGLISH AS OTHER.

FOR RETAIL CLOTHING STORE FEATURING LADIES' AND MEN'S CLOTHING, SHOES AND ACCESSORIES (U.S. CLS. 100, 101 AND 102).

FIRST USE 6-1-2004; IN COMMERCE 6-1-2004.
STEVEN PEREZ, EXAMINING ATTORNEY

SN 78-657,067. NOREALTYFEE INC., DRYDEN, ONTARIO, CANADA, FILED 6-23-2005.

NOREALTYFEE

THE MARK CONSISTS OF STANDARD CHARACTERS WITHOUT CLAIM TO ANY PARTICULAR FONT, STYLE, SIZE, OR COLOR.

FOR ONLINE REAL ESTATE ADVERTISING SERVICES FOR BROKERS, LANDLORDS, RENTERS AND SELLERS OF HOMES, HOUSES, APARTMENTS, CONDOS AND PROPERTIES GENERALLY VIA THE WORLD WIDE WEB (U.S. CLS. 100, 101 AND 102).

FIRST USE 5-31-2000; IN COMMERCE 5-31-2000.
BARBARA BROWN, EXAMINING ATTORNEY

SN 78-662,493. SILVER GHOST ASSOCIATION, TAYLORVILLE, IL. FILED 7-1-2005.

SILVER GHOST ASSOCIATION

THE MARK CONSISTS OF STANDARD CHARACTERS WITHOUT CLAIM TO ANY PARTICULAR FONT, STYLE, SIZE, OR COLOR.

NO CLAIM IS MADE TO THE EXCLUSIVE RIGHT TO USE "ASSOCIATION", APART FROM THE MARK AS SHOWN.

FOR ASSOCIATION SERVICES, NAMELY, PROMOTING THE INTERESTS OF ENTHUSIASTS OF ANTIQUE AND CLASSIC AUTOMOBILES (U.S. CLS. 100, 101 AND 102).

FIRST USE 8-0-1986; IN COMMERCE 8-0-1986.
LEIGH CAROLINE CASE, EXAMINING ATTORNEY

CLASS 35—(Continued).

SN 78-670,651. GQXZP2, LLC, SAN ANTONIO, TX. FILED 7-14-2005.

A.NET

THE MARK CONSISTS OF STANDARD CHARACTERS WITHOUT CLAIM TO ANY PARTICULAR FONT, STYLE, SIZE, OR COLOR.

FOR ON-LINE WHOLESALE AND RETAIL STORE SERVICES FEATURING GENERAL CONSUMER MERCHANDISE, NAMELY, CLOTHING, SHOES, BATH AND BODY PRODUCTS, JEWELRY, ELECTRONICS, COOKWARE, HOUSEWARES, APPLIANCES, FURNITURE, LINENS, PILLOWS, DECORATIVE ACCESSORIES, OFFICE FURNITURE AND ACCESSORIES, TOYS, GAMES, SPORTING GOODS, TOOLS, OUTDOOR LAWN AND GARDEN EQUIPMENT, PET SUPPLIES AND PAPER PRODUCTS (U.S. CLS. 100, 101 AND 102).

ATTIYA MALIK, EXAMINING ATTORNEY

SN 78-674,702. MILWAUKEE POLICE ASSOCIATION, MILWAUKEE, WI. FILED 7-20-2005.

MPA

THE MARK CONSISTS OF STANDARD CHARACTERS WITHOUT CLAIM TO ANY PARTICULAR FONT, STYLE, SIZE, OR COLOR.

SEC. 2(F).
FOR LABOR UNION SERVICES NAMELY, GENERAL LABOR UNION ACTIVITIES FOR THE BENEFIT OF ITS MEMBERS (U.S. CLS. 100, 101 AND 102).

FIRST USE 1-1-1977; IN COMMERCE 1-1-1977.

SHANNON TWOHIG, EXAMINING ATTORNEY

SN 78-674,725. MILWAUKEE POLICE ASSOCIATION, MILWAUKEE, WI. FILED 7-20-2005.

MILWAUKEE POLICE ASSOCIATION

THE MARK CONSISTS OF STANDARD CHARACTERS WITHOUT CLAIM TO ANY PARTICULAR FONT, STYLE, SIZE, OR COLOR.

NO CLAIM IS MADE TO THE EXCLUSIVE RIGHT TO USE "POLICE ASSOCIATION", APART FROM THE MARK AS SHOWN.

SEC. 2(F).

FOR PROVIDING LABOR RELATIONS SERVICES, NAMELY, ESTABLISHING COMMITTEES WITH UNIONS TO PROMOTE IMPROVED RELATIONS BETWEEN EMPLOYERS AND UNIONS; ASSOCIATION SERVICES, NAMELY, PROMOTING THE INTERESTS OF POLICE UNION MEMBERS; LABOR UNIONS (U.S. CLS. 100, 101 AND 102).

FIRST USE 1-1-1977; IN COMMERCE 1-1-1977.

ANDREA EVANS, EXAMINING ATTORNEY

CLASS 35—(Continued).

SN 78-676,611. TOP PRODUCER SYSTEMS COMPANY, RICHMOND, CANADA, FILED 7-22-2005.

TOP MARKETER

THE MARK CONSISTS OF STANDARD CHARACTERS WITHOUT CLAIM TO ANY PARTICULAR FONT, STYLE, SIZE, OR COLOR.

NO CLAIM IS MADE TO THE EXCLUSIVE RIGHT TO USE "MARKETER", APART FROM THE MARK AS SHOWN.

FOR REAL ESTATE REFERRAL SERVICES; PROVIDING POTENTIAL REAL ESTATE BUYERS AND SELLERS REFERRALS TO REAL ESTATE AGENTS VIA THE INTERNET; PROVIDING REAL ESTATE AGENTS WITH INFORMATION ON CUSTOMERS SEEKING REAL ESTATE SERVICES (U.S. CLS. 100, 101 AND 102).

ANDREA K. NADELMAN, EXAMINING ATTORNEY

SN 78-677,967. ACADEMY OF INTERACTIVE ARTS AND SCIENCES, CALABASAS, CA. FILED 7-25-2005.

D.I.C.E. SUMMIT

THE MARK CONSISTS OF STANDARD CHARACTERS WITHOUT CLAIM TO ANY PARTICULAR FONT, STYLE, SIZE, OR COLOR.

NO CLAIM IS MADE TO THE EXCLUSIVE RIGHT TO USE "SUMMIT", APART FROM THE MARK AS SHOWN.

FOR ARRANGING AND CONDUCTING TRADE SHOWS IN THE FIELD OF COMPUTER GAMES AND VIDEO GAMES DESIGN, DEVELOPMENT, TECHNOLOGY, PROGRAMMING, GRAPHICS, ANIMATION, AUDIO, THEORY, MARKETING, AND SALES (U.S. CLS. 100, 101 AND 102).

FIRST USE 9-30-2001; IN COMMERCE 9-30-2001.

HOWARD B. LEVINE, EXAMINING ATTORNEY

SN 78-678,654. ARMSTRONG TEASDALE LLP, ST. LOUIS, MO. FILED 7-26-2005.

THE PREVENE GROUP

THE MARK CONSISTS OF STANDARD CHARACTERS WITHOUT CLAIM TO ANY PARTICULAR FONT, STYLE, SIZE, OR COLOR.

NO CLAIM IS MADE TO THE EXCLUSIVE RIGHT TO USE "GROUP", APART FROM THE MARK AS SHOWN.

FOR BUSINESS CONSULTATION SERVICES IN THE FIELD OF CORPORATE COMPLIANCE AND ETHICS REGARDING SECURITIES AND BUSINESS LAWS AND REGULATIONS (U.S. CLS. 100, 101 AND 102).

RONALD AIKENS, EXAMINING ATTORNEY

CLASS 35—(Continued).

SN 78-682,995. KANSAS COALITION FOR LIFESAVING CURES INC., OVERLAND PARK, KS. FILED 8-1-2005.

KCLC

THE MARK CONSISTS OF STANDARD CHARACTERS WITHOUT CLAIM TO ANY PARTICULAR FONT, STYLE, SIZE, OR COLOR.

FOR PROMOTING PUBLIC AWARENESS OF THE NEED FOR AND AVAILABILITY OF SCIENTIFIC RESEARCH, TREATMENT, AND EDUCATION IN THE FIELD OF STEM CELL RESEARCH AND PROVIDING INFORMATION IN CONNECTION THEREWITH; PUBLIC AWARENESS SERVICES, NAMELY PROMOTING THE NEED FOR SCIENTIFIC RESEARCH, TREATMENT AND EDUCATION IN THE FIELD OF STEM CELLS (U.S. CLS. 100, 101 AND 102).

ELLEN PERKINS, EXAMINING ATTORNEY

SN 78-685,336. DOMTAR INC., MONTREAL, CANADA, FILED 8-4-2005.



Domtar distribution group

OWNER OF U.S. REG. NOS. 877,808, 2,444,314 AND OTHERS.

NO CLAIM IS MADE TO THE EXCLUSIVE RIGHT TO USE "DISTRIBUTION GROUP", APART FROM THE MARK AS SHOWN.

THE STIPPLING IS FOR SHADING PURPOSES ONLY AND IS NOT INTENDED TO INDICATE COLOR.

FOR DISTRIBUTORSHIPS IN THE FIELD OF PAPER PRODUCTS; BUSINESS MARKETING SERVICES IN THE FIELD OF PAPER PRODUCTS (U.S. CLS. 100, 101 AND 102).

FIRST USE 11-0-2004; IN COMMERCE 11-0-2004.

BARBARA A. GOLD, EXAMINING ATTORNEY

SN 78-685,775. FIREFIGHTERS INSTITUTE FOR RACIAL EQUALITY, INC. (F.I.R.E.), ST. LOUIS, MO. FILED 8-4-2005.

F.I.R.E. FIREFIGHTERS INSTITUTE FOR RACIAL EQUALITY

THE MARK CONSISTS OF STANDARD CHARACTERS WITHOUT CLAIM TO ANY PARTICULAR FONT, STYLE, SIZE, OR COLOR.

SEC. 2(F).

FOR ASSOCIATION SERVICES TO PROMOTE FAIR AND EQUAL PARTICIPATION IN THE AREAS OF HIRING AND PROMOTION AND EQUAL TREATMENT IN THE FIRE DEPARTMENT (U.S. CLS. 100, 101 AND 102).

FIRST USE 0-0-1968; IN COMMERCE 0-0-1968.

INGRID C. EULIN, EXAMINING ATTORNEY

CLASS 35—(Continued).

SN 78-686,266. PROPAYROLL, INC., DELRAY BEACH, FL. FILED 8-5-2005.

PROPAYROLL

THE MARK CONSISTS OF STANDARD CHARACTERS WITHOUT CLAIM TO ANY PARTICULAR FONT, STYLE, SIZE, OR COLOR.

FOR PAYROLL PROCESSING IN THE NATURE OF ADMINISTRATION OF BUSINESS PAYROLL FOR OTHERS, TAX FILING AND TAX REPORTING, NAMELY, TAX DECLARATION PROCEDURE SERVICES (U.S. CLS. 100, 101 AND 102).

FIRST USE 9-30-2003; IN COMMERCE 9-30-2003.

JULIE GUTTADAURO, EXAMINING ATTORNEY

SN 78-686,996. SAVANT SOLUTIONS CO., TAHOE VISTA, CA. FILED 8-5-2005.

SAVANT SOLUTIONS

THE MARK CONSISTS OF STANDARD CHARACTERS WITHOUT CLAIM TO ANY PARTICULAR FONT, STYLE, SIZE, OR COLOR.

NO CLAIM IS MADE TO THE EXCLUSIVE RIGHT TO USE "SOLUTIONS", APART FROM THE MARK AS SHOWN.

FOR BUSINESS CONSULTING AND INFORMATION SERVICES (U.S. CLS. 100, 101 AND 102).

FIRST USE 9-15-1989; IN COMMERCE 9-15-1989.

STEVEN PEREZ, EXAMINING ATTORNEY

CLASS 35—(Continued).

SN 78-688,815. CONSOLIDATED SERVICES GROUP, INC., LANSDALE, PA. FILED 8-9-2005.



NO CLAIM IS MADE TO THE EXCLUSIVE RIGHT TO USE "CONSOLIDATED SERVICES GROUP", APART FROM THE MARK AS SHOWN.

FOR HEALTH CARE COST CONTAINMENT; BUSINESS AUDITING, NAMELY, HEALTH CARE PROVIDER BILL AUDITING; HEALTH CARE COST AND UTILIZATION REVIEW; INSURANCE CLAIMS AUDITING; COST MANAGEMENT FOR THE HEALTH CARE BENEFIT PLANS OF OTHERS; AND CONSULTING SERVICES IN THE FIELDS OF HEALTH CARE COST CONTAINMENT, BUSINESS AUDITING, NAMELY, HEALTH CARE PROVIDER BILL AUDITING, HEALTH CARE COST AND UTILIZATION REVIEW, INSURANCE CLAIMS AUDITING AND COST MANAGEMENT FOR THE HEALTH CARE BENEFIT PLANS OF OTHERS (U.S. CLS. 100, 101 AND 102).

FIRST USE 7-31-1991; IN COMMERCE 7-31-1991.
DAVID COLLIER, EXAMINING ATTORNEY

CLASS 35—(Continued).

SN 78-689,432. BIOCOMPARE, INC., SOUTH SAN FRANCISCO, CA. FILED 8-10-2005.

COMPARENETWORKS

THE MARK CONSISTS OF STANDARD CHARACTERS WITHOUT CLAIM TO ANY PARTICULAR FONT, STYLE, SIZE, OR COLOR.

FOR PROVIDING PRODUCT INFORMATION VIA THE INTERNET INCLUDING PRODUCT DESCRIPTIONS, SPECIFICATIONS, USE, DEMONSTRATION, EDUCATION AND OTHER PRODUCT INFORMATION IN VARIOUS MEDIA FORMS INCLUDING TEXT, AUDIO, PICTORIAL, GRAPHICS AND VIDEO FORMATS; AND ADVERTISING SERVICES INCLUDING CONDUCTING MARKET RESEARCH SURVEYS AND LEAD GENERATION, IN THE FIELDS OF LIFE SCIENCES AND HEALTHCARE INDUSTRIES (U.S. CLS. 100, 101 AND 102).

FIRST USE 3-1-2004; IN COMMERCE 3-1-2004.
RENEE MCCRAY, EXAMINING ATTORNEY

SN 78-689,761. PRIDE HOSPITALITY, LLC, GERMANTONW, TN. FILED 8-10-2005.



NO CLAIM IS MADE TO THE EXCLUSIVE RIGHT TO USE "HOSPITALITY", APART FROM THE MARK AS SHOWN.

THE COLOR(S) RED, BLUE, GREY, BLACK IS/ARE CLAIMED AS A FEATURE OF THE MARK.

THE MARK CONSISTS OF PRIDE HOSPITALITY IN BLUE, PRIDE IN SHADOW GREY, CIRCLE AS LOGO IN RED WITH BLACK SHADOW.

FOR HOTEL MANAGEMENT AND OPERATION OF HOTELS FOR OTHERS (U.S. CLS. 100, 101 AND 102).

FIRST USE 1-1-1998; IN COMMERCE 1-1-1998.
SCOTT SISUN, EXAMINING ATTORNEY

SN 78-689,305. VAST INDUSTRIAL SUPPLY, LLC, ROME, GA. FILED 8-10-2005.



THE MARK CONSISTS OF THE WORD VAST AND THREE STYLIZED HEX NUTS.

FOR DISTRIBUTORSHIP SERVICES IN THE FIELD OF INDUSTRIAL SUPPLIES (U.S. CLS. 100, 101 AND 102).

FIRST USE 6-30-2005; IN COMMERCE 6-30-2005.
BARBARA RUTLAND, EXAMINING ATTORNEY

CLASS 35—(Continued).

SN 78-692,395. RELIANT GLASS & DOOR SYSTEMS, LLC, SHEBOYGAN, WI. FILED 8-15-2005.



THE MARK CONSISTS OF LETTER "R" FORMED BY A METAL DOOR, A SHEET OF GLASS, AND A DOOR HANDLE.

FOR DISTRIBUTORSHIP IN THE FIELD OF COMMERCIAL GLASS AND DOOR SYSTEMS INCLUDING GLASS, HOLLOW METAL DOORS AND FRAMES, WOOD DOORS, HARDWARE, GLAZING, TOILET PARTITIONS, AND ACCESSORIES (U.S. CLS. 100, 101 AND 102).

FIRST USE 11-11-2004; IN COMMERCE 11-11-2004.
KRISTINA KLOIBER, EXAMINING ATTORNEY

SN 78-694,303. INTERBRAND GROUP, LONDON, UNITED KINGDOM, FILED 8-17-2005.

Lang-Gauge

THE MARK CONSISTS OF STANDARD CHARACTERS WITHOUT CLAIM TO ANY PARTICULAR FONT, STYLE, SIZE, OR COLOR.

PRIORITY CLAIMED UNDER SEC. 44(D) ON UNITED KINGDOM APPLICATION NO. 2392203, FILED 5-18-2005.

FOR BUSINESS AND MARKET RESEARCH; MARKET RESEARCH, NAMELY, NAME EVALUATION RESEARCH, TESTING AND EVALUATION OF BRAND NAMES IN ENGLISH AND FOREIGN LANGUAGES; BUSINESS ADVISORY, INFORMATION AND CONSULTING SERVICES OF IN THE AREA OF TESTING AND EVALUATING BRAND NAMES (U.S. CLS. 100, 101 AND 102).

FIRST USE 0-0-1999; IN COMMERCE 0-0-1999.
SAIMA MAKHDOOM, EXAMINING ATTORNEY

CLASS 35—(Continued).

SN 78-694,414. AMERICAN FINANCIAL SERVICES ASSOCIATION, WASHINGTON, DC. FILED 8-17-2005.



American Financial Services Association

NO CLAIM IS MADE TO THE EXCLUSIVE RIGHT TO USE "FINANCIAL SERVICES ASSOCIATION", APART FROM THE MARK AS SHOWN.

SEC. 2(F) AS TO "AMERICAN".
FOR ASSOCIATION SERVICES, NAMELY PROMOTING THE INTERESTS OF THE CONSUMER CREDIT INDUSTRY (U.S. CLS. 100, 101 AND 102).

FIRST USE 1-1-1999; IN COMMERCE 1-1-1999.
TIMOTHY FINNEGAN, EXAMINING ATTORNEY

SN 78-695,202. ECONOMY HARDWARE, INC., CAMBRIDGE, MA. FILED 8-18-2005.

CITY KITCHENS

THE MARK CONSISTS OF STANDARD CHARACTERS WITHOUT CLAIM TO ANY PARTICULAR FONT, STYLE, SIZE, OR COLOR.

OWNER OF U.S. REG. NO. 2,271,167.

NO CLAIM IS MADE TO THE EXCLUSIVE RIGHT TO USE "KITCHENS", APART FROM THE MARK AS SHOWN.
FOR RETAIL STORE SERVICES FEATURING KITCHEN CABINETS, KITCHEN APPLIANCES, AND COUNTERTOPS (U.S. CLS. 100, 101 AND 102).

BRENDAN MCCAULEY, EXAMINING ATTORNEY

SN 78-695,880. TELESERVICES, INC., LA JOLLA, CA. FILED 8-18-2005.

EVERYTHING DSL

THE MARK CONSISTS OF STANDARD CHARACTERS WITHOUT CLAIM TO ANY PARTICULAR FONT, STYLE, SIZE, OR COLOR.

NO CLAIM IS MADE TO THE EXCLUSIVE RIGHT TO USE "DSL", APART FROM THE MARK AS SHOWN.

FOR COMPARATIVE MARKETING AND ADVERTISING SERVICES FOR PROVIDERS OF RESIDENTIAL AND BUSINESS TELECOMMUNICATIONS SERVICES, NAMELY, FOR PROVIDERS OF BROADBAND CABLE, DSL, FIBER-OPTIC AND SATELLITE INTERNET ACCESS SERVICES, CABLE AND SATELLITE TELEVISION, VOICE OVER IP, AND LONG-DISTANCE TELEPHONE SERVICES; OPERATION OF TELEPHONE CALL CENTERS FOR OTHERS IN THE FIELD OF HIGH SPEED ACCESS TO GLOBAL COMPUTER NETWORKS (U.S. CLS. 100, 101 AND 102).

FIRST USE 2-28-1999; IN COMMERCE 2-28-1999.
PATRICIA EVANKO, EXAMINING ATTORNEY

CLASS 35—(Continued).

SN 78-696,263. ANTHONY, MIKE CECIL, PORTLAND, OR. FILED 8-19-2005.

maisonJoi

THE ENGLISH TRANSLATION OF THE WORD MAISON-JOI IN THE MARK IS JOY OF HOME.

FOR RETAIL DEPARTMENT STORE SERVICES (U.S. CLS. 100, 101 AND 102).

TIMOTHY FINNEGAN, EXAMINING ATTORNEY

CLASS 35—(Continued).

SN 78-698,188. MUNCE, DON, LEE'S SUMMIT, MO. FILED 8-23-2005.

MY COLLEGE OPTIONS

THE MARK CONSISTS OF STANDARD CHARACTERS WITHOUT CLAIM TO ANY PARTICULAR FONT, STYLE, SIZE, OR COLOR.

NO CLAIM IS MADE TO THE EXCLUSIVE RIGHT TO USE "COLLEGE OPTIONS", APART FROM THE MARK AS SHOWN.

FOR ADMINISTERING SURVEYS TO AND COLLECTING INFORMATION FROM SECONDARY SCHOOL STUDENTS, AND PROVIDING INFORMATION TO POST-SECONDARY INSTITUTIONS, RECRUITERS AND YOUTH SERVICE PROVIDERS BASED ON DATA COLLECTED FROM STUDENTS, AND PROVIDING INFORMATION TO STUDENTS ABOUT EMPLOYERS AND YOUTH SERVICE OPPORTUNITIES BASED ON DATA COLLECTED FROM STUDENTS ALL FOR THE PURPOSE OF ASSISTING STUDENTS IN ASSESSING EMPLOYMENT OPPORTUNITIES (U.S. CLS. 100, 101 AND 102).

FIRST USE 9-30-2001; IN COMMERCE 9-30-2001.
DARRYL SPRUILL, EXAMINING ATTORNEY

SN 78-697,412. TELESERVICES, INC., LA JOLLA, CA. FILED 8-22-2005.

EVERYTHING DS3

THE MARK CONSISTS OF STANDARD CHARACTERS WITHOUT CLAIM TO ANY PARTICULAR FONT, STYLE, SIZE, OR COLOR.

NO CLAIM IS MADE TO THE EXCLUSIVE RIGHT TO USE "DS3", APART FROM THE MARK AS SHOWN.

FOR COMPARATIVE MARKETING AND ADVERTISING SERVICES FOR PROVIDERS OF RESIDENTIAL AND BUSINESS TELECOMMUNICATIONS SERVICES, NAMELY, FOR PROVIDERS OF BROADBAND CABLE, DSL, FIBER-OPTIC AND SATELLITE INTERNET ACCESS SERVICES, CABLE AND SATELLITE TELEVISION, VOICE OVER IP, AND LONG-DISTANCE TELEPHONE SERVICES; OPERATION OF TELEPHONE CALL CENTERS FOR OTHERS IN THE FIELD OF HIGH SPEED ACCESS TO GLOBAL COMPUTER NETWORKS (U.S. CLS. 100, 101 AND 102).

FIRST USE 2-28-1999; IN COMMERCE 2-28-1999.
PATRICIA EVANKO, EXAMINING ATTORNEY

SN 78-698,437. THE HOME SERVICE STORE, INC., RUTLAND, VT. FILED 8-23-2005.

HSS

THE MARK CONSISTS OF STANDARD CHARACTERS WITHOUT CLAIM TO ANY PARTICULAR FONT, STYLE, SIZE, OR COLOR.

OWNER OF U.S. REG. NO. 3,021,242.

FOR PROMOTING THE SALE OF PRODUCTS AND SERVICES, PROVIDED BY OTHERS, FOR THE IMPROVEMENT OF HOMES, BUSINESSES AND INSTITUTIONS; PROMOTING IN STORES OF OTHERS, THE PRODUCTS AND SERVICES OF OTHERS, FOR THE IMPROVEMENT OF HOMES, BUSINESSES AND INSTITUTIONS; REFERRAL OF HOMEOWNERS, BUSINESSES AND INSTITUTIONS TO CONTRACTORS, NAMELY, MATCHING CONTRACTORS WITH PARTIES THAT DESIRE TO ACQUIRE GOODS AND SERVICES FOR THE IMPROVEMENT OF HOMES, BUSINESSES AND INSTITUTIONS; REFERRAL OF HOMEOWNERS, BUSINESSES AND INSTITUTIONS TO CONTRACTORS, NAMELY, MATCHING CONTRACTORS THAT PERFORM MAINTENANCE, IMPROVEMENT AND/OR REPAIR SERVICES IN HOMES, BUSINESSES AND INSTITUTIONS WITH PARTIES THAT DESIRE SUCH MAINTENANCE, IMPROVEMENT AND/OR REPAIR SERVICES; OFFERING A REFERRAL SERVICE FOR CONTRACTORS, NAMELY INTRODUCING CONTRACTORS TO HOMEOWNERS, BUSINESSES AND INSTITUTIONS DESIRING MAINTENANCE, IMPROVEMENT OR REPAIR SERVICES (U.S. CLS. 100, 101 AND 102).

FIRST USE 8-16-2005; IN COMMERCE 8-16-2005.
MEGAN WHITNEY, EXAMINING ATTORNEY

CLASS 35—(Continued).

SN 78-698,473. MAJORIA & SANDOZ, INC., MARRERO, LA. FILED 8-23-2005.



NO CLAIM IS MADE TO THE EXCLUSIVE RIGHT TO USE "DRUGS", APART FROM THE MARK AS SHOWN.

THE MARK CONSISTS OF THE WORDS "MAJORIA DRUGS", WITH THREE ICONS STACKED ABOVE THE WORDS "MAJORIA DRUGS," SAID ICONS EACH IN THE SHAPE OF A SQUARE-DIAMOND AND ALTOGETHER FORMING A PYRAMID-LIKE SHAPE STACKED ABOVE THE WORDS "MAJORIA DRUGS"; EACH OF THE THREE ICONS INCORPORATES DIFFERENT IMAGES, NAMELY, A SUN IMAGE IN THE BOTTOM-LEFT ICON, A MORTAR AND PESTLE IMAGE IN THE TOP ICON, AND A LEAF IMAGE IN THE BOTTOM-RIGHT ICON.

FOR RETAIL DRUG STORE SERVICES, RETAIL STORE SERVICES FEATURING GENERAL MERCHANDISE (U.S. CLS. 100, 101 AND 102).

FIRST USE 7-1-2005; IN COMMERCE 7-1-2005.

CHRISTOPHER OTT, EXAMINING ATTORNEY

SN 78-698,558. PINYA.COM INC., NEEDHAM, MA. FILED 8-23-2005.

PINYA

THE MARK CONSISTS OF STANDARD CHARACTERS WITHOUT CLAIM TO ANY PARTICULAR FONT, STYLE, SIZE, OR COLOR.

THE FOREIGN WORDING IN THE MARK TRANSLATES INTO ENGLISH AS "PINEAPPLE".

FOR DISSEMINATING ADVERTISING MATERIAL FOR OTHERS VIA ELECTRONIC COMMUNICATIONS NETWORKS AND PROMOTING THE GOODS AND SERVICES OF OTHERS BY PREPARING AND PLACING BANNER ADVERTISEMENTS AND THROUGH THE ELECTRONIC PROMOTION OF AND AUCTIONING OF THE GOODS AND SERVICES OF OTHERS OVER THE INTERNET; ONLINE RETAIL STORE FEATURING A WIDE VARIETY OF CONSUMER GOODS; AUCTION SERVICES OFFERED OVER THE INTERNET; PROVIDING INFORMATION REGARDING THE GOODS AND SERVICES OF OTHERS OVER THE INTERNET; PROVIDING ONLINE INFORMATION IN THE FIELDS OF EMPLOYMENT, PERSONNEL RECRUITMENT, CAREERS, PERSONAL ISSUES RELATED TO CAREERS AND WORK LIFE, JOB RESOURCES, JOB LISTINGS AND RESUMES; PROVIDING ONLINE INTERACTIVE EMPLOYMENT COUNSELING AND PERSONNEL RECRUITMENT SERVICES; PROVIDING ONLINE EMPLOYMENT PLACEMENT SERVICES, NAMELY, RESUME MATCHING SERVICES OVER THE INTERNET; ONLINE COMMERCIAL INFORMATION DIRECTORY SERVICES; PROVIDING DIRECTORY INFORMATION FEATURING NAMES AND BUSINESSES, INDIVIDUAL AND BUSINESS ADDRESSES AND TELEPHONE NUMBERS AND PROVIDING ELECTRONIC MAIL ADDRESS DIRECTORIES VIA THE INTERNET (U.S. CLS. 100, 101 AND 102).

MELISSA VALLILLO, EXAMINING ATTORNEY

CLASS 35—(Continued).

SN 78-699,463. INVISION, IMPLEMENT, INDUSTRIALIZE LLC, NEW YORK, NY. FILED 8-24-2005.

I-3, INVISION, IMPLEMENT, INDUSTRIALIZE

THE MARK CONSISTS OF STANDARD CHARACTERS WITHOUT CLAIM TO ANY PARTICULAR FONT, STYLE, SIZE, OR COLOR.

FOR ADVERTISING, MARKETING AND PROMOTION SERVICES; PROMOTION USING AUDIOVISUAL MEDIA; PRODUCT MERCHANDISING; ARRANGING AND CONDUCTING MARKETING PROMOTIONAL EVENTS FOR OTHERS; PREPARING PROMOTIONAL AND MERCHANDISING MATERIAL FOR OTHERS; PREPARATION OF CUSTOM ADVERTISEMENTS AND CUSTOM PROMOTIONAL PRODUCTS FOR OTHERS; MERCHANDISING SERVICES FOR INDUCING THE PURCHASING PUBLIC TO BUY THE GOODS OF OTHERS THROUGH A PROMOTIONAL GIFT REDEMPTION PROGRAM; BUSINESS MARKETING AND DIRECT MAIL CONSULTING SERVICES; PROVIDING BUSINESS MARKETING INFORMATION; BUSINESS MERCHANDISING DISPLAY SERVICES; DEVELOPING PROMOTIONAL CAMPAIGNS FOR BUSINESS; COOPERATIVE ADVERTISING AND MARKETING; OPERATING ON-LINE MARKETPLACES FOR SELLERS OF GOODS AND/OR SERVICES; ADVERTISING AGENCIES, NAMELY, PROMOTING THE SERVICES OF THE MUSIC, BEAUTY, FASHION, HOME DÉCOR AND ENTERTAINMENT INDUSTRIES THROUGH THE DISTRIBUTION OF PRINTED AND AUDIO PROMOTIONAL MATERIALS AND BY RENDERING SALES PROMOTION ADVICE; ADVERTISING SERVICES, NAMELY, CREATING CORPORATE LOGOS FOR OTHERS; ADVERTISING SERVICES, NAMELY, CREATING CORPORATE AND BRAND IDENTITY FOR OTHERS; DIRECT MAIL ADVERTISING; DIRECT MARKETING ADVERTISING FOR OTHERS; PROMOTING THE GOODS AND SERVICES OF OTHERS THROUGH THE DISTRIBUTION OF DISCOUNT CARDS; PROMOTING THE SALE OF GOODS AND SERVICES OF OTHERS THROUGH THE DISTRIBUTION OF PRINTED MATERIAL AND PROMOTIONAL CONTESTS; DISSEMINATION OF ADVERTISING FOR OTHERS VIA THE INTERNET; DISSEMINATION OF ADVERTISING MATTER; PREPARING AUDIO-VISUAL PRESENTATIONS FOR USE IN ADVERTISING; PREPARING AND PLACING ADVERTISEMENTS FOR OTHERS; HANDBILL DISTRIBUTION; SAMPLE DISTRIBUTION; ARRANGING AND CONDUCTING TRADE SHOWS IN THE FIELDS OF MUSIC, GENERAL ENTERTAINMENT, TELEVISION, FILM, BEAUTY, FASHION, HOME DÉCOR, THE ARTS, CULTURE, POLITICS AND EDUCATION; CONDUCTING AN ON-LINE TRADE SHOW EXHIBITION IN THE FIELDS OF MUSIC, GENERAL ENTERTAINMENT, TELEVISION, FILM, BEAUTY, FASHION, HOME DÉCOR, THE ARTS, CULTURE, POLITICS AND EDUCATION; PLANNING AND CONDUCTING TRADE FAIRS, EXHIBITIONS AND PRESENTATIONS FOR ECONOMIC OR ADVERTISING PURPOSES; PRODUCTION AND DISTRIBUTION OF TELEVISION AND RADIO COMMERCIALS; ADVERTISING SERVICES, NAMELY, PROMOTING THE GOODS AND SERVICES OF OTHERS THROUGH ISSUANCE OF PRODUCT AND/OR SERVICE ENDORSEMENTS, AND THROUGH APPEARANCES FOR PRODUCT AND/OR SERVICE ADVERTISING; ELECTRONIC BILLBOARD ADVERTISING; PROVIDING A WEB SITE WHICH FEATURES ADVERTISEMENTS FOR THE GOODS AND SERVICES OF OTHERS ON A GLOBAL COMPUTER NETWORK; PROVIDING SPACE AT A WEB SITE FOR THE ADVERTISEMENT OF THE GOODS AND SERVICES OF OTHERS; PROVIDING A WEB SITE AT WHICH USERS CAN OFFER GOODS FOR SALE AND BUY GOODS OFFERED BY OTHERS; PROMOTING THE GOODS AND SERVICES OF OTHERS BY PROVIDING HYPERTEXT LINKS TO THE WEB SITES OF OTHERS; PROMOTING THE GOODS AND SERVICES OF OTHERS BY PROVIDING A WEB SITE AT WHICH USERS CAN LINK

CLASS 35—(Continued).

TO MUSIC, BEAUTY, FASHION, HOME DÉCOR AND ENTERTAINMENT SUBJECT MATTERS; PROVIDING ON-LINE DIRECTORY INFORMATION SERVICES ALSO FEATURING HYPERLINKS TO OTHER WEB SITES; PROVIDING INFORMATION ABOUT THE GOODS AND SERVICES OF OTHERS VIA THE GLOBAL COMPUTER NETWORK; PROMOTING THE GOODS AND SERVICES OF OTHERS BY MEANS OF OPERATING AN ON-LINE SHOPPING MALL WITH LINKS TO THE RETAIL WEB SITES OF OTHERS; PROMOTING THE GOODS AND SERVICES OF OTHERS THROUGH ON-LINE ORDERING AND CATALOGING OF THOSE GOODS AND SERVICES; PROVIDING AN ON-LINE SHOWROOM FOR THE GOODS OF OTHERS IN THE FIELDS OF MUSIC, BEAUTY, FASHION, HOME DÉCOR AND ENTERTAINMENT; PROMOTING THE GOODS AND SERVICES OF OTHERS BY PREPARING AND PLACING ADVERTISEMENTS IN AN ELECTRONIC MAGAZINE ACCESSED THROUGH A GLOBAL COMPUTER NETWORK; PROMOTING THE CONCERTS OF OTHERS; PROMOTING THE GOODS AND SERVICES OF OTHERS BY ARRANGING FOR SPONSORS TO AFFILIATE THEIR GOODS AND SERVICES WITH MUSIC, BEAUTY, FASHION, CULTURAL AND ENTERTAINMENT EVENTS; PUBLIC RELATIONS; PUBLICITY AGENTS; MANAGEMENT OF PERFORMING ARTISTS AND PROFESSIONAL ATHLETES; THEATRICAL MANAGEMENT; TALENT AGENCIES; RETAIL STORES, ON-LINE ORDERING SERVICES, AND ELECTRONIC RETAILING SERVICES VIA COMPUTER, ALL FEATURING PRE-RECORDED CD'S, VIDEO TAPES, LASER DISKS, DVD'S, SOUND RECORDINGS, AUDIO CASSETTES AND TAPES, AUDIO DISCS, PHONOGRAPH RECORDS, CD-ROMS, VIDEO CASSETTES, VIDEO DISCS, DATS, AND MP3S FEATURING MUSIC, MERCHANDISING PRODUCTS IN THE NATURE OF MAGNETS, PAPERWEIGHTS, COMPUTER PRODUCTS, GAMES AND RELATED ACCESSORIES, NOVELTY ITEMS, PINS AND BUTTONS, EMBLEMS, COASTERS, PRINTED MATTER IN THE NATURE OF POSTERS, CALENDARS, STICKERS AND RELATED ITEMS, STATIONERY, PUBLICATIONS, TOUR BOOKS AND EVENT PROGRAMS, MUGS, BAGS AND RELATED ACCESSORIES, CLOTHING AND RELATED ACCESSORIES (U.S. CLS. 100, 101 AND 102).

CHARLES L. JENKINS, EXAMINING ATTORNEY

SN 78-701,331. FURNITURE DESIGNS BY ASPEN (MAURITIUS) LIMITED, PHOENIX, AZ. FILED 8-26-2005.

ASPENHOME

THE MARK CONSISTS OF STANDARD CHARACTERS WITHOUT CLAIM TO ANY PARTICULAR FONT, STYLE, SIZE, OR COLOR.

FOR RETAIL AND WHOLESALE STORE SERVICES IN THE FIELD OF FURNITURE (U.S. CLS. 100, 101 AND 102).

RENEE MCCRAY, EXAMINING ATTORNEY

CLASS 35—(Continued).

SN 78-702,415. BAIN & COMPANY INC., BOSTON, MA. FILED 8-29-2005.

PLOT

THE MARK CONSISTS OF STANDARD CHARACTERS WITHOUT CLAIM TO ANY PARTICULAR FONT, STYLE, SIZE, OR COLOR.

FOR BUSINESS CONSULTING SERVICES, NAMELY, CHANGE MANAGEMENT (U.S. CLS. 100, 101 AND 102).
KATHERINE E. HALMEN, EXAMINING ATTORNEY

SN 78-703,565. K BARTLETT LIFETIME SOLUTIONS, INC., SACRAMENTO, CA. FILED 8-30-2005.

**LIFETIME SOLUTIONS PLACING
PEOPLE FIRST**

THE MARK CONSISTS OF STANDARD CHARACTERS WITHOUT CLAIM TO ANY PARTICULAR FONT, STYLE, SIZE, OR COLOR.

FOR REFERRAL SERVICES FOR SOURCES OF ELDER CARE AND ASSISTED LIVING FACILITIES; PLACEMENT SERVICES, NAMELY, PLACING PEOPLE IN NEED OF CARE IN ASSISTED LIVING FACILITIES (U.S. CLS. 100, 101 AND 102).

AMY ALFIERI, EXAMINING ATTORNEY

SN 78-703,571. ROOM 40 LLC, CHICAGO, IL. FILED 8-30-2005.

ROOM 40

THE MARK CONSISTS OF STANDARD CHARACTERS WITHOUT CLAIM TO ANY PARTICULAR FONT, STYLE, SIZE, OR COLOR.

FOR ADVERTISING AND MARKETING, MARKET RESEARCH, MARKET ANALYSIS, COMPUTERIZED DATABASE COMPILATION AND MANAGEMENT, AND TRACKING OF EMPLOYEE AND MANAGER PERFORMANCE FOR OTHERS (U.S. CLS. 100, 101 AND 102).

SUSAN STIGLITZ, EXAMINING ATTORNEY

CLASS 35—(Continued).

SN 78-704,128. LIBERAL ARTS CAREER NETWORK, HOLLAND, MI. FILED 8-31-2005.

Spotlight on Careers

THE MARK CONSISTS OF STANDARD CHARACTERS WITHOUT CLAIM TO ANY PARTICULAR FONT, STYLE, SIZE, OR COLOR.

NO CLAIM IS MADE TO THE EXCLUSIVE RIGHT TO USE "CAREERS", APART FROM THE MARK AS SHOWN.

FOR PROVIDING CAREER INFORMATION FOR STUDENTS OF PARTICIPATING LIBERAL ARTS COLLEGES VIA A GLOBAL COMPUTER NETWORK; PROVIDING ON-LINE INFORMATION AND NEWS IN THE FIELD OF EMPLOYMENT AND CAREER PLACEMENT SERVICES FOR STUDENTS OF PARTICIPATING LIBERAL ARTS COLLEGES; PROVIDING ON-LINE ALUMNI PROFILES SPECIFICALLY RELATING TO EMPLOYMENT AND CAREER PLACEMENT FOR STUDENTS OF PARTICIPATING LIBERAL ARTS COLLEGES; AND PROVIDING ON-LINE DIRECTORY SERVICES ALSO FEATURING HYPERLINKS TO OTHER WEB SITES RELATING TO JOB LISTINGS AND JOB PROFILES FOR STUDENTS OF PARTICIPATING LIBERAL ARTS COLLEGES (U.S. CLS. 100, 101 AND 102).

FIRST USE 6-27-2003; IN COMMERCE 8-1-2003.
KATHERINE STOIDES, EXAMINING ATTORNEY

SN 78-706,719. OHLINGER, THOMAS P, OMAHA, NE. FILED 9-4-2005.

Oh My What A Buy

THE MARK CONSISTS OF STANDARD CHARACTERS WITHOUT CLAIM TO ANY PARTICULAR FONT, STYLE, SIZE, OR COLOR.

FOR ON-LINE RETAIL STORE SERVICES FEATURING ELECTRONICS, COMPUTERS, SPORTING GOODS, TOYS, VIDEO GAMES, ENTERTAINMENT AND SPORTS EVENTS TICKETS, JEWELRY, CLOTHING, BOOKS, VEHICLES, HOME AND GARDEN PRODUCTS, DVDS AND CDS, HEALTH AND BEAUTY SUPPLIES, OFFICE AND RETAIL EQUIPMENT AND MACHINES, ARTS AND CRAFTS, MUSICAL INSTRUMENTS, AND COLLECTIBLES (U.S. CLS. 100, 101 AND 102).

FIRST USE 8-19-2005; IN COMMERCE 8-24-2005.
ELIZABETH J. WINTER, EXAMINING ATTORNEY

CLASS 35—(Continued).

SN 78-706,967. DAVID TK HOANG, PLAINFIELD, IL. FILED 9-6-2005.

KITCHENCOMPLEMENTS

THE COLORS YELLOW AND RED ARE CLAIMED AS A FEATURE OF THE MARK.

THE YELLOW COLOR APPEARS IN THE TERM "KITCHEN". THE RED COLOR APPEARS IN THE TERM "COMPLEMENTS".

FOR COMPUTERIZED ON-LINE ORDERING SERVICES IN THE FIELD OF KITCHEN FURNISHINGS AND ACCESSORIES (U.S. CLS. 100, 101 AND 102).

ALEXANDER L. POWERS, EXAMINING ATTORNEY

SN 78-711,950. IT'S YOUR MOVE, INC., NATICK, MA. FILED 9-13-2005.

YOUR MOVING PALETTE

THE MARK CONSISTS OF STANDARD CHARACTERS WITHOUT CLAIM TO ANY PARTICULAR FONT, STYLE, SIZE, OR COLOR.

NO CLAIM IS MADE TO THE EXCLUSIVE RIGHT TO USE "MOVING", APART FROM THE MARK AS SHOWN.

FOR MOVING AND RELOCATION SERVICES, NAMELY, ADVISING, PLANNING, ORGANIZING, MANAGING, SUPERVISING, AND COORDINATING RESIDENTIAL MOVES; PROVIDING CONSULTATION SERVICES IN THE AREAS OF ORGANIZATION, PACKING AND UNPACKING, SORTING FURNITURE AND PERSONAL BELONGINGS, HOME CLEANING AND SET-UP; REFERRALS IN THE FIELD OF THE SERVICES OF OTHERS IN THE AREAS OF HOME CLEANING, HAULING, APPRAISALS, AUCTIONS, ESTATE AND YARD SALES, DONATIONS, STORAGE, AND INTERIOR DECORATING AND DESIGN (U.S. CLS. 100, 101 AND 102).

FIRST USE 9-1-2004; IN COMMERCE 9-1-2004.
KIMBERLY PERRY, EXAMINING ATTORNEY

SN 78-713,813. BRYN MAWR MANAGEMENT SERVICES, LLC, CHICAGO, IL. FILED 9-15-2005.

CRUSADER INTERNATIONAL GROUP

THE MARK CONSISTS OF STANDARD CHARACTERS WITHOUT CLAIM TO ANY PARTICULAR FONT, STYLE, SIZE, OR COLOR.

NO CLAIM IS MADE TO THE EXCLUSIVE RIGHT TO USE "INTERNATIONAL GROUP", APART FROM THE MARK AS SHOWN.

FOR PROMOTION OF FINANCIAL AND INSURANCE SERVICES, ON BEHALF OF THIRD PARTIES (U.S. CLS. 100, 101 AND 102).

FIRST USE 9-18-2003; IN COMMERCE 9-18-2003.
LEIGH CAROLINE CASE, EXAMINING ATTORNEY

CLASS 35—(Continued).

SN 78-714,210. ONE SCOTTSDALE HOLDINGS LLC, SCOTTSDALE, AZ. FILED 9-15-2005.

ONE SCOTTSDALE

THE MARK CONSISTS OF STANDARD CHARACTERS WITHOUT CLAIM TO ANY PARTICULAR FONT, STYLE, SIZE, OR COLOR.

NO CLAIM IS MADE TO THE EXCLUSIVE RIGHT TO USE "SCOTTSDALE", APART FROM THE MARK AS SHOWN.

FOR ASSOCIATION SERVICES, NAMELY, PROMOTING THE INTERESTS OF HOMEOWNERS THAT RESIDE IN THE COMMUNITY (U.S. CLS. 100, 101 AND 102).

CAROLYN CATALDO, EXAMINING ATTORNEY

CLASS 35—(Continued).

SN 78-716,314. RIGHT MEDIA INC., NEW YORK, NY. FILED 9-20-2005.

Yield Manager

THE MARK CONSISTS OF STANDARD CHARACTERS WITHOUT CLAIM TO ANY PARTICULAR FONT, STYLE, SIZE, OR COLOR.

OWNER OF U.S. REG. NO. 2,983,347.

FOR ADVERTISING SERVICES, NAMELY, PREPARING, PLACING, AND PROVIDING A WEBSITE FOR CONTROLLING ONLINE ADVERTISING CAMPAIGNS FOR OTHERS (U.S. CLS. 100, 101 AND 102).

GRETTA YAO, EXAMINING ATTORNEY

SN 78-716,869. OMX, INC., ITASCA, IL. FILED 9-20-2005.

**OFFICEMAX HAVE IT ALL
PLEDGE**

THE MARK CONSISTS OF STANDARD CHARACTERS WITHOUT CLAIM TO ANY PARTICULAR FONT, STYLE, SIZE, OR COLOR.

OWNER OF U.S. REG. NOS. 2,367,604, 2,878,901 AND OTHERS.

NO CLAIM IS MADE TO THE EXCLUSIVE RIGHT TO USE "PLEDGE", APART FROM THE MARK AS SHOWN.

FOR RETAIL AND ONLINE RETAIL STORES FEATURING BLANK CDS AND DVDS, COMPUTERS, COMPUTER ACCESSORIES, OFFICE SUPPLIES AND PRODUCTS; RETAIL STORE SERVICES IN THE FIELDS OF OFFICE SUPPLIES AND EQUIPMENT, FURNITURE, PHOTOCOPYING, PRINTING, FAXING, TYPESETTING, AND THE LIKE (U.S. CLS. 100, 101 AND 102).

TIMOTHY FINNEGAN, EXAMINING ATTORNEY

SN 78-715,433. LOPEZ NEGRETE COMMUNICATIONS, INC., HOUSTON, TX. FILED 9-19-2005.



THE NAME(S), SHOWN IN THE MARK IDENTIFIES ALEX LOPEZ NEGRETE AND CATHY LOPEZ NEGRETE, WHOSE CONSENT(S) TO REGISTER IS SUBMITTED.

THE COLORS BLACK AND GOLD ARE CLAIMED AS A FEATURE OF THE MARK.

THE COLOR BLACK APPEARS IN THE WORDS LOPEZ NEGRETE AND THE COLOR GOLD APPEARS IN THE DESIGN FEATURE.

THE MARK CONSISTS OF THE TERMS LOPEZ NEGRETE AND A GOLD STYLIZED DESIGN MOTIF UNDERNEATH THE LITERAL PORTION.

FOR ADVERTISING, MARKETING, AND PUBLICITY SERVICES, NAMELY, PROMOTING GOODS, SERVICES, BRAND IDENTITY AND COMMERCIAL INFORMATION AND NEWS OF THIRD PARTIES THROUGH PRINT, AUDIO, VIDEO, DIGITAL AND ON-LINE MEDIUM; CREATING CORPORATE AND BRAND IDENTITY FOR OTHERS; ADVERTISING CONSULTANCY; PUBLIC RELATIONS; PROCUREMENT SERVICES, NAMELY PURCHASING MEDIA ACCESS FOR OTHERS; MANAGEMENT OF ADVERTISING ACCOUNTS; AND CONDUCTING BUSINESS AND MARKET RESEARCH AND SURVEYS (U.S. CLS. 100, 101 AND 102).

FIRST USE 11-30-1998; IN COMMERCE 11-30-1998.

MARGERY A. TIERNEY, EXAMINING ATTORNEY

SN 78-717,273. HEALTH & BEAUTY ASSOCIATION LLC, MANHASSET, NY. FILED 9-21-2005.

FROM FORMULA TO FINISH

THE MARK CONSISTS OF STANDARD CHARACTERS WITHOUT CLAIM TO ANY PARTICULAR FONT, STYLE, SIZE, OR COLOR.

FOR ARRANGING, PROMOTING AND CONDUCTING TRADE SHOWS, BUSINESS CONFERENCES AND EXPOSITIONS IN THE FIELDS OF COSMETICS, SKIN CARE, FRAGRANCES, TOILETRIES, AND RELATED TECHNOLOGIES, NAMELY, INGREDIENTS, EQUIPMENT, AND MANUFACTURING, RESEARCH, PACKAGING, AND MARKETING PROCESSES USED IN THE FIELDS OF COSMETICS, SKIN CARE, FRAGRANCES, AND TOILETRIES (U.S. CLS. 100, 101 AND 102).

FIRST USE 6-20-2000; IN COMMERCE 6-20-2000.

PAMELA HIRSCHMAN, EXAMINING ATTORNEY

CLASS 35—(Continued).

SN 78-721,013. PARAGON MANAGEMENT ASSOCIATES, INC., COLUMBUS, OH. FILED 9-27-2005.

Paragon Management Associates, Inc.

THE MARK CONSISTS OF STANDARD CHARACTERS WITHOUT CLAIM TO ANY PARTICULAR FONT, STYLE, SIZE, OR COLOR.

NO CLAIM IS MADE TO THE EXCLUSIVE RIGHT TO USE "MANAGEMENT ASSOCIATES, INC.", APART FROM THE MARK AS SHOWN.

FOR DENTAL-PRACTICE CONSULTING, MANAGEMENT, PLANNING AND SUPERVISION, NAMELY MONTHLY IN-OFFICE CONSULTATIONS TO EVALUATE THE DENTAL PRACTICE AND DISCUSS HOW TO IMPROVE THE PRACTICE; BUSINESS NETWORKING, NAMELY, ORGANIZING MONTHLY STUDY CLUBS, CONSISTING OF EIGHT TO TWELVE DENTISTS, TO ADDRESS DENTAL PRACTICE PROBLEMS AND SOLUTIONS; PRACTICE EVALUATIONS TO ADDRESS DENTAL-PRACTICE ASPECTS SUCH AS BREAK-EVEN POINTS, PROFIT-CENTER ANALYSIS, EMPLOYEE PERFORMANCE, AND PRACTICE EFFICIENCIES (U.S. CLS. 100, 101 AND 102).

FIRST USE 6-19-1996; IN COMMERCE 6-19-1996.
SANI KHOURI, EXAMINING ATTORNEY

SN 78-722,091. BODACLICK, S.L., MADRID, SPAIN, FILED 9-28-2005.



THE COLOR(S) BLUE AND RED IS/ARE CLAIMED AS A FEATURE OF THE MARK.

THE MARK CONSISTS OF THE COLOR BLUE APPEARING IN THE WORDING "BODACLICK" AND ".COM," AND THE COLOR RED APPEARING IN THE WORDING "USA" AND IN THE ASTERISK DESIGN.

FOR ADVERTISING AGENCY SERVICES, NAMELY, PROMOTING THE GOODS AND SERVICES OF THE WEDDING INDUSTRY FOR THIRD PARTIES THROUGH PRINT AND ON-LINE MEDIA, IN THE FIELDS OF LIMOUSINE SERVICES, MUSICAL BANDS, DISC JOCKEYS, CLASSICAL MUSIC ENSEMBLES, RESTAURANTS, BANQUET HALLS, HOTELS, CATERING, CATERERS, OFF-SITE CATERERS, WEDDING CAKE BAKERS, TRAVEL AGENCIES, TRAVEL PLANNING, CRUISE LISTINGS, BEACH WEDDINGS, BRIDAL CONSULTANTS, HONEYMOON PLANNERS, PARTY PLANNERS, PARTY EQUIPMENT RENTAL, WEDDING GOWNS, TUXEDOS, JEWELERS, HAIRDRESSERS, BEAUTY SALON SERVICES, MANICURE AND PEDICURE SERVICES, FLORISTS, WEDDING INVITATIONS, PHOTOGRAPHY, VIDEOGRAPHY; PROMOTING THE GOODS AND SERVICES OF OTHERS BY MEANS OF OPERATING AN ON-LINE SHOPPING MALL WITH LINKS TO THE RETAIL WEBSITES OF VENDORS THAT PROVIDE A WIDE RANGE OF WEDDING SUPPLIES, GOODS AND SERVICES (U.S. CLS. 100, 101 AND 102).

FIRST USE 12-12-2004; IN COMMERCE 12-12-2004.
WANDA KAY PRICE, EXAMINING ATTORNEY

CLASS 35—(Continued).

SN 78-723,973. HOLMES, BENNIE D., BIRMINGHAM, AL. FILED 9-30-2005.

MACMAN ENTERTAINMENT & PROMOTIONS DA DEEPSOUTH UNDERGROUND CONNECTION

THE MARK CONSISTS OF STANDARD CHARACTERS WITHOUT CLAIM TO ANY PARTICULAR FONT, STYLE, SIZE, OR COLOR.

NO CLAIM IS MADE TO THE EXCLUSIVE RIGHT TO USE "ENTERTAINMENT & PROMOTIONS", APART FROM THE MARK AS SHOWN.

FOR ADVERTISING, MARKETING AND PROMOTION SERVICES; PROMOTING SPORTS COMPETITIONS AND/OR EVENTS OF OTHERS; PROMOTING THE CONCERTS OF OTHERS; PROMOTING THE PARTIES AND SPECIAL EVENTS OF OTHERS (U.S. CLS. 100, 101 AND 102).

DOMINICK J. SALEMI, EXAMINING ATTORNEY

SN 78-724,153. PURPLE SQUIRREL SERVICES (PSS), FAIR OAKS, CA. FILED 9-30-2005.

Purple Squirrel Services, Inc.

THE MARK CONSISTS OF STANDARD CHARACTERS WITHOUT CLAIM TO ANY PARTICULAR FONT, STYLE, SIZE, OR COLOR.

NO CLAIM IS MADE TO THE EXCLUSIVE RIGHT TO USE "SERVICES, INC.", APART FROM THE MARK AS SHOWN.

FOR BUSINESS CONSULTING AND INFORMATION SERVICES; BUSINESS CONSULTING, MANAGEMENT, PLANNING AND SUPERVISION (U.S. CLS. 100, 101 AND 102).

FIRST USE 9-6-2005; IN COMMERCE 9-6-2005.
MARK T. MULLEN, EXAMINING ATTORNEY

SN 78-724,214. PURPLE SQUIRREL SERVICES (PSS), FAIR OAKS, CA. FILED 9-30-2005.



NO CLAIM IS MADE TO THE EXCLUSIVE RIGHT TO USE "SERVICES, INC.", APART FROM THE MARK AS SHOWN.

THE COLOR(S) PURPLE IS/ARE CLAIMED AS A FEATURE OF THE MARK.

THE MARK CONSISTS OF PURPLE STYLIZED DEPICTION OF AN ACORN, WITH PURPLE ALSO APPEARING IN LETTERING.

FOR BUSINESS CONSULTING AND INFORMATION SERVICES; BUSINESS CONSULTING, MANAGEMENT, PLANNING AND SUPERVISION (U.S. CLS. 100, 101 AND 102).

FIRST USE 9-6-2005; IN COMMERCE 9-6-2005.
MARGERY A. TIERNEY, EXAMINING ATTORNEY

CLASS 35—(Continued).

SN 78-725,197. QUIJANO, ELVIA, JERSEY CITY, NJ. FILED 10-3-2005.



NO CLAIM IS MADE TO THE EXCLUSIVE RIGHT TO USE "ENTERTAINMENT", APART FROM THE MARK AS SHOWN.

THE COLOR(S) RED, BLACK AND WHITE ARE CLAIMED AS A FEATURE OF THE MARK".

THE MARK CONSISTS OF A RED TARGET WITH A SOLID RED CIRCLE WITH WHITE RED CROSS HAIRS, AND A LARGER RED CIRCLE WITH RED CROSSHAIRS. THE WORD MURDA APPEARS IN BLACK ON THE OUTSIDE OF THE OUTER RING OF THE TARGET. THE LETTER M APPEARS IN BLACK IN THE MIDDLE OF THE TARGET. ANOTHER LETTER M APPEARS IN BLACK TO THE BOTTOM RIGHT OF THE TARGET, AND THE WORDS MAMIS ENTERTAINMENT APPEAR IN BLACK BELOW THE SECOND M.

FOR MANAGEMENT OF PERFORMING/RECORDING ARTISTS, DISC JOCKEYS, RADIO PERSONALITIES AND OTHER PUBLIC FIGURES; ADVERTISING, MARKETING, AND PROMOTION SERVICES; ARRANGING AND CONDUCTING MARKETING PROMOTIONAL EVENTS FOR OTHERS (U.S. CLS. 100, 101 AND 102).

FIRST USE 1-0-2002; IN COMMERCE 1-0-2002.

JENNIFER MCROBBIE, EXAMINING ATTORNEY

CLASS 35—(Continued).

SN 78-727,564. THE HOME SERVICE STORE, INC., RUTLAND, VT. FILED 10-6-2005.

GO WITH A PRO

THE MARK CONSISTS OF STANDARD CHARACTERS WITHOUT CLAIM TO ANY PARTICULAR FONT, STYLE, SIZE, OR COLOR.

FOR PROMOTING THE SALE OF PRODUCTS AND SERVICES, PROVIDED BY OTHERS, FOR THE IMPROVEMENT OF HOMES, BUSINESSES AND INSTITUTIONS; PROMOTING IN STORES OF OTHERS, THE PRODUCTS AND SERVICES OF OTHERS, FOR THE IMPROVEMENT OF HOMES, BUSINESSES AND INSTITUTIONS; REFERRAL OF HOMEOWNERS, BUSINESSES AND INSTITUTIONS TO CONTRACTORS, NAMELY, MATCHING CONTRACTORS WITH PARTIES THAT DESIRE TO ACQUIRE GOODS AND SERVICES FOR THE IMPROVEMENT OF HOMES, BUSINESSES AND INSTITUTIONS; REFERRAL OF HOMEOWNERS, BUSINESSES AND INSTITUTIONS TO CONTRACTORS, NAMELY, MATCHING CONTRACTORS THAT PERFORM MAINTENANCE, IMPROVEMENT AND/OR REPAIR SERVICES IN HOMES, BUSINESSES AND INSTITUTIONS WITH PARTIES THAT DESIRE SUCH MAINTENANCE, IMPROVEMENT AND/OR REPAIR SERVICES; OFFERING A REFERRAL SERVICE FOR CONTRACTORS, NAMELY INTRODUCING CONTRACTORS TO HOMEOWNERS, BUSINESSES AND INSTITUTIONS DESIRING MAINTENANCE, IMPROVEMENT OR REPAIR SERVICES (U.S. CLS. 100, 101 AND 102).

FIRST USE 8-16-2005; IN COMMERCE 8-16-2005.

DOMINIC FATHY, EXAMINING ATTORNEY

SN 78-725,531. FIRST PEOPLE'S FUND, RAPID CITY, SD. FILED 10-3-2005.

COLLECTIVE SPIRIT

THE MARK CONSISTS OF STANDARD CHARACTERS WITHOUT CLAIM TO ANY PARTICULAR FONT, STYLE, SIZE, OR COLOR.

FOR ASSOCIATION SERVICES, NAMELY, PROMOTING THE INTERESTS OF AMERICAN INDIAN ARTISTS AND CRAFTSPEOPLE ENGAGED IN THE FIELD OF AMERICAN INDIAN ARTS AND CRAFTS, AND ENGAGED IN FOSTERING COMMUNITY SPIRIT (U.S. CLS. 100, 101 AND 102).

FIRST USE 3-0-2003; IN COMMERCE 3-0-2003.

TEJBIR SINGH, EXAMINING ATTORNEY

SN 78-728,654. ETIGO INC., ORLANDO, FL. FILED 10-7-2005.

Quà Vui

THE MARK CONSISTS OF STANDARD CHARACTERS WITHOUT CLAIM TO ANY PARTICULAR FONT, STYLE, SIZE, OR COLOR.

"THE FOREIGN WORDING IN THE MARK TRANSLATES INTO ENGLISH AS A JOYFUL GIFT."

SEC. 2(F) AS TO QUA VUI.

FOR COMPUTERIZED ON-LINE GIFT ORDERING SERVICE WHICH MATCHES THE GIFT GIVER'S REQUIREMENTS WITH THE GIFT RECIPIENT'S WANTS AND NEEDS; ISSUING GIFT CERTIFICATES WHICH MAY THEN BE REDEEMED FOR GOODS OR SERVICES; RETAIL GIFT SHOPS (U.S. CLS. 100, 101 AND 102).

FIRST USE 6-2-2005; IN COMMERCE 6-2-2005.

CHERYL CLAYTON, EXAMINING ATTORNEY

CLASS 35—(Continued).

SN 78-728,957. WHITEBOARD BROADBAND SOLUTIONS, LLC, COLUMBUS, OH. FILED 10-7-2005.



NO CLAIM IS MADE TO THE EXCLUSIVE RIGHT TO USE "BROADBAND SOLUTIONS", APART FROM THE MARK AS SHOWN.

FOR BUSINESS CONSULTING, PLANNING AND LOBBYING SERVICES IN CONNECTION WITH PROVISION OF TELECOMMUNICATIONS SERVICES (U.S. CLS. 100, 101 AND 102).

FIRST USE 3-17-2005; IN COMMERCE 3-17-2005.
DAHLIA GEORGE, EXAMINING ATTORNEY

SN 78-729,123. AQUATIC HEALTH RESOURCES, L.L.C., BRAINERD, MN. FILED 10-7-2005.

RGS TRIDENT

THE MARK CONSISTS OF STANDARD CHARACTERS WITHOUT CLAIM TO ANY PARTICULAR FONT, STYLE, SIZE, OR COLOR.

FOR DISTRIBUTORSHIPS IN THE FIELD OF PRODUCTS FOR THE ANIMAL HEALTH INDUSTRY (U.S. CLS. 100, 101 AND 102).

ELISSA GARBER KON, EXAMINING ATTORNEY

SN 78-734,284. SOUTH DAKOTA CORN GROWERS ASSOCIATION, SIOUX FALLS, SD. FILED 10-17-2005.

SOUTH DAKOTA CORN GROWERS ASSOCIATION

THE MARK CONSISTS OF STANDARD CHARACTERS WITHOUT CLAIM TO ANY PARTICULAR FONT, STYLE, SIZE, OR COLOR.

NO CLAIM IS MADE TO THE EXCLUSIVE RIGHT TO USE "ASSOCIATION", APART FROM THE MARK AS SHOWN.

SEC. 2(F).

FOR ASSOCIATION SERVICES, NAMELY, PROMOTING THE INTERESTS OF CORN GROWERS AND OTHERS INTERESTED IN THE SALE AND UTILIZATION OF CORN (U.S. CLS. 100, 101 AND 102).

FIRST USE 0-0-1987; IN COMMERCE 0-0-1987.
MELISSA VALLILLO, EXAMINING ATTORNEY

CLASS 35—(Continued).

SN 78-734,339. SOUTH DAKOTA CORN GROWERS ASSOCIATION, SIOUX FALLS, SD. FILED 10-17-2005.



NO CLAIM IS MADE TO THE EXCLUSIVE RIGHT TO USE "ASSOCIATION", APART FROM THE MARK AS SHOWN.

SEC. 2(F) AS TO "SOUTH DAKOTA CORN GROWERS ASSOCIATION".

FOR ASSOCIATION SERVICES, NAMELY, PROMOTING THE INTERESTS OF CORN GROWERS AND OTHERS INTERESTED IN THE SALE AND UTILIZATION OF CORN (U.S. CLS. 100, 101 AND 102).

FIRST USE 7-0-2005; IN COMMERCE 7-0-2005.
MELISSA VALLILLO, EXAMINING ATTORNEY

SN 78-735,461. WONDERLIC, INC., LIBERTYVILLE, IL. FILED 10-18-2005.

WONDERLIC RECRUITING RESULTS

THE MARK CONSISTS OF STANDARD CHARACTERS WITHOUT CLAIM TO ANY PARTICULAR FONT, STYLE, SIZE, OR COLOR.

OWNER OF U.S. REG. NOS. 1,812,131 AND 3,058,166.
NO CLAIM IS MADE TO THE EXCLUSIVE RIGHT TO USE "RECRUITING RESULTS", APART FROM THE MARK AS SHOWN.

FOR HUMAN RESOURCES CONSULTATION; TESTING TO DETERMINE EMPLOYMENT SKILLS (U.S. CLS. 100, 101 AND 102).

FIRST USE 10-1-2003; IN COMMERCE 10-1-2003.
INGRID C. EULIN, EXAMINING ATTORNEY

CLASS 35—(Continued).

SN 78-740,654. CITIZENS' COMMITTEE FOR CHILDREN OF NEW YORK, INC., NEW YORK, NY. FILED 10-26-2005.

**SECURING EVERY CHILD'S
BIRTHRIGHT**

THE MARK CONSISTS OF STANDARD CHARACTERS WITHOUT CLAIM TO ANY PARTICULAR FONT, STYLE, SIZE, OR COLOR.

FOR PROMOTING PUBLIC AWARENESS OF THE NEED FOR THE CARE OF CHILDREN (U.S. CLS. 100, 101 AND 102).

FIRST USE 10-19-2004; IN COMMERCE 10-19-2004.
KRISTINA KLOIBER, EXAMINING ATTORNEY

SN 78-743,397. WINEBOW, INC., MONTVALE, NJ. FILED 10-31-2005.



OWNER OF U.S. REG. NO. 2,071,562.
NO CLAIM IS MADE TO THE EXCLUSIVE RIGHT TO USE BRANDS INTERNATIONAL, APART FROM THE MARK AS SHOWN.

FOR PROMOTING GOODS AND SERVICES OF OTHERS THROUGH DISTRIBUTION OF PRINTED ADVERTISING MATERIALS; DISTRIBUTORSHIP SERVICES FEATURING IMPORTED WINES, SPIRITS, GRAPPA, LIQUEURS, FOODS, NAMELY, OLIVE OIL, VINEGAR, SPECIALTY CANNED GOODS AND DIGESTIVE FOOD AND BEVERAGES (U.S. CLS. 100, 101 AND 102).

FIRST USE 7-1-2005; IN COMMERCE 7-1-2005.
STEVEN PEREZ, EXAMINING ATTORNEY

SN 78-743,969. HEALTH & BEAUTY ASSOCIATION LLC, MANHASSET, NY. FILED 10-31-2005.

**HBA INTERNATIONAL
PACKAGE DESIGN AWARDS**

THE MARK CONSISTS OF STANDARD CHARACTERS WITHOUT CLAIM TO ANY PARTICULAR FONT, STYLE, SIZE, OR COLOR.

OWNER OF U.S. REG. NOS. 2,876,430, 2,894,490 AND OTHERS.
NO CLAIM IS MADE TO THE EXCLUSIVE RIGHT TO USE "INTERNATIONAL PACKAGE DESIGN AWARDS", APART FROM THE MARK AS SHOWN.

FOR ARRANGING, PROMOTING AND CONDUCTING TRADE SHOWS, CONFERENCES AND EXPOSITIONS IN THE FIELD OF COSMETICS, FRAGRANCES, TOILETRIES, SKIN CARE, AND RELATED TECHNOLOGIES (U.S. CLS. 100, 101 AND 102).

FIRST USE 6-20-2000; IN COMMERCE 6-20-2000.
DANNEAN HETZEL, EXAMINING ATTORNEY

CLASS 35—(Continued).

SN 78-747,454. THE GUMBELS, INC., NEW YORK, NY. FILED 11-4-2005.

Caravan

THE COLOR(S) GRAY IS/ARE CLAIMED AS A FEATURE OF THE MARK.

THE WORD CARAVAN IS IN GRAY.
THE MARK CONSISTS OF A STYLIZED DESIGN OF THE WORD "CARAVAN".

FOR RETAIL CLOTHING BOUTIQUES (U.S. CLS. 100, 101 AND 102).

FIRST USE 1-1-2005; IN COMMERCE 1-1-2005.
DAWN FELDMAN, EXAMINING ATTORNEY

SN 78-748,893. LOTAL ENTERPRISES LLC, NEW YORK, NY. FILED 11-7-2005.

BANANAMOVING.COM

THE MARK CONSISTS OF STANDARD CHARACTERS WITHOUT CLAIM TO ANY PARTICULAR FONT, STYLE, SIZE, OR COLOR.

FOR REFERRAL SERVICES IN THE FIELDS OF RESIDENTIAL AND COMMERCIAL MOVING AND RELOCATION SERVICES, HOME REPAIR AND REMODELING SERVICES, REAL ESTATE SERVICES, MOVING, PROPERTY, LIABILITY AND CASUALTY INSURANCE SERVICES, LAWN CARE AND PEST CONTROL SERVICES, PLUMBING SERVICES, AIR CONDITIONING AND HEATING SERVICES, AND HOME SECURITY SERVICES, ALL PROVIDED THROUGH A GLOBAL COMPUTER NETWORK; ADVERTISING AND PROMOTING THE GOODS AND SERVICES OF OTHERS BY PROVIDING A WEBSITE IN WHICH USERS CAN LINK TO THE WEBSITES OF OTHERS IN THE FIELDS OF RESIDENTIAL AND COMMERCIAL MOVING AND RELOCATION SERVICES, HOME REPAIR AND REMODELING SERVICES, REAL ESTATE SERVICES, MOVING, PROPERTY, LIABILITY AND CASUALTY INSURANCE SERVICES, LAWN CARE AND PEST CONTROL SERVICES, PLUMBING SERVICES, AIR CONDITIONING AND HEATING SERVICES, AND HOME SECURITY SERVICES (U.S. CLS. 100, 101 AND 102).

DAWN FELDMAN, EXAMINING ATTORNEY

CLASS 35—(Continued).

SN 78-757,507. HANNSPREE, INC., TAIPEI CITY 114, TAIWAN, FILED 11-18-2005.

my style. my tv.

THE MARK CONSISTS OF STANDARD CHARACTERS WITHOUT CLAIM TO ANY PARTICULAR FONT, STYLE, SIZE, OR COLOR.

FOR EXPORT AND IMPORT AGENCIES; RETAIL TELEVISION STORES; RETAIL DEPARTMENT STORES; RETAIL GIFT SHOPS; RETAIL STORE SERVICES FEATURING A WIDE VARIETY OF CONSUMER GOODS OF OTHERS; WHOLESALE STORES FEATURING GIFTS AND CONSUMER ELECTRONIC PRODUCTS; COMPUTERIZED ONLINE ORDERING FEATURING GENERAL MERCHANDISE AND GENERAL CONSUMER GOODS; AUCTION MANAGEMENT SERVICES PROVIDED TO OTHERS OVER AN ONLINE WEB SITE ACCESSED THROUGH A GLOBAL COMPUTER NETWORK; MAIL ORDER SERVICES FEATURING A WIDE VARIETY OF CONSUMER ELECTRONIC PRODUCTS (U.S. CLS. 100, 101 AND 102).

SOPHIA S. KIM, EXAMINING ATTORNEY

SN 78-757,662. ADAPTIVE ASSESSMENT SERVICES, JACKSONVILLE, FL. FILED 11-19-2005.

Smart Test Technology

THE MARK CONSISTS OF STANDARD CHARACTERS WITHOUT CLAIM TO ANY PARTICULAR FONT, STYLE, SIZE, OR COLOR.

NO CLAIM IS MADE TO THE EXCLUSIVE RIGHT TO USE "TEST TECHNOLOGY", APART FROM THE MARK AS SHOWN.

FOR CHARITABLE SERVICES, NAMELY COORDINATION OF THE PROCUREMENT AND DISTRIBUTION OF FOOD DONATIONS FROM MANUFACTURERS, WHOLESALERS, RETAILERS, AND GOVERNMENT AGENCIES TO ORGANIZATIONS PROVIDING FREE FOOD TO NEEDY PEOPLE; HUMAN CAPITAL MANAGEMENT OUTSOURCING SERVICES; HUMAN RESOURCES CONSULTATION; HUMAN RESOURCES MANAGEMENT; NATURAL RESOURCE MANAGEMENT; PSYCHOLOGICAL TESTING FOR THE SELECTION OF PERSONNEL; SERVING AS A HUMAN RESOURCES DEPARTMENT FOR OTHERS; TESTING TO DETERMINE EMPLOYMENT SKILLS; TESTING TO DETERMINE JOB COMPETENCY; TESTING TO DETERMINE PROFESSIONAL COMPETENCY (U.S. CLS. 100, 101 AND 102).

STEVEN JACKSON, EXAMINING ATTORNEY

CLASS 35—(Continued).

SN 78-761,823. CONCURRENT CONSULTING, INC., FAYETTEVILLE, GA. FILED 11-28-2005.

CONCURRENT GROWTH
CONSULTING FOR THE
ELECTRICAL INDUSTRY

THE MARK CONSISTS OF STANDARD CHARACTERS WITHOUT CLAIM TO ANY PARTICULAR FONT, STYLE, SIZE, OR COLOR.

FOR BUSINESS ORGANIZATION AND OPERATION CONSULTANCY; CONSULTING SERVICES IN BUSINESS ORGANIZATION AND MANAGEMENT (U.S. CLS. 100, 101 AND 102).

FIRST USE 11-1-2005; IN COMMERCE 11-1-2005.
INGRID C. EULIN, EXAMINING ATTORNEY

SN 78-767,524. SPOKESMAN-REVIEW, INC., SPOKANE, WA. FILED 12-6-2005.

a little bit of everything
pinch

THE COLORS BLACK AND RED ARE CLAIMED FEATURES OF THE MARK.

THE MARK CONSISTS OF THE WORDS PINCH A LITTLE BIT OF EVERYTHING IN BLACK WITH A RED CIRCLE ABOVE THE LETTER "I" IN THE WORD "PINCH".

FOR ADVERTISING FOOD AND FOODSTUFFS FOR SALE BY MEANS OF A WEEKLY PUBLICATION (U.S. CLS. 100, 101 AND 102).

FIRST USE 6-5-2005; IN COMMERCE 6-5-2005.
DAVID YONTEF, EXAMINING ATTORNEY

SN 78-768,396. ROOM 40 LLC, CHICAGO, IL. FILED 12-7-2005.

MARKETSHAREPLUS

THE MARK CONSISTS OF STANDARD CHARACTERS WITHOUT CLAIM TO ANY PARTICULAR FONT, STYLE, SIZE, OR COLOR.

FOR ADVERTISING AND MARKETING SERVICES; MARKET RESEARCH, MARKET ANALYSIS AND PREPARING AND DISTRIBUTING OF ADVERTISEMENTS FOR OTHERS; AND COMPUTERIZED DATABASE COMPILATION AND MANAGEMENT FOR OTHERS (U.S. CLS. 100, 101 AND 102).

FIRST USE 12-7-2005; IN COMMERCE 12-7-2005.
SUSAN LESLIE DUBOIS, EXAMINING ATTORNEY

CLASS 35—(Continued).

SN 78-768,604. ROLPHE INDUSTRIES, INC., COEUR D'ALENE, ID. FILED 12-7-2005.



FOR REAL ESTATE ADVERTISING SERVICES AND REAL ESTATE MARKETING SERVICES, NAMELY, ONLINE SERVICES FEATURING TOURS OF RESIDENTIAL AND COMMERCIAL REAL ESTATE (U.S. CLS. 100, 101 AND 102).

FIRST USE 1-21-2005; IN COMMERCE 1-21-2005.
AMY ALFIERI, EXAMINING ATTORNEY

SN 78-768,899. KNIGHTGATES, INC., GREENWOOD, IN. FILED 12-7-2005.

Employee Induction Motor

THE MARK CONSISTS OF STANDARD CHARACTERS WITHOUT CLAIM TO ANY PARTICULAR FONT, STYLE, SIZE, OR COLOR.

NO CLAIM IS MADE TO THE EXCLUSIVE RIGHT TO USE "EMPLOYEE", APART FROM THE MARK AS SHOWN.

FOR PERSONNEL MANAGEMENT (U.S. CLS. 100, 101 AND 102).

TRACY CROSS, EXAMINING ATTORNEY

CLASS 35—(Continued).

SN 78-775,866. CLEVER COVERS, INC., ORLANDO, FL. FILED 12-19-2005.

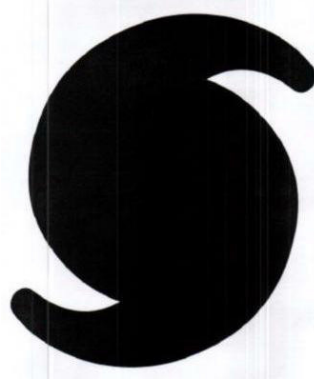

FOR RETAIL STORE AND DISTRIBUTORSHIP SERVICES FEATURING HOME AND BUSINESS STORM AND PROTECTION PRODUCTS, NAMELY, PLASTIC PANELS AND SHUTTERS FOR PROTECTING EXTERIOR AND INTERIOR WINDOWS AND DOORS FOR STORM AND SECURITY PROTECTION, AND MOUNTING HARDWARE USED THEREWITH, NAMELY, HOOK AND LOOP FASTENERS, INTERLOCKING MUSHROOM HEAD FASTENERS, SCREWS, NAILS, CLIPS AND ACCESSORIES, NAMELY, HANDLES ALL SOLD AS A UNIT; FRANCHISING, NAMELY, OFFERING TECHNICAL ASSISTANCE IN THE ESTABLISHMENT AND/OR OPERATION OF RETAIL STORE SERVICES WHICH OFFER STORM AND SECURITY PROTECTION, PLASTIC SHUTTERS, PLASTIC PANELS, FASTENERS AND HANDLES (U.S. CLS. 100, 101 AND 102).

FIRST USE 9-12-2004; IN COMMERCE 9-12-2004.
REBECCA GAN, EXAMINING ATTORNEY

SN 78-776,552. NAME RITE, L.L.C., TEMECULA, CA. FILED 12-19-2005.



OWNER OF U.S. REG. NOS. 1,427,920, 2,318,513 AND OTHERS.

NO CLAIM IS MADE TO THE EXCLUSIVE RIGHT TO USE "PHARMACY", APART FROM THE MARK AS SHOWN.

THE MARK CONSISTS OF THE WORD PREORDERX AND A SHIELD DESIGN WITH THE WORDS RITE AID AND PHARMACY.

FOR RETAIL PHARMACY SERVICES (U.S. CLS. 100, 101 AND 102).

RAMONA ORTIGA, EXAMINING ATTORNEY

CLASS 35—(Continued).

SN 78-776,797. SEAT COVERS UNLIMITED, LLC, MESA, AZ. FILED 12-20-2005.



NO CLAIM IS MADE TO THE EXCLUSIVE RIGHT TO USE "SEAT COVERS", APART FROM THE MARK AS SHOWN.

THE MARK CONSISTS OF A CARTOON MAN FIGURE SITTING ON A LONG CAR SEAT, TO THE LEFT OF SEAT AND ABOVE COVERS.

FOR WHOLESALE AND RETAIL STORE SERVICES FEATURING AUTOMOBILE SEAT COVERS, DASHBOARD COVERS, FLOOR MATS, AUTOMOBILE ACCESSORIES, AND GOLF CART SEAT COVERS (U.S. CLS. 100, 101 AND 102).

FIRST USE 1-1-1985; IN COMMERCE 1-1-1985.
KAREN BRACEY, EXAMINING ATTORNEY

CLASS 35—(Continued).

SN 78-778,987. GFK AG, 90319 NUERNBERG, FED REP GERMANY, FILED 12-22-2005.

GfK LoyaltyPlus

OWNER OF U.S. REG. NOS. 2,522,589, 2,906,704 AND OTHERS.

FOR CONDUCTING CUSTOMER SATISFACTION AND LOYALTY RESEARCH SURVEYS, AND CUSTOMER RELATIONSHIP MANAGEMENT CONSULTING, NAMELY, PROVIDING SERVICES IN THE FIELDS OF NEED ASSESSMENT, PROGRAM DESIGN, DATA ANALYSIS AND MODELING OF CUSTOMER DATA (U.S. CLS. 100, 101 AND 102).

TRACY CROSS, EXAMINING ATTORNEY

SN 78-778,641. HCCA INTERNATIONAL, INC., BRENTWOOD, TN. FILED 12-21-2005.

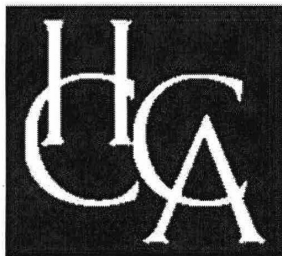

FOR EMPLOYMENT HIRING, RECRUITING, PLACEMENT, AND STAFFING SERVICES IN THE FIELD OF HEALTHCARE; INTERNATIONAL HEALTHCARE STAFFING; NURSE RECRUITING AND STAFFING SERVICES; HEALTHCARE MANAGEMENT SERVICES, NAMELY, INTERNATIONAL ADMINISTRATION AND MANAGEMENT OF HOSPITALS FOR OTHERS; BUSINESS MANAGEMENT SERVICES, NAMELY, MANAGEMENT IN THE FIELD OF HOSPITALS AND HEALTHCARE FACILITIES (U.S. CLS. 100, 101 AND 102).

FIRST USE 9-0-2002; IN COMMERCE 9-0-2002.
GEOFFREY FOSDICK, EXAMINING ATTORNEY

SN 78-780,028. LEVYTI CONSULTING LLC, MCLEAN, VA. FILED 12-23-2005.



THE COLORS WHITE AND DARK BLUE ARE CLAIMED AS A FEATURE OF THE MARK.

THE COLOR WHITE APPEARS IN THE LETTERING FOR THE LITERAL ELEMENT "LEVY" AND AS THE RECTANGULAR BACKGROUND COLOR BEHIND THE LITERAL ELEMENT "TI". THE COLOR DARK BLUE APPEARS IN THE RECTANGULAR BACKGROUND COLOR BEHIND THE LITERAL ELEMENT "LEVY" AND IN THE LETTERING FOR THE LITERAL ELEMENT "TI".

FOR BUSINESS CONSULTING IN THE NATURE OF TAX CONSULTING; BUSINESS MANAGEMENT, PLANNING AND SUPERVISION IN THE FIELD OF TAX ADVISORY SERVICES (U.S. CLS. 100, 101 AND 102).

FIRST USE 1-15-2005; IN COMMERCE 3-1-2005.
AMY MCMENAMIN, EXAMINING ATTORNEY

CLASS 35—(Continued).

SN 78-782,606. BALLY TOTAL FITNESS HOLDING CORPORATION, CHICAGO, IL. FILED 12-29-2005.

CLUB BALLY MEMBER REWARDS

THE MARK CONSISTS OF STANDARD CHARACTERS WITHOUT CLAIM TO ANY PARTICULAR FONT, STYLE, SIZE, OR COLOR.

NO CLAIM IS MADE TO THE EXCLUSIVE RIGHT TO USE MEMBER REWARDS, APART FROM THE MARK AS SHOWN.

FOR HEALTH CLUB REWARDS PROGRAM, NAMELY, PROMOTING THE SALE AND USE OF HEALTH CLUB MEMBERSHIPS THROUGH THE ADMINISTRATION OF AN INCENTIVE REWARDS PROGRAM FOR CUSTOMERS (U.S. CLS. 100, 101 AND 102).
JENNIFER MCROBBIE, EXAMINING ATTORNEY

SN 78-785,622. EAST SIDE ENTREES, INC., WOODBURY, NY. FILED 1-5-2006.

GOT BREAKFAST?

THE MARK CONSISTS OF STANDARD CHARACTERS WITHOUT CLAIM TO ANY PARTICULAR FONT, STYLE, SIZE, OR COLOR.

NO CLAIM IS MADE TO THE EXCLUSIVE RIGHT TO USE BREAKFAST, APART FROM THE MARK AS SHOWN.

FOR CONDUCTING A PUBLIC SERVICE ADVERTISING CAMPAIGN TO EDUCATE THE PUBLIC ON THE IMPORTANCE OF GOOD NUTRITION FOR CHILDREN AND THE AVAILABILITY OF PROGRAMS TO PROVIDE BREAKFAST FOR NEEDY SCHOOL CHILDREN (U.S. CLS. 100, 101 AND 102).

FIRST USE 12-20-2005; IN COMMERCE 12-20-2005.
SHARON MEIER, EXAMINING ATTORNEY

SN 78-785,668. OKOH, EFUA, ELMHURST, NY. FILED 1-5-2006.

MISS ODUJA BEAUTY PAGEANT

THE MARK CONSISTS OF STANDARD CHARACTERS WITHOUT CLAIM TO ANY PARTICULAR FONT, STYLE, SIZE, OR COLOR.

NO CLAIM IS MADE TO THE EXCLUSIVE RIGHT TO USE "BEAUTY PAGEANT", APART FROM THE MARK AS SHOWN.

FOR PROMOTIONAL SERVICES FEATURING BEAUTY PAGEANTS (U.S. CLS. 100, 101 AND 102).
NAAKWAMA ANKRAH, EXAMINING ATTORNEY

CLASS 35—(Continued).

SN 78-787,453. MICHELLE KENNEDY, TEMPE, AZ. FILED 1-9-2006.



NO CLAIM IS MADE TO THE EXCLUSIVE RIGHT TO USE "RESTAURANT LISTINGS", APART FROM THE MARK AS SHOWN.

FOR PROVIDING ON-LINE DIRECTORY INFORMATION SERVICES, ALSO FEATURING HYPERLINKS TO OTHER WEB SITES (U.S. CLS. 100, 101 AND 102).

FIRST USE 1-9-2006; IN COMMERCE 1-9-2006.
WANDA KAY PRICE, EXAMINING ATTORNEY

SN 78-787,704. LENDINGTREE, LLC, CHARLOTTE, NC. FILED 1-9-2006.

RealEstate.com
inventing a better way

OWNER OF U.S. REG. NO. 3,100,010.
NO CLAIM IS MADE TO THE EXCLUSIVE RIGHT TO USE "REAL ESTATE" OR "COM", APART FROM THE MARK AS SHOWN.

FOR MATCHING CONSUMERS WITH REAL ESTATE PROFESSIONALS IN THE FIELD OF REAL ESTATE SERVICES, VIA A GLOBAL COMPUTER NETWORK (U.S. CLS. 100, 101 AND 102).

FIRST USE 4-1-2005; IN COMMERCE 4-5-2005.
STANLEY I. OSBORNE, EXAMINING ATTORNEY

CLASS 35—(Continued).

SN 78-787,910. HOT TOPIC, INC., CITY OF INDUSTRY, CA.
FILED 1-9-2006.

30 YEARS OF PUNK

THE MARK CONSISTS OF STANDARD CHARACTERS WITHOUT CLAIM TO ANY PARTICULAR FONT, STYLE, SIZE, OR COLOR.

NO CLAIM IS MADE TO THE EXCLUSIVE RIGHT TO USE "PUNK", APART FROM THE MARK AS SHOWN.

FOR ON-LINE RETAIL STORE SERVICES FEATURING CLOTHING AND RELATED ACCESSORIES, GIFTS, STATIONERY ITEMS, COSMETICS, AND PRERECORDED AUDIO AND VIDEO PRODUCTS; RETAIL APPAREL STORES; RETAIL MUSIC AND RECORD STORES; RETAIL STORE SERVICES IN THE FIELD OF CLOTHING AND RELATED ACCESSORIES, GIFTS, STATIONERY ITEMS, COSMETICS, AND PRERECORDED AUDIO AND VIDEO PRODUCTS FEATURING A BONUS INCENTIVE PROGRAM FOR CUSTOMERS; RETAIL STORES FEATURING CLOTHING AND RELATED ACCESSORIES, GIFTS, STATIONERY ITEMS, COSMETICS, AND PRERECORDED AUDIO AND VIDEO PRODUCTS (U.S. CLS. 100, 101 AND 102).

TIMOTHY FINNEGAN, EXAMINING ATTORNEY

CLASS 35—(Continued).

SN 78-793,628. MICRO ELECTRONICS, INC., HILLIARD, OH. FILED 1-18-2006.



OWNER OF U.S. REG. NOS. 1,552,264, 1,843,328 AND 2,794,827.

NO CLAIM IS MADE TO THE EXCLUSIVE RIGHT TO USE "ONLINE", APART FROM THE MARK AS SHOWN.

SEC. 2(F).

FOR COMPUTERIZED ON-LINE RETAIL STORE SERVICES IN THE FIELD OF COMPUTERS, COMPUTER HARDWARE, COMPUTER PROCESSORS, COMPUTER PERIPHERAL DEVICES, COMPUTER MONITORS, COMPUTER SUPPLIES, COMPUTER ACCESSORIES, COMPUTER SOFTWARE, COMPUTER GAMES, DIGITAL CAMERAS, CAMCORDERS, COMPUTER HARD DISC DRIVES, COMPUTER FLOPPY DRIVES, DVD DRIVES, CD DRIVES, CDS, DVDS, WIRELESS TELEPHONES, CALCULATORS, GPS DEVICES, MP3 PLAYERS, PDAS, COMPUTER PRINTERS, PRINTER CARTRIDGES, FURNITURE, AND BOOKS (U.S. CLS. 100, 101 AND 102).

FIRST USE 5-25-2002; IN COMMERCE 5-25-2002.

ARETHA SOMERVILLE, EXAMINING ATTORNEY

SN 78-791,754. PK WORLDMEDIA, INC., CARMEL, CA.
FILED 1-13-2006.

IDENTITREND

THE MARK CONSISTS OF STANDARD CHARACTERS WITHOUT CLAIM TO ANY PARTICULAR FONT, STYLE, SIZE, OR COLOR.

FOR BUSINESS RESEARCH SERVICES, NAMELY BUSINESS RESEARCH TO IDENTIFY AND TRACK CHANGES IN TRENDS IN ALL ASPECTS OF CONSUMERS' LIVES, INCLUDING TRENDS IN BUSINESS, FINANCE, INVESTING, TECHNOLOGY, COMPUTERS, COMMUNICATIONS, ENTERTAINMENT, SPORTS, RECREATION, HEALTH, ENERGY, NATURAL RESOURCES, FARMING, MANUFACTURING, RETAILING, TRANSPORTATION, GOVERNMENT, MILITARY, ARTS, CULTURE AND SOCIAL INTERACTION (U.S. CLS. 100, 101 AND 102).

ANDREA K. NADELMAN, EXAMINING ATTORNEY

SN 78-793,731. SUMMIT ELECTRIC SUPPLY COMPANY, INC., ALBUQUERQUE, NM. FILED 1-18-2006.

**SUMMIT'S 30-Second Counter
Service Guarantee**

THE MARK CONSISTS OF STANDARD CHARACTERS WITHOUT CLAIM TO ANY PARTICULAR FONT, STYLE, SIZE, OR COLOR.

NO CLAIM IS MADE TO THE EXCLUSIVE RIGHT TO USE 30-SECOND COUNTER SERVICE GUARANTEE, APART FROM THE MARK AS SHOWN.

FOR DISTRIBUTORSHIP SERVICES IN THE FIELD OF ELECTRICAL AND INDUSTRIAL MAINTENANCE, REPAIR AND OPERATIONS SUPPLIES AND EQUIPMENT (U.S. CLS. 100, 101 AND 102).

FIRST USE 12-31-1990; IN COMMERCE 12-31-1990.

ANNE MADDEN, EXAMINING ATTORNEY

CLASS 35—(Continued).

SN 78-793,752. SUMMIT ELECTRIC SUPPLY COMPANY, INC., ALBUQUERQUE, NM. FILED 1-18-2006.

CLASS 35—(Continued).

SN 78-797,292. LENDINGTREE LLC, CHARLOTTE, NC. FILED 1-23-2006.

20/20 Will-Call Guarantee

THE MARK CONSISTS OF STANDARD CHARACTERS WITHOUT CLAIM TO ANY PARTICULAR FONT, STYLE, SIZE, OR COLOR.

NO CLAIM IS MADE TO THE EXCLUSIVE RIGHT TO USE WILL-CALL GUARANTEE, APART FROM THE MARK AS SHOWN.

FOR DISTRIBUTORSHIP SERVICES IN THE FIELD OF ELECTRICAL AND INDUSTRIAL MAINTENANCE, REPAIR AND OPERATIONS SUPPLIES AND EQUIPMENT (U.S. CLS. 100, 101 AND 102).

FIRST USE 12-31-1985; IN COMMERCE 12-31-1985.
ANNE MADDEN, EXAMINING ATTORNEY

THE MARK CONSISTS OF STANDARD CHARACTERS WITHOUT CLAIM TO ANY PARTICULAR FONT, STYLE, SIZE, OR COLOR.

FOR MATCHING CONSUMERS WITH REAL ESTATE PROFESSIONALS IN THE FIELD OF REAL ESTATE SERVICES, VIA A GLOBAL COMPUTER NETWORK (U.S. CLS. 100, 101 AND 102).

FIRST USE 1-23-2006; IN COMMERCE 1-23-2006.

STANLEY I. OSBORNE, EXAMINING ATTORNEY

SN 78-797,978. FOLK ART BY DAVID, INC., CHILLICOTHE, OH. FILED 1-24-2006.

Saltbox and Willows

SN 78-795,145. STA TRAVEL, INC., LOS ANGELES, CA. FILED 1-19-2006.

THE MARK CONSISTS OF STANDARD CHARACTERS WITHOUT CLAIM TO ANY PARTICULAR FONT, STYLE, SIZE, OR COLOR.

FOR RETAIL STORE SERVICES FEATURING A WIDE VARIETY OF CONSUMER GOODS OF OTHERS (U.S. CLS. 100, 101 AND 102).

FIRST USE 12-6-2005; IN COMMERCE 1-9-2006.

PETER B. BROMAGHIM, EXAMINING ATTORNEY

Travel Addicts

THE MARK CONSISTS OF STANDARD CHARACTERS WITHOUT CLAIM TO ANY PARTICULAR FONT, STYLE, SIZE, OR COLOR.

NO CLAIM IS MADE TO THE EXCLUSIVE RIGHT TO USE "TRAVEL", APART FROM THE MARK AS SHOWN.

FOR PROMOTING THE SALE OF GOODS AND SERVICES OF OTHERS BY MEANS OF A CUSTOMER LOYALTY, RETENTION, INCENTIVE, AND REWARD PROGRAM THAT ALLOWS PARTICIPANTS TO EARN PURCHASE POINTS BY PURCHASING TRAVEL SERVICES AND OTHER GOODS AND SERVICES THROUGH APPLICANT AND ITS COMMERCIAL PARTNERS AND THEN REDEEM THOSE POINTS FOR DISCOUNTS ON AIRLINE TICKETS, LODGING, AND GROUND EXCURSIONS (U.S. CLS. 100, 101 AND 102).

FIRST USE 4-1-2005; IN COMMERCE 4-1-2005.
ANDREW RHIM, EXAMINING ATTORNEY

SN 78-800,853. CAG PRODUCTIONS, LLC, MERRICK, NY. FILED 1-27-2006.

CAG

THE MARK CONSISTS OF STANDARD CHARACTERS WITHOUT CLAIM TO ANY PARTICULAR FONT, STYLE, SIZE, OR COLOR.

FOR PROMOTING THE GOODS AND SERVICES OF OTHERS VIA A GLOBAL COMPUTER NETWORK, NAMELY PROVIDING A WEBSITE AT WHICH USERS RECEIVE INFORMATION REGARDING VIDEO GAME SALES AND AT WHICH USERS CAN LINK TO THE WEB SITES OF OTHERS REGARDING VIDEO GAME SALES (U.S. CLS. 100, 101 AND 102).

FIRST USE 4-28-2003; IN COMMERCE 4-28-2003.

GIANCARLO CASTRO, EXAMINING ATTORNEY

CLASS 35—(Continued).

SN 78-802,193. ELLISON EDUCATIONAL EQUIPMENT, INC., LAKE FOREST, CA. FILED 1-30-2006.

ELLISONDESIGN.COM

THE MARK CONSISTS OF STANDARD CHARACTERS WITHOUT CLAIM TO ANY PARTICULAR FONT, STYLE, SIZE, OR COLOR.

OWNER OF U.S. REG. NOS. 2,168,762, 2,174,225 AND OTHERS.

FOR RETAILING SERVICES VIA A GLOBAL COMPUTER NETWORK FOR HAND OPERATED DIE AND PLATE CUTTERS, EMBOSSERS, STAMPERS, STEEL RULE DIES, CHEMICAL-ETCHED DIES, STORAGE CONTAINERS, CARRIERS, ORGANIZERS, PAPERS, PUNCHES, BOOKS, FABRICS, SPONGES, MAGNETS, FOILS, POLY FOAMS, PLASTICS, STICKERS, SCISSORS, LAMINATORS, ADHESIVES, STENCILS, BINDERS, SHIRTS, GREETING CARDS, AND PRE-CUT SHAPES (U.S. CLS. 100, 101 AND 102).

SETH A. RAPPAPORT, EXAMINING ATTORNEY

SN 78-805,678. JONAS! MUSIC SERVICES, LK. HOPATCONG, NJ. FILED 2-2-2006.

jōnas!
music services

NO CLAIM IS MADE TO THE EXCLUSIVE RIGHT TO USE "MUSIC SERVICES", APART FROM THE MARK AS SHOWN.

FOR MARKETING, ADVERTISING, PUBLICITY CONSULTATION, PROMOTIONAL SERVICES, AND RELATED CONSULTING SERVICES IN THE FIELD OF MUSIC; DISTRIBUTION OF PRODUCTS FOR ADVERTISING PURPOSES, NAMELY, DIGITAL COMPACT DISC DISTRIBUTION AND RELATED CONSULTING SERVICES (U.S. CLS. 100, 101 AND 102).

FIRST USE 1-27-2006; IN COMMERCE 3-2-2006.

DAVID MILLER, EXAMINING ATTORNEY

CLASS 35—(Continued).

SN 78-811,221. CLEVER COVERS, INC., ORLANDO, FL. FILED 2-9-2006.

CLEVER COVERS

THE MARK CONSISTS OF STANDARD CHARACTERS WITHOUT CLAIM TO ANY PARTICULAR FONT, STYLE, SIZE, OR COLOR.

NO CLAIM IS MADE TO THE EXCLUSIVE RIGHT TO USE "COVERS", APART FROM THE MARK AS SHOWN.

FOR RETAIL STORE SERVICES FEATURING HOME AND BUSINESS STORM AND PROTECTION PRODUCTS, NAMELY, PLASTIC PANELS AND SHUTTERS FOR PROTECTING EXTERIOR AND INTERIOR WINDOWS AND DOORS FOR STORM AND SECURITY PROTECTION, AND MOUNTING HARDWARE THEREFOR, NAMELY, HOOK AND LOOP FASTENERS, INTERLOCKING MUSHROOM HEAD FASTENERS, SCREWS, NAILS, CLIPS AND ACCESSORIES, NAMELY, HANDLES; DISTRIBUTORSHIPS FEATURING STORM AND SECURITY PROTECTION ITEMS, PLASTIC SHUTTERS, PLASTIC PANELS, FASTENERS AND HANDLES; AND FRANCHISING, NAMELY, OFFERING TECHNICAL ASSISTANCE IN THE ESTABLISHMENT AND/OR OPERATION OF RETAIL STORES AND DISTRIBUTORSHIPS FEATURING STORM AND SECURITY PROTECTION, PLASTIC SHUTTERS, PLASTIC PANELS, FASTENERS AND HANDLES (U.S. CLS. 100, 101 AND 102).

FIRST USE 9-12-2004; IN COMMERCE 9-19-2004.

REBECCA GAN, EXAMINING ATTORNEY

SN 78-812,412. PAUL, ANTHONY D., HUNTSVILLE, AL. FILED 2-10-2006.

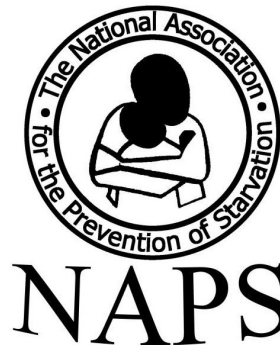

NO CLAIM IS MADE TO THE EXCLUSIVE RIGHT TO USE "THE NATIONAL ASSOCIATION FOR THE PREVENTION OF STARVATION", APART FROM THE MARK AS SHOWN.

THE MARK CONSISTS OF A SEAL SURROUNDING AN IMAGE OF A PERSON HOLDING A CHILD.

FOR CHARITABLE SERVICES, NAMELY, ORGANIZING AND CONDUCTING VOLUNTEER PROGRAMS AND COMMUNITY SERVICE PROJECTS IN THE FIELD OF DRUG PREVENTION, HIV/AIDS PREVENTION INFORMATION, COMMUNITY DEVELOPMENT, ACADEMIC TUTORING PROGRAMS FOR YOUTH, VIOLENCE PREVENTION, AND FOOD DISTRIBUTION (U.S. CLS. 100, 101 AND 102).

FIRST USE 5-3-2000; IN COMMERCE 5-3-2000.

AMY MCMENAMIN, EXAMINING ATTORNEY

CLASS 35—(Continued).

SN 78-814,097. SPX CORPORATION, CHARLOTTE, NC. FILED 2-14-2006.



FOR PERSONNEL PLACEMENT AND RECRUITMENT (U.S. CLS. 100, 101 AND 102).
INGA ERVIN, EXAMINING ATTORNEY

SN 78-816,640. RICHESON, JUANITA, SANTA MONICA, CA. FILED 2-16-2006.



OWNER OF U.S. REG. NO. 2,661,231.
NO CLAIM IS MADE TO THE EXCLUSIVE RIGHT TO USE "PHOTOS", APART FROM THE MARK AS SHOWN.
FOR LICENSING OF REPRODUCTION RIGHTS FOR PHOTOGRAPHS; RETAIL STORES FEATURING PHOTOGRAPHS (U.S. CLS. 100, 101 AND 102).
FIRST USE 9-2-2002; IN COMMERCE 9-2-2002.
BARNEY CHARLON, EXAMINING ATTORNEY

CLASS 35—(Continued).

SN 78-818,183. RELENTLESS IMPROVEMENT LLC, LIVERMORE, CA. FILED 2-17-2006.



THE APPLICANT CLAIMS COLOR AS A FEATURE OF THE MARK, NAMELY, DARK BLUE, BLUE, RED, AND GREEN.

THE MARK CONSISTS OF A RED APPLE WITH A GREEN STEM AND GREEN LEAF, THE WORD "RELENTLESS" IN DARK BLUE STANDARD FONT TO THE LEFT OF THE APPLE, AND THE WORD "IMPROVEMENT" IN BLUE STANDARD FONT TO THE RIGHT OF THE APPLE.

FOR COMPUTERIZED ON-LINE RETAIL STORE SERVICES IN THE FIELD OF FOOD, VITAMINS, MINERALS, HERBS, ANTIOXIDANTS, BOTANICAL EXTRACTS, CHEWING GUMS, EYE DROPS, AND COSMETICS; ELECTRONIC RETAILING SERVICES VIA COMPUTER FEATURING FOOD, VITAMINS, MINERALS, HERBS, ANTIOXIDANTS, BOTANICAL EXTRACTS, CHEWING GUMS, EYE DROPS, AND COSMETICS; ON-LINE RETAIL STORE SERVICES FEATURING FOOD, VITAMINS, MINERALS, HERBS, ANTIOXIDANTS, BOTANICAL EXTRACTS, CHEWING GUMS, EYE DROPS, AND COSMETICS; PROMOTING THE GOODS AND SERVICES OF OTHERS BY MEANS OF OPERATING AN ON-LINE SHOPPING MALL WITH LINKS TO THE RETAIL WEB SITES OF OTHERS (U.S. CLS. 100, 101 AND 102).

FIRST USE 2-14-2006; IN COMMERCE 2-14-2006.
KATHERINE CHANG, EXAMINING ATTORNEY

SN 78-818,488. NATIONAL AUTISM ASSOCIATION, NIXA, MO. FILED 2-19-2006.

Think Autism. Think Cure.

THE MARK CONSISTS OF STANDARD CHARACTERS WITHOUT CLAIM TO ANY PARTICULAR FONT, STYLE, SIZE, OR COLOR.

FOR ASSOCIATION SERVICES, NAMELY, PROMOTING THE INTERESTS OF FAMILIES AFFECTED BY AUTISM (U.S. CLS. 100, 101 AND 102).

PETER B. BROMAGHIM, EXAMINING ATTORNEY

CLASS 35—(Continued).

SN 78-819,555. KUZMA, ROBERT, WILMINGTON, NC.
FILED 2-21-2006.



NO CLAIM IS MADE TO THE EXCLUSIVE RIGHT TO USE "HEALTH SHOPPE", APART FROM THE MARK AS SHOWN.

FOR RETAIL STORES FEATURING VITAMINS, DIETARY SUPPLEMENTS, HEALTH FOODS, FITNESS PRODUCTS, COSMETICS AND BODY CARE PRODUCTS (U.S. CLS. 100, 101 AND 102).

G. MAYERSCHOFF, EXAMINING ATTORNEY

SN 78-819,722. A BONE TO PICK, LLC, DAVIDSONVILLE, MD. FILED 2-21-2006.

a bone to pick

THE MARK CONSISTS OF STANDARD CHARACTERS WITHOUT CLAIM TO ANY PARTICULAR FONT, STYLE, SIZE, OR COLOR.

FOR ON-LINE RETAIL STORE SERVICES FEATURING COUTURE, BEDDING, COLLARS, LEADS, BOWLS, SPA PRODUCTS, ACCESSORIES AND VARIOUS OTHER PRODUCTS FOR DOGS (U.S. CLS. 100, 101 AND 102).

FIRST USE 11-1-2005; IN COMMERCE 11-1-2005.

MARY MUNSON, EXAMINING ATTORNEY

SN 78-821,468. SHADOW ENTERPRISES LLC, RED BANK, NJ. FILED 2-23-2006.

IM Dining

THE MARK CONSISTS OF STANDARD CHARACTERS WITHOUT CLAIM TO ANY PARTICULAR FONT, STYLE, SIZE, OR COLOR.

FOR COMPUTERIZED ONLINE ORDERING SERVICES IN THE FIELD OF FOOD WHICH USE INSTANT MESSAGING FOR ORDERING (U.S. CLS. 100, 101 AND 102).

CAROL SPILS, EXAMINING ATTORNEY

CLASS 35—(Continued).

SN 78-823,394. LABORATORY ANIMAL MANAGEMENT ASSOCIATION (LAMA), EDEN PRAIRIE, MN. FILED 2-25-2006.



NO CLAIM IS MADE TO THE EXCLUSIVE RIGHT TO USE "LABORATORY ANIMAL MANAGEMENT ASSOCIATION", APART FROM THE MARK AS SHOWN.

THE COLORS MEDIUM BLUE, BLACK AND WHITE ARE CLAIMED AS A FEATURE OF THE MARK.

THE COLOR MEDIUM BLUE APPEARS IN THE GLOBE DESIGN OF THE MARK. THE COLOR BLACK APPEARS IN THE DESIGNS OF THE RABBIT, PEOPLE BARS AND THE ROUND OUTLINE OF THE GLOBE OF THE MARK. THE COLOR BLUE ALSO APPEARS IN THE WORDING "LABORATORY ANIMAL MANAGEMENT ASSOCIATION." THE COLOR WHITE APPEARS IN THE DESIGNS OF THE MOUSE AND BOOK OF THE MARK.

FOR BUSINESS NETWORKING FOR MANAGERS, SUPERVISOR, DIRECTORS, AND VENDORS IN THE LABORATORY ANIMAL MANAGEMENT INDUSTRY FOR THE BIOMEDICAL AND SAFETY ASSESSMENT RESEARCH (U.S. CLS. 100, 101 AND 102).

DAWN HAN, EXAMINING ATTORNEY

SN 78-823,922. ONE SCOTTSDALE HOLDINGS LLC, SCOTTSDALE, AZ. FILED 2-27-2006.



ONE SCOTTSDALE

NO CLAIM IS MADE TO THE EXCLUSIVE RIGHT TO USE "SCOTTSDALE", APART FROM THE MARK AS SHOWN.

FOR ASSOCIATION SERVICES, NAMELY, PROMOTING THE INTERESTS OF HOMEOWNERS THAT RESIDE IN THE COMMUNITY; COMMERCIAL BUSINESS MANAGEMENT; BUSINESS MANAGEMENT IN THE FIELD OF COMMERCIAL REAL ESTATE AND RETAIL; PROMOTING THE GOODS AND SERVICES OF OTHERS BY DISTRIBUTING ADVERTISING MATERIALS THROUGH A VARIETY OF METHODS (U.S. CLS. 100, 101 AND 102).

CAROLYN CATALDO, EXAMINING ATTORNEY

CLASS 35—(Continued).

SN 78-824,945. LOGISTICS & ENVIRONMENTAL SUPPORT SERVICES CORPORATION, HUNTSVILLE, AL. FILED 2-28-2006.



NO CLAIM IS MADE TO THE EXCLUSIVE RIGHT TO USE "TOTAL LOGISTICS SOLUTIONS", APART FROM THE MARK AS SHOWN.

THE COLOR(S) RED, BLACK AND GRAY IS/ARE CLAIMED AS A FEATURE OF THE MARK.

THE MARK CONSISTS OF MARK CONSIST OF LESCO IN RED BLOCK LETTERS WITH A BLACK SWOOSH SET BEHIND THE LETTERS WITH A RED STAR AT THE END OF THE SWOOSH ON THE LEFT HAND SIDE. TOTAL LOGISTICS SOLUTIONS IS IN RED BLOCK LETTERS LOCATED BELOW THE WORD LESCO. ALL HAVE A GRAY GRADIENT BACKGROUND.

FOR BUSINESS CONSULTING SERVICES RELATING TO PRODUCT DISTRIBUTION, OPERATIONS MANAGEMENT SERVICES, LOGISTICS, REVERSE LOGISTICS, SUPPLY CHAIN, AND PRODUCTION SYSTEMS AND DISTRIBUTION SOLUTIONS (U.S. CLS. 100, 101 AND 102).

FIRST USE 1-20-2006; IN COMMERCE 2-3-2006.
YONG KIM, EXAMINING ATTORNEY

SN 78-825,108. JHAVERI DHAVAL, COPIAGUE, NY. FILED 2-28-2006.

Zaroori

THE MARK CONSISTS OF STANDARD CHARACTERS WITHOUT CLAIM TO ANY PARTICULAR FONT, STYLE, SIZE, OR COLOR.

THE ENGLISH TRANSLATION OF "ZAROORI" IS "NECESSARY".

FOR COMPUTERIZED ONLINE ORDERING FEATURING GENERAL MERCHANDISE AND GENERAL CONSUMER GOODS (U.S. CLS. 100, 101 AND 102).

KATRINA EDGE, EXAMINING ATTORNEY

CLASS 35—(Continued).

SN 78-826,484. NEWLEVEL GROUP, LLC, NAPA, CA. FILED 3-1-2006.

HIGH SATISFACTION DAY

THE MARK CONSISTS OF STANDARD CHARACTERS WITHOUT CLAIM TO ANY PARTICULAR FONT, STYLE, SIZE, OR COLOR.

FOR BUSINESS CONSULTATION SERVICES; MANAGEMENT AND BUSINESS CONSULTING SERVICES IN THE FIELD OF ORGANIZATIONAL AND WORK PROCESS CHANGE, DESIGN AND DEVELOPMENT, AS WELL AS LEADERSHIP AND MANAGEMENT (U.S. CLS. 100, 101 AND 102).

TIMOTHY FINNEGAN, EXAMINING ATTORNEY

SN 78-827,002. TAX PROJECTS GROUP LLP, INDEPENDENCE, OH. FILED 3-2-2006.

**TAX PROJECTS GROUP**

NO CLAIM IS MADE TO THE EXCLUSIVE RIGHT TO USE TAX PROJECTS GROUP, APART FROM THE MARK AS SHOWN.

THE COLOR(S) BLUE AND BLACK IS/ARE CLAIMED AS A FEATURE OF THE MARK.

THE COLOR BLUE APPEARS IN THE LETTERING "TPG" AND IN THE HORIZONTAL LINE; THE COLOR BLACK APPEARS IN THE WORDING "TAX PROJECTS GROUP".

FOR TAX ADVISORY SERVICES OFFERED TO CERTIFIED PUBLIC ACCOUNTANTS (U.S. CLS. 100, 101 AND 102).

FIRST USE 12-15-2005; IN COMMERCE 12-15-2005.
MICHAEL GAAFAR, EXAMINING ATTORNEY

SN 78-827,808. FASHION CAREER CENTER, LLC, ENGLISHTOWN, NJ. FILED 3-2-2006.

RESUME PRO

THE MARK CONSISTS OF STANDARD CHARACTERS WITHOUT CLAIM TO ANY PARTICULAR FONT, STYLE, SIZE, OR COLOR.

NO CLAIM IS MADE TO THE EXCLUSIVE RIGHT TO USE "RESUME", APART FROM THE MARK AS SHOWN. FOR RESUME PREPARATION (U.S. CLS. 100, 101 AND 102).

FIRST USE 1-1-1990; IN COMMERCE 1-1-1990.
JOHN WILKE, EXAMINING ATTORNEY

CLASS 35—(Continued).

SN 78-828,208. DEMARCO GROUP, INC., KNOXVILLE, TN. FILED 3-3-2006.



THE MARK CONSISTS OF A STYLIZED MOTOR SCOOTER FEATURING TWO CIRCLES AS TIRES, A WAVY LINE AS THE BODY, AND A SHORT ANGLED LINE AS THE HANDLE. THE WORDING COOLBUGGIES.COM APPEARS BELOW THE DESIGN.

FOR DEALERSHIP IN THE FIELD OF VEHICLES, NAMELY, GOLF CARTS AND AUTOMOBILES (U.S. CLS. 100, 101 AND 102).

SANDRA MANIOS, EXAMINING ATTORNEY

SN 78-828,467. WIDGET SUPPLY, INC, ALBANY, OR. FILED 3-3-2006.

Widget Supply

THE MARK CONSISTS OF STANDARD CHARACTERS WITHOUT CLAIM TO ANY PARTICULAR FONT, STYLE, SIZE, OR COLOR.

NO CLAIM IS MADE TO THE EXCLUSIVE RIGHT TO USE "SUPPLY", APART FROM THE MARK AS SHOWN.

FOR COMPUTERIZED ON-LINE RETAIL STORE SERVICES IN THE FIELD OF HOBBY, CRAFT, AND JEWELER ITEMS (U.S. CLS. 100, 101 AND 102).

FIRST USE 2-1-1996; IN COMMERCE 2-13-1998.
ESTHER A. BORSUK, EXAMINING ATTORNEY

SN 78-830,604. RADIANCE LEARNING, AUSTIN, TX. FILED 3-6-2006.

Radiance Learning

THE MARK CONSISTS OF STANDARD CHARACTERS WITHOUT CLAIM TO ANY PARTICULAR FONT, STYLE, SIZE, OR COLOR.

NO CLAIM IS MADE TO THE EXCLUSIVE RIGHT TO USE "LEARNING", APART FROM THE MARK AS SHOWN. FOR BUSINESS LEADERSHIP DEVELOPMENT (U.S. CLS. 100, 101 AND 102).

FIRST USE 9-1-2005; IN COMMERCE 1-5-2006.
MATTHEW PAPPAS, EXAMINING ATTORNEY

CLASS 35—(Continued).

SN 78-831,151. CHAN, SUSAN, NEW YORK, NY. FILED 3-7-2006.

HUSH

THE MARK CONSISTS OF STANDARD CHARACTERS WITHOUT CLAIM TO ANY PARTICULAR FONT, STYLE, SIZE, OR COLOR.

FOR ON-LINE RETAIL STORE SERVICES FEATURING REST, RELAXATION, AND SLEEP RELATED GOODS, NAMELY, EARPLUGS, SLEEP MASKS, PAJAMAS, SLIPPERS, BLANKETS, PILLOWS, PLUSH TOYS, CDS, BOOKS, SOAP, BODY OIL, INCENSE, CANDLES, TEA, HOMEOPATHIC SUPPLEMENTS, DECAFFEINATED BEVERAGES, SHIRTS, STATIONERY, PENS, LAMPS, LINENS, TOTE BAGS, JOURNALS, LEOTARDS, TIGHTS (U.S. CLS. 100, 101 AND 102).

GIANCARLO CASTRO, EXAMINING ATTORNEY

SN 78-831,875. LENDINGTREE LLC, CHARLOTTE, NC. FILED 3-8-2006.

RealEstate.com

OWNER OF U.S. REG. NO. 3,100,100.

NO CLAIM IS MADE TO THE EXCLUSIVE RIGHT TO USE "REAL ESTATE OR COM", APART FROM THE MARK AS SHOWN.

FOR MATCHING CONSUMERS WITH REAL ESTATE PROFESSIONALS IN THE FIELD OF REAL ESTATE SERVICES, VIA A GLOBAL COMPUTER NETWORK (U.S. CLS. 100, 101 AND 102).

FIRST USE 4-1-2005; IN COMMERCE 4-1-2005.

STANLEY I. OSBORNE, EXAMINING ATTORNEY

SN 78-833,205. TRUCK-FRAME & AXLE REPAIR ASSOCIATION, INC., PALMYRA, MO. FILED 3-9-2006.



THE MARK CONSISTS OF THE LETTERS TARA WITH A RISING STAR AT THE TOP OF THE LETTER A.

FOR ASSOCIATION SERVICES, NAMELY, PROMOTING THE INTERESTS OF HEAVY TRUCK AND TRAILER RE-BUILDING SPECIALISTS (U.S. CLS. 100, 101 AND 102).

FIRST USE 1-1-1992; IN COMMERCE 1-1-1992.

TANYA AMOS, EXAMINING ATTORNEY

CLASS 35—(Continued).

SN 78-833,605. KISER, MARY E., WEST HOLLYWOOD, CA.
FILED 3-9-2006.

Four Legged Humans

THE MARK CONSISTS OF STANDARD CHARACTERS WITHOUT CLAIM TO ANY PARTICULAR FONT, STYLE, SIZE, OR COLOR.

FOR BUSINESS MANAGEMENT SERVICES, NAMELY, LAUNCHING OF INVENTIONS INTO THE MARKETPLACE (U.S. CLS. 100, 101 AND 102).

GRETTA YAO, EXAMINING ATTORNEY

SN 78-833,843. MAMMOTH CHOPPERS, INC., BELLINGHAM, WA. FILED 3-9-2006.

Ride the Beast

THE MARK CONSISTS OF STANDARD CHARACTERS WITHOUT CLAIM TO ANY PARTICULAR FONT, STYLE, SIZE, OR COLOR.

FOR RETAIL STORE SERVICES, MAIL-ORDER SERVICES, ONLINE RETAIL STORE SERVICES AND MAIL ORDER SERVICES VIA TELEPHONE FEATURING MOTORCYCLE EXHAUST PIPES, MOTORCYCLE ACCESSORIES, NAMELY FOOT PEGS AND BRACKET, FORWARD CONTROLS, NAMELY, FOOT BRAKES AND FOOT SHIFTERS, SIDESTANDS, FORK TUBE CAPS, SUSPENSION SYSTEMS FOR MOTORCYCLES, MASTER CYLINDERS, FOOT CONTROL LEVERS, HAND LEVERS, WHEEL SPACERS, HANDLEBAR GRIPS, HANDLEBAR CLAMPS, REARVIEW MIRRORS, HANDLEBAR SWITCHES AND HOUSINGS, CHASSIS, LEVER AND GRIP COVERS, LUGGAGE CARRIERS, FOOT SUPPORTERS, NON-CHROME SADDLEBAGS, SADDLEBAGS, CHROME MOTORCYCLE ACCESSORIES, NAMELY, BOLT-ON COVERS, SHOCK ABSORBER COVERS, BRAKE PEDALS, AXLE CAPS, VALVE STEM CAPS, MOTOR COVERS, HORN COVERS, BATTERY COVERS, CABLE GUIDES, FLOORBOARDS, HANDLEBARS, GAS CAPS, SHIFT RODS, PRIMARY COVERS, POINTS COVERS, WHEELS, MOTORCYCLE COVERS, FORKS, PULLEYS AND LICENSE PLATE HOLDERS, CLOTHING APPAREL, NAMELY LEATHER JACKETS, BELTS, HATS, SHIRTS, GLOVES, JACKETS, VESTS, PANTS, LEATHER PANTS, CHAPS, BOOTS AND DENIM JACKETS (U.S. CLS. 100, 101 AND 102).

FIRST USE 12-13-2005; IN COMMERCE 12-13-2005.

SUE LAWRENCE, EXAMINING ATTORNEY

CLASS 35—(Continued).

SN 78-834,161. HOOVER-HAWLEY ASSOCIATES, INC., ROANOKE, IN. FILED 3-10-2006.

OWNER OF U.S. REG. NOS. 2,642,666 AND 2,671,739.
FOR MANUFACTURER REPRESENTATIVES IN THE FIELD OF GIFTS AND DECORATIVE ACCESSORIES (U.S. CLS. 100, 101 AND 102).

FIRST USE 1-3-2000; IN COMMERCE 1-3-2000.
YONG KIM, EXAMINING ATTORNEY

SN 78-834,213. ONEUP INNOVATIONS, LLC, ATLANTA, GA.
FILED 3-10-2006.

EXPLORE MORE

THE MARK CONSISTS OF STANDARD CHARACTERS WITHOUT CLAIM TO ANY PARTICULAR FONT, STYLE, SIZE, OR COLOR.

FOR ONLINE RETAIL STORE SERVICES FEATURING ADULT SEXUAL AIDS, NAMELY, CUSHIONS FOR SEXUAL ENHANCEMENT, AIDING IN COPULATION, FOREPLAY AND IMPROVING THE LIKELIHOOD OF FERTILIZATION AND COVERS FOR THE SAME, WRIST CUFFS, ANKLE CUFFS, THIGH CUFFS, BLIND-FOLDS, RESTRAINTS, TETHERS, THROES, DUVETS, PILLOWS, SHAMS, POSITION GUIDES, DVDS, AND SACKS (U.S. CLS. 100, 101 AND 102).

STEPHANIE DAVIS, EXAMINING ATTORNEY

CLASS 35—(Continued).

SN 78-836,161. MATISSE LTD, EAST LIVERPOOL, OH. FILED 3-13-2006.

Gaballi Gals

THE MARK CONSISTS OF STANDARD CHARACTERS WITHOUT CLAIM TO ANY PARTICULAR FONT, STYLE, SIZE, OR COLOR.

OWNER OF U.S. REG. NO. 2,903,953.

NO CLAIM IS MADE TO THE EXCLUSIVE RIGHT TO USE "GALS", APART FROM THE MARK AS SHOWN.

FOR SHOP-AT-HOME PARTIES FEATURING PERSONALIZED PRODUCTS, NAMELY, BABY BLANKETS, BABY CLOTHING, KIDS CLOTHING, HOME DECOR, HANDBAGS AND TOTES, DOLLS, DOG CLOTHING, MEN'S CLOTHING, WOMEN'S CLOTHING; CATALOG ORDERING SERVICES FEATURING PERSONALIZED PRODUCTS SUCH AS BABY BLANKETS, BABY CLOTHING, KIDS CLOTHING, HOME DECOR, HANDBAGS AND TOTES, DOLLS, DOG CLOTHING, MEN'S CLOTHING, WOMEN'S CLOTHING; BUSINESS INTERMEDIARY AND ADVISORY SERVICES IN THE FIELD OF SELLING PRODUCTS AND RENDERING SERVICES (U.S. CLS. 100, 101 AND 102).

FIRST USE 3-4-2006; IN COMMERCE 3-4-2006.

KATHERINE CONNOLLY, EXAMINING ATTORNEY

SN 78-837,353. MULTIVEND LLC, DEER PARK, NY. FILED 3-15-2006.

MULTIVEND

THE MARK CONSISTS OF STANDARD CHARACTERS WITHOUT CLAIM TO ANY PARTICULAR FONT, STYLE, SIZE, OR COLOR.

FOR DISTRIBUTORSHIP SERVICES IN THE FIELD OF VENDING MACHINES (U.S. CLS. 100, 101 AND 102).

FIRST USE 12-31-1990; IN COMMERCE 12-31-1990.

EDWARD FENNESSY, EXAMINING ATTORNEY

CLASS 35—(Continued).

SN 78-838,754. ASAP SOFTWARE EXPRESS, INC., BUFFALO GROVE, IL. FILED 3-16-2006.

BUYIT@ASAP

THE MARK CONSISTS OF STANDARD CHARACTERS WITHOUT CLAIM TO ANY PARTICULAR FONT, STYLE, SIZE, OR COLOR.

OWNER OF U.S. REG. NOS. 1,969,425, 1,969,426 AND 2,421,516.

FOR DISTRIBUTORSHIP SERVICES IN THE FIELD OF COMPUTER SOFTWARE AND COMPUTERS; ELECTRONIC RETAILING SERVICES VIA THE INTERNET FEATURING COMPUTERS AND COMPUTER SOFTWARE; LICENSING OF COMPUTER SOFTWARE; RETAIL STORE SERVICES FEATURING COMPUTER SOFTWARE OF OTHERS (U.S. CLS. 100, 101 AND 102).

FIRST USE 7-0-2005; IN COMMERCE 7-0-2005.

ALLISON SCHRODY, EXAMINING ATTORNEY

SN 78-838,835. CASEPOST, INC., IRVINE, CA. FILED 3-16-2006.

CASEPOST

THE MARK CONSISTS OF STANDARD CHARACTERS WITHOUT CLAIM TO ANY PARTICULAR FONT, STYLE, SIZE, OR COLOR.

FOR ON-LINE ADVERTISING SERVICES, NAMELY, MAINTAINING A WEB SITE FOR PROFESSIONALS TO BE MATCHED WITH POTENTIAL CLIENTS IN RESPONSE TO CLIENT SOLICITATIONS (U.S. CLS. 100, 101 AND 102).

FIRST USE 1-1-2002; IN COMMERCE 12-1-2002.

JOHN GARTNER, EXAMINING ATTORNEY

SN 78-839,653. EAU CLAIRE SAND AND GRAVEL COMPANY, INC., EAU CLAIRE, WI. FILED 3-17-2006.

ROCK ON

THE MARK CONSISTS OF STANDARD CHARACTERS WITHOUT CLAIM TO ANY PARTICULAR FONT, STYLE, SIZE, OR COLOR.

FOR ONLINE RETAIL, CATALOG RETAIL AND RETAIL STORE SERVICES FEATURING LANDSCAPING MATERIALS, NAMELY, DECORATIVE ROCK AND STONE (U.S. CLS. 100, 101 AND 102).

GIANCARLO CASTRO, EXAMINING ATTORNEY

CLASS 35—(Continued).

SN 78-839,678. HARMONY HARDWARE AND HOME, LLC, NORMAN, OK. FILED 3-17-2006.

HARMONY HARDWARE & HOME

THE MARK CONSISTS OF STANDARD CHARACTERS WITHOUT CLAIM TO ANY PARTICULAR FONT, STYLE, SIZE, OR COLOR.

NO CLAIM IS MADE TO THE EXCLUSIVE RIGHT TO USE "HARDWARE & HOME", APART FROM THE MARK AS SHOWN.

FOR RETAIL STORE SERVICES IN THE FIELD OF HARDWARE (U.S. CLS. 100, 101 AND 102).

FIRST USE 2-15-2006; IN COMMERCE 2-15-2006.
JERI J. FICKES, EXAMINING ATTORNEY

SN 78-839,690. EAU CLAIRE SAND AND GRAVEL COMPANY, INC., EAU CLAIRE, WI. FILED 3-17-2006.

DO YOU ROCK?

THE MARK CONSISTS OF STANDARD CHARACTERS WITHOUT CLAIM TO ANY PARTICULAR FONT, STYLE, SIZE, OR COLOR.

FOR ONLINE RETAIL, CATALOG RETAIL AND RETAIL STORE SERVICES FEATURING LANDSCAPING MATERIALS, NAMELY, DECORATIVE ROCK AND STONE (U.S. CLS. 100, 101 AND 102).

GIANCARLO CASTRO, EXAMINING ATTORNEY

SN 78-839,711. EAU CLAIRE SAND AND GRAVEL COMPANY, INC., EAU CLAIRE, WI. FILED 3-17-2006.

DO YOU STONE?

THE MARK CONSISTS OF STANDARD CHARACTERS WITHOUT CLAIM TO ANY PARTICULAR FONT, STYLE, SIZE, OR COLOR.

FOR ONLINE RETAIL, CATALOG RETAIL AND RETAIL STORE SERVICES FEATURING LANDSCAPING MATERIALS, NAMELY, DECORATIVE ROCK AND STONE (U.S. CLS. 100, 101 AND 102).

GIANCARLO CASTRO, EXAMINING ATTORNEY

CLASS 35—(Continued).

SN 78-840,312. ARENA, CHRISTINE, SAN FRANCISCO, CA. FILED 3-17-2006.

HIGH-PURPOSE ID

THE MARK CONSISTS OF STANDARD CHARACTERS WITHOUT CLAIM TO ANY PARTICULAR FONT, STYLE, SIZE, OR COLOR.

FOR BUSINESS CONSULTING SERVICES TO ASSIST OTHERS IN DETERMINING AND IMPLEMENTING THEIR MISSION IN A RESPONSIBLE MANNER (U.S. CLS. 100, 101 AND 102).

COLLEEN KEARNEY, EXAMINING ATTORNEY

SN 78-840,332. ARENA, CHRISTINE, SAN FRANCISCO, CA. FILED 3-17-2006.

HIGH-PURPOSE

THE MARK CONSISTS OF STANDARD CHARACTERS WITHOUT CLAIM TO ANY PARTICULAR FONT, STYLE, SIZE, OR COLOR.

FOR BUSINESS CONSULTING SERVICES TO ASSIST OTHERS IN DETERMINING AND IMPLEMENTING THEIR MISSION IN A RESPONSIBLE MANNER (U.S. CLS. 100, 101 AND 102).

COLLEEN KEARNEY, EXAMINING ATTORNEY

SN 78-840,347. ARENA, CHRISTINE, SAN FRANCISCO, CA. FILED 3-17-2006.

HIGH-PURPOSE COMPANY

THE MARK CONSISTS OF STANDARD CHARACTERS WITHOUT CLAIM TO ANY PARTICULAR FONT, STYLE, SIZE, OR COLOR.

NO CLAIM IS MADE TO THE EXCLUSIVE RIGHT TO USE "COMPANY", APART FROM THE MARK AS SHOWN.

FOR BUSINESS CONSULTING SERVICES TO ASSIST OTHERS IN DETERMINING AND IMPLEMENTING THEIR MISSION IN A RESPONSIBLE MANNER (U.S. CLS. 100, 101 AND 102).

COLLEEN KEARNEY, EXAMINING ATTORNEY

CLASS 35—(Continued).

SN 78-842,136. MONAHAN, DEBORAH, DAWN, LEWIS-VILLE, TX. FILED 3-21-2006.

Organizing 101

THE MARK CONSISTS OF STANDARD CHARACTERS WITHOUT CLAIM TO ANY PARTICULAR FONT, STYLE, SIZE, OR COLOR.

NO CLAIM IS MADE TO THE EXCLUSIVE RIGHT TO USE "ORGANIZING", APART FROM THE MARK AS SHOWN.

FOR PROVIDING ORGANIZING SERVICES FOR BELONGINGS AND SPACES IN A RESIDENCE OR OFFICE SUCH AS PAPERS AND TIME; PROVIDING ORGANIZING SERVICES FOR INDIVIDUALS AT HOME, IN HOME OFFICES AND IN BUSINESS OFFICES, THAT PROVIDES HELP WITH TIME AND PAPER MANAGEMENT (U.S. CLS. 100, 101 AND 102).

FIRST USE 2-19-2000; IN COMMERCE 2-19-2000.
KATRINA EDGE, EXAMINING ATTORNEY

SN 78-842,431. PREVOST CAR INC., STE-CLAIRE, CANADA, FILED 3-21-2006.

PREVOST

THE MARK CONSISTS OF STANDARD CHARACTERS WITHOUT CLAIM TO ANY PARTICULAR FONT, STYLE, SIZE, OR COLOR.

OWNER OF U.S. REG. NOS. 2,752,950, 2,780,667 AND 2,989,529.

FOR RETAIL STORE AND DISTRIBUTORSHIP SERVICES FEATURING PARTS AND ACCESSORIES FOR BUSES (U.S. CLS. 100, 101 AND 102).

FIRST USE 3-0-1957; IN COMMERCE 7-0-1967.
DEIRDRE ROBERTSON, EXAMINING ATTORNEY

SN 78-842,493. PREVOST CAR INC., STE-CLAIRE, CANADA, FILED 3-21-2006.

PREVOST

OWNER OF U.S. REG. NOS. 2,752,950, 2,780,667 AND 2,989,529.

FOR RETAIL STORE AND DISTRIBUTORSHIP SERVICES FEATURING PARTS AND ACCESSORIES FOR BUSES (U.S. CLS. 100, 101 AND 102).

FIRST USE 3-0-1957; IN COMMERCE 7-0-1967.
DEIRDRE ROBERTSON, EXAMINING ATTORNEY

CLASS 35—(Continued).

SN 78-844,467. PCENTRAL.US, INC., URBAN DALE, IA. FILED 3-23-2006.

pcCentral

FOR DATA PROCESSING SERVICES (U.S. CLS. 100, 101 AND 102).

FIRST USE 7-1-2005; IN COMMERCE 7-1-2005.
BARNEY CHARLON, EXAMINING ATTORNEY

SN 78-844,521. IQ PIPELINE, LLC, SAN DIEGO, CA. FILED 3-23-2006.

The Smart Way To Staff

THE MARK CONSISTS OF STANDARD CHARACTERS WITHOUT CLAIM TO ANY PARTICULAR FONT, STYLE, SIZE, OR COLOR.

FOR EMPLOYMENT HIRING, RECRUITING, PLACEMENT, STAFFING AND CAREER NETWORKING SERVICES (U.S. CLS. 100, 101 AND 102).

FIRST USE 3-1-2006; IN COMMERCE 3-1-2006.
GINA FINK, EXAMINING ATTORNEY

SN 78-844,665. KAZI, ANWAR R., HONOLULU, HI. FILED 3-23-2006.

Homeslead

THE MARK CONSISTS OF STANDARD CHARACTERS WITHOUT CLAIM TO ANY PARTICULAR FONT, STYLE, SIZE, OR COLOR.

FOR DISSEMINATION OF ADVERTISING FOR REAL ESTATE AGENCIES AND OTHERS VIA A GLOBAL COMMUNICATION NETWORK AND MAGAZINE PUBLICATION (U.S. CLS. 100, 101 AND 102).

FIRST USE 3-1-2006; IN COMMERCE 3-7-2006.
DANIEL RUSSELL, EXAMINING ATTORNEY

CLASS 35—(Continued).

SN 78-844,845. LAROY, GARY J., OLD HICKORY, TN. FILED 3-23-2006.

Natural Path Marketing

THE MARK CONSISTS OF STANDARD CHARACTERS WITHOUT CLAIM TO ANY PARTICULAR FONT, STYLE, SIZE, OR COLOR.

NO CLAIM IS MADE TO THE EXCLUSIVE RIGHT TO USE "MARKETING", APART FROM THE MARK AS SHOWN.

FOR ADVERTISING AGENCIES, NAMELY, PROMOTING THE GOODS AND SERVICES OF OTHERS; ADVERTISING AND PROMOTION SERVICES AND RELATED CONSULTING; ADVERTISING SERVICES, NAMELY, CREATING CORPORATE AND BRAND IDENTITY FOR OTHERS; ADVERTISING, MARKETING AND PROMOTION SERVICES (U.S. CLS. 100, 101 AND 102).

FIRST USE 3-16-2006; IN COMMERCE 3-16-2006.
ROBERT STRUCK, EXAMINING ATTORNEY

SN 78-845,374. TOLEDO OPTICAL LABORATORY, INC., TOLEDO, OH. FILED 3-24-2006.

TOLEDO OPTICAL

THE MARK CONSISTS OF STANDARD CHARACTERS WITHOUT CLAIM TO ANY PARTICULAR FONT, STYLE, SIZE, OR COLOR.

OWNER OF U.S. REG. NO. 2,377,321.

NO CLAIM IS MADE TO THE EXCLUSIVE RIGHT TO USE "OPTICAL", APART FROM THE MARK AS SHOWN.

SEC. 2(F).

FOR RETAIL OPTICAL GOODS STORES (U.S. CLS. 100, 101 AND 102).

FIRST USE 2-0-1947; IN COMMERCE 2-0-1947.
LA TONIA FISHER, EXAMINING ATTORNEY

SN 78-845,714. MASON COMPANIES INC., CHIPPEWA FALLS, WI. FILED 3-24-2006.



OWNER OF U.S. REG. NOS. 2,605,442, 2,992,709 AND OTHERS.

FOR COMPUTERIZED ONLINE RETAIL STORE SERVICES IN THE FIELD OF FOOTWEAR, CLOTHING AND ACCESSORIES; MAIL ORDER CATALOG SERVICES FEATURING FOOTWEAR, CLOTHING AND ACCESSORIES (U.S. CLS. 100, 101 AND 102).

DAVID MILLER, EXAMINING ATTORNEY

CLASS 35—(Continued).

SN 78-846,412. KANRED HOLDINGS, LLC, DBA BIG BOSS GAMES, CAVE CREEK, AZ. FILED 3-27-2006.

BIG BOSS GAMES

THE MARK CONSISTS OF STANDARD CHARACTERS WITHOUT CLAIM TO ANY PARTICULAR FONT, STYLE, SIZE, OR COLOR.

NO CLAIM IS MADE TO THE EXCLUSIVE RIGHT TO USE "GAMES", APART FROM THE MARK AS SHOWN.

FOR RETAIL STORES FEATURING VIDEO AND COMPUTER GAME SOFTWARE AND ASSOCIATED EQUIPMENT AND ACCESSORIES, PRE-RECORDED DIGITAL ENTERTAINMENT MEDIA AND ASSOCIATED EQUIPMENT AND ACCESSORIES, PRE-RECORDED DIGITAL MUSIC AND ASSOCIATED EQUIPMENT AND ACCESSORIES, GAMES, PRINTED PUBLICATIONS, FOODSTUFFS, CLOTHING, TOYS, COLLECTIBLE FIGURES AND COMPUTER SOFTWARE AND HARDWARE; ONLINE RETAIL STORE SERVICES FEATURING VIDEO AND COMPUTER GAME SOFTWARE AND ASSOCIATED EQUIPMENT AND ACCESSORIES, PRE-RECORDED DIGITAL ENTERTAINMENT MEDIA AND ASSOCIATED EQUIPMENT AND ACCESSORIES, PRE-RECORDED DIGITAL MUSIC AND ASSOCIATED EQUIPMENT AND ACCESSORIES, GAMES, PRINTED PUBLICATIONS, FOODSTUFFS, CLOTHING, TOYS, COLLECTIBLE FIGURES AND COMPUTER SOFTWARE AND HARDWARE (U.S. CLS. 100, 101 AND 102).

FIRST USE 3-7-2005; IN COMMERCE 3-7-2005.
ALLISON HOLTZ, EXAMINING ATTORNEY

SN 78-846,599. NSF SERVICES INC., ROSEDALE, MD. FILED 3-27-2006.



THE APPLICANT CLAIMS COLOR AS A FEATURE OF THE MARK, NAMELY, BLUE AND ORANGE.

THE MARK CONSISTS OF THE LETTERS SYSQS. THE LETTERS "S," "Y," "S," AND "S" ARE TYPED FACED LETTERS IN BLUE. THE FOURTH LETTER "Q" IS STYLIZED AND CONSISTS OF THE SHAPE OF A SPHERE IN BLUE AND A TAIL IN ORANGE.

FOR ONLINE CONSIGNMENT SERVICES WHEREBY GOODS ARE RECEIVED ON CONSIGNMENT FOR AUCTION ON AN ONLINE AUCTION SITE (U.S. CLS. 100, 101 AND 102).

FIRST USE 2-27-2006; IN COMMERCE 2-27-2006.
ESTHER A. BORSUK, EXAMINING ATTORNEY

CLASS 35—(Continued).

SN 78-846,683. FRONT ROW MARKETING SERVICES, L.P., PHILADELPHIA, PA. FILED 3-27-2006.



NO CLAIM IS MADE TO THE EXCLUSIVE RIGHT TO USE "MARKETING SERVICES", APART FROM THE MARK AS SHOWN.

FOR PROMOTING THE GOODS AND SERVICES OF OTHERS BY ARRANGING FOR CORPORATE SPONSORS TO AFFILIATE THEIR GOODS AND SERVICES WITH SPORTING EVENTS AND SPORTS TEAMS, ARENAS, STADIUMS, AND OTHER PUBLIC ASSEMBLY FACILITIES, AND MUNICIPALLY-OWNED ASSETS AND PUBLIC AREAS; ADVERTISING SERVICES, NAMELY, ARRANGING OF CORPORATE SPONSORSHIP AND ADVERTISING FOR SPORTING EVENTS AND SPORTS TEAMS, ARENAS, STADIUMS, AND OTHER PUBLIC ASSEMBLY FACILITIES, AND MUNICIPALITIES; ADVERTISING SERVICES, NAMELY, CREATING CORPORATE AND BRAND IDENTITY FOR OTHERS THROUGH SPORTS MARKETING AND SPONSORSHIPS; CREATING CORPORATE SPONSORSHIP PROMOTIONAL AND MARKETING CAMPAIGNS FOR OTHERS; CONSULTING SERVICES IN THE AREA OF PROMOTIONS, MARKETING, AND ADVERTISING (U.S. CLS. 100, 101 AND 102).

FIRST USE 9-0-2005; IN COMMERCE 9-0-2005.
JENNIFER KRISP, EXAMINING ATTORNEY

SN 78-846,929. FRONT ROW MARKETING SERVICES, L.P., PHILADELPHIA, PA. FILED 3-27-2006.

**FRONT ROW MARKETING
SERVICES**

THE MARK CONSISTS OF STANDARD CHARACTERS WITHOUT CLAIM TO ANY PARTICULAR FONT, STYLE, SIZE, OR COLOR.

NO CLAIM IS MADE TO THE EXCLUSIVE RIGHT TO USE "MARKETING SERVICES", APART FROM THE MARK AS SHOWN.

FOR PROMOTING THE GOODS AND SERVICES OF OTHERS BY ARRANGING FOR CORPORATE SPONSORS TO AFFILIATE THEIR GOODS AND SERVICES WITH SPORTING EVENTS AND SPORTS TEAMS, ARENAS, STADIUMS, AND OTHER PUBLIC ASSEMBLY FACILITIES, AND MUNICIPALLY-OWNED ASSETS AND PUBLIC AREAS; ADVERTISING SERVICES, NAMELY, ARRANGING OF CORPORATE SPONSORSHIP AND ADVERTISING FOR SPORTING EVENTS AND SPORTS TEAMS, ARENAS, STADIUMS, AND OTHER PUBLIC ASSEMBLY FACILITIES, AND MUNICIPALITIES; ADVERTISING SERVICES, NAMELY, CREATING CORPORATE AND BRAND IDENTITY FOR OTHERS THROUGH SPORTS MARKETING AND SPONSORSHIPS; CREATING CORPORATE SPONSORSHIP PROMOTIONAL AND MARKETING CAMPAIGNS FOR OTHERS; CONSULTING SERVICES IN THE AREA OF PROMOTIONS, MARKETING, AND ADVERTISING (U.S. CLS. 100, 101 AND 102).

FIRST USE 2-0-1998; IN COMMERCE 2-0-1998.
JENNIFER KRISP, EXAMINING ATTORNEY

CLASS 35—(Continued).

SN 78-847,190. STOWE WOODWARD LLC, WESTBOROUGH, MA. FILED 3-27-2006.

OneTrac

THE MARK CONSISTS OF STANDARD CHARACTERS WITHOUT CLAIM TO ANY PARTICULAR FONT, STYLE, SIZE, OR COLOR.

FOR PROVIDING A DATABASE MANAGEMENT SYSTEM IN THE FIELD OF PAPERMAKING MACHINES, ROLLS, FABRICS AND EQUIPMENT USED IN PAPERMAKING MACHINES, NAMELY, PROVIDING TO CUSTOMERS A SECURE ONLINE DATABASE FOR ORDERING GOODS CAPABLE OF MAINTAINING ROLL AND FABRIC SPECIFICATIONS, TRACKING ROLL AND FABRIC PERFORMANCE AND HISTORY, MONITORING THE STATUS OF ALL SPARE ROLLS AND FABRICS, AND INTERACTING WITH HYPERLINKED MACHINE DRAWINGS TO FURNISH LEVELS OF DETAILS OF THE PAPER MACHINES, MACHINE SECTIONS AND INDIVIDUAL ROLLS AND FABRICS (U.S. CLS. 100, 101 AND 102).

DAYNA BROWNE, EXAMINING ATTORNEY

SN 78-847,256. JACQUIE JORDAN INC., LOS ANGELES, CA. FILED 3-27-2006.

TVGuestpert

THE MARK CONSISTS OF STANDARD CHARACTERS WITHOUT CLAIM TO ANY PARTICULAR FONT, STYLE, SIZE, OR COLOR.

SEC. 2(F).

FOR BUSINESS SERVICES, NAMELY, PROCURING QUALIFIED AND CREDENTIALLED THIRD-PARTY EXPERTS, PROFESSIONALS AND OTHER QUALIFIED PERSONNEL, FOR OTHERS, FOR MEDIA RELATED APPEARANCES (U.S. CLS. 100, 101 AND 102).

FIRST USE 3-22-2005; IN COMMERCE 3-22-2005.
EVELYN BRADLEY, EXAMINING ATTORNEY

CLASS 35—(Continued).

SN 78-847,419. TKTS, LLC, MESA, AZ. FILED 3-27-2006.

DragonFire Racing

THE MARK CONSISTS OF STANDARD CHARACTERS WITHOUT CLAIM TO ANY PARTICULAR FONT, STYLE, SIZE, OR COLOR.

NO CLAIM IS MADE TO THE EXCLUSIVE RIGHT TO USE "RACING", APART FROM THE MARK AS SHOWN.

FOR RETAIL STORE SERVICES AND WHOLESALE STORE SERVICES, RETAIL ONLINE ORDERING SERVICES AND WHOLESALE ONLINE ORDERING SERVICES, AND RETAIL AND WHOLESALE TELEPHONE ORDERING SERVICES ALL IN THE FIELD OF OFF-ROAD ACCESSORIES (U.S. CLS. 100, 101 AND 102).

FIRST USE 9-1-2005; IN COMMERCE 9-1-2005.

PAUL F. GAST, EXAMINING ATTORNEY

SN 78-849,031. DECISION INSIGHT, INC., KANSAS CITY, MO. FILED 3-29-2006.

SIMUSHOP

THE MARK CONSISTS OF STANDARD CHARACTERS WITHOUT CLAIM TO ANY PARTICULAR FONT, STYLE, SIZE, OR COLOR.

FOR MARKETING AND SALES RESEARCH SERVICES UTILIZING ONLINE SIMULATED RETAIL ENVIRONMENTS TO PREDICT AND STUDY CUSTOMER PREFERENCES AND PURCHASING PATTERNS (U.S. CLS. 100, 101 AND 102).

FIRST USE 0-0-2004; IN COMMERCE 6-30-2005.

SANI KHOURI, EXAMINING ATTORNEY

SN 78-849,176. T.A. SEEDS, LLC, JERSEY SHORE, PA. FILED 3-29-2006.

WE ARE FARMERS FIRST!

THE MARK CONSISTS OF STANDARD CHARACTERS WITHOUT CLAIM TO ANY PARTICULAR FONT, STYLE, SIZE, OR COLOR.

FOR RETAIL STORE SERVICES FEATURING SEEDS (U.S. CLS. 100, 101 AND 102).

FIRST USE 8-15-2005; IN COMMERCE 8-15-2005.

KATHRYN COWARD, EXAMINING ATTORNEY

CLASS 35—(Continued).

SN 78-849,650. BERKAHN, PETER REGINALD, SYDNEY, AUSTRALIA, FILED 3-30-2006.

be smarter than yourself

THE MARK CONSISTS OF STANDARD CHARACTERS WITHOUT CLAIM TO ANY PARTICULAR FONT, STYLE, SIZE, OR COLOR.

FOR ADVERTISING SERVICES, NAMELY, CREATING A CORPORATE AND BRANDING IDENTITY (U.S. CLS. 100, 101 AND 102).

JOHN SCHUYLER YARD, EXAMINING ATTORNEY

SN 78-850,384. KARA VITA, INC., ST. PETERSBURG, FL. FILED 3-30-2006.

SHARE THE PURPOSE, INSPIRE OTHERS

THE MARK CONSISTS OF STANDARD CHARACTERS WITHOUT CLAIM TO ANY PARTICULAR FONT, STYLE, SIZE, OR COLOR.

FOR ADVERTISING, MARKETING AND PROMOTION SERVICES; ADVICE IN THE FIELD OF BUSINESS MANAGEMENT AND MARKETING; ASSISTANCE IN MANAGEMENT OF BUSINESS ACTIVITIES; BUSINESS MARKETING SERVICES; DIRECT MARKETING SERVICES; MULTI-LEVEL MARKETING BUSINESS SERVICES (U.S. CLS. 100, 101 AND 102).

REBECCA GAN, EXAMINING ATTORNEY

SN 78-850,854. BAPTIST HEALTH VENTURES, INC., PENSACOLA, FL. FILED 3-31-2006.

Sustainability Survey

THE MARK CONSISTS OF STANDARD CHARACTERS WITHOUT CLAIM TO ANY PARTICULAR FONT, STYLE, SIZE, OR COLOR.

NO CLAIM IS MADE TO THE EXCLUSIVE RIGHT TO USE "SURVEY", APART FROM THE MARK AS SHOWN.

FOR BUSINESS RESEARCH AND SURVEYS (U.S. CLS. 100, 101 AND 102).

FIRST USE 7-1-2004; IN COMMERCE 8-1-2004.

BENJAMIN OKEKE, EXAMINING ATTORNEY

CLASS 35—(Continued).

SN 78-851,079. CREATIVE ANVIL, INC., ST. LOUIS, MO.
FILED 3-31-2006.

CREATIVE ANVIL

THE MARK CONSISTS OF STANDARD CHARACTERS WITHOUT CLAIM TO ANY PARTICULAR FONT, STYLE, SIZE, OR COLOR.
FOR ADVERTISING AND MARKETING (U.S. CLS. 100, 101 AND 102).
TRAVIS WHEATLEY, EXAMINING ATTORNEY

SN 78-851,732. HOT OFF THE PRESS, INC., CANBY, OR.
FILED 3-31-2006.

PAPER WISHES

THE MARK CONSISTS OF STANDARD CHARACTERS WITHOUT CLAIM TO ANY PARTICULAR FONT, STYLE, SIZE, OR COLOR.
NO CLAIM IS MADE TO THE EXCLUSIVE RIGHT TO USE "PAPER", APART FROM THE MARK AS SHOWN.
FOR MAIL ORDER CATALOG SERVICES FEATURING ARTS AND CRAFTS PRODUCTS (U.S. CLS. 100, 101 AND 102).
FIRST USE 2-0-2002; IN COMMERCE 2-0-2002.
IRENE D. WILLIAMS, EXAMINING ATTORNEY

SN 78-852,008. ALPERT, PAUL STEPHEN, MORGAN HILL, CA. FILED 4-1-2006.

TEN-FORTYLAND

THE MARK CONSISTS OF STANDARD CHARACTERS WITHOUT CLAIM TO ANY PARTICULAR FONT, STYLE, SIZE, OR COLOR.
FOR TAX ADVISORY SERVICES; TAX CONSULTATION; TAX FILING SERVICE; TAX PREPARATION; INCOME TAX PREPARATION (U.S. CLS. 100, 101 AND 102).
FIRST USE 0-0-2003; IN COMMERCE 0-0-2003.
SALLY SHIH, EXAMINING ATTORNEY

CLASS 35—(Continued).

SN 78-852,189. LOWMAN GROUP, INC., ATLANTA, GA.
FILED 4-3-2006.

FAME SPORTS

THE MARK CONSISTS OF STANDARD CHARACTERS WITHOUT CLAIM TO ANY PARTICULAR FONT, STYLE, SIZE, OR COLOR.
NO CLAIM IS MADE TO THE EXCLUSIVE RIGHT TO USE "SPORTS", APART FROM THE MARK AS SHOWN.
FOR RETAIL FOOTWEAR STORE SERVICES (U.S. CLS. 100, 101 AND 102).
FIRST USE 6-5-2003; IN COMMERCE 6-5-2003.
ELLEN BURNS, EXAMINING ATTORNEY

SN 78-852,247. SOUTHERN AUTO SALES, INC., EAST WINDSOR, CT. FILED 4-3-2006.

CARLOS

THE MARK CONSISTS OF STANDARD CHARACTERS WITHOUT CLAIM TO ANY PARTICULAR FONT, STYLE, SIZE, OR COLOR.
FOR COMPUTER SERVICES, NAMELY, PROVIDING AN ON-LINE DATABASE FEATURING AUTOMOBILES AVAILABLE FOR SALE (U.S. CLS. 100, 101 AND 102).
FIRST USE 12-0-1998; IN COMMERCE 3-0-1999.
FRANK LATTUCA, EXAMINING ATTORNEY

SN 78-852,422. TOWBIN, JOSHUA D., LAS VEGAS, NV.
FILED 4-3-2006.

CHOP

THE MARK CONSISTS OF STANDARD CHARACTERS WITHOUT CLAIM TO ANY PARTICULAR FONT, STYLE, SIZE, OR COLOR.
FOR AUTOMOBILE DEALERSHIPS; PROVIDING INFORMATION ABOUT AUTOMOBILES FOR SALE BY MEANS OF THE INTERNET; RETAIL SERVICES, NAMELY, DIRECT SOLICITATION BY SALES AGENTS IN CONNECTION WITH THE SALES OF NEW OR USED AUTOMOBILES (U.S. CLS. 100, 101 AND 102).
AMY GEARIN, EXAMINING ATTORNEY

CLASS 35—(Continued).

SN 78-852,427. TOWBIN, JOSHUA D., LAS VEGAS, NV.
FILED 4-3-2006.

CHOPPER

THE MARK CONSISTS OF STANDARD CHARACTERS WITHOUT CLAIM TO ANY PARTICULAR FONT, STYLE, SIZE, OR COLOR.

FOR AUTOMOBILE DEALERSHIPS; PROVIDING INFORMATION ABOUT AUTOMOBILES FOR SALE BY MEANS OF THE INTERNET; RETAIL SERVICES, NAMELY, DIRECT SOLICITATION BY SALES AGENTS IN CONNECTION WITH THE SALES OF NEW OR USED AUTOMOBILES (U.S. CLS. 100, 101 AND 102).

JANICE L. MCMORROW, EXAMINING ATTORNEY

SN 78-852,517. PIVOTPOINT SOLUTIONS, BRYAN, TX.
FILED 4-3-2006.



NO CLAIM IS MADE TO THE EXCLUSIVE RIGHT TO USE "SOLUTIONS", APART FROM THE MARK AS SHOWN.

FOR DATA MANAGEMENT AND STATISTICAL ANALYSIS CONSULTING FOR THE TELECOMMUNICATIONS INDUSTRY (U.S. CLS. 100, 101 AND 102).

FIRST USE 4-12-2005; IN COMMERCE 4-12-2005.
MICHELE SWAIN, EXAMINING ATTORNEY

SN 78-852,705. SCHOLASTIC INC., NEW YORK, NY. FILED
4-3-2006.

ULTIMATE SPY CLUB

THE MARK CONSISTS OF STANDARD CHARACTERS WITHOUT CLAIM TO ANY PARTICULAR FONT, STYLE, SIZE, OR COLOR.

NO CLAIM IS MADE TO THE EXCLUSIVE RIGHT TO USE "CLUB", APART FROM THE MARK AS SHOWN.

FOR MAIL ORDER BOOK CLUB SERVICES FEATURING BOOKS AND TOYS FOR CHILDREN (U.S. CLS. 100, 101 AND 102).

RICHARD A. STRASER, EXAMINING ATTORNEY

CLASS 35—(Continued).

SN 78-853,107. TRACKABOUT, INC., MOON TWP, PA.
FILED 4-4-2006.

TelemeTrack

THE MARK CONSISTS OF STANDARD CHARACTERS WITHOUT CLAIM TO ANY PARTICULAR FONT, STYLE, SIZE, OR COLOR.

FOR ON-LINE SERVICES, NAMELY, ORDERING AND INVENTORY MONITORING FOR INDUSTRIAL GASES AND LIQUIDS (U.S. CLS. 100, 101 AND 102).

MARTHA FROMM, EXAMINING ATTORNEY

SN 78-853,983. TUCKER, JOEL G., LOS ANGELES, CA.
FILED 4-4-2006.

DEVIOUS TOYS

NO CLAIM IS MADE TO THE EXCLUSIVE RIGHT TO USE TOYS, APART FROM THE MARK AS SHOWN.

THE MARK CONSISTS OF THE WORDS DEVIOUS AND TOYS IN A STYLIZED GOTHIC FONT.

FOR ON-LINE CATALOG, ORDERING AND RETAIL STORE SERVICES, FEATURING ADULT ENTERTAINMENT AND ADULT NOVELTIES, PRERECORDED VIDEO TAPES, DVDS, BOOKS, ADULT TOYS AND NOVELTIES, UNDERWEAR, LINGERIE, EROTIC CLOTHING AND COSTUMES (U.S. CLS. 100, 101 AND 102).

FIRST USE 1-9-1999; IN COMMERCE 12-2-2002.

LEIGH CAROLINE CASE, EXAMINING ATTORNEY

SN 78-853,988. TUCKER, JOEL G., LOS ANGELES, CA.
FILED 4-4-2006.

PleasureGear

FOR ON-LINE CATALOG, ORDERING AND RETAIL STORE SERVICES, FEATURING ADULT ENTERTAINMENT AND ADULT NOVELTIES, PRERECORDED VIDEO TAPES, DVDS, BOOKS, ADULT TOYS AND NOVELTIES, UNDERWEAR, LINGERIE, EROTIC CLOTHING AND COSTUMES (U.S. CLS. 100, 101 AND 102).

FIRST USE 10-6-2000; IN COMMERCE 10-6-2000.

LEIGH CAROLINE CASE, EXAMINING ATTORNEY

CLASS 35—(Continued).

SN 78-854,064. LARKIN, RICHARD L., CARLSBAD, CA.
FILED 4-5-2006.



NO CLAIM IS MADE TO THE EXCLUSIVE RIGHT TO USE THE REPRESENTATION OF THE DESIGN OF THE FINGERS AND "YELLOWPAGES.COM", APART FROM THE MARK AS SHOWN.

THE MARK CONSISTS OF A STYLIZED CAPITAL LETTER Q WITH A LINE FROM THE UPPER LEFT PORTION OF THE LETTER Q EXTENDING AS THE TAIL OF THE LETTER Q. INSIDE THE LETTER Q IS A OUTLINE OF A HAND SHOWING WALKING FINGERS. BELOW THE LETTER Q IN REVERSE TYPE IS THE WORD "QUITYELLOWPAGES.COM" USING DIFFERENT FONT TREATMENTS FOR PORTIONS OF THE WORD "QUIT", "YELLOWPAGES" AND ".COM".

FOR ADVERTISING AND ADVERTISEMENT SERVICES (U.S. CLS. 100, 101 AND 102).
FIRST USE 4-4-2006; IN COMMERCE 4-4-2006.
PAUL F. GAST, EXAMINING ATTORNEY

SN 78-854,398. ONVIA, INC., SEATTLE, WA. FILED 4-5-2006.

ONVIA DOMINION

THE MARK CONSISTS OF STANDARD CHARACTERS WITHOUT CLAIM TO ANY PARTICULAR FONT, STYLE, SIZE, OR COLOR.

OWNER OF U.S. REG. NOS. 2,564,106 AND 3,105,266.
FOR BUSINESS INFORMATION IN THE FIELD OF BUSINESS AND GOVERNMENTAL BID OPPORTUNITIES; BUSINESS INFORMATION SERVICES IN THE NATURE OF PROVIDING INFORMATION ON BUSINESS OPPORTUNITIES; PROVIDING AN ON-LINE COMPUTER DATABASE FEATURING TRADE INFORMATION IN THE FIELD OF BUSINESS AND GOVERNMENTAL BID OPPORTUNITIES (U.S. CLS. 100, 101 AND 102).

FIRST USE 4-3-2006; IN COMMERCE 4-3-2006.
PAUL F. GAST, EXAMINING ATTORNEY

CLASS 35—(Continued).

SN 78-854,417. LAXTON, JOHN, SANTA ROSA, CA. FILED 4-5-2006.

I-Capital

THE MARK CONSISTS OF STANDARD CHARACTERS WITHOUT CLAIM TO ANY PARTICULAR FONT, STYLE, SIZE, OR COLOR.

FOR PROVIDING A SEARCHABLE ONLINE ADVERTISING GUIDE FEATURING THE GOODS AND SERVICES OF OTHER ONLINE VENDORS ON THE INTERNET (U.S. CLS. 100, 101 AND 102).

FIRST USE 12-23-2003; IN COMMERCE 12-23-2003.
JIM RINGLE, EXAMINING ATTORNEY

SN 78-854,541. AMANDA L. RIDENOURE, VERO BEACH, FL. FILED 4-5-2006.



NO CLAIM IS MADE TO THE EXCLUSIVE RIGHT TO USE "STUDIOS", APART FROM THE MARK AS SHOWN.

THE COLOR(S) GREEN, WHITE AND BLUE IS/ARE CLAIMED AS A FEATURE OF THE MARK.

THE MARK CONSISTS OF GREEN SQUARE WITH WHITE S RUNNING THROUGH IT AND BLUE SQUARE IN UPPER RIGHT QUADRANT OF GREEN SQUARE. SQUARED STUDIOS IN CENTURY GOTHIC IN BLUE WITH "SQUARED" RUNNING ALONG TOP OF GREEN SQUARE AND "STUDIOS" ALONG RIGHT SIDE OF GREEN SQUARE.

FOR ADVERTISING AGENCIES; ADVERTISING AND ADVERTISEMENT SERVICES; ADVERTISING AND MARKETING; ADVERTISING, MARKETING AND PROMOTION SERVICES; COOPERATIVE ADVERTISING AND MARKETING; DEVELOPMENT OF MARKETING STRATEGIES AND CONCEPTS (U.S. CLS. 100, 101 AND 102).

FIRST USE 1-21-2006; IN COMMERCE 2-1-2006.
JOHN DWYER, EXAMINING ATTORNEY

CLASS 35—(Continued).

SN 78-854,610. AMANDA L. RIDENOURS, VERO BEACH, FL. FILED 4-5-2006.

business going in circles?
get squared away.

THE MARK CONSISTS OF STANDARD CHARACTERS WITHOUT CLAIM TO ANY PARTICULAR FONT, STYLE, SIZE, OR COLOR.

FOR ADVERTISING AGENCIES; ADVERTISING AGENCIES, NAMELY, PROMOTING THE GOODS AND SERVICES OF OTHERS; ADVERTISING AGENCIES, NAMELY, PROMOTING THE SERVICES OF OTHER BUSINESS THROUGH THE DISTRIBUTION OF PRINTED AND AUDIO PROMOTIONAL MATERIALS AND BY RENDERING SALES PROMOTION ADVICE; ADVERTISING AND ADVERTISEMENT SERVICES; ADVERTISING AND BUSINESS SERVICES, NAMELY SECURING AIRTIME ON ALL FORMS OF MEDIA COMMUNICATIONS STATIONS, SYSTEMS, NETWORKS, AND SERVICES FOR THE PURPOSE OF PROMOTING THE GOODS AND SERVICES OF OTHERS; ADVERTISING AND COMMERCIAL INFORMATION SERVICES, VIA THE INTERNET; ADVERTISING AND MARKETING; ADVERTISING AND PROMOTION SERVICES AND RELATED CONSULTING; ADVERTISING AND PUBLICITY SERVICES; ADVERTISING AND PUBLICITY SERVICES, NAMELY, PROMOTING THE GOODS, SERVICES, BRAND IDENTITY AND COMMERCIAL INFORMATION AND NEWS OF THIRD PARTIES THROUGH PRINT, AUDIO, VIDEO, DIGITAL AND ON-LINE MEDIUM; ADVERTISING CONSULTATION; ADVERTISING FLYER DISTRIBUTION; ADVERTISING SERVICES; ADVERTISING SERVICES, NAMELY, CREATING CORPORATE AND BRAND IDENTITY FOR OTHERS; ADVERTISING SERVICES, NAMELY, CREATING CORPORATE LOGOS FOR OTHERS; ADVERTISING THROUGH ALL PUBLIC COMMUNICATION MEANS; ADVERTISING VIA ELECTRONIC MEDIA AND SPECIFICALLY THE INTERNET; ADVERTISING, MARKETING AND PROMOTION SERVICES; COOPERATIVE ADVERTISING AND MARKETING; CREATING AND UPDATING ADVERTISING MATERIAL; MEDIATION OF ADVERTISING; PLACING ADVERTISEMENTS FOR OTHERS; PREPARATION AND REALIZATION OF MEDIA AND ADVERTISING PLANS AND CONCEPTS; PREPARATION OF CUSTOM ADVERTISEMENTS FOR OTHERS; PREPARATION OF CUSTOM OR NON-CUSTOM ADVERTISING FOR BUSINESSES FOR DISSEMINATION VIA THE WEB, CD OR DVD FOR OPTIONAL UPLOAD OR DOWNLOAD TO A COMPUTER; PREPARING ADVERTISEMENTS FOR OTHERS; PREPARING AND PLACING ADVERTISEMENTS FOR OTHERS; PREPARING AND PLACING OF ADVERTISEMENTS; PROMOTING, ADVERTISING AND MARKETING OF THE ON-LINE WEBSITES OF OTHERS; REAL ESTATE ADVERTISING SERVICES (U.S. CLS. 100, 101 AND 102).

JOHN DWYER, EXAMINING ATTORNEY

CLASS 35—(Continued).

SN 78-855,267. LOPEZ, ALFONSO, MIAMI, FL. FILED 4-6-2006.



NO CLAIM IS MADE TO THE EXCLUSIVE RIGHT TO USE "LATIN AMERICAN BROADCAST SHOW", APART FROM THE MARK AS SHOWN.

THE MARK CONSISTS OF A STYLIZED REPRESENTATION OF THE AMERICAN CONTINENTS USING DIFFERENT SIZED DOTS. A LINE EMANATES HORIZONTALLY, AND TO THE RIGHT OF THE REPRESENTATION, FROM THE DOT REPRESENTING FLORIDA. THIS LINE SEPARATES THE SUPERIOR TERM "LABS" AND FROM THE INFERIOR TERMS "LATIN AMERICAN BROADCAST SHOW". TO THE RIGHT OF THOSE TERMS, THE LINE IS INTERSECTED BY A STYLIZED WAVE AND ENDS IN ANOTHER DOT. THE COLOR GRAY IS NOT CLAIMED AS A FEATURE OF THE MARK.

FOR PROMOTING AND CONDUCTING TRADE SHOWS IN THE FIELD OF BROADCAST COMMUNICATIONS (U.S. CLS. 100, 101 AND 102).

FIRST USE 2-1-2006; IN COMMERCE 2-1-2006.

ELLEN B. AWRICH, EXAMINING ATTORNEY

SN 78-855,285. KATHY'S TREASURES, NAUGATUCK, CT. FILED 4-6-2006.



THE MARK CONSISTS OF THE WORDS APPEAR IN A STYLIZED FONT. THE APOSTROPHE IN THE WORD KATHY'S APPEARS AS A FLOWER AND THERE IS ALSO A FLOWER UNDER THE LETTER S IN THE WORD TREASURES.

FOR ON-LINE RETAIL STORE SERVICES FEATURING CLOTHING FOR PLUS SIZED WOMEN; RETAIL CLOTHING STORES (U.S. CLS. 100, 101 AND 102).

FIRST USE 4-11-2005; IN COMMERCE 4-11-2005.

WILLIAM P. SHANAHAN, EXAMINING ATTORNEY

CLASS 35—(Continued).

SN 78-855,504. PLYWOOD AND LUMBER SALES INC., OAKLAND, CA. FILED 4-6-2006.

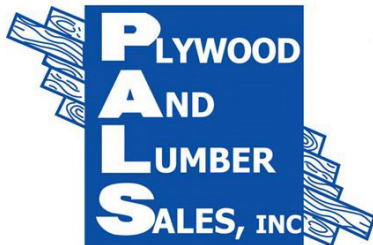

NO CLAIM IS MADE TO THE EXCLUSIVE RIGHT TO USE "PLYWOOD AND LUMBER SALES, INC.", APART FROM THE MARK AS SHOWN.

THE COLOR(S) BLUE AND WHITE IS/ARE CLAIMED AS A FEATURE OF THE MARK.

THE MARK CONSISTS OF 5 PIECES OF WOOD LAYED AT AN ANGLE WITH A BLUE RECTANGLE OVER IT WITH THE WORDS PLYWOOD AND LUMBER SALES, INC IN WHITE ON IT.

FOR WHOLESALE DISTRIBUTORSHIP FEATURING FSC CERTIFIED LUMBER, HARDWOOD, SOFTWOOD, WOOD PANELS, AND OTHER WOOD PRODUCTS (U.S. CLS. 100, 101 AND 102).

FIRST USE 12-7-1983; IN COMMERCE 12-7-1983.
CAROLYN GRAY, EXAMINING ATTORNEY

SN 78-855,781. STERLING REPUTATION, INC., SUNRISE, FL. FILED 4-6-2006.

STERLING REPUTATION

THE MARK CONSISTS OF STANDARD CHARACTERS WITHOUT CLAIM TO ANY PARTICULAR FONT, STYLE, SIZE, OR COLOR.

FOR WHOLESALE DISTRIBUTORSHIP FEATURING JEWELRY (U.S. CLS. 100, 101 AND 102).

FIRST USE 1-10-2000; IN COMMERCE 1-10-2000.
AMY MCMENAMIN, EXAMINING ATTORNEY

SN 78-855,829. TPI HOLDINGS, INC., NORFOLK, VA. FILED 4-6-2006.

SAILBOATTRADERONLINE.COM

THE MARK CONSISTS OF STANDARD CHARACTERS WITHOUT CLAIM TO ANY PARTICULAR FONT, STYLE, SIZE, OR COLOR.

FOR PREPARING AND DISSEMINATING ADVERTISING FOR OTHERS VIA ELECTRONIC MEDIA (U.S. CLS. 100, 101 AND 102).

FIRST USE 1-1-2001; IN COMMERCE 1-1-2001.
NORA BUCHANAN WILL, EXAMINING ATTORNEY

CLASS 35—(Continued).

SN 78-856,069. SKY FACET LLC, NEW YORK, NY. FILED 4-6-2006.

A Diamond is Worth a Thousand Feelings

THE MARK CONSISTS OF STANDARD CHARACTERS WITHOUT CLAIM TO ANY PARTICULAR FONT, STYLE, SIZE, OR COLOR.

FOR RETAIL JEWELRY STORES (U.S. CLS. 100, 101 AND 102).

FIRST USE 11-13-2004; IN COMMERCE 11-13-2004.
DAVID ELTON, EXAMINING ATTORNEY

SN 78-856,275. RENAE GAGEN, BLOOMFIELD, NJ. FILED 4-7-2006.

EXPECTING FASHION

THE MARK CONSISTS OF STANDARD CHARACTERS WITHOUT CLAIM TO ANY PARTICULAR FONT, STYLE, SIZE, OR COLOR.

NO CLAIM IS MADE TO THE EXCLUSIVE RIGHT TO USE "FASHION", APART FROM THE MARK AS SHOWN.

FOR ONLINE RETAIL STORE SERVICES FEATURING MATERNITY WEAR AND ACCESSORIES (U.S. CLS. 100, 101 AND 102).

HEATHER THOMPSON, EXAMINING ATTORNEY

SN 78-856,606. THE COSTUME CITY, INC., TUKWILA, WA. FILED 4-7-2006.

COSTUME CITY

THE MARK CONSISTS OF STANDARD CHARACTERS WITHOUT CLAIM TO ANY PARTICULAR FONT, STYLE, SIZE, OR COLOR.

NO CLAIM IS MADE TO THE EXCLUSIVE RIGHT TO USE "COSTUME", APART FROM THE MARK AS SHOWN.

FOR RETAIL COSTUME SUPERSTORE SPECIALIZING IN HALLOWEEN, PART, SCHOOL PLAY AND SIMILAR OCCASION COSTUMES (U.S. CLS. 100, 101 AND 102).

FIRST USE 3-1-2004; IN COMMERCE 3-1-2004.
TANYA AMOS, EXAMINING ATTORNEY

CLASS 35—(Continued).

SN 78-856,739. DEVON ENERGY CORPORATION, OKLAHOMA CITY, OK. FILED 4-7-2006.

WISE EYES

THE MARK CONSISTS OF STANDARD CHARACTERS WITHOUT CLAIM TO ANY PARTICULAR FONT, STYLE, SIZE, OR COLOR.

FOR CONDUCTING NATIONWIDE ADVERTISING CAMPAIGNS FOR OTHERS, WHICH PROMOTE VOLUNTARY CITIZEN ACTIONS PERTAINING TO, AND PUBLIC UNDERSTANDING OF, CRIME PREVENTION (U.S. CLS. 100, 101 AND 102).

FIRST USE 12-31-1993; IN COMMERCE 12-31-1993.
JAMES MACFARLANE, EXAMINING ATTORNEY

CLASS 35—(Continued).

SN 78-856,797. DEVON ENERGY CORPORATION, OKLAHOMA CITY, OK. FILED 4-7-2006.



THE MARK CONSISTS OF A STYLIZED DEPICTION OF A MOON WITH THE WORDS "WISE EYES" PRINTED WITHIN THE MOON. TO THE UPPER RIGHT AND BREAKING THROUGH THE EDGE OF THE MOON IS A STYLIZED DEPICTION OF AN OWL, WITH WINGS SPREAD.

FOR CONDUCTING NATIONWIDE ADVERTISING CAMPAIGNS FOR OTHERS, WHICH PROMOTE VOLUNTARY CITIZEN ACTIONS PERTAINING TO, AND PUBLIC UNDERSTANDING OF, CRIME PREVENTION (U.S. CLS. 100, 101 AND 102).

FIRST USE 12-31-1993; IN COMMERCE 12-31-1993.
JAMES MACFARLANE, EXAMINING ATTORNEY

SN 78-856,742. NET FRAMEWORK TECHNOLOGIES, INC., IRVINE, CA. FILED 4-7-2006.

LEADEX

THE MARK CONSISTS OF STANDARD CHARACTERS WITHOUT CLAIM TO ANY PARTICULAR FONT, STYLE, SIZE, OR COLOR.

FOR PROVIDING A WEB SITE FOR THE ORGANIZATION, PURCHASE AND TRANSFER OF SALES AND MARKETING DATA RELATING TO PROSPECTIVE CUSTOMERS; COMPUTERIZED COLLECTION, PROCESSING AND SHARING OF LEADS AMONG SUBSCRIBERS; COMPUTERIZED LEAD EXPEDITING SERVICES, NAMELY, CENTRALIZED, NETWORK-BASED DATA COLLECTION, PROCESSING AND RETRIEVAL SERVICES IN THE FIELD OF SALES AND MARKETING LEADS; AND PROVIDING SALES LEADS FOR OTHERS (U.S. CLS. 100, 101 AND 102).

LA TONIA FISHER, EXAMINING ATTORNEY

SN 78-856,818. TRUVEON CORPORATION, DURHAM, NC. FILED 4-7-2006.

TruMetrics

SN 78-856,765. KICKSTAND TECHNOLOGIES, INC., ENGLEWOOD, CO. FILED 4-7-2006.

Office Stand

THE MARK CONSISTS OF STANDARD CHARACTERS WITHOUT CLAIM TO ANY PARTICULAR FONT, STYLE, SIZE, OR COLOR.

FOR VENDING MACHINE SERVICES (U.S. CLS. 100, 101 AND 102).

PAM WILLIS, EXAMINING ATTORNEY

THE MARK CONSISTS OF STANDARD CHARACTERS WITHOUT CLAIM TO ANY PARTICULAR FONT, STYLE, SIZE, OR COLOR.

FOR COLLECTION, PREPARATION, COMPOSITION, STORAGE, PROCESSING, ACQUISITION AND PROVISION OF BUSINESS INFORMATION, DATA, STATISTICS AND INDICES IN THE CLIMATE CONTROL SYSTEM AND BUILDING AUTOMATION INDUSTRY; PROVIDING STATISTICAL INFORMATION IN THE CLIMATE CONTROL SYSTEM AND BUILDING AUTOMATION INDUSTRY (U.S. CLS. 100, 101 AND 102).

JASON LOTT, EXAMINING ATTORNEY

CLASS 35—(Continued).

SN 78-856,905. GOOD IDEA LLC, SUNRISE, FL. FILED 4-7-2006.

DISCOVER AND WINNER

THE MARK CONSISTS OF STANDARD CHARACTERS WITHOUT CLAIM TO ANY PARTICULAR FONT, STYLE, SIZE, OR COLOR.

FOR ONLINE RETAIL STORE SERVICES AND RETAIL STORE SERVICES FEATURING CLOTHING, HOUSEWARES, APPLIANCES, ELECTRONICS, JEWELRY, VEHICLES AND TRAVEL (U.S. CLS. 100, 101 AND 102).

KIMBERLY PERRY, EXAMINING ATTORNEY

CLASS 35—(Continued).

SN 78-858,560. KOKOLAKIS, JOSEPH, JOHN, TARPON SPRINGS, FL. FILED 4-11-2006.

PANTHEON AIRWAYS

THE MARK CONSISTS OF STANDARD CHARACTERS WITHOUT CLAIM TO ANY PARTICULAR FONT, STYLE, SIZE, OR COLOR.

NO CLAIM IS MADE TO THE EXCLUSIVE RIGHT TO USE "AIRWAYS", APART FROM THE MARK AS SHOWN, FOR MANAGEMENT OF AN AIRLINE COMPANY (U.S. CLS. 100, 101 AND 102).

CATHERINE FAINT, EXAMINING ATTORNEY

SN 78-857,848. INCOGNITO, ROYAL OAK, MI. FILED 4-10-2006.

INCOGNITO

THE MARK CONSISTS OF STANDARD CHARACTERS WITHOUT CLAIM TO ANY PARTICULAR FONT, STYLE, SIZE, OR COLOR.

OWNER OF U.S. REG. NOS. 1,775,085 AND 1,775,086. FOR RETAIL SHOPS FEATURING SUNGLASSES, JEWELRY, ACCESSORIES, BAGS, BELTS, HAIR ORNAMENTS, HOSIERY, GLOVES, MILLINERY, MUSIC, MUSIC RELATED ITEMS, BOOKS, VIDEOS, GIFT ITEMS (U.S. CLS. 100, 101 AND 102).

FIRST USE 10-1-1982; IN COMMERCE 10-1-1982. LINDA LAVACHE, EXAMINING ATTORNEY

SN 78-859,136. JILLIAN CHASE CORP., WELLESLEY, MA. FILED 4-11-2006.

HAZEL & GRACE

THE MARK CONSISTS OF STANDARD CHARACTERS WITHOUT CLAIM TO ANY PARTICULAR FONT, STYLE, SIZE, OR COLOR.

FOR RETAIL CLOTHING STORES (U.S. CLS. 100, 101 AND 102).

FIRST USE 8-1-2005; IN COMMERCE 8-1-2005.

THEODORE MCBRIDE, EXAMINING ATTORNEY

SN 78-858,450. TOUCHÉ, LLC, MIFFLINBURG, PA. FILED 4-11-2006.



THE MARK CONSISTS OF THE STYLIZED LETTERING "TOUCHE.COM". AN EXCLAMATION POINT TAKES THE PLACE OF THE ACCENT OVER THE "E" IN TOUCHE. THE WORD TOUCHE IS UNDERLINED WITH A SCRIBBLE DESIGN.

FOR DISSEMINATION OF ADVERTISING FOR OTHERS VIA THE INTERNET (U.S. CLS. 100, 101 AND 102).

SANDRA MANIOS, EXAMINING ATTORNEY

SN 78-859,362. BCM, LLC, SMITHTOWN, NY. FILED 4-11-2006.



NO CLAIM IS MADE TO THE EXCLUSIVE RIGHT TO USE MARKETING GROUP, APART FROM THE MARK AS SHOWN.

FOR MARKETING SERVICES RELATED TO COMPANY PROMOTIONS, ADVERTISING, MEDIA, COLLATERAL PRODUCTION, BRAND STRATEGIES AND TRADITIONAL MARKETING RESEARCH/SERVICES (U.S. CLS. 100, 101 AND 102).

FIRST USE 4-20-2005; IN COMMERCE 4-20-2005.

CHRIS WELLS, EXAMINING ATTORNEY

CLASS 35—(Continued).

SN 78-859,365. GOLDEN GATE DEPOT LLC, SAN RAMON, CA. FILED 4-11-2006.

Golden Gate Depot

THE MARK CONSISTS OF STANDARD CHARACTERS WITHOUT CLAIM TO ANY PARTICULAR FONT, STYLE, SIZE, OR COLOR.

FOR RETAIL STORES FEATURING MODEL TRAINS AND ACCESSORIES; WHOLESALE STORES FEATURING MODEL TRAINS AND ACCESSORIES (U.S. CLS. 100, 101 AND 102).

FIRST USE 12-12-1990; IN COMMERCE 12-12-1990.
CHRIS WELLS, EXAMINING ATTORNEY

SN 78-859,564. PROORBIS, LLC, MALVERN, PA. FILED 4-12-2006.

TCAM

THE MARK CONSISTS OF STANDARD CHARACTERS WITHOUT CLAIM TO ANY PARTICULAR FONT, STYLE, SIZE, OR COLOR.

OWNER OF U.S. REG. NO. 2,468,397.
FOR BUSINESS CONSULTING SERVICES FOR VALUATION AND MANAGEMENT OF BUSINESS ASSETS, CONDUCTING BUSINESS RESEARCH, AND SURVEYS FOR VALUATION AND MANAGEMENT OF ASSETS (U.S. CLS. 100, 101 AND 102).

GINA FINK, EXAMINING ATTORNEY

SN 78-859,575. PROORBIS, LLC, MALVERN, PA. FILED 4-12-2006.

PCAM

THE MARK CONSISTS OF STANDARD CHARACTERS WITHOUT CLAIM TO ANY PARTICULAR FONT, STYLE, SIZE, OR COLOR.

OWNER OF U.S. REG. NO. 2,468,397.
FOR BUSINESS CONSULTING SERVICES FOR VALUATION AND MANAGEMENT OF BUSINESS ASSETS, CONDUCTING BUSINESS RESEARCH, AND SURVEYS FOR VALUATION AND MANAGEMENT OF ASSETS (U.S. CLS. 100, 101 AND 102).

GINA FINK, EXAMINING ATTORNEY

CLASS 35—(Continued).

SN 78-859,653. THE ENDURANCE GROUP, YARMOUTH, ME. FILED 4-12-2006.

THE ENDURANCE GROUP

THE MARK CONSISTS OF STANDARD CHARACTERS WITHOUT CLAIM TO ANY PARTICULAR FONT, STYLE, SIZE, OR COLOR.

NO CLAIM IS MADE TO THE EXCLUSIVE RIGHT TO USE "GROUP", APART FROM THE MARK AS SHOWN.

FOR OUTSOURCING IN THE FIELD OF BUSINESS DEVELOPMENT, SALES AND MARKETING (U.S. CLS. 100, 101 AND 102).

FIRST USE 10-30-2002; IN COMMERCE 10-30-2002.
SUNG IN, EXAMINING ATTORNEY

SN 78-859,986. KAVI, INC., CORINTH, NY. FILED 4-12-2006.

CLIK

THE MARK CONSISTS OF STANDARD CHARACTERS WITHOUT CLAIM TO ANY PARTICULAR FONT, STYLE, SIZE, OR COLOR.

FOR ON-LINE RETAIL STORE SERVICES FEATURING BOOKLETS, SHIRTS, HATS, BAGS, AND BUMPER STICKERS; RETAIL STORES FEATURING BOOKLETS, SHIRTS, HATS, BAGS, AND BUMPER STICKERS (U.S. CLS. 100, 101 AND 102).

PAM WILLIS, EXAMINING ATTORNEY

SN 78-860,498. PERSPECTIVES/THE CONSULTING GROUP, INC., LOS ANGELES, CA. FILED 4-12-2006.

CHOCLATIQUE

THE MARK CONSISTS OF STANDARD CHARACTERS WITHOUT CLAIM TO ANY PARTICULAR FONT, STYLE, SIZE, OR COLOR.

FOR WHOLESALE AND RETAIL STORES FEATURING CANDY AND CONFECTIONS (U.S. CLS. 100, 101 AND 102).

FIRST USE 8-27-2004; IN COMMERCE 8-12-2005.
DAVID TAYLOR, EXAMINING ATTORNEY

CLASS 35—(Continued).

SN 78-860,577. DOT FOODS, INC., MT. STERLING, IL.
FILED 4-13-2006.

DOT

THE MARK CONSISTS OF STANDARD CHARACTERS WITHOUT CLAIM TO ANY PARTICULAR FONT, STYLE, SIZE, OR COLOR.

OWNER OF U.S. REG. NOS. 1,749,051, 3,076,574 AND OTHERS.

FOR WHOLESALE FOOD DISTRIBUTORSHIP SERVICES (U.S. CLS. 100, 101 AND 102).

FIRST USE 11-25-1991; IN COMMERCE 11-25-1991.
KATRINA EDGE, EXAMINING ATTORNEY

CLASS 35—(Continued).

SN 78-860,703. THE ARC OF DAVIDSON COUNTY, NASHVILLE, TN. FILED 4-13-2006.

"WE'RE ABOUT PEOPLE"

THE MARK CONSISTS OF STANDARD CHARACTERS WITHOUT CLAIM TO ANY PARTICULAR FONT, STYLE, SIZE, OR COLOR.

FOR ASSOCIATION SERVICES, NAMELY, PROMOTING THE INTERESTS AND WELFARE OF MENTALLY HANDICAPPED CITIZENS (U.S. CLS. 100, 101 AND 102).
FIRST USE 11-1-2005; IN COMMERCE 11-1-2005.

JEFFERY COWARD, EXAMINING ATTORNEY

SN 78-860,641. AMP CALIFORNIA, INC., COSTA MESA, CA.
FILED 4-13-2006.

i SOURCING

THE MARK CONSISTS OF STANDARD CHARACTERS WITHOUT CLAIM TO ANY PARTICULAR FONT, STYLE, SIZE, OR COLOR.

FOR ARCHITECTURAL, ENGINEERING, AND CONSTRUCTION OUTSOURCING SERVICES (U.S. CLS. 100, 101 AND 102).

MARGERY A. TIERNEY, EXAMINING ATTORNEY

SN 78-860,824. CAR WORLD, INC., ALBUQUERQUE, NM.
FILED 4-13-2006.

GOT A JOB? GET A CAR!

THE MARK CONSISTS OF STANDARD CHARACTERS WITHOUT CLAIM TO ANY PARTICULAR FONT, STYLE, SIZE, OR COLOR.

FOR AUTOMOBILE DEALERSHIPS AND RETAIL STORE SERVICES FEATURING AUTOMOBILES, TRUCKS, VANS, SUVS, AND AUTOMOBILE PARTS (U.S. CLS. 100, 101 AND 102).

FIRST USE 4-15-2005; IN COMMERCE 4-15-2005.
PAMELA HIRSCHMAN, EXAMINING ATTORNEY

SN 78-860,648. SIMONTON BUILDING PRODUCTS, INC., PARKERSBURG, WV. FILED 4-13-2006.

EPOPS

THE MARK CONSISTS OF STANDARD CHARACTERS WITHOUT CLAIM TO ANY PARTICULAR FONT, STYLE, SIZE, OR COLOR.

FOR ON-LINE ELECTRONIC ORDERING SERVICE FOR NON-METAL WINDOWS AND COMPONENTS THEREOF (U.S. CLS. 100, 101 AND 102).

FIRST USE 9-30-1996; IN COMMERCE 9-30-1996.
PAMELA HIRSCHMAN, EXAMINING ATTORNEY

SN 78-861,349. MYHUCKLEBERRY.COM, INC., REDMOND, WA. FILED 4-13-2006.

myhuckleberry.com

THE MARK CONSISTS OF STANDARD CHARACTERS WITHOUT CLAIM TO ANY PARTICULAR FONT, STYLE, SIZE, OR COLOR.

FOR OPERATING ON-LINE MARKETPLACES FOR SELLERS OF GOODS AND/OR SERVICES (U.S. CLS. 100, 101 AND 102).

VERNA BETH RIRIE, EXAMINING ATTORNEY

CLASS 35—(Continued).

SN 78-861,401. BARTER AMERICAS, INC., FAYETTEVILLE, AR. FILED 4-13-2006.

BANX

THE MARK CONSISTS OF STANDARD CHARACTERS WITHOUT CLAIM TO ANY PARTICULAR FONT, STYLE, SIZE, OR COLOR.

FOR EXCHANGE SERVICES, NAMELY BARTERING OF GOODS FOR OTHERS; SERVICES RENDERED BY A FRANCHISOR, NAMELY ASSISTANCE IN THE RUNNING OR MANAGEMENT OF INDUSTRIAL OR COMMERCIAL ENTERPRISES (U.S. CLS. 100, 101 AND 102).
FIRST USE 4-1-2006; IN COMMERCE 4-7-2006.

ELIZABETH J. WINTER, EXAMINING ATTORNEY

SN 78-861,512. ASBURY AUTOMOTIVE GROUP, INC., NEW YORK, NY. FILED 4-14-2006.

GRAY-DANIELS

THE MARK CONSISTS OF STANDARD CHARACTERS WITHOUT CLAIM TO ANY PARTICULAR FONT, STYLE, SIZE, OR COLOR.

FOR AUTOMOBILE DEALERSHIPS (U.S. CLS. 100, 101 AND 102).

FIRST USE 4-0-2000; IN COMMERCE 4-0-2000.
JOANNA DUKOVIC, EXAMINING ATTORNEY

SN 78-861,654. FOOD PANTRY, LTD., HONOLULU, HI. FILED 4-14-2006.



FOR RETAIL SERVICES FEATURING CANDY, CONFECTIONERY, AND GIFT ITEMS (U.S. CLS. 100, 101 AND 102).

MATTHEW MCDOWELL, EXAMINING ATTORNEY

CLASS 35—(Continued).

SN 78-861,796. SALESTRAX, L.L.C., OVERLAND PARK, KS. FILED 4-14-2006.

SALESTRAX

THE MARK CONSISTS OF STANDARD CHARACTERS WITHOUT CLAIM TO ANY PARTICULAR FONT, STYLE, SIZE, OR COLOR.

FOR EMPLOYMENT HIRING, RECRUITMENT, PLACEMENT, STAFFING, AND CAREER NETWORKING SERVICES; ORGANIZING AND CONDUCTING JOB FAIRS; PROVIDING FEE BASED DIRECT PLACEMENT SERVICES; PROVIDING ON-LINE INFORMATION IN THE FIELDS OF EMPLOYMENT, RECRUITMENT, CAREERS, PERSONAL ISSUES RELATED TO CAREERS AND WORK LIFE, JOB RESOURCES, JOB LISTINGS, AND RESUMES; PROVIDING ON-LINE INTERACTIVE EMPLOYMENT JOB POSTING AND RESUME DATABASE ACCESS SERVICES VIA A GLOBAL COMPUTER NETWORK (U.S. CLS. 100, 101 AND 102).

FIRST USE 1-12-1999; IN COMMERCE 1-12-1999.
PAMELA HIRSCHMAN, EXAMINING ATTORNEY

SN 78-861,976. THE SOCK COMPANY, INC., WESTWOOD, NJ. FILED 4-14-2006.

MOAB

THE MARK CONSISTS OF STANDARD CHARACTERS WITHOUT CLAIM TO ANY PARTICULAR FONT, STYLE, SIZE, OR COLOR.

FOR RETAIL STORE AND ONLINE RETAIL STORE SERVICES IN THE FIELDS OF CLOTHING, CAMPING GEAR, SPORTING GOODS, CYCLING GEAR, BOATING GEAR, CANOEING GEAR, HIKING GEAR, PET GOODS, RUNNING AND FITNESS GOODS, EYEWEAR, LUGGAGE, WATCHES, CLIMBING GEAR (U.S. CLS. 100, 101 AND 102).

ADA HAN, EXAMINING ATTORNEY

CLASS 35—(Continued).

SN 78-862,052. CROUCIER, ANTHONY E., LONG BEACH, CA. FILED 4-14-2006.



THE MARK CONSISTS OF STYLIZED LETTERS "AU" AND UNDERNEATH IS THE STYLIZED WORDS "ABSOLUTELYU".

FOR RETAIL STORES, NAMELY, ON-LINE RETAIL STORES FEATURING LEATHER CASES, SCREEN PROTECTORS AND OTHER RELATED DEVICES THAT PERTAIN TO SUSPENSION OF PORTABLE ELECTRONIC EQUIPMENT (U.S. CLS. 100, 101 AND 102).

FIRST USE 12-15-2005; IN COMMERCE 3-2-2006.
ANDREA K. NADELMAN, EXAMINING ATTORNEY

SN 78-862,167. SANDERBECK, RAYMOND, J, MEDINA, OH. FILED 4-14-2006.

MICHELLE'S LEADING STAR

THE MARK CONSISTS OF STANDARD CHARACTERS WITHOUT CLAIM TO ANY PARTICULAR FONT, STYLE, SIZE, OR COLOR.

FOR PROMOTING PUBLIC AWARENESS OF THE NEED FOR EDUCATING THE IMPORTANCE OF SAFE DRIVING ESPECIALLY AMONG NEWLY LICENSED DRIVERS (U.S. CLS. 100, 101 AND 102).

JESSICA A. POWERS, EXAMINING ATTORNEY

SN 78-862,221. GOODRICH, JAMES C., NEW YORK CITY, NY. FILED 4-14-2006.

Metropolist

THE MARK CONSISTS OF STANDARD CHARACTERS WITHOUT CLAIM TO ANY PARTICULAR FONT, STYLE, SIZE, OR COLOR.

FOR PROVIDING TELEPHONE DIRECTORY INFORMATION VIA GLOBAL COMMUNICATIONS NETWORKS; PROVIDING AN ONLINE INTERACTIVE WEBSITE OBTAINING USER FEEDBACK CONCERNING LOCAL BUSINESSES AND OTHER RESOURCES; PROVIDING INFORMATION INCLUDING COMPILATIONS, RANKINGS, RATINGS, AND REVIEWS RELATING TO THESE LOCAL BUSINESSES AND OTHER RESOURCES USING A GLOBAL COMPUTER NETWORK (U.S. CLS. 100, 101 AND 102).

IRENE D. WILLIAMS, EXAMINING ATTORNEY

CLASS 35—(Continued).

SN 78-862,315. NANOVOLTAIX, INC., SCOTTSDALE, AZ. FILED 4-15-2006.

NanoVoltaix

THE MARK CONSISTS OF STANDARD CHARACTERS WITHOUT CLAIM TO ANY PARTICULAR FONT, STYLE, SIZE, OR COLOR.

FOR MANAGEMENT AND BUSINESS CONSULTING SERVICES IN THE FIELD OF NANOTECHNOLOGY (U.S. CLS. 100, 101 AND 102).

FIRST USE 3-24-2006; IN COMMERCE 3-24-2006.
JENNIFER VASQUEZ, EXAMINING ATTORNEY

SN 78-862,455. GERBER, MALINDA D., MORAGA, CA. FILED 4-17-2006.

PHILANTHROBUCKS

THE MARK CONSISTS OF STANDARD CHARACTERS WITHOUT CLAIM TO ANY PARTICULAR FONT, STYLE, SIZE, OR COLOR.

FOR CHARITABLE SERVICES, NAMELY ORGANIZING AND CONDUCTING VOLUNTEER PROGRAMS AND COMMUNITY SERVICE PROJECTS (U.S. CLS. 100, 101 AND 102).

LAURA KOVALSKY, EXAMINING ATTORNEY

SN 78-862,479. INETA (INTERNATIONAL .NET ASSOCIATION), BELLEVUE, WA. FILED 4-17-2006.

The Best Are Here

THE MARK CONSISTS OF STANDARD CHARACTERS WITHOUT CLAIM TO ANY PARTICULAR FONT, STYLE, SIZE, OR COLOR.

FOR ASSOCIATION SERVICES, NAMELY, PROMOTING THE INTERESTS OF SOFTWARE DEVELOPERS (U.S. CLS. 100, 101 AND 102).

BARNEY CHARLON, EXAMINING ATTORNEY

CLASS 35—(Continued).

SN 78-862,536. THE INTEGER GROUP, L.L.C., LAKEWOOD, CO. FILED 4-17-2006.

AT THE INTERSECTION OF BRANDING AND SELLING

THE MARK CONSISTS OF STANDARD CHARACTERS WITHOUT CLAIM TO ANY PARTICULAR FONT, STYLE, SIZE, OR COLOR.

FOR ADVERTISING AGENCIES, NAMELY, PROMOTING THE GOODS AND SERVICES OF OTHERS; ADVERTISING AND PROMOTION SERVICES AND RELATED CONSULTING; ADVERTISING, MARKETING AND PROMOTION SERVICES (U.S. CLS. 100, 101 AND 102).

FIRST USE 10-1-2002; IN COMMERCE 10-1-2002.
ANDREA EVANS, EXAMINING ATTORNEY

SN 78-862,616. KINESIS SURVEY TECHNOLOGIES, LLC, DALLAS, TX. FILED 4-17-2006.

CAMI

THE MARK CONSISTS OF STANDARD CHARACTERS WITHOUT CLAIM TO ANY PARTICULAR FONT, STYLE, SIZE, OR COLOR.

FOR CONDUCTING BUSINESS AND MARKET RESEARCH SURVEYS (U.S. CLS. 100, 101 AND 102).

FIRST USE 1-1-2005; IN COMMERCE 1-1-2005.
AMY GEARIN, EXAMINING ATTORNEY

SN 78-862,653. BRICKHOUSE ELECTRONICS, NEW YORK, NY. FILED 4-17-2006.

BrickHouse Security

THE MARK CONSISTS OF STANDARD CHARACTERS WITHOUT CLAIM TO ANY PARTICULAR FONT, STYLE, SIZE, OR COLOR.

NO CLAIM IS MADE TO THE EXCLUSIVE RIGHT TO USE "SECURITY", APART FROM THE MARK AS SHOWN.

FOR RETAIL STORE AND ONLINE RETAIL STORE SERVICES FEATURING SURVEILLANCE EQUIPMENT, COUNTER SURVEILLANCE EQUIPMENT, GPS (GLOBAL POSITIONING SYSTEM) TRACKING EQUIPMENT, CHILD SAFETY EQUIPMENT, AND SPY EQUIPMENT (U.S. CLS. 100, 101 AND 102).

FIRST USE 1-5-2005; IN COMMERCE 1-5-2005.
KATRINA EDGE, EXAMINING ATTORNEY

CLASS 35—(Continued).

SN 78-862,867. MAGNOLIA BAKERY, INC., NEW YORK, NY. FILED 4-17-2006.

Magnolia Bakery

THE MARK CONSISTS OF STANDARD CHARACTERS WITHOUT CLAIM TO ANY PARTICULAR FONT, STYLE, SIZE, OR COLOR.

OWNER OF U.S. REG. NO. 3,126,202.

NO CLAIM IS MADE TO THE EXCLUSIVE RIGHT TO USE "BAKERY", APART FROM THE MARK AS SHOWN.

FOR RETAIL BAKERY SHOPS (U.S. CLS. 100, 101 AND 102).

FIRST USE 4-17-1996; IN COMMERCE 4-22-1996.
KAPIL BHANOT, EXAMINING ATTORNEY

SN 78-863,084. CATLIN, LISA L, PITTSBURGH, PA. FILED 4-17-2006.

PMETH

THE MARK CONSISTS OF STANDARD CHARACTERS WITHOUT CLAIM TO ANY PARTICULAR FONT, STYLE, SIZE, OR COLOR.

FOR EDUCATION LEADERSHIP DEVELOPMENT (U.S. CLS. 100, 101 AND 102).

FIRST USE 6-26-2004; IN COMMERCE 6-26-2004.
JOHN WILKE, EXAMINING ATTORNEY

SN 78-863,195. AES LOGISTICS, INC, TUKWILA, WA. FILED 4-17-2006.

Your Business, Delivered.

THE MARK CONSISTS OF STANDARD CHARACTERS WITHOUT CLAIM TO ANY PARTICULAR FONT, STYLE, SIZE, OR COLOR.

FOR TRANSPORTATION LOGISTICS SERVICES, NAMELY, ARRANGING THE TRANSPORTATION OF GOODS FOR OTHERS (U.S. CLS. 100, 101 AND 102).

RUDY R. SINGLETON, EXAMINING ATTORNEY

CLASS 35—(Continued).

SN 78-863,228. BOBBIN, SCOTT, STERLING, VA. FILED 4-17-2006.

Soul Insurance

THE MARK CONSISTS OF STANDARD CHARACTERS WITHOUT CLAIM TO ANY PARTICULAR FONT, STYLE, SIZE, OR COLOR.

FOR ON-LINE RETAIL STORE SERVICES FEATURING PERSONALIZED PROMOTIONAL ITEMS, NAMELY, NOVELTY PLAQUES, NOVELTY CERTIFICATES, NOVELTY AUTO ACCESSORIES NAMELY NOVELTY LICENSE PLATE HOLDERS, NOVELTY KEY TAGS, NOVELTY KEY RINGS, NOVELTY BUTTONS, NOVELTY LAPEL PINS, NOVELTY STICKERS, NOVELTY MUGS AND DRINK WARE, NAMELY NOVELTY THERMAL TRAVEL MUGS, NOVELTY SPORTS BEVERAGE BOTTLES, AND ANY OTHER NOVELTY ITEMS USED TO PROMOTE PERSONALIZED MESSAGES (U.S. CLS. 100, 101 AND 102).

CARRIE ACHEN, EXAMINING ATTORNEY

SN 78-863,441. SULLA TAVOLA, LLC, NASHVILLE, TN. FILED 4-18-2006.

SULLA TAVOLA

THE MARK CONSISTS OF STANDARD CHARACTERS WITHOUT CLAIM TO ANY PARTICULAR FONT, STYLE, SIZE, OR COLOR.

THE FOREIGN WORDING IN THE MARK TRANSLATES INTO ENGLISH AS ON THE TABLE.

FOR IMPORT AGENCY SERVICES AND DISTRIBUTORSHIP FEATURING WINE, OLIVE OIL, TRUFFLE PRODUCTS, SAUCE (U.S. CLS. 100, 101 AND 102).

KELLY BOULTON, EXAMINING ATTORNEY

SN 78-863,471. SWIRE PACIFIC HOLDINGS INC., DRAPER, UT. FILED 4-18-2006.

Swire Classic Vending

THE MARK CONSISTS OF STANDARD CHARACTERS WITHOUT CLAIM TO ANY PARTICULAR FONT, STYLE, SIZE, OR COLOR.

NO CLAIM IS MADE TO THE EXCLUSIVE RIGHT TO USE "VENDING", APART FROM THE MARK AS SHOWN.

FOR RENTAL OF VENDING MACHINES; VENDING IN THE FIELD OF FOOD AND BEVERAGES; VENDING MACHINE SERVICES (U.S. CLS. 100, 101 AND 102).

FIRST USE 12-20-2004; IN COMMERCE 12-20-2004.

LAURIE MAYES, EXAMINING ATTORNEY

CLASS 35—(Continued).

SN 78-863,499. NATIONAL BOATERS INC., POCASSET, MA. FILED 4-18-2006.



NO CLAIM IS MADE TO THE EXCLUSIVE RIGHT TO USE "CAPE COD BOATERS CO-OP" AND "WE STOP PRICING PIRACY!", APART FROM THE MARK AS SHOWN.

THE COLORS RED, BLACK, GRAY AND WHITE ARE CLAIMED AS A FEATURE OF THE MARK.

THE COLOR RED APPEARS IN THE UNIVERSAL PROHIBITION SYMBOL AND IN THE WORDING WE STOP PRICING PIRACY! THE COLOR BLACK APPEARS IN THE WORDING CAPE COD BOATERS CO-OP, THE CIRCULAR BACKGROUND BEHIND THE SKULL, THE HANDLES AND OUTLINE OF THE SWORDS AND THE SKULL'S EYE PATCH. THE COLOR GRAY APPEARS IN THE OUTLINE OF THE SKULL. THE COLOR WHITE APPEARS IN THE SKULL AND SWORDS.

FOR ADMINISTRATION OF A DISCOUNT PROGRAM FOR ENABLING PARTICIPANTS TO OBTAIN DISCOUNTS ON GOODS AND SERVICES THROUGH USE OF A DISCOUNT MEMBERSHIP CARD (U.S. CLS. 100, 101 AND 102).

FIRST USE 2-15-2006; IN COMMERCE 3-15-2006.

TINA BROWN, EXAMINING ATTORNEY

SN 78-863,509. MATCHMY INC., DURANGO, CO. FILED 4-18-2006.



THE COLOR(S) GRAY AND ORANGE IS/ARE CLAIMED AS A FEATURE OF THE MARK.

THE MARK CONSISTS OF A SINGLE GRAY PUZZLE PIECE TO THE LEFT OF THE ORANGE TEXT MATCHMY. THE MARK APPEARS ON A TRANSPARENT BACKGROUND, AND NO OTHER COLOR IS CLAIMED AS A PART OF THE MARK.

FOR ADVERTISING AND MARKETING; BUSINESS MARKETING SERVICES (U.S. CLS. 100, 101 AND 102).

TANYA AMOS, EXAMINING ATTORNEY

CLASS 35—(Continued).

SN 78-863,577. SMARTER SOLUTIONS, INC., AUSTIN, TX.
FILED 4-18-2006.

THE BUSINESS WAY OF LIFE

THE MARK CONSISTS OF STANDARD CHARACTERS WITHOUT CLAIM TO ANY PARTICULAR FONT, STYLE, SIZE, OR COLOR.

FOR BUSINESS CONSULTING AND BUSINESS MANAGEMENT SERVICES UTILIZING A BUSINESS STRATEGY CONSISTING OF PROCESS, ORGANIZATION AND TECHNICAL CHANGE TO INCREASE CUSTOMER SATISFACTION, OPERATIONAL EFFICIENCIES AND REVENUE FOR BUSINESS PROCESS IMPROVEMENT (U.S. CLS. 100, 101 AND 102).

FIRST USE 3-13-2006; IN COMMERCE 3-13-2006.
MARK SPARACINO, EXAMINING ATTORNEY

SN 78-863,659. RANAVAYA, MOHAMMED I. M.D., CHAPMANVILLE, WV. FILED 4-18-2006.



NO CLAIM IS MADE TO THE EXCLUSIVE RIGHT TO USE "INTERNATIONAL COLLEGE OF OCCUPATIONAL & ENVIRONMENTAL MEDICINE", APART FROM THE MARK AS SHOWN.

"THE COLOR(S) BLUE, GREEN, YELLOW, BLACK & DARK GREEN IS/ARE CLAIMED AS A FEATURE OF THE MARK".

"THE MARK CONSISTS OF A BLUE WORLD GLOBE WITH GREEN & YELLOW COUNTRIES AND BLACK LONGITUDE & LATITUDE LINES. THE GLOBE IS SURROUNDED WITH DARK GREEN LEAVES AND THREE YELLOW STARS AT THE BOTTOM. THE WORDING OF THE MARK APPEARS IN BLUE".

FOR ASSOCIATION SERVICES, NAMELY, PROMOTING THE INTERESTS OF PRACTITIONERS IN THE FIELD OF DISABILITY AND LEGAL MEDICINE (U.S. CLS. 100, 101 AND 102).

FIRST USE 4-5-2006; IN COMMERCE 4-5-2006.
KELLY BOULTON, EXAMINING ATTORNEY

CLASS 35—(Continued).

SN 78-863,721. IT'S OUR NATURE, INC., CLEARWATER, FL. FILED 4-18-2006.

**Healthy-Wear For People
Who Care**

THE MARK CONSISTS OF STANDARD CHARACTERS WITHOUT CLAIM TO ANY PARTICULAR FONT, STYLE, SIZE, OR COLOR.

FOR RETAIL CLOTHING BOUTIQUES (U.S. CLS. 100, 101 AND 102).

FIRST USE 5-1-2004; IN COMMERCE 10-2-2004.
KIMBERLY FRYE, EXAMINING ATTORNEY

SN 78-863,950. OFCOURSE, INC., TAMPA, FL. FILED 4-18-2006.

OFCOURSE

THE MARK CONSISTS OF STANDARD CHARACTERS WITHOUT CLAIM TO ANY PARTICULAR FONT, STYLE, SIZE, OR COLOR.

FOR EMPLOYEE LEASING AND PAYROLL PROCESSING SERVICES (U.S. CLS. 100, 101 AND 102).

ANNE FARRELL, EXAMINING ATTORNEY

SN 78-863,958. CUENCA ENTERPRISES INC., PICO RIVERA, CA. FILED 4-18-2006.

**HOME AND
LIVING.COM**
YOUR STYLE. ON YOUR BUDGET.

THE MARK CONSISTS OF STYLIZED WORDS IN A BOX. FOR ON-LINE RETAIL STORE SERVICES FEATURING HOME FURNITURE, BEDROOM FURNITURE, HOME OFFICE FURNITURE, BABY FURNITURE, MATTRESSES, LIVING ROOM FURNITURE, LINENS, INTERIOR DECORATING ITEMS (U.S. CLS. 100, 101 AND 102).

FIRST USE 11-4-2005; IN COMMERCE 11-4-2005.
INGRID C. EULIN, EXAMINING ATTORNEY

CLASS 35—(Continued).

SN 78-864,092. WEAVER, STEPHANIE, SAN DIEGO, CA.
FILED 4-18-2006.

Experienceology

THE MARK CONSISTS OF STANDARD CHARACTERS WITHOUT CLAIM TO ANY PARTICULAR FONT, STYLE, SIZE, OR COLOR.

FOR BUSINESS ADVICE AND INFORMATION; BUSINESS ADVISORY SERVICES, CONSULTANCY AND INFORMATION; BUSINESS CONSULTATION; BUSINESS CONSULTATION AND MANAGEMENT REGARDING MARKETING ACTIVITIES AND LAUNCHING OF NEW PRODUCTS; BUSINESS CONSULTATION SERVICES; BUSINESS CONSULTING AND BUSINESS INFORMATION FOR ENTERPRISES; BUSINESS MANAGEMENT CONSULTANCY AND ADVISORY SERVICES; BUSINESS MANAGEMENT CONSULTING WITH RELATION TO STRATEGY, MARKETING, PRODUCTION, PERSONNEL AND RETAIL SALE MATTERS; BUSINESS MARKETING CONSULTING SERVICES; BUSINESS MERCHANDISING DISPLAY SERVICES; DEVELOPMENT OF MARKETING STRATEGIES AND CONCEPTS; MARKETING CONSULTING; PLANNING AND CONDUCTING OF TRADE FAIRS, EXHIBITIONS AND PRESENTATIONS FOR ECONOMIC OR ADVERTISING PURPOSES (U.S. CLS. 100, 101 AND 102).

FIRST USE 7-21-2004; IN COMMERCE 7-21-2004.
CAROLYN CATALDO, EXAMINING ATTORNEY

SN 78-864,132. CUENCA ENTERPRISES INC., PICO RIVERA,
CA. FILED 4-18-2006.

home and living.com

THE MARK CONSISTS OF STANDARD CHARACTERS WITHOUT CLAIM TO ANY PARTICULAR FONT, STYLE, SIZE, OR COLOR.

FOR ON-LINE RETAIL STORE SERVICES FEATURING HOME FURNITURE, BEDROOM FURNITURE, HOME OFFICE FURNITURE, BABY FURNITURE, MATTRESSES, LIVING ROOM FURNITURE, LINENS, INTERIOR DECORATING ITEMS (U.S. CLS. 100, 101 AND 102).

FIRST USE 2-20-2005; IN COMMERCE 2-20-2005.
INGRID C. EULIN, EXAMINING ATTORNEY

CLASS 35—(Continued).

SN 78-864,149. HANAEE, SHAWN, STERLING HEIGHTS, MI.
FILED 4-18-2006.

jobberz.com

THE MARK CONSISTS OF STANDARD CHARACTERS WITHOUT CLAIM TO ANY PARTICULAR FONT, STYLE, SIZE, OR COLOR.

FOR PROVIDING ON-LINE INFORMATION IN THE FIELDS OF EMPLOYMENT, RECRUITMENT, CAREERS, PERSONAL ISSUES RELATED TO CAREERS AND WORK LIFE, JOB RESOURCES, JOB LISTINGS AND RESUMES; PROVIDING ON-LINE INTERACTIVE EMPLOYMENT COUNSELING AND RECRUITMENT SERVICES; PROVIDING ON-LINE EMPLOYMENT PLACEMENT SERVICES, NAMELY, RESUME MATCHING SERVICES VIA A GLOBAL COMPUTER NETWORK (U.S. CLS. 100, 101 AND 102).

FIRST USE 12-1-2005; IN COMMERCE 12-1-2005.
MARGERY A. TIERNEY, EXAMINING ATTORNEY

SN 78-864,171. WINESTYLES, INC., MARGATE, FL. FILED
4-18-2006.

BECAUSE EVERY DAY IS AN OCCASION

THE MARK CONSISTS OF STANDARD CHARACTERS WITHOUT CLAIM TO ANY PARTICULAR FONT, STYLE, SIZE, OR COLOR.

FOR RETAIL STORE SERVICES FEATURING WINE, WINE ACCESSORIES AND GIFT ITEMS (U.S. CLS. 100, 101 AND 102).

JASON ROTH, EXAMINING ATTORNEY

SN 78-864,211. Q, INTERACTIVE, INC., CHICAGO, IL.
FILED 4-18-2006.

TrueConversion Engine

THE MARK CONSISTS OF STANDARD CHARACTERS WITHOUT CLAIM TO ANY PARTICULAR FONT, STYLE, SIZE, OR COLOR.

FOR PROMOTING THE GOODS AND SERVICES OF OTHERS THROUGH THE DISPLAY OF ADVERTISING FROM A WEB PAGE ON THE GLOBAL COMPUTER NETWORK (U.S. CLS. 100, 101 AND 102).

KENNETH E. SHARPERSON, EXAMINING ATTORNEY

CLASS 35—(Continued).

SN 78-864,259. LEADING EDGE MARKETING, INC., NASSAU, NEW PROVIDENCE, BAHAMAS, FILED 4-18-2006.

Party Like a Pornstar

THE MARK CONSISTS OF STANDARD CHARACTERS WITHOUT CLAIM TO ANY PARTICULAR FONT, STYLE, SIZE, OR COLOR.

FOR CONTESTS AND INCENTIVE AWARD PROGRAMS TO PROMOTE THE SALE OF PRODUCTS AND SERVICES OF OTHERS (U.S. CLS. 100, 101 AND 102).

PAM WILLIS, EXAMINING ATTORNEY

SN 78-864,265. GLOBAL EXPERIENCES, INC., ALEXANDRIA, VA. FILED 4-18-2006.

Global Experiences

THE MARK CONSISTS OF STANDARD CHARACTERS WITHOUT CLAIM TO ANY PARTICULAR FONT, STYLE, SIZE, OR COLOR.

NO CLAIM IS MADE TO THE EXCLUSIVE RIGHT TO USE "GLOBAL", APART FROM THE MARK AS SHOWN.

FOR ADMINISTRATION OF CULTURAL AND EDUCATIONAL EXCHANGE PROGRAMS; EDUCATION LEADERSHIP DEVELOPMENT; PROVIDING BUSINESS AND COMMERCIAL INFORMATION IN THE FIELD OF BUSINESS TRAVEL MANAGEMENT AND THE BUSINESS TRAVEL INDUSTRY; TRAVEL MANAGEMENT (U.S. CLS. 100, 101 AND 102).

FIRST USE 10-1-2001; IN COMMERCE 4-1-2002.
SAMUEL E. SHARPER JR., EXAMINING ATTORNEY

SN 78-864,301. TRICOM PUBLICITY, INC, ROCKFORD, IL. FILED 4-18-2006.

Authors In Your Pocket

THE MARK CONSISTS OF STANDARD CHARACTERS WITHOUT CLAIM TO ANY PARTICULAR FONT, STYLE, SIZE, OR COLOR.

NO CLAIM IS MADE TO THE EXCLUSIVE RIGHT TO USE "AUTHORS", APART FROM THE MARK AS SHOWN.

FOR ASSOCIATION SERVICES, NAMELY, PROMOTING THE INTERESTS OF AUTHORS (U.S. CLS. 100, 101 AND 102).

AMY MCMENAMIN, EXAMINING ATTORNEY

CLASS 35—(Continued).

SN 78-864,308. TRICOM PUBLICITY, INC, ROCKFORD, IL. FILED 4-18-2006.

Bookclub In Your Pocket

THE MARK CONSISTS OF STANDARD CHARACTERS WITHOUT CLAIM TO ANY PARTICULAR FONT, STYLE, SIZE, OR COLOR.

NO CLAIM IS MADE TO THE EXCLUSIVE RIGHT TO USE "BOOKCLUB", APART FROM THE MARK AS SHOWN.

FOR ASSOCIATION SERVICES, NAMELY, PROMOTING THE INTERESTS OF AUTHORS (U.S. CLS. 100, 101 AND 102).

ELIZABETH J. WINTER, EXAMINING ATTORNEY

SN 78-864,436. BEALE STREET GRILL INC., THE, BATH, ME. FILED 4-19-2006.



OWNER OF U.S. REG. NOS. 2,720,423, 2,896,996 AND 2,896,997.

NO CLAIM IS MADE TO THE EXCLUSIVE RIGHT TO USE "BARBEQUE", APART FROM THE MARK AS SHOWN.

THE MARK CONSISTS OF THE WORDS BEALE STREET BARBEQUE WITH A FIGURE HOLDING A MUSICAL INSTRUMENT AND LEANING AGAINST A LAMPPOST.

FOR ONLINE RETAIL STORE AND ONLINE WHOLESALE STORE SERVICES FEATURING OUTDOOR FURNITURE, GAS, ELECTRIC AND CHARCOAL GRILLS, ACCESSORIES AND UTENSILS USED WITH OUTDOOR COOKING GRILLS, OUTDOOR GRILL CLEANING BRUSHES, POT HOLDERS, OVEN MITS, CHARCOAL, WOOD CHIPS FOR SMOKING AND GRILLING, OUTDOOR COOKING SMOKERS, CLOTHING, APRONS, AND HATS (U.S. CLS. 100, 101 AND 102).

ANNE E. GUSTASON, EXAMINING ATTORNEY

CLASS 35—(Continued).

SN 78-864,583. QUANTUM NY, LLC, NEW YORK, NY.
FILED 4-19-2006.

MY-IN.COM

THE MARK CONSISTS OF STANDARD CHARACTERS WITHOUT CLAIM TO ANY PARTICULAR FONT, STYLE, SIZE, OR COLOR.

FOR PROVIDING A WEBSITE WHICH FEATURES RESUMES, HEAD SHOTS, DEMO REELS, PORTFOLIOS, AUDITION ALERTS, JOB RESOURCES, JOB LISTINGS, APPOINTMENT SCHEDULING SERVICES AND EMPLOYMENT INFORMATION FOR ARTISTS, PERFORMERS, PRODUCERS, DIRECTORS, DESIGNERS AND OTHER ENTERTAINMENT INDUSTRY PROFESSIONALS; PROVIDING A WEBSITE WHICH ALLOWS ENTERTAINMENT INDUSTRY PROFESSIONALS TO POST RESUMES, HEAD SHOTS, DEMO REELS, PORTFOLIOS, AUDITION ALERTS, JOB RESOURCES, JOB LISTINGS AND EMPLOYMENT INFORMATION ONLINE; PROVIDING A WEBSITE FEATURING PRODUCT RATINGS OF THE GOODS AND SERVICES OF OTHERS IN THE ENTERTAINMENT INDUSTRY; CUSTOMER LOYALTY SERVICES AND CUSTOMER CLUB SERVICES, FOR COMMERCIAL, PROMOTIONAL AND/OR ADVERTISING PURPOSES; MONITORING SERVICES, NAMELY PROVIDING USERS WITH INFORMATION ON THE NUMBER OF TIMES THEIR RESUMES CAME UP IN SEARCH RESULTS AND INFORMATION ON THE NUMBER OF TIMES RESUMES, PHOTOS, HEAD SHOTS, VIDEO REELS AND SOUND SAMPLES WERE CLICKED FOR FULL VIEWING BY OTHERS; PROVIDING A WEBSITE WHICH ALLOWS USERS TO RATE LOCATIONS WHERE ENTERTAINMENT INDUSTRY PROFESSIONALS AND CELEBRITIES GATHER AND NETWORK AND LIST ADDITIONAL LOCATIONS (U.S. CLS. 100, 101 AND 102).

FIRST USE 4-17-2006; IN COMMERCE 4-17-2006.
TINA L. SNAPP, EXAMINING ATTORNEY

SN 78-864,632. MCKINNEY, AILIA COLEY, INGLEWOOD, CA. FILED 4-19-2006.



THE APPLICANT CLAIMS COLOR AS A FEATURE OF THE MARK, NAMELY, RED, WHITE AND BLACK.

THE MARK CONSISTS OF LADY WITH A WHITE FACE OUTLINED IN BLACK, RED LIPS OUTLINED IN BLACK, AN EYE/EYELASH IN THE COLOR BLACK, A BLACK HAT, A RED HEART SHAPED TORSO AND BLACK GLOVES.

FOR ARRANGING AND CONDUCTING MARKETING PROMOTIONAL EVENTS FOR OTHERS (U.S. CLS. 100, 101 AND 102).

DOMINIC FATHY, EXAMINING ATTORNEY

CLASS 35—(Continued).

SN 78-864,701. AFMS, LLC, PORTLAND, OR. FILED 4-19-2006.

AFMS

THE MARK CONSISTS OF STANDARD CHARACTERS WITHOUT CLAIM TO ANY PARTICULAR FONT, STYLE, SIZE, OR COLOR.

FOR TRANSPORTATION LOGISTICS SERVICES, NAMELY, PLANNING AND SCHEDULING SHIPMENTS FOR USERS OF TRANSPORTATION SERVICES (U.S. CLS. 100, 101 AND 102).

FIRST USE 12-31-1999; IN COMMERCE 12-31-2000.
TINA L. SNAPP, EXAMINING ATTORNEY

SN 78-864,839. LIEW, FRED VAN, DALLAS, TX. FILED 4-19-2006.

TRINISOL

THE MARK CONSISTS OF STANDARD CHARACTERS WITHOUT CLAIM TO ANY PARTICULAR FONT, STYLE, SIZE, OR COLOR.

FOR RETAIL STORE SERVICES FEATURING WATER FILTERS, AIR FILTERS, BOTTLED WATER, SELF IMPROVEMENT BOOKS, SELF IMPROVEMENT TAPES, JEWELRY AND NUTRIENT DENSE FOOD CONCENTRATES; ON-LINE RETAIL STORE SERVICES FEATURING WATER FILTERS, AIR FILTERS, BOTTLED WATER, SELF IMPROVEMENT BOOKS, SELF IMPROVEMENT TAPES, JEWELRY AND NUTRIENT DENSE FOOD CONCENTRATES (U.S. CLS. 100, 101 AND 102).

TONJA GASKINS, EXAMINING ATTORNEY

SN 78-864,892. DYNAMIS ADVISORS INC., CHAGRIN FALLS, OH. FILED 4-19-2006.



THE MARK CONSISTS OF A BOLD CAPITAL LETTER G WITHIN THE WORDS "GROWING IN PLACE". BEHIND THE BOLD CAPITAL G ARE FOUR ARROWS.

FOR BUSINESS CONSULTATION SERVICES (U.S. CLS. 100, 101 AND 102).

FIRST USE 3-2-2005; IN COMMERCE 3-2-2005.

WILLIAM BRECKENFELD, EXAMINING ATTORNEY

CLASS 35—(Continued).

SN 78-864,900. DOWN ETC. LLC, SAN FRANCISCO, CA. FILED 4-19-2006.

DOWN ETC

THE MARK CONSISTS OF STANDARD CHARACTERS WITHOUT CLAIM TO ANY PARTICULAR FONT, STYLE, SIZE, OR COLOR.

NO CLAIM IS MADE TO THE EXCLUSIVE RIGHT TO USE "DOWN", APART FROM THE MARK AS SHOWN.

FOR RETAIL STORES FEATURING BEDDING (U.S. CLS. 100, 101 AND 102).

FIRST USE 8-1-2001; IN COMMERCE 8-1-2001.
ALAIN LAPTEY, EXAMINING ATTORNEY

CLASS 35—(Continued).

SN 78-865,194. PHELAN, SAMUEL, NEWPORT, RI. FILED 4-19-2006.

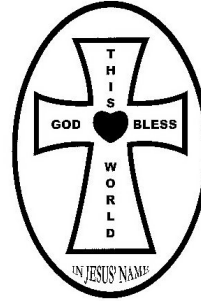

THE MARK CONSISTS OF THIS IS AN OVAL LOGO (CALLED CROSS-HEART) WITH A CROSS INSIDE AND A RED HEART AT THE CENTER OF THE CROSS. THE WORDS 'GOD BLESS THIS WORLD' ARE INSERTED IN THE ARMS OF THE CROSS AND THE WORDS 'IN JESUS' NAME' ARE INCLUDED AT THE BOTTOM OF THE OVAL.

FOR RETAIL SERVICES, FEATURING T-SHIRTS AND CAR MAGNETS PROMOTING CHRISTIANITY (U.S. CLS. 100, 101 AND 102).

CAROLYN CATALDO, EXAMINING ATTORNEY

SN 78-865,032. MEDICAL TECHNOLOGY (W.B.) INC., LONDON, ONTARIO, CANADA, FILED 4-19-2006.



FOR ONLINE RETAIL STORE SERVICES FEATURING WRISTBANDS AND TAGS; ONLINE ORDERING SERVICES FEATURING WRISTBANDS AND TAGS (U.S. CLS. 100, 101 AND 102).

DAVID COLLIER, EXAMINING ATTORNEY

SN 78-865,223. R2 GROUP, LLC, CARLSBAD, CA. FILED 4-19-2006.

Roadmaps Institute

THE MARK CONSISTS OF STANDARD CHARACTERS WITHOUT CLAIM TO ANY PARTICULAR FONT, STYLE, SIZE, OR COLOR.

NO CLAIM IS MADE TO THE EXCLUSIVE RIGHT TO USE "INSTITUTE", APART FROM THE MARK AS SHOWN.

FOR BUSINESS CONSULTING AND BUSINESS MANAGEMENT RELATING TO PRODUCT DEVELOPMENT, PROCUREMENT, PRODUCTION, QUALITY, DISTRIBUTION, DISPOSAL, LOGISTICS, REVERSE LOGISTICS, SUPPLY CHAIN, AND LEAN SOLUTIONS; BUSINESS PLANNING WITH RESPECT TO SUPPLY CHAINS; BUSINESS PLANNING FOR SUPPLY AND CUSTOMER CHAIN MEMBERS IN TERMS OF CAPABILITY, PERFORMANCE, COORDINATION AND COLLABORATION BETWEEN DEPARTMENTS AND DIVISIONS (U.S. CLS. 100, 101 AND 102).

FIRST USE 2-23-2004; IN COMMERCE 7-31-2004.
JOHN SCHUYLER YARD, EXAMINING ATTORNEY

CLASS 35—(Continued).

SN 78-865,251. R2 GROUP, LLC, CARLSBAD, CA. FILED 4-19-2006.



THE MARK CONSISTS OF THE LETTER "R" AND "I" WHERE THE "I" CONTAINS A DEPICTION OF A ROAD.

FOR BUSINESS CONSULTING AND BUSINESS MANAGEMENT RELATING TO PRODUCT DEVELOPMENT, PROCUREMENT, PRODUCTION, QUALITY, DISTRIBUTION, DISPOSAL, LOGISTICS, REVERSE LOGISTICS, SUPPLY CHAIN, AND LEAN SOLUTIONS; BUSINESS PLANNING WITH RESPECT TO SUPPLY CHAINS; BUSINESS PLANNING FOR SUPPLY AND CUSTOMER CHAIN MEMBERS IN TERMS OF CAPABILITY, PERFORMANCE, COORDINATION AND COLLABORATION BETWEEN DEPARTMENTS AND DIVISIONS (U.S. CLS. 100, 101 AND 102).

FIRST USE 6-16-2005; IN COMMERCE 6-22-2005.
JOHN SCHUYLER YARD, EXAMINING ATTORNEY

SN 78-865,272. R2 GROUP, LLC, CARLSBAD, CA. FILED 4-19-2006.

DR2IVE

THE MARK CONSISTS OF STANDARD CHARACTERS WITHOUT CLAIM TO ANY PARTICULAR FONT, STYLE, SIZE, OR COLOR.

FOR BUSINESS CONSULTING AND BUSINESS MANAGEMENT RELATING TO PRODUCT DEVELOPMENT, PROCUREMENT, PRODUCTION, QUALITY, DISTRIBUTION, DISPOSAL, LOGISTICS, REVERSE LOGISTICS, SUPPLY CHAIN, AND LEAN SOLUTIONS; BUSINESS PLANNING WITH RESPECT TO SUPPLY CHAINS; BUSINESS PLANNING FOR SUPPLY AND CUSTOMER CHAIN MEMBERS IN TERMS OF CAPABILITY, PERFORMANCE, COORDINATION AND COLLABORATION BETWEEN DEPARTMENTS AND DIVISIONS (U.S. CLS. 100, 101 AND 102).

FIRST USE 11-30-2003; IN COMMERCE 11-30-2003.
JOHN SCHUYLER YARD, EXAMINING ATTORNEY

CLASS 35—(Continued).

SN 78-865,304. R2 GROUP, LLC, CARLSBAD, CA. FILED 4-19-2006.

Robust Roadmaps

THE MARK CONSISTS OF STANDARD CHARACTERS WITHOUT CLAIM TO ANY PARTICULAR FONT, STYLE, SIZE, OR COLOR.

FOR BUSINESS CONSULTING AND BUSINESS MANAGEMENT RELATING TO PRODUCT DEVELOPMENT, PROCUREMENT, PRODUCTION, QUALITY, DISTRIBUTION, DISPOSAL, LOGISTICS, REVERSE LOGISTICS, SUPPLY CHAIN, AND LEAN SOLUTIONS; BUSINESS PLANNING WITH RESPECT TO SUPPLY CHAINS; BUSINESS PLANNING FOR SUPPLY AND CUSTOMER CHAIN MEMBERS IN TERMS OF CAPABILITY, PERFORMANCE, COORDINATION AND COLLABORATION BETWEEN DEPARTMENTS AND DIVISIONS (U.S. CLS. 100, 101 AND 102).

FIRST USE 11-30-2004; IN COMMERCE 2-28-2005.
JOHN SCHUYLER YARD, EXAMINING ATTORNEY

SN 78-865,366. BASKETT ENTERPRISES INC., ROCKWALL, TX. FILED 4-19-2006.

LET'S ROLL

THE MARK CONSISTS OF STANDARD CHARACTERS WITHOUT CLAIM TO ANY PARTICULAR FONT, STYLE, SIZE, OR COLOR.

FOR ADVERTISING, MARKETING, PROMOTIONAL, AND PUBLICITY SERVICES, NAMELY, MOBILE DISSEMINATION OF BILLBOARD ADVERTISING MATERIAL FOR OTHERS VIA A MOBILE CHANGING BILLBOARD SIGN APPEARING ON THE SIDE(S) OF A TRUCK TRAVERSING A PREDETERMINED ROUTE AT PREDETERMINED TIMES; ADVERTISING CONSULTATION SERVICES, NAMELY, THE DESIGN OF BILLBOARD ADVERTISING MATERIALS FOR OTHERS; ADVERTISING CONSULTATION SERVICES, NAMELY, THE DESIGN OF TRUCK ROUTES FOR THE DEMOGRAPHICALLY EFFECTIVE MOBILE DISSEMINATION OF MOBILE BILLBOARD ADVERTISING MATERIAL FOR OTHERS; RENTAL OF MOBILE BILLBOARD ADVERTISING SPACE TO OTHERS, SAID MOBILE BILLBOARD ADVERTISING SPACE COMPRISING A MOBILE CHANGING BILLBOARD SIGN APPEARING ON THE SIDE(S) OF A TRUCK TRAVERSING A PREDETERMINED ROUTE AT PREDETERMINED TIMES; BILLBOARD ADVERTISING SERVICES FOR OTHERS; ADVERTISING CONSULTATION SERVICES, NAMELY, THE DEMOGRAPHICALLY DRIVEN SELECTION OF FIXED BILLBOARD SITES FOR THE DISSEMINATION OF BILLBOARD ADVERTISING MATERIAL (U.S. CLS. 100, 101 AND 102).

MARIA-VICTORIA SUAREZ, EXAMINING ATTORNEY

CLASS 35—(Continued).

SN 78-865,556. TRADE MARKETING AND PROMOTION GROUP, INC., WHITE PLAINS, NY. FILED 4-20-2006.

TMPG

THE MARK CONSISTS OF STANDARD CHARACTERS WITHOUT CLAIM TO ANY PARTICULAR FONT, STYLE, SIZE, OR COLOR.

OWNER OF U.S. REG. NO. 2,321,142.
FOR DEVELOPING ADVERTISING AND PROMOTIONAL CAMPAIGNS FOR BUSINESSES; PLACING ADVERTISEMENTS FOR OTHERS; MARKET ANALYSIS AND RESEARCH (U.S. CLS. 100, 101 AND 102).
FIRST USE 6-1-1993; IN COMMERCE 6-1-1993.
AISHA CLARKE, EXAMINING ATTORNEY

CLASS 35—(Continued).

SN 78-865,944. OFFICESCAPES LLC, WHITE PLAINS, NY. FILED 4-20-2006.

BRINGING YOUR OFFICE ENVIRONMENT TO LIFE

THE MARK CONSISTS OF STANDARD CHARACTERS WITHOUT CLAIM TO ANY PARTICULAR FONT, STYLE, SIZE, OR COLOR.

FOR INTERNET AND MAIL ORDER CATALOG SERVICES FEATURING SILK FLORALS AND PLANTS (U.S. CLS. 100, 101 AND 102).
FIRST USE 4-1-1997; IN COMMERCE 4-1-1997.
JEFF DEFORD, EXAMINING ATTORNEY

SN 78-865,652. THE FILMPUNKS, HOLLYWOOD, CA. FILED 4-20-2006.

FILMPUNKS

THE MARK CONSISTS OF STANDARD CHARACTERS WITHOUT CLAIM TO ANY PARTICULAR FONT, STYLE, SIZE, OR COLOR.

FOR POST-PRODUCTION EDITING SERVICES FOR VIDEO AND AUDIO COMMERCIALS; PRODUCING AUDIO OR VIDEO INFOMERCIALS; PRODUCTION OF TELEVISION COMMERCIALS; PROMOTION USING AUDIOVISUAL MEDIA; TALENT AGENCIES (U.S. CLS. 100, 101 AND 102).
FIRST USE 3-13-2006; IN COMMERCE 3-13-2006.
NAAKWAMA ANKRAH, EXAMINING ATTORNEY

SN 78-866,075. DISC MARKETING, LLC, PASADENA, CA. FILED 4-20-2006.

soundDNA

THE MARK CONSISTS OF STANDARD CHARACTERS WITHOUT CLAIM TO ANY PARTICULAR FONT, STYLE, SIZE, OR COLOR.

FOR ADVERTISING, PROMOTION AND MARKETING SERVICES (U.S. CLS. 100, 101 AND 102).
KAREN BRACEY, EXAMINING ATTORNEY

SN 78-865,886. OFFICESCAPES LLC, WHITE PLAINS, NY. FILED 4-20-2006.

ELEVATING HEART AND HOME

THE MARK CONSISTS OF STANDARD CHARACTERS WITHOUT CLAIM TO ANY PARTICULAR FONT, STYLE, SIZE, OR COLOR.

FOR INTERNET AND MAIL ORDER CATALOG SERVICES FEATURING SILK FLORALS AND PLANTS (U.S. CLS. 100, 101 AND 102).
FIRST USE 8-1-2005; IN COMMERCE 8-1-2005.
JEFF DEFORD, EXAMINING ATTORNEY

SN 78-866,086. PEDRAZA, MILTON F., WYCKOFF, NJ. FILED 4-20-2006.

LUXURY BOARD

THE MARK CONSISTS OF STANDARD CHARACTERS WITHOUT CLAIM TO ANY PARTICULAR FONT, STYLE, SIZE, OR COLOR.

FOR BUSINESS RESEARCH AND ADVICE TO CLIENTS IN AREAS SUCH AS MARKETING, BRANDING, ADVERTISING, CONSUMER SPENDING AND BUSINESS PRACTICES IN THE LUXURY CONSUMER SERVICES AND PRODUCTS SECTORS (U.S. CLS. 100, 101 AND 102).
AISHA CLARKE, EXAMINING ATTORNEY

CLASS 35—(Continued).

SN 78-866,108. ZOOM MEDIA CORP., NEW YORK, NY. FILED 4-20-2006.

ZOOM MEDIA AND MARKETING

THE MARK CONSISTS OF STANDARD CHARACTERS WITHOUT CLAIM TO ANY PARTICULAR FONT, STYLE, SIZE, OR COLOR.

OWNER OF U.S. REG. NO. 2,839,338.

NO CLAIM IS MADE TO THE EXCLUSIVE RIGHT TO USE MEDIA AND MARKETING, APART FROM THE MARK AS SHOWN.

FOR ADVERTISING SERVICES, NAMELY PREPARING AND PLACING ADVERTISEMENTS FOR OTHERS ON A VARIETY OF MEDIA INCLUDING ILLUMINATED AND NON-ILLUMINATED BILLBOARDS, POSTCARDS, POSTCARD RACKS, POSTERS, ILLUMINATED SIGNS, PAINTED MURALS, AUDIO AND VIDEO DIGITAL SIGNAGE; AND DISSEMINATION OF ADVERTISING FOR OTHERS VIA ONLINE ELECTRONIC COMMUNICATION NETWORKS (U.S. CLS. 100, 101 AND 102).

ODESSA BIBBINS, EXAMINING ATTORNEY

SN 78-866,116. DISC MARKETING, LLC, PASADENA, CA. FILED 4-20-2006.

FOOTNOTES

THE MARK CONSISTS OF STANDARD CHARACTERS WITHOUT CLAIM TO ANY PARTICULAR FONT, STYLE, SIZE, OR COLOR.

FOR ADVERTISING, PROMOTION AND MARKETING SERVICES (U.S. CLS. 100, 101 AND 102).

KAREN BRACEY, EXAMINING ATTORNEY

CLASS 35—(Continued).

SN 78-866,309. TORRES, ROSA, NEW PALTZ, NY. FILED 4-20-2006.

THE OWL AND THE SERPENT

THE MARK CONSISTS OF STANDARD CHARACTERS WITHOUT CLAIM TO ANY PARTICULAR FONT, STYLE, SIZE, OR COLOR.

FOR RETAIL STORES FEATURING METAPHYSICAL BOOKS, REIKI, HERBS, TAROT BOOKS, RELIGIOUS ITEMS, INCENSE, CANDLES, OILS, JEWELRY, CRYSTALS, CRAFTS, WANDS, ALTARS, ALTAR TOOLS, STATUES, ART, SANTERIA SUPPLIES, RUNES, DRUMS, DREAMCATCHERS, PENTACLES, TALKING STICKS, NATIVE AMERICAN CRAFTS, RAINSTICKS, SUNCATCHERS, PAINTINGS, RATTLES, SILVER JEWELRY, BOTANICA, ORGANIC SOAPS, BATH SALTS, AROMATHERAPY, AND CLOTHING (U.S. CLS. 100, 101 AND 102).

FIRST USE 4-0-2001; IN COMMERCE 4-0-2001.

SUSAN LESLIE DUBOIS, EXAMINING ATTORNEY

SN 78-866,315. QUALITY BROKERAGE COMPANY OF GEORGIA, INC., SMYRNA, GA. FILED 4-20-2006.

Providing profitable solutions to the challenges facing today's foodservice operators

THE MARK CONSISTS OF STANDARD CHARACTERS WITHOUT CLAIM TO ANY PARTICULAR FONT, STYLE, SIZE, OR COLOR.

FOR MANUFACTURER REPRESENTATIVES IN THE FIELD OF PRODUCTS FOR FOODSERVICE OPERATORS AND DISTRIBUTORS (U.S. CLS. 100, 101 AND 102).

FIRST USE 6-1-2002; IN COMMERCE 6-1-2002.

DEIRDRE ROBERTSON, EXAMINING ATTORNEY

SN 78-866,371. OSWALD, JASON L., MINNEAPOLIS, MN. FILED 4-20-2006.

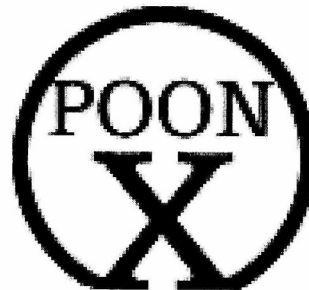

FOR DISSEMINATION OF ADVERTISING FOR OTHERS VIA THE INTERNET (U.S. CLS. 100, 101 AND 102).

KAREN BRACEY, EXAMINING ATTORNEY

CLASS 35—(Continued).

SN 78-866,729. ALOHA COWBOY, LLC, MAKAWAO, HI.
FILED 4-21-2006.

ALOHA COWBOY

THE MARK CONSISTS OF STANDARD CHARACTERS WITHOUT CLAIM TO ANY PARTICULAR FONT, STYLE, SIZE, OR COLOR.

NO CLAIM IS MADE TO THE EXCLUSIVE RIGHT TO USE COWBOY, APART FROM THE MARK AS SHOWN.

FOR RETAIL CLOTHING STORES FEATURING MEN'S, WOMEN'S AND CHILDREN'S CLOTHING (U.S. CLS. 100, 101 AND 102).

KATHERINE STOIDES, EXAMINING ATTORNEY

CLASS 35—(Continued).

SN 78-866,782. NEXPLORE TECHNOLOGIES, INC., FRISCO, TX. FILED 4-21-2006.

MYCIRCLE

THE MARK CONSISTS OF STANDARD CHARACTERS WITHOUT CLAIM TO ANY PARTICULAR FONT, STYLE, SIZE, OR COLOR.

FOR ADVERTISEMENT SERVICES AND ADVERTISING ADVICE ON THE ANALYSIS OF CONSUMER BUYING BEHAVIOR (U.S. CLS. 100, 101 AND 102).

CAROL SPILS, EXAMINING ATTORNEY

SN 78-866,768. GREENBRIER MANAGEMENT SERVICES, LLC, LAKE OSWEGO, OR. FILED 4-21-2006.



Railcar Management Solutions

NO CLAIM IS MADE TO THE EXCLUSIVE RIGHT TO USE "RAILCAR MANAGEMENT SOLUTIONS", APART FROM THE MARK AS SHOWN.

THE COLOR(S) WHITE AND BLACK AND GOLD IS/ARE CLAIMED AS A FEATURE OF THE MARK.

THE MARK CONSISTS OF THE WORD ENSPIRE ON A BLACK RECTANGLE WITH A GOLD STYLIZED TRIANGLE IN THE BLACK RECTANGLE ABOVE THE S AND P OF THE WORD ENSPIRE.

FOR RAILCAR BUSINESS MANAGEMENT SERVICES (U.S. CLS. 100, 101 AND 102).

DAVID TAYLOR, EXAMINING ATTORNEY

SN 78-866,818. NEXPLORE TECHNOLOGIES, INC., FRISCO, TX. FILED 4-21-2006.

NEXPLORE.COM

THE MARK CONSISTS OF STANDARD CHARACTERS WITHOUT CLAIM TO ANY PARTICULAR FONT, STYLE, SIZE, OR COLOR.

FOR ADVERTISEMENT SERVICES AND ADVERTISING ADVICE ON THE ANALYSIS OF CONSUMER BUYING BEHAVIOR (U.S. CLS. 100, 101 AND 102).

CAROL SPILS, EXAMINING ATTORNEY

SN 78-866,774. NEXPLORE TECHNOLOGIES, INC., FRISCO, TX. FILED 4-21-2006.

MYCIRCLE.COM

THE MARK CONSISTS OF STANDARD CHARACTERS WITHOUT CLAIM TO ANY PARTICULAR FONT, STYLE, SIZE, OR COLOR.

FOR ADVERTISEMENT SERVICES AND ADVERTISING ADVICE ON THE ANALYSIS OF CONSUMER BUYING BEHAVIOR (U.S. CLS. 100, 101 AND 102).

CAROL SPILS, EXAMINING ATTORNEY

SN 78-866,883. NEXPLORE TECHNOLOGIES, INC., FRISCO, TX. FILED 4-21-2006.

NEXPLORE

THE MARK CONSISTS OF STANDARD CHARACTERS WITHOUT CLAIM TO ANY PARTICULAR FONT, STYLE, SIZE, OR COLOR.

FOR ADVERTISEMENT SERVICES AND ADVERTISING ADVICE ON THE ANALYSIS OF CONSUMER BUYING BEHAVIOR (U.S. CLS. 100, 101 AND 102).

CAROL SPILS, EXAMINING ATTORNEY

CLASS 35—(Continued).

SN 78-866,924. APOSTLE CLOTHING COMPANY, INC., COCOA, FL. FILED 4-21-2006.



NO CLAIM IS MADE TO THE EXCLUSIVE RIGHT TO USE "RIDE SHOP", APART FROM THE MARK AS SHOWN. THE MARK CONSISTS OF THE STYLIZED LETTERS "VRS". THE WORDS VIERA RIDE SHOP ARE TO THE LEFT OF THE STYLIZED LETTERS.

THE ENGLISH TRANSLATION OF THE WORD VIERA IN THE MARK IS FAITH.
FOR RETAIL SPORTING GOODS STORES (U.S. CLS. 100, 101 AND 102).

DAVID COLLIER, EXAMINING ATTORNEY

SN 78-867,075. GREENBRIER MANAGEMENT SERVICES, LLC, LAKE OSWEGO, OR. FILED 4-21-2006.

ENSPIRE

THE MARK CONSISTS OF STANDARD CHARACTERS WITHOUT CLAIM TO ANY PARTICULAR FONT, STYLE, SIZE, OR COLOR.

FOR RAILCAR BUSINESS MANAGEMENT SERVICES (U.S. CLS. 100, 101 AND 102).

DAVID TAYLOR, EXAMINING ATTORNEY

SN 78-867,136. COOL SCHOOL INCENTIVES, INC., BECKER, MN. FILED 4-21-2006.

Cool U Cafe

THE MARK CONSISTS OF STANDARD CHARACTERS WITHOUT CLAIM TO ANY PARTICULAR FONT, STYLE, SIZE, OR COLOR.

FOR ADVERTISING, MARKETING AND PROMOTION SERVICES (U.S. CLS. 100, 101 AND 102).

CHERYL CLAYTON, EXAMINING ATTORNEY

CLASS 35—(Continued).

SN 78-867,139. GREENBRIER MANAGEMENT SERVICES, LLC, LAKE OSWEGO, OR. FILED 4-21-2006.



THE COLOR(S) BLACK AND OLIVE GREEN IS/ARE CLAIMED AS A FEATURE OF THE MARK.

THE MARK CONSISTS OF THE WORD ENTRUST WITH THREE STYLIZED OLIVE GREEN TRIANGLES ABOVE AND TO THE LEFT OF THE E IN ENTRUST.

FOR RAILCAR MAINTENANCE MANAGEMENT SERVICES (U.S. CLS. 100, 101 AND 102).

DAVID TAYLOR, EXAMINING ATTORNEY

SN 78-867,148. GREENBRIER MANAGEMENT SERVICES, LLC, LAKE OSWEGO, OR. FILED 4-21-2006.

entrust

THE MARK CONSISTS OF STANDARD CHARACTERS WITHOUT CLAIM TO ANY PARTICULAR FONT, STYLE, SIZE, OR COLOR.

FOR RAILCAR MAINTENANCE MANAGEMENT SERVICES (U.S. CLS. 100, 101 AND 102).

DAVID TAYLOR, EXAMINING ATTORNEY

SN 78-867,159. STONE MOUNTAIN CARPET MILLS, INC., EARTH CITY, MO. FILED 4-21-2006.



THE COLOR(S) YELLOW AND BLACK IS/ARE CLAIMED AS A FEATURE OF THE MARK.

THE MARK CONSISTS OF THE WORDS THE FLOOR TRADER IN BLACK IN A YELLOW SQUARE.

FOR RETAIL STORE SERVICES IN THE FIELD OF FLOOR COVERINGS (U.S. CLS. 100, 101 AND 102).

FIRST USE 7-31-2005; IN COMMERCE 7-31-2005.

CHERYL CLAYTON, EXAMINING ATTORNEY

CLASS 35—(Continued).

SN 78-867,176. COOL SCHOOL INCENTIVES, INC., BECKER, MN. FILED 4-21-2006.

Be Your Own Cool

THE MARK CONSISTS OF STANDARD CHARACTERS WITHOUT CLAIM TO ANY PARTICULAR FONT, STYLE, SIZE, OR COLOR.

FOR ADVERTISING, MARKETING AND PROMOTION SERVICES (U.S. CLS. 100, 101 AND 102).
CHERYL CLAYTON, EXAMINING ATTORNEY

SN 78-867,204. DOYLE, ROBERT, NEW YORK, NY. FILED 4-21-2006.



THE MARK CONSISTS OF COMPANY NAME IBOTANICALS LAYERED ON TOP OF A FLOWER.

FOR RETAIL STORES FEATURING OF CUSTOM FORMULATIONS OF BATH AND BODY PRODUCTS, SKINCARE PRODUCTS, HAIR PRODUCTS, PERFUMES, SOAPS, BATH CARE PRODUCTS, COSMETICS, ESSENTIAL OILS, FRAGRANCE WATERS, ROOM FRAGRANCES, AND OTC PHARMACEUTICALS; WHOLESALE DISTRIBUTORSHIPS FEATURING OF CUSTOM FORMULATIONS OF BATH AND BODY PRODUCTS, SKINCARE PRODUCTS, HAIR PRODUCTS, PERFUMES, SOAPS, BATH CARE PRODUCTS, COSMETICS, ESSENTIAL OILS, FRAGRANCE WATERS, ROOM FRAGRANCES, AND OTC PHARMACEUTICALS (U.S. CLS. 100, 101 AND 102).

STEPHANIE DAVIS, EXAMINING ATTORNEY

SN 78-867,527. WESTFALL, MATTHEW WILSON, BROOKLYN, NY. FILED 4-23-2006.

ADBATTLES

THE MARK CONSISTS OF STANDARD CHARACTERS WITHOUT CLAIM TO ANY PARTICULAR FONT, STYLE, SIZE, OR COLOR.

FOR PROVIDING AND RENTAL OF ADVERTISING SPACE ON THE INTERNET (U.S. CLS. 100, 101 AND 102).
LINDA ORNDORFF, EXAMINING ATTORNEY

CLASS 35—(Continued).

SN 78-867,573. ARAUZ, NICOLAS A, BROOKLYN, NY. FILED 4-23-2006.

Xipto

THE MARK CONSISTS OF STANDARD CHARACTERS WITHOUT CLAIM TO ANY PARTICULAR FONT, STYLE, SIZE, OR COLOR.

FOR ADVERTISING AND BUSINESS SERVICES, NAMELY SECURING AIRTIME ON ALL FORMS OF MEDIA COMMUNICATIONS STATIONS, SYSTEMS, NETWORKS, AND SERVICES FOR THE PURPOSE OF PROMOTING THE GOODS AND SERVICES OF OTHERS (U.S. CLS. 100, 101 AND 102).

FIRST USE 4-22-2001; IN COMMERCE 11-20-2005.
HOWARD B. LEVINE, EXAMINING ATTORNEY

SN 78-867,587. TODOROV, ELIZABETH F., STERLING, MA. FILED 4-23-2006.

Pool Pocket

THE MARK CONSISTS OF STANDARD CHARACTERS WITHOUT CLAIM TO ANY PARTICULAR FONT, STYLE, SIZE, OR COLOR.

NO CLAIM IS MADE TO THE EXCLUSIVE RIGHT TO USE POOL, APART FROM THE MARK AS SHOWN.

FOR SWIMMING POOL MANAGEMENT (U.S. CLS. 100, 101 AND 102).

LEIGH CAROLINE CASE, EXAMINING ATTORNEY

SN 78-867,786. YOOX S.P.A., ZOLA PREDOSA, BOLOGNA, ITALY, FILED 4-24-2006.

YOOX

THE MARK CONSISTS OF STANDARD CHARACTERS WITHOUT CLAIM TO ANY PARTICULAR FONT, STYLE, SIZE, OR COLOR.

OWNER OF U.S. REG. NOS. 2,732,994 AND 2,833,929.

FOR (BASED UPON 1(A)) COMPUTERIZED ON-LINE RETAIL STORE SERVICES IN THE FIELDS OF RECORDS IN VINYL, AUDIO CD'S, JEWELRY, JEWELS, WATCHES, PHOTOGRAPHS, ARTIST'S MATERIAL, CALENDARS, BOOKS, AGENDAS, GOODS MADE OF LEATHER AND IMITATIONS OF LEATHER, WALLETS, PURSES, SUITCASES, UMBRELLAS, DESIGN GIFTS AND DESIGN FANCY GOODS, TEXTILES AND TEXTILES GOODS, BED AND TABLE COVERS, CLOTHING, INCLUDING LEATHER JACKETS AND TROUSERS, DRESSES, BELTS, TIES, SCARVES, GLOVES, SLEEVES, STOLES, JACKETS, SHIRTS, TROUSERS, BLOUSES, COATS, BLAZERS, CAPES, MEN'S AND LADIES SUITS, SKIRTS, LINGERIE AND UNDERGARMENTS, PULL-OVERS, BEACHWEAR, PANTS, SHORTS, SHIRTS, T-SHIRTS, CLOTHING TOPS, LEATHER SKIRTS, WAIST-

CLASS 35—(Continued).

COATS, DUNGAREES, DRESSES, CAFTANS, FURS, PONCHOS, OVERCOATS, CASUAL CLOTHING, HOSIERY, SWEATSHIRTS, MOTORBIKE SUITS, SPORTS/ATHLETIC CLOTHING, HEADWEAR, HEADGEAR, HATS, HEAD BANDS, BUCKLES, CUFFS, SHAWLS, SCARVES, GLOVES, FOOTWEAR, INCLUDING SHOES, SANDALS, MOCCASINS, MULES, SNEAKERS, ATHLETIC FOOTWEAR, BEACH FOOTWEAR, SLIPPERS, SANDALS, BOOTS, (BASED UPON 1(B)) COMPUTERIZED ON-LINE RETAIL STORE SERVICES IN THE FIELDS OF PERFUMES, BLEACHING PREPARATIONS AND OTHER SUBSTANCES FOR LAUNDRY USE, CLEANING, POLISHING, SCOURING AND ABRASIVE PREPARATIONS, SOAPS, PERFUMERY, TOILETRIES, ESSENTIAL OILS, COSMETICS, HAIR LOTIONS, DENTIFRICES, PHOTOGRAPHIC, CINEMATOGRAPHIC, OPTICAL, WEIGHING, SIGNALING APPARATUS AND INSTRUMENTS, APPARATUS FOR RECORDING, TRANSMISSION OR REPRODUCTION OF SOUND OR IMAGES, MAGNETIC DATA CARRIERS, RECORDING DISCS, CALCULATING MACHINES, DATA PROCESSING EQUIPMENT AND COMPUTERS, DVD'S, SOFTWARE, VHS AUDIO AND VIDEO RECORDINGS, COMPUTER GAMES, PRECIOUS METALS AND THEIR ALLOYS AND GOODS OF PRECIOUS METALS OR COATED THEREWITH, LAMPS, PRECIOUS STONES, HOROLOGICAL AND CHRONOMETRIC INSTRUMENTS, PAPER, CARDBOARD AND GOODS MADE OF THESE MATERIALS, PRINTED MATTER, STATIONERY, ADHESIVES FOR STATIONERY, PLASTIC MATERIALS FOR PACKAGING, PRINTERS' TYPE, PRINTED BLOCKS, ANIMAL SKINS, HIDES, TRUNKS, PARASOLS, WALKING STICKS, WHIPS, LEASHES, BAGS FOR CARRYING ANIMALS, HANDBAGS, TEXTILE BAGS, SHOULDER BAGS, MARSUPIUM BAGS, POCHETTES, SHOPPING BAGS, BACKPACKS, WORKING BAGS, TRAVEL BAGS, TROLLEY, BEAUTY CASES, FURNITURE FOR THE HOUSE AND FOR THE GARDEN, MIRRORS, PICTURE FRAMES, CHAIRS, TABLES, HOUSEHOLD OR KITCHEN UTENSILS AND CONTAINERS, GLASSWARE, GOODS MADE OF PORCELAIN, GAMES AND PLAYTHINGS, GYMNASTIC AND SPORTING ARTICLES, DECORATIONS FOR CHRISTMAS TREES (U.S. CLS. 100, 101 AND 102).

FIRST USE 12-31-2002; IN COMMERCE 12-31-2002.
ANNE FARRELL, EXAMINING ATTORNEY

SN 78-867,921. LUXURY LINK, LLC, LOS ANGELES, CA.
FILED 4-24-2006.

LuxeLife

THE MARK CONSISTS OF STANDARD CHARACTERS WITHOUT CLAIM TO ANY PARTICULAR FONT, STYLE, SIZE, OR COLOR.

FOR ONLINE AUCTION SERVICE; COMPUTERIZED ONLINE ORDERING SERVICE FEATURING THE DISTRIBUTION OF JEWELRY, WATCHES, HANDBAGS, LUGGAGE, WINE AND CONSUMER ELECTRONICS (U.S. CLS. 100, 101 AND 102).

FIRST USE 3-9-2006; IN COMMERCE 3-9-2006.
CHRIS WELLS, EXAMINING ATTORNEY

CLASS 35—(Continued).

SN 78-868,003. HOFFMEISTER, COLIN, W, NORTHAMPTON, MA. FILED 4-24-2006.

SunMeister

THE MARK CONSISTS OF STANDARD CHARACTERS WITHOUT CLAIM TO ANY PARTICULAR FONT, STYLE, SIZE, OR COLOR.

FOR CONCEPT AND BRAND DEVELOPMENT IN THE FIELD OF SUN PROTECTION PRODUCTS FEATURING CLOTHING, COSMETICS AND SKIN PREPARATIONS, AND PROTECTIVE GEAR (U.S. CLS. 100, 101 AND 102).
ODESSA BIBBINS, EXAMINING ATTORNEY

SN 78-868,059. BIG BLUE MARBLE SPORTS, INC., POCASSETT, MA. FILED 4-24-2006.

BIG BLUE MARBLE SPORTS

THE MARK CONSISTS OF STANDARD CHARACTERS WITHOUT CLAIM TO ANY PARTICULAR FONT, STYLE, SIZE, OR COLOR.

NO CLAIM IS MADE TO THE EXCLUSIVE RIGHT TO USE "SPORTS", APART FROM THE MARK AS SHOWN.

FOR DISTRIBUTORSHIP SERVICES FEATURING WATER SPORTS EQUIPMENT AND ACCESSORIES, INCLUDING BODYBOARDS, SURF FINS, RASH GUARDS, APPAREL, WETSUITS, AND SUN CARE PRODUCTS (U.S. CLS. 100, 101 AND 102).

FIRST USE 4-1-2005; IN COMMERCE 4-1-2005.
WILLIAM P. SHANAHAN, EXAMINING ATTORNEY

SN 78-868,063. INSTITUTE FOR SAFE MEDICATION PRACTICES, HUNTINGDON VALLEY, PA. FILED 4-24-2006.

MONIT-ERR

THE MARK CONSISTS OF STANDARD CHARACTERS WITHOUT CLAIM TO ANY PARTICULAR FONT, STYLE, SIZE, OR COLOR.

FOR MONITORING SERVICES NAMELY POST MARKETING SURVEILLANCE SERVICES TO DETECT ADVERSE DRUG EVENTS RELATED TO MEDICATION ERRORS FOR BUSINESS PURPOSES (U.S. CLS. 100, 101 AND 102).

GRETTA YAO, EXAMINING ATTORNEY

CLASS 35—(Continued).

SN 78-868,076. INSTITUTE FOR SAFE MEDICATION PRACTICES, HUNTINGDON VALLEY, PA. FILED 4-24-2006.

CLASS 35—(Continued).

SN 78-868,513. NATIONAL HEALTH PARTNERS, INC., HORSHAM, PA. FILED 4-24-2006.

EVALUATE-ERR



THE MARK CONSISTS OF STANDARD CHARACTERS WITHOUT CLAIM TO ANY PARTICULAR FONT, STYLE, SIZE, OR COLOR.

FOR SERVICES FOR EVALUATION OF ADVERSE DRUG EVENTS RELATED TO MEDICATION ERRORS FOR BUSINESS PURPOSES (U.S. CLS. 100, 101 AND 102).
GRETTA YAO, EXAMINING ATTORNEY

NO CLAIM IS MADE TO THE EXCLUSIVE RIGHT TO USE QUALITY HEALTHCARE, APART FROM THE MARK AS SHOWN.

THE LINING IS A FEATURE OF THE MARK AND DOES NOT INDICATE COLOR.

THE MARK CONSISTS OF AN ARROW INSIDE A CIRCLE.

FOR ADMINISTRATION OF A DISCOUNT PROGRAM FOR ENABLING PARTICIPANTS TO OBTAIN DISCOUNTS ON HEALTH CARE GOODS AND SERVICES THROUGH USE OF A DISCOUNT MEMBERSHIP CARD (U.S. CLS. 100, 101 AND 102).

FIRST USE 6-30-2001; IN COMMERCE 6-30-2001.
JOHN HWANG, EXAMINING ATTORNEY

SN 78-868,119. SRDS, INC., DES PLAINES, IL. FILED 4-24-2006.

SN 78-868,748. VALLON, LLC, MINNEAPOLIS, MN. FILED 4-25-2006.

MY SRDS PROJECT MANAGER

EXECUTIVE BENCH STRENGTH

THE MARK CONSISTS OF STANDARD CHARACTERS WITHOUT CLAIM TO ANY PARTICULAR FONT, STYLE, SIZE, OR COLOR.

OWNER OF U.S. REG. NOS. 1,685,263, 2,939,758 AND OTHERS.

NO CLAIM IS MADE TO THE EXCLUSIVE RIGHT TO USE PROJECT MANAGER, APART FROM THE MARK AS SHOWN.

FOR BUSINESS INFORMATION DELIVERED VIA THE INTERNET, NAMELY, BUDGETING, SCHEDULING, TRACKING AND ORDERING INFORMATION, DIRECTED TO PLANNERS AND PURCHASERS OF ADVERTISING SPACE (U.S. CLS. 100, 101 AND 102).
KATHERINE STOIDES, EXAMINING ATTORNEY

THE MARK CONSISTS OF STANDARD CHARACTERS WITHOUT CLAIM TO ANY PARTICULAR FONT, STYLE, SIZE, OR COLOR.

NO CLAIM IS MADE TO THE EXCLUSIVE RIGHT TO USE "EXECUTIVE", APART FROM THE MARK AS SHOWN.

FOR STAFFING SERVICES IN THE FIELDS OF FINANCE, OPERATIONS, SALES MANAGEMENT, MARKETING MANAGEMENT, INFORMATION TECHNOLOGY SYSTEMS AND HUMAN RESOURCES (U.S. CLS. 100, 101 AND 102).

FIRST USE 4-20-2006; IN COMMERCE 4-20-2006.
ALEXANDER L. POWERS, EXAMINING ATTORNEY

CLASS 35—(Continued).

SN 78-868,767. POOLAH, LLC, ATLANTA, GA. FILED 4-25-2006.



THE MARK CONSISTS OF A CIRCLE CONTAINING CONCENTRIC CIRCLES AND THE WORD POOLAH.
FOR CONCERT PROMOTION SERVICES FOR OTHERS; ON-LINE CONCERT PROMOTION SERVICES FOR OTHERS; CONCERT TICKET AGENCY SERVICES; ON-LINE RETAIL STORE SERVICES FEATURING CONCERT TICKETS, MUSICAL SOUND AND VIDEO RECORDINGS, DOWNLOADABLE PRE-RECORDED MUSIC AND VIDEO, CLOTHING, AND POSTERS; CONDUCTING CONTESTS AND POLLS TO PROMOTE CONCERTS AND MUSIC EVENTS; ONLINE VOTING IN PROMOTION OF CONCERTS AND MUSIC EVENTS (U.S. CLS. 100, 101 AND 102).
SCOTT BALDWIN, EXAMINING ATTORNEY

CLASS 35—(Continued).

SN 78-868,781. POOLAH, LLC, ATLANTA, GA. FILED 4-25-2006.

WHERE YOUR VOICE IS HEARD

THE MARK CONSISTS OF STANDARD CHARACTERS WITHOUT CLAIM TO ANY PARTICULAR FONT, STYLE, SIZE, OR COLOR.
FOR CONCERT PROMOTION SERVICES FOR OTHERS; ON-LINE CONCERT PROMOTION SERVICES FOR OTHERS; CONCERT TICKET AGENCY SERVICES; ON-LINE RETAIL STORE SERVICES FEATURING CONCERT TICKETS, MUSICAL SOUND AND VIDEO RECORDINGS, DOWNLOADABLE PRE-RECORDED MUSIC AND VIDEO, CLOTHING, AND POSTERS; CONDUCTING CONTESTS AND POLLS TO PROMOTE CONCERTS AND MUSIC EVENTS; ONLINE VOTING IN PROMOTION OF CONCERTS AND MUSIC EVENTS (U.S. CLS. 100, 101 AND 102).
SCOTT BALDWIN, EXAMINING ATTORNEY

SN 78-868,778. POOLAH, LLC, ATLANTA, GA. FILED 4-25-2006.



THE MARK CONSISTS OF A CIRCLE CONTAINING CONCENTRIC CIRCLES.
FOR CONCERT PROMOTION SERVICES FOR OTHERS; ON-LINE CONCERT PROMOTION SERVICES FOR OTHERS; CONCERT TICKET AGENCY SERVICES; ON-LINE RETAIL STORE SERVICES FEATURING CONCERT TICKETS, MUSICAL SOUND AND VIDEO RECORDINGS, DOWNLOADABLE PRE-RECORDED MUSIC AND VIDEO, CLOTHING, AND POSTERS; CONDUCTING CONTESTS AND POLLS TO PROMOTE CONCERTS AND MUSIC EVENTS; ONLINE VOTING IN PROMOTION OF CONCERTS AND MUSIC EVENTS (U.S. CLS. 100, 101 AND 102).
SCOTT BALDWIN, EXAMINING ATTORNEY

SN 78-868,789. PUREFUN, INC, GLOUCESTER, MA. FILED 4-25-2006.

PUREFUN

THE MARK CONSISTS OF STANDARD CHARACTERS WITHOUT CLAIM TO ANY PARTICULAR FONT, STYLE, SIZE, OR COLOR.
FOR ADVERTISING, MARKETING AND PROMOTION SERVICES; BUSINESS MARKETING SERVICES; COOPERATIVE ADVERTISING AND MARKETING; DEVELOPMENT OF MARKETING STRATEGIES AND CONCEPTS; GENERAL BUSINESS MERCHANDISING SERVICES, NAMELY, MARKETING; ON-LINE RETAIL STORE SERVICES FEATURING SANITARY BOOKS AND TOYS FOR MEDICAL OFFICES; PROVIDING ADVERTISING, MARKETING AND PROMOTIONAL SERVICES FOR THE PHARMACEUTICAL AND MEDICAL INDUSTRY; WHOLESALE DISTRIBUTORSHIPS FEATURING SANITARY BOOKS AND TOYS FOR MEDICAL OFFICES (U.S. CLS. 100, 101 AND 102).
FIRST USE 5-31-2005; IN COMMERCE 2-23-2006.
SCOTT BALDWIN, EXAMINING ATTORNEY

CLASS 35—(Continued).

SN 78-868,805. BLOEMHARD, REMKO, URBANA, OH. FILED 4-25-2006.



FOR DATABASE MANAGEMENT; DISPLAYING ADVERTISEMENTS FOR OTHERS (U.S. CLS. 100, 101 AND 102).

ELIZABETH PIGNATELLO, EXAMINING ATTORNEY



SN 78-868,812. ROLLING STONE, L.L.C., ENGLEWOOD, CO. FILED 4-25-2006.

ROLLING STONE

THE MARK CONSISTS OF STANDARD CHARACTERS WITHOUT CLAIM TO ANY PARTICULAR FONT, STYLE, SIZE, OR COLOR.

FOR FRANCHISE SERVICES, NAMELY, OFFERING TECHNICAL AND BUSINESS MANAGEMENT ASSISTANCE IN THE ESTABLISHMENT AND OPERATION OF BUSINESSES THAT SELL AND DISTRIBUTE CHEF TOOLS AND CUTLERY, AND THAT PROVIDE MOBILE SHARPENING SERVICES (U.S. CLS. 100, 101 AND 102). FIRST USE 1-1-2000; IN COMMERCE 4-18-2001.

ELIZABETH PIGNATELLO, EXAMINING ATTORNEY

CLASS 35—(Continued).

SN 78-868,882. TAMURA, CARY K, NAPA, CA. FILED 4-25-2006.

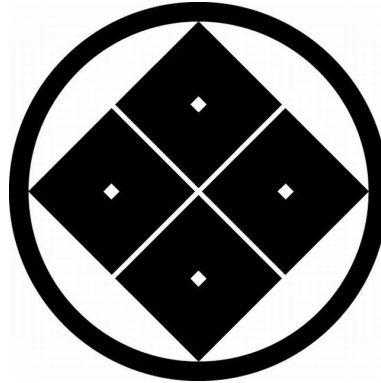

THE MARK CONSISTS OF A CIRCLE WITHIN WHICH ARE FOUR SQUARES OF EQUAL SIZE ADJACENT TO, BUT SLIGHTLY SEPARATE FROM ONE ANOTHER TO FORM ANOTHER LARGER SQUARE WHOSE CORNERS CONTACT THE INTERIOR OF THE CIRCLE AT THE TOP, BOTTOM, LEFT AND RIGHT. WITHIN EACH OF THE FOUR SQUARES IS A SMALLER SQUARE SET WITH ITS EDGES PARALLEL TO THE EDGES OF THE SQUARE WITHIN WHICH EACH IS SET.

FOR LICENSING CONSULTATION IN CONNECTION WITH THE PRODUCTION, BOTTLING, MARKETING AND SALE OF WINE AND WINE RELATED BEVERAGES IN COMPLIANCE WITH EXISTING FEDERAL AND STATE REGULATIONS (U.S. CLS. 100, 101 AND 102).

ALLISON HOLTZ, EXAMINING ATTORNEY



SN 78-869,113. QUANTIFIED MARKETING GROUP, LLC, HEATHROW, FL. FILED 4-25-2006.



THE MARK CONSISTS OF STYLIZED PINEAPPLE. FOR DEVELOPMENT OF MARKETING STRATEGIES AND CONCEPTS FOR RESTAURANTS; ADVERTISING AND MARKETING SERVICES FOR RESTAURANTS; PUBLIC RELATIONS SERVICES FOR RESTAURANTS; CONCEPT AND BRAND DEVELOPMENT AND DESIGN FOR RESTAURANTS (U.S. CLS. 100, 101 AND 102). FIRST USE 11-30-2002; IN COMMERCE 11-30-2002.

KATHERINE STOIDES, EXAMINING ATTORNEY

CLASS 35—(Continued).

SN 78-869,208. BAIN & COMPANY, INC., BOSTON, MA.
FILED 4-25-2006.

RxAPID

THE MARK CONSISTS OF STANDARD CHARACTERS WITHOUT CLAIM TO ANY PARTICULAR FONT, STYLE, SIZE, OR COLOR.
FOR BUSINESS MANAGEMENT AND CONSULTING SERVICES (U.S. CLS. 100, 101 AND 102).
TINA L. SNAPP, EXAMINING ATTORNEY

SN 78-869,302. FORBES PARK LAND OWNERS ASSOCIATION, FORT GARLAND, CO. FILED 4-25-2006.

Forbes Park

THE MARK CONSISTS OF STANDARD CHARACTERS WITHOUT CLAIM TO ANY PARTICULAR FONT, STYLE, SIZE, OR COLOR.
FOR ASSOCIATION SERVICES— NAMELY-PROMOTING THE INTERESTS OF LAND AND HOME OWNERS (U.S. CLS. 100, 101 AND 102).
FIRST USE 3-19-1976; IN COMMERCE 3-19-1976.
DAVID C. REIHNER, EXAMINING ATTORNEY

SN 78-869,407. WEBVENTA, INC., EVANSVILLE, IN. FILED 4-25-2006.

AllMyEggs

THE MARK CONSISTS OF STANDARD CHARACTERS WITHOUT CLAIM TO ANY PARTICULAR FONT, STYLE, SIZE, OR COLOR.
FOR ADVERTISING AND COMMERCIAL INFORMATION SERVICES, VIA THE INTERNET; ADVERTISING AND MARKETING; ADVERTISING VIA ELECTRONIC MEDIA AND SPECIFICALLY THE INTERNET; ADVERTISING, MARKETING AND PROMOTION SERVICES (U.S. CLS. 100, 101 AND 102).
ROBIN CHOSID, EXAMINING ATTORNEY

CLASS 35—(Continued).

SN 78-869,550. STULBERGER, JONATHAN, CHATSWORTH, CA. FILED 4-25-2006.

GOT KUSH?

THE MARK CONSISTS OF STANDARD CHARACTERS WITHOUT CLAIM TO ANY PARTICULAR FONT, STYLE, SIZE, OR COLOR.
OWNER OF U.S. REG. NO. 3,033,283.
SEC. 2(F).
FOR MAIL ORDER SERVICES FEATURING T-SHIRTS, HATS, AND SWEATSHIRTS; ON-LINE RETAIL STORE SERVICES FEATURING T-SHIRTS, HATS, AND SWEATSHIRTS (U.S. CLS. 100, 101 AND 102).
FIRST USE 12-8-2000; IN COMMERCE 1-20-2001.
HEATHER THOMPSON, EXAMINING ATTORNEY

SN 78-869,553. WINECOMMUNE.COM, LLC, OAKLAND, CA. FILED 4-25-2006.

WINECOMMUNE

THE MARK CONSISTS OF STANDARD CHARACTERS WITHOUT CLAIM TO ANY PARTICULAR FONT, STYLE, SIZE, OR COLOR.
FOR ARRANGING AND CONDUCTING OF AUCTION SALES; ORGANIZATION OF INTERNET AUCTIONS; PROVIDING A WEBSITE AT WHICH USERS CAN OFFER GOODS FOR SALE AND BUY GOODS OFFERED BY OTHERS (U.S. CLS. 100, 101 AND 102).
FIRST USE 4-30-1999; IN COMMERCE 4-30-1999.
H. M. FISHER, EXAMINING ATTORNEY

SN 78-869,683. WORKFORCE CAROLINA, INC., MOUNT AIRY, NC. FILED 4-26-2006.

WORKFORCE CAROLINA

THE MARK CONSISTS OF STANDARD CHARACTERS WITHOUT CLAIM TO ANY PARTICULAR FONT, STYLE, SIZE, OR COLOR.
OWNER OF U.S. REG. NO. 2,443,584.
SEC. 2(F).
FOR EMPLOYMENT SERVICES, NAMELY, TEMPORARY PERSONNEL PLACEMENT AND RECRUITMENT (U.S. CLS. 100, 101 AND 102).
FIRST USE 8-23-1999; IN COMMERCE 8-23-1999.
DAYNA BROWNE, EXAMINING ATTORNEY

CLASS 35—(Continued).

SN 78-870,001. BIG BLUE MARBLE SPORTS, INC., POCASSETT, MA. FILED 4-26-2006.

WE GET THE SPORT. WE GET
THE GEAR.

THE MARK CONSISTS OF STANDARD CHARACTERS WITHOUT CLAIM TO ANY PARTICULAR FONT, STYLE, SIZE, OR COLOR.

FOR DISTRIBUTORSHIP SERVICES FEATURING WATER SPORTS EQUIPMENT AND ACCESSORIES, INCLUDING BODYBOARDS, SURF FINNS, RASH GUARDS, APPAREL, WET SUITS, AND SUN CARE PRODUCTS (U.S. CLS. 100, 101 AND 102).

FIRST USE 4-1-2005; IN COMMERCE 4-1-2005.
WILLIAM P. SHANAHAN, EXAMINING ATTORNEY

SN 78-870,065. WINECOMMUNE.COM, LLC, OAKLAND, CA. FILED 4-26-2006.

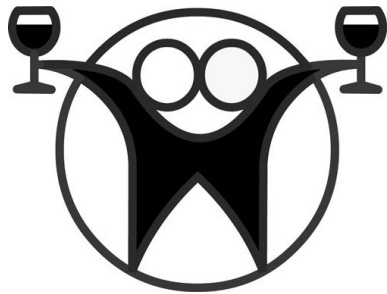

FOR ARRANGING AND CONDUCTING OF AUCTION SALES; ORGANIZATION OF INTERNET AUCTIONS; PROVIDING A WEBSITE AT WHICH USERS CAN OFFER GOODS FOR SALE AND BUY GOODS OFFERED BY OTHERS (U.S. CLS. 100, 101 AND 102).

FIRST USE 11-0-2001; IN COMMERCE 11-0-2001.
H. M. FISHER, EXAMINING ATTORNEY

SN 78-870,102. PATTERSON MEDICAL PRODUCTS, INC., BOLINGBROOK, IL. FILED 4-26-2006.

PERFORMANCE PLUS

THE MARK CONSISTS OF STANDARD CHARACTERS WITHOUT CLAIM TO ANY PARTICULAR FONT, STYLE, SIZE, OR COLOR.

FOR ONLINE ORDERING SERVICES AND CATALOG SERVICES FEATURING PRODUCTS IN THE FIELD OF SPORTS MEDICINE, STRENGTH TRAINING, FITNESS TRAINING, CONDITIONING, AND FIRST AID (U.S. CLS. 100, 101 AND 102).

DEIRDRE ROBERTSON, EXAMINING ATTORNEY

CLASS 35—(Continued).

SN 78-870,173. SPECTRUM NETWORKS, INC., CINCINNATI, OH. FILED 4-26-2006.



OWNER OF U.S. REG. NO. 2,912,134.

NO CLAIM IS MADE TO THE EXCLUSIVE RIGHT TO USE "INC" AND "COMMUNICATIONS", APART FROM THE MARK AS SHOWN.

THE MARK CONSISTS OF CIRCLE DIVIDED BY A STYLIZED "S".

FOR BUSINESS MANAGEMENT AND CONSULTATION SERVICES FOR OTHERS, NAMELY, PROVIDING ACCOUNT AUDITING, BUSINESS RESEARCH, BUSINESS FACILITY RELOCATION, AND BID ANALYSIS, ALL RELATED TO CUSTOMERS' THIRD-PARTY PROVIDED TELECOMMUNICATIONS SERVICES (U.S. CLS. 100, 101 AND 102).

FIRST USE 3-10-2006; IN COMMERCE 3-10-2006.
JILL C. ALT, EXAMINING ATTORNEY

SN 78-870,333. ACXESS INC., BOCA RATON, FL. FILED 4-26-2006.

AcXess

THE MARK CONSISTS OF STANDARD CHARACTERS WITHOUT CLAIM TO ANY PARTICULAR FONT, STYLE, SIZE, OR COLOR.

FOR DISASTER RECOVERY SERVICES, NAMELY, BUSINESS PLANNING AND BUSINESS CONTINUITY SERVICES (U.S. CLS. 100, 101 AND 102).

FIRST USE 1-12-2005; IN COMMERCE 1-12-2005.
TINA L. SNAPP, EXAMINING ATTORNEY

SN 78-870,420. COPYRIGHT CLEARANCE CENTER, INC., DANVERS, MA. FILED 4-26-2006.

RIGHTSPHERE

THE MARK CONSISTS OF STANDARD CHARACTERS WITHOUT CLAIM TO ANY PARTICULAR FONT, STYLE, SIZE, OR COLOR.

FOR MANAGING LICENSED RIGHTS FOR USERS OF THE COPYRIGHTED WORKS OF OTHERS (U.S. CLS. 100, 101 AND 102).

H. M. FISHER, EXAMINING ATTORNEY

CLASS 35—(Continued).

SN 78-870,467. MARKOFF, NICHOLAS, CENTERVILLE, OH.
FILED 4-26-2006.

Noogle, Noogles

THE MARK CONSISTS OF STANDARD CHARACTERS
WITHOUT CLAIM TO ANY PARTICULAR FONT, STYLE,
SIZE, OR COLOR.

FOR RETAIL APPAREL STORES (U.S. CLS. 100, 101
AND 102).

NAKIA HENRY, EXAMINING ATTORNEY

SN 78-870,551. BIOCOCOM/SAN DIEGO, SAN DIEGO, CA.
FILED 4-26-2006.

BIOCOCOM

THE MARK CONSISTS OF STANDARD CHARACTERS
WITHOUT CLAIM TO ANY PARTICULAR FONT, STYLE,
SIZE, OR COLOR.

OWNER OF U.S. REG. NO. 3,128,608.

FOR ASSOCIATION SERVICES, NAMELY PROMOT-
ING THE INTERESTS OF INDIVIDUALS AND COMPAN-
IES IN THE LIFE SCIENCES FIELD (U.S. CLS. 100, 101
AND 102).

FIRST USE 4-20-1993; IN COMMERCE 4-20-1993.

MARIA-VICTORIA SUAREZ, EXAMINING ATTORNEY

SN 78-870,591. SPLOTCH LLC, DALLAS, TX. FILED 4-26-
2006.



THE MARK CONSISTS OF STYLIZED TEXT OF THE
WORDING SPLOTCH.

FOR ON-LINE RETAIL STORE SERVICES FEATUR-
ING T-SHIRTS (U.S. CLS. 100, 101 AND 102).

FIRST USE 4-20-2004; IN COMMERCE 7-0-2005.

RAUL CORDOVA, EXAMINING ATTORNEY

CLASS 35—(Continued).

SN 78-870,598. LUCIDUX SOLUTIONS INCORPORATED,
MIAMI, FL. FILED 4-26-2006.

ALTERSHOPS

THE MARK CONSISTS OF STANDARD CHARACTERS
WITHOUT CLAIM TO ANY PARTICULAR FONT, STYLE,
SIZE, OR COLOR.

FOR ARRANGING AND CONDUCTION OF AUCTION
SALES; AUCTION MANAGEMENT SERVICES PRO-
VIDED TO OTHERS OVER AN ONLINE WEB SITE
ACCESSED THROUGH A GLOBAL COMPUTER NET-
WORK; AUCTIONING VIA TELECOMMUNICATION
NETWORKS; COMPUTERIZED ONLINE ORDERING
FEATURING GENERAL MERCHANDISE AND GENER-
AL CONSUMER GOODS; DISSEMINATION OF ADVER-
TISING FOR OTHERS VIA AN ONLINE
COMMUNICATIONS NETWORK ON THE INTERNET;
ON-LINE TRADING SERVICES IN WHICH SELLER
POSTS PRODUCTS TO BE AUCTIONED AND BIDDING
IS DONE VIA THE INTERNET; ONLINE CONSIGN-
MENT SERVICES WHEREBY GOODS ARE RECEIVED
ON CONSIGNMENT FOR AUCTION ON AN ONLINE
AUCTION SITE; ORGANISATION OF INTERNET AU-
CTIONS; PROVIDING A SEARCHABLE ONLINE ADVER-
TISING GUIDE FEATURING THE GOODS AND
SERVICES OF OTHER ONLINE VENDORS ON THE
INTERNET (U.S. CLS. 100, 101 AND 102).

JASON ROTH, EXAMINING ATTORNEY

SN 78-870,913. AERO-ZONE INCORPORATED, MESA, AZ.
FILED 4-27-2006.

AERO-ZONE

THE MARK CONSISTS OF STANDARD CHARACTERS
WITHOUT CLAIM TO ANY PARTICULAR FONT, STYLE,
SIZE, OR COLOR.

FOR PROCUREMENT, NAMELY, PURCHASING OF
AIRCRAFT PARTS, AIRCRAFT EQUIPMENT SERVICES
AND AIRCRAFT ACCESSORIES FOR OTHERS (U.S.
CLS. 100, 101 AND 102).

FIRST USE 6-1-1994; IN COMMERCE 6-1-1994.

KELLY MCCOY, EXAMINING ATTORNEY

SN 78-871,005. LOCKHEED MARTIN CORPORATION,
BETHESDA, MD. FILED 4-27-2006.

LIGHTNING II

THE MARK CONSISTS OF STANDARD CHARACTERS
WITHOUT CLAIM TO ANY PARTICULAR FONT, STYLE,
SIZE, OR COLOR.

FOR PROMOTING THE INTEREST OF THE PUBLIC
IN THE FIELD OF AERONAUTICS AND AVIATION
(U.S. CLS. 100, 101 AND 102).

PAULA MAYS, EXAMINING ATTORNEY

CLASS 35—(Continued).

SN 78-871,057. CHOICEPOINT ASSET COMPANY, ALPHARETTA, GA. FILED 4-27-2006.

CADIA

THE MARK CONSISTS OF STANDARD CHARACTERS WITHOUT CLAIM TO ANY PARTICULAR FONT, STYLE, SIZE, OR COLOR.

FOR BUSINESS CONSULTING AND INFORMATION SERVICES; PROVIDING STATISTICAL AND DEMOGRAPHIC INFORMATION (U.S. CLS. 100, 101 AND 102). WILLIAM BRECKENFELD, EXAMINING ATTORNEY

SN 78-871,069. AMERICAN ACADEMY OF COSMETIC DENTISTRY, MADISON, WI. FILED 4-27-2006.

FOR ASSOCIATION SERVICES, NAMELY PROMOTING THE INTERESTS OF COSMETIC DENTISTS (U.S. CLS. 100, 101 AND 102).

FIRST USE 6-6-1985; IN COMMERCE 6-6-1985. JENNIFER MARTIN, EXAMINING ATTORNEY

SN 78-871,210. LAWFIRM STAFF, PASADENA, CA. FILED 4-27-2006.

NO CLAIM IS MADE TO THE EXCLUSIVE RIGHT TO USE "LAWFIRMSTAFF", APART FROM THE MARK AS SHOWN.

THE MARK CONSISTS OF A CIRCLE, SURROUNDED BY 4 SHAPES, EACH CONSISTING OF A SQUARE WITH A SMALL APPENDAGE FACING COUNTER-CLOCKWISE AROUND THE CIRCLE, AND THE BOTTOM ONE CONTAINING WITHIN IT THE OUTLINE OF A TIE, GIVING THE IMPRESSION OF A PERSON, AND WITH "LAWFIRMSTAFF" APPEARING TO THE RIGHT, WITH THE LAST FIVE LETTERS IN BOLD FONT.

FOR EMPLOYMENT HIRING, RECRUITING, PLACEMENT, STAFFING AND CAREER NETWORKING SERVICES (U.S. CLS. 100, 101 AND 102).

FIRST USE 2-3-2006; IN COMMERCE 2-3-2006. WILLIAM ROSSMAN, EXAMINING ATTORNEY

CLASS 35—(Continued).

SN 78-871,616. M & A GROUP, LLC, ORO VALLEY, AZ. FILED 4-27-2006.

HELPING PEOPLE ON THE WAY
UP!

THE MARK CONSISTS OF STANDARD CHARACTERS WITHOUT CLAIM TO ANY PARTICULAR FONT, STYLE, SIZE, OR COLOR.

FOR OFFERING LEASE-TO-OWN REAL ESTATE PROGRAMS TO PROSPECTIVE HOME BUYERS (U.S. CLS. 100, 101 AND 102).

FIRST USE 12-31-2005; IN COMMERCE 12-31-2005. CIMMERIAN COLEMAN, EXAMINING ATTORNEY

SN 78-871,702. XCD PERFORMANCE CONSULTING, BELLE MEAD, NJ. FILED 4-27-2006.

NO CLAIM IS MADE TO THE EXCLUSIVE RIGHT TO USE "PERFORMANCE CONSULTING", APART FROM THE MARK AS SHOWN.

THE COLOR(S) BLUE AND ORANGE/BROWN IS/ARE CLAIMED AS A FEATURE OF THE MARK.

THE MARK CONSISTS OF THE LETTERS XCD, WHICH APPEAR IN ORANGE/BROWN, AND THE WORDS PERFORMANCE CONSULTING, WHICH APPEAR IN BLUE. TO THE LEFT OF THE WORDS XCD PERFORMANCE CONSULTING APPEARS A TILTED, STYLIZED FORM OF THE LETTER D IN BLUE AND A TILTED, STYLIZED FORM OF THE LETTER C IN ORANGE/BROWN. A PORTION OF EACH OF THE STYLIZED LETTERS INTERSECTS TO FORM AN X.

FOR MANAGEMENT AND BUSINESS CONSULTING SERVICES IN THE FIELD OF SUPPLY CHAIN, ENGINEERED LABOR STANDARDS, SOFTWARE SELECTION AND IMPLEMENTATION, AND PROCESS DESIGN AND IMPROVEMENT (U.S. CLS. 100, 101 AND 102).

FIRST USE 11-11-2002; IN COMMERCE 2-1-2003. TINA L. SNAPP, EXAMINING ATTORNEY

CLASS 35—(Continued).

SN 78-871,757. HOODLOVE LIMITED LIABILITY COMPANY, EAST ORANGE, NJ. FILED 4-28-2006.

HOOD LOVE

THE MARK CONSISTS OF STANDARD CHARACTERS WITHOUT CLAIM TO ANY PARTICULAR FONT, STYLE, SIZE, OR COLOR.

FOR PROVIDING AN ONLINE COMMERCIAL INFORMATION DIRECTORY ON THE INTERNET (U.S. CLS. 100, 101 AND 102).

BARBARA BROWN, EXAMINING ATTORNEY

SN 78-871,758. HOODLOVE LIMITED LIABILITY COMPANY, EAST ORANGE, NJ. FILED 4-28-2006.



THE MARK CONSISTS OF THE WORDING HOOD LOVE AND HL WITHIN A STYLIZED DESIGN.

FOR PROVIDING AN ONLINE COMMERCIAL INFORMATION DIRECTORY ON THE INTERNET (U.S. CLS. 100, 101 AND 102).

BARBARA BROWN, EXAMINING ATTORNEY

CLASS 35—(Continued).

SN 78-873,080. TOUCHÉ, LLC, MIFFLINBURG, PA. FILED 5-1-2006.

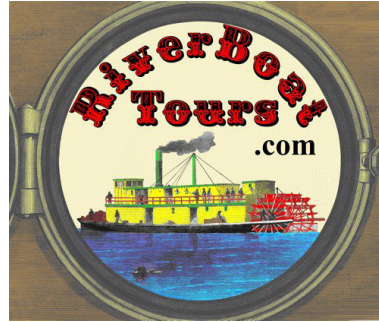

NO CLAIM IS MADE TO THE EXCLUSIVE RIGHT TO USE "RIVERBOAT TOURS .COM", APART FROM THE MARK AS SHOWN.

THE COLORS BROWN, BRASS, BLACK, BEIGE, RED, GRAY, GREEN, YELLOW, AND BLUE ARE CLAIMED AS A FEATURE OF THE MARK.

THE COLORS BROWN, BRASS, AND BLACK APPEAR ON THE DESIGN OF AN OPEN PORTHOLE, THROUGH WHICH THE REST OF THE MARK APPEARS. THE COLORS RED AND BLACK APPEAR ON THE STYLIZED WORDING RIVERBOAT TOURS AROUND THE TOP THIRD OF THE PORTHOLE, WITH A BEIGE BACKGROUND. THE LETTERING ".COM" APPEARS IN THE COLOR BLACK BELOW AND TO THE RIGHT OF THE WORD "TOURS". THE COLOR YELLOW APPEARS AS THE DESIGN OF A PADDLE-WHEEL STEAMBOAT TRIMMED IN RED, GREEN, AND BLACK, WITH A RED PADDLE-WHEEL, GRAY SMOKE, BROWN CARGO, GRAY ENTRYWAYS, AND PEOPLE APPEARING IN THE COLORS GRAY AND BLACK. THE COLOR BLUE APPEARS ON THE DESIGN OF A RIVER, WHICH COMPRISES THE LOWER THIRD OF THE PORTHOLE.

FOR DISSEMINATION OF ADVERTISING FOR OTHERS VIA THE INTERNET (U.S. CLS. 100, 101 AND 102).

SANDRA MANIOS, EXAMINING ATTORNEY

SN 78-873,477. PARAMOUNT VENDING, INC., POMPANO BEACH, FL. FILED 5-1-2006.



THE MARK CONSISTS OF THE WORD "PARAMOUNT" WITH RAYS COMING OUT OF THE LETTER "O".

FOR RENTAL OF VENDING MACHINES; VENDING MACHINE SERVICES (U.S. CLS. 100, 101 AND 102). FIRST USE 1-2-1930; IN COMMERCE 1-2-1930.

ANGELA M. MICHELI, EXAMINING ATTORNEY

CLASS 35—(Continued).

SN 78-873,643. MONKEE'S, LLC, WINSTON-SALEM, NC.
FILED 5-1-2006.

MONKEE'S

THE MARK CONSISTS OF STANDARD CHARACTERS WITHOUT CLAIM TO ANY PARTICULAR FONT, STYLE, SIZE, OR COLOR.

FOR RETAIL SHOPS FEATURING SHOES, BELTS, JEWELRY, HANDBAGS, SUNGLASSES AND ACCESSORIES (U.S. CLS. 100, 101 AND 102).

FIRST USE 8-0-1996; IN COMMERCE 8-0-1996.

JASON ROTH, EXAMINING ATTORNEY

CLASS 35—(Continued).

SN 78-874,350. REACH LEGAL, INC., RIVER FOREST, IL.
FILED 5-2-2006.

LEGALFEST

THE MARK CONSISTS OF STANDARD CHARACTERS WITHOUT CLAIM TO ANY PARTICULAR FONT, STYLE, SIZE, OR COLOR.

FOR CONDUCTING AN ON-LINE TRADE SHOW EXHIBITION, IN THE FIELD OF LEGAL AND LEGAL SUPPORT GOODS AND SERVICES (U.S. CLS. 100, 101 AND 102).

FIRST USE 4-7-2006; IN COMMERCE 4-7-2006.

DAVID H. STINE, EXAMINING ATTORNEY

SN 78-874,033. VINTAGE JAPANESE MOTORCYCLE CLUB NORTH AMERICA, INC., OLIVER SPRINGS, TN. FILED 5-2-2006.

VJMC

THE MARK CONSISTS OF STANDARD CHARACTERS WITHOUT CLAIM TO ANY PARTICULAR FONT, STYLE, SIZE, OR COLOR.

FOR ASSOCIATION SERVICES, NAMELY, PROMOTING THE SPORT OF MOTORCYCLING (U.S. CLS. 100, 101 AND 102).

FIRST USE 4-0-1978; IN COMMERCE 4-0-1978.

JAMES A. RAUEN, EXAMINING ATTORNEY

SN 78-874,363. SEK, KOSOL, P, ROSEVILLE, MN. FILED 5-2-2006.

NAME YOUR HOUSE VALUES

THE MARK CONSISTS OF STANDARD CHARACTERS WITHOUT CLAIM TO ANY PARTICULAR FONT, STYLE, SIZE, OR COLOR.

FOR REAL ESTATE MARKETING SERVICES, NAMELY, ON-LINE SERVICES FEATURING TOURS OF RESIDENTIAL AND COMMERCIAL REAL ESTATE (U.S. CLS. 100, 101 AND 102).

FIRST USE 12-30-2005; IN COMMERCE 12-30-2005.

AISHA CLARKE, EXAMINING ATTORNEY

SN 78-874,267. INFOTRADIX LLC, DEERFIELD BEACH, FL.
FILED 5-2-2006.

TRUSTMYBIZ

THE MARK CONSISTS OF STANDARD CHARACTERS WITHOUT CLAIM TO ANY PARTICULAR FONT, STYLE, SIZE, OR COLOR.

FOR PROVIDING ON-LINE DIRECTORY INFORMATION SERVICES ALSO FEATURING HYPERLINKS TO OTHER WEB SITES (U.S. CLS. 100, 101 AND 102).

FIRST USE 3-31-2006; IN COMMERCE 3-31-2006.

JOHN HWANG, EXAMINING ATTORNEY

SN 78-874,405. SEK, KOSOL, P, ROSEVILLE, MN. FILED 5-2-2006.

NoDiscount

THE MARK CONSISTS OF STANDARD CHARACTERS WITHOUT CLAIM TO ANY PARTICULAR FONT, STYLE, SIZE, OR COLOR.

FOR REAL ESTATE MARKETING SERVICES, NAMELY, ON-LINE SERVICES FEATURING TOURS OF RESIDENTIAL AND COMMERCIAL REAL ESTATE (U.S. CLS. 100, 101 AND 102).

FIRST USE 5-1-2001; IN COMMERCE 5-1-2001.

AISHA CLARKE, EXAMINING ATTORNEY

CLASS 35—(Continued).

SN 78-874,600. OPUSTONE LLC, MIAMI, FL. FILED 5-2-2006.

**BUILD A BETTER LIFESTYLE
FROM THE FLOOR UP**

THE MARK CONSISTS OF STANDARD CHARACTERS WITHOUT CLAIM TO ANY PARTICULAR FONT, STYLE, SIZE, OR COLOR.

FOR RETAIL STORE SERVICES FEATURING NATURAL STONE TILES, MARBLE SLABS, SINKS, PAVERS, COPING, STONE SEALERS, GLASS TILES, TABLES, COLUMNS, STATUES, DOORS (U.S. CLS. 100, 101 AND 102).

FIRST USE 4-18-2006; IN COMMERCE 4-18-2006.
KIMBERLY PERRY, EXAMINING ATTORNEY

SN 78-874,639. GRENZEBACH, GLIER & ASSOCIATES, INC., CHICAGO, IL. FILED 5-2-2006.



NO CLAIM IS MADE TO THE EXCLUSIVE RIGHT TO USE "DATA" AND "DIAGNOSTICS", APART FROM THE MARK AS SHOWN.

THE COLOR(S) GREEN, YELLOW, RED AND BLACK IS/ ARE CLAIMED AS A FEATURE OF THE MARK.

THE MARK CONSISTS OF THE SHAPE OF THE LETTER "D" CONSISTING OF RED, GREEN AND YELLOW DOTS; TO THE RIGHT OF THE "D" IS THE WORD "DONORSCAPE" IN GREEN LETTERS; UNDERNEATH THE WORD "DONORSCAPE" ARE THE WORDS "DATA", "DIAGNOSTICS", AND "DIRECTION" IN BLACK LETTERS SEPARATED BY THREE DOTS OF RED, GREEN AND YELLOW.

FOR MARKET RESEARCH SERVICES, NAMELY, TRACKING AND IDENTIFYING PROSPECTIVE DONORS FOR NON-PROFIT ORGANIZATIONS; MARKET RESEARCH CONSULTATION SERVICES (U.S. CLS. 100, 101 AND 102).

FIRST USE 4-1-2006; IN COMMERCE 4-1-2006.
AMY ALFIERI, EXAMINING ATTORNEY

SN 78-874,995. PREVO'S FAMILY MARKETS, INC., GRAND RAPIDS, MI. FILED 5-3-2006.

**EXCEPTIONAL QUALITY.
EXCEPTIONAL CHOICE.**

THE MARK CONSISTS OF STANDARD CHARACTERS WITHOUT CLAIM TO ANY PARTICULAR FONT, STYLE, SIZE, OR COLOR.

FOR SUPERMARKETS (U.S. CLS. 100, 101 AND 102).
ROBERT LAVACHE, EXAMINING ATTORNEY

CLASS 35—(Continued).

SN 78-875,271. SEK, KOSOL, P, ROSEVILLE, MN. FILED 5-3-2006.

NoDiscount P-R-O-C-E-S-S

THE MARK CONSISTS OF STANDARD CHARACTERS WITHOUT CLAIM TO ANY PARTICULAR FONT, STYLE, SIZE, OR COLOR.

FOR REAL ESTATE MARKETING SERVICES, NAMELY, ON-LINE SERVICES FEATURING TOURS OF RESIDENTIAL AND COMMERCIAL REAL ESTATE (U.S. CLS. 100, 101 AND 102).

FIRST USE 5-1-2001; IN COMMERCE 5-1-2001.
AISHA CLARKE, EXAMINING ATTORNEY

SN 78-875,468. INNOVATION INTERACTIVE, INC., NEW YORK, NY. FILED 5-3-2006.

SITEPARKER

THE MARK CONSISTS OF STANDARD CHARACTERS WITHOUT CLAIM TO ANY PARTICULAR FONT, STYLE, SIZE, OR COLOR.

FOR ADVERTISING AND MARKETING SERVICES, NAMELY PROVIDING DOMAIN NAME MANAGEMENT AND MONETIZATION SERVICES, INCLUDING PROVIDING DOMAIN NAME OWNERS WITH ALGORITHMS BASED ON FACTORS SUCH AS KEY TEMPLATES, CLICK THROUGH RATES AND COST PER CLICK RATES THAT RENDER THE HIGHEST PAGE YIELD FOR THE DOMAIN OWNER (U.S. CLS. 100, 101 AND 102).

FIRST USE 5-3-2006; IN COMMERCE 5-3-2006.
NAAKWAMA ANKRAH, EXAMINING ATTORNEY

SN 78-876,910. SEARS BRANDS, LLC, HOFFMAN ESTATES, IL. FILED 5-4-2006.

SIMPLY SEARS

THE MARK CONSISTS OF STANDARD CHARACTERS WITHOUT CLAIM TO ANY PARTICULAR FONT, STYLE, SIZE, OR COLOR.

OWNER OF U.S. REG. NOS. 1,529,006, 2,764,442 AND OTHERS.

FOR ONLINE RETAIL STORE SERVICES FEATURING GENERAL MERCHANDISE (U.S. CLS. 100, 101 AND 102).

REBECCA POVARCHUK, EXAMINING ATTORNEY

CLASS 35—(Continued).

SN 78-876,955. SEARS BRANDS, LLC, HOFFMAN ESTATES, IL. FILED 5-4-2006.

SIMPLY CAMPUS

THE MARK CONSISTS OF STANDARD CHARACTERS WITHOUT CLAIM TO ANY PARTICULAR FONT, STYLE, SIZE, OR COLOR.

FOR ONLINE RETAIL STORE SERVICES FEATURING HOME FASHIONS, CLOTHING, FURNISHINGS, STORAGE, OFFICE SUPPLIES AND EQUIPMENT, SMALL APPLIANCES, HOME DECORATIONS, GAMES, ELECTRONICS, VIDEOS, BOOKS, MUSIC AND TELEPHONES (U.S. CLS. 100, 101 AND 102).

REBECCA POVARCHUK, EXAMINING ATTORNEY

SN 78-881,660. CAVENDER INVESTMENT PROPERTIES, LTD, TYLER, TX. FILED 5-11-2006.



NO CLAIM IS MADE TO THE EXCLUSIVE RIGHT TO USE "WESTERN OUTFITTER", APART FROM THE MARK AS SHOWN.

THE COLORS BLACK, RED, AND WHITE ARE CLAIMED AS A FEATURE OF THE MARK.

THE WORD CAVENDER'S IS RED WITH A BLACK DOUBLE BORDER, THE WORDS WESTERN OUTFITTER ARE BLACK, THE STARS ARE BLACK AND WHITE.

THE MARK CONSISTS OF CAVENDERS IN RED LETTERS OUTLINED IN WHITE, WESTERN OUTFITTERS IN BLACK. ALL LETTERS ARE STYLIZED AND CAPITALIZED. THE W IN WESTERN AND THE O & R IN OUTFITTER IS/ARE LARGER CAPITAL LETTERS.

FOR RETAIL STORE SERVICES FEATURING CLOTHING AND BOOTS (U.S. CLS. 100, 101 AND 102).

FIRST USE 7-30-1998; IN COMMERCE 7-30-1998.
JOHN WILKE, EXAMINING ATTORNEY

SN 78-883,331. PRICEWATERHOUSECOOPERS LLP, NEW YORK, NY. FILED 5-15-2006.

ENGAGEMENT INTELLIGENCE

THE MARK CONSISTS OF STANDARD CHARACTERS WITHOUT CLAIM TO ANY PARTICULAR FONT, STYLE, SIZE, OR COLOR.

NO CLAIM IS MADE TO THE EXCLUSIVE RIGHT TO USE "INTELLIGENCE", APART FROM THE MARK AS SHOWN.

FOR CONSULTING SERVICES IN THE FIELD OF HUMAN RESOURCES; PREPARING ELECTRONIC BUSINESS REPORTS AND CONDUCTING SURVEYS ON HUMAN RESOURCES ISSUES (U.S. CLS. 100, 101 AND 102).

DAVID TAYLOR, EXAMINING ATTORNEY

CLASS 35—(Continued).

SN 78-883,835. HEALTHSIMPLE TOOLS, LLC, MINNEAPOLIS, MN. FILED 5-15-2006.

HEALTHSIMPLE

THE MARK CONSISTS OF STANDARD CHARACTERS WITHOUT CLAIM TO ANY PARTICULAR FONT, STYLE, SIZE, OR COLOR.

FOR ON-LINE RETAIL STORES IN THE FIELD OF HEALTH AND NUTRITION, NAMELY, BOOKS, VIDEOS, PERSONAL CARE ITEMS, EDUCATIONAL TOOLS, FOOD, BEVERAGES, GIFT ITEMS, CLOTHING AND GAMES; RETAIL STORE SERVICES IN THE FIELD OF HEALTH AND NUTRITION NAMELY, BOOKS, VIDEOS, PERSONAL CARE ITEMS, EDUCATIONAL TOOLS, FOOD, BEVERAGES, GIFT ITEMS, CLOTHING AND GAMES; RETAIL CATALOG MAIL ORDER SERVICE IN THE FIELD OF HEALTH AND NUTRITION, NAMELY, BOOKS, VIDEOS, PERSONAL CARE ITEMS, EDUCATIONAL TOOLS, FOOD, BEVERAGES, GIFT ITEMS, CLOTHING AND GAMES; RETAIL SERVICES BY DIRECT SOLICITATION BY SALES AGENTS IN THE FIELD OF HEALTH AND NUTRITION, NAMELY, BOOKS, VIDEOS, PERSONAL CARE ITEMS, EDUCATIONAL TOOLS, FOOD, BEVERAGES, GIFT ITEMS, CLOTHING AND GAMES (U.S. CLS. 100, 101 AND 102).

RUDY R. SINGLETON, EXAMINING ATTORNEY

SN 78-884,351. ADD VANTAGE GROUP, INC. DBA BRAND CANYON CO., SCOTTSDALE, AZ. FILED 5-16-2006.

**These Lights Will Silent
Your Night**

THE MARK CONSISTS OF STANDARD CHARACTERS WITHOUT CLAIM TO ANY PARTICULAR FONT, STYLE, SIZE, OR COLOR.

FOR ADVERTISING SLOGAN AND CARTOON CHARACTER LICENSING (U.S. CLS. 100, 101 AND 102).

FIRST USE 12-20-2004; IN COMMERCE 12-20-2004.
KIMBERLY PERRY, EXAMINING ATTORNEY

CLASS 35—(Continued).

SN 78-885,817. DOT FOODS, INC., MT. STERLING, IL.
FILED 5-17-2006.

DOT ON DEMAND

THE MARK CONSISTS OF STANDARD CHARACTERS WITHOUT CLAIM TO ANY PARTICULAR FONT, STYLE, SIZE, OR COLOR.

OWNER OF U.S. REG. NOS. 1,749,051, 3,076,574 AND OTHERS.

NO CLAIM IS MADE TO THE EXCLUSIVE RIGHT TO USE "ON DEMAND", APART FROM THE MARK AS SHOWN.

FOR WHOLESALE DISTRIBUTORSHIP SERVICES FEATURING FOODSERVICE PRODUCTS (U.S. CLS. 100, 101 AND 102).

FIRST USE 6-24-2004; IN COMMERCE 6-24-2004.
KATRINA EDGE, EXAMINING ATTORNEY

SN 78-886,012. AIRCRAFT OWNERS AND PILOTS ASSOCIATION, FREDERICK, MD. FILED 5-17-2006.

**Share Your Passion For
Flight**

THE MARK CONSISTS OF STANDARD CHARACTERS WITHOUT CLAIM TO ANY PARTICULAR FONT, STYLE, SIZE, OR COLOR.

FOR ASSOCIATION SERVICES, NAMELY PROMOTING THE INTERESTS OF GENERAL AVIATION IN THE NATURE OF PROMOTING AVIATION TO NEW PILOTS AND INACTIVE PILOTS TO RETURN TO FLYING (U.S. CLS. 100, 101 AND 102).

SCOTT BALDWIN, EXAMINING ATTORNEY

SN 78-886,473. CAVENDER INVESTMENT PROPERTIES, LTD, TYLER, TX. FILED 5-18-2006.



THE COLORS BLACK, RED, AND WHITE ARE CLAIMED AS A FEATURE OF THE MARK.

THE WORD CAVENDER'S IS RED WITH A BLACK DOUBLE BORDER, THE CURVED LINES ARE BLACK, THE STARS ARE BLACK AND WHITE.

FOR RETAIL STORES FEATURING WESTERN CLOTHING, BOOTS, HATS, ACCESSORIES, AND DECOR (U.S. CLS. 100, 101 AND 102).

FIRST USE 7-30-1998; IN COMMERCE 7-30-1998.
JOHN WILKE, EXAMINING ATTORNEY

CLASS 35—(Continued).

SN 78-887,348. WEBCONSULS, LLC, NEWPORT BEACH, CA.
FILED 5-18-2006.

PASSPORT TO RECOVERY

THE MARK CONSISTS OF STANDARD CHARACTERS WITHOUT CLAIM TO ANY PARTICULAR FONT, STYLE, SIZE, OR COLOR.

FOR PROVIDING ON-LINE DIRECTORY INFORMATION SERVICES ALSO FEATURING HYPERLINKS TO OTHER WEB SITES (U.S. CLS. 100, 101 AND 102).

SAMUEL E. SHARPER JR., EXAMINING ATTORNEY

SN 78-888,120. KAZI, ANWAR, HONOLULU, HI. FILED 5-19-2006.

STAFFINGPOWER

THE MARK CONSISTS OF STANDARD CHARACTERS WITHOUT CLAIM TO ANY PARTICULAR FONT, STYLE, SIZE, OR COLOR.

OWNER OF U.S. REG. NO. 3,132,310.

FOR PROVIDING ON-LINE PERSONNEL RECRUITMENT, PERSONNEL MANAGEMENT INFORMATION AND JOB SEARCH INFORMATION SERVICES; PROVIDING AN INTERACTIVE COMPUTER DATABASE FEATURING RECRUITMENT AND EMPLOYMENT INFORMATION, EMPLOYMENT ADVERTISING, BUSINESS ADVERTISING, EXECUTIVE JOBS POSTING SERVICES AND SEARCH, CAREER INFORMATION AND RESOURCES, RESUME CREATION AND POSTING, RESUME TRANSMITTAL AND COMMUNICATION OF RESPONSES THERETO VIA A GLOBAL COMPUTER NETWORK (U.S. CLS. 100, 101 AND 102).

FIRST USE 4-25-2005; IN COMMERCE 4-25-2005.
DANIEL RUSSELL, EXAMINING ATTORNEY

CLASS 35—(Continued).

SN 78-888,399. KAZI, ANWAR R., HONOLULU, HI. FILED 5-19-2006.

STAFFINGPOWER.COM

THE MARK CONSISTS OF STANDARD CHARACTERS WITHOUT CLAIM TO ANY PARTICULAR FONT, STYLE, SIZE, OR COLOR.

OWNER OF U.S. REG. NO. 3,132,310.

FOR PROVIDING ON-LINE PERSONNEL RECRUITMENT, PERSONNEL MANAGEMENT INFORMATION AND JOB SEARCH INFORMATION SERVICES; EXECUTIVE JOBS SEARCH SERVICES, NAMELY, PROVIDING A DATABASE OF JOBS TO ASSIST IN JOB PLACEMENT; PROVIDING INTERACTIVE COMPUTER DATABASE FEATURING RECRUITMENT AND EMPLOYMENT INFORMATION, EMPLOYMENT ADVERTISING, CAREER INFORMATION AND RESOURCES, RESUME CREATION AND POSTING, TEMPORARY WORK POSTING SERVICES, RESUME TRANSMITTAL AND COMMUNICATION OF RESPONSES THERETO VIA A GLOBAL COMPUTER NETWORK (U.S. CLS. 100, 101 AND 102).

FIRST USE 4-25-2005; IN COMMERCE 4-25-2005.
DANIEL RUSSELL, EXAMINING ATTORNEY

SN 78-888,403. KAZI, ANWAR R., HONOLULU, HI. FILED 5-19-2006.

STAFFINGPOWER

THE MARK CONSISTS OF STANDARD CHARACTERS WITHOUT CLAIM TO ANY PARTICULAR FONT, STYLE, SIZE, OR COLOR.

OWNER OF U.S. REG. NO. 3,132,310.

FOR PROVIDING AN INTERACTIVE COMPUTER DATABASE, VIA AN ONLINE COMPUTER NETWORK, IN THE FIELD OF EMPLOYMENT AND RESUME AVAILABILITY (U.S. CLS. 100, 101 AND 102).

FIRST USE 4-25-2005; IN COMMERCE 4-25-2005.
DANIEL RUSSELL, EXAMINING ATTORNEY

SN 78-895,791. NCM ASSOCIATES, INC., OVERLAND PARK, KS. FILED 5-30-2006.

PROFIT SOLUTIONS

THE MARK CONSISTS OF STANDARD CHARACTERS WITHOUT CLAIM TO ANY PARTICULAR FONT, STYLE, SIZE, OR COLOR.

FOR PREPARING BUSINESS REPORTS (U.S. CLS. 100, 101 AND 102).

PAM WILLIS, EXAMINING ATTORNEY

CLASS 35—(Continued).

SN 78-895,802. NCM ASSOCIATES, INC., OVERLAND PARK, KS. FILED 5-30-2006.



THE MARK CONSISTS OF THE LETTER P WITH A MAZE DESIGN AND THE WORDS PROFIT SOLUTIONS EDUCATE MOTIVATE LEAD.

FOR PREPARING BUSINESS REPORTS (U.S. CLS. 100, 101 AND 102).

PAM WILLIS, EXAMINING ATTORNEY

SN 78-895,819. NCM ASSOCIATES, INC., OVERLAND PARK, KS. FILED 5-30-2006.

**PROFIT SOLUTIONS EDUCATE
MOTIVATE LEAD**

THE MARK CONSISTS OF STANDARD CHARACTERS WITHOUT CLAIM TO ANY PARTICULAR FONT, STYLE, SIZE, OR COLOR.

FOR PREPARING BUSINESS REPORTS (U.S. CLS. 100, 101 AND 102).

PAM WILLIS, EXAMINING ATTORNEY

SN 78-903,263. ITRON, INC., SPOKANE, WA. FILED 6-7-2006.

OPENWAY

THE MARK CONSISTS OF STANDARD CHARACTERS WITHOUT CLAIM TO ANY PARTICULAR FONT, STYLE, SIZE, OR COLOR.

FOR DATABASE MANAGEMENT; COMPUTERIZED DATABASE MANAGEMENT; DATA PROCESSING SERVICES ALL FOR USE IN THE UTILITY, POWER, ENERGY AND WATER INDUSTRIES (U.S. CLS. 100, 101 AND 102).

KATHLEEN M. VANSTON, EXAMINING ATTORNEY

CLASS 35—(Continued).

SN 78-904,696. INTERNATIONAL TRUCK INTELLECTUAL PROPERTY COMPANY, LLC, WARRENVILLE, IL. FILED 6-9-2006.

DIA

THE MARK CONSISTS OF STANDARD CHARACTERS WITHOUT CLAIM TO ANY PARTICULAR FONT, STYLE, SIZE, OR COLOR.
FOR INVENTORY CONTROL SYSTEM FOR TRUCKS AND PARTS (U.S. CLS. 100, 101 AND 102).
FIRST USE 5-0-2006; IN COMMERCE 5-0-2006.
NAAKWAMA ANKRAH, EXAMINING ATTORNEY

CLASS 35—(Continued).

SN 78-905,379. CORPORATE ALLIANCE OF UTAH, INC., PROVO, UT. FILED 6-10-2006.

LEARN. SERVE. GROW.

THE MARK CONSISTS OF STANDARD CHARACTERS WITHOUT CLAIM TO ANY PARTICULAR FONT, STYLE, SIZE, OR COLOR.
FOR BUSINESS NETWORKING (U.S. CLS. 100, 101 AND 102).
FIRST USE 9-0-2004; IN COMMERCE 9-0-2004.
KEVON CHISOLM, EXAMINING ATTORNEY

SN 78-904,890. BALLY TOTAL FITNESS HOLDING CORPORATION, CHICAGO, IL. FILED 6-9-2006.

DISCOVER THE FINANCIAL POWER OF FITNESS

THE MARK CONSISTS OF STANDARD CHARACTERS WITHOUT CLAIM TO ANY PARTICULAR FONT, STYLE, SIZE, OR COLOR.
FOR FRANCHISE SERVICES, NAMELY, OFFERING TECHNICAL AND BUSINESS MANAGEMENT ASSISTANCE IN THE ESTABLISHMENT AND OPERATION OF HEALTH AND FITNESS CLUBS (U.S. CLS. 100, 101 AND 102).
FIRST USE 6-1-2006; IN COMMERCE 6-1-2006.
SETH A. RAPPAPORT, EXAMINING ATTORNEY

SN 78-905,386. CORPORATE ALLIANCE OF UTAH, INC., PROVO, UT. FILED 6-10-2006.

RELATIONSHIP SUMMIT

THE MARK CONSISTS OF STANDARD CHARACTERS WITHOUT CLAIM TO ANY PARTICULAR FONT, STYLE, SIZE, OR COLOR.
FOR BUSINESS NETWORKING (U.S. CLS. 100, 101 AND 102).
FIRST USE 4-0-2004; IN COMMERCE 4-0-2004.
KEVON CHISOLM, EXAMINING ATTORNEY

SN 78-904,922. BALLY TOTAL FITNESS HOLDING CORPORATION, CHICAGO, IL. FILED 6-9-2006.

TURNING PHYSICAL FITNESS INTO FINANCIAL INDEPENDENCE

THE MARK CONSISTS OF STANDARD CHARACTERS WITHOUT CLAIM TO ANY PARTICULAR FONT, STYLE, SIZE, OR COLOR.
FOR FRANCHISE SERVICES, NAMELY, OFFERING TECHNICAL AND BUSINESS MANAGEMENT ASSISTANCE IN THE ESTABLISHMENT AND OPERATION OF HEALTH AND FITNESS CLUBS (U.S. CLS. 100, 101 AND 102).
FIRST USE 6-1-2006; IN COMMERCE 6-1-2006.
SETH A. RAPPAPORT, EXAMINING ATTORNEY

SN 78-905,389. CORPORATE ALLIANCE OF UTAH, INC., PROVO, UT. FILED 6-10-2006.

RELATIONSHIP POWER INDEX

THE MARK CONSISTS OF STANDARD CHARACTERS WITHOUT CLAIM TO ANY PARTICULAR FONT, STYLE, SIZE, OR COLOR.
FOR BUSINESS NETWORKING (U.S. CLS. 100, 101 AND 102).
FIRST USE 2-0-2006; IN COMMERCE 2-0-2006.
KEVON CHISOLM, EXAMINING ATTORNEY

CLASS 35—(Continued).

SN 78-905,390. CORPORATE ALLIANCE OF UTAH, INC.,
PROVO, UT. FILED 6-10-2006.

RELATIONSHIP ARROGANCE

THE MARK CONSISTS OF STANDARD CHARACTERS
WITHOUT CLAIM TO ANY PARTICULAR FONT, STYLE,
SIZE, OR COLOR.

FOR BUSINESS NETWORKING (U.S. CLS. 100, 101
AND 102).

FIRST USE 9-0-2004; IN COMMERCE 9-0-2004.
KEVON CHISOLM, EXAMINING ATTORNEY

SN 78-905,397. CORPORATE ALLIANCE OF UTAH, INC.,
PROVO, UT. FILED 6-10-2006.

RELATIONSHIP COACH

THE MARK CONSISTS OF STANDARD CHARACTERS
WITHOUT CLAIM TO ANY PARTICULAR FONT, STYLE,
SIZE, OR COLOR.

FOR BUSINESS NETWORKING (U.S. CLS. 100, 101
AND 102).

FIRST USE 2-0-2006; IN COMMERCE 2-0-2006.
KEVON CHISOLM, EXAMINING ATTORNEY

SN 78-905,398. CORPORATE ALLIANCE OF UTAH, INC.,
PROVO, UT. FILED 6-10-2006.

RPI

THE MARK CONSISTS OF STANDARD CHARACTERS
WITHOUT CLAIM TO ANY PARTICULAR FONT, STYLE,
SIZE, OR COLOR.

FOR BUSINESS NETWORKING (U.S. CLS. 100, 101
AND 102).

FIRST USE 2-0-2006; IN COMMERCE 2-0-2006.
KEVON CHISOLM, EXAMINING ATTORNEY

CLASS 35—(Continued).

SN 78-913,534. AERO-ZONE INCORPORATED, MESA, AZ.
FILED 6-21-2006.



THE STIPPLING IS FOR SHADING PURPOSES ONLY.
THE MARK CONSISTS OF A BIG HALF CIRCLE AND A
SMALLER HALF CIRCLE.

FOR PROCUREMENT, NAMELY, PURCHASING PUR-
CHASING OF AIRCRAFT PARTS, AIRCRAFT EQUIP-
MENT SERVICES AND AIRCRAFT ACCESSORIES FOR
OTHERS (U.S. CLS. 100, 101 AND 102).

FIRST USE 6-10-1994; IN COMMERCE 6-10-1994.
KELLY MCCOY, EXAMINING ATTORNEY

SN 78-918,238. HOODLOVE LIMITED LIABILITY COM-
PANY, EAST ORANGE, NJ. FILED 6-27-2006.

HOOD LOVE

THE MARK CONSISTS OF STANDARD CHARACTERS
WITHOUT CLAIM TO ANY PARTICULAR FONT, STYLE,
SIZE, OR COLOR.

FOR BUSINESS NETWORKING; CHARITABLE SER-
VICES, NAMELY ORGANIZING AND CONDUCTING
VOLUNTEER PROGRAMS AND COMMUNITY SERVICE
PROJECTS; GENERAL BUSINESS NETWORKING RE-
FERRAL SERVICES, NAMELY, PROMOTING THE
GOODS AND SERVICES OF OTHERS BY PASSING
BUSINESS LEADS AND REFERRALS AMONG GROUP
MEMBERS; ON-LINE RETAIL STORE SERVICES FEAT-
URING JEWELRY AND COSTUME JEWELRY, PINS,
HOME FURNISHINGS AND ACCESSORIES, HOUSE-
WARES, CLOCKS, WATCHES, STATIONARY, PAPER
GOODS, GARBAGE BAGS AND LINERS, LEATHER
GOODS, PHOTO MATS, PICTURE FRAMING MAT
BOARDS, PROTECTIVE COVERS FOR BOOKS AND
PAPER, MAGAZINES, STICKERS, PLASTIC GOODS,
KEY CHAINS, KEY CHAIN TAGS, BANNERS, BATH
AND BATHROOM ACCESSORIES, PERSONAL CARE
PRODUCTS, CANDLE HOLDERS AND FRAGRANCE
OIL BURNERS, GARBAGE CANS, HEADWEAR, FOOT-
WEAR, CLOTHING, APPAREL AND FASHION ACCES-
SORIES, GAMES, SPORTING GOODS, TOYS, BALLS,
PARTY FAVORS, AND OTHER RELATED CONSUMER
GOODS; RETAIL STORE SERVICES FEATURING A
WIDE VARIETY OF CONSUMER GOODS OF OTHERS;
TALENT AGENCIES (U.S. CLS. 100, 101 AND 102).

BARBARA BROWN, EXAMINING ATTORNEY

CLASS 35—(Continued).

SN 78-927,347. GEORGIA-PACIFIC CORPORATION, ATLANTA, GA. FILED 7-12-2006.

WEATHERBUILT

THE MARK CONSISTS OF STANDARD CHARACTERS WITHOUT CLAIM TO ANY PARTICULAR FONT, STYLE, SIZE, OR COLOR.

FOR PROVIDING CONSUMER INFORMATION IN THE FIELD OF BUILDING PRODUCTS (U.S. CLS. 100, 101 AND 102).

FIRST USE 6-1-2006; IN COMMERCE 6-1-2006.
LINDA MICKLEBURGH, EXAMINING ATTORNEY

CLASS 35—(Continued).

SN 78-977,615. HOP, LLC, BALTIMORE, MD. FILED 9-12-2005.

HOOKED ON

THE MARK CONSISTS OF STANDARD CHARACTERS WITHOUT CLAIM TO ANY PARTICULAR FONT, STYLE, SIZE, OR COLOR.

OWNER OF U.S. REG. NOS. 2,050,379, 2,674,241 AND OTHERS.

FOR PROMOTING PUBLIC AWARENESS OF THE IMPORTANCE OF LEARNING AND EDUCATION (U.S. CLS. 100, 101 AND 102).

SONYA STEPHENS, EXAMINING ATTORNEY

CLASS 36—INSURANCE AND FINANCIAL

SN 76-363,248. EASY CASH, INC., LITTLE ROCK, AR. FILED 1-22-2002.



SUBJECT TO CONCURRENT USE PROCEEDING WITH AMERICAN INTERNATIONAL INVESTMENT AND ADVANTAGE RENT-A-CAR, INC. APPLICANT CLAIMS EXCLUSIVE RIGHT TO USE THE MARK IN THE AREA COMPRISING THE STATE OF ARKANSAS, TULSA AND OKLAHOMA CITY, OKLAHOMA.

FOR SECURED LENDING AND DEFERRED PAYMENT CHECK CASHING (U.S. CLS. 100, 101 AND 102).

FIRST USE 11-28-1997; IN COMMERCE 2-6-1999.
MARGERY A. TIERNEY, EXAMINING ATTORNEY

SN 78-952,034. CONSTELLATION ENERGY GROUP, INC., BALTIMORE, MD. FILED 8-15-2006.

EIQ

THE MARK CONSISTS OF STANDARD CHARACTERS WITHOUT CLAIM TO ANY PARTICULAR FONT, STYLE, SIZE, OR COLOR.

FOR PROCUREMENT, NAMELY, PURCHASING OF ENERGY FOR OTHERS; CONSULTATION SERVICES IN THE FIELDS OF ENERGY CONSUMPTION, ENERGY CONSERVATION AND ENERGY USE MANAGEMENT; ENERGY MANAGEMENT SERVICES, NAMELY, FORMULATING ENERGY CONSUMPTION PLANS TO REDUCE ENERGY COSTS AND TO REDUCE RISKS ASSOCIATED WITH CHANGING ENERGY COSTS; INFORMATION SERVICES, NAMELY, PROVIDING INFORMATION REGARDING ENERGY CONSUMPTION AND ENERGY COSTS; ENERGY AUDITING, NAMELY, REVIEW AND ANALYSIS OF ENERGY CONSUMPTION; PREPARING CUSTOMIZED BUSINESS REPORTS FEATURING ENERGY SAVINGS DATA, ENERGY PROFILE DEVELOPMENT, ENERGY PROFILE BENCHMARKING, RATE ANALYSIS AND VERIFICATION, RISK TOLERANCE, PROCUREMENT STRATEGY AND ENERGY PRODUCT SELECTION; AND PROVIDING A WEBSITE FEATURING INFORMATION ABOUT ENERGY MANAGEMENT, USE, COSTS AND CONSERVATION (U.S. CLS. 100, 101 AND 102).

DAVID MURRAY, EXAMINING ATTORNEY

SN 76-384,433. PEOPLES BANK, NATIONAL ASSOCIATION, MARIETTA, OH. FILED 3-19-2002.

PEOPLES BANK

NO CLAIM IS MADE TO THE EXCLUSIVE RIGHT TO USE "BANK", APART FROM THE MARK AS SHOWN. FOR BANKING SERVICES (U.S. CLS. 100, 101 AND 102).

FIRST USE 0-0-1902; IN COMMERCE 0-0-1902.
SHARI SHEFFIELD, EXAMINING ATTORNEY

CLASS 36—(Continued).

SN 76-536,020. METROPOLITAN REGIONAL INFORMATION SYSTEMS, INC., ROCKVILLE, MD. FILED 8-11-2003.

CORNERSTONE

FOR PROVIDING AN ONLINE DATABASE IN THE FIELD OF REAL ESTATE, NAMELY PROVIDING A SEARCHABLE DATABASE OF LOCAL AND REGIONAL RESIDENTIAL AND BUSINESS PROPERTY SALES, VACANT LAND AND LEASING LISTINGS (U.S. CLS. 100, 101 AND 102).

ANN E. SAPPENFIELD, EXAMINING ATTORNEY

SN 76-556,192. ADMAR ENTERPRISES, INC., MERRICK, NY. FILED 10-16-2003.

ECCO

FOR FINANCIAL SERVICES NAMELY CHECK CONVERSION AND ACCOUNTS RECEIVABLE CONVERSION (U.S. CLS. 100, 101 AND 102).

FIRST USE 1-3-2003; IN COMMERCE 1-3-2003.

PAULA MAYS, EXAMINING ATTORNEY

SN 76-562,488. BAYVIEW FINANCIAL, L.P., CORAL GABLES, FL. FILED 11-17-2003.

CommercialDirect

THE MARK CONSISTS OF THE TWO WORDS "COMMERCIAL" AND "DIRECT" CONCATENATED SO THAT THE "L" IN "COMMERCIAL" IS ADJACENT THE VERTICAL BAR OF THE "D" IN "DIRECT" AND WITH FIVE ADDITIONAL DOTS EXTENDING OFF TO THE RIGHT OF THE DOT COMPLETING THE "I" IN "DIRECT".

SEC. 2(F).

FOR FINANCIAL INFORMATION PROVIDED BY ELECTRONIC MEANS REGARDING LOANS AND LENDING; FINANCIAL SERVICES, NAMELY MONEY LENDING; FINANCIAL SERVICES, NAMELY COMMERCIAL MORTGAGE LENDING; AND FINANCIAL SERVICES, NAMELY ORIGINATING REAL ESTATE AND ASSET BACKED LOANS (U.S. CLS. 100, 101 AND 102).

FIRST USE 9-12-2003; IN COMMERCE 9-12-2003.

MARK SPARACINO, EXAMINING ATTORNEY

CLASS 36—(Continued).

SN 76-591,126. 1ST COMMUNITY FEDERAL CREDIT UNION, SAN ANGELO, TX. FILED 5-10-2004.



NO CLAIM IS MADE TO THE EXCLUSIVE RIGHT TO USE "FEDERAL CREDIT UNION", APART FROM THE MARK AS SHOWN.

SEC. 2(F) AS TO "1ST COMMUNITY" FOR CREDIT UNION SERVICES (U.S. CLS. 100, 101 AND 102).

FIRST USE 7-27-1983; IN COMMERCE 7-27-1983.

DORITT L. CARROLL, EXAMINING ATTORNEY

SN 76-615,353. FIRST HORIZON NATIONAL CORPORATION, MEMPHIS, TN. FILED 10-6-2004.



THE COLOR(S) RED, WHITE AND BLUE IS/ARE CLAIMED AS A FEATURE OF THE MARK.

THE COLOR RED APPEARS IN THE UPPER PORTION OF THE BISECTED SQUARE, THE COLOR BLUE APPEARS IN THE LOWER PORTION OF THE BISECTED SQUARE AND IN THE WORDING OF THE MARK, AND THE COLOR WHITE APPEARS IN THE STAR AND THE BISECTING STRIPE IN THE SQUARE.

SEC. 2(F) AS TO "FIRST TENNESSEE".

FOR BANKING SERVICES AND A HOUSE MARK FOR A FULL LINE OF MORTGAGE SERVICES, SECURITIES, BROKERAGE SERVICES, INVESTMENT BANKING SERVICES, FINANCIAL SERVICES AND INSURANCE SERVICES (U.S. CLS. 100, 101 AND 102).

FIRST USE 8-4-1998; IN COMMERCE 8-4-1998.

SHAUNIA WALLACE, EXAMINING ATTORNEY

SN 76-617,666. PAGLIA CONSULTING GROUP, LLC, OXNARD, CA. FILED 10-22-2004.



NO CLAIM IS MADE TO THE EXCLUSIVE RIGHT TO USE CONSULTING GROUP, LLC, APART FROM THE MARK AS SHOWN.

THE COLORS BLUE AND BLACK ARE CLAIMED AS FEATURES OF THE MARK.

THE COLOR BLUE APPEARS IN THE STYLIZED "P" DESIGN; THE WORDING IN THE MARK AND THE UNDERLINING APPEAR IN BLACK.

FOR BUSINESS VALUATION SERVICES (U.S. CLS. 100, 101 AND 102).

FIRST USE 3-1-2004; IN COMMERCE 3-1-2004.

TINA L. SNAPP, EXAMINING ATTORNEY

CLASS 36—(Continued).

SN 76-623,301. COMMERCIAL BANK OF TEXAS, N.A.,
NACOGDOCHES, TX. FILED 12-6-2004.



The logo for CBT Xchange features the letters "CBT" in a bold, serif font above the word "Xchange" in a similar font. A stylized star is positioned to the left of the "X", and wavy lines are integrated into the design below the "X".

FOR CORRESPONDENT BANKING SERVICES, NAMELY, LOAN ORIGATION SERVICES, LOAN BROKERAGE SERVICES, LOAN FINANCING, AND FINANCIAL CLEARING HOUSE SERVICES; CONSUMER, COMMERCIAL, AGRICULTURAL, AND MORTGAGE BANKING SERVICES; TRUST SERVICES, NAMELY, INVESTMENT AND TRUST COMPANY SERVICES AND TRUST MANAGEMENT ACCOUNTS; PROVIDING CHECKING AND SAVINGS ACCOUNT SERVICES; FINANCIAL SERVICES, NAMELY, ISSUANCE AND MANAGEMENT OF CERTIFICATES BACKED BY LOAN PORTFOLIOS WHICH ARE SUBSEQUENTLY MANAGED TO INSURE THE INTEGRITY OF THE CERTIFICATES; FINANCING SERVICES; AUTOMATED TELLER MACHINE SERVICES; ELECTRONIC CASH TRANSACTIONS; PROVIDING BANK ACCOUNT INFORMATION BY TELEPHONE, ELECTRONICALLY AND VIA THE INTERNET; CHECK CASHING; TRAVELERS' CHECK ISSUANCE; MONEY ORDER SERVICES; SAFE DEPOSIT BOX SERVICES; CHECK PROCESSING; CHECK VERIFICATION; DEBIT CARD SERVICES; ELECTRONIC BILL PAYMENT SERVICES; FINANCIAL AND ESTATE PLANNING; ESTATE TRUST MANAGEMENT; CORRESPONDENT BANKING SERVICES; GUARANTY CASH MANAGEMENT; CREDIT CARD SERVICES; CREDIT CARD VERIFICATION; CREDIT INQUIRY; EVALUATION OF CREDIT BUREAU DATA; FIDUCIARY REPRESENTATIVES; REAL ESTATE TRUSTEE SERVICES; INSURANCE AGENCIES IN THE FIELDS OF HOME, LIFE, ACCIDENT, AUTOMOBILE, MEDICAL, PROPERTY AND CASUALTY LONG-TERM CARE; INSURANCE CONSULTATION; INSURANCE ADMINISTRATION IN THE FIELDS OF HOME, LIFE AND ACCIDENT INSURANCE; ELECTRONIC PROCESSING OF INSURANCE CLAIMS AND PAYMENT DATA; MAINTAINING ESCROW ACCOUNTS FOR INVESTMENTS; FINANCIAL INVESTMENT PLANNING; INVESTMENT MANAGEMENT; MUTUAL FUND INVESTMENT AND DISTRIBUTION; FINANCIAL PORTFOLIO MANAGEMENT; FINANCIAL RESEARCH; FISCAL ASSESSMENT AND EVALUATION; AGENCIES IN THE FIELD OF BONDS AND OTHER SECURITIES (U.S. CLS. 100, 101 AND 102).

FIRST USE 1-26-2000; IN COMMERCE 1-26-2000.
DAWN HAN, EXAMINING ATTORNEY

CLASS 36—(Continued).

SN 76-645,406. UNIVERSAL AMERICAN FINANCIAL
CORP., RYEBROOK, NY. FILED 8-23-2005.



The logo for CONSTITUTION LIFE features the word "CONSTITUTION" in a large, serif font above the word "LIFE" in a similar font. A stylized star is positioned to the left of the "L", and horizontal lines are integrated into the design below the "L".

OWNER OF U.S. REG. NOS. 1,337,160 AND 1,337,161.
NO CLAIM IS MADE TO THE EXCLUSIVE RIGHT TO USE "LIFE", APART FROM THE MARK AS SHOWN.

FOR INSURANCE SERVICES, NAMELY, INSURANCE UNDERWRITING IN THE FIELDS OF LIFE INSURANCE, HEALTH INSURANCE, SUPPLEMENTAL HEALTH INSURANCE, DENTAL INSURANCE; INSURANCE CLAIMS ADMINISTRATION AND PROCESSING; ANNUITY UNDERWRITING; SHORT TERM CARE INSURANCE; NURSING HOME AND IN-HOME CARE INSURANCE; REHABILITATION INSURANCE; INSURANCE ADMINISTRATION; INSURANCE AGENCY AND BROKERAGE SERVICES; INSURANCE CONSULTATION (U.S. CLS. 100, 101 AND 102).

FIRST USE 1-1-1942, THE SERVICE MARK WAS FIRST USED IN A DIFFERENT FORM IN CONNECTION WITH THE SERVICES IN SEPTEMBER 14, 1992.; IN COMMERCE 1-1-1942, THE SERVICE MARK WAS FIRST USED IN A DIFFERENT FORM IN CONNECTION WITH THE SERVICES IN INTERSTATE COMMERCE IN SEPTEMBER 14, 1992..

REBECCA GAN, EXAMINING ATTORNEY

SN 76-650,448. BARNARD ESTATES LIMITED, CASTRIES,
ST.LUCIA, FILED 11-15-2005.

Sunswept Estates

THE MARK CONSISTS OF STANDARD CHARACTERS WITHOUT CLAIM TO ANY PARTICULAR FONT, STYLE, SIZE, OR COLOR.

NO CLAIM IS MADE TO THE EXCLUSIVE RIGHT TO USE ESTATES, APART FROM THE MARK AS SHOWN.

FOR REAL ESTATE BROKERAGE SERVICES IN THE FIELD OF VACATION HOMES AND OTHER REAL ESTATE (U.S. CLS. 100, 101 AND 102).

ZHALEH DELANEY, EXAMINING ATTORNEY

CLASS 36—(Continued).

SN 76-650,964. SOFAER CAPITAL INC., TORTOLA, BR. VIRGIN ISLANDS, FILED 11-28-2005.

SofærCapital

CLASS 36—(Continued).

SN 76-650,965. SOFAER CAPITAL INC., TORTOLA, BR. VIRGIN ISLANDS, FILED 11-28-2005.



FOR INVESTMENT MANAGEMENT AND ADVISORY SERVICES; FUND MANAGEMENT AND FINANCIAL PORTFOLIO MANAGEMENT; FINANCIAL RESEARCH AND ANALYSIS; FINANCIAL INFORMATION IN THE NATURE OF RATES OF EXCHANGE; FINANCIAL INFORMATION PROVIDED BY ELECTRONIC MEANS; FINANCIAL INFORMATION PROCESSING; FINANCIAL MANAGEMENT; INVESTMENT RESEARCH AND ANALYSIS; RESEARCH SERVICES RELATING TO FINANCE; BANKING; HEDGE FUND INVESTMENT SERVICES; FUNDS INVESTMENT; INVESTMENT CONSULTATION; REAL ESTATE ACQUISITION AND APPRAISAL; VENTURE CAPITAL FUNDING SERVICES TO EMERGING AND START UP COMPANIES; CORPORATE FINANCE, NAMELY CONSULTANCY SERVICES RELATING TO DEBT AND EQUITY FINANCE; ADMINISTRATION OF CAPITAL INVESTMENT SERVICES; ADMINISTRATION OF TRUSTS; TRUSTEESHIP; ADMINISTRATION OF INVESTMENT FUNDS; ADMINISTRATION OF SHARES, NAMELY BROKERAGE OF SHARES OF STOCKS AND OTHER SECURITIES (U.S. CLS. 100, 101 AND 102).

FIRST USE 5-1-2003; IN COMMERCE 5-1-2003.
ELIZABETH PIGNATELLO, EXAMINING ATTORNEY

SN 76-651,179. PREMIER CLUB SERVICES, INC., ALEXANDRIA, VA. FILED 11-29-2005.

 **Premier
Club Benefits**
Premier Club Services, Inc.

THE MARK CONSISTS OF THE TERM "SOFAERCAPITAL" IN A STYLIZED FONT WITH THE LETTERS "S" AND "C" IN UPPERCASE AND ALL OTHER LETTERS IN LOWERCASE.

FOR INVESTMENT MANAGEMENT AND ADVISORY SERVICES; FUND MANAGEMENT AND FINANCIAL PORTFOLIO MANAGEMENT; FINANCIAL RESEARCH AND ANALYSIS; FINANCIAL INFORMATION IN THE NATURE OF RATES OF EXCHANGE; FINANCIAL INFORMATION PROVIDED BY ELECTRONIC MEANS; FINANCIAL INFORMATION PROCESSING; FINANCIAL MANAGEMENT; INVESTMENT RESEARCH AND ANALYSIS; RESEARCH SERVICES RELATING TO FINANCE; BANKING; HEDGE FUND INVESTMENT SERVICES; FUNDS INVESTMENT; INVESTMENT CONSULTATION; REAL ESTATE ACQUISITION AND APPRAISAL; VENTURE CAPITAL FUNDING SERVICES TO EMERGING AND START UP COMPANIES; CORPORATE FINANCE, NAMELY CONSULTANCY SERVICES RELATING TO DEBT AND EQUITY FINANCE; ADMINISTRATION OF CAPITAL INVESTMENT SERVICES; ADMINISTRATION OF TRUSTS; TRUSTEESHIP; ADMINISTRATION OF INVESTMENT FUNDS; ADMINISTRATION OF SHARES, NAMELY BROKERAGE OF SHARES OF STOCKS AND OTHER SECURITIES (U.S. CLS. 100, 101 AND 102).

FIRST USE 5-1-2003; IN COMMERCE 5-1-2003.
ELIZABETH PIGNATELLO, EXAMINING ATTORNEY

NO CLAIM IS MADE TO THE EXCLUSIVE RIGHT TO USE "PREMIER CLUB BENEFITS", "PREMIER CLUB SERVICES, INC.", AND "EST. 2005", APART FROM THE MARK AS SHOWN.

THE MARK CONSISTS OF A SHIELD IN THE UPPER LEFT CORNER OF THE MARK WITH THE REMAINDER OF THE MARK CONSISTING OF THE WORDS "PREMIER CLUB BENEFITS PREMIER CLUB SERVICES, INC." IN A STYLIZED FONT. THE SHIELD IS FLANKED BY TWO GARLANDS OF LEAVES AND A BANNER READING "EST. 2005" RUNS ACROSS THE BOTTOM OF THE SHIELD. THE SHIELD IS DIVIDED INTO FOUR QUADRANTS CONTAINING A WORLD GLOBE, THE LETTERS "PCB", TWO CLASPED HANDS, AND AN OPEN BOOK.

FOR ADMINISTRATION OF EMPLOYEE BENEFITS PLANS (U.S. CLS. 100, 101 AND 102).
ELLEN B. AWRICH, EXAMINING ATTORNEY

CLASS 36—(Continued).

SN 76-654,430. THE TRUST FOR PUBLIC LAND, SAN FRANCISCO, CA. FILED 1-30-2006.



NO CLAIM IS MADE TO THE EXCLUSIVE RIGHT TO USE "WORKING LANDS", APART FROM THE MARK AS SHOWN.

FOR CONSERVATION REAL ESTATE SERVICES, NAMELY DEVELOPMENT OF PLANS FOR OTHERS FOR THE ACQUISITION AND CONVEYANCE OF REAL PROPERTY TO BE CONSERVED FOR THE PUBLIC BENEFIT, INCLUDING OPEN SPACE, RECREATIONAL LAND, HISTORICAL SITES, AND CULTURAL SITES, AND PROVIDING INFORMATION REGARDING THE SAME (U.S. CLS. 100, 101 AND 102).

FIRST USE 10-1-2004; IN COMMERCE 10-1-2004.
BARBARA GAYNOR, EXAMINING ATTORNEY

SN 76-654,432. THE TRUST FOR PUBLIC LAND, SAN FRANCISCO, CA. FILED 1-30-2006.



NO CLAIM IS MADE TO THE EXCLUSIVE RIGHT TO USE "LAND & WATER", APART FROM THE MARK AS SHOWN.

FOR CONSERVATION REAL ESTATE SERVICES, NAMELY DEVELOPMENT OF PLANS FOR OTHERS FOR THE ACQUISITION AND CONVEYANCE OF REAL PROPERTY TO BE CONSERVED FOR THE PUBLIC BENEFIT, INCLUDING OPEN SPACE, RECREATIONAL LAND, HISTORICAL SITES, AND CULTURAL SITES, AND PROVIDING INFORMATION REGARDING THE SAME (U.S. CLS. 100, 101 AND 102).

FIRST USE 10-1-2004; IN COMMERCE 10-1-2004.
BARBARA GAYNOR, EXAMINING ATTORNEY

CLASS 36—(Continued).

SN 76-656,667. PIPELINE FINANCIAL GROUP, INC., NEW YORK, NY. FILED 3-10-2006.

A BETTER CHANCE FOR BEST EXECUTION

THE MARK CONSISTS OF STANDARD CHARACTERS WITHOUT CLAIM TO ANY PARTICULAR FONT, STYLE, SIZE, OR COLOR.

NO CLAIM IS MADE TO THE EXCLUSIVE RIGHT TO USE "BEST EXECUTION", APART FROM THE MARK AS SHOWN.

FOR COMPUTERIZED ONLINE TRADING SERVICES WHICH PROVIDE TRADERS WITH THE ABILITY TO COMPLETE TRADES ON VARIOUS EXCHANGES WITHIN THE SECURITIES, OPTIONS, FUTURES AND DERIVATIVES MARKETS AND TO ACCESS MARKET INFORMATION ALL BY MEANS OF A GLOBAL COMPUTER NETWORK (U.S. CLS. 100, 101 AND 102).

TIMOTHY FINNEGAN, EXAMINING ATTORNEY

SN 76-657,299. OLD MUTUAL BUSINESS SERVICES, INC., BALTIMORE, MD. FILED 3-27-2006.

INNOVATIVE AND BALANCED FINANCIAL SOLUTIONS

THE MARK CONSISTS OF STANDARD CHARACTERS WITHOUT CLAIM TO ANY PARTICULAR FONT, STYLE, SIZE, OR COLOR.

FOR LIFE INSURANCE AND ANNUITY UNDERWRITING SERVICES (U.S. CLS. 100, 101 AND 102).

FIRST USE 6-0-2003; IN COMMERCE 6-0-2003.

COLLEEN DOMBROW, EXAMINING ATTORNEY

SN 76-658,447. HAGHKAR, MOHAMMED, DOWNING-TOWN, PA. FILED 4-14-2006.

Allegiance Financial Solutions

THE MARK CONSISTS OF STANDARD CHARACTERS WITHOUT CLAIM TO ANY PARTICULAR FONT, STYLE, SIZE, OR COLOR.

NO CLAIM IS MADE TO THE EXCLUSIVE RIGHT TO USE "FINANCIAL SOLUTIONS", APART FROM THE MARK AS SHOWN.

FOR MORTGAGE BROKERAGE; FINANCIAL PLANNING AND FINANCIAL MANAGEMENT (U.S. CLS. 100, 101 AND 102).

FIRST USE 10-28-2004; IN COMMERCE 10-28-2004.
FRED MANDIR, EXAMINING ATTORNEY

SN 76-659,110. ADVANCE RESTAURANT FINANCE, LLC, SAN MATEO, CA. FILED 4-26-2006.



FOR PROVIDING RETAIL ESTABLISHMENT WORKING CAPITAL (U.S. CLS. 100, 101 AND 102).

FIRST USE 9-1-2001; IN COMMERCE 9-1-2001.

JIM RINGLE, EXAMINING ATTORNEY

CLASS 36—(Continued).

SN 76-660,724. MERRILL LYNCH & CO., INC., NEW YORK, NY. FILED 5-30-2006.

RETIRE WITH AUTOMATED MANAGED PROGRAMS

THE MARK CONSISTS OF STANDARD CHARACTERS WITHOUT CLAIM TO ANY PARTICULAR FONT, STYLE, SIZE, OR COLOR.

FOR FINANCIAL SERVICES, NAMELY, THE PROVISION OF RETIREMENT INVESTMENT MANAGEMENT SERVICES (U.S. CLS. 100, 101 AND 102).

FIRST USE 5-8-2006; IN COMMERCE 5-8-2006.

JESSICA A. POWERS, EXAMINING ATTORNEY

CLASS 36—(Continued).

SN 78-353,248. AFNI, INC., BLOOMINGTON, IL. FILED 1-16-2004.

OBSERVER

SN 76-660,866. MERRILL LYNCH & CO., INC., NEW YORK, NY. FILED 5-31-2006.

RCMA MASTER FINANCIAL

THE MARK CONSISTS OF STANDARD CHARACTERS WITHOUT CLAIM TO ANY PARTICULAR FONT, STYLE, SIZE, OR COLOR.

OWNER OF U.S. REG. NO. 2,393,114.

NO CLAIM IS MADE TO THE EXCLUSIVE RIGHT TO USE "MASTER FINANCIAL", APART FROM THE MARK AS SHOWN.

FOR FINANCIAL SERVICES, NAMELY, PROVIDING FINANCIAL MANAGEMENT SERVICES BETWEEN MASTER RETIREMENT ASSET ACCOUNTS AND SUB-ACCOUNTS (U.S. CLS. 100, 101 AND 102).

FIRST USE 3-1-1998; IN COMMERCE 3-1-1998.

JESSICA A. POWERS, EXAMINING ATTORNEY

THE MARK CONSISTS OF STANDARD CHARACTERS WITHOUT CLAIM TO ANY PARTICULAR FONT, STYLE, SIZE, OR COLOR.

FOR PROVIDING ON-LINE INFORMATION IN THE FIELD OF BANKRUPTCY FILINGS (U.S. CLS. 100, 101 AND 102).

FIRST USE 9-15-2003; IN COMMERCE 9-15-2003.

NANCY CLARKE, EXAMINING ATTORNEY

SN 78-363,557. TIMOTHY R DOWNEY INSURANCE INC, KOKOMO, IN. FILED 2-6-2004.

DOWNEY INSURANCE

SN 76-661,152. MERRILL LYNCH & CO., INC., NEW YORK, NY. FILED 5-31-2006.

RCMA SUBACCOUNTS

THE MARK CONSISTS OF STANDARD CHARACTERS WITHOUT CLAIM TO ANY PARTICULAR FONT, STYLE, SIZE, OR COLOR.

OWNER OF U.S. REG. NO. 2,393,114 AND OTHERS.

NO CLAIM IS MADE TO THE EXCLUSIVE RIGHT TO USE "SUBACCOUNTS", APART FROM THE MARK AS SHOWN.

FOR FINANCIAL SERVICES, NAMELY THE OFFERING OF AN ACCOUNT CREATED TO FACILITATE THE SEGREGATION OF ASSETS BY RETIREMENT PLAN SPONSORS (U.S. CLS. 100, 101 AND 102).

FIRST USE 3-1-1998; IN COMMERCE 3-1-1998.

JESSICA A. POWERS, EXAMINING ATTORNEY

THE MARK CONSISTS OF STANDARD CHARACTERS WITHOUT CLAIM TO ANY PARTICULAR FONT, STYLE, SIZE, OR COLOR.

NO CLAIM IS MADE TO THE EXCLUSIVE RIGHT TO USE "INSURANCE", APART FROM THE MARK AS SHOWN.

SEC. 2(F).

FOR INSURANCE BROKERAGE, INSURANCE ADMINISTRATION, AND INSURANCE UNDERWRITING SERVICES FOR WORKER'S COMPENSATION, AUTOMOBILE, PROPERTY, CASUALTY, EMPLOYERS' LIABILITY AND LIFE INSURANCE, ALL PROVIDED TO GOVERNMENTAL ENTITIES (U.S. CLS. 100, 101 AND 102).

FIRST USE 12-1-1998; IN COMMERCE 12-1-1998.

STEVEN JACKSON, EXAMINING ATTORNEY

CLASS 36—(Continued).

SN 78-446,400. UNION FEDERAL BANK OF INDIANAPOLIS, INDIANAPOLIS, IN. FILED 7-6-2004.

CLASS 36—(Continued).

SN 78-451,347. CITIZENS FINANCIAL GROUP, INC., PROVIDENCE, RI. FILED 7-15-2004.



**CITIZENS CIRCLE
GOLD ACCOUNT**

THE MARK CONSISTS OF THE CHARACTERS "123EZREFI" WITH A CIRCLE AROUND "EZ".
FOR BANKING SERVICES (U.S. CLS. 100, 101 AND 102).
FIRST USE 1-23-2004; IN COMMERCE 1-23-2004.
MICHELE SWAIN, EXAMINING ATTORNEY

THE MARK CONSISTS OF STANDARD CHARACTERS WITHOUT CLAIM TO ANY PARTICULAR FONT, STYLE, SIZE, OR COLOR.
OWNER OF U.S. REG. NOS. 2,228,415, 2,668,486 AND OTHERS.
NO CLAIM IS MADE TO THE EXCLUSIVE RIGHT TO USE "ACCOUNT", APART FROM THE MARK AS SHOWN.
FOR BANKING SERVICES (U.S. CLS. 100, 101 AND 102).
FIRST USE 4-15-1996; IN COMMERCE 4-19-1996.
RONALD MCMORROW, EXAMINING ATTORNEY

SN 78-449,985. THE DAYTON FOUNDATION, INC., DAYTON, OH. FILED 7-13-2004.

SN 78-456,480. VALUFINDER GROUP, INC., NEW YORK, NY. FILED 7-26-2004.



VALUFINDER GROUP

We're here for good.

NO CLAIM IS MADE TO THE EXCLUSIVE RIGHT TO USE FOUNDATION, APART FROM THE MARK AS SHOWN.
SEC. 2(F) AS TO "DAYTON".
FOR PHILANTHROPIC SERVICES CONCERNING CHARITABLE FUND RAISING (U.S. CLS. 100, 101 AND 102).
FIRST USE 6-13-1994; IN COMMERCE 6-13-1994.
EDWARD NELSON, EXAMINING ATTORNEY

THE MARK CONSISTS OF STANDARD CHARACTERS WITHOUT CLAIM TO ANY PARTICULAR FONT, STYLE, SIZE, OR COLOR.
NO CLAIM IS MADE TO THE EXCLUSIVE RIGHT TO USE "GROUP", APART FROM THE MARK AS SHOWN.
FOR INVESTMENT BANKING SERVICES (U.S. CLS. 100, 101 AND 102).
FIRST USE 1-1-1973; IN COMMERCE 1-1-1973.
MARK T. MULLEN, EXAMINING ATTORNEY

CLASS 36—(Continued).

SN 78-496,791. ACE LIMITED, HAMILTON, BERMUDA, FILED 10-8-2004.

ACE GROUP

THE MARK CONSISTS OF STANDARD CHARACTERS WITHOUT CLAIM TO ANY PARTICULAR FONT, STYLE, SIZE, OR COLOR.

NO CLAIM IS MADE TO THE EXCLUSIVE RIGHT TO USE "GROUP", APART FROM THE MARK AS SHOWN.

FOR INSURANCE, NAMELY, PROPERTY, CASUALTY, ACCIDENT, HEALTH, LIFE AND LIABILITY INSURANCE AND REINSURANCE UNDERWRITING; INSURANCE SERVICES, NAMELY, CLAIMS ADMINISTRATION AND PROCESSING SERVICES, LOSS CONTROL SERVICES, BROKERAGE SERVICES, CONSULTATION AND PLANNING SERVICES, RISK MANAGEMENT SERVICES, SUBROGATION AND ACTUARIAL SERVICES, CLAIMS ADJUSTMENT, AND INSURANCE APPRAISALS, ALL IN THE FIELDS OF PROPERTY, CASUALTY, ACCIDENT, HEALTH, LIFE AND LIABILITY INSURANCE AND REINSURANCE; RELATED FINANCIAL SERVICES, NAMELY, FINANCIAL GUARANTY AND SURETY INSURANCE AND REINSURANCE, MORTGAGE GUARANTY, TRADE CREDIT AND RESIDUAL VALUE INSURANCE, TITLE COVER, ASSET MANAGEMENT, TRUST ACCOUNT AND CUSTODIAL SERVICES, AND MORTGAGE GUARANTY ASSURANCE UNDERWRITING; AND RELATED FINANCIAL RISK MANAGEMENT SERVICES, NAMELY, UNDERWRITING CREDIT DEFAULT SWAPS, FINITE RISK STRUCTURES, FINANCIAL DERIVATIVES, AND BALANCE SHEET PROTECTION PRODUCTS; ASSET MANAGEMENT; AND TRUST ACCOUNT AND CUSTODIAL SERVICES (U.S. CLS. 100, 101 AND 102).

FIRST USE 7-0-1999; IN COMMERCE 7-0-1999.
DORITT L. CARROLL, EXAMINING ATTORNEY

SN 78-518,857. AAMES INVESTMENT CORPORATION, LOS ANGELES, CA. FILED 11-17-2004.

AAMES INVESTMENT

THE MARK CONSISTS OF STANDARD CHARACTERS WITHOUT CLAIM TO ANY PARTICULAR FONT, STYLE, SIZE, OR COLOR.

OWNER OF U.S. REG. NO. 2,002,362.

NO CLAIM IS MADE TO THE EXCLUSIVE RIGHT TO USE INVESTMENT, APART FROM THE MARK AS SHOWN.

FOR FINANCIAL SERVICES, NAMELY, REAL ESTATE INVESTMENT AND TRUST SERVICES; MORTGAGE BANKING AND BROKERAGE SERVICES; LOAN ORIGINATION AND SECURITIZATION SERVICES (U.S. CLS. 100, 101 AND 102).

FIRST USE 3-0-2004; IN COMMERCE 11-17-2004.
ODESSA BIBBINS, EXAMINING ATTORNEY

CLASS 36—(Continued).

SN 78-532,385. DOGSTERS, LLC, MILFORD, CT. FILED 12-14-2004.

UNITED FIDO ORBITERS

THE MARK CONSISTS OF STANDARD CHARACTERS WITHOUT CLAIM TO ANY PARTICULAR FONT, STYLE, SIZE, OR COLOR.

FOR BUSINESS MANAGEMENT CONSULTING, NAMELY, ARRANGING FOR RETAIL OUTLETS TO MARKET, PROMOTE AND SELL PET FOOD AND PET ACCESSORIES; RETAIL STORE SERVICES FEATURING PET FOOD AND PET ACCESSORIES; OFFERING TECHNICAL ASSISTANCE IN OBTAINING FRANCHISEES FOR THE SALE OF PET FOOD AND PET ACCESSORIES (U.S. CLS. 100, 101 AND 102).

TINA L. SNAPP, EXAMINING ATTORNEY

SN 78-589,650. ZILLOW, INC., SEATTLE, WA. FILED 3-17-2005.

ZILLOW.COM

THE MARK CONSISTS OF STANDARD CHARACTERS WITHOUT CLAIM TO ANY PARTICULAR FONT, STYLE, SIZE, OR COLOR.

FOR OPERATING MARKETPLACES FOR SELLERS OF GOODS AND SERVICES IN THE FIELD OF REAL ESTATE; REAL ESTATE AGENCIES AND BROKERAGE; REAL ESTATE CONSULTANCY, APPRAISAL AND VALUATION SERVICES, FINANCIAL VALUATION OF PERSONAL PROPERTY AND REAL ESTATE; PROVIDING INFORMATION IN THE FIELD OF REAL ESTATE (U.S. CLS. 100, 101 AND 102).

DAVID TAYLOR, EXAMINING ATTORNEY

CLASS 36—(Continued).

SN 78-609,534. ISO PROPERTIES, INC., WILMINGTON, DE. FILED 4-15-2005.



OWNER OF U.S. REG. NO. 2,662,173.

FOR INSURANCE RATING SERVICES AND INSURANCE RATING DATA SERVICES, NAMELY, PROVIDING DATA ALLOWING INSURANCE CARRIERS AND INSURANCE UNDERWRITERS TO USE AND APPLY INSURANCE RATES USING PREDEFINED DECISIONS AND PARAMETERS, AND PROVIDING DATA TO UPDATE THOSE PREDEFINED DECISIONS AND PARAMETERS AUTOMATICALLY UPON THE FILING OF NEW RATES WITH STATE INSURANCE DEPARTMENTS (U.S. CLS. 100, 101 AND 102).

FIRST USE 11-0-2004; IN COMMERCE 11-0-2004.
IRENE D. WILLIAMS, EXAMINING ATTORNEY

SN 78-613,119. CBA - MEZZANINE CAPITAL HOLDINGS, LLC, SHORT HILLS, NJ. FILED 4-20-2005.

MEZZ CAP

THE MARK CONSISTS OF STANDARD CHARACTERS WITHOUT CLAIM TO ANY PARTICULAR FONT, STYLE, SIZE, OR COLOR.

OWNER OF U.S. REG. NO. 2,894,413.

NO CLAIM IS MADE TO THE EXCLUSIVE RIGHT TO USE "MEZZ", APART FROM THE MARK AS SHOWN.

FOR FINANCIAL SERVICES, NAMELY REAL ESTATE SECURITIZATION SERVICES; MORTGAGE BANKING SERVICES, NAMELY, ORIGINATION, ACQUISITION, SERVICING AND SECURITIZATION OF MORTGAGE LOANS; REAL ESTATE FINANCING SERVICES; AND FINANCIAL AND REAL ESTATE CONSULTANCY, ADVISORY AND INFORMATION SERVICES RELATING TO ALL THE FOREGOING SERVICES (U.S. CLS. 100, 101 AND 102).

FIRST USE 12-0-2001; IN COMMERCE 12-0-2001.
SARA THOMAS, EXAMINING ATTORNEY

CLASS 36—(Continued).

SN 78-619,913. PERSHING INVESTMENTS LLC, NEWARK, DE. FILED 4-29-2005.

Pershing

Advisor Solutions

OWNER OF U.S. REG. NOS. 2,245,524, 2,736,385 AND 3,016,685.

NO CLAIM IS MADE TO THE EXCLUSIVE RIGHT TO USE "ADVISOR SOLUTIONS", APART FROM THE MARK AS SHOWN.

FOR FINANCIAL SERVICES AND PRIME BROKERAGE SERVICES, NAMELY BROKERAGE AND DEALER SERVICES IN SECURITIES, BONDS, MUTUAL FUNDS, AND INVESTMENT VEHICLES PROVIDED TO MONEY MANAGERS; FINANCIAL INVESTMENT AND MANAGEMENT SERVICES; FINANCIAL CONSULTING SERVICES (U.S. CLS. 100, 101 AND 102).

SEAN CROWLEY, EXAMINING ATTORNEY

SN 78-634,191. AMERICASBANK CORP., TOWSON, MD. FILED 5-20-2005.

AMERICASBANK

THE MARK CONSISTS OF STANDARD CHARACTERS WITHOUT CLAIM TO ANY PARTICULAR FONT, STYLE, SIZE, OR COLOR.

OWNER OF U.S. REG. NOS. 2,246,780 AND 2,427,771.

SEC. 2(F).

FOR BANKING SERVICES (U.S. CLS. 100, 101 AND 102).

FIRST USE 12-1-1997; IN COMMERCE 12-1-1997.

MICHELE SWAIN, EXAMINING ATTORNEY

SN 78-636,125. MCCLURE, KELLY, LINCOLN, CA. FILED 5-24-2005.

CALIFORNIA MORTGAGE MART

THE MARK CONSISTS OF STANDARD CHARACTERS WITHOUT CLAIM TO ANY PARTICULAR FONT, STYLE, SIZE, OR COLOR.

NO CLAIM IS MADE TO THE EXCLUSIVE RIGHT TO USE "MORTGAGE", APART FROM THE MARK AS SHOWN.

SEC. 2(F).

FOR MORTGAGE BROKERAGE SERVICES (U.S. CLS. 100, 101 AND 102).

FIRST USE 5-31-1998; IN COMMERCE 5-31-1998.

JORDAN BAKER, EXAMINING ATTORNEY

CLASS 36—(Continued).

SN 78-646,486. ITG SOFTWARE SOLUTIONS, INC., CULVER CITY, CA. FILED 6-8-2005.

WHERE RISK CONTROL MEETS
COST CONTROL

THE MARK CONSISTS OF STANDARD CHARACTERS WITHOUT CLAIM TO ANY PARTICULAR FONT, STYLE, SIZE, OR COLOR.

FOR FINANCIAL SERVICES, NAMELY, PROVIDING PORTFOLIO MANAGEMENT, PORTFOLIO TRADING, PORTFOLIO OPTIMIZATION SERVICES, AND PRE AND POST TRADE PORTFOLIO FINANCIAL ANALYSIS (U.S. CLS. 100, 101 AND 102).

FIRST USE 8-0-2003; IN COMMERCE 8-0-2003.
CHRISTOPHER OTT, EXAMINING ATTORNEY

SN 78-659,049. YOUR-BEST-RATE FINANCIAL, LLC, ATLANTA, GA. FILED 6-27-2005.

YOUR BEST RATE

THE MARK CONSISTS OF STANDARD CHARACTERS WITHOUT CLAIM TO ANY PARTICULAR FONT, STYLE, SIZE, OR COLOR.

SEC. 2(F).
FOR MORTGAGE LENDING SERVICES (U.S. CLS. 100, 101 AND 102).

FIRST USE 5-1-2001; IN COMMERCE 5-1-2001.
AMY ALFIERI, EXAMINING ATTORNEY

SN 78-661,728. WASHINGTON MUTUAL, INC., SEATTLE, WA. FILED 6-30-2005.

WAMU DIRECT

THE MARK CONSISTS OF STANDARD CHARACTERS WITHOUT CLAIM TO ANY PARTICULAR FONT, STYLE, SIZE, OR COLOR.

OWNER OF U.S. REG. NOS. 2,315,782, 2,483,253 AND 2,498,860.

NO CLAIM IS MADE TO THE EXCLUSIVE RIGHT TO USE "DIRECT", APART FROM THE MARK AS SHOWN.

FOR BANKING SERVICES, NAMELY, PROVIDING A FULL LINE OF BANKING SERVICES PROVIDED VIA COMPUTER AND GLOBAL COMPUTER NETWORKS; ELECTRONIC CASH TRANSACTIONS; BANKING SERVICES; CHECKING ACCOUNT SERVICES; SAVINGS AND CERTIFICATE OF DEPOSIT ACCOUNT SERVICES; DEBIT CARD SERVICES; CREDIT CARD SERVICES; CASH CARD SERVICES; ATM SERVICES; ELECTRONIC BILL PAY SERVICES; MORTGAGE AND EQUITY LENDING SERVICES; HOME EQUITY LINES OF CREDIT; CONSUMER LENDING SERVICES; FINANCIAL SPONSORSHIP OF SPORTING, CULTURAL AND EDUCATIONAL EVENTS (U.S. CLS. 100, 101 AND 102).

WOODROW HARTZOG, EXAMINING ATTORNEY

CLASS 36—(Continued).

SN 78-662,250. ADAME, FRANCISCO, CONCORD, CA. FILED 6-30-2005.

HCFA

THE MARK CONSISTS OF STANDARD CHARACTERS WITHOUT CLAIM TO ANY PARTICULAR FONT, STYLE, SIZE, OR COLOR.

FOR MORTGAGE BROKERAGE (U.S. CLS. 100, 101 AND 102).

FIRST USE 9-0-2003; IN COMMERCE 2-9-2004.
LESLEY LAMOTHE, EXAMINING ATTORNEY

SN 78-670,447. AMERICAN INSURANCE ADMINISTRATORS, INC., COLUMBUS, OH. FILED 7-14-2005.

LIFE LEGACY

THE MARK CONSISTS OF STANDARD CHARACTERS WITHOUT CLAIM TO ANY PARTICULAR FONT, STYLE, SIZE, OR COLOR.

FOR INSURANCE SERVICES, NAMELY BUNDLING DONATIONS BY MULTIPLE DONORS TO PURCHASE LIFE INSURANCE FOR THE BENEFIT OF THE DONEE (U.S. CLS. 100, 101 AND 102).

FIRST USE 5-9-2005; IN COMMERCE 5-9-2005.
LEIGH CAROLINE CASE, EXAMINING ATTORNEY

SN 78-675,345. MASORTI FOUNDATION FOR CONSERVATIVE JUDAISM IN ISRAEL, NEW YORK, NY. FILED 7-21-2005.



THE MARK CONSISTS OF AN OUTLINE OF TWO TABLETS CONTAINING THE HEBREW LETTER "MEM".
THE FOREIGN WORDING IN THE MARK TRANSLATES INTO ENGLISH AS TRADITIONAL.

"THE NON-LATIN CHARACTER(S) IN THE MARK TRANSLITERATES INTO "MEM", AND THIS MEANS (NO TRANSLATION) IN ENGLISH".

FOR CHARITABLE FUND-RAISING SERVICES (U.S. CLS. 100, 101 AND 102).

FIRST USE 10-28-1996; IN COMMERCE 10-28-1996.
DAVID TAYLOR, EXAMINING ATTORNEY

CLASS 36—(Continued).

SN 78-681,678. THE PITTSBURGH FOUNDATION, PITTSBURGH, PA. FILED 7-29-2005.



**THE PITTSBURGH
FOUNDATION**

NO CLAIM IS MADE TO THE EXCLUSIVE RIGHT TO USE "FOUNDATION", APART FROM THE MARK AS SHOWN.

SEC. 2(F) "THE PITTSBURGH FOUNDATION".
FOR MANAGING CHARITABLE ENDOWMENTS; INVESTING AND ADMINISTERING A POOL OF ENDOWMENT FUNDS ESTABLISHED BY INDIVIDUALS, FAMILIES, BUSINESSES, AND ORGANIZATIONS; ADMINISTRATIVE SERVICES FOR CURRENT DISTRIBUTION FUNDS, NAMELY COLLECTING AND HOLDING PAPER CHECKS, PAPER MONEY AND ELECTRONIC FUNDS FROM DONORS, AND TRANSFERRING PAPER CHECKS AND ELECTRONIC FUNDS TO DONEES; ADMINISTRATION OF PLANNED GIVING AND TRUSTS; CHARITABLE FUNDRAISING; ADMINISTERING A CHARITABLE COMMUNITY FUND AND PROVIDING GRANTS TO NON-PROFIT ORGANIZATIONS FROM A CHARITABLE COMMUNITY FUND FOR THE PURPOSES OF ACHIEVING EDUCATIONAL EXCELLENCE AND EQUITY, FOSTERING ECONOMIC DEVELOPMENT, SUPPORTING FAMILIES, CHILDREN AND YOUTH, REDUCING DISPARITIES IN HEALTH OUTCOMES, AND ADVANCING THE ARTS (U.S. CLS. 100, 101 AND 102).

FIRST USE 5-31-1996; IN COMMERCE 5-31-1996.
SUSAN BILLHEIMER, EXAMINING ATTORNEY

SN 78-682,323. MINT MANAGEMENT, INC., HOUSTON, TX. FILED 7-31-2005.

MINT

THE MARK CONSISTS OF STANDARD CHARACTERS WITHOUT CLAIM TO ANY PARTICULAR FONT, STYLE, SIZE, OR COLOR.

OWNER OF U.S. REG. NO. 2,768,201.
FOR ENERGY BROKERAGE SERVICES, NAMELY TRADING, BUYING AND SELLING OF ENERGY FOR OTHERS; ENERGY COMMODITIES TRADING FOR OTHERS; ENERGY-RELATED FINANCIAL INSTRUMENTS TRADING FOR OTHERS; CONSULTING SERVICES IN THE FIELD OF ENERGY BROKERAGE AND ENERGY BROKERAGE MANAGEMENT; ENERGY BROKERAGE SERVICES (U.S. CLS. 100, 101 AND 102).
DOMINICK J. SALEMI, EXAMINING ATTORNEY

CLASS 36—(Continued).

SN 78-688,550. WELSHCO, LLC, MINNEAPOLIS, MN. FILED 8-9-2005.

WELSH CAPITAL

THE MARK CONSISTS OF STANDARD CHARACTERS WITHOUT CLAIM TO ANY PARTICULAR FONT, STYLE, SIZE, OR COLOR.

NO CLAIM IS MADE TO THE EXCLUSIVE RIGHT TO USE "CAPITAL", APART FROM THE MARK AS SHOWN.
FOR MORTGAGE REAL ESTATE FINANCING SERVICES; FINANCIAL PLANNING AND MANAGEMENT SERVICES; FINANCIAL MANAGEMENT SERVICES; REAL ESTATE INVESTMENT ADVISORY SERVICES; PROPERTY MORTGAGE BROKERAGE, MORTGAGE LENDING SERVICES; FINANCIAL ANALYSIS AND CONSULTATION SERVICES (U.S. CLS. 100, 101 AND 102).

FIRST USE 10-1-1998; IN COMMERCE 10-1-1998.
JIM RINGLE, EXAMINING ATTORNEY

SN 78-693,662. MCDONALD'S CORPORATION, OAK BROOK, IL. FILED 8-16-2005.



OWNER OF U.S. REG. NOS. 2,377,753, 2,377,754 AND OTHERS.

THE NAME RONALD MCDONALD DOES NOT IDENTIFY A LIVING INDIVIDUAL.
FOR CHARITABLE FUNDRAISING SERVICES (U.S. CLS. 100, 101 AND 102).
FIRST USE 9-30-2002; IN COMMERCE 9-30-2002.
CYNTHIA SLOAN, EXAMINING ATTORNEY

CLASS 36—(Continued).

SN 78-694,408. NEW YORK COMMUNITY BANCORP, INC., WESTBURY, NY. FILED 8-17-2005.



FOR FINANCIAL SERVICES, NAMELY CREDITING ACCOUNTS WITH EARNED AMOUNTS AND PROVIDING ACCESS TO CREDITED FUNDS; DEBIT CARD SERVICES; DEBIT CARD SERVICES KEYED TO ACCOUNTS ACCESSIBLE AT A RETAIL POINT OF PURCHASE THROUGH THE USE OF A PERSONAL IDENTIFICATION NUMBER; DEBIT CARD SERVICES KEYED TO ACCOUNTS ACCESSIBLE AT A RETAIL POINT OF PURCHASE THROUGH THE USE OF A PERSONAL IDENTIFICATION NUMBER OR A COMMERCIAL CREDIT CARD ISSUER; DEBIT CARD SERVICES KEYED TO ACCOUNTS, WHICH ARE NOT BANK ACCOUNTS, ACCESSIBLE AT A RETAIL POINT OF PURCHASE THROUGH THE USE OF A PERSONAL IDENTIFICATION NUMBER (U.S. CLS. 100, 101 AND 102).

TIMOTHY FINNEGAN, EXAMINING ATTORNEY

SN 78-697,268. DANA-FARBER CANCER INSTITUTE, INC., BOSTON, MA. FILED 8-22-2005.

A CHANCE FOR KIDS

THE MARK CONSISTS OF STANDARD CHARACTERS WITHOUT CLAIM TO ANY PARTICULAR FONT, STYLE, SIZE, OR COLOR.

FOR CHARITABLE FUND RAISING SERVICES TO RAISE MONEY FOR CANCER TREATMENT CENTER OPERATIONS, CANCER RESEARCH AND CANCER EDUCATION AND AWARENESS (U.S. CLS. 100, 101 AND 102).

FIRST USE 1-1-2001; IN COMMERCE 1-1-2001.
AMEETA JORDAN, EXAMINING ATTORNEY

SN 78-701,601. MOVING INSURANCE, LLC, MONTCLAIR, NJ. FILED 8-26-2005.

BE SAFE. SECURE. INSURED.

THE MARK CONSISTS OF STANDARD CHARACTERS WITHOUT CLAIM TO ANY PARTICULAR FONT, STYLE, SIZE, OR COLOR.

FOR PROVIDING INFORMATION IN THE FIELD OF INSURANCE BY MEANS OF A GLOBAL COMPUTER NETWORK; INSURANCE AGENCY, BROKERAGE AND UNDERWRITING SERVICES IN THE FIELDS OF MOVING, PROPERTY, CASUALTY, AND LIABILITY INSURANCE (U.S. CLS. 100, 101 AND 102).

FIRST USE 1-1-2004; IN COMMERCE 1-1-2004.
WOODROW HARTZOG, EXAMINING ATTORNEY

CLASS 36—(Continued).

SN 78-705,076. CONTRARIAN CAPITAL MANAGEMENT, LLC, GREENWICH, CT. FILED 9-1-2005.

CONTRARIAN CAPITAL

THE MARK CONSISTS OF STANDARD CHARACTERS WITHOUT CLAIM TO ANY PARTICULAR FONT, STYLE, SIZE, OR COLOR.

NO CLAIM IS MADE TO THE EXCLUSIVE RIGHT TO USE "CAPITAL", APART FROM THE MARK AS SHOWN.

SEC. 2(F).

FOR FINANCIAL SERVICES, NAMELY, INVESTMENT MANAGEMENT SERVICES AND INVESTMENT CONSULTATION IN RELATION THERETO (U.S. CLS. 100, 101 AND 102).

FIRST USE 5-15-1995; IN COMMERCE 5-15-1995.
CYNTHIA SLOAN, EXAMINING ATTORNEY

SN 78-706,313. ING GROEP N.V., AMSTERDAM, NETHERLANDS, FILED 9-2-2005.

ING SMARTDESIGN SIMPLEFLEX ANNUITY

THE MARK CONSISTS OF STANDARD CHARACTERS WITHOUT CLAIM TO ANY PARTICULAR FONT, STYLE, SIZE, OR COLOR.

OWNER OF U.S. REG. NOS. 1,804,417, 2,718,571 AND OTHERS.

NO CLAIM IS MADE TO THE EXCLUSIVE RIGHT TO USE "ANNUITY", APART FROM THE MARK AS SHOWN.

FOR ANNUITY SERVICES, NAMELY, ADMINISTRATION, INVESTMENT AND DISTRIBUTION OF ANNUITIES (U.S. CLS. 100, 101 AND 102).

KATHERINE STOIDES, EXAMINING ATTORNEY

SN 78-707,544. HERITAGE AFFINITY ENTERPRISES LLC, DBA HERITAGE AFFINITY SERVICES, CEDARHURST, NY. FILED 9-6-2005.



NO CLAIM IS MADE TO THE EXCLUSIVE RIGHT TO USE "AFFINITY SERVICES", APART FROM THE MARK AS SHOWN.

THE GRAY INDICATED IN DRAWING IS FOR SHADING PURPOSES ONLY AND IS NOT A CLAIMED FEATURE OF THE MARK.

FOR CHARITABLE FUND RAISING SERVICES, CREDIT CARD SERVICES (U.S. CLS. 100, 101 AND 102).
KELLY BOULTON, EXAMINING ATTORNEY

CLASS 36—(Continued).

SN 78-709,184. NEW WIRELESS SERVICES, INC., BEDFORD, MA. FILED 9-8-2005.

WEBCARE

THE MARK CONSISTS OF STANDARD CHARACTERS WITHOUT CLAIM TO ANY PARTICULAR FONT, STYLE, SIZE, OR COLOR.

FOR PROVIDING ONLINE ACCOUNT INFORMATION TO WIRELESS COMMUNICATIONS CARRIERS SO THAT THEIR CUSTOMER SERVICE REPRESENTATIVES CAN RESPOND TO SUBSCRIBER REQUESTS (U.S. CLS. 100, 101 AND 102).

FIRST USE 5-15-2001; IN COMMERCE 6-15-2001.
ARETHA SOMERVILLE, EXAMINING ATTORNEY

CLASS 36—(Continued).

SN 78-714,205. ONE SCOTTSDALE HOLDINGS LLC, SCOTTSDALE, AZ. FILED 9-15-2005.

ONE SCOTTSDALE

THE MARK CONSISTS OF STANDARD CHARACTERS WITHOUT CLAIM TO ANY PARTICULAR FONT, STYLE, SIZE, OR COLOR.

NO CLAIM IS MADE TO THE EXCLUSIVE RIGHT TO USE "SCOTTSDALE", APART FROM THE MARK AS SHOWN.

FOR REAL ESTATE BROKERAGE SERVICES FOR CUSTOM HOMES, PRODUCTION HOMES AND CUSTOM HOME SITES (U.S. CLS. 100, 101 AND 102).

CAROLYN CATALDO, EXAMINING ATTORNEY

SN 78-715,532. MERITAS EDUCATIONAL FUNDING, INC., HERSHEY, PA. FILED 9-19-2005.

MERITAS EDUCATIONAL FUNDING

THE MARK CONSISTS OF STANDARD CHARACTERS WITHOUT CLAIM TO ANY PARTICULAR FONT, STYLE, SIZE, OR COLOR.

NO CLAIM IS MADE TO THE EXCLUSIVE RIGHT TO USE "EDUCATIONAL FUNDING", APART FROM THE MARK AS SHOWN.

FOR STUDENT LOAN SERVICES, NAMELY, PROVIDING, SECONDARY-MARKET PURCHASING, AND SERVICING STUDENT LOANS (U.S. CLS. 100, 101 AND 102).

ALICE SUE CARRUTHERS, EXAMINING ATTORNEY

SN 78-711,666. NAVY FEDERAL CREDIT UNION, MERRIFIELD, VA. FILED 9-13-2005.



Walter the Walrus

THE STIPPLING IS A FEATURE OF THE MARK. THE MARK CONSISTS OF PICTURE OF A WALRUS WITH THE WORDS WALTER THE WALRUS UNDERNEATH.

FOR CREDIT UNION SERVICES, NAMELY, CHILDREN'S SAVINGS ACCOUNTS (U.S. CLS. 100, 101 AND 102).

MYRIAH HABEEB, EXAMINING ATTORNEY

SN 78-718,923. SHARE OUR STRENGTH, WASHINGTON, DC. FILED 9-22-2005.

RESTAURANTS FOR RELIEF ONE MEAL ONE NIGHT ONE NATION

THE MARK CONSISTS OF STANDARD CHARACTERS WITHOUT CLAIM TO ANY PARTICULAR FONT, STYLE, SIZE, OR COLOR.

NO CLAIM IS MADE TO THE EXCLUSIVE RIGHT TO USE "RESTAURANT", APART FROM THE MARK AS SHOWN.

FOR CHARITABLE FUND RAISING SERVICES (U.S. CLS. 100, 101 AND 102).

FIRST USE 9-8-2005; IN COMMERCE 9-8-2005.
LA TONIA FISHER, EXAMINING ATTORNEY

CLASS 36—(Continued).

SN 78-718,933. SHARE OUR STRENGTH, WASHINGTON, DC. FILED 9-22-2005.

RESTAURANTS FOR RELIEF

THE MARK CONSISTS OF STANDARD CHARACTERS WITHOUT CLAIM TO ANY PARTICULAR FONT, STYLE, SIZE, OR COLOR.

NO CLAIM IS MADE TO THE EXCLUSIVE RIGHT TO USE "RESTAURANT", APART FROM THE MARK AS SHOWN.

FOR CHARITABLE FUND RAISING SERVICES (U.S. CLS. 100, 101 AND 102).

FIRST USE 9-8-2005; IN COMMERCE 9-8-2005.
LA TONIA FISHER, EXAMINING ATTORNEY

SN 78-719,048. WELLS FARGO & COMPANY, MINNEAPOLIS, MN. FILED 9-23-2005.

STAGECOACH ISLAND

THE MARK CONSISTS OF STANDARD CHARACTERS WITHOUT CLAIM TO ANY PARTICULAR FONT, STYLE, SIZE, OR COLOR.

OWNER OF U.S. REG. NOS. 2,364,213, 2,595,974 AND OTHERS.

FOR BANKING SERVICES; ONLINE BANKING SERVICES; FINANCIAL SERVICES, NAMELY, CREDIT CARD AND DEBIT CARD SERVICES, CONSUMER LENDING SERVICES AND STUDENT LOAN SERVICES; PROVIDING INFORMATION REGARDING BANKING, CREDIT, MONEY MANAGEMENT, INVESTING, INVESTMENTS AND FINANCIAL MATTERS; COUNSELING IN THE FIELD OF BANKING AND FINANCIAL SERVICES (U.S. CLS. 100, 101 AND 102).

ANDREW RHIM, EXAMINING ATTORNEY

SN 78-719,909. RUPE COMPANIES INC., BOISE, ID. FILED 9-23-2005.

LAND TITLE ESCROW

THE MARK CONSISTS OF STANDARD CHARACTERS WITHOUT CLAIM TO ANY PARTICULAR FONT, STYLE, SIZE, OR COLOR.

NO CLAIM IS MADE TO THE EXCLUSIVE RIGHT TO USE "ESCROW", APART FROM THE MARK AS SHOWN.

SEC. 2(F).
FOR ESCROW COLLECTION AGENCY (U.S. CLS. 100, 101 AND 102).

FIRST USE 12-0-2000; IN COMMERCE 12-0-2000.
GEOFFREY FOSDICK, EXAMINING ATTORNEY

CLASS 36—(Continued).

SN 78-720,102. FAMILIES AND SCHOOLS TOGETHER FEDERAL CREDIT UNION, HANFORD, CA. FILED 9-25-2005.



NO CLAIM IS MADE TO THE EXCLUSIVE RIGHT TO USE "FEDERAL CREDIT UNION", APART FROM THE MARK AS SHOWN.

THE MARK CONTAINS STYLIZED DEPICTIONS OF PEOPLE, LINED OVALS AND THE STYLIZED WORD "FAST".

FOR CREDIT UNION SERVICES (U.S. CLS. 100, 101 AND 102).

FIRST USE 8-1-1999; IN COMMERCE 8-1-1999.
RONALD AIKENS, EXAMINING ATTORNEY

SN 78-723,685. LISK, DANIEL T., BROOKLYN, NY. FILED 9-29-2005.

UrbanRebel

THE MARK CONSISTS OF STANDARD CHARACTERS WITHOUT CLAIM TO ANY PARTICULAR FONT, STYLE, SIZE, OR COLOR.

FOR REAL ESTATE BROKERAGE AND APPRAISAL SERVICES (U.S. CLS. 100, 101 AND 102).

FIRST USE 9-16-2005; IN COMMERCE 9-16-2005.
DAYNA BROWNE, EXAMINING ATTORNEY

SN 78-735,324. LEVY, SCHWARTZ & ASSOCIATES, LLC, WILMINGTON, DE. FILED 10-18-2005.

**LEVY SCHWARTZ
AND ASSOCIATES**

NO CLAIM IS MADE TO THE EXCLUSIVE RIGHT TO USE "AND ASSOCIATES", APART FROM THE MARK AS SHOWN.

FOR REAL ESTATE AGENCIES; APPRAISAL OF REAL ESTATE; PROVIDING INFORMATION IN THE FIELD OF REAL ESTATE BY MEANS OF LINKING THE WEBSITE TO OTHER WEBSITES FEATURING REAL ESTATE INFORMATION; REAL ESTATE LISTING; REAL ESTATE MARKETING SERVICES, NAMELY, ON-LINE SERVICES FEATURING TOURS OF RESIDENTIAL AND COMMERCIAL REAL ESTATE (U.S. CLS. 100, 101 AND 102).

FIRST USE 6-7-2005; IN COMMERCE 9-16-2005.
ELLEN B. AWRICH, EXAMINING ATTORNEY

CLASS 36—(Continued).

SN 78-737,808. BENFIELD HOLDINGS INC., MINNEAPOLIS, MN. FILED 10-21-2005.

BENFIELD. UNQUESTIONABLY
IN YOUR CORNER.

THE MARK CONSISTS OF STANDARD CHARACTERS WITHOUT CLAIM TO ANY PARTICULAR FONT, STYLE, SIZE, OR COLOR.

FOR REINSURANCE AND INSURANCE ADMINISTRATION, ANALYSIS, BROKERAGE, CLAIMS PROCESSING, CONSULTING AND MANAGEMENT SERVICES, REINSURANCE AGENCY SERVICES AND INSURANCE AGENCY SERVICES IN THE FIELDS OF HEALTH, LIFE, PROPERTY, CASUALTY AND WORKER'S COMPENSATION, RISK MANAGEMENT ADMINISTRATIVE AND CONSULTING SERVICES INCLUDING CATASTROPHIC MODELS SERVICES AND LOSS ACTUARIAL SERVICES (U.S. CLS. 100, 101 AND 102).

FIRST USE 9-26-2005; IN COMMERCE 9-26-2005.
LEIGH CAROLINE CASE, EXAMINING ATTORNEY

SN 78-741,888. WELLS FARGO & COMPANY, MINNEAPOLIS, MN. FILED 10-27-2005.

STAGECOACH INSURANCE
SERVICES

THE MARK CONSISTS OF STANDARD CHARACTERS WITHOUT CLAIM TO ANY PARTICULAR FONT, STYLE, SIZE, OR COLOR.

OWNER OF U.S. REG. NOS. 2,364,213, 2,595,974 AND OTHERS.

NO CLAIM IS MADE TO THE EXCLUSIVE RIGHT TO USE "INSURANCE SERVICES", APART FROM THE MARK AS SHOWN.

FOR FINANCIAL INVESTMENT SERVICES IN THE FIELD OF ANNUITIES (U.S. CLS. 100, 101 AND 102).
ANDREW RHIM, EXAMINING ATTORNEY

SN 78-742,638. SABRIENT SYSTEMS LLC, SANTA BARBARA, CA. FILED 10-28-2005.

SmartLink bridge

THE MARK CONSISTS OF STANDARD CHARACTERS WITHOUT CLAIM TO ANY PARTICULAR FONT, STYLE, SIZE, OR COLOR.

NO CLAIM IS MADE TO THE EXCLUSIVE RIGHT TO USE "BRIDGE", APART FROM THE MARK AS SHOWN.

FOR FINANCIAL SERVICES, NAMELY, FISCAL ASSESSMENT AND EVALUATION OF SECURITIES DELIVERED AS LISTS SELECTED BY USER-CUSTOMIZABLE CRITERIA (U.S. CLS. 100, 101 AND 102).

FIRST USE 7-1-2005; IN COMMERCE 7-1-2005.
BILL DAWE, EXAMINING ATTORNEY

CLASS 36—(Continued).

SN 78-750,873. COMMISSION CASH, INC., STERLING, VA. FILED 11-9-2005.



The logo for Commission Cash features the words "Commission Cash" in a bold, blue, sans-serif font. Above the text is a green swoosh that starts under "Commission" and ends under "Cash", arching over the space between the two words.

OWNER OF U.S. REG. NO. 3,016,389.

NO CLAIM IS MADE TO THE EXCLUSIVE RIGHT TO USE "COMMISSION CASH", APART FROM THE MARK AS SHOWN.

THE COLOR(S) BLUE AND GREEN IS/ARE CLAIMED AS A FEATURE OF THE MARK.

THE COLOR BLUE APPEARS IN THE WORDING AND THE COLOR GREEN APPEARS IN THE DESIGN ABOVE THE WORDING.

FOR REAL ESTATE COMMISSIONS FACTORING SERVICES, NAMELY THE PURCHASE OF COMMISSIONS FROM REAL ESTATE AGENTS AT A DISCOUNTED RATE (U.S. CLS. 100, 101 AND 102).

FIRST USE 7-20-2005; IN COMMERCE 10-22-2005.
MICHAEL WEBSTER, EXAMINING ATTORNEY

SN 78-762,284. BANCO POPULAR ESPANOL, S.A., 28001 MADRID, SPAIN, FILED 11-29-2005.

BPE BANK

THE MARK CONSISTS OF STANDARD CHARACTERS WITHOUT CLAIM TO ANY PARTICULAR FONT, STYLE, SIZE, OR COLOR.

NO CLAIM IS MADE TO THE EXCLUSIVE RIGHT TO USE "BANK", APART FROM THE MARK AS SHOWN.

FOR BANKING SERVICES, INSURANCE AGENCY AND BROKERAGE, FINANCIAL PLANNING AND MANAGEMENT; MONETARY EXCHANGE, REAL ESTATE AGENCY SERVICES; PROVISION OF INFORMATION RELATING TO FINANCE; ISSUING OF CREDIT CARDS; CREDIT AND DEBIT CARD SERVICES; ALL LISTED SERVICES PROVIDED IN THE STANDARD MANNER OR VIA WORLDWIDE EXTERNAL AND INTERNAL COMPUTER NETWORKS (U.S. CLS. 100, 101 AND 102).

KYLE PEETE, EXAMINING ATTORNEY

CLASS 36—(Continued).

SN 78-763,725. PINK SHEETS LLC, NEW YORK, NY. FILED 11-30-2005.

PremierQX

THE MARK CONSISTS OF STANDARD CHARACTERS WITHOUT CLAIM TO ANY PARTICULAR FONT, STYLE, SIZE, OR COLOR.

FOR PROVIDING FINANCIAL INFORMATION IN THE NATURE OF MARKET QUOTATIONS AND ORDERS THROUGH A WEBSITE; COLLECTING, ORGANIZING, PROCESSING AND DISSEMINATING FINANCIAL AND SECURITIES INFORMATION THROUGH A WEBSITE; PROVIDING AN ON-LINE COMPUTER DATABASE FEATURING FINANCIAL INVESTMENT INFORMATION (U.S. CLS. 100, 101 AND 102).

JESSICA A. POWERS, EXAMINING ATTORNEY

SN 78-766,276. INTERBOLSA, S.A. COMISIONISTA DE BOLSA, MEDELLIN, COLOMBIA. FILED 12-5-2005.



InterBolsa
Creadores de Mercado

NO CLAIM IS MADE TO THE EXCLUSIVE RIGHT TO USE "MERCADO", APART FROM THE MARK AS SHOWN. "THE FOREIGN WORDING IN THE MARK TRANSLATES INTO ENGLISH AS INTERBOLSA MARKET CREATORS."

FOR FINANCIAL SERVICES, NAMELY, FINANCIAL CONSULTATION, FINANCIAL EXCHANGE, FINANCIAL FORECASTING, MONETARY EXCHANGE (U.S. CLS. 100, 101 AND 102).

WARREN L. OLANDRIA, EXAMINING ATTORNEY

SN 78-771,926. GOLDEN TRIANGLE, INC., BILLINGS, MT. FILED 12-13-2005.



FIRST
National Pawn

NO CLAIM IS MADE TO THE EXCLUSIVE RIGHT TO USE "NATIONAL PAWN", APART FROM THE MARK AS SHOWN.

FOR PAWN SHOPS (U.S. CLS. 100, 101 AND 102).
FIRST USE 2-1-1982; IN COMMERCE 8-1-1990.
SARAH WAYDA, EXAMINING ATTORNEY

CLASS 36—(Continued).

SN 78-774,696. DESARROLLO MARINA VALLARTA, S.A. DE C.V., GUADALAJARA, MEXICO, FILED 12-15-2005.

NEW ROCKY POINT

THE MARK CONSISTS OF STANDARD CHARACTERS WITHOUT CLAIM TO ANY PARTICULAR FONT, STYLE, SIZE, OR COLOR.

NO CLAIM IS MADE TO THE EXCLUSIVE RIGHT TO USE "ROCKY POINT", APART FROM THE MARK AS SHOWN.

FOR VACATION REAL ESTATE TIME-SHARING (U.S. CLS. 100, 101 AND 102).

REBECCA GAN, EXAMINING ATTORNEY

SN 78-774,698. DESARROLLO MARINA VALLARTA, S.A. DE C.V., GUADALAJARA, MEXICO, FILED 12-15-2005.

NUEVO PUERTO PENASCO

THE MARK CONSISTS OF STANDARD CHARACTERS WITHOUT CLAIM TO ANY PARTICULAR FONT, STYLE, SIZE, OR COLOR.

NO CLAIM IS MADE TO THE EXCLUSIVE RIGHT TO USE "PUERTO PENASCO", APART FROM THE MARK AS SHOWN.

THE FOREIGN WORDING IN THE MARK TRANSLATES INTO ENGLISH AS NEW PUERTO PENASCO.

FOR VACATION REAL ESTATE TIME-SHARING (U.S. CLS. 100, 101 AND 102).

REBECCA GAN, EXAMINING ATTORNEY

CLASS 36—(Continued).

SN 78-776,521. ELLIOTT COVE CAPITAL MANAGEMENT LLC, SEATTLE, WA. FILED 12-19-2005.

**ELLIOTT COVE**

Capital Management

OWNER OF U.S. REG. NO. 2,851,947.

NO CLAIM IS MADE TO THE EXCLUSIVE RIGHT TO USE "CAPITAL MANAGEMENT", APART FROM THE MARK AS SHOWN.

THE NAME ELLIOTT COVE DOES NOT IDENTIFY ANY LIVING INDIVIDUALS.

THE MARK CONSISTS OF A PICTURE OF A LIGHTHOUSE WITH THREE BIRDS IN FLIGHT AGAINST A BACKGROUND OF SKY AND CLOUDS RENDERED WITH BROKEN HORIZONTAL LINES IN THE STYLE OF ANTIQUE ETCHINGS, NOT IN COLOR OR LINED FOR COLOR, ALL CONTAINED WITHIN A VERTICAL RECTANGLE WITH CURVED TOP AND BOTTOM; WITH THE WORDING ELLIOTT COVE BELOW THE RECTANGLE, AND THE WORDING CAPITAL MANAGEMENT BELOW ELLIOTT COVE.

FOR FINANCIAL SERVICES, NAMELY, PROVIDING FINANCIAL PLANNING AND FINANCIAL MANAGEMENT SERVICES, EXCLUDING INSURANCE RELATED SERVICES (U.S. CLS. 100, 101 AND 102).

FIRST USE 1-1-2003; IN COMMERCE 1-1-2003.

ODESSA BIBBINS, EXAMINING ATTORNEY

SN 78-778,833. 1ST COMMERCIAL CREDIT LLC, EL PASO, TX. FILED 12-21-2005.

1ST COMMERCIAL CREDIT

THE MARK CONSISTS OF STANDARD CHARACTERS WITHOUT CLAIM TO ANY PARTICULAR FONT, STYLE, SIZE, OR COLOR.

NO CLAIM IS MADE TO THE EXCLUSIVE RIGHT TO USE "COMMERCIAL CREDIT", APART FROM THE MARK AS SHOWN.

FOR LOAN CREDIT AND FACTORING SERVICES (U.S. CLS. 100, 101 AND 102).

FIRST USE 5-0-2001; IN COMMERCE 1-0-2002.

HOWARD B. LEVINE, EXAMINING ATTORNEY

CLASS 36—(Continued).

SN 78-785,949. WASHINGTON MUTUAL, INC., SEATTLE, WA. FILED 1-5-2006.

WAMU FREE CHECKING

THE MARK CONSISTS OF STANDARD CHARACTERS WITHOUT CLAIM TO ANY PARTICULAR FONT, STYLE, SIZE, OR COLOR.

OWNER OF U.S. REG. NOS. 2,315,782, 2,879,308 AND OTHERS.

NO CLAIM IS MADE TO THE EXCLUSIVE RIGHT TO USE "FREE CHECKING", APART FROM THE MARK AS SHOWN.

FOR BANKING SERVICES; AUTOMATED TELLER MACHINE SERVICES; SAVINGS, CHECKING AND CERTIFICATE OF DEPOSIT ACCOUNT SERVICES; CHECK CARD SERVICES; CREDIT CARD SERVICES; DEBIT CARD SERVICES; CASH CARD SERVICES; STORED VALUE CARD SERVICES; ONLINE BANKING SERVICES; ELECTRONIC PAYMENT SERVICES, NAMELY, ELECTRONIC PROCESSING AND TRANSMISSION OF BILL PAYMENT DATA; DEBT AND CREDIT ANALYSIS SERVICES; PROVIDING CONSULTING SERVICES, ADVICE AND INFORMATION TO ASSIST OTHERS IN PROTECTING CREDIT RATINGS; REGISTERING AND CANCELING CREDIT CARDS AND RESTORING CREDIT; PROVIDING INFORMATION ON PROTECTING CREDIT RATINGS, REGISTERING AND CANCELING CREDIT CARDS AND RESTORING AND ANALYZING CREDIT; CREDIT RATING SERVICES; CREDIT REPORTING SERVICES (U.S. CLS. 100, 101 AND 102).

NANCY CLARKE, EXAMINING ATTORNEY

SN 78-790,782. GFI GROUP INC., NEW YORK, NY. FILED 1-12-2006.

GFI FOREXMATCH

THE MARK CONSISTS OF STANDARD CHARACTERS WITHOUT CLAIM TO ANY PARTICULAR FONT, STYLE, SIZE, OR COLOR.

OWNER OF U.S. REG. NOS. 2,099,047, 3,081,665 AND OTHERS.

FOR FINANCIAL INVESTMENT IN THE FIELD OF SECURITIES AND DERIVATIVE FINANCIAL INSTRUMENTS; PROVIDING PRICING, MARKET AND TRADING INFORMATION FOR SECURITIES BY ELECTRONIC MEANS VIA A GLOBAL COMPUTER NETWORK; AUTOMATED SECURITIES BROKERAGE SERVICES, NAMELY, EXECUTION AND MANAGEMENT OF TRANSACTIONS INVOLVING SECURITIES BY ELECTRONIC MEANS VIA A GLOBAL COMPUTER NETWORK (U.S. CLS. 100, 101 AND 102).

JOHN SCHUYLER YARD, EXAMINING ATTORNEY

CLASS 36—(Continued).

SN 78-794,912. US BANCORP LICENSING, INC., MINNEAPOLIS, MN. FILED 1-19-2006.

FAF ADVISORS

THE MARK CONSISTS OF STANDARD CHARACTERS WITHOUT CLAIM TO ANY PARTICULAR FONT, STYLE, SIZE, OR COLOR.

NO CLAIM IS MADE TO THE EXCLUSIVE RIGHT TO USE "ADVISORS", APART FROM THE MARK AS SHOWN. FOR INVESTMENT MANAGEMENT AND INVESTMENT ADVISORY SERVICES (U.S. CLS. 100, 101 AND 102).

SONYA STEPHENS, EXAMINING ATTORNEY

CLASS 36—(Continued).

SN 78-813,271. TRAINOR ASSOCIATES, INC., NEW HARTFORD, NY. FILED 2-13-2006.

SNAP!

THE MARK CONSISTS OF STANDARD CHARACTERS WITHOUT CLAIM TO ANY PARTICULAR FONT, STYLE, SIZE, OR COLOR.

FOR BANKING SERVICES; AUTOMATED TELLER MACHINE SERVICES; DEBIT CARD SERVICES (U.S. CLS. 100, 101 AND 102).

MARIA-VICTORIA SUAREZ, EXAMINING ATTORNEY

SN 78-802,764. DAVID J. BOCZAR, LLC, EASTON, CT. FILED 1-30-2006.

SN 78-813,272. TRAINOR ASSOCIATES, INC., NEW HARTFORD, NY. FILED 2-13-2006.



FOR BANKING IN A CLIK

NO CLAIM IS MADE TO THE EXCLUSIVE RIGHT TO USE "WEALTH ADVISORS", APART FROM THE MARK AS SHOWN.

FOR PRIVATE WEALTH MANAGEMENT AND FINANCIAL PLANNING SERVICES (U.S. CLS. 100, 101 AND 102).

RAMONA ORTIGA, EXAMINING ATTORNEY

THE MARK CONSISTS OF STANDARD CHARACTERS WITHOUT CLAIM TO ANY PARTICULAR FONT, STYLE, SIZE, OR COLOR.

FOR BANKING SERVICES; AUTOMATED TELLER MACHINE SERVICES; DEBIT CARD SERVICES (U.S. CLS. 100, 101 AND 102).

MARIA-VICTORIA SUAREZ, EXAMINING ATTORNEY

SN 78-813,244. TRAINOR ASSOCIATES, INC., NEW HARTFORD, NY. FILED 2-13-2006.

SN 78-813,277. TRAINOR ASSOCIATES, INC., NEW HARTFORD, NY. FILED 2-13-2006.

CLIK!

FOR BANKING IN A SNAP

THE MARK CONSISTS OF STANDARD CHARACTERS WITHOUT CLAIM TO ANY PARTICULAR FONT, STYLE, SIZE, OR COLOR.

FOR BANKING SERVICES; AUTOMATED TELLER MACHINE SERVICES; DEBIT CARD SERVICES (U.S. CLS. 100, 101 AND 102).

MARIA-VICTORIA SUAREZ, EXAMINING ATTORNEY

THE MARK CONSISTS OF STANDARD CHARACTERS WITHOUT CLAIM TO ANY PARTICULAR FONT, STYLE, SIZE, OR COLOR.

FOR BANKING SERVICES; AUTOMATED TELLER MACHINE SERVICES; DEBIT CARD SERVICES (U.S. CLS. 100, 101 AND 102).

MARIA-VICTORIA SUAREZ, EXAMINING ATTORNEY

CLASS 36—(Continued).

SN 78-813,603. BOLLMAN, JEFFERY C, LAS VEGAS, NV.
FILED 2-13-2006.



NO CLAIM IS MADE TO THE EXCLUSIVE RIGHT TO USE "REALTY & FINANCIAL INC", APART FROM THE MARK AS SHOWN.

THE COLORS RED, GRAY, BLACK, AND WHITE ARE CLAIMED AS A FEATURE OF THE MARK.

THE COLOR RED APPEARS IN THE ROOF OF THE HOUSE AND THE GRAPHING LINE; THE COLOR GRAY APPEARS IN THE BASE OF THE HOUSE AND IN THE LIGHTER STRIPES ON THE RIGHT-HAND SIDE OF THE HIGH-RISE BUILDING; THE COLOR BLACK APPEARS IN THE UPPER LEVEL OF THE HOUSE, IN THE DARKER STRIPES ON THE HIGH-RISE BUILDING AND IN THE WORDING "BOLLMAN-CHAN REALTY & FINANCIAL INC."; THE COLOR WHITE APPEARS IN THE LIGHTER STRIPES ON THE LEFT-HAND SIDE OF THE HIGH-RISE BUILDING AND IN THE BACKGROUND OF THE MARK.

FOR REAL ESTATE BROKERAGE (U.S. CLS. 100, 101 AND 102).

FIRST USE 1-5-2006; IN COMMERCE 1-5-2006.
MICHAEL GAAFAR, EXAMINING ATTORNEY

SN 78-814,805. PREMIERA BLUE CROSS, SEATTLE, WA.
FILED 2-14-2006.

AK HERITAGESELECT HSA

THE MARK CONSISTS OF STANDARD CHARACTERS WITHOUT CLAIM TO ANY PARTICULAR FONT, STYLE, SIZE, OR COLOR.

NO CLAIM IS MADE TO THE EXCLUSIVE RIGHT TO USE "AK" AND "HSA", APART FROM THE MARK AS SHOWN.

FOR HEALTH, MEDICAL, HOSPITAL, PHARMACEUTICAL AND PRESCRIPTION DRUG INSURANCE UNDERWRITING; ADMINISTRATION AND ORGANIZING OF PREPAID AND PREFERRED PROVIDER HEALTH, MEDICAL, HOSPITAL, PHARMACEUTICAL, PRESCRIPTION DRUG PLANS AND HEALTH SAVINGS ACCOUNTS AND SIMILAR ACCOUNTS AND RELATED HEALTHCARE PLANS AND NETWORKS; ADMINISTERING AND UNDERWRITING HEALTH CARE COVERAGE THROUGH CONTRACTED RELATIONSHIPS WITH SUBSCRIBERS AND PROFESSIONAL CLINICAL, HOSPITAL, NURSING HOME AND OTHER HEALTH CARE PROVIDERS (U.S. CLS. 100, 101 AND 102).

FIRST USE 6-0-2004; IN COMMERCE 6-0-2004.
MICHELLE DUBOIS, EXAMINING ATTORNEY

CLASS 36—(Continued).

SN 78-817,230. AMERICAN WHOLESALE INSURANCE GROUP, INC., CHARLOTTE, NC. FILED 2-17-2006.

THERE'S A BETTER WAY.

THE MARK CONSISTS OF STANDARD CHARACTERS WITHOUT CLAIM TO ANY PARTICULAR FONT, STYLE, SIZE, OR COLOR.

FOR WHOLESALE COMMERCIAL INSURANCE BROKERAGE AND CONSULTATION (U.S. CLS. 100, 101 AND 102).

FIRST USE 2-7-2006; IN COMMERCE 2-7-2006.
SARAH WAYDA, EXAMINING ATTORNEY

SN 78-818,935. GORDON, STEVEN, T., TROY, MI. FILED 2-20-2006.

INSUREALLIANCE

THE MARK CONSISTS OF STANDARD CHARACTERS WITHOUT CLAIM TO ANY PARTICULAR FONT, STYLE, SIZE, OR COLOR.

FOR INSURANCE AGENCIES (U.S. CLS. 100, 101 AND 102).

TIMOTHY FINNEGAN, EXAMINING ATTORNEY

SN 78-821,139. COLLIERS INTERNATIONAL PARTNERSHIP, SAN JOSE, CA. FILED 2-22-2006.

WESTRIDGE PARTNERS

THE MARK CONSISTS OF STANDARD CHARACTERS WITHOUT CLAIM TO ANY PARTICULAR FONT, STYLE, SIZE, OR COLOR.

NO CLAIM IS MADE TO THE EXCLUSIVE RIGHT TO USE "PARTNERS", APART FROM THE MARK AS SHOWN.

FOR REAL ESTATE BROKERAGE AND APPRAISAL SERVICES AND CONSULTING SERVICES IN CONNECTION THEREWITH (U.S. CLS. 100, 101 AND 102).

CHRISTINE COOPER, EXAMINING ATTORNEY

CLASS 36—(Continued).

SN 78-829,705. KINDER MORGAN, HOUSTON, TX. FILED 3-6-2006.



OWNER OF U.S. REG. NO. 2,747,976.
FOR BILL PAYMENT PLAN SERVICES FOR CUSTOMERS REGARDING THEIR UTILITY AND ENERGY BILLS (U.S. CLS. 100, 101 AND 102).
FIRST USE 2-3-2006; IN COMMERCE 2-3-2006.
ALAIN LAPTER, EXAMINING ATTORNEY

SN 78-832,970. TOYOTA JIDOSHA KABUSHIKI KAISHA, TOYOTA-SHI, AICHI-KEN, JAPAN, FILED 3-9-2006.

SCION FINANCIAL SERVICES

THE MARK CONSISTS OF STANDARD CHARACTERS WITHOUT CLAIM TO ANY PARTICULAR FONT, STYLE, SIZE, OR COLOR.

OWNER OF U.S. REG. NO. 2,972,026.
NO CLAIM IS MADE TO THE EXCLUSIVE RIGHT TO USE "FINANCIAL SERVICES", APART FROM THE MARK AS SHOWN.

FOR FINANCING THE PURCHASE AND LEASING OF MOTOR VEHICLES; UNDERWRITING AND ADMINISTERING INSURANCE AGREEMENTS, SERVICE AGREEMENTS, PREPAID MAINTENANCE AGREEMENTS, AND DEBT CANCELLATION AGREEMENTS, ALL RELATED TO MOTOR VEHICLES (U.S. CLS. 100, 101 AND 102).

ERNEST SHOSHO, EXAMINING ATTORNEY

SN 78-841,127. SIERRA HEALTH FOUNDATION, SACRAMENTO, CA. FILED 3-20-2006.

REACH. CONNECTING
COMMUNITIES AND YOUTH FOR
A HEALTHY FUTURE.

THE MARK CONSISTS OF STANDARD CHARACTERS WITHOUT CLAIM TO ANY PARTICULAR FONT, STYLE, SIZE, OR COLOR.

FOR CHARITABLE FUND RAISING FOR AND PROVIDING GRANTS TO ORGANIZATIONS AND COMMUNITIES INVOLVED IN PROMOTING HEALTH AND WELFARE OF LOCAL YOUTH (U.S. CLS. 100, 101 AND 102).

CHRISTOPHER OTT, EXAMINING ATTORNEY

CLASS 36—(Continued).

SN 78-841,765. GROUP INTEGRITY, INC., DANVILLE, CA. FILED 3-20-2006.

Group Integrity

THE MARK CONSISTS OF STANDARD CHARACTERS WITHOUT CLAIM TO ANY PARTICULAR FONT, STYLE, SIZE, OR COLOR.

NO CLAIM IS MADE TO THE EXCLUSIVE RIGHT TO USE "GROUP", APART FROM THE MARK AS SHOWN.

FOR REAL ESTATE LISTING; REAL ESTATE BROKERAGE (U.S. CLS. 100, 101 AND 102).

FIRST USE 12-2-2005; IN COMMERCE 12-2-2005.
LINDA ORNDORFF, EXAMINING ATTORNEY

SN 78-843,058. PITTMAN & ASSOCIATES, INC., MEMPHIS, TN. FILED 3-22-2006.

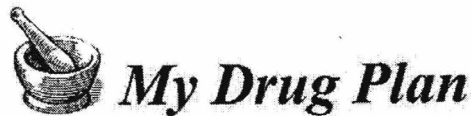

NO CLAIM IS MADE TO THE EXCLUSIVE RIGHT TO USE "DRUG PLAN", APART FROM THE MARK AS SHOWN.

FOR PHARMACEUTICAL BENEFIT MANAGEMENT SERVICES, NAMELY, ADMINISTRATION OF PHARMACY BENEFIT PLANS (U.S. CLS. 100, 101 AND 102).

PAUL F. GAST, EXAMINING ATTORNEY

SN 78-845,179. WINN, DANIEL P., EDMONDS, WA. FILED 3-24-2006.



NO CLAIM IS MADE TO THE EXCLUSIVE RIGHT TO USE "FINANCIAL TRUST", APART FROM THE MARK AS SHOWN.

THE MARK CONSISTS OF AN OPEN BOOK WITH THE WORDS FINANCIAL TRUST IMPRINTED ON IT.

FOR TRUST SERVICES, NAMELY, INVESTMENT AND TRUST COMPANY SERVICES (U.S. CLS. 100, 101 AND 102).

MARK SPARACINO, EXAMINING ATTORNEY

CLASS 36—(Continued).

SN 78-847,105. MINAHAN, CATHERINE MARIE SIOBHAN, BELLEVUE, WA. FILED 3-27-2006.

It's For the Kids!

THE MARK CONSISTS OF STANDARD CHARACTERS WITHOUT CLAIM TO ANY PARTICULAR FONT, STYLE, SIZE, OR COLOR.

FOR CHARITABLE FUND RAISING, NAMELY, NON-PROFIT EVENTS THAT RAISE MONEY FOR CHILDREN'S CHARITIES (U.S. CLS. 100, 101 AND 102).

JENNIFER VASQUEZ, EXAMINING ATTORNEY

SN 78-847,238. THE PACIFIC COASTAL COMPANY LLC, HUNTINGTON BEACH, CA. FILED 3-27-2006.



NO CLAIM IS MADE TO THE EXCLUSIVE RIGHT TO USE "COMPANY", APART FROM THE MARK AS SHOWN. THE MARK CONSISTS OF A SUNRISE DESIGN NEXT TO THE WORDS THE PACIFIC COASTAL COMPANY.

FOR REAL ESTATE SERVICES, NAMELY, REAL ESTATE MANAGEMENT, REAL ESTATE LEASING, AND RENTAL OF HOMES AND APARTMENTS (U.S. CLS. 100, 101 AND 102).

FIRST USE 12-0-2005; IN COMMERCE 12-0-2005.
GINA HAYES, EXAMINING ATTORNEY

SN 78-848,576. CROSSCHECK, INC., ROHNERT PARK, CA. FILED 3-29-2006.

**CHECK CENTER BACK OFFICE
CONVERSION PLUS**

THE MARK CONSISTS OF STANDARD CHARACTERS WITHOUT CLAIM TO ANY PARTICULAR FONT, STYLE, SIZE, OR COLOR.

NO CLAIM IS MADE TO THE EXCLUSIVE RIGHT TO USE "CHECK CENTER BACK OFFICE CONVERSION", APART FROM THE MARK AS SHOWN.

FOR ELECTRONIC CHECK CONVERSION SERVICES AND CHECK VERIFICATION AND GUARANTEE SERVICES (U.S. CLS. 100, 101 AND 102).

JILL PRATER, EXAMINING ATTORNEY

CLASS 36—(Continued).

SN 78-848,581. CROSSCHECK, INC., ROHNERT PARK, CA. FILED 3-29-2006.

**CHECK CENTER BUSINESS
OFFICE CONVERSION PLUS**

THE MARK CONSISTS OF STANDARD CHARACTERS WITHOUT CLAIM TO ANY PARTICULAR FONT, STYLE, SIZE, OR COLOR.

NO CLAIM IS MADE TO THE EXCLUSIVE RIGHT TO USE "CHECK CENTER BUSINESS OFFICE CONVERSION", APART FROM THE MARK AS SHOWN.

FOR ELECTRONIC CHECK CONVERSION SERVICES AND CHECK VERIFICATION AND GUARANTEE SERVICES (U.S. CLS. 100, 101 AND 102).

JILL PRATER, EXAMINING ATTORNEY

SN 78-848,933. GUIDEONE MUTUAL INSURANCE COMPANY, WEST DES MOINES, IA. FILED 3-29-2006.

MINISTRYCHECK

THE MARK CONSISTS OF STANDARD CHARACTERS WITHOUT CLAIM TO ANY PARTICULAR FONT, STYLE, SIZE, OR COLOR.

FOR INSURANCE RISK MANAGEMENT (U.S. CLS. 100, 101 AND 102).

FIRST USE 3-1-2006; IN COMMERCE 3-1-2006.
RONALD AIKENS, EXAMINING ATTORNEY

SN 78-849,508. WILLIAM O'NEIL + COMPANY, INCORPORATED, LOS ANGELES, CA. FILED 3-29-2006.

DAILY GRAPHS ONLINE

THE MARK CONSISTS OF STANDARD CHARACTERS WITHOUT CLAIM TO ANY PARTICULAR FONT, STYLE, SIZE, OR COLOR.

NO CLAIM IS MADE TO THE EXCLUSIVE RIGHT TO USE "ONLINE", APART FROM THE MARK AS SHOWN.

SEC. 2(F) AS TO "DAILY GRAPHS".
FOR FINANCIAL INFORMATION SERVICES (U.S. CLS. 100, 101 AND 102).

FIRST USE 12-31-1996; IN COMMERCE 12-31-1996.
LINDA E. BLOHM, EXAMINING ATTORNEY

CLASS 36—(Continued).

SN 78-850,977. MELIN, ERIC V., CAMBRIDGE, MA. FILED 3-31-2006.

COMPETE TO GIVE

THE MARK CONSISTS OF STANDARD CHARACTERS WITHOUT CLAIM TO ANY PARTICULAR FONT, STYLE, SIZE, OR COLOR.

FOR PROVIDING AN INTERNET-BASED INTERACTIVE DATABASE IN THE FIELD OF PHILANTHROPY, GRANT FUNDING OPPORTUNITIES, AND CHARITABLE SERVICES; PROVIDING ONLINE INFORMATION IN THE FIELD OF PHILANTHROPY; MANAGING, BIDDING, ORGANIZING AND TRACKING CHARITABLE DONATIONS BY MEANS OF AN INTERNET WEBSITE (U.S. CLS. 100, 101 AND 102).

KEVON CHISOLM, EXAMINING ATTORNEY

SN 78-852,383. THE WILLIAM FALL GROUP, INC., TOLEDO, OH. FILED 4-3-2006.

The William Fall Group

THE MARK CONSISTS OF STANDARD CHARACTERS WITHOUT CLAIM TO ANY PARTICULAR FONT, STYLE, SIZE, OR COLOR.

NO CLAIM IS MADE TO THE EXCLUSIVE RIGHT TO USE GROUP, APART FROM THE MARK AS SHOWN.

THE NAME(S), PORTRAIT(S), AND/OR SIGNATURE(S) SHOWN IN THE MARK IDENTIFIES WILLIAM FALL, WHOSE CONSENT(S) TO REGISTER IS SUBMITTED.

FOR REAL ESTATE CONSULTING SERVICES (U.S. CLS. 100, 101 AND 102).

FIRST USE 2-0-1982; IN COMMERCE 2-0-1982.

JEFF DEFORD, EXAMINING ATTORNEY

SN 78-852,393. CORTAZZO, MARK, PARSIPPANY, NJ. FILED 4-3-2006.

Flow Adjusted Portfolio Optimization

THE MARK CONSISTS OF STANDARD CHARACTERS WITHOUT CLAIM TO ANY PARTICULAR FONT, STYLE, SIZE, OR COLOR.

NO CLAIM IS MADE TO THE EXCLUSIVE RIGHT TO USE FLOW ADJUSTED PORTFOLIO, APART FROM THE MARK AS SHOWN.

FOR FINANCIAL PLANNING (U.S. CLS. 100, 101 AND 102).

JEFF DEFORD, EXAMINING ATTORNEY

CLASS 36—(Continued).

SN 78-852,961. MONEYTREE, INC., SEATTLE, WA. FILED 4-3-2006.



OWNER OF U.S. REG. NOS. 2,166,890, 2,976,195 AND OTHERS.

FOR FINANCIAL SERVICES, NAMELY, CHECK CASHING SERVICES, SHORT TERM SMALL LOAN FINANCING SERVICES, MONEY WIRE TRANSFER SERVICES, MONEY ORDER SERVICES, ATM SERVICES, AND DEBIT AND STORED VALUE CARD SERVICES (U.S. CLS. 100, 101 AND 102).

FIRST USE 11-15-2002; IN COMMERCE 12-20-2005.

LINDA MICKLEBURGH, EXAMINING ATTORNEY

SN 78-853,123. CITIZENS TRUST MORTGAGE CORPORATION, MAITLAND, FL. FILED 4-4-2006.

EAAS

THE MARK CONSISTS OF STANDARD CHARACTERS WITHOUT CLAIM TO ANY PARTICULAR FONT, STYLE, SIZE, OR COLOR.

FOR FINANCIAL SERVICES, NAMELY CONSULTING SERVICES IN THE FIELD OF FINANCES, MORTGAGE BANKING, REAL ESTATE INVESTMENT, MORTGAGE PLANNING AND FINANCIAL PLANNING; AND MORTGAGE BANKING SERVICES (U.S. CLS. 100, 101 AND 102).

ANNE MADDEN, EXAMINING ATTORNEY

SN 78-853,184. CITIZENS TRUST MORTGAGE CORPORATION, MAITLAND, FL. FILED 4-4-2006.

THE EQUITY ADVANTAGE ADVISORY SYSTEM

THE MARK CONSISTS OF STANDARD CHARACTERS WITHOUT CLAIM TO ANY PARTICULAR FONT, STYLE, SIZE, OR COLOR.

NO CLAIM IS MADE TO THE EXCLUSIVE RIGHT TO USE "THE EQUITY" AND "ADVISORY SYSTEM", APART FROM THE MARK AS SHOWN.

FOR FINANCIAL SERVICES, NAMELY CONSULTING SERVICES IN THE FIELD OF FINANCES, MORTGAGE BANKING, REAL ESTATE INVESTMENT, MORTGAGE PLANNING AND FINANCIAL PLANNING; AND MORTGAGE BANKING SERVICES (U.S. CLS. 100, 101 AND 102).

ANNE MADDEN, EXAMINING ATTORNEY

CLASS 36—(Continued).

SN 78-853,393. INCOMEPTIONS ADVISORS, GURNEE, IL.
FILED 4-4-2006.

INCOMEPTIONS ADVISORS

THE MARK CONSISTS OF STANDARD CHARACTERS WITHOUT CLAIM TO ANY PARTICULAR FONT, STYLE, SIZE, OR COLOR.

NO CLAIM IS MADE TO THE EXCLUSIVE RIGHT TO USE "ADVISORS", APART FROM THE MARK AS SHOWN. FOR FINANCIAL SERVICES, NAMELY, RESEARCH, ANALYSIS, INVESTMENT ADVICE, TAX PREPARATION AND FINANCIAL PLANNING SERVICES (U.S. CLS. 100, 101 AND 102).

BENJAMIN OKEKE, EXAMINING ATTORNEY

SN 78-854,455. COASTAL CLAIMS SERVICES, INC., PEMBROKE, GA. FILED 4-5-2006.



NO CLAIM IS MADE TO THE EXCLUSIVE RIGHT TO USE "CLAIMS SERVICES, INC.", APART FROM THE MARK AS SHOWN.

THE COLOR(S) NAVY BLUE, LIGHT BLUE, BLACK, AND GRAY IS/ARE CLAIMED AS A FEATURE OF THE MARK. THE MARK CONSISTS OF 3 NAVY BLUE CIRCLES INTERSECTING WITH BLACK STYLIZED "CCS" POSITIONED IN CENTER. LIGHT BLUE SHADOW IS BEHIND THE NAVY BLUE CIRCLES. DARK BLUE STYLIZED "COASTAL CLAIMS SERVICES, INC." WITH A GRAY SHADOW UNDERLINED WITH A BLACK LINE.

FOR APPRAISALS FOR INSURANCE CLAIMS OF PERSONAL PROPERTY; APPRAISALS FOR INSURANCE CLAIMS OF REAL ESTATE; CLAIMS ADJUSTMENT IN THE FIELD OF INSURANCE; ELECTRONIC PROCESSING OF INSURANCE CLAIMS AND PAYMENT DATA; INSURANCE CLAIMS ADMINISTRATION; INSURANCE CLAIMS PROCESSING (U.S. CLS. 100, 101 AND 102).

FIRST USE 4-30-2005; IN COMMERCE 5-15-2005.
PAM WILLIS, EXAMINING ATTORNEY

CLASS 36—(Continued).

SN 78-855,215. C & G SAVINGS BANK, ALTOONA, PA.
FILED 4-6-2006.



FOR BANKING; ON-LINE BANKING SERVICES (U.S. CLS. 100, 101 AND 102).
DAVID MILLER, EXAMINING ATTORNEY

SN 78-855,230. C & G SAVINGS BANK, ALTOONA, PA.
FILED 4-6-2006.



NO CLAIM IS MADE TO THE EXCLUSIVE RIGHT TO USE "FREE CHECKING", APART FROM THE MARK AS SHOWN.

FOR BANKING; CHECKING ACCOUNT SERVICES (U.S. CLS. 100, 101 AND 102).
DAVID MILLER, EXAMINING ATTORNEY

SN 78-855,498. PALMIERI, THOMAS, M., HIGLEY, AZ.
FILED 4-6-2006.

LEGACY NOW

THE MARK CONSISTS OF STANDARD CHARACTERS WITHOUT CLAIM TO ANY PARTICULAR FONT, STYLE, SIZE, OR COLOR.

NO CLAIM IS MADE TO THE EXCLUSIVE RIGHT TO USE LEGACY, APART FROM THE MARK AS SHOWN.

FOR CHARITABLE ANNUITY FUNDRAISING SERVICES (U.S. CLS. 100, 101 AND 102).

TARAH HARDY, EXAMINING ATTORNEY

CLASS 36—(Continued).

SN 78-855,894. CHOICEPOINT ASSET COMPANY, ALPHARETTA, GA. FILED 4-6-2006.

RESIDENT DATA

THE MARK CONSISTS OF STANDARD CHARACTERS WITHOUT CLAIM TO ANY PARTICULAR FONT, STYLE, SIZE, OR COLOR.

OWNER OF U.S. REG. NO. 2,308,060.
SEC. 2(F).

FOR RESIDENTIAL APARTMENT HOUSING INFORMATION MANAGEMENT, NAMELY, RESIDENT SCREENING THROUGH CREDIT BUREAU INQUIRY AND EVALUATION (U.S. CLS. 100, 101 AND 102).

FIRST USE 9-0-1998; IN COMMERCE 9-0-1998.
WILLIAM BRECKENFELD, EXAMINING ATTORNEY

SN 78-855,980. "REMEMBER ME" ROSE GARDEN, PORTLAND, OR. FILED 4-6-2006.

"Remember Me" Rose Garden

THE MARK CONSISTS OF STANDARD CHARACTERS WITHOUT CLAIM TO ANY PARTICULAR FONT, STYLE, SIZE, OR COLOR.

NO CLAIM IS MADE TO THE EXCLUSIVE RIGHT TO USE "ROSE GARDEN", APART FROM THE MARK AS SHOWN.

FOR CHARITABLE FUND RAISING (U.S. CLS. 100, 101 AND 102).

FIRST USE 1-24-2002; IN COMMERCE 1-24-2002.
LA TONIA FISHER, EXAMINING ATTORNEY

SN 78-856,170. ASSIST-2-SELL, INC., RENO, NV. FILED 4-6-2006.



OWNER OF U.S. REG. NOS. 1,743,808 AND 1,744,999.
NO CLAIM IS MADE TO THE EXCLUSIVE RIGHT TO USE ".COM", APART FROM THE MARK AS SHOWN.

THE MARK CONSISTS OF THE WORDS ASSIST2SELL.COM WITH A DESIGN OF A HOUSE OVERLAPPING THE NUMBER 2 AND THE TERM .COM ENCASED VERTICALLY IN THE LAST LETTER L.

FOR REAL ESTATE BROKERAGE; REAL ESTATE CONSULTATION (U.S. CLS. 100, 101 AND 102).

FIRST USE 4-1-2006; IN COMMERCE 4-1-2006.
DAHLIA GEORGE, EXAMINING ATTORNEY

CLASS 36—(Continued).

SN 78-856,568. LEGEND GROUP HOLDINGS, LLC, PALM BEACH GARDENS, FL. FILED 4-7-2006.



THE MARK CONSISTS OF A SILHOUETTE OF A HUMAN HEAD WITHIN A STYLIZED "N". THE WORD NEURAL APPEARS VERTICALLY INSIDE THE STYLIZED "N" AND THE WORD VISION APPEARS HORIZONTALLY UNDER THE DESIGN PORTION OF THE MARK.

FOR INVESTMENT ADVISORY SERVICES (U.S. CLS. 100, 101 AND 102).

FIRST USE 2-26-2006; IN COMMERCE 2-28-2006.
LINDA LAVACHE, EXAMINING ATTORNEY

SN 78-856,726. JUAREZ, JORGE MIRANDA, CHICAGO, IL. FILED 4-7-2006.



OWNER OF U.S. REG. NO. 3,008,639.

FOR MONEY TRANSFER SERVICES; NAMELY, ELECTRONIC FUND TRANSFERS BETWEEN THE USA AND LATIN AMERICA AND EUROPE (U.S. CLS. 100, 101 AND 102).

FIRST USE 1-0-1999; IN COMMERCE 1-0-1999.
ELIZABETH HUGHITT, EXAMINING ATTORNEY

SN 78-856,828. OHMSTAR HOME LENDING LLC, TAMPA, FL. FILED 4-7-2006.



THE MARK CONSISTS OF STANDARD CHARACTERS WITHOUT CLAIM TO ANY PARTICULAR FONT, STYLE, SIZE, OR COLOR.

FOR MORTGAGE LENDING SERVICES (U.S. CLS. 100, 101 AND 102).

FIRST USE 6-0-2004; IN COMMERCE 6-0-2004.
MELISSA VALLILLO, EXAMINING ATTORNEY

CLASS 36—(Continued).

SN 78-857,023. NORTH CASCADES NATIONAL BANK, CHELAN, WA. FILED 4-7-2006.



THE MARK CONSISTS OF STYLIZED N FOLLOWED BY NCNB.
FOR BANKING (U.S. CLS. 100, 101 AND 102).
FIRST USE 5-8-2006; IN COMMERCE 5-8-2006.
KAREN BRACEY, EXAMINING ATTORNEY

SN 78-857,087. ATHERTON TRUST, FOSTER CITY, CA. FILED 4-7-2006.



NO CLAIM IS MADE TO THE EXCLUSIVE RIGHT TO USE "TRUST", APART FROM THE MARK AS SHOWN.
FOR REAL ESTATE WEALTH MANAGEMENT (U.S. CLS. 100, 101 AND 102).
FIRST USE 12-30-2005; IN COMMERCE 12-30-2005.
KEVON CHISOLM, EXAMINING ATTORNEY

SN 78-857,750. AMERICADE LLC, HENDERSON, NV. FILED 4-10-2006.

DITMO

THE MARK CONSISTS OF STANDARD CHARACTERS WITHOUT CLAIM TO ANY PARTICULAR FONT, STYLE, SIZE, OR COLOR.
FOR FINANCIAL SERVICES, NAMELY, FINANCIAL ADVISORY AND INVESTMENT MANAGEMENT SERVICES IN THE FIELDS OF ALTERNATIVE ASSETS, HEDGE FUNDS, FUND OF FUNDS AND INDEX-LINKED INVESTMENT PRODUCTS (U.S. CLS. 100, 101 AND 102).
NANCY CLARKE, EXAMINING ATTORNEY

CLASS 36—(Continued).

SN 78-857,815. EPISCOPAL RELIEF AND DEVELOPMENT CORPORATION, NEW YORK, NY. FILED 4-10-2006.

NETS FOR LIFE

THE MARK CONSISTS OF STANDARD CHARACTERS WITHOUT CLAIM TO ANY PARTICULAR FONT, STYLE, SIZE, OR COLOR.
FOR CHARITABLE FUND RAISING SERVICES, NAMELY, RAISING FUNDS FOR USE IN CONNECTION WITH ADVICE, EDUCATION AND PRODUCTS FOR THE PREVENTION OF MALARIA (U.S. CLS. 100, 101 AND 102).
BERYL GARDNER, EXAMINING ATTORNEY

SN 78-858,126. NEXTRADE HOLDINGS, INC., CLEARWATER, FL. FILED 4-10-2006.



THE MARK CONSISTS OF STYLIZED CAPITAL AE FOLLOWED BY A SUPERSCRIPT 2.
FOR FUTURES EXCHANGE SERVICES (U.S. CLS. 100, 101 AND 102).
TARAH HARDY, EXAMINING ATTORNEY

SN 78-858,149. NEXTRADE HOLDINGS, INC., CLEARWATER, FL. FILED 4-10-2006.

AE²

FOR FUTURES EXCHANGE SERVICES (U.S. CLS. 100, 101 AND 102).
TARAH HARDY, EXAMINING ATTORNEY

CLASS 36—(Continued).

SN 78-858,186. ANDY ROSS GROUP LLC, MADISON, CT. FILED 4-10-2006.

Andy Ross
GROUP

PROFESSIONAL MORTGAGE PLANNERS

NO CLAIM IS MADE TO THE EXCLUSIVE RIGHT TO USE GROUP OR PROFESSIONAL MORTGAGE PLANNERS, APART FROM THE MARK AS SHOWN.

THE NAME ANDY ROSS IDENTIFIES A LIVING INDIVIDUAL WHOSE CONSENT IS OF RECORD.

FOR FINANCIAL SERVICES, NAMELY, PROFESSIONAL MORTGAGE PLANNING (U.S. CLS. 100, 101 AND 102).

FIRST USE 5-1-2002; IN COMMERCE 5-1-2002.
 JAMES GRIFFIN, EXAMINING ATTORNEY

SN 78-858,442. SILK ABSTRACT COMPANY, PLYMOUTH MEETING, PA. FILED 4-11-2006.

SILK

THE MARK CONSISTS OF STANDARD CHARACTERS WITHOUT CLAIM TO ANY PARTICULAR FONT, STYLE, SIZE, OR COLOR.

FOR TITLE INSURANCE SERVICES; REAL ESTATE BROKERAGE SERVICES (U.S. CLS. 100, 101 AND 102).

FIRST USE 8-27-1998; IN COMMERCE 8-27-1998.
 DANNEAN HETZEL, EXAMINING ATTORNEY

CLASS 36—(Continued).

SN 78-858,697. WEALTH SYSTEMS INTERNATIONAL, LTD., HAMILTON HM 12, BERMUDA, FILED 4-11-2006.

DELGREENE FINANCIAL

THE MARK CONSISTS OF STANDARD CHARACTERS WITHOUT CLAIM TO ANY PARTICULAR FONT, STYLE, SIZE, OR COLOR.

NO CLAIM IS MADE TO THE EXCLUSIVE RIGHT TO USE "FINANCIAL", APART FROM THE MARK AS SHOWN.

FOR MORTGAGE BANKING SERVICES, NAMELY, ORIGINATION, SERVING AND BROKERAGE OF MORTGAGE LOANS; TRUST SERVICES, NAMELY, INVESTMENT AND TRUST ADMINISTRATION SERVICES; ESCROW SERVICES AND ADMINISTRATION; INVESTMENT ADVISORY, MANAGEMENT, BROKERAGE, CONSULTATION AND ADMINISTRATIVE SERVICES; FINANCIAL AND TAX PLANNING, MANAGEMENT AND CONSULTATION SERVICES; INSURANCE COMPANY SERVICES, NAMELY, PRODUCT, BROKERAGE AND ADMINISTRATION; LOAN FINANCING, BROKERAGE AND SERVICING; REAL ESTATE DEVELOPMENT, INVESTMENT, BROKERAGE, CONSULTING AND NEGOTIATION SERVICES; ESTATE AND RETIREMENT PLANNING; ELEEMOSYNARY SERVICES IN THE FIELD OF MONETARY DONATIONS; BROKERAGE IN THE FIELD OF ANNUITIES, BONDS, CERTIFICATES OF DEPOSIT, MUTUAL FUNDS, PURCHASE ORDERS, STRUCTURED SETTLEMENTS AND OTHER FINANCIAL INSTRUMENTS; FINANCIAL SERVICES, NAMELY, INVESTMENT FUND TRANSFER AND TRANSACTION SERVICES (U.S. CLS. 100, 101 AND 102).

FIRST USE 5-31-2001; IN COMMERCE 5-31-2001.
 ALLISON HOLTZ, EXAMINING ATTORNEY

SN 78-858,938. COMMERCE EQUITIES INC, HOUSTON, TX. FILED 4-11-2006.

DESIGN TO LEASE

THE MARK CONSISTS OF STANDARD CHARACTERS WITHOUT CLAIM TO ANY PARTICULAR FONT, STYLE, SIZE, OR COLOR.

NO CLAIM IS MADE TO THE EXCLUSIVE RIGHT TO USE "LEASE", APART FROM THE MARK AS SHOWN.

FOR LEASING OF APARTMENTS (U.S. CLS. 100, 101 AND 102).

FIRST USE 11-1-2004; IN COMMERCE 11-1-2004.
 SANDRA MANIOS, EXAMINING ATTORNEY

CLASS 36—(Continued).

SN 78-859,239. VENTIS CONSULTING, LLC, CHAPPAQUA, NY. FILED 4-11-2006.

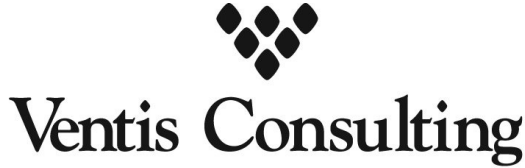

NO CLAIM IS MADE TO THE EXCLUSIVE RIGHT TO USE "CONSULTING", APART FROM THE MARK AS SHOWN.

FOR INSURANCE CONSULTATION; LIFE INSURANCE BROKERAGE (U.S. CLS. 100, 101 AND 102). FIRST USE 4-1-2005; IN COMMERCE 4-1-2005. TINA BROWN, EXAMINING ATTORNEY

CLASS 36—(Continued).

SN 78-859,619. LENDINGTOOLS.COM,INC., WICHITA, KS. FILED 4-12-2006.

ON-WE Network

THE MARK CONSISTS OF STANDARD CHARACTERS WITHOUT CLAIM TO ANY PARTICULAR FONT, STYLE, SIZE, OR COLOR.

NO CLAIM IS MADE TO THE EXCLUSIVE RIGHT TO USE NETWORK, APART FROM THE MARK AS SHOWN.

FOR ELECTRONIC CLEARING AND SETTLEMENT SERVICE BETWEEN PARTICIPANT FINANCIAL INSTITUTIONS (U.S. CLS. 100, 101 AND 102).

FIRST USE 3-1-2003; IN COMMERCE 5-16-2005. LEIGH CAROLINE CASE, EXAMINING ATTORNEY

SN 78-859,601. LENDINGTOOLS.COM, INC., WICHITA, KS. FILED 4-12-2006.



FOR ELECTRONIC CLEARING AND SETTLEMENT SERVICE BETWEEN PARTICIPANT FINANCIAL INSTITUTIONS (U.S. CLS. 100, 101 AND 102).

FIRST USE 4-3-2006; IN COMMERCE 4-3-2006. LEIGH CAROLINE CASE, EXAMINING ATTORNEY

SN 78-859,909. THE SETTINGS DEVELOPMENT COMPANIES, LLC, ATLANTA, GA. FILED 4-12-2006.



FOR REAL ESTATE ACQUISITION SERVICES; REAL ESTATE BROKERAGE; REAL ESTATE MANAGEMENT (U.S. CLS. 100, 101 AND 102).

FIRST USE 7-15-2005; IN COMMERCE 7-15-2005. NICHOLAS ALTREE, EXAMINING ATTORNEY

SN 78-859,614. LENDINGTOOLS.COM, INC., WICHITA, KS. FILED 4-12-2006.

ONWE

THE MARK CONSISTS OF STANDARD CHARACTERS WITHOUT CLAIM TO ANY PARTICULAR FONT, STYLE, SIZE, OR COLOR.

FOR ELECTRONIC CLEARING AND SETTLEMENT SERVICE BETWEEN PARTICIPANT FINANCIAL INSTITUTIONS (U.S. CLS. 100, 101 AND 102).

FIRST USE 3-1-2003; IN COMMERCE 10-18-2005. LEIGH CAROLINE CASE, EXAMINING ATTORNEY

SN 78-860,205. GAIL JOHNSON, P.C., PHOENIX, AZ. FILED 4-12-2006.

THE SKY'S THE LIMIT

THE MARK CONSISTS OF STANDARD CHARACTERS WITHOUT CLAIM TO ANY PARTICULAR FONT, STYLE, SIZE, OR COLOR.

FOR REAL ESTATE BROKERAGE AND LISTING SERVICES (U.S. CLS. 100, 101 AND 102).

FIRST USE 1-31-2006; IN COMMERCE 1-31-2006. MELISSA VALLILLO, EXAMINING ATTORNEY

CLASS 36—(Continued).

SN 78-861,038. THE NATIONAL BANK OF INDIANAPOLIS CORPORATION, INDIANAPOLIS, IN. FILED 4-13-2006.

BANK HOME AGAIN

THE MARK CONSISTS OF STANDARD CHARACTERS WITHOUT CLAIM TO ANY PARTICULAR FONT, STYLE, SIZE, OR COLOR.

FOR BANKING SERVICES (U.S. CLS. 100, 101 AND 102).

FIRST USE 5-1-2000; IN COMMERCE 5-1-2000.
CAROL SPILS, EXAMINING ATTORNEY

CLASS 36—(Continued).

SN 78-861,739. JUST ABOUT KIDS FOUNDATION, WICHITA, KS. FILED 4-14-2006.

JUST ABOUT KIDS

THE MARK CONSISTS OF STANDARD CHARACTERS WITHOUT CLAIM TO ANY PARTICULAR FONT, STYLE, SIZE, OR COLOR.

FOR CHARITABLE FUNDRAISING SERVICES (U.S. CLS. 100, 101 AND 102).

FIRST USE 7-1-2004; IN COMMERCE 7-0-2005.
JUDITH HELFMAN, EXAMINING ATTORNEY

SN 78-861,247. DEER VALLEY FUNDING LIMITED, ST. HELIER, JERSEY, FILED 4-13-2006.

DEER VALLEY FUNDING

THE MARK CONSISTS OF STANDARD CHARACTERS WITHOUT CLAIM TO ANY PARTICULAR FONT, STYLE, SIZE, OR COLOR.

NO CLAIM IS MADE TO THE EXCLUSIVE RIGHT TO USE "FUNDING", APART FROM THE MARK AS SHOWN.

FOR FINANCIAL SERVICES, NAMELY, STRUCTURING AND ISSUING COMMERCIAL PAPER AND OTHER DEBT INSTRUMENTS BY MEANS OF PRIVATE PLACEMENT OFFERINGS TO INSTITUTIONAL INVESTORS (U.S. CLS. 100, 101 AND 102).

FIRST USE 12-1-2005; IN COMMERCE 12-1-2005.
RON FAIRBANKS, EXAMINING ATTORNEY

SN 78-862,038. SOUK LLC, PORTLAND, OR. FILED 4-14-2006.

SOUK

THE MARK CONSISTS OF STANDARD CHARACTERS WITHOUT CLAIM TO ANY PARTICULAR FONT, STYLE, SIZE, OR COLOR.

FOR LEASING OF OFFICE SPACE; LEASING OF FLEXIBLE OFFICE SPACE (U.S. CLS. 100, 101 AND 102).

MICHAEL KAZAZIAN, EXAMINING ATTORNEY

SN 78-861,722. JUST ABOUT KIDS FOUNDATION, WICHITA, KS. FILED 4-14-2006.

JAK

THE MARK CONSISTS OF STANDARD CHARACTERS WITHOUT CLAIM TO ANY PARTICULAR FONT, STYLE, SIZE, OR COLOR.

FOR CHARITABLE FUNDRAISING SERVICES (U.S. CLS. 100, 101 AND 102).

FIRST USE 1-2-2005; IN COMMERCE 7-0-2005.
JUDITH HELFMAN, EXAMINING ATTORNEY

SN 78-862,310. AFRO INTERNATIONAL LIMITED INC, WASHINGTON, DC. FILED 4-15-2006.

**RIKBAN
WORLDWIDE EXPRESS MONEY
TRANSFERS**

THE MARK CONSISTS OF STANDARD CHARACTERS WITHOUT CLAIM TO ANY PARTICULAR FONT, STYLE, SIZE, OR COLOR.

NO CLAIM IS MADE TO THE EXCLUSIVE RIGHT TO USE "WORLDWIDE EXPRESS MONEY TRANSFERS", APART FROM THE MARK AS SHOWN.

FOR MONEY TRANSFER (U.S. CLS. 100, 101 AND 102).

KATINA MISTER, EXAMINING ATTORNEY

CLASS 36—(Continued).

SN 78-862,312. MONARCH GROUP, LLC, DANA POINT, CA. FILED 4-15-2006.

thespillzone.com

THE MARK CONSISTS OF STANDARD CHARACTERS WITHOUT CLAIM TO ANY PARTICULAR FONT, STYLE, SIZE, OR COLOR.

FOR FINANCIAL INVESTMENT IN THE FIELD OF REAL ESTATE; FINANCIAL VALUATION OF PERSONAL PROPERTY AND REAL ESTATE; OPERATING MARKETPLACES FOR SELLERS OF GOODS AND/OR SERVICES; PROVIDING INFORMATION IN THE FIELD OF REAL ESTATE BY MEANS OF LINKING THE WEB SITE TO OTHER WEB SITES FEATURING REAL ESTATE INFORMATION; REAL ESTATE INVESTMENT; REAL ESTATE VALUATION SERVICES; REAL ESTATE VALUATIONS (U.S. CLS. 100, 101 AND 102).

KATINA MISTER, EXAMINING ATTORNEY

CLASS 36—(Continued).

SN 78-862,512. AFFALON CORPORATION, DBA THE PINNACLE CORPORATION, ARLINGTON, TX. FILED 4-17-2006.

LoyalPay

THE MARK CONSISTS OF STANDARD CHARACTERS WITHOUT CLAIM TO ANY PARTICULAR FONT, STYLE, SIZE, OR COLOR.

FOR BILL PAYMENT SERVICES; ELECTRONIC COMMERCE PAYMENT SERVICES, NAMELY, ESTABLISHING FUNDED ACCOUNTS USED TO PURCHASE GOODS AND SERVICES ON THE INTERNET; PRE-PAID PURCHASE CARD SERVICES NAMELY, PROCESSING ELECTRONIC PAYMENTS MADE THROUGH PREPAID CARDS; PRE-PAID PURCHASE CARD SERVICES, NAMELY PROCESSING ELECTRONIC PAYMENTS THROUGH PRE-PAID CARDS; PROVIDING ELECTRONIC PROCESSING OF CREDIT CARD TRANSACTIONS AND ELECTRONIC PAYMENTS VIA A GLOBAL COMPUTER NETWORK; PROVIDING MULTIPLE PAYMENT OPTIONS BY MEANS OF CUSTOMER-OPERATED ELECTRONIC TERMINALS AVAILABLE ON-SITE IN RETAIL STORES (U.S. CLS. 100, 101 AND 102).

AMY BROZENIC, EXAMINING ATTORNEY

SN 78-862,355. AFRO INTERNATIONAL LIMITED INC, WASHINGTON, DC. FILED 4-16-2006.

AFRO INTERNATIONAL
WORLDWIDE EXPRESS MONEY
TRANSFERS

THE MARK CONSISTS OF STANDARD CHARACTERS WITHOUT CLAIM TO ANY PARTICULAR FONT, STYLE, SIZE, OR COLOR.

NO CLAIM IS MADE TO THE EXCLUSIVE RIGHT TO USE "INTERNATIONAL WORLDWIDE EXPRESS MONEY TRANSFERS", APART FROM THE MARK AS SHOWN.

FOR ACQUISITION AND TRANSFER OF MONETARY CLAIMS; ELECTRONIC FUNDS TRANSFER; ELECTRONIC FUNDS TRANSFER BY TELECOMMUNICATIONS; ELECTRONIC TRANSFER OF MONEY; ELECTRONIC TRANSFERS OF MONEY; FINANCIAL SERVICES IN THE FIELD OF MONEY LENDING; FINANCIAL SERVICES, NAMELY MONEY LENDING; FINANCIAL SERVICES, NAMELY, INVESTMENT FUND TRANSFER AND TRANSACTION SERVICES; MANAGEMENT OF PORTFOLIOS OF TRANSFERABLE SECURITIES; MONEY ORDER PAYMENT GUARANTEE SERVICES; MONEY ORDER SERVICES; MONEY TRANSFER (U.S. CLS. 100, 101 AND 102).

KATINA MISTER, EXAMINING ATTORNEY

SN 78-862,701. SOUTHPAW ASSET MANAGEMENT LP, GREENWICH, CT. FILED 4-17-2006.



FOR FINANCIAL SERVICES, NAMELY, INVESTMENT ADVISORY SERVICES AND MANAGEMENT OF INVESTMENT FUNDS (U.S. CLS. 100, 101 AND 102).

FIRST USE 8-0-2005; IN COMMERCE 8-0-2005.
IRA J. GOODSID, EXAMINING ATTORNEY

SN 78-862,802. MACLAWRAN GROUP INC., THE, BEACONSFIELD, CANADA, FILED 4-17-2006.

HANDICASH

THE MARK CONSISTS OF STANDARD CHARACTERS WITHOUT CLAIM TO ANY PARTICULAR FONT, STYLE, SIZE, OR COLOR.

FOR FINANCIAL SERVICES, NAMELY MONEY LENDING (U.S. CLS. 100, 101 AND 102).

MICHAEL WEBSTER, EXAMINING ATTORNEY

CLASS 36—(Continued).

SN 78-863,137. BROOKE CORPORATION, OVERLAND PARK, KS. FILED 4-17-2006.

BROOKE SAVINGS BANK

THE MARK CONSISTS OF STANDARD CHARACTERS WITHOUT CLAIM TO ANY PARTICULAR FONT, STYLE, SIZE, OR COLOR.

OWNER OF U.S. REG. NOS. 1,588,160, 2,981,536 AND OTHERS.

NO CLAIM IS MADE TO THE EXCLUSIVE RIGHT TO USE "SAVINGS BANK", APART FROM THE MARK AS SHOWN.

FOR BANKING SERVICES; AND FINANCIAL TRUST OPERATIONS (U.S. CLS. 100, 101 AND 102).

ELLEN B. AWRICH, EXAMINING ATTORNEY

SN 78-863,802. GROWMARK, INC., BLOOMINGTON, IL. FILED 4-18-2006.



OWNER OF U.S. REG. NO. 2,826,608.
NO CLAIM IS MADE TO THE EXCLUSIVE RIGHT TO USE "NETWORK", APART FROM THE MARK AS SHOWN.
FOR CREDIT CARD, DEBIT CARD, STORED VALUE CARD, AND GIFT CARD SERVICES (U.S. CLS. 100, 101 AND 102).

FIRST USE 11-30-2005; IN COMMERCE 11-30-2005.
CATHERINE FAINT, EXAMINING ATTORNEY

SN 78-864,152. SALMA BASRAVI, INC., GLENDALE, CA. FILED 4-18-2006.



THE NAME SALMA BASRAVI IDENTIFIES A LIVING INDIVIDUAL WHOSE CONSENT IS OF RECORD.
FOR REAL ESTATE CONSULTANT (U.S. CLS. 100, 101 AND 102).

FIRST USE 7-10-2005; IN COMMERCE 8-1-2005.
MARGERY A. TIERNEY, EXAMINING ATTORNEY

CLASS 36—(Continued).

SN 78-864,294. PEOPLES WORLD CORP., WYNNWOOD, PA. FILED 4-18-2006.

PEOPLES WORLD

THE MARK CONSISTS OF STANDARD CHARACTERS WITHOUT CLAIM TO ANY PARTICULAR FONT, STYLE, SIZE, OR COLOR.

FOR FINANCIAL CONSULTATION (U.S. CLS. 100, 101 AND 102).

DARRYL SPRUILL, EXAMINING ATTORNEY

SN 78-864,404. STEELPOINT CAPITAL PARTNERS, LP, NEW YORK, NY. FILED 4-19-2006.

STEELPOINT

THE MARK CONSISTS OF STANDARD CHARACTERS WITHOUT CLAIM TO ANY PARTICULAR FONT, STYLE, SIZE, OR COLOR.

FOR FINANCIAL SERVICES, NAMELY, VENTURE CAPITAL AND PRIVATE EQUITY MANAGEMENT AND INVESTMENT SERVICES; FINANCIAL ANALYSIS AND CONSULTATION SERVICES IN THE FIELDS OF VENTURE CAPITAL AND PRIVATE EQUITY MANAGEMENT AND INVESTMENT (U.S. CLS. 100, 101 AND 102).

CAROLINE WOOD, EXAMINING ATTORNEY

SN 78-864,409. STEELPOINT CAPITAL PARTNERS, LP, NEW YORK, NY. FILED 4-19-2006.

STEELPOINT CAPITAL PARTNERS

THE MARK CONSISTS OF STANDARD CHARACTERS WITHOUT CLAIM TO ANY PARTICULAR FONT, STYLE, SIZE, OR COLOR.

NO CLAIM IS MADE TO THE EXCLUSIVE RIGHT TO USE "CAPITAL PARTNERS", APART FROM THE MARK AS SHOWN.

FOR FINANCIAL SERVICES, NAMELY, VENTURE CAPITAL AND PRIVATE EQUITY MANAGEMENT AND INVESTMENT SERVICES; FINANCIAL ANALYSIS AND CONSULTATION SERVICES IN THE FIELDS OF VENTURE CAPITAL AND PRIVATE EQUITY MANAGEMENT AND INVESTMENT (U.S. CLS. 100, 101 AND 102).

CAROLINE WOOD, EXAMINING ATTORNEY

CLASS 36—(Continued).

SN 78-864,469. COMMUNITY BANKS, INC., HARRISBURG, PA. FILED 4-19-2006.

MEGABUCK\$

THE MARK CONSISTS OF STANDARD CHARACTERS WITHOUT CLAIM TO ANY PARTICULAR FONT, STYLE, SIZE, OR COLOR.

FOR BANKING SERVICES, NAMELY, CHILDREN'S BANKING SERVICES (U.S. CLS. 100, 101 AND 102).

FIRST USE 8-28-1995; IN COMMERCE 8-28-1995.
ANDREA SAUNDERS, EXAMINING ATTORNEY

SN 78-864,539. CERBERUS CAPITAL MANAGEMENT, L.P., NEW YORK, NY. FILED 4-19-2006.

CERBERUS CAPITAL MANAGEMENT, L.P.

THE MARK CONSISTS OF STANDARD CHARACTERS WITHOUT CLAIM TO ANY PARTICULAR FONT, STYLE, SIZE, OR COLOR.

NO CLAIM IS MADE TO THE EXCLUSIVE RIGHT TO USE "CAPITAL MANAGEMENT, L.P.", APART FROM THE MARK AS SHOWN.

FOR FINANCIAL SERVICES, NAMELY, PRIVATE EQUITY INVESTMENT SERVICES, PURCHASE OF SECURITIES AND OTHER FINANCIAL INSTRUMENTS, FINANCIAL SERVICES RELATED TO CORPORATE ACQUISITIONS, EXPANSIONS, RESTRUCTURINGS AND BUYOUTS, INVESTMENT MANAGEMENT SERVICES, INVESTMENT ADVISORY SERVICES, ASSET MANAGEMENT SERVICES AND LOAN ORIGATION SERVICES (U.S. CLS. 100, 101 AND 102).

FIRST USE 4-0-1993; IN COMMERCE 4-0-1993.
MARIAM MAHMOUDI, EXAMINING ATTORNEY

SN 78-864,543. CERBERUS CAPITAL MANAGEMENT, L.P., NEW YORK, NY. FILED 4-19-2006.

CERBERUS

THE MARK CONSISTS OF STANDARD CHARACTERS WITHOUT CLAIM TO ANY PARTICULAR FONT, STYLE, SIZE, OR COLOR.

FOR FINANCIAL SERVICES, NAMELY, PRIVATE EQUITY INVESTMENT SERVICES, PURCHASE OF SECURITIES AND OTHER FINANCIAL INSTRUMENTS, FINANCIAL SERVICES RELATED TO CORPORATE ACQUISITIONS, EXPANSIONS, RESTRUCTURINGS AND BUYOUTS, INVESTMENT MANAGEMENT SERVICES, INVESTMENT ADVISORY SERVICES, ASSET MANAGEMENT SERVICES AND LOAN ORIGATION SERVICES (U.S. CLS. 100, 101 AND 102).

FIRST USE 12-0-1992; IN COMMERCE 12-0-1992.
MARIAM MAHMOUDI, EXAMINING ATTORNEY

CLASS 36—(Continued).

SN 78-864,608. TAILWIND CAPITAL GROUP LLC, NEW YORK, NY. FILED 4-19-2006.



FOR FINANCIAL SERVICES IN THE NATURE OF PRIVATE EQUITY INVESTMENT (U.S. CLS. 100, 101 AND 102).

FIRST USE 11-18-2005; IN COMMERCE 11-18-2005.
HOWARD SMIGA, EXAMINING ATTORNEY

SN 78-864,716. GATEWAY COMMUNITY FINANCIAL, MHC, SEWELL, NJ. FILED 4-19-2006.

GCF

THE MARK CONSISTS OF STANDARD CHARACTERS WITHOUT CLAIM TO ANY PARTICULAR FONT, STYLE, SIZE, OR COLOR.

FOR BANKING; MORTGAGE BANKING; ON-LINE BANKING SERVICES (U.S. CLS. 100, 101 AND 102).

FIRST USE 2-0-1963; IN COMMERCE 2-0-1963.
ALICE BENMAMAN, EXAMINING ATTORNEY

SN 78-864,802. MIDWEST EMPLOYEE MEDICAL BENEFIT ASSOCIATION, GRAND RAPIDS, MI. FILED 4-19-2006.



NO CLAIM IS MADE TO THE EXCLUSIVE RIGHT TO USE "OHIO HEALTH CARE TRUST", APART FROM THE MARK AS SHOWN.

THE APPLICANT CLAIMS COLOR AS A FEATURE OF THE MARK, NAMELY, RED AND BLACK.

THE MARK CONSISTS OF THE STYLIZED LETTER "O" IN RED AND "OHIO HEALTH CARE TRUST" IN BLACK.

FOR ADMINISTRATION OF EMPLOYEE BENEFIT PLANS (U.S. CLS. 100, 101 AND 102).

FIRST USE 5-0-2005; IN COMMERCE 5-0-2005.
TRACY CROSS, EXAMINING ATTORNEY

CLASS 36—(Continued).

SN 78-864,910. MRU HOLDINGS, INC., NEW YORK, NY. FILED 4-19-2006.

IT MATTERS NOW

THE MARK CONSISTS OF STANDARD CHARACTERS WITHOUT CLAIM TO ANY PARTICULAR FONT, STYLE, SIZE, OR COLOR.

FOR FINANCIAL SERVICES, NAMELY, PROVIDING LOAN FINANCING TO STUDENTS, GUARANTEEING LOAN FINANCING TO STUDENTS AND PROVIDING FINANCIAL AID TO STUDENTS IN EXCHANGE FOR A FIXED PERCENTAGE OF THE STUDENTS' INCOME FOR A SPECIFIED PERIOD (U.S. CLS. 100, 101 AND 102).
FIRST USE 4-10-2006; IN COMMERCE 4-10-2006.
CIMMERIAN COLEMAN, EXAMINING ATTORNEY

SN 78-865,633. TOWNSEND ANALYTICS, LTD., CHICAGO, IL. FILED 4-20-2006.

REAL CROSS

THE MARK CONSISTS OF STANDARD CHARACTERS WITHOUT CLAIM TO ANY PARTICULAR FONT, STYLE, SIZE, OR COLOR.

FOR AUTOMATED TRADING SERVICES FOR INVESTMENT SECURITIES (U.S. CLS. 100, 101 AND 102).
MARIA-VICTORIA SUAREZ, EXAMINING ATTORNEY

SN 78-866,124. COMMONWEALTH INSURANCE GROUP, LLC, CHARLESTON, SC. FILED 4-20-2006.



NO CLAIM IS MADE TO THE EXCLUSIVE RIGHT TO USE "INSURANCE GROUP; PROPERTY & CASUALTY; EMPLOYEE BENEFITS; FINANCIAL SERVICES", APART FROM THE MARK AS SHOWN.

FOR INSURANCE BROKERAGE AND FINANCIAL SERVICES IN THE FIELD OF PROPERTY AND CASUALTY, EMPLOYEE BENEFITS, AND LIFE INSURANCE (U.S. CLS. 100, 101 AND 102).
FIRST USE 2-1-2005; IN COMMERCE 2-1-2005.
CAROLYN GRAY, EXAMINING ATTORNEY

CLASS 36—(Continued).

SN 78-866,139. PERVO ENERGY LLC, SCOTTSDALE, AZ. FILED 4-20-2006.

Pervo Energy

THE MARK CONSISTS OF STANDARD CHARACTERS WITHOUT CLAIM TO ANY PARTICULAR FONT, STYLE, SIZE, OR COLOR.

NO CLAIM IS MADE TO THE EXCLUSIVE RIGHT TO USE "ENERGY", APART FROM THE MARK AS SHOWN.
FOR BROKERAGE OF ENERGY, NAMELY, GAS AND ELECTRICITY; CONSULTANCY CONCERNING FINANCING OF ENERGY PROJECTS; ENERGY BROKERAGE SERVICES (U.S. CLS. 100, 101 AND 102).
TONJA GASKINS, EXAMINING ATTORNEY

SN 78-866,302. ROCKVILLE ROADIES MULTIPLE SCLEROSIS PROJECT INC, GAITHERSBURG, MD. FILED 4-20-2006.

IMMOBILE ► I'M MOBILE

THE MARK CONSISTS OF STYLIZED WORDS AND AN ARROW.

FOR CHARITABLE FUND RAISING (U.S. CLS. 100, 101 AND 102).
FIRST USE 4-9-2006; IN COMMERCE 4-9-2006.
KYLE PEETE, EXAMINING ATTORNEY

SN 78-866,303. MID-STATE INSURANCE AGENCY INC., LYNCHBURG, VA. FILED 4-20-2006.

"First in Quality Protection"

THE MARK CONSISTS OF STANDARD CHARACTERS WITHOUT CLAIM TO ANY PARTICULAR FONT, STYLE, SIZE, OR COLOR.

FOR INSURANCE AGENCIES IN THE FIELD OF PROPERTY, CASUALTY, LIFE AND HEALTH (U.S. CLS. 100, 101 AND 102).
FIRST USE 12-1-1980; IN COMMERCE 12-1-1980.
KYLE PEETE, EXAMINING ATTORNEY

CLASS 36—(Continued).

SN 78-866,739. PACIFIC LIFE INSURANCE COMPANY,
NEWPORT BEACH, CA. FILED 4-21-2006.

DESTINATION INDEPENDENCE

THE MARK CONSISTS OF STANDARD CHARACTERS
WITHOUT CLAIM TO ANY PARTICULAR FONT, STYLE,
SIZE, OR COLOR.

FOR FINANCIAL SERVICES, NAMELY, UNDER-
WRITING AND ADMINISTRATION OF MUTUAL
FUNDS AND ANNUITIES (U.S. CLS. 100, 101 AND 102).
FIRST USE 2-1-2006; IN COMMERCE 2-1-2006.
DANIEL RUSSELL, EXAMINING ATTORNEY

SN 78-866,798. BANISTER FINANCIAL, INC., CHARLOTTE,
NC. FILED 4-21-2006.

BANISTER FINANCIAL

THE MARK CONSISTS OF STANDARD CHARACTERS
WITHOUT CLAIM TO ANY PARTICULAR FONT, STYLE,
SIZE, OR COLOR.

NO CLAIM IS MADE TO THE EXCLUSIVE RIGHT TO
USE FINANCIAL, APART FROM THE MARK AS SHOWN.

FOR FISCAL ASSESSMENT AND EVALUATION,
NAMELY CONDUCTING APPRAISALS AND ADVISING
CLIENTS AS TO FAIR MARKET VALUE OF BUSI-
NESSES (U.S. CLS. 100, 101 AND 102).

FIRST USE 7-0-1989; IN COMMERCE 7-0-1989.
CAROL SPILS, EXAMINING ATTORNEY

SN 78-867,189. PATHWAY CAPITAL MANAGEMENT, LLC,
IRVINE, CA. FILED 4-21-2006.

PATHWAY

THE MARK CONSISTS OF STANDARD CHARACTERS
WITHOUT CLAIM TO ANY PARTICULAR FONT, STYLE,
SIZE, OR COLOR.

FOR INVESTMENT SERVICES, NAMELY INVEST-
MENT ADVISORY SERVICES, INVESTMENT MANAGE-
MENT, INVESTMENT ADVICE, INVESTMENT
CONSULTATION, INVESTMENT OF FUNDS FOR
OTHERS, ALTERNATIVE INVESTMENTS FOR OTHERS
(U.S. CLS. 100, 101 AND 102).

FIRST USE 12-31-1991; IN COMMERCE 12-31-1991.
CHERYL CLAYTON, EXAMINING ATTORNEY

CLASS 36—(Continued).

SN 78-867,250. PAUL LAW REALTY, INC. GRASS VALLEY,
CA. FILED 4-21-2006.

Trust Takes Time

THE MARK CONSISTS OF STANDARD CHARACTERS
WITHOUT CLAIM TO ANY PARTICULAR FONT, STYLE,
SIZE, OR COLOR.

FOR REAL ESTATE BROKERAGE (U.S. CLS. 100, 101
AND 102).

FIRST USE 11-1-2004; IN COMMERCE 1-1-2005.
ANGELA M. MICHELI, EXAMINING ATTORNEY

SN 78-868,365. MOTHERS AGAINST DRUNK DRIVING,
IRVING, TX. FILED 4-24-2006.

SHIFTING GEARS

THE MARK CONSISTS OF STANDARD CHARACTERS
WITHOUT CLAIM TO ANY PARTICULAR FONT, STYLE,
SIZE, OR COLOR.

FOR CHARITABLE FUND RAISING SERVICES,
NAMELY, CONDUCTING AND PROMOTING ROAD
RALLIES AND AUTO SHOWS TO RAISE MONEY FOR
ACTIVITIES DESIGNED TO PROMOTE THE INTEREST
OF PERSONS OPPOSED TO DRUNK DRIVING AND TO
SUPPORT VICTIMS OF DRUNK DRIVING (U.S. CLS.
100, 101 AND 102).

FIRST USE 2-1-2006; IN COMMERCE 2-1-2006.
WENDY GOODMAN, EXAMINING ATTORNEY

SN 78-868,531. OSMOND FOUNDATION, FOR THE CHIL-
DREN OF THE WORLD, DBA CHILDREN'S MIRACLE
NETWORK, SALT LAKE CITY, UT. FILED 4-24-2006.

ALL-STAR MIRACLE HOME

THE MARK CONSISTS OF STANDARD CHARACTERS
WITHOUT CLAIM TO ANY PARTICULAR FONT, STYLE,
SIZE, OR COLOR.

OWNER OF U.S. REG. NO. 1,851,682.

NO CLAIM IS MADE TO THE EXCLUSIVE RIGHT TO
USE HOME, APART FROM THE MARK AS SHOWN.

FOR CHARITABLE FUND RAISING AND ELEEMO-
SYNARY SERVICES IN THE FIELD OF MONETARY
DONATIONS (U.S. CLS. 100, 101 AND 102).

FIRST USE 10-20-2005; IN COMMERCE 10-20-2005.
JOHN HWANG, EXAMINING ATTORNEY

CLASS 36—(Continued).

SN 78-868,539. OSMOND FOUNDATION, FOR THE CHILDREN OF THE WORLD, DBA CHILDREN'S MIRACLE NETWORK, SALT LAKE CITY, UT. FILED 4-24-2006.



OWNER OF U.S. REG. NO. 1,851,682.
 NO CLAIM IS MADE TO THE EXCLUSIVE RIGHT TO USE HOME, APART FROM THE MARK AS SHOWN.
 FOR CHARITABLE FUND RAISING AND ELEEMOSYNARY SERVICES IN THE FIELD OF MONETARY DONATIONS (U.S. CLS. 100, 101 AND 102).
 FIRST USE 10-20-2005; IN COMMERCE 10-20-2005.
 JOHN HWANG, EXAMINING ATTORNEY

SN 78-868,558. OSMOND FOUNDATION, FOR THE CHILDREN OF THE WORLD, DBA CHILDREN'S MIRACLE NETWORK, SALT LAKE CITY, UT. FILED 4-24-2006.



OWNER OF U.S. REG. NO. 1,851,682.
 FOR CHARITABLE FUND RAISING AND ELEEMOSYNARY SERVICES IN THE FIELD OF MONETARY DONATIONS (U.S. CLS. 100, 101 AND 102).
 FIRST USE 5-1-1993; IN COMMERCE 5-1-1993.
 JOHN HWANG, EXAMINING ATTORNEY

SN 78-868,806. NUTRITIONALLY YOURS LLC, DETROIT, MI. FILED 4-25-2006.

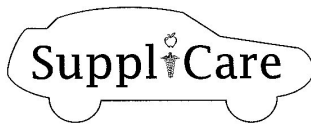

FOR INSURANCE UNDERWRITING IN THE FIELD OF HEALTH; UNDERWRITING INSURANCE FOR PREPAID HEALTH CARE (U.S. CLS. 100, 101 AND 102).
 ELIZABETH PIGNATELLO, EXAMINING ATTORNEY

CLASS 36—(Continued).

SN 78-869,022. COAST2COAST INVESTMENTS, LLC, WINDERMERE, FL. FILED 4-25-2006.



NO CLAIM IS MADE TO THE EXCLUSIVE RIGHT TO USE INVESTMENTS, APART FROM THE MARK AS SHOWN.
 THE APPLICANT CLAIMS COLOR AS A FEATURE OF THE MARK, NAMELY, BLUE, WHITE, BLACK AND GRAY.

THE MARK CONSISTS THE REPEATED TERM COAST IN THE COLOR BLACK. THE NUMERAL 2 IS SHADED IN THE COLORS GRAY, BLACK AND BLUE. THE TERM INVESTMENTS IS WHITE OUTLINED IN BLACK. TWO ARROWS FORMING A CIRCULAR DESIGN IN SHADES OF GRAY AND BLACK.

FOR LAND ACQUISITION, NAMELY, REAL ESTATE BROKERAGE; REAL ESTATE ACQUISITION SERVICES; REAL ESTATE AGENCIES; REAL ESTATE BROKERAGE; REAL ESTATE CONSULTANCY; REAL ESTATE CONSULTATION; REAL ESTATE INVESTMENT; REAL ESTATE LISTING; REAL ESTATE MANAGEMENT; REAL ESTATE MANAGEMENT CONSULTATION; REAL ESTATE MULTIPLE LISTING SERVICES; REAL ESTATE VALUATIONS (U.S. CLS. 100, 101 AND 102).
 FIRST USE 6-1-2004; IN COMMERCE 6-1-2004.
 LINDA E. BLOHM, EXAMINING ATTORNEY

SN 78-869,074. BILLY BUCK BUYS HOUSES, LLC, NORTH MIAMI BEACH, FL. FILED 4-25-2006.

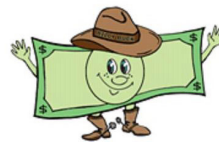

THE COLOR(S) BLACK, WHITE, BROWN AND GREEN ARE CLAIMED AS A FEATURE OF THE MARK.

THE COLOR(S) GREEN AND BLACK APPEAR IN THE DESIGN OF AN ANIMATED PIECE OF PAPER MONEY WITH A FACE, ARMS AND LEGS. THE MONEY IS SHOWN IN LIGHT AND DARK GREEN WITH A BLACK BORDER AND BLACK "S" SIGNS IN EACH CORNER. THE ANIMATED FACE OF THE MONEY IS OUTLINED IN BLACK WITH BLACK FEATURES AND GREEN, BLACK AND WHITE EYES. THE MONEY IS "WEARING" A BROWN HAT WITH A BLACK BAND AND BROWN BOOTS.

FOR REAL ESTATE ACQUISITION SERVICES, NAMELY, THE PURCHASES OF HOUSES FOR RESALE (U.S. CLS. 100, 101 AND 102).
 FIRST USE 9-1-2005; IN COMMERCE 9-1-2005.
 KATRINA EDGE, EXAMINING ATTORNEY

CLASS 36—(Continued).

SN 78-869,091. BILLY BUCK BUYS HOUSES, LLC, NORTH MIAMI BEACH, FL. FILED 4-25-2006.

BILLY BUCK BUYS HOUSES

THE MARK CONSISTS OF STANDARD CHARACTERS WITHOUT CLAIM TO ANY PARTICULAR FONT, STYLE, SIZE, OR COLOR.

NO CLAIM IS MADE TO THE EXCLUSIVE RIGHT TO USE "BUYS HOUSES", APART FROM THE MARK AS SHOWN.

THE NAME "BILLY BUCK" DOES NOT IDENTIFY A LIVING INDIVIDUAL.

FOR REAL ESTATE ACQUISITION SERVICES, NAMELY, THE PURCHASE OF HOUSES FOR RESALE (U.S. CLS. 100, 101 AND 102).

FIRST USE 9-1-2005; IN COMMERCE 9-1-2005.
KATRINA EDGE, EXAMINING ATTORNEY

CLASS 36—(Continued).

SN 78-870,421. DEEPWATER BAIL BONDS, INC., DOWNEY, CA. FILED 4-26-2006.

Don't Go To Bed With A Price On Your Head

THE MARK CONSISTS OF STANDARD CHARACTERS WITHOUT CLAIM TO ANY PARTICULAR FONT, STYLE, SIZE, OR COLOR.

FOR BAIL BONDING (U.S. CLS. 100, 101 AND 102).

FIRST USE 6-1-1976; IN COMMERCE 6-1-1976.

KATHERINE STOIDES, EXAMINING ATTORNEY

SN 78-870,466. INNOVAPORT LLC, WHITEFISH BAY, WI. FILED 4-26-2006.

Innovaloan

THE MARK CONSISTS OF STANDARD CHARACTERS WITHOUT CLAIM TO ANY PARTICULAR FONT, STYLE, SIZE, OR COLOR.

FOR CONSUMER LENDING SERVICES; INVESTMENT SERVICES, NAMELY ASSET ACQUISITION, CONSULTATION, DEVELOPMENT AND MANAGEMENT SERVICES (U.S. CLS. 100, 101 AND 102).

NAKIA HENRY, EXAMINING ATTORNEY

SN 78-869,501. DEEPWATER BAIL BONDS, INC., DOWNEY, CA. FILED 4-25-2006.

DeepWater Bail Bonds

THE MARK CONSISTS OF STANDARD CHARACTERS WITHOUT CLAIM TO ANY PARTICULAR FONT, STYLE, SIZE, OR COLOR.

NO CLAIM IS MADE TO THE EXCLUSIVE RIGHT TO USE "BAIL BONDS", APART FROM THE MARK AS SHOWN.

FOR BAIL BONDING (U.S. CLS. 100, 101 AND 102).
FIRST USE 6-1-1976; IN COMMERCE 6-1-1976.
KATHERINE STOIDES, EXAMINING ATTORNEY

SN 78-870,601. DEEPWATER BAIL BONDS, INC., DOWNEY, CA. FILED 4-26-2006.

SN 78-870,368. DEEPWATER BAIL BONDS, INC., DOWNEY, CA. FILED 4-26-2006.

WHEN YOU'RE IN DEEP WATER CALL... "MOSES"

THE MARK CONSISTS OF STANDARD CHARACTERS WITHOUT CLAIM TO ANY PARTICULAR FONT, STYLE, SIZE, OR COLOR.

FOR BAIL BONDING (U.S. CLS. 100, 101 AND 102).
FIRST USE 6-1-1976; IN COMMERCE 6-1-1976.
KATHERINE STOIDES, EXAMINING ATTORNEY

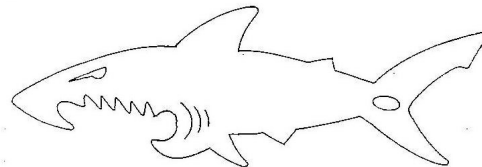

THE MARK CONSISTS OF A SHARK.
FOR BAIL BONDING (U.S. CLS. 100, 101 AND 102).
FIRST USE 6-1-1976; IN COMMERCE 6-1-1976.
KATHERINE STOIDES, EXAMINING ATTORNEY

CLASS 36—(Continued).

SN 78-870,650. OWNIT MORTGAGE SOLUTIONS, INC., AGOURA HILLS, CA. FILED 4-26-2006.

RIGHTDEAL

THE MARK CONSISTS OF STANDARD CHARACTERS WITHOUT CLAIM TO ANY PARTICULAR FONT, STYLE, SIZE, OR COLOR.

FOR MORTGAGE BANKING SERVICES, MORTGAGE LENDING SERVICES, HOME EQUITY LENDING SERVICES, AND HOME EQUITY LOANS (U.S. CLS. 100, 101 AND 102).

DAVID C. REIHNER, EXAMINING ATTORNEY

SN 78-871,016. CLEARLIGHT PARTNERS MANAGEMENT, LLC, NEWPORT BEACH, CA. FILED 4-27-2006.

CLEARLIGHT
PARTNERS LLC 

OWNER OF U.S. REG. NO. 2,645,017.
NO CLAIM IS MADE TO THE EXCLUSIVE RIGHT TO USE "PARTNERS LLC", APART FROM THE MARK AS SHOWN.

FOR FINANCIAL SERVICES, NAMELY, PROVIDING PRIVATE EQUITY FUNDING (U.S. CLS. 100, 101 AND 102).

FIRST USE 9-1-2005; IN COMMERCE 9-1-2005.
ALEXANDER L. POWERS, EXAMINING ATTORNEY

SN 78-871,185. K-GROUP HOLDINGS INC., MIAMI, FL. FILED 4-27-2006.

METROPICA REALTY

THE MARK CONSISTS OF STANDARD CHARACTERS WITHOUT CLAIM TO ANY PARTICULAR FONT, STYLE, SIZE, OR COLOR.

OWNER OF U.S. REG. NO. 3,103,444.
NO CLAIM IS MADE TO THE EXCLUSIVE RIGHT TO USE "REALTY", APART FROM THE MARK AS SHOWN.

FOR REAL ESTATE BROKERAGE (U.S. CLS. 100, 101 AND 102).

VIVIAN MICZNIK FIRST, EXAMINING ATTORNEY

CLASS 36—(Continued).

SN 78-871,359. ISE STOCK EXCHANGE, LLC, NEW YORK, NY. FILED 4-27-2006.

ISE STOCK EXCHANGE

THE MARK CONSISTS OF STANDARD CHARACTERS WITHOUT CLAIM TO ANY PARTICULAR FONT, STYLE, SIZE, OR COLOR.

OWNER OF U.S. REG. NOS. 2,635,776, 2,643,218 AND 2,686,458.

NO CLAIM IS MADE TO THE EXCLUSIVE RIGHT TO USE "STOCK EXCHANGE", APART FROM THE MARK AS SHOWN.

FOR CONDUCTING A SECURITIES EXCHANGE (U.S. CLS. 100, 101 AND 102).

FIRST USE 4-19-2006; IN COMMERCE 4-19-2006.
DEBRA LEE, EXAMINING ATTORNEY

SN 78-873,435. PEACHTREE LBP FINANCE CO., LLC, NORCROSS, GA. FILED 5-1-2006.

ENJOY THE SECURITY OF KNOWING.

THE MARK CONSISTS OF STANDARD CHARACTERS WITHOUT CLAIM TO ANY PARTICULAR FONT, STYLE, SIZE, OR COLOR.

FOR FINANCIAL AND INVESTMENT SERVICES, NAMELY, PROVIDING PREMIUM FINANCING FOR AN EXECUTIVE BENEFITS PROGRAM FUNDED WITH LIFE INSURANCE (U.S. CLS. 100, 101 AND 102).

FIRST USE 11-1-2005; IN COMMERCE 11-1-2005.
ALEXANDER L. POWERS, EXAMINING ATTORNEY

SN 78-873,592. PLS FINANCIAL SERVICES, INC., CHICAGO, IL. FILED 5-1-2006.

BECAUSE YOU DESERVE BETTER

THE MARK CONSISTS OF STANDARD CHARACTERS WITHOUT CLAIM TO ANY PARTICULAR FONT, STYLE, SIZE, OR COLOR.

FOR FINANCIAL SERVICES, NAMELY, SHORT TERM LOAN SERVICES IN THE NATURE OF PAYDAY LOAN ADVANCES AND CHECK CASHING SERVICES (U.S. CLS. 100, 101 AND 102).

FIRST USE 7-6-2005; IN COMMERCE 7-6-2005.
DARRYL SPRUILL, EXAMINING ATTORNEY

CLASS 36—(Continued).

SN 78-873,917. CYCLE GEAR, INC., BENICIA, CA. FILED 5-1-2006.

MOTOCREDIT

THE MARK CONSISTS OF STANDARD CHARACTERS WITHOUT CLAIM TO ANY PARTICULAR FONT, STYLE, SIZE, OR COLOR.

FOR CREDIT CARD SERVICES (U.S. CLS. 100, 101 AND 102).

FIRST USE 11-15-2003; IN COMMERCE 11-15-2003.
MATTHEW MCDOWELL, EXAMINING ATTORNEY

SN 78-873,982. ATRIUM UNDERWRITERS LTD, LONDON, UNITED KINGDOM, FILED 5-2-2006.

AUGOLD

THE MARK CONSISTS OF STANDARD CHARACTERS WITHOUT CLAIM TO ANY PARTICULAR FONT, STYLE, SIZE, OR COLOR.

FOR INSURANCE AND REINSURANCE UNDERWRITING SERVICES IN THE FIELDS OF PROPERTY, CASUALTY, LIQUOR LIABILITY, ACCIDENT AND HEALTH AND GENERAL INSURANCE (U.S. CLS. 100, 101 AND 102).

FIRST USE 2-4-2005; IN COMMERCE 2-4-2005.
JOHN HWANG, EXAMINING ATTORNEY

SN 78-874,172. INDEPENDENT BROKERS REALTY, LLC, CHANHASSEN, MN. FILED 5-2-2006.

Does your broker make you
broke?

THE MARK CONSISTS OF STANDARD CHARACTERS WITHOUT CLAIM TO ANY PARTICULAR FONT, STYLE, SIZE, OR COLOR.

FOR REAL ESTATE BROKERAGE SERVICES (U.S. CLS. 100, 101 AND 102).

FIRST USE 1-1-2002; IN COMMERCE 1-1-2002.
CATHERINE FAINT, EXAMINING ATTORNEY

CLASS 36—(Continued).

SN 78-874,263. ATRIUM UNDERWRITERS LTD, LONDON, UNITED KINGDOM, FILED 5-2-2006.

THE COLOR(S) PURPLE AND GOLD IS/ARE CLAIMED AS A FEATURE OF THE MARK.

THE MARK CONSISTS OF THE LETTERS "AU" IN PURPLE, WITH THE CROSSBAR OMITTED FROM THE LETTER A, AND THE WORD "GOLD" IN GOLD.

FOR INSURANCE AND REINSURANCE UNDERWRITING SERVICES IN THE FIELDS OF PROPERTY, CASUALTY, LIQUOR LIABILITY, ACCIDENT AND HEALTH AND GENERAL INSURANCE (U.S. CLS. 100, 101 AND 102).

FIRST USE 2-4-2005; IN COMMERCE 2-4-2005.
JOHN HWANG, EXAMINING ATTORNEY

SN 78-884,687. GUIDEONE MUTUAL INSURANCE COMPANY, WEST DES MOINES, IA. FILED 5-16-2006.

SAFEGUARDING THE FAITHFUL

THE MARK CONSISTS OF STANDARD CHARACTERS WITHOUT CLAIM TO ANY PARTICULAR FONT, STYLE, SIZE, OR COLOR.

OWNER OF U.S. REG. NOS. 2,339,189, 2,391,984 AND 2,551,105.

FOR EDUCATIONAL SERVICES, NAMELY, CONDUCTING SEMINARS AND WORKSHOPS IN THE FIELD OF INSURANCE RISK MANAGEMENT (U.S. CLS. 100, 101 AND 102).

FIRST USE 2-0-2006; IN COMMERCE 2-0-2006.
RONALD AIKENS, EXAMINING ATTORNEY

SN 78-888,766. CALYON FINANCIAL, INC., CHICAGO, IL. FILED 5-22-2006.

TICKETWIZARD

THE MARK CONSISTS OF STANDARD CHARACTERS WITHOUT CLAIM TO ANY PARTICULAR FONT, STYLE, SIZE, OR COLOR.

FOR FINANCIAL AND INVESTMENT SERVICES, NAMELY, FUTURES BROKERAGE SERVICES; FOREIGN EXCHANGE TRANSACTIONS AND BROKERAGE SERVICES IN THE FIELDS OF PRECIOUS METALS, ENERGY, FIXED INCOME, DERIVATIVES, EQUITIES AND SECURITIES; ON-LINE BROKERAGE SERVICES IN THE FIELDS OF FUTURES, EQUITIES, SECURITIES, FOREIGN EXCHANGE, ENERGY AND PRECIOUS METALS; AND INVESTMENT RESEARCH AND INFORMATION SERVICES (U.S. CLS. 100, 101 AND 102).

COLLEEN KEARNEY, EXAMINING ATTORNEY

CLASS 36—(Continued).

SN 78-888,782. CALYON FINANCIAL, INC., CHICAGO, IL. FILED 5-22-2006.

TOTAL TICKETWIZARD

THE MARK CONSISTS OF STANDARD CHARACTERS WITHOUT CLAIM TO ANY PARTICULAR FONT, STYLE, SIZE, OR COLOR.

FOR FINANCIAL AND INVESTMENT SERVICES, NAMELY, FUTURES BROKERAGE SERVICES; FOREIGN EXCHANGE TRANSACTIONS AND BROKERAGE SERVICES IN THE FIELDS OF PRECIOUS METALS, ENERGY, FIXED INCOME, DERIVATIVES, EQUITIES AND SECURITIES; ON-LINE BROKERAGE SERVICES IN THE FIELDS OF FUTURES, EQUITIES, SECURITIES, FOREIGN EXCHANGE, ENERGY AND PRECIOUS METALS; AND INVESTMENT RESEARCH AND INFORMATION SERVICES (U.S. CLS. 100, 101 AND 102).

COLLEEN KEARNEY, EXAMINING ATTORNEY

SN 78-889,251. FLUSHING SAVINGS BANK, LAKE SUCCESS, NY. FILED 5-22-2006.

FLUSHING SAVINGS BANK

THE MARK CONSISTS OF STANDARD CHARACTERS WITHOUT CLAIM TO ANY PARTICULAR FONT, STYLE, SIZE, OR COLOR.

NO CLAIM IS MADE TO THE EXCLUSIVE RIGHT TO USE "SAVINGS BANK", APART FROM THE MARK AS SHOWN.

SEC. 2(F).

FOR FULL SERVICE BANKING SERVICES AND ON-LINE BANKING SERVICES PROVIDED VIA THE INTERNET, NAMELY PROVISION OF SAVINGS ACCOUNTS, CHECKING ACCOUNTS, MONEY MARKET ACCOUNTS AND CERTIFICATES OF DEPOSIT; CONSUMER LENDING SERVICES, NAMELY PROVIDING STUDENT LOANS, MORTGAGE LOANS, INSTALLMENT LOANS, SMALL BUSINESS LOANS, MANUFACTURED HOUSING LOANS, HOME EQUITY LOANS, HOME EQUITY LINES OF CREDIT AND AUTOMOBILE LOANS; FINANCIAL INVESTMENT SERVICES, NAMELY RETIREMENT FINANCIAL PLANNING, MUTUAL FUNDS INVESTMENT, COLLEGE SAVING PLANS, STOCKS BROKERAGE, BROKERAGE OF BONDS AND SECURITIES; AND CREDIT AND DEBIT CARD SERVICES (U.S. CLS. 100, 101 AND 102).

FIRST USE 11-1-1929; IN COMMERCE 6-1-1998.

EDWARD FENNESSY, EXAMINING ATTORNEY

CLASS 36—(Continued).

SN 78-896,382. BUYSIDE, INC., CHICAGO, IL. FILED 5-30-2006.

COUNTDOWN TO CLOSING

THE MARK CONSISTS OF STANDARD CHARACTERS WITHOUT CLAIM TO ANY PARTICULAR FONT, STYLE, SIZE, OR COLOR.

FOR BROKERAGE IN THE FIELD OF ONLINE REAL ESTATE; DISCOUNT BROKERAGE SERVICES; REAL ESTATE BROKERAGE (U.S. CLS. 100, 101 AND 102).

FIRST USE 4-5-2006; IN COMMERCE 4-5-2006.

DAVID MILLER, EXAMINING ATTORNEY

SN 78-900,833. MONACO COACH CORPORATION, COBURG, OR. FILED 6-5-2006.

REACH YOUR DESTINATION

THE MARK CONSISTS OF STANDARD CHARACTERS WITHOUT CLAIM TO ANY PARTICULAR FONT, STYLE, SIZE, OR COLOR.

FOR RETAIL FINANCING PROGRAMS FOR RECREATIONAL VEHICLES (U.S. CLS. 100, 101 AND 102).

DARRYL SPRUILL, EXAMINING ATTORNEY

SN 78-918,247. HOODLOVE LIMITED LIABILITY COMPANY, EAST ORANGE, NJ. FILED 6-27-2006.

HOOD LOVE

THE MARK CONSISTS OF STANDARD CHARACTERS WITHOUT CLAIM TO ANY PARTICULAR FONT, STYLE, SIZE, OR COLOR.

FOR CHARITABLE FUND RAISING (U.S. CLS. 100, 101 AND 102).

BARBARA BROWN, EXAMINING ATTORNEY

CLASS 37—CONSTRUCTION AND REPAIR

SN 76-627,845. THE GUTTER GENIE CO., WEST CHESTER, OH. FILED 1-13-2005.

GUTTER GENIE

THE MARK CONSISTS OF STANDARD CHARACTERS WITHOUT CLAIM TO ANY PARTICULAR FONT, STYLE, SIZE, OR COLOR.

NO CLAIM IS MADE TO THE EXCLUSIVE RIGHT TO USE "GUTTER", APART FROM THE MARK AS SHOWN.

FOR INSTALLATION OF RAIN GUTTER SYSTEMS FOR ALLEVIATING LEAF AND OTHER DEBRIS ACCUMULATION IN GUTTERS (U.S. CLS. 100, 103 AND 106).

FIRST USE 1-27-2004; IN COMMERCE 1-27-2004.
MICHAEL GAAFAR, EXAMINING ATTORNEY

SN 76-655,461. ELITE PROPERTIES OF AMERICA, INC., COLORADO SPRINGS, CO. FILED 2-22-2006.



OWNER OF U.S. REG. NOS. 3,038,231, 3,068,757 AND 3,068,798.

FOR REAL ESTATE DEVELOPMENT SERVICES, NAMELY PLANNING AND LAYING OUT RESIDENTIAL AND COMMERCIAL COMMUNITIES (U.S. CLS. 100, 103 AND 106).

BRENDAN REGAN, EXAMINING ATTORNEY

SN 76-657,251. REMOTEVIDEO, LLC, OLATHE, KS. FILED 3-24-2006.



FOR INSTALLATION AND MAINTENANCE OF VIDEO SURVEILLANCE EQUIPMENT (U.S. CLS. 100, 103 AND 106).

FIRST USE 12-0-2003; IN COMMERCE 12-0-2003.
DAVID TAYLOR, EXAMINING ATTORNEY

CLASS 37—(Continued).

SN 76-658,438. RELUMINATE, INC., ST. PAUL, MN. FILED 4-14-2006.



THE COLOR(S) ORANGE, YELLOW, RED, BLACK AND WHITE IS/ARE CLAIMED AS A FEATURE OF THE MARK.

THE COLORS ORANGE AND YELLOW APPEAR AS A BACKGROUND; THE COLOR RED APPEARS IN THE "HEAD" DEPICTION, AS WELL AS IN THE WORDS "IT'S A BRIGHT IDEA."; THE COLOR BLACK APPEARS IN THE WORD "RELUMINATE", AS WELL AS AN OUTLINE TO THE BASE OF THE "HEAD" DEPICTION; THE COLOR WHITE APPEARS IN THE EXCLAMATION MARK, IN THE WHITE RING SURROUNDING THE "HEAD" DEPICTION, IN THE BASE OF THE "HEAD" DEPICTION, AND IN THE WORD "INC."

FOR INSTALLATION, MAINTENANCE, REPAIR, RETROFITTING, AND REPLACEMENT OF LIGHTING SYSTEMS AND EQUIPMENT (U.S. CLS. 100, 103 AND 106).

FIRST USE 2-1-2006; IN COMMERCE 2-1-2006.
FRED MANDIR, EXAMINING ATTORNEY

SN 76-658,838. ALLEN EDWIN COMPANY, INC., PORTAGE, MI. FILED 4-20-2006.

BIG

THE MARK CONSISTS OF STANDARD CHARACTERS WITHOUT CLAIM TO ANY PARTICULAR FONT, STYLE, SIZE, OR COLOR.

FOR RESIDENTIAL HOME BUILDING SERVICES (U.S. CLS. 100, 103 AND 106).

FIRST USE 12-18-2005; IN COMMERCE 12-18-2005.
HOWARD B. LEVINE, EXAMINING ATTORNEY

SN 77-003,706. AECON HOLDINGS INC., CAMBRIDGE, ONTARIO, CANADA, FILED 9-20-2006.

IST

THE MARK CONSISTS OF STANDARD CHARACTERS WITHOUT CLAIM TO ANY PARTICULAR FONT, STYLE, SIZE, OR COLOR.

OWNER OF U.S. REG. NO. 2,427,853.
FOR MAINTENANCE, INSTALLATION AND REPAIR OF STEAM GENERATORS (U.S. CLS. 100, 103 AND 106).

FIRST USE 3-31-1992; IN COMMERCE 3-31-1992.
TRAVIS WHEATLEY, EXAMINING ATTORNEY

CLASS 37—(Continued).

SN 78-309,514. A.W. HEC, INC., KINGWOOD, TX. FILED 10-5-2003.

BEDROCK

FOR CONSTRUCTION AND REPAIR OF BUILDINGS
(U.S. CLS. 100, 103 AND 106).
NANCY CLARKE, EXAMINING ATTORNEY

SN 78-422,082. BEYNON SPORTS SURFACING, INC., COCKEYSVILLE, MD. FILED 5-20-2004.

Martin Surfacing

THE MARK CONSISTS OF STANDARD CHARACTERS WITHOUT CLAIM TO ANY PARTICULAR FONT, STYLE, SIZE, OR COLOR.

NO CLAIM IS MADE TO THE EXCLUSIVE RIGHT TO USE "SURFACING", APART FROM THE MARK AS SHOWN.

FOR INSTALLATION OF ATHLETIC FLOORING (U.S. CLS. 100, 103 AND 106).

LA TONIA FISHER, EXAMINING ATTORNEY

SN 78-493,037. CANYONS LAND AND CATTLE COMPANY, LLC, TERREBONNE, OR. FILED 10-1-2004.

RANCH AT THE CANYONS

THE MARK CONSISTS OF STANDARD CHARACTERS WITHOUT CLAIM TO ANY PARTICULAR FONT, STYLE, SIZE, OR COLOR.

NO CLAIM IS MADE TO THE EXCLUSIVE RIGHT TO USE "RANCH", APART FROM THE MARK AS SHOWN.

FOR REAL ESTATE DEVELOPMENT (U.S. CLS. 100, 103 AND 106).

FIRST USE 11-3-2004; IN COMMERCE 11-3-2004.

DAWN HAN, EXAMINING ATTORNEY

CLASS 37—(Continued).

SN 78-521,149. INTERNET BILLING SERVICES, INC., REDDING, CA. FILED 11-22-2004.

Nerds On Call

THE MARK CONSISTS OF STANDARD CHARACTERS WITHOUT CLAIM TO ANY PARTICULAR FONT, STYLE, SIZE, OR COLOR.

OWNER OF U.S. REG. NO. 59,583.

NO CLAIM IS MADE TO THE EXCLUSIVE RIGHT TO USE "ON CALL", APART FROM THE MARK AS SHOWN.

FOR INSTALLATION, MAINTENANCE AND REPAIR OF COMPUTERS FOR HOMES AND BUSINESSES (U.S. CLS. 100, 103 AND 106).

FIRST USE 3-0-2004; IN COMMERCE 3-0-2004.

SOPHIA S. KIM, EXAMINING ATTORNEY

SN 78-609,002. WARMAN, WILLIAM E., CHICAGO, IL. FILED 4-14-2005.

PRAIRIE STATION

THE MARK CONSISTS OF STANDARD CHARACTERS WITHOUT CLAIM TO ANY PARTICULAR FONT, STYLE, SIZE, OR COLOR.

FOR REAL ESTATE DEVELOPMENT (U.S. CLS. 100, 103 AND 106).

FIRST USE 3-15-2005; IN COMMERCE 3-15-2005.

EVELYN BRADLEY, EXAMINING ATTORNEY

SN 78-610,137. BLACK DOG CARWASH, LLC, ROCHESTER, NH. FILED 4-15-2005.



NO CLAIM IS MADE TO THE EXCLUSIVE RIGHT TO USE "CAR WASH", APART FROM THE MARK AS SHOWN.

"THE COLOR(S) BLACK, WHITE, ORANGE, GOLD, YELLOW AND RED IS/ARE CLAIMED AS A FEATURE OF THE MARK".

THE COLOR BLACK APPEARS IN THE DOG DESIGN, AS

CLASS 37—(Continued).

AN OUTLINE AROUND THE HALF OVAL BACKGROUND AND THE SOAP BUBBLES, AND IN THE WORDING BLACK DOG CAR WASH; THE COLOR WHITE APPEARS IN THE SOAP BUBBLES AND THE DOG'S EYE; THE COLOR GOLD APPEARS IN THE SOAP BUBBLES; THE COLOR YELLOW APPEARS IN THE HALF OVAL BACKGROUND; THE COLOR ORANGE APPEARS IN THE HALF OVAL BACKGROUND AND AS AN UNDERLINE BELOW THE WORDING IN THE MARK; AND THE COLOR RED APPEARS IN THE DOG'S BANDANA.

FOR CAR WASH SERVICES (U.S. CLS. 100, 103 AND 106).

FIRST USE 8-0-2004; IN COMMERCE 8-27-2004.
TEJBIR SINGH, EXAMINING ATTORNEY

SN 78-630,236. RYTECH FRANCHISING, INC., KENNESAW, GA. FILED 5-16-2005.



OWNER OF U.S. REG. NO. 2,144,886.
FOR CLEANING SERVICES IN THE FIELD OF WATER DAMAGE RESTORATION OF CARPET, NAMELY, WATER REMOVAL, BACTERIA CONTROL, DEHUMIDIFICATION, RESTORATION OF CARPET, AND CARPET CLEANING; INSTALLING CARPET (U.S. CLS. 100, 103 AND 106).

FIRST USE 1-28-2005; IN COMMERCE 1-28-2005.
KRISTIN DAHLING, EXAMINING ATTORNEY

SN 78-652,789. TROESSER, MICHAEL, PEORIA HEIGHTS, IL. FILED 6-17-2005.



NO CLAIM IS MADE TO THE EXCLUSIVE RIGHT TO USE "BATHROOMS", APART FROM THE MARK AS SHOWN.

THE COLORS RED, WHITE AND BLACK ARE CLAIMED AS A FEATURE OF THE MARK.

THE COLOR RED APPEARS IN THE LETTER "P" DESIGN THAT FORMS THE COMBINED LETTERS "BP" DESIGN, THE COLOR WHITE APPEARS IN THE REMAINING LOOP THAT FORMS THE LETTER "B" IN THE COMBINED LETTERS "BP" DESIGN AND THE COLOR BLACK APPEARS IN THE BORDER OUTLINING THE LETTERS "BP" DESIGN AND THE REMAINING TERMS COMPRISING THE MARK.

FOR REMODELING SERVICES FOR BATHROOMS AND RESTROOMS (U.S. CLS. 100, 103 AND 106).

FIRST USE 2-1-2004; IN COMMERCE 2-1-2004.
GENE MACIOL, EXAMINING ATTORNEY

CLASS 37—(Continued).

SN 78-661,411. DUNES COUNTRY PARTNERS, LLC, VAL-PARAISO, IN. FILED 6-30-2005.

DUNES COUNTRY

THE MARK CONSISTS OF STANDARD CHARACTERS WITHOUT CLAIM TO ANY PARTICULAR FONT, STYLE, SIZE, OR COLOR.

FOR REAL ESTATE PROPERTY DEVELOPMENT (U.S. CLS. 100, 103 AND 106).

FIRST USE 10-1-1997; IN COMMERCE 10-1-1997.
RUDY R. SINGLETON, EXAMINING ATTORNEY

SN 78-680,537. RATTLER TOOLS, INC., HARVEY, LA. FILED 7-28-2005.

MAG TRAP

THE MARK CONSISTS OF STANDARD CHARACTERS WITHOUT CLAIM TO ANY PARTICULAR FONT, STYLE, SIZE, OR COLOR.

FOR SERVICES OF LEASING AND RENTAL OF OIL FIELD EQUIPMENT (U.S. CLS. 100, 103 AND 106).

FIRST USE 3-1-2000; IN COMMERCE 3-1-2000.
FRED CARL, EXAMINING ATTORNEY

SN 78-681,692. ONE WEEK BATH, INC., TARZANA, CA. FILED 7-29-2005.

HIGH QUALITY DOESN'T HAVE TO TAKE FOREVER

THE MARK CONSISTS OF STANDARD CHARACTERS WITHOUT CLAIM TO ANY PARTICULAR FONT, STYLE, SIZE, OR COLOR.

FOR PROVIDING INFORMATION SERVICES IN THE FIELD OF RESIDENTIAL AND COMMERCIAL HOME AND BATHROOM REMODELING, CONSTRUCTION, AND RENOVATION; BATHROOM REMODELING, CONSTRUCTION, AND RENOVATION (U.S. CLS. 100, 103 AND 106).

FIRST USE 6-0-2005; IN COMMERCE 6-0-2005.
ELI HELLMAN, EXAMINING ATTORNEY

CLASS 37—(Continued).

SN 78-686,750. CENTEX CORPORATION, DALLAS, TX. FILED 8-5-2005.



FOR CONSTRUCTION SERVICES, NAMELY, PLANING, LAYING OUT AND CUSTOM CONSTRUCTION OF RESIDENTIAL AND COMMERCIAL COMMUNITIES; REAL ESTATE DEVELOPMENT OF RESIDENTIAL, SECOND-HOME AND RESORT COMMUNITIES; CONSTRUCTION OF ATHLETIC FACILITIES OF RESIDENTIAL AND COMMERCIAL COMMUNITIES (U.S. CLS. 100, 103 AND 106).
FIRST USE 1-7-2005; IN COMMERCE 1-7-2005.
DAWN HAN, EXAMINING ATTORNEY

SN 78-702,948. UNITY ELECTRIC CONSTRUCTION, INC., SHASTA LAKE, CA. FILED 8-29-2005.

UEC

THE MARK CONSISTS OF STANDARD CHARACTERS WITHOUT CLAIM TO ANY PARTICULAR FONT, STYLE, SIZE, OR COLOR.
FOR ELECTRICAL CONTRACTOR SERVICES (U.S. CLS. 100, 103 AND 106).
FIRST USE 2-4-1986; IN COMMERCE 2-4-1986.
JOHN SCHUYLER YARD, EXAMINING ATTORNEY

SN 78-703,205. MONTECITO INVESTMENT COMPANY, LLC, JACKSONVILLE, FL. FILED 8-30-2005.

MONTECITO

THE MARK CONSISTS OF STANDARD CHARACTERS WITHOUT CLAIM TO ANY PARTICULAR FONT, STYLE, SIZE, OR COLOR.
FOR REAL ESTATE DEVELOPMENT (U.S. CLS. 100, 103 AND 106).
FIRST USE 4-1-2004; IN COMMERCE 9-1-2004.
SONYA STEPHENS, EXAMINING ATTORNEY

CLASS 37—(Continued).

SN 78-704,884. H.D. FRANCHISING SYSTEMS, LLC, MILFORD, OH. FILED 8-31-2005.

THE BIG NAME IN SMALL JOBS

THE MARK CONSISTS OF STANDARD CHARACTERS WITHOUT CLAIM TO ANY PARTICULAR FONT, STYLE, SIZE, OR COLOR.
FOR HOUSE MAINTENANCE; REMODELING AND REPAIR, NAMELY, CARPENTRY, DRYWALL INSTALLATION AND REPAIR; ELECTRICAL CONTRACTING SERVICES; MASONRY; PAINTING; PLUMBING; ROOFING; AND WALL COVERING INSTALLATION (U.S. CLS. 100, 103 AND 106).
FIRST USE 2-5-1995; IN COMMERCE 2-5-1995.
RON FAIRBANKS, EXAMINING ATTORNEY

SN 78-704,892. H.D. FRANCHISING SYSTEMS, LLC, MILFORD, OH. FILED 8-31-2005.

A GOOD HANDYMAN...TODAY,
EVERYBODY NEEDS ONE.

THE MARK CONSISTS OF STANDARD CHARACTERS WITHOUT CLAIM TO ANY PARTICULAR FONT, STYLE, SIZE, OR COLOR.
FOR HOUSE MAINTENANCE; REMODELING AND REPAIR, NAMELY, CARPENTRY, DRYWALL INSTALLATION AND REPAIR; ELECTRICAL CONTRACTING SERVICES; MASONRY; PAINTING; PLUMBING; ROOFING; AND WALL COVERING INSTALLATION (U.S. CLS. 100, 103 AND 106).
FIRST USE 10-19-2001; IN COMMERCE 10-19-2001.
RON FAIRBANKS, EXAMINING ATTORNEY

SN 78-704,895. H.D. FRANCHISING SYSTEMS, LLC, MILFORD, OH. FILED 8-31-2005.

A HANDYMAN. EVERY HOME
NEEDS ONE.

THE MARK CONSISTS OF STANDARD CHARACTERS WITHOUT CLAIM TO ANY PARTICULAR FONT, STYLE, SIZE, OR COLOR.
FOR HOUSE MAINTENANCE; REMODELING AND REPAIR, NAMELY, CARPENTRY, DRYWALL INSTALLATION AND REPAIR; ELECTRICAL CONTRACTING SERVICES; MASONRY; PAINTING; PLUMBING; ROOFING; AND WALL COVERING INSTALLATION (U.S. CLS. 100, 103 AND 106).
FIRST USE 2-5-1995; IN COMMERCE 2-5-1995.
RON FAIRBANKS, EXAMINING ATTORNEY

CLASS 37—(Continued).

SN 78-711,143. MC3 CONSULTANTS, INCORPORATED, CARLSBAD, CA. FILED 9-12-2005.

CLASS 37—(Continued).

SN 78-717,700. AMERICA IN-HOME, MILWAUKEE, WI. FILED 9-21-2005.

mc³



FOR POST CONSTRUCTION FORENSIC ANALYSIS IN THE NATURE OF BUILDING INSPECTION, POST CONSTRUCTION INVESTIGATION AND CONSULTATION OF MULTI-FAMILY RESIDENTIAL PROPERTIES FOR THE PURPOSE OF EVALUATING APARTMENT TO CONDOMINIUM CONSTRUCTION CONVERSION (U.S. CLS. 100, 103 AND 106).

FIRST USE 1-31-2005; IN COMMERCE 1-31-2005.
MICHAEL WEBSTER, EXAMINING ATTORNEY

NO CLAIM IS MADE TO THE EXCLUSIVE RIGHT TO USE "AMERICA IN-HOME", APART FROM THE MARK AS SHOWN.

FOR INSTALLATION OF HOME THEATER SYSTEMS, AUDIO/VIDEO SYSTEMS, VACUUM SYSTEMS, STRUCTURED WIRE SYSTEMS, ROOM ORGANIZATION SYSTEMS AND SAFETY AND SECURITY SYSTEMS, NAMELY BURGLAR ALARM SYSTEMS, SMOKE AND FIRE DETECTION SYSTEMS, CARBON MONOXIDE SENSORS, TEMPERATURE SENSORS, WATER INTRUSION AND FLOOD SENSORS AND MEDICAL ALERT SYSTEMS (U.S. CLS. 100, 103 AND 106).

FIRST USE 8-0-2006; IN COMMERCE 8-0-2006.
HEATHER SAPP, EXAMINING ATTORNEY

SN 78-714,211. ONE SCOTTSDALE HOLDINGS LLC, SCOTTSDALE, AZ. FILED 9-15-2005.

SN 78-731,041. DONOVAN, RUSS, OAKLAND, CA. FILED 10-11-2005.

ONE SCOTTSDALE

PHILBRICK

THE MARK CONSISTS OF STANDARD CHARACTERS WITHOUT CLAIM TO ANY PARTICULAR FONT, STYLE, SIZE, OR COLOR.

NO CLAIM IS MADE TO THE EXCLUSIVE RIGHT TO USE "SCOTTSDALE", APART FROM THE MARK AS SHOWN.

FOR REAL ESTATE DEVELOPMENT SERVICES, NAMELY, THE DEVELOPMENT OF MASTER PLANNED COMMUNITIES, PLANNING AND DEVELOPMENT OF RESIDENTIAL COMMUNITIES, INCLUDING HOUSES AND APARTMENTS; COMMERCIAL PROPERTIES, INDUSTRIAL BUILDINGS, OFFICE AND RETAIL SPACE (U.S. CLS. 100, 103 AND 106).
CAROLYN CATALDO, EXAMINING ATTORNEY

THE MARK CONSISTS OF STANDARD CHARACTERS WITHOUT CLAIM TO ANY PARTICULAR FONT, STYLE, SIZE, OR COLOR.

SEC. 2(F).
FOR REPAIR, MAINTENANCE, AND RESTORATION OF BOATS (U.S. CLS. 100, 103 AND 106).
FIRST USE 7-31-1934; IN COMMERCE 12-31-1934.
TARAH HARDY, EXAMINING ATTORNEY

CLASS 37—(Continued).

SN 78-740,319. IMPRIMIS LLC, SANDY, UT. FILED 10-25-2005.

Imprimis

THE MARK CONSISTS OF STANDARD CHARACTERS WITHOUT CLAIM TO ANY PARTICULAR FONT, STYLE, SIZE, OR COLOR.

FOR REAL ESTATE DEVELOPMENT (U.S. CLS. 100, 103 AND 106).

FIRST USE 9-30-2005; IN COMMERCE 9-30-2005.
TRAVIS WHEATLEY, EXAMINING ATTORNEY

CLASS 37—(Continued).

SN 78-784,747. PCG TRADING, LLC, PEABODY, MA. FILED 1-4-2006.

NEXTPHASE

THE MARK CONSISTS OF STANDARD CHARACTERS WITHOUT CLAIM TO ANY PARTICULAR FONT, STYLE, SIZE, OR COLOR.

FOR RESTORING, RECONDITIONING, AND REBUILDING OF COMPUTERS, COMPUTER ACCESSORIES, AND COMPUTER PARTS FOR RESALE (U.S. CLS. 100, 103 AND 106).

FIRST USE 12-1-2005; IN COMMERCE 12-1-2005.
WENDY GOODMAN, EXAMINING ATTORNEY

SN 78-746,840. F.C. FRANCHISING SYSTEMS, INC., CINCINNATI, OH. FILED 11-3-2005.

ON CALL PAINTERS

THE MARK CONSISTS OF STANDARD CHARACTERS WITHOUT CLAIM TO ANY PARTICULAR FONT, STYLE, SIZE, OR COLOR.

NO CLAIM IS MADE TO THE EXCLUSIVE RIGHT TO USE "PAINTERS", APART FROM THE MARK AS SHOWN. FOR HOUSE PAINTING (U.S. CLS. 100, 103 AND 106).

FIRST USE 11-1-2005; IN COMMERCE 11-1-2005.
RICHARD WHITE, EXAMINING ATTORNEY

SN 78-790,912. COURTNEY KELLOGG, ANNAPOLIS, MD. FILED 1-13-2006.

Ecologic Cleaning

THE MARK CONSISTS OF STANDARD CHARACTERS WITHOUT CLAIM TO ANY PARTICULAR FONT, STYLE, SIZE, OR COLOR.

NO CLAIM IS MADE TO THE EXCLUSIVE RIGHT TO USE "CLEANING", APART FROM THE MARK AS SHOWN. FOR CLEANING OF RESIDENTIAL HOUSES (U.S. CLS. 100, 103 AND 106).

FIRST USE 12-1-2005; IN COMMERCE 12-1-2005.
SKYE YOUNG, EXAMINING ATTORNEY

SN 78-751,991. DUKE'S FIREHOSE COMPANY, INC., FRAZER, PA. FILED 11-11-2005.

SAFETY WAX

THE MARK CONSISTS OF STANDARD CHARACTERS WITHOUT CLAIM TO ANY PARTICULAR FONT, STYLE, SIZE, OR COLOR.

NO CLAIM IS MADE TO THE EXCLUSIVE RIGHT TO USE "WAX", APART FROM THE MARK AS SHOWN. FOR CAR AND TRUCK WASHING SERVICES (U.S. CLS. 100, 103 AND 106).

FIRST USE 3-1-1997; IN COMMERCE 9-1-1998.
ANDREA EVANS, EXAMINING ATTORNEY

SN 78-791,417. SENIZERGUES, PIERRE ANDRE, NEWPORT BEACH, CA. FILED 1-13-2006.

PAS ECOSKATE HOUSE

THE MARK CONSISTS OF STANDARD CHARACTERS WITHOUT CLAIM TO ANY PARTICULAR FONT, STYLE, SIZE, OR COLOR.

NO CLAIM IS MADE TO THE EXCLUSIVE RIGHT TO USE "HOUSE", APART FROM THE MARK AS SHOWN. FOR BUILDING CONSTRUCTION AND REPAIR; CONSTRUCTION AND RENOVATION OF BUILDINGS (U.S. CLS. 100, 103 AND 106).

FIRST USE 12-1-2005; IN COMMERCE 12-1-2005.
DANNEAN HETZEL, EXAMINING ATTORNEY

CLASS 37—(Continued).

SN 78-818,552. DESARROLLO MARINA VALLARTA, S.A. DE C.V., GUADALAJARA, MEXICO, FILED 2-19-2006.

NUEVO PUERTO PENASCO

THE MARK CONSISTS OF STANDARD CHARACTERS WITHOUT CLAIM TO ANY PARTICULAR FONT, STYLE, SIZE, OR COLOR.

NO CLAIM IS MADE TO THE EXCLUSIVE RIGHT TO USE "PUERTO PENASCO", APART FROM THE MARK AS SHOWN.

THE FOREIGN WORDING IN THE MARK TRANSLATES INTO ENGLISH AS NEW PUERTO PENASCO.

FOR LAND DEVELOPMENT SERVICES, NAMELY, PLANNING AND LAYING OUT OF RESIDENTIAL AND/OR COMMERCIAL COMMUNITIES; REAL ESTATE DEVELOPMENT (U.S. CLS. 100, 103 AND 106).

REBECCA GAN, EXAMINING ATTORNEY

SN 78-818,554. DESARROLLO MARINA VALLARTA, S.A. DE C.V., GUADALAJARA, MEXICO, FILED 2-19-2006.

NEW ROCKY POINT

THE MARK CONSISTS OF STANDARD CHARACTERS WITHOUT CLAIM TO ANY PARTICULAR FONT, STYLE, SIZE, OR COLOR.

NO CLAIM IS MADE TO THE EXCLUSIVE RIGHT TO USE "ROCKY POINT", APART FROM THE MARK AS SHOWN.

FOR LAND DEVELOPMENT SERVICES, NAMELY, PLANNING AND LAYING OUT OF RESIDENTIAL AND/OR COMMERCIAL COMMUNITIES; REAL ESTATE DEVELOPMENT (U.S. CLS. 100, 103 AND 106).

REBECCA GAN, EXAMINING ATTORNEY

SN 78-822,783. CROPP-METCALFE, FAIRFAX, VA. FILED 2-24-2006.

5 STAR TECHNICIAN

THE MARK CONSISTS OF STANDARD CHARACTERS WITHOUT CLAIM TO ANY PARTICULAR FONT, STYLE, SIZE, OR COLOR.

NO CLAIM IS MADE TO THE EXCLUSIVE RIGHT TO USE "TECHNICIAN", APART FROM THE MARK AS SHOWN.

FOR HVAC CONTRACTOR SERVICES (U.S. CLS. 100, 103 AND 106).

FIRST USE 9-14-2005; IN COMMERCE 2-20-2006.
PAUL CROWLEY, EXAMINING ATTORNEY

CLASS 37—(Continued).

SN 78-834,785. GLEN, SMITH & GLEN DEVELOPMENT COMPANY LLC, LAS VEGAS, NV. FILED 3-10-2006.



NO CLAIM IS MADE TO THE EXCLUSIVE RIGHT TO USE "DEVELOPMENT", APART FROM THE MARK AS SHOWN.

THE MARK CONSISTS OF THE LETTERS GSG SEPARATED BY SLASHES FOLLOWED BY THE WORDS GLEN, SMITH & GLEN OVER THE WORD DEVELOPMENT.

FOR REAL ESTATE DEVELOPMENT; REAL ESTATE SITE SELECTION; CONSTRUCTION PLANNING; CONSTRUCTION MANAGEMENT AND SUPERVISION; AND CONSTRUCTION SERVICES, NAMELY, PLANNING, LAYING OUT AND CUSTOM CONSTRUCTION OF RESIDENTIAL AND COMMERCIAL COMMUNITIES; LAND DEVELOPMENT SERVICES, NAMELY, PLANNING AND LAYING OUT OF RESIDENTIAL AND/OR COMMERCIAL COMMUNITIES (U.S. CLS. 100, 103 AND 106).

FIRST USE 7-30-2003; IN COMMERCE 7-30-2003.
SUSAN LESLIE DUBOIS, EXAMINING ATTORNEY

SN 78-837,571. OLEY, MICHAEL, GOOCHLAND, VA. FILED 3-15-2006.

the project people

THE MARK CONSISTS OF STANDARD CHARACTERS WITHOUT CLAIM TO ANY PARTICULAR FONT, STYLE, SIZE, OR COLOR.

FOR CONSULTATION IN THE FIELD OF HOME IMPROVEMENT, NAMELY BUILDING AND REPAIR OF RESIDENTIAL AND COMMERCIAL HOMES (U.S. CLS. 100, 103 AND 106).

NAKIA HENRY, EXAMINING ATTORNEY

CLASS 37—(Continued).

SN 78-838,720. KS SQUARED, INC., BOHEMIA, NY. FILED 3-16-2006.



NO CLAIM IS MADE TO THE EXCLUSIVE RIGHT TO USE "CARPET CLEANING", APART FROM THE MARK AS SHOWN.

THE LIKENESS (OR, "PORTRAIT") IN THE MARK DOES NOT IDENTIFY A LIVING INDIVIDUAL.

FOR CARPET CLEANING, UPHOLSTERY CLEANING, AIR DUCT CLEANING, WINDOW CLEANING, VINYL CUT TILE CLEANING, FLOOD RESTORATION CLEANING (U.S. CLS. 100, 103 AND 106).

FIRST USE 11-2-2002; IN COMMERCE 11-2-2002.

BILL DAWE, EXAMINING ATTORNEY

SN 78-839,179. AF MASONRY, INC., DOVER, FL. FILED 3-16-2006.

Building America One Block at a Time

THE MARK CONSISTS OF STANDARD CHARACTERS WITHOUT CLAIM TO ANY PARTICULAR FONT, STYLE, SIZE, OR COLOR.

FOR MASONRY SERVICES (U.S. CLS. 100, 103 AND 106).

FIRST USE 11-1-2005; IN COMMERCE 11-1-2005.

ROBIN CHOSID, EXAMINING ATTORNEY

SN 78-847,895. HONDA MOTOR CO., LTD., MINATO-KU, TOKYO, JAPAN, FILED 3-28-2006.

ACURALINK ASSIST

THE MARK CONSISTS OF STANDARD CHARACTERS WITHOUT CLAIM TO ANY PARTICULAR FONT, STYLE, SIZE, OR COLOR.

OWNER OF U.S. REG. NOS. 1,407,602, 2,365,656 AND OTHERS.

NO CLAIM IS MADE TO THE EXCLUSIVE RIGHT TO USE "ASSIST", APART FROM THE MARK AS SHOWN.

FOR PROVIDING MAINTENANCE AND VEHICLE REPAIR INFORMATION TO DRIVERS REGARDING THEIR VEHICLES (U.S. CLS. 100, 103 AND 106).

MELISSA VALLILLO, EXAMINING ATTORNEY

CLASS 37—(Continued).

SN 78-849,316. INDUSTRIAL FENCE, INC., CHICAGO, IL. FILED 3-29-2006.

IFI GROUP

THE MARK CONSISTS OF STANDARD CHARACTERS WITHOUT CLAIM TO ANY PARTICULAR FONT, STYLE, SIZE, OR COLOR.

NO CLAIM IS MADE TO THE EXCLUSIVE RIGHT TO USE "GROUP", APART FROM THE MARK AS SHOWN.

FOR CONSTRUCTION SERVICES; INSTALLATION, CONSTRUCTION AND REPAIR OF ORNAMENTAL IRON FENCES, CHAIN LINK FENCES, OVERHEAD DOORS, GUARDRAILS, WOOD FENCES, WINDOW GUARDS, METAL RAILINGS; CONSTRUCTION SUPERVISION MANAGEMENT; CARPENTRY SERVICES; PAINTING SERVICES (U.S. CLS. 100, 103 AND 106).

FIRST USE 0-0-2005; IN COMMERCE 0-0-2005.

JEFF DEFORD, EXAMINING ATTORNEY

SN 78-853,197. GREENSTAR HOMES, INC., MADISON, WI. FILED 4-4-2006.



NO CLAIM IS MADE TO THE EXCLUSIVE RIGHT TO USE "HOMES", APART FROM THE MARK AS SHOWN.

THE COLORS GREEN, YELLOW, WHITE AND BLACK ARE CLAIMED AS A FEATURE OF THE MARK.

THE COLORS YELLOW AND WHITE APPEAR IN THE BACKGROUND OF THE MARK. THE COLOR GREEN APPEARS IN THE WORD GREEN, AND THE DESIGN OF A SHOOTING STAR. THE COLOR BLACK APPEARS IN THE WORDS STAR AND HOMES, AND IN THE DESIGN OF THE HOUSE AND TREE.

FOR RESIDENTIAL CONSTRUCTION; LAND DEVELOPMENT SERVICES, NAMELY, PLANNING AND LAYING OUT OF RESIDENTIAL COMMUNITIES; RESIDENTIAL CONSTRUCTION CONSULTING (U.S. CLS. 100, 103 AND 106).

FIRST USE 7-0-2003; IN COMMERCE 7-0-2003.

PAMELA HIRSCHMAN, EXAMINING ATTORNEY

CLASS 37—(Continued).

SN 78-854,026. RICHARDS, MARCUS A, WEST COVINA, CA.
FILED 4-4-2006.



THE APPLICANT CLAIMS COLOR AS A FEATURE OF THE MARK, NAMELY, BLACK, YELLOW AND GREY.

THE MARK CONSISTS OF STYLIZED LETTERS "E" AND "R" IN THE COLOR BLACK, THE WORD "EXPERT" IN THE COLOR YELLOW, THE WORD "REACTION" IN THE COLOR GREY.

FOR COMPUTER INSTALLATION AND REPAIR; INSTALLATION OF COMPUTER NETWORKS; INSTALLATION OF COMPUTER SYSTEMS; MAINTENANCE AND REPAIR OF COMPUTER HARDWARE; MAINTENANCE AND REPAIR OF COMPUTER NETWORKS; MAINTENANCE OF COMPUTER HARDWARE; REPAIR OF DAMAGED COMPUTERS; REPAIR OR MAINTENANCE OF COMPUTERS; UPDATING OF COMPUTER HARDWARE; UPGRADING OF COMPUTER HARDWARE (U.S. CLS. 100, 103 AND 106).

TONJA GASKINS, EXAMINING ATTORNEY

SN 78-854,787. RHODES DESIGN AND DEVELOPMENT CORP., LAS VEGAS, NV. FILED 4-5-2006.

CELESTE

THE MARK CONSISTS OF STANDARD CHARACTERS WITHOUT CLAIM TO ANY PARTICULAR FONT, STYLE, SIZE, OR COLOR.

FOR HOMEBUILDING SERVICES; DEVELOPMENT OF REAL PROPERTY FOR SINGLE-FAMILY AND MULTI-FAMILY RESIDENTIAL AND MASTER-PLANNED COMMUNITY PURPOSES (U.S. CLS. 100, 103 AND 106).

RENEE MCCRAY, EXAMINING ATTORNEY

SN 78-854,791. RHODES DESIGN AND DEVELOPMENT CORP., LAS VEGAS, NV. FILED 4-5-2006.

JARUPA

THE MARK CONSISTS OF STANDARD CHARACTERS WITHOUT CLAIM TO ANY PARTICULAR FONT, STYLE, SIZE, OR COLOR.

FOR HOMEBUILDING SERVICES; DEVELOPMENT OF REAL PROPERTY FOR SINGLE-FAMILY AND MULTI-FAMILY RESIDENTIAL AND MASTER-PLANNED COMMUNITY PURPOSES (U.S. CLS. 100, 103 AND 106).

RENEE MCCRAY, EXAMINING ATTORNEY

CLASS 37—(Continued).

SN 78-855,480. CYBER COMPUTERS, BULLHEAD CITY, AZ.
FILED 4-6-2006.



NO CLAIM IS MADE TO THE EXCLUSIVE RIGHT TO USE "COMPUTERS", APART FROM THE MARK AS SHOWN.

FOR COMPUTER REPAIR AND INSTALLATION OF COMPUTER NETWORKS (U.S. CLS. 100, 103 AND 106).

FIRST USE 6-1-2001; IN COMMERCE 6-1-2001.

ALEXANDER L. POWERS, EXAMINING ATTORNEY

SN 78-855,546. ASSOCIATED MATERIALS, INC., DBA AL-SIDE, CUYAHOGA FALLS, OH. FILED 4-6-2006.

ISS Installed Sales Solutions

THE MARK CONSISTS OF STANDARD CHARACTERS WITHOUT CLAIM TO ANY PARTICULAR FONT, STYLE, SIZE, OR COLOR.

NO CLAIM IS MADE TO THE EXCLUSIVE RIGHT TO USE INSTALLED SALES, APART FROM THE MARK AS SHOWN.

FOR INSTALLATION OF WINDOWS AND SIDING (U.S. CLS. 100, 103 AND 106).

FIRST USE 3-15-2006; IN COMMERCE 3-15-2006.

JEFF DEFORD, EXAMINING ATTORNEY

SN 78-855,930. LIBHART, INC., DBA POOLS BY LIBHART, ATLANTIC BEACH, FL. FILED 4-6-2006.



NO CLAIM IS MADE TO THE EXCLUSIVE RIGHT TO USE POOLS AND CERTIFIED RESIDENTIAL POOL CONTRACTOR, APART FROM THE MARK AS SHOWN.

THE MARK CONSISTS OF STYLIZED WORDS "POOLS BY LIBHART CERTIFIED RESIDENTIAL POOL CONTRACTOR" WITH A PICTURE OF A PALM TREE IN A CIRCLE.

FOR INSTALLATION, MAINTENANCE AND REPAIR OF SWIMMING POOLS, SCREEN ENCLOSURES, PAVERS, WATERSCAPES, SOLAR SYSTEMS, POOL HEATERS, AND SALT SYSTEMS (U.S. CLS. 100, 103 AND 106).

FIRST USE 1-1-2004; IN COMMERCE 1-1-2004.

WILLIAM BRECKENFELD, EXAMINING ATTORNEY

CLASS 37—(Continued).

SN 78-856,675. ISOTECH PEST MANAGEMENT, INC., COVINA, CA. FILED 4-7-2006.

**THE PREMIER PEST
MANAGEMENT EXPERIENCE**

THE MARK CONSISTS OF STANDARD CHARACTERS WITHOUT CLAIM TO ANY PARTICULAR FONT, STYLE, SIZE, OR COLOR.

NO CLAIM IS MADE TO THE EXCLUSIVE RIGHT TO USE "PREMIER PEST MANAGEMENT", APART FROM THE MARK AS SHOWN.

FOR PEST CONTROL SERVICES; ODOR CONTROL SERVICES (U.S. CLS. 100, 103 AND 106).

FIRST USE 8-5-2005; IN COMMERCE 8-5-2005.

JILL PRATER, EXAMINING ATTORNEY

SN 78-857,690. REGLAZE MASTER, INC., WESTON, FL. FILED 4-10-2006.

UGLY TUBS?

THE MARK CONSISTS OF STANDARD CHARACTERS WITHOUT CLAIM TO ANY PARTICULAR FONT, STYLE, SIZE, OR COLOR.

NO CLAIM IS MADE TO THE EXCLUSIVE RIGHT TO USE "TUBS", APART FROM THE MARK AS SHOWN.

FOR RESURFACING OF BATHTUBS, TILES AND COUNTERTOPS (U.S. CLS. 100, 103 AND 106).

FIRST USE 6-17-2004; IN COMMERCE 6-17-2004.

NAKIA HENRY, EXAMINING ATTORNEY

SN 78-857,843. HAFF, KENNETH R, PALM HARBOR, FL. FILED 4-10-2006.



THE MARK CONSISTS OF STYLIZED WORDS, SUN, CLOUDS, AND A STANDING MAID.

FOR CLEANING OF INDUSTRIAL PREMISES; CLEANING OF RESIDENTIAL HOUSES (U.S. CLS. 100, 103 AND 106).

FIRST USE 4-6-2006; IN COMMERCE 4-6-2006.

DAYNA BROWNE, EXAMINING ATTORNEY

CLASS 37—(Continued).

SN 78-859,864. COYOTE JOE'S COFFEE COMPANY, NEWBERG, OR. FILED 4-12-2006.

COYOTE JOE'S

THE MARK CONSISTS OF STANDARD CHARACTERS WITHOUT CLAIM TO ANY PARTICULAR FONT, STYLE, SIZE, OR COLOR.

FOR AUTOMOBILE CLEANING AND CAR WASHING (U.S. CLS. 100, 103 AND 106).

FIRST USE 6-1-2005; IN COMMERCE 6-1-2005.

DAVID MILLER, EXAMINING ATTORNEY

SN 78-859,968. THE SETTINGS DEVELOPMENT COMPANIES, LLC, ATLANTA, GA. FILED 4-12-2006.

THE SETTINGS

THE MARK CONSISTS OF THE WORDS "THE SETTINGS" AND TWO OVERLAPPING CURVED LINES ABOVE THE WORDS "THE SETTINGS".

FOR REAL ESTATE DEVELOPMENT (U.S. CLS. 100, 103 AND 106).

FIRST USE 7-15-2005; IN COMMERCE 7-15-2005.

NICHOLAS ALTREE, EXAMINING ATTORNEY

CLASS 37—(Continued).

SN 78-862,013. MCBRIDE ELECTRIC, INC., SAN DIEGO, CA. FILED 4-14-2006.



People. Process. Results.

OWNER OF U.S. REG. NOS. 940,731, 2,966,509 AND OTHERS.

NO CLAIM IS MADE TO THE EXCLUSIVE RIGHT TO USE "POWER", "NATIONWIDE", "PEOPLE", "PROCESS" AND "RESULTS", APART FROM THE MARK AS SHOWN.

THE COLOR(S) BLUE, BLACK, DARK GRAY AND LIGHT GRAY IS/ARE CLAIMED AS A FEATURE OF THE MARK.

THE MARK CONSISTS OF THE LETTER "M" IN BLUE, THE WORD "POWER" IN BLACK, THE WORD "MCBRIDE" IN DARK GRAY, THE WORD "NATIONWIDE" IN LIGHT GRAY, AND THE WORDS "PEOPLE.", "PROCESS.", AND "RESULTS." IN BLUE. THE LETTER "M" AT THE BEGINNING OF THE MARK IS HIGHLIGHTED BY A GRAY SHADOW. THE LETTER "M" AND THE WORDS "POWER", "MCBRIDE", AND "NATIONWIDE" ARE SEPARATED BY INTERSECTING BLACK VERTICAL AND HORIZONTAL LINES.

FOR CONSULTING IN THE FIELD OF ELECTRICAL CONTRACTOR SERVICES; ELECTRICAL CONTRACTOR SERVICES, NAMELY, MULTI-CITY AND MULTI-SITE INSTALLATION OF ELECTRICAL SYSTEMS, POWER SYSTEMS, AND DATA TRANSMISSION SYSTEMS (U.S. CLS. 100, 103 AND 106).

FIRST USE 4-9-2006; IN COMMERCE 4-9-2006.

MICHAEL KEATING, EXAMINING ATTORNEY

SN 78-864,004. SUNSHINE CAR CARE, LLC, TALLAHASSEE, FL. FILED 4-18-2006.

THE MARK CONSISTS OF THE WORDS SUPER-SPLASH WRITTEN IN AN ARC.

FOR CAR WASH SERVICES (U.S. CLS. 100, 103 AND 106).

FIRST USE 0-0-2005; IN COMMERCE 0-0-2005.

WANDA KAY PRICE, EXAMINING ATTORNEY

CLASS 37—(Continued).

SN 78-864,433. HEADLINE MANAGEMENT, INC., CORNELIUS, NC. FILED 4-19-2006.

READY SET REPAIR!

THE MARK CONSISTS OF STANDARD CHARACTERS WITHOUT CLAIM TO ANY PARTICULAR FONT, STYLE, SIZE, OR COLOR.

FOR BUILDING MAINTENANCE AND REPAIR (U.S. CLS. 100, 103 AND 106).

FIRST USE 1-1-2006; IN COMMERCE 1-1-2006.

BRIDGETT SMITH, EXAMINING ATTORNEY

SN 78-864,612. WORTHINGTON AVIATION PARTS, INC., EAGAN, MN. FILED 4-19-2006.

THE TRUSTED SOURCE

THE MARK CONSISTS OF STANDARD CHARACTERS WITHOUT CLAIM TO ANY PARTICULAR FONT, STYLE, SIZE, OR COLOR.

FOR AIRCRAFT REPAIR AND MAINTENANCE; MAINTENANCE AND/OR REPAIR OF AIRCRAFT; OUTER AND INNER CLEANING OF AIRCRAFT; PROVIDING INFORMATION ON REPAIR SERVICES IN THE AVIATION SECTOR; REPAIR, SERVICING AND MAINTENANCE OF VEHICLES AND APPARATUS FOR Locomotion BY AIR (U.S. CLS. 100, 103 AND 106).

FIRST USE 4-1-2006; IN COMMERCE 4-1-2006.

HOWARD SMIGA, EXAMINING ATTORNEY

SN 78-866,797. EARLY, GREGORY C., MACON, GA. FILED 4-21-2006.

AFFORDABLE HOUSING.
EXCEPTIONAL RESULTS

THE MARK CONSISTS OF STANDARD CHARACTERS WITHOUT CLAIM TO ANY PARTICULAR FONT, STYLE, SIZE, OR COLOR.

FOR HOUSE BUILDING AND REPAIR (U.S. CLS. 100, 103 AND 106).

CAROL SPILS, EXAMINING ATTORNEY

CLASS 37—(Continued).

SN 78-866,807. RCR PLUMBING, INC, ORANGE, CA. FILED 4-21-2006.



OWNER OF U.S. REG. NO. 2,582,115.
THE COLOR(S) DARK AND LIGHT BLUE IS/ARE CLAIMED AS A FEATURE OF THE MARK.

THE COLOR LIGHT BLUE APPEARS IN THE WATER DROPLET DESIGN IN THE MARK. THE COLOR DARK BLUE APPEARS IN THE LETTERS "RCR" IN THE MARK.

THE MARK CONSISTS OF STYLIZED LETTER "RCR" WITH A WATER DROPLET IN THE CENTER OF THE LETTER C.

FOR PLUMBING SERVICES (U.S. CLS. 100, 103 AND 106).

FIRST USE 7-1-2004; IN COMMERCE 7-1-2004.

BARBARA A. LOUGHRAN, EXAMINING ATTORNEY

SN 78-867,822. PACIFIC STAR COMMUNICATIONS, INC., PORTLAND, OR. FILED 4-24-2006.

PACSTAR

THE MARK CONSISTS OF STANDARD CHARACTERS WITHOUT CLAIM TO ANY PARTICULAR FONT, STYLE, SIZE, OR COLOR.

FOR MAINTENANCE AND REPAIR OF COMPUTER, COMMUNICATIONS AND TELECOMMUNICATIONS HARDWARE AND SOFTWARE (U.S. CLS. 100, 103 AND 106).

TIMOTHY FINNEGAN, EXAMINING ATTORNEY

CLASS 37—(Continued).

SN 78-868,385. CONTROLLED AIR, INC., KINGSPORT, TN. FILED 4-24-2006.



THE MARK CONSISTS OF THREE INTERTWINING BOOMERANGS.

FOR HEATING, AIR CONDITIONING AND PLUMBING CONTRACTOR SERVICES (U.S. CLS. 100, 103 AND 106).

FIRST USE 4-1-2005; IN COMMERCE 4-1-2005.

SANDRA MANIOS, EXAMINING ATTORNEY

SN 78-868,842. PRO IMAGE INSTALLERS, NAVARRE, FL. FILED 4-25-2006.

Pro Image Installers

THE MARK CONSISTS OF STANDARD CHARACTERS WITHOUT CLAIM TO ANY PARTICULAR FONT, STYLE, SIZE, OR COLOR.

NO CLAIM IS MADE TO THE EXCLUSIVE RIGHT TO USE "INSTALLERS", APART FROM THE MARK AS SHOWN.

FOR INSTALLATION OF FIXTURES AND GRAPHICS, AND BUILDOUTS, REMODELS, AND RETROFITS FOR RETAIL AND HOSPITALITY ENVIRONMENTS (U.S. CLS. 100, 103 AND 106).

FIRST USE 12-31-1998; IN COMMERCE 12-31-1998.

WILLIAM P. SHANAHAN, EXAMINING ATTORNEY

CLASS 37—(Continued).

SN 78-868,987. HEADLINE MANAGEMENT, INC., CORNELIUS, NC. FILED 4-25-2006.

READY SET RENOVATE!

THE MARK CONSISTS OF STANDARD CHARACTERS WITHOUT CLAIM TO ANY PARTICULAR FONT, STYLE, SIZE, OR COLOR.

FOR CONSTRUCTION AND RENOVATION OF BUILDINGS; CONSTRUCTION, MAINTENANCE AND RENOVATION OF PROPERTY; RENOVATION IN THE FIELD OF RESIDENTIAL AND COMMERCIAL BUILDINGS (U.S. CLS. 100, 103 AND 106).

BRIDGETT SMITH, EXAMINING ATTORNEY

SN 78-869,095. MUELLER WATER PRODUCTS, INC., TAMPA, FL. FILED 4-25-2006.

AQUANT

THE MARK CONSISTS OF STANDARD CHARACTERS WITHOUT CLAIM TO ANY PARTICULAR FONT, STYLE, SIZE, OR COLOR.

FOR CONSULTING SERVICES FOR THE CONSTRUCTION OF WATER TREATMENT AND PURIFICATION PLANTS, SOLID WASTE TREATMENT PLANTS AND OTHER MUNICIPAL INFRASTRUCTURE FACILITIES; PUMP REPAIR OR MAINTENANCE; PUMP REPAIRING (U.S. CLS. 100, 103 AND 106).

MICHAEL WEBSTER, EXAMINING ATTORNEY

SN 78-870,191. KASTERA LLC, BOISE, ID. FILED 4-26-2006.

WELCOME HOME TO KASTERA

THE MARK CONSISTS OF STANDARD CHARACTERS WITHOUT CLAIM TO ANY PARTICULAR FONT, STYLE, SIZE, OR COLOR.

OWNER OF U.S. REG. NO. 3,126,909.

FOR CONSTRUCTION SERVICES, NAMELY, PLANNING, LAYING OUT AND CONSTRUCTION OF RESIDENTIAL COMMUNITIES; CONSTRUCTION OF SINGLE FAMILY DWELLING UNITS; REAL ESTATE DEVELOPMENT (U.S. CLS. 100, 103 AND 106).

FIRST USE 9-1-2005; IN COMMERCE 9-1-2005.
GISELLE AGOSTO, EXAMINING ATTORNEY

CLASS 37—(Continued).

SN 78-870,926. ANOTHER WAY ENTERPRISES, LLC, SPOKANE, WA. FILED 4-27-2006.

TIEMPO COMMONS

THE MARK CONSISTS OF STANDARD CHARACTERS WITHOUT CLAIM TO ANY PARTICULAR FONT, STYLE, SIZE, OR COLOR.

NO CLAIM IS MADE TO THE EXCLUSIVE RIGHT TO USE "COMMONS", APART FROM THE MARK AS SHOWN. THE ENGLISH TRANSLATION OF THE WORD TIEMPO IN THE MARK IS TIME.

FOR REAL ESTATE PROJECT PLANNING AND DEVELOPMENT (U.S. CLS. 100, 103 AND 106).

DARRYL SPRUILL, EXAMINING ATTORNEY

SN 78-871,074. MCCALL SERVICE, INC., JACKSONVILLE, FL. FILED 4-27-2006.

**PROTECTING YOUR HOME FROM
THE GROUND UP**

THE MARK CONSISTS OF STANDARD CHARACTERS WITHOUT CLAIM TO ANY PARTICULAR FONT, STYLE, SIZE, OR COLOR.

FOR TERMITE AND PEST CONTROL (U.S. CLS. 100, 103 AND 106).

JUSTINE D. PARKER, EXAMINING ATTORNEY

SN 78-871,257. STANDARD TRUST CORPORATION, AIKEN, SC. FILED 4-27-2006.



OWNER OF U.S. REG. NO. 2,909,737.

THE COLOR(S) BLACK, GRAY, YELLOW, LIGHT ORANGE, LIGHT PINK, RED, CHARCOAL GRAY, WHITE, LIGHT BLUE, NAVY BLUE IS/ARE CLAIMED AS A FEATURE OF THE MARK.

THE COLOR BLACK APPEARS IN THE OUTLINE OF THE HUMAN CHARACTER DESIGN, AND IN THE CHARACTER'S WATCH. THE COLOR GRAY APPEARS IN THE CHARACTER'S CAP AND PANTS. THE COLOR YELLOW APPEARS IN THE CHARACTER'S SHIRT AND IN THE SUN AND SUN RAYS. THE COLOR LIGHT ORANGE APPEARS

CLASS 37—(Continued).

IN THE SUN, THE SUN RAYS, AND THE OUTLINE OF THE SUN RAYS. THE COLOR LIGHT PINK APPEARS IN THE CHARACTER'S SKIN. THE COLOR RED APPEARS IN THE LETTERING ON THE CAP, IN THE WORDS "MR. CENTRAL," IN THE CHARACTER'S HAIR, AND IN THE FLAG ON THE CHARACTER'S SHIRT. THE COLOR CHARCOAL GRAY APPEARS IN THE CHARACTER'S WATCH AND SHOES. THE COLOR WHITE APPEARS IN THE CHARACTER'S EYES, TEETH, WATCH, ICE CUBE, AND IN THE FLAG ON HIS SHIRT. THE COLOR LIGHT BLUE APPEARS IN THE ICE CUBE. THE COLOR NAVY BLUE APPEARS IN THE FLAG ON THE CHARACTER'S SHIRT.

THE MARK CONSISTS OF A SMILING HUMAN CHARACTER WEARING A CAP AND LOOKING DOWN AT HIS WRISTWATCH. THE CAP BEARS A STYLIZED "M" AND "C" WHICH OVERLAP. THE CHARACTER'S BODY IS IN THE SHAPE OF AN ICE CUBE THAT IS DRIPPING IN THREE PLACES. THE STYLIZED WORDS "MR. CENTRAL" APPEAR ON THE FRONT OF THE ICE CUBE. BEHIND AND TO THE UPPER LEFT OF THE CHARACTER IS A SUN WITH RAYS EMANATING FROM IT IN ALL DIRECTIONS.

FOR AIR CONDITIONING CONTRACTOR SERVICES; HEATING CONTRACTOR SERVICES (U.S. CLS. 100, 103 AND 106).

FIRST USE 6-1-2005; IN COMMERCE 6-1-2005.

BRENDAN MCCAULEY, EXAMINING ATTORNEY

SN 78-872,330. 866 FIX GLASS, INC., NORTHVILLE, MI. FILED 4-28-2006.



FOR AUTOMOBILE REPAIR AND MAINTENANCE, NAMELY, REPAIRING AND REPLACING AUTOMOBILE WINDOWS AND REPAIRING MOTOR VEHICLES (U.S. CLS. 100, 103 AND 106).

FIRST USE 5-31-2005; IN COMMERCE 6-1-2005.

BERYL GARDNER, EXAMINING ATTORNEY

SN 78-873,514. SAVAGES INC., OKLAHOMA CITY, OK. FILED 5-1-2006.

YOU HAVE THE RIGHT TO REMAIN OUTDOORS

THE MARK CONSISTS OF STANDARD CHARACTERS WITHOUT CLAIM TO ANY PARTICULAR FONT, STYLE, SIZE, OR COLOR.

FOR PEST CONTROL (U.S. CLS. 100, 103 AND 106).

FIRST USE 3-1-2006; IN COMMERCE 3-1-2006.

EUGENIA MARTIN, EXAMINING ATTORNEY

CLASS 37—(Continued).

SN 78-895,542. GANDER MOUNTAIN COMPANY, ST. PAUL, MN. FILED 5-30-2006.

FOX RIVER

THE MARK CONSISTS OF STANDARD CHARACTERS WITHOUT CLAIM TO ANY PARTICULAR FONT, STYLE, SIZE, OR COLOR.

OWNER OF U.S. REG. NO. 1,850,302.

FOR GUNSMITHING, NAMELY REPAIR OR MAINTENANCE OF FIREARMS (U.S. CLS. 100, 103 AND 106).

PAMELA HIRSCHMAN, EXAMINING ATTORNEY

SN 78-907,294. HARTMANN & FORBES LLC, TUALATIN, OR. FILED 6-13-2006.

TAKE-BACK

THE MARK CONSISTS OF STANDARD CHARACTERS WITHOUT CLAIM TO ANY PARTICULAR FONT, STYLE, SIZE, OR COLOR.

FOR COLLECTION OF WINDOW SHADES AND WINDOW COVERINGS FOR RECYCLING (U.S. CLS. 100, 103 AND 106).

FIRST USE 1-0-2006; IN COMMERCE 1-0-2006.

YONG KIM, EXAMINING ATTORNEY

SN 79-018,481. EPULSE LIMITED, UNITED KINGDOM, FILED 10-12-2004.

EPULSE

THE MARK CONSISTS OF STANDARD CHARACTERS WITHOUT CLAIM TO ANY PARTICULAR FONT, STYLE, SIZE, OR COLOR.

OWNER OF INTERNATIONAL REGISTRATION 0870317 DATED 10-12-2004, EXPIRES 10-12-2014.

FOR INSTALLATION, MAINTENANCE AND REPAIR OF COMPUTER HARDWARE AND OFFICE MACHINES; INFORMATION SERVICES RELATING TO INSTALLATION, MAINTENANCE AND REPAIR SERVICES OF COMPUTER HARDWARE AND OFFICE MACHINES; INSTALLATION OF COMPUTER HARDWARE COMPONENTS NAMELY PERIPHERAL APPARATUS FOR USE WITH COMPUTERS, APPARATUS AND INSTRUMENTS FOR HANDLING, STORAGE, TRANSMISSION OR PROCESSING OF DATA FOR USE IN THE PROVISION OF TELECOMMUNICATIONS, ELECTRONIC MAIL AND COMPUTERIZED COMMUNICATION SERVICES; RESTORATION, REPAIR, INSTALLATION OR MAINTENANCE SERVICES IN RESPECT OF COMPUTERS, PERIPHERAL APPARATUS FOR USE WITH COMPUTERS, APPARATUS AND INSTRUMENTS FOR HANDLING, STORAGE, TRANSMISSION OR PROCESSING OF DATA (U.S. CLS. 100, 103 AND 106).

SUSAN BILLHEIMER, EXAMINING ATTORNEY

CLASS 38—COMMUNICATION

SN 76-118,207. JORDAN, STEPHANIE M., HUNTSVILLE, AL.
FILED 7-14-2000.

FUTURE NETWORKS

NO CLAIM IS MADE TO THE EXCLUSIVE RIGHT TO USE "NETWORKS", APART FROM THE MARK AS SHOWN.

FOR PROVIDING MULTIPLE-USER ACCESS TO A GLOBAL COMPUTER INFORMATION NETWORK; ELECTRONIC TRANSMISSION OF MESSAGES, VOICE, AND DATA; PROVIDING TELECOMMUNICATIONS CONNECTIONS TO A GLOBAL COMPUTER NETWORK; TELECOMMUNICATIONS SERVICES, NAMELY, PERSONAL COMMUNICATION SERVICES (U.S. CLS. 100, 101 AND 104).

FIRST USE 12-9-1993; IN COMMERCE 5-4-1994.
RONALD AIKENS, EXAMINING ATTORNEY

SN 76-633,476. TANDBERG, INC., RESTON, VA. FILED 3-17-2005.

BE THERE NOW

THE MARK CONSISTS OF STANDARD CHARACTERS WITHOUT CLAIM TO ANY PARTICULAR FONT, STYLE, SIZE, OR COLOR.

FOR VIDEO TELECONFERENCING (U.S. CLS. 100, 101 AND 104).

FIRST USE 7-0-2003; IN COMMERCE 7-0-2003.
SCOTT SISUN, EXAMINING ATTORNEY

SN 76-643,051. FLIK MEDIA CORPORATION, TUCSON, AZ.
FILED 7-15-2005.



THE COLOR(S) RED AND BLUE IS/ARE CLAIMED AS A FEATURE OF THE MARK.

THE COLOR(S) RED AND BLUE (2 SHADES, A DARKER SHADE AND A LIGHTER SHADE) APPEARING IN THE MARK ARE CLAIMED AS A FEATURE OF THE MARK. THE COLOR RED APPEARS IN THE STARS ABOVE THE TERM "PEOPLES", AND THE COLOR BLUE APPEARS IN 2 SHADES IN THE EXPRESSION "THE PEOPLES LOBBY". A DARKER SHADE IN THE WORD "PEOPLES" AND A LIGHTER SHADE IN THE WORDS "THE" AND "LOBBY".

FOR INTERNET BASED COMMUNICATION SERVICE, NAMELY, PROVIDING E-MAIL SERVICES ENABLING A CITIZEN TO RECEIVE INFORMATION BY INTERNET BASED COMMUNICATION DEVICES, REGARDING AN ISSUE OF INTEREST TO THE CITIZEN, AND TO PROVIDE INPUT TO A DECISION MAKER, PARTICULARLY A POLITICAL DECISION MAKER, ON THE ISSUE, BY E-MAIL USING INTERNET BASED COMMUNICATION DEVICES (U.S. CLS. 100, 101 AND 104).

DAVID ELTON, EXAMINING ATTORNEY

CLASS 38—(Continued).

SN 76-653,853. AFFILIATE LICENSE CO., L.L.C., BERWYN, PA. FILED 1-23-2006.

SUNCOM TRUE TO YOU

THE MARK CONSISTS OF STANDARD CHARACTERS WITHOUT CLAIM TO ANY PARTICULAR FONT, STYLE, SIZE, OR COLOR.

OWNER OF U.S. REG. NOS. 2,367,621 AND 2,576,959.
FOR WIRELESS TELECOMMUNICATIONS SERVICES, NAMELY, TRANSMISSION OF VOICE, DATA AND INFORMATION BY ELECTRONIC MEANS (U.S. CLS. 100, 101 AND 104).

SUSAN LESLIE DUBOIS, EXAMINING ATTORNEY

SN 76-657,214. UNIVISION COMMUNICATIONS INC., LOS ANGELES, CA. FILED 3-24-2006.

LA PICUDA

THE MARK CONSISTS OF STANDARD CHARACTERS WITHOUT CLAIM TO ANY PARTICULAR FONT, STYLE, SIZE, OR COLOR.

THE ENGLISH TRANSLATION OF "LA PICUDA" IS "THE SHARP ONE".

FOR RADIO BROADCASTING SERVICES (U.S. CLS. 100, 101 AND 104).

FIRST USE 1-9-2006; IN COMMERCE 1-9-2006.

JULIE GUTTADAURO, EXAMINING ATTORNEY

SN 76-658,383. CRICKET COMMUNICATIONS, INC., SAN DIEGO, CA. FILED 4-13-2006.

JUMP BY CRICKET

THE MARK CONSISTS OF STANDARD CHARACTERS WITHOUT CLAIM TO ANY PARTICULAR FONT, STYLE, SIZE, OR COLOR.

OWNER OF U.S. REG. NOS. 2,359,369 AND 2,359,370.

FOR TELECOMMUNICATIONS SERVICES, NAMELY, LOCAL, LONG DISTANCE AND INTERNATIONAL TRANSMISSION OF VOICE, DATA, TEXT, FACSIMILE, VIDEO, ADVERTISING, GAMING, AND GRAPHICS, BY MEANS OF TELEPHONE, CABLE, SATELLITE, WIRELESS AND HANDHELD AND PDA DEVICES AND THE INTERNET; PROVIDING ACCESS TO DIRECTORY SERVICES BY TELEPHONE, CABLE, SATELLITE, WIRELESS AND HANDHELD AND PDA DEVICES AND THE INTERNET; ELECTRONIC MAIL AND VOICE MESSAGING SERVICES, NAMELY, RECORDING, STORAGE AND SUBSEQUENT TRANSMISSION OF MESSAGES BY TELEPHONE, CABLE, SATELLITE, WIRELESS AND HANDHELD AND PDA DEVICES THE INTERNET; COMPUTER-AIDED TRANSMISSION OF MESSAGES AND IMAGES; TRANSMITTING STREAMED SOUND AND AUDIO-VISUAL RECORDINGS VIA TELEPHONE, CABLE, SATELLITE, WIRELESS AND HANDHELD AND PDA DEVICES AND THE INTERNET; PAGING SERVICES; COMMUNICATIONS EXCHANGE SERVICES VIA TELEPHONE, CABLE SATELLITE, WIRELESS AND HANDHELD AND PDA DEVICES AND THE INTERNET (U.S. CLS. 100, 101 AND 104).

NAKWAMA ANKRAH, EXAMINING ATTORNEY

CLASS 38—(Continued).

SN 76-659,221. GOTVMAIL COMMUNICATIONS, LLC, WESTON, MA. FILED 4-27-2006.

THE VIRTUAL PHONE SYSTEM FOR TODAY'S SMALL BUSINESS

THE MARK CONSISTS OF STANDARD CHARACTERS WITHOUT CLAIM TO ANY PARTICULAR FONT, STYLE, SIZE, OR COLOR.

OWNER OF U.S. REG. NO. 3,050,741.
FOR TELECOMMUNICATIONS SERVICES, NAMELY VOICE MAIL SERVICES, TOLL FREE TELEPHONE SERVICES, AND WIRELESS PBX SERVICES (U.S. CLS. 100, 101 AND 104).

CAROL SPILS, EXAMINING ATTORNEY

SN 76-661,584. GOTVMAIL COMMUNICATIONS, LLC, WESTON, MA. FILED 6-15-2006.

VOICEMAIL...AND SO MUCH MORE.

THE MARK CONSISTS OF STANDARD CHARACTERS WITHOUT CLAIM TO ANY PARTICULAR FONT, STYLE, SIZE, OR COLOR.

FOR TELECOMMUNICATIONS SERVICES, NAMELY VOICE MAIL SERVICES, TOLL FREE TELEPHONE SERVICES, AND WIRELESS PBX SERVICES (U.S. CLS. 100, 101 AND 104).

FIRST USE 5-25-2006; IN COMMERCE 5-25-2006.
CAROL SPILS, EXAMINING ATTORNEY

SN 78-138,837. ABS FAX TECHNOLOGIES, INC., HOUSTON, TX. FILED 6-26-2002.

ESIMPLY

OWNER OF U.S. REG. NO. 2,190,461.
FOR EMAIL TRANSMISSION SERVICES, NAMELY, AN EMAIL DISTRIBUTION SERVICE THAT ENABLES USERS TO SEND INFORMATION TO A MULTITUDE OF DESTINATIONS SIMULTANEOUSLY VIA EMAIL (U.S. CLS. 100, 101 AND 104).

FIRST USE 11-13-2001; IN COMMERCE 11-13-2001.
JOHN KELLY, EXAMINING ATTORNEY

CLASS 38—(Continued).

SN 78-382,046. QWEST COMMUNICATIONS INTERNATIONAL INC., DENVER, CO. FILED 3-10-2004.

SOLUTIONS THAT ARE OUT OF THE BOX. NOT OFF THE SHELF.

THE MARK CONSISTS OF STANDARD CHARACTERS WITHOUT CLAIM TO ANY PARTICULAR FONT, STYLE, SIZE, OR COLOR.

FOR TELECOMMUNICATIONS SERVICES, NAMELY TELEPHONE COMMUNICATIONS SERVICES, ELECTRONIC TRANSMISSION OF VOICE, DATA, VIDEO AND MESSAGES, PROVIDING ACCESS TO A FIBER OPTIC TELECOMMUNICATIONS NETWORK, PROVIDING PRIVATE AND SECURE REAL TIME ELECTRONIC COMMUNICATION OVER A COMPUTER NETWORK AND TELEPHONE LINES, LEASING AND RENTAL OF TELECOMMUNICATIONS EQUIPMENT, DSL SERVICES, PRIVATE LINE SERVICES, VIRTUAL PRIVATE NETWORK SERVICES, TELECOMMUNICATIONS CONSULTING SERVICES (U.S. CLS. 100, 101 AND 104).

FIRST USE 2-24-2004; IN COMMERCE 2-24-2004.
HOWARD B. LEVINE, EXAMINING ATTORNEY

SN 78-578,618. CLEARWIRE CORPORATION, KIRKLAND, WA. FILED 3-2-2005.

VOICEMAX

THE MARK CONSISTS OF STANDARD CHARACTERS WITHOUT CLAIM TO ANY PARTICULAR FONT, STYLE, SIZE, OR COLOR.

FOR TELECOMMUNICATIONS SERVICES NAMELY, PROVIDING TELECOMMUNICATIONS CONNECTIONS TO A GLOBAL COMPUTER NETWORK; ELECTRONIC, ELECTRIC, AND DIGITAL TRANSMISSION OF DATA, IMAGES, SIGNALS, MESSAGES AND VOICE; PROVIDING HIGH SPEED ACCESS TO AREA NETWORKS AND A GLOBAL COMPUTER INFORMATION NETWORK; TELECOMMUNICATION CONSULTATION; PROVIDING HIGH SPEED ACCESS TO COMPUTER AND COMMUNICATION NETWORKS (U.S. CLS. 100, 101 AND 104).

KELLEY WELLS, EXAMINING ATTORNEY

CLASS 38—(Continued).

SN 78-636,464. SCANR, INC., PALO ALTO, CA. FILED 5-24-2005.

SCANR

THE MARK CONSISTS OF STANDARD CHARACTERS WITHOUT CLAIM TO ANY PARTICULAR FONT, STYLE, SIZE, OR COLOR.

FOR WIRELESS TRANSMISSION OF DATA, FACSIMILES, IMAGES AND INFORMATION; INTERNET SERVICES, NAMELY THE TRANSMISSION OF DATA, FACSIMILES, IMAGES AND INFORMATION FROM COMPUTERS OR HANDHELD ELECTRONIC DEVICES TO OTHERS OVER AN ELECTRONIC COMMUNICATION NETWORK (U.S. CLS. 100, 101 AND 104).
MYRIAH HABEEB, EXAMINING ATTORNEY

SN 78-661,495. SATCOM DIRECT, INC., SATELLITE BEACH, FL. FILED 6-30-2005.

AERO X

THE MARK CONSISTS OF STANDARD CHARACTERS WITHOUT CLAIM TO ANY PARTICULAR FONT, STYLE, SIZE, OR COLOR.

FOR TELECOMMUNICATION SERVICES FOR AIR TO GROUND AND GROUND TO AIR COMMUNICATIONS, NAMELY, LOCAL AND LONG DISTANCE TRANSMISSION OF AUDIO, VIDEO AND DATA TRANSMISSION BY MEANS OF SATELLITE (U.S. CLS. 100, 101 AND 104).
FIRST USE 6-30-2005; IN COMMERCE 6-30-2005.
MICHAEL LEWIS, EXAMINING ATTORNEY

CLASS 38—(Continued).

SN 78-673,472. CINGULAR WIRELESS II, LLC, ATLANTA, GA. FILED 7-19-2005.

CINGULAR SOUNDS TONE CLUB

THE MARK CONSISTS OF STANDARD CHARACTERS WITHOUT CLAIM TO ANY PARTICULAR FONT, STYLE, SIZE, OR COLOR.

NO CLAIM IS MADE TO THE EXCLUSIVE RIGHT TO USE "SOUNDS TONE CLUB", APART FROM THE MARK AS SHOWN.

FOR TELECOMMUNICATIONS SERVICES, NAMELY WIRELESS TRANSMISSION OF VOICE, DATA, IMAGES, AUDIO, VIDEO, SIGNALS, SOFTWARE, INFORMATION, GAMES, RING TONES, RINGTONE SUBSCRIPTION PROGRAMS AND MESSAGES; WIRELESS TELEPHONE SERVICES; WIRELESS VOICE MESSAGING SERVICES; TELEPHONE CALL FORWARDING SERVICES; WIRELESS TEXT AND NUMERIC DIGITAL MESSAGING SERVICES; ELECTRONIC MAIL SERVICES; PAGING SERVICES; FACSIMILE TRANSMISSION SERVICES; PROVIDING MULTIPLE USER ACCESS TO A GLOBAL COMPUTER INFORMATION NETWORK, THE INTERNET, WIDE AREA NETWORKS, LOCAL AREA NETWORKS AND PRIVATE COMPUTER INFORMATION NETWORKS; WIRELESS TELEPHONE ROAMING SERVICES; TELEMATICS SERVICES; TELEMETRY SERVICES; TELECOMMUNICATIONS GATEWAY SERVICES; PROVIDING ON-LINE ELECTRONIC BULLETIN BOARDS FOR TRANSMISSION OF MESSAGES AMONG COMPUTER USERS CONCERNING A WIDE VARIETY OF TOPICS; TELEVISION BROADCASTING AND NARROW-CASTING SERVICES (U.S. CLS. 100, 101 AND 104).

MICHELE SWAIN, EXAMINING ATTORNEY

SN 78-692,532. GLOBAL VALLEY NETWORKS, INC., PATTERSON, CA. FILED 8-15-2005.

GLOBAL VALLEY LONG DISTANCE

THE MARK CONSISTS OF STANDARD CHARACTERS WITHOUT CLAIM TO ANY PARTICULAR FONT, STYLE, SIZE, OR COLOR.

NO CLAIM IS MADE TO THE EXCLUSIVE RIGHT TO USE "LONG DISTANCE", APART FROM THE MARK AS SHOWN.

FOR TELECOMMUNICATIONS SERVICES, NAMELY LOCAL AND LONG DISTANCE TELEPHONE, VOICE AND DATA TRANSMISSION BY MEANS OF TELEPHONE, CABLE, SATELLITE, AND INTERNET; DIGITAL SUBSCRIBER LINE AND BROADBAND SERVICES, NAMELY, PROVIDING TELEPHONE SYSTEM AND BROADBAND BASED MULTIPLE USER ACCESS TO A GLOBAL COMPUTER NETWORK; FACSIMILE TRANSMISSIONS SERVICES; WIRELESS COMMUNICATIONS SERVICES, NAMELY, WIRELESS TELEPHONE, FACSIMILE TRANSMISSION, AND DIGITAL MESSAGING SERVICES; PROVIDING WIRELESS COMMUNICATIONS ACCESS TO A GLOBAL COMPUTER NETWORK (U.S. CLS. 100, 101 AND 104).

FIRST USE 6-1-2004; IN COMMERCE 6-1-2004.
TASNEEM HUSSAIN, EXAMINING ATTORNEY

CLASS 38—(Continued).

SN 78-696,605. DIGITALBRIDGE COMMUNICATIONS, LLC, LEESBURG, VA. FILED 8-19-2005.



NO CLAIM IS MADE TO THE EXCLUSIVE RIGHT TO USE "COMMUNICATIONS", APART FROM THE MARK AS SHOWN.

FOR BROADBAND COMMUNICATION SERVICES OR PROVIDING MULTIPLE USER DIAL UP AND DEDICATED ACCESS TO THE INTERNET (U.S. CLS. 100, 101 AND 104).

RENEE MCCRAY, EXAMINING ATTORNEY

SN 78-699,295. EVOLUTION ARTISTS, INC., SAN FRANCISCO, CA. FILED 8-24-2005.

GCAST

THE MARK CONSISTS OF STANDARD CHARACTERS WITHOUT CLAIM TO ANY PARTICULAR FONT, STYLE, SIZE, OR COLOR.

FOR PODCASTING SERVICES, WEBCASTING SERVICES, SUBSCRIPTION SERVICES FOR AUDIO BROADCASTING (U.S. CLS. 100, 101 AND 104).

FIRST USE 12-1-2005; IN COMMERCE 12-1-2005.

KELLEY WELLS, EXAMINING ATTORNEY

SN 78-709,568. BOOST COMMUNICATIONS, SAN DIEGO, CA. FILED 9-8-2005.

mVote

THE MARK CONSISTS OF STANDARD CHARACTERS WITHOUT CLAIM TO ANY PARTICULAR FONT, STYLE, SIZE, OR COLOR.

FOR COMMUNICATIONS BY MOBILE PHONES, NAMELY, TO ALLOW RADIO LISTENERS TO COMMUNICATE WITH THE STATION VIA TEXT MESSAGING (U.S. CLS. 100, 101 AND 104).

FIRST USE 5-5-2005; IN COMMERCE 7-5-2005.

KAREN K. BUSH, EXAMINING ATTORNEY

CLASS 38—(Continued).

SN 78-709,572. BOOST COMMUNICATIONS, SAN DIEGO, CA. FILED 9-8-2005.

mtalk

THE MARK CONSISTS OF STANDARD CHARACTERS WITHOUT CLAIM TO ANY PARTICULAR FONT, STYLE, SIZE, OR COLOR.

FOR COMMUNICATIONS BY MOBILE PHONES, NAMELY, TO ALLOW RADIO LISTENERS TO COMMUNICATE WITH ON-AIR PERSONALITIES VIA TEXT MESSAGING (U.S. CLS. 100, 101 AND 104).

FIRST USE 6-6-2005; IN COMMERCE 7-5-2005.

KAREN K. BUSH, EXAMINING ATTORNEY

SN 78-715,661. VERSCIENT TECHNOLOGIES LLC, EDEN PRAIRIE, MN. FILED 9-19-2005.

VerScient

THE MARK CONSISTS OF STANDARD CHARACTERS WITHOUT CLAIM TO ANY PARTICULAR FONT, STYLE, SIZE, OR COLOR.

FOR TELEPHONE COMMUNICATION SERVICES (U.S. CLS. 100, 101 AND 104).

FIRST USE 9-17-2002; IN COMMERCE 9-17-2002.

JESSICA A. POWERS, EXAMINING ATTORNEY

CLASS 38—(Continued).

SN 78-724,872. SIGNAL, MOBILE, BOULOGNE, FRANCE,
FILED 10-3-2005.



OWNER OF FRANCE REG. NO. 053355275, DATED 4-25-2005, EXPIRES 4-25-2015.

THE MARK CONSISTS OF A MAN INSIDE A CIRCLE FOR CELLULAR TELEPHONE COMMUNICATION; COMMUNICATION BY ELECTRONIC COMPUTER TERMINALS; COMMUNICATION BY MOBILE TELEPHONE; COMMUNICATION SERVICES, NAMELY, ELECTRONIC TRANSMISSION OF DATA AND DOCUMENTS AMONG USERS OF COMPUTERS; COMMUNICATION VIA COMPUTER TERMINALS, BY DIGITAL TRANSMISSION OR BY SATELLITE; COMMUNICATIONS BY COMPUTER TERMINALS; COMMUNICATIONS BY MEANS OF MOBILE PHONES; COMMUNICATIONS BY MOBILE PHONES; COMMUNICATIONS SERVICES, NAMELY, TRANSMITTING STREAMED SOUND AND AUDIO-VISUAL RECORDINGS VIA THE INTERNET; COMMUNICATIONS VIA ANALOGUE AND DIGITAL COMPUTER TERMINALS; COMMUNICATIONS VIA MULTINATIONAL TELECOMMUNICATION NETWORKS; INFORMATION TRANSMISSION VIA ELECTRONIC COMMUNICATIONS NETWORKS; MOBILE TELEPHONE COMMUNICATION; PROVIDING ON-LINE COMMUNICATIONS LINKS WHICH TRANSFER THE WEBSITE USER TO OTHER LOCAL AND GLOBAL WEB PAGES; PROVIDING PRIVATE AND SECURE REAL TIME ELECTRONIC COMMUNICATION OVER A COMPUTER NETWORK; PROVIDING VOICE COMMUNICATION SERVICES VIA THE INTERNET; SIGNAL TRANSMISSION FOR ELECTRONIC COMMERCE VIA TELECOMMUNICATION SYSTEMS AND DATA COMMUNICATION SYSTEMS; TELECOMMUNICATIONS SERVICES, NAMELY, PERSONAL COMMUNICATION SERVICES; TELEPHONE COMMUNICATION SERVICES (U.S. CLS. 100, 101 AND 104).

JOHN WILKE, EXAMINING ATTORNEY

CLASS 38—(Continued).

SN 78-726,634. GREAT MEDIA TECHNOLOGIES PVT. LTD.,
KOLKATA, INDIA, FILED 10-5-2005.



NO CLAIM IS MADE TO THE EXCLUSIVE RIGHT TO USE "DEBT CONSOLIDATION", APART FROM THE MARK AS SHOWN.

THE COLOR(S) BLACK, ORANGE, GREEN, WHITE IS/ARE CLAIMED AS A FEATURE OF THE MARK.

THE COLOR(S) GREEN APPEARS IN THE CONTOUR OF THE PIGEON, THE COLOR ORANGE APPEARS IN THE TERM CONSOLIDATION, THE COLOR BLACK APPEARS IN THE TERMS DEBT AND CARE AND THE COLOR WHITE APPEARS IN THE BACKGROUND IS/ARE CLAIMED AS A FEATURE OF THE MARK.

THE MARK CONSISTS OF A FLYING PIGEON HAVING GREEN BODY.

FOR PROVIDING ON-LINE COMMUNICATIONS LINKS WHICH TRANSFER THE WEBSITE USER TO OTHER LOCAL AND GLOBAL WEB PAGES (U.S. CLS. 100, 101 AND 104).

FIRST USE 6-1-2005; IN COMMERCE 6-1-2005.
SALLY SHIH, EXAMINING ATTORNEY

SN 78-727,311. E.I. PARTNERS, HOUSTON, TX. FILED 10-5-2005.

DIGIPHONE

THE MARK CONSISTS OF STANDARD CHARACTERS WITHOUT CLAIM TO ANY PARTICULAR FONT, STYLE, SIZE, OR COLOR.

FOR TELECOMMUNICATION SERVICES, NAMELY, MOBILE AND INTERNET TELEPHONY SERVICES, ELECTRONIC TRANSMISSION OF MESSAGES, DATA, IMAGES, VIDEO AND DATABASE INFORMATION ON-LINE OR VIA THE INTERNET; ON LINE SERVICES, NAMELY, PROVIDING INFORMATION VIA LOCAL AND GLOBAL COMPUTER NETWORKS IN THE FIELD OF TELECOMMUNICATIONS AND TELEPHONY SERVICES (U.S. CLS. 100, 101 AND 104).

LOURDES AYALA, EXAMINING ATTORNEY

CLASS 38—(Continued).

SN 78-754,968. ZANA NETWORK INC., BIRMINGHAM, MI. FILED 11-16-2005.

ZANA

THE MARK CONSISTS OF STANDARD CHARACTERS WITHOUT CLAIM TO ANY PARTICULAR FONT, STYLE, SIZE, OR COLOR.

THE NAME(S), PORTRAIT(S), AND/OR SIGNATURE(S) SHOWN IN THE MARK DOES NOT IDENTIFY A PARTICULAR LIVING INDIVIDUAL.

FOR CABLE TELEVISION BROADCASTING RELATED TO BUSINESS ACTIVITIES (U.S. CLS. 100, 101 AND 104).

ALICIA COLLINS, EXAMINING ATTORNEY

SN 78-762,360. FAR EAST BROADCASTING COMPANY, LA MIRADA, CA. FILED 11-29-2005.

FAR EAST BROADCASTING
COMPANY

THE MARK CONSISTS OF STANDARD CHARACTERS WITHOUT CLAIM TO ANY PARTICULAR FONT, STYLE, SIZE, OR COLOR.

NO CLAIM IS MADE TO THE EXCLUSIVE RIGHT TO USE "BROADCASTING COMPANY", APART FROM THE MARK AS SHOWN.

SEC. 2(F).
FOR RADIO BROADCASTING SERVICES FEATURING RELIGIOUS BROADCASTS (U.S. CLS. 100, 101 AND 104).

FIRST USE 12-31-1945; IN COMMERCE 12-31-1945.
MARY MUNSON, EXAMINING ATTORNEY

CLASS 38—(Continued).

SN 78-768,788. JACKSON ENERGY AUTHORITY, JACKSON, TN. FILED 12-7-2005.



NO CLAIM IS MADE TO THE EXCLUSIVE RIGHT TO USE "JACKSON", APART FROM THE MARK AS SHOWN.

THE MARK CONSISTS OF "E+" ON TOP OF A SQUARE WITH THE LETTERS "TV" UNDERNEATH AND THE NUMBER "6" NEXT TO IT WITH THE WORD "JACKSON" UNDERNEATH, ALL INSIDE A SQUARE BOX WITH ROUNDED EDGES.

FOR TELEVISION BROADCASTING SERVICES; CABLE TELEVISION, SATELLITE TELEVISION, TERRESTRIAL TELEVISION AND RADIO TRANSMISSION SERVICES; TELEVISION BROADCASTING; TRANSMISSION OF MESSAGES OVER ELECTRONIC MEDIA (U.S. CLS. 100, 101 AND 104).

FIRST USE 11-0-2004; IN COMMERCE 11-0-2004.
INGA ERVIN, EXAMINING ATTORNEY

SN 78-772,669. CBS RADIO KFRC-FM, INC., NEW YORK, NY. FILED 12-13-2005.

YOUR LIFE. YOUR MUSIC.

THE MARK CONSISTS OF STANDARD CHARACTERS WITHOUT CLAIM TO ANY PARTICULAR FONT, STYLE, SIZE, OR COLOR.

NO CLAIM IS MADE TO THE EXCLUSIVE RIGHT TO USE "MUSIC", APART FROM THE MARK AS SHOWN.
FOR RADIO BROADCASTING SERVICES (U.S. CLS. 100, 101 AND 104).

FIRST USE 9-2-2005; IN COMMERCE 9-2-2005.
HEATHER THOMPSON, EXAMINING ATTORNEY

CLASS 38—(Continued).

SN 78-772,672. CBS RADIO STATIONS INC., NEW YORK, NY. FILED 12-13-2005.

RED 102.3

THE MARK CONSISTS OF STANDARD CHARACTERS WITHOUT CLAIM TO ANY PARTICULAR FONT, STYLE, SIZE, OR COLOR.

NO CLAIM IS MADE TO THE EXCLUSIVE RIGHT TO USE "102.3", APART FROM THE MARK AS SHOWN.

FOR RADIO BROADCASTING SERVICES (U.S. CLS. 100, 101 AND 104).

FIRST USE 4-13-2004; IN COMMERCE 4-13-2004.

HEATHER THOMPSON, EXAMINING ATTORNEY

SN 78-780,129. APLOGICA, INC., ALLENDALE, NJ. FILED 12-23-2005.

DEALSMAN

THE MARK CONSISTS OF STANDARD CHARACTERS WITHOUT CLAIM TO ANY PARTICULAR FONT, STYLE, SIZE, OR COLOR.

FOR PROVIDING ON-LINE FORUMS FOR TRANSMISSION OF MESSAGES AMONG COMPUTER USERS CONCERNING ON-LINE SHOPPING (U.S. CLS. 100, 101 AND 104).

FIRST USE 2-1-2004; IN COMMERCE 2-1-2004.

DAVID TAYLOR, EXAMINING ATTORNEY

SN 78-790,828. MUTILMEDIA TELESYS, INC., TEMPE, AZ. FILED 1-12-2006.



FOR PROVIDE ACCESS TO A CLOSED TELECOMMUNICATION NETWORK FEATURING AUDIO AND VIDEO COMMUNICATIONS BETWEEN THE SUBSCRIBER AND A DESIGNATED SITE (U.S. CLS. 100, 101 AND 104).

FIRST USE 12-31-1999; IN COMMERCE 12-31-1999.

ODESSA BIBBINS, EXAMINING ATTORNEY

CLASS 38—(Continued).

SN 78-809,550. LUGINBUHL, RYAN D., SAINT LOUIS, MO. FILED 2-7-2006.

This Week in Medical School

THE MARK CONSISTS OF STANDARD CHARACTERS WITHOUT CLAIM TO ANY PARTICULAR FONT, STYLE, SIZE, OR COLOR.

NO CLAIM IS MADE TO THE EXCLUSIVE RIGHT TO USE "MEDICAL SCHOOL", APART FROM THE MARK AS SHOWN.

FOR PODCASTING SERVICES, NAMELY, PROVIDING A PODCAST ABOUT MEDICINE, MEDICAL SCHOOL AND MEDICAL STUDENTS CONTAINING, BUT NOT LIMITED TO, NEWS, INTERVIEWS, AND CREATIVE PIECES (U.S. CLS. 100, 101 AND 104).

FIRST USE 8-1-2005; IN COMMERCE 12-15-2005.

KATHERINE E. HALMEN, EXAMINING ATTORNEY

SN 78-811,899. IMPSAT USA, INC., WILTON MANORS, FL. FILED 2-10-2006.

Think>Ahead

OWNER OF U.S. REG. NOS. 2,316,106, 2,328,574 AND OTHERS.

FOR TELECOMMUNICATIONS SERVICES, NAMELY, LOCAL AND LONG DISTANCE TRANSMISSION OF VOICE, DATA, GRAPHICS BY MEANS OF TELEPHONE, TELEGRAPHIC, CABLE, AND SATELLITE TRANSMISSIONS (U.S. CLS. 100, 101 AND 104).

FIRST USE 3-31-2003; IN COMMERCE 3-31-2003.

WENDY JUN, EXAMINING ATTORNEY

SN 78-814,175. DEALERON, INC, ROCKVILLE, MD. FILED 2-14-2006.

CALLPROSPECTOR

THE MARK CONSISTS OF STANDARD CHARACTERS WITHOUT CLAIM TO ANY PARTICULAR FONT, STYLE, SIZE, OR COLOR.

FOR TELECOMMUNICATION SERVICES, NAMELY, THE AUTOMATIC ROUTING OF EMAIL LEADS OR SALES INQUIRES INTO PHONE CALLS THAT ATTEMPT TO INSTANTLY CONNECT THE BUSINESS TO THE CONSUMER (U.S. CLS. 100, 101 AND 104).

FIRST USE 6-1-2005; IN COMMERCE 7-1-2005.

DAVID MURRAY, EXAMINING ATTORNEY

CLASS 38—(Continued).

SN 78-839,607. TANDBERG TELEVISION INC., DULUTH, GA. FILED 3-17-2006.

TELEVISIONARY

THE MARK CONSISTS OF STANDARD CHARACTERS WITHOUT CLAIM TO ANY PARTICULAR FONT, STYLE, SIZE, OR COLOR.

FOR PROVIDING HIGH-QUALITY, LIVE, ON-DEMAND AND INTERACTIVE TELEVISION TRANSMISSION SERVICES WITH ADVANCED COMPRESSION THROUGH DIGITAL VIDEO (U.S. CLS. 100, 101 AND 104).

RENEE MCCRAY, EXAMINING ATTORNEY

SN 78-839,609. TANDBERG TELEVISION INC., DULUTH, GA. FILED 3-17-2006.

WE'RE TELEVISIONARIES

THE MARK CONSISTS OF STANDARD CHARACTERS WITHOUT CLAIM TO ANY PARTICULAR FONT, STYLE, SIZE, OR COLOR.

FOR PROVIDING HIGH-QUALITY, LIVE, ON-DEMAND AND INTERACTIVE TELEVISION TRANSMISSION SERVICES WITH ADVANCED COMPRESSION THROUGH DIGITAL VIDEO (U.S. CLS. 100, 101 AND 104).

RENEE MCCRAY, EXAMINING ATTORNEY

SN 78-840,543. TURNER BROADCASTING SYSTEM, INC., ATLANTA, GA. FILED 3-17-2006.

SKREW

THE MARK CONSISTS OF STANDARD CHARACTERS WITHOUT CLAIM TO ANY PARTICULAR FONT, STYLE, SIZE, OR COLOR.

FOR TELECOMMUNICATION SERVICES, NAMELY, ELECTRONIC TRANSMISSION OF DATA, DOCUMENTS, MUSIC, VIDEOS, IMAGES, TEXT AND OTHER DATA VIA A GLOBAL COMPUTER NETWORK (U.S. CLS. 100, 101 AND 104).

MYRIAH HABEBE, EXAMINING ATTORNEY

CLASS 38—(Continued).

SN 78-845,222. TELEMUNDO OF LOS ANGELES, INC., BURBANK, CA. FILED 3-24-2006.



NO CLAIM IS MADE TO THE EXCLUSIVE RIGHT TO USE "LOS ANGELES", APART FROM THE MARK AS SHOWN.

THE MARK CONSISTS OF THE LETTERS KWHY-TV LOS ANGELES AND THE NUMBER 22 INSIDE A SUN DESIGN, FOR TELEVISION BROADCASTING (U.S. CLS. 100, 101 AND 104).

FIRST USE 11-30-2004; IN COMMERCE 11-30-2004.
INGA ERVIN, EXAMINING ATTORNEY

SN 78-846,894. PREMIER MEDIA SERVICES INC., MESA, AZ. FILED 3-27-2006.

Hot Chicks Stock Picks

THE MARK CONSISTS OF STANDARD CHARACTERS WITHOUT CLAIM TO ANY PARTICULAR FONT, STYLE, SIZE, OR COLOR.

NO CLAIM IS MADE TO THE EXCLUSIVE RIGHT TO USE STOCK PICKS, APART FROM THE MARK AS SHOWN.

FOR MOBILE MEDIA AND ENTERTAINMENT SERVICES IN THE NATURE OF ELECTRONIC TRANSMISSION OF ENTERTAINMENT MEDIA CONTENT; TRANSMISSION OF MESSAGES OVER ELECTRONIC MEDIA; TRANSMISSION OF STOCK MARKET INFORMATION WITH THE HELP OF TELECOMMUNICATION MEDIA (U.S. CLS. 100, 101 AND 104).

FRED CARL, EXAMINING ATTORNEY

CLASS 38—(Continued).

SN 78-854,401. ATARI INTERACTIVE, INC., NEW YORK, NY. FILED 4-5-2006.

ATARI COMMUNITY

THE MARK CONSISTS OF STANDARD CHARACTERS WITHOUT CLAIM TO ANY PARTICULAR FONT, STYLE, SIZE, OR COLOR.

OWNER OF U.S. REG. NOS. 1,050,153 AND 3,029,190.

NO CLAIM IS MADE TO THE EXCLUSIVE RIGHT TO USE "COMMUNITY", APART FROM THE MARK AS SHOWN.

THE ENGLISH TRANSLATION OF ATARI IS "SUCCESS" OR "LUCK."

FOR PROVIDING ON-LINE FORUMS AND ON-LINE CHAT ROOMS FOR THE TRANSMISSION OF MESSAGES AMONG COMPUTER USERS REGARDING VIDEO GAMES AND GAMING (U.S. CLS. 100, 101 AND 104).

FIRST USE 4-4-2006; IN COMMERCE 4-4-2006.

LAURIE MAYES, EXAMINING ATTORNEY

SN 78-854,948. AZTECA MOBILE, L.L.C., OVERLAND PARK, KS. FILED 4-5-2006.

TU MARCAS LAS REGLAS

THE MARK CONSISTS OF STANDARD CHARACTERS WITHOUT CLAIM TO ANY PARTICULAR FONT, STYLE, SIZE, OR COLOR.

THE FOREIGN WORDING IN THE MARK TRANSLATES INTO ENGLISH AS YOU DIAL THE RULES.

FOR TELECOMMUNICATIONS RESELLER SERVICES, NAMELY, PROVIDING LONG DISTANCE TELECOMMUNICATION SERVICES; CELLULAR TELEPHONE AND WIRELESS BROADBAND COMMUNICATIONS SERVICES; TWO-WAY RADIO COMMUNICATIONS SERVICES; AND TELECOMMUNICATIONS SERVICES PROVIDED VIA PREPAID CALLING CARDS (U.S. CLS. 100, 101 AND 104).

MICHAEL WIENER, EXAMINING ATTORNEY

SN 78-856,584. INFOTELIS CORP., CLEVELAND, OH. FILED 4-7-2006.

INFOTELIS

THE MARK CONSISTS OF STANDARD CHARACTERS WITHOUT CLAIM TO ANY PARTICULAR FONT, STYLE, SIZE, OR COLOR.

FOR INTERNET TELEPHONY SERVICES (U.S. CLS. 100, 101 AND 104).

FIRST USE 12-21-2005; IN COMMERCE 1-27-2006.

TANYA AMOS, EXAMINING ATTORNEY

CLASS 38—(Continued).

SN 78-856,848. CHUNG, NORMAN, LOS ANGELES, CA. FILED 4-7-2006.

BABBLEBUG

THE MARK CONSISTS OF STANDARD CHARACTERS WITHOUT CLAIM TO ANY PARTICULAR FONT, STYLE, SIZE, OR COLOR.

FOR TELECOMMUNICATIONS SERVICES, NAMELY, PERSONAL COMMUNICATION SERVICES; TELEPHONE TELECOMMUNICATIONS SERVICES PROVIDED VIA PREPAID TELEPHONE CALLING CARDS; VOICE OVER IP SERVICES (U.S. CLS. 100, 101 AND 104).

FIRST USE 2-1-2005; IN COMMERCE 2-1-2005.

BENJAMIN OKEKE, EXAMINING ATTORNEY

SN 78-858,291. BERMAN, BRUCE, A, ENCINO, CA. FILED 4-10-2006.

LIQUIDATION STATION

THE MARK CONSISTS OF STANDARD CHARACTERS WITHOUT CLAIM TO ANY PARTICULAR FONT, STYLE, SIZE, OR COLOR.

NO CLAIM IS MADE TO THE EXCLUSIVE RIGHT TO USE "STATION", APART FROM THE MARK AS SHOWN.

FOR TELEVISION PROGRAMME BROADCASTING VIA CABLE (U.S. CLS. 100, 101 AND 104).

DAVID COLLIER, EXAMINING ATTORNEY

SN 78-858,619. NETWORK ENTERPRISES, INC., NEW YORK, NY. FILED 4-11-2006.

GET MORE ACTION

THE MARK CONSISTS OF STANDARD CHARACTERS WITHOUT CLAIM TO ANY PARTICULAR FONT, STYLE, SIZE, OR COLOR.

FOR TELEVISION BROADCASTING SERVICES VIA CABLE, SATELLITE AND OTHER MEANS; CABLE RADIO BROADCASTING, CABLE RADIO TRANSMISSION; MOBILE RADIO COMMUNICATION; RADIO BROADCASTING; RADIO COMMUNICATION (U.S. CLS. 100, 101 AND 104).

IRENE D. WILLIAMS, EXAMINING ATTORNEY

CLASS 38—(Continued).

SN 78-859,374. VOXBONE, BRUSSELS, BELGIUM, FILED 4-11-2006.

VOXBONE

THE MARK CONSISTS OF STANDARD CHARACTERS WITHOUT CLAIM TO ANY PARTICULAR FONT, STYLE, SIZE, OR COLOR.

FOR TELECOMMUNICATION SERVICES, NAMELY VOICE OVER INTERNET PROTOCOL (VOIP) SERVICES (U.S. CLS. 100, 101 AND 104).

FIRST USE 1-10-2005; IN COMMERCE 1-10-2005.
REBECCA POVARCHUK, EXAMINING ATTORNEY

SN 78-860,181. CELLCO PARTNERSHIP, DBA VERIZON WIRELESS, BEDMINISTER, NJ. FILED 4-12-2006.

ELITE ACCESS

THE MARK CONSISTS OF STANDARD CHARACTERS WITHOUT CLAIM TO ANY PARTICULAR FONT, STYLE, SIZE, OR COLOR.

NO CLAIM IS MADE TO THE EXCLUSIVE RIGHT TO USE "ACCESS", APART FROM THE MARK AS SHOWN.

FOR WIRELESS TELECOMMUNICATIONS, NAMELY, WIRELESS PHONE SERVICES (U.S. CLS. 100, 101 AND 104).

ROBIN CHOSID, EXAMINING ATTORNEY

SN 78-860,594. COLEMAN RESEARCH, INC., MORRISVILLE, NC. FILED 4-13-2006.

FOUR DECADES FOUR SONGS

THE MARK CONSISTS OF STANDARD CHARACTERS WITHOUT CLAIM TO ANY PARTICULAR FONT, STYLE, SIZE, OR COLOR.

FOR RADIO BROADCASTING SERVICES (U.S. CLS. 100, 101 AND 104).

JOHN LINCOSKI, EXAMINING ATTORNEY

CLASS 38—(Continued).

SN 78-861,196. PHILLIPS, MARK, SEATTLE, WA. FILED 4-13-2006.



THE MARK CONSISTS OF TWO WORD BUBBLES, THE LEFT ONE SAYING HELLO IN A MASCULINE FONT, THE RIGHT ONE SAYING HELLO IN A FEMININE FONT.

FOR COMMUNICATIONS BY MOBILE PHONES (U.S. CLS. 100, 101 AND 104).

SUSAN LESLIE DUBOIS, EXAMINING ATTORNEY

SN 78-862,499. FAMILY FRIENDLY RADIO, INC., CLEVELAND, OH. FILED 4-17-2006.



THE MARK CONSISTS OF A BLACK AND WHITE BOWL AND SPOON WITH THE TEXT, "SOUP DU JOUR".

FOR RADIO PROGRAM BROADCASTING (U.S. CLS. 100, 101 AND 104).

FIRST USE 10-1-2003; IN COMMERCE 11-1-2003.
TIMOTHY FINNEGAN, EXAMINING ATTORNEY

CLASS 38—(Continued).

SN 78-862,556. PROTECTION ONE ALARM MONITORING, INC., IRVING, TX. FILED 4-17-2006.

ALWAYS P1

THE MARK CONSISTS OF STANDARD CHARACTERS WITHOUT CLAIM TO ANY PARTICULAR FONT, STYLE, SIZE, OR COLOR.

FOR ELECTRONIC TRANSMISSION OF MESSAGES AND DATA BY MEANS OF WIRELESS SERVICES AND WIRELINE SERVICES THROUGH A GLOBAL COMPUTER INFORMATION NETWORK, NAMELY, TRANSFER OF INFORMATION AND USER DEFINED DATA RELATED TO THE MANAGEMENT AND MONITORING OF COMMERCIAL AND RESIDENTIAL SECURITY AND PROPERTY AUTOMATION SYSTEMS, NAMELY, LIGHTING, APPLIANCES, SPRINKLER SYSTEMS, POWER, HEATING, VENTILATION AND AIR CONDITIONING (HVAC), VIDEO CAMERAS, VIDEO MONITORS, SMOKE DETECTORS, FIRE DETECTORS, CARBON MONOXIDE DETECTORS, FLOOD DETECTORS, TEMPERATURE SENSORS, MOTION SENSORS, VIBRATION SENSORS, ACCESS SENSORS AND ENTRY SENSORS (U.S. CLS. 100, 101 AND 104).

CHRISTOPHER BUONGIORNO, EXAMINING ATTORNEY

SN 78-864,100. PODTIPPETS LLC, BOULDER, CO. FILED 4-18-2006.

PodTippets

THE MARK CONSISTS OF STANDARD CHARACTERS WITHOUT CLAIM TO ANY PARTICULAR FONT, STYLE, SIZE, OR COLOR.

FOR PROVIDING ELECTRONIC TRANSMISSION OF AUDIO AND VIDEO MATERIAL, NAMELY, VOICE, DATA, IMAGES, SIGNALS AND MESSAGES VIA THE INTERNET; BROADCASTING OR STREAMING OF VIDEO MATERIAL OVER THE INTERNET, AND PODCASTING SERVICES (U.S. CLS. 100, 101 AND 104).

FIRST USE 2-0-2006; IN COMMERCE 2-0-2006.
TONI HICKEY, EXAMINING ATTORNEY

CLASS 38—(Continued).

SN 78-864,602. QUANTUM NY, LLC, NEW YORK, NY. FILED 4-19-2006.

MY-IN.COM

THE MARK CONSISTS OF STANDARD CHARACTERS WITHOUT CLAIM TO ANY PARTICULAR FONT, STYLE, SIZE, OR COLOR.

FOR COMMUNICATION SERVICES, NAMELY PROVIDING AUDITION AND JOB ALERTS FOR CELLULAR PHONES AND PERSONAL HANDHELD COMPUTERS; PROVIDING ONLINE CHAT ROOMS AND ELECTRONIC BULLETIN BOARDS FOR TRANSMISSION OF MESSAGES AMONG USERS CONCERNING THE ENTERTAINMENT INDUSTRY (U.S. CLS. 100, 101 AND 104).

FIRST USE 4-17-2006; IN COMMERCE 4-17-2006.
TINA L. SNAPP, EXAMINING ATTORNEY

SN 78-864,677. HENDRICK, NILS, CONCORD, CA. FILED 4-19-2006.

BOWDY

THE MARK CONSISTS OF STANDARD CHARACTERS WITHOUT CLAIM TO ANY PARTICULAR FONT, STYLE, SIZE, OR COLOR.

FOR ELECTRONIC MAIL SERVICES (U.S. CLS. 100, 101 AND 104).

FIRST USE 3-15-2006; IN COMMERCE 3-15-2006.
CATHERINE FAINT, EXAMINING ATTORNEY

SN 78-865,086. EWAN 1, INC., SANTA ANA, CA. FILED 4-19-2006.

EWAND

THE MARK CONSISTS OF STANDARD CHARACTERS WITHOUT CLAIM TO ANY PARTICULAR FONT, STYLE, SIZE, OR COLOR.

FOR STREAMING OF MEDIA VIA THE INTERNET (U.S. CLS. 100, 101 AND 104).

PAULA MAYS, EXAMINING ATTORNEY

CLASS 38—(Continued).

SN 78-865,181. DIRECTV, INC., EL SEGUNDO, CA. FILED 4-19-2006.

GET THE BEST

THE MARK CONSISTS OF STANDARD CHARACTERS WITHOUT CLAIM TO ANY PARTICULAR FONT, STYLE, SIZE, OR COLOR.

FOR BROADCASTING PROGRAMS VIA A GLOBAL COMPUTER NETWORK; BROADCASTING SERVICES AND PROVISION OF TELECOMMUNICATION ACCESS TO FILMS AND TV PROGRAMMES PROVIDED VIA A VIDEO-ON-DEMAND SERVICE; COMMUNICATIONS SERVICES, NAMELY, TRANSMITTING STREAMED SOUND AND AUDIO-VISUAL RECORDINGS VIA THE INTERNET; DELIVERY OF MESSAGES BY ELECTRONIC TRANSMISSION; ELECTRONIC MAIL SERVICES; ELECTRONIC TRANSMISSION OF MESSAGES AND DATA; ELECTRONIC, ELECTRIC, AND DIGITAL TRANSMISSION OF VOICE, DATA, IMAGES, SIGNALS, AND MESSAGES; INSTANT MESSAGING SERVICES; PAY-PER-VIEW TELEVISION TRANSMISSION SERVICES; PROVIDING MULTIPLE-USER ACCESS TO A GLOBAL COMPUTER INFORMATION NETWORK; SATELLITE TELEVISION BROADCASTING; SATELLITE TRANSMISSION SERVICES; SATELLITE, CABLE, NETWORK TRANSMISSION OF SOUNDS, IMAGES, SIGNALS AND DATA; TELEMATIC SENDING OF INFORMATION; TRANSMISSION OF DATA, SOUND AND IMAGES BY SATELLITE; TRANSMISSION OF SOUND AND VISION VIA SATELLITE OR INTERACTIVE MULTIMEDIA NETWORKS; VIDEO BROADCASTING; VIDEO-ON-DEMAND TRANSMISSION SERVICES (U.S. CLS. 100, 101 AND 104).

NORA BUCHANAN WILL, EXAMINING ATTORNEY

CLASS 38—(Continued).

SN 78-866,024. DIRECTV, INC., EL SEGUNDO, CA. FILED 4-20-2006.

TURN ON THE BEST

THE MARK CONSISTS OF STANDARD CHARACTERS WITHOUT CLAIM TO ANY PARTICULAR FONT, STYLE, SIZE, OR COLOR.

FOR BROADCASTING PROGRAMS VIA A GLOBAL COMPUTER NETWORK; BROADCASTING SERVICES AND PROVISION OF TELECOMMUNICATION ACCESS TO FILMS AND TV PROGRAMMES PROVIDED VIA A VIDEO-ON-DEMAND SERVICE; COMMUNICATIONS SERVICES, NAMELY, TRANSMITTING STREAMED SOUND AND AUDIO-VISUAL RECORDINGS VIA THE INTERNET; DELIVERY OF MESSAGES BY ELECTRONIC TRANSMISSION; ELECTRONIC MAIL SERVICES; ELECTRONIC TRANSMISSION OF MESSAGES AND DATA; ELECTRONIC, ELECTRIC, AND DIGITAL TRANSMISSION OF VOICE, DATA, IMAGES, SIGNALS, AND MESSAGES; INSTANT MESSAGING SERVICES; PAY-PER-VIEW TELEVISION TRANSMISSION SERVICES; PROVIDING MULTIPLE-USER ACCESS TO A GLOBAL COMPUTER INFORMATION NETWORK; SATELLITE TELEVISION BROADCASTING; SATELLITE TRANSMISSION SERVICES; SATELLITE, CABLE, NETWORK TRANSMISSION OF SOUNDS, IMAGES, SIGNALS AND DATA; TELEMATIC SENDING OF INFORMATION; TRANSMISSION OF DATA, SOUND AND IMAGES BY SATELLITE; TRANSMISSION OF SOUND AND VISION VIA SATELLITE OR INTERACTIVE MULTIMEDIA NETWORKS; VIDEO BROADCASTING; VIDEO-ON-DEMAND TRANSMISSION SERVICES (U.S. CLS. 100, 101 AND 104).

NORA BUCHANAN WILL, EXAMINING ATTORNEY

SN 78-865,869. ASSOCIATED NETWORK PARTNERS, INC., SPRINGFIELD, IL. FILED 4-20-2006.

SMARTPIC

THE MARK CONSISTS OF STANDARD CHARACTERS WITHOUT CLAIM TO ANY PARTICULAR FONT, STYLE, SIZE, OR COLOR.

FOR TELECOMMUNICATIONS SERVICES, NAMELY, AUTOMATIC NUMBER IDENTIFICATION CODE INFORMATION ACTIVATION, AND PER MESSAGE CALL ROUTING (U.S. CLS. 100, 101 AND 104).

SARAH WAYDA, EXAMINING ATTORNEY

SN 78-866,451. POND, JACOB, C, CHICAGO, IL. FILED 4-21-2006.

Stretch the Weekend

THE MARK CONSISTS OF STANDARD CHARACTERS WITHOUT CLAIM TO ANY PARTICULAR FONT, STYLE, SIZE, OR COLOR.

FOR MOBILE MEDIA AND ENTERTAINMENT SERVICES IN THE NATURE OF ELECTRONIC TRANSMISSION OF ENTERTAINMENT MEDIA CONTENT (U.S. CLS. 100, 101 AND 104).

CHRISTOPHER BUONGIORNO, EXAMINING ATTORNEY

CLASS 38—(Continued).

SN 78-868,195. USFR MEDIA GROUP INC., HOUSTON, TX. FILED 4-24-2006.



NO CLAIM IS MADE TO THE EXCLUSIVE RIGHT TO USE "AMERICA" AND "TELEVISION NETWORK", APART FROM THE MARK AS SHOWN.

THE MARK CONSISTS OF THE WORDS "AMERICA ONE" ABOVE A CURVED BRUSH STROKE, WITH THE WORDS "TELEVISION NETWORK" BELOW THE CURVED BRUSH STROKE.

FOR TELEVISION BROADCASTING (U.S. CLS. 100, 101 AND 104).

FIRST USE 6-30-2003; IN COMMERCE 6-30-2003. CHRISTOPHER BUONGIORNO, EXAMINING ATTORNEY

SN 78-868,198. USFR MEDIA GROUP INC., HOUSTON, TX. FILED 4-24-2006.



NO CLAIM IS MADE TO THE EXCLUSIVE RIGHT TO USE "AMERICA" AND "SPORTS", APART FROM THE MARK AS SHOWN.

THE MARK CONSISTS OF THE WORDS "AMERICA ONE" ABOVE A CURVED BRUSH STROKE, WITH THE WORD "SPORTS" BELOW THE CURVED BRUSH STROKE.

FOR TELEVISION BROADCASTING (U.S. CLS. 100, 101 AND 104).

FIRST USE 6-30-2003; IN COMMERCE 6-30-2003. CHRISTOPHER BUONGIORNO, EXAMINING ATTORNEY

SN 78-868,363. QWEST COMMUNICATIONS INTERNATIONAL INC., DENVER, CO. FILED 4-24-2006.

Q ROUTING

THE MARK CONSISTS OF STANDARD CHARACTERS WITHOUT CLAIM TO ANY PARTICULAR FONT, STYLE, SIZE, OR COLOR.

NO CLAIM IS MADE TO THE EXCLUSIVE RIGHT TO USE "ROUTING", APART FROM THE MARK AS SHOWN.

FOR TELECOMMUNICATIONS SERVICES, NAMELY, CALL ROUTING SERVICES (U.S. CLS. 100, 101 AND 104).

FIRST USE 8-31-2004; IN COMMERCE 8-31-2004. MARGARET POWER, EXAMINING ATTORNEY

CLASS 38—(Continued).

SN 78-868,430. GETTY IMAGES, INC., SEATTLE, WA. FILED 4-24-2006.

PICTURECAST

THE MARK CONSISTS OF STANDARD CHARACTERS WITHOUT CLAIM TO ANY PARTICULAR FONT, STYLE, SIZE, OR COLOR.

FOR TELECOMMUNICATIONS SERVICES, NAMELY, COMMUNICATION VIA A GLOBAL COMPUTER NETWORK, WIRED AND WIRELESS NETWORKS; TELECOMMUNICATIONS SERVICES, NAMELY, STREAMING OF IMAGES, AUDIO, TEXT, AND VIDEO CONTENT VIA A GLOBAL COMPUTER NETWORK, WIRED AND WIRELESS NETWORKS; BROADCASTING PROGRAMS TO MOBILE TELEPHONES AND OTHER WIRELESS COMMUNICATION DEVICES; ELECTRONIC TRANSMISSION OF NEWS TO MOBILE TELEPHONES AND OTHER WIRELESS COMMUNICATION DEVICES (U.S. CLS. 100, 101 AND 104).

MARY MUNSON, EXAMINING ATTORNEY

SN 78-869,055. DIVORCE OF COURSE LLC, SUMMIT, NJ. FILED 4-25-2006.

Rid Your Spouse From Your House

THE MARK CONSISTS OF STANDARD CHARACTERS WITHOUT CLAIM TO ANY PARTICULAR FONT, STYLE, SIZE, OR COLOR.

FOR INFORMATION TRANSMISSION VIA ELECTRONIC COMMUNICATIONS NETWORKS; PROVIDING ON-LINE CHAT ROOMS AND ELECTRONIC BULLETIN BOARDS FOR TRANSMISSION OF MESSAGES AMONG USERS IN THE FIELD OF GENERAL INTEREST; PROVIDING ON-LINE CHAT ROOMS FOR TRANSMISSION OF MESSAGES AMONG COMPUTER USERS CONCERNING RELATIONSHIPS AND DIVORCE; PROVIDING ON-LINE COMMUNICATIONS LINKS WHICH TRANSFER THE WEBSITE USER TO OTHER LOCAL AND GLOBAL WEB PAGES; PROVIDING ON-LINE FORUMS FOR TRANSMISSION OF MESSAGES AMONG COMPUTER USERS CONCERNING RELATIONSHIPS AND DIVORCE; PROVIDING ON-LINE LISTSERVERS FOR TRANSMISSION OF MESSAGES AMONG COMPUTER USERS CONCERNING RELATIONSHIPS AND DIVORCE; TRANSMISSION OF INFORMATION VIA NATIONAL AND INTERNATIONAL NETWORKS (U.S. CLS. 100, 101 AND 104).

FIRST USE 4-10-2006; IN COMMERCE 4-10-2006. PAUL E. FAHRENKOPF, EXAMINING ATTORNEY

CLASS 38—(Continued).

SN 78-869,414. INLAND TELEPHONE COMPANY, ROSLYN, WA. FILED 4-25-2006.

Your Hometown Connection

THE MARK CONSISTS OF STANDARD CHARACTERS WITHOUT CLAIM TO ANY PARTICULAR FONT, STYLE, SIZE, OR COLOR.

FOR LOCAL AND LONG DISTANCE TELEPHONE SERVICES (U.S. CLS. 100, 101 AND 104).
ROBIN CHOSID, EXAMINING ATTORNEY

SN 78-870,612. LUCIDUX SOLUTIONS INCORPORATED, MIAMI, FL. FILED 4-26-2006.

FIESTAPLEX

THE MARK CONSISTS OF STANDARD CHARACTERS WITHOUT CLAIM TO ANY PARTICULAR FONT, STYLE, SIZE, OR COLOR.

FOR COMMUNICATIONS SERVICES, NAMELY, TRANSMITTING STREAMED SOUND AND AUDIO-VISUAL RECORDINGS VIA THE INTERNET; RADIO BROADCASTING; RADIO BROADCASTING OF INFORMATION AND OTHER PROGRAMS; RADIO PROGRAM BROADCASTING; RADIO PROGRAMME BROADCASTING; STREAMING OF AUDIO MATERIAL ON THE INTERNET; STREAMING OF VIDEO MATERIAL ON THE INTERNET (U.S. CLS. 100, 101 AND 104).
JASON ROTH, EXAMINING ATTORNEY

SN 78-871,600. DRIVER'S NETWORK LLC, ALBUQUERQUE, NM. FILED 4-27-2006.

LIVETRUCKER.COM

THE MARK CONSISTS OF STANDARD CHARACTERS WITHOUT CLAIM TO ANY PARTICULAR FONT, STYLE, SIZE, OR COLOR.

FOR STREAMING OF VIDEO MATERIAL ON THE INTERNET (U.S. CLS. 100, 101 AND 104).
BARBARA A. LOUGHRAN, EXAMINING ATTORNEY

CLASS 38—(Continued).

SN 78-872,061. JOIPHONE LLC, DELRAY BEACH, FL. FILED 4-28-2006.

JOIPHONE

THE MARK CONSISTS OF STANDARD CHARACTERS WITHOUT CLAIM TO ANY PARTICULAR FONT, STYLE, SIZE, OR COLOR.

OWNER OF U.S. REG. NO. 2,711,466.
FOR PROVIDING VOICE COMMUNICATION SERVICES VIA THE INTERNET (U.S. CLS. 100, 101 AND 104).
WENDY JUN, EXAMINING ATTORNEY

SN 78-872,209. BELL SOUTH INTELLECTUAL PROPERTY CORPORATION, WILMINGTON, DE. FILED 4-28-2006.

ENHANCED ANSWERS

THE MARK CONSISTS OF STANDARD CHARACTERS WITHOUT CLAIM TO ANY PARTICULAR FONT, STYLE, SIZE, OR COLOR.

FOR TELECOMMUNICATIONS SERVICES, NAMELY, PROVIDING TRANSMISSION OF VOICE, DATA, FACSIMILE AND VIDEO VIA COMPUTER, TELEVISION AND TELECOMMUNICATIONS NETWORKS; WIRELINE AND WIRELESS COMMUNICATION TRANSMISSION SERVICES; CUSTOM CALLING SERVICES FOR CONSUMERS AND BUSINESS; VOICE AND DATA MESSAGING STORE AND FORWARD SERVICES; VOICE AND VIDEO CONFERENCING SERVICES; TELECOMMUNICATIONS GATEWAY SERVICES FOR PROVIDING ACCESS TO GLOBAL COMPUTER COMMUNICATIONS NETWORKS, ELECTRONIC TRANSMISSION OF DATA, SOUND, TEXT AND IMAGE MESSAGES, AND VIDEO TRANSMISSION SERVICES; CELLULAR TELEPHONE SERVICES; PAGING SERVICES, TELEPHONE COMMUNICATION SERVICES; CABLE TELEVISION TRANSMISSION SERVICES; SATELLITE TELEVISION TRANSMISSION SERVICES ANALOG AND DIGITAL TELEVISION TRANSMISSION SERVICES, TELEVISION BROADCASTING SERVICES; PROVIDING MULTIPLE USER ACCESS TO GLOBAL COMPUTER INFORMATION NETWORKS (U.S. CLS. 100, 101 AND 104).
NORA BUCHANAN WILL, EXAMINING ATTORNEY

CLASS 38—(Continued).

SN 78-872,210. BELLSOUTH INTELLECTUAL PROPERTY CORPORATION, WILMINGTON, DE. FILED 4-28-2006.

IT'S YOUR NUMBER

THE MARK CONSISTS OF STANDARD CHARACTERS WITHOUT CLAIM TO ANY PARTICULAR FONT, STYLE, SIZE, OR COLOR.

FOR TELECOMMUNICATION SERVICES, NAMELY CALL FORWARDING SERVICES (U.S. CLS. 100, 101 AND 104).

NORA BUCHANAN WILL, EXAMINING ATTORNEY



SN 78-877,359. VARSITY SPIRIT CORPORATION, MEMPHIS, TN. FILED 5-5-2006.

WE ARE CHEERLEADING

THE MARK CONSISTS OF STANDARD CHARACTERS WITHOUT CLAIM TO ANY PARTICULAR FONT, STYLE, SIZE, OR COLOR.

FOR TELEVISION BROADCASTING (U.S. CLS. 100, 101 AND 104).

KENNETH E. SHARPERSON, EXAMINING ATTORNEY



SN 78-883,612. GLOBAL CROSSING TELECOMMUNICATIONS, INC., BINGHAM FARMS, MI. FILED 5-15-2006.

CONFERCALL

THE MARK CONSISTS OF STANDARD CHARACTERS WITHOUT CLAIM TO ANY PARTICULAR FONT, STYLE, SIZE, OR COLOR.

FOR TELECONFERENCING SERVICES (U.S. CLS. 100, 101 AND 104).

HOWARD B. LEVINE, EXAMINING ATTORNEY

CLASS 38—(Continued).

SN 78-883,838. HEALTHSIMPLE TOOLS, LLC, MINNEAPOLIS, MN. FILED 5-15-2006.

HEALTHSIMPLE

THE MARK CONSISTS OF STANDARD CHARACTERS WITHOUT CLAIM TO ANY PARTICULAR FONT, STYLE, SIZE, OR COLOR.

FOR TELECOMMUNICATIONS SERVICES, NAMELY, TELEPHONE COMMUNICATIONS SERVICES AND DELIVERY OF MESSAGES BY ELECTRONIC MAIL; AND PROVIDING ON-LINE ELECTRONIC BULLETIN BOARDS FOR THE TRANSMISSION OF MESSAGES AMONG COMPUTER USERS; PROVIDING AN INTERACTIVE CHAT ROOM FOR TRANSMISSION OF MESSAGES IN THE FIELDS OF HEALTH AND NUTRITION; PROVIDING ONLINE CHAT ROOM AND BULLETIN BOARD SERVICES FEATURING DISCUSSIONS OF HEALTH AND NUTRITION; BROADCASTING AND DELIVERY OF AUDIO, VIDEO AND MULTIMEDIA CONTENT BY MEANS OF CELLULAR, WIRELESS COMMUNICATIONS AND COMPUTER NETWORKS; ELECTRONIC TRANSMISSION OF DATA, IMAGES, DOCUMENTS AND MESSAGES VIA COMPUTER TERMINALS; ELECTRONIC DATA MESSAGING (U.S. CLS. 100, 101 AND 104).

RUDY R. SINGLETON, EXAMINING ATTORNEY



SN 78-893,050. DELPHI TECHNOLOGIES, INC., TROY, MI. FILED 5-25-2006.

DELPHI

THE MARK CONSISTS OF STANDARD CHARACTERS WITHOUT CLAIM TO ANY PARTICULAR FONT, STYLE, SIZE, OR COLOR.

FOR PROVISION OF WEBSITE TO ENABLE PHYSICIANS, HEALTHCARE WORKERS AND OTHER CAREGIVERS REMOTE CONNECTION TO PATIENT MONITORS (U.S. CLS. 100, 101 AND 104).

CHRISTINE COOPER, EXAMINING ATTORNEY

CLASS 38—(Continued).

SN 78-918,252. HOODLOVE LIMITED LIABILITY COMPANY, EAST ORANGE, NJ. FILED 6-27-2006.

HOOD LOVE

THE MARK CONSISTS OF STANDARD CHARACTERS WITHOUT CLAIM TO ANY PARTICULAR FONT, STYLE, SIZE, OR COLOR.

FOR COMMUNICATION BY MOBILE TELEPHONE; INTERNET CAFE SERVICES, NAMELY, PROVIDING TELECOMMUNICATIONS CONNECTIONS TO THE INTERNET IN A CAFE ENVIRONMENT; MOBILE MEDIA AND ENTERTAINMENT SERVICES IN THE NATURE OF ELECTRONIC TRANSMISSION OF ENTERTAINMENT MEDIA CONTENT (U.S. CLS. 100, 101 AND 104).
BARBARA BROWN, EXAMINING ATTORNEY

SN 78-935,694. VIACOM INTERNATIONAL INC., NEW YORK, NY. FILED 7-24-2006.

VMTV

THE MARK CONSISTS OF STANDARD CHARACTERS WITHOUT CLAIM TO ANY PARTICULAR FONT, STYLE, SIZE, OR COLOR.

FOR PROVIDING ON-LINE CHAT ROOMS FOR TRANSMISSION OF MESSAGES AMONG COMPUTER USERS CONCERNING THE TOPICS OF TELEVISION AND COMPUTER GAMING ENTERTAINMENT; PROVIDING ON-LINE ELECTRONIC BULLETIN BOARDS FOR TRANSMISSION OF MESSAGES AMONG COMPUTER USERS CONCERNING THE TOPICS OF TELEVISION AND COMPUTER GAMING ENTERTAINMENT (U.S. CLS. 100, 101 AND 104).

SUSAN RICHARDS, EXAMINING ATTORNEY

SN 78-935,697. VIACOM INTERNATIONAL INC., NEW YORK, NY. FILED 7-24-2006.

VLB

THE MARK CONSISTS OF STANDARD CHARACTERS WITHOUT CLAIM TO ANY PARTICULAR FONT, STYLE, SIZE, OR COLOR.

FOR PROVIDING ON-LINE CHAT ROOMS FOR TRANSMISSION OF MESSAGES AMONG COMPUTER USERS CONCERNING THE TOPICS OF TELEVISION AND COMPUTER GAMING ENTERTAINMENT; PROVIDING ON-LINE ELECTRONIC BULLETIN BOARDS FOR TRANSMISSION OF MESSAGES AMONG COMPUTER USERS CONCERNING THE TOPICS OF TELEVISION AND COMPUTER GAMING ENTERTAINMENT (U.S. CLS. 100, 101 AND 104).

SUSAN RICHARDS, EXAMINING ATTORNEY

CLASS 39—TRANSPORTATION AND STORAGE

SN 76-610,715. GRAFE UND UNZER VERLAG GMBH, D-81675 MUNICH, FED REP GERMANY, FILED 9-3-2004.



OWNER OF ERPN CMNTY TM OFC REG. NO. 988279, DATED 5-31-2000, EXPIRES 11-16-2008.

THE COLOR(S) BLACK AND GOLD IS/ARE CLAIMED AS A FEATURE OF THE MARK.

THE COLOR(S) GOLD IS USED IN THE BACKGROUND OF THE RECTANGLE AND THE COLOR BLACK IS USED FOR THE LETTERS AND THE VERTICAL LINE.

FOR TOURIST AND TRAVEL ORGANIZATION AND ARRANGEMENT; NAMELY, THE ORGANIZATION OF SIGHTSEEING TOURS, ESCORTING OF TOURS, ADVISING TOURISTS AND BUSINESS TRAVELERS IN THEIR CHOICE OF TRAVEL ROUTES AND SIGHTSEEING DESTINATIONS (U.S. CLS. 100 AND 105).

JERI J. FICKES, EXAMINING ATTORNEY

SN 76-641,348. AGNEW, DENNIS, BOCA RATON, FL. FILED 6-22-2005.

SUN LINE

THE MARK CONSISTS OF STANDARD CHARACTERS WITHOUT CLAIM TO ANY PARTICULAR FONT, STYLE, SIZE, OR COLOR.

NO CLAIM IS MADE TO THE EXCLUSIVE RIGHT TO USE "LINE", APART FROM THE MARK AS SHOWN.

FOR CRUISE SHIP SERVICES; TRAVEL INFORMATION SERVICES (U.S. CLS. 100 AND 105).

FIRST USE 3-0-2002; IN COMMERCE 3-0-2002.

REBECCA GAN, EXAMINING ATTORNEY

SN 76-661,248. DREAM DINNERS, INC., SNOHOMISH, WA. FILED 6-8-2006.

LIFE JUST GOT EASIER!

THE MARK CONSISTS OF STANDARD CHARACTERS WITHOUT CLAIM TO ANY PARTICULAR FONT, STYLE, SIZE, OR COLOR.

OWNER OF U.S. REG. NO. 2,816,395.

FOR FOOD DELIVERY TO THE GENERAL PUBLIC (U.S. CLS. 100 AND 105).

FIRST USE 8-1-2002; IN COMMERCE 8-1-2002.

JASON ROTH, EXAMINING ATTORNEY

CLASS 39—(Continued).

SN 78-578,154. SEMpra ENERGY, SAN DIEGO, CA. FILED 3-2-2005.



OWNER OF U.S. REG. NOS. 2,437,361, 2,858,908 AND OTHERS.

NO CLAIM IS MADE TO THE EXCLUSIVE RIGHT TO USE "GAS COMPANY" AND "ENERGY UTILITY", APART FROM THE MARK AS SHOWN.

THE COLOR(S) BLUE AND RED IS/ARE CLAIMED AS A FEATURE OF THE MARK.

THE RECTANGLE AND LITERAL ELEMENTS "SOUTHERN CALIFORNIA GAS COMPANY" AND "A SEMpra ENERGY UTILITY" APPEAR IN THE COLOR BLUE. THE CRESCENT AND THE FIGURE ARE IN RED AND THE STYLIZED FLAME HELD BY THE FIGURE IN THE CRESCENT APPEARS IN BLUE.

THE MARK CONSISTS OF TWO DESIGN ELEMENTS USED IN CONJUNCTION WITH THE PRINTED WORDS IN THIS MARK. THE FIRST IS A STYLIZED FLAME OUTLINED IN A RECTANGLE ADJACENT TO THE NAME "SOUTHERN CALIFORNIA GAS COMPANY". BENEATH THOSE COMPONENTS A CRESCENT AND FIGURE DESIGN APPEAR IN THE MIDDLE OF THE PHRASE "A SEMpra ENERGY UTILITY".

SEC. 2(F) AS TO "SOUTHERN CALIFORNIA".

FOR PUBLIC UTILITY SERVICES IN THE NATURE OF THE DISTRIBUTION OF ENERGY AND NATURAL GAS (U.S. CLS. 100 AND 105).

FIRST USE 12-31-2000; IN COMMERCE 12-31-2000.

DAHLIA GEORGE, EXAMINING ATTORNEY

CLASS 39—(Continued).

SN 78-665,491. ARPIN INTERNATIONAL GROUP, INC., EAST GREENWICH, RI. FILED 7-7-2005.

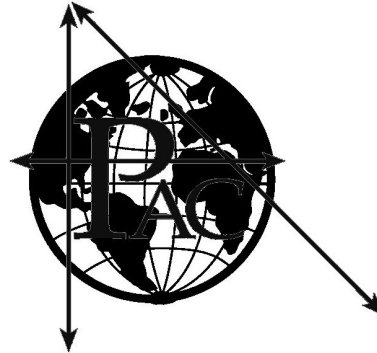

THE STIPLING IS FOR SHADING PURPOSES ONLY. THE MARK CONSISTS OF THE WORD PAC SUPERIMPOSED OVER A GLOBE WITH ARROWS.

FOR TRANSPORTATION AND MOVING SERVICES FOR OTHERS, NAMELY, THE TRANSPORTATION OF HOUSEHOLD AND COMMERCIAL GOODS AND SPECIALIZED TRANSPORT OF FRAGILE GOODS BY TRUCK OR VAN; PACKING AND PACKAGING OF GOODS FOR TRANSPORTATION FOR OTHERS; CUSTOMIZED SHIPPING SERVICES, NAMELY, PROVIDING CUSTOMIZED FREIGHT AND DISTRIBUTION VIA TRUCK TRANSPORTATION; WAREHOUSING SERVICES; TRANSPORTATION AND INVENTORY LOGISTIC CONSULTATION SERVICES FOR OTHERS ABOUT THE PACKING, TRANSPORT, WAREHOUSING AND STORAGE OF GOODS; WAREHOUSING AND STORAGE OF GOODS; FREIGHT FORWARDING, AND FREIGHT BROKERAGE SERVICES FOR OTHERS; PACKAGING ARTICLES FOR TRANSPORTATION, NAMELY, CRATING SERVICES (U.S. CLS. 100 AND 105).

FIRST USE 0-0-2000; IN COMMERCE 0-0-2000.

SHANNON TWOHIG, EXAMINING ATTORNEY

SN 78-686,724. CENTRAL CONCRETE SUPERMIX, INC., MIAMI, FL. FILED 8-5-2005.



THE COLOR(S) RED, WHITE AND GRAY IS/ARE CLAIMED AS A FEATURE OF THE MARK.

THE COLOR RED APPEARS IN THE DIAMOND DESIGN IN THE MARK. THE COLOR GRAY APPEARS IN THE RECTANGLE DESIGN IN THE MARK AND THE COLOR WHITE APPEARS IN THE WORDING SUPERBLOCK AND IN THE BACKGROUND OF THE MARK.

FOR DELIVERY BY TRUCK OF CONCRETE BLOCKS (U.S. CLS. 100 AND 105).

MONIQUE MILLER, EXAMINING ATTORNEY

CLASS 39—(Continued).

SN 78-705,242. STONE & WARD, INC., LITTLE ROCK, AR. FILED 9-1-2005.

Power Of Hope Fund

THE MARK CONSISTS OF STANDARD CHARACTERS WITHOUT CLAIM TO ANY PARTICULAR FONT, STYLE, SIZE, OR COLOR.

NO CLAIM IS MADE TO THE EXCLUSIVE RIGHT TO USE "FUND", APART FROM THE MARK AS SHOWN.

FOR PUBLIC UTILITY SERVICES IN THE NATURE OF ELECTRICITY DISTRIBUTION (U.S. CLS. 100 AND 105).

HEATHER THOMPSON, EXAMINING ATTORNEY

SN 78-714,236. LONGTAIL AVIATION LIMITED, HAMILTON, BERMUDA, FILED 9-15-2005.

LONGTAIL AVIATION

THE MARK CONSISTS OF STANDARD CHARACTERS WITHOUT CLAIM TO ANY PARTICULAR FONT, STYLE, SIZE, OR COLOR.

NO CLAIM IS MADE TO THE EXCLUSIVE RIGHT TO USE "AVIATION", APART FROM THE MARK AS SHOWN.

FOR TRANSPORTATION OF PASSENGERS AND GOODS BY AIR; AIR CHARTER TRANSPORTATION SERVICES; AIR AMBULANCE TRANSPORTATION; TRAVEL ARRANGEMENT, RESERVATION AND AIRLINE TICKETING SERVICES FOR CONSUMERS; PROVIDING TRAVEL OR TOUR INFORMATION RELATING TO AVIATION (U.S. CLS. 100 AND 105).

FIRST USE 2-18-2005; IN COMMERCE 2-18-2005.
ANGELA M. MICHELI, EXAMINING ATTORNEY

SN 78-716,398. ALASKA TRAVEL ADVENTURES, INC., JUNEAU, AK. FILED 9-20-2005.

Best of Alaska Day Tours & Attractions

THE MARK CONSISTS OF STANDARD CHARACTERS WITHOUT CLAIM TO ANY PARTICULAR FONT, STYLE, SIZE, OR COLOR.

SEC. 2(F).
FOR TRAVEL GUIDE SERVICES (U.S. CLS. 100 AND 105).

FIRST USE 3-1-2000; IN COMMERCE 3-1-2000.
BARBARA RUTLAND, EXAMINING ATTORNEY

CLASS 39—(Continued).

SN 78-732,417. RELOTEK, LLC, MONTCLAIR, NJ. FILED 10-13-2005.

MOVINGHUB.COM

THE MARK CONSISTS OF STANDARD CHARACTERS WITHOUT CLAIM TO ANY PARTICULAR FONT, STYLE, SIZE, OR COLOR.

FOR PROVIDING INFORMATION ABOUT RESIDENTIAL, COMMERCIAL AND INDUSTRIAL MOVING SERVICES OVER A GLOBAL COMPUTER NETWORK (U.S. CLS. 100 AND 105).

KATHY DE JONGE, EXAMINING ATTORNEY

SN 78-783,849. MARTEN TRANSPORT, LTD., MONDOVI, WI. FILED 1-3-2006.



FOR TRANSPORTATION SERVICES, NAMELY, TRANSPORTATION OF FREIGHT AND GOODS BY TRUCK AND RAIL; LOGISTICS SERVICES, NAMELY, ARRANGING, SCHEDULING, AND MONITORING THE TRANSPORTATION AND SHIPMENT OF FREIGHT; TRANSPORTATION BROKERAGE SERVICES (U.S. CLS. 100 AND 105).

FIRST USE 12-31-1985; IN COMMERCE 12-31-1985.
TASNEEM HUSSAIN, EXAMINING ATTORNEY

SN 78-813,703. PREMIER WORLD TOURS, LLC, REDONDO BEACH, CA. FILED 2-13-2006.

Premier World Tours

THE MARK CONSISTS OF STANDARD CHARACTERS WITHOUT CLAIM TO ANY PARTICULAR FONT, STYLE, SIZE, OR COLOR.

NO CLAIM IS MADE TO THE EXCLUSIVE RIGHT TO USE WORLD TOURS, APART FROM THE MARK AS SHOWN.

SEC. 2(F).
FOR ARRANGING FOR TRAVEL VISAS, PASSPORTS AND TRAVEL DOCUMENTS FOR PERSONS TRAVELING ABROAD; ARRANGING TRAVEL TOURS; COORDINATING TRAVEL ARRANGEMENTS FOR INDIVIDUALS AND FOR GROUPS; ORGANIZATION OF TRAVEL; ORGANIZATION OF EXCURSIONS, SIGHTSEEING TOURS, HOLIDAYS, TOURS AND TRAVEL; TRAVEL AGENCY SERVICES, NAMELY, MAKING RESERVATIONS AND BOOKINGS FOR TRANSPORTATION (U.S. CLS. 100 AND 105).

FIRST USE 8-1-1999; IN COMMERCE 8-1-1999.
HOWARD SMIGA, EXAMINING ATTORNEY

CLASS 39—(Continued).

SN 78-832,067. TEXAS INTERNATIONAL EXPRESS, HUFFMAN, TX. FILED 3-8-2006.

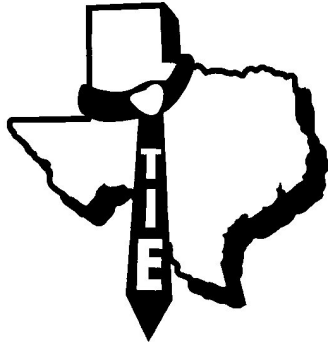

NO CLAIM IS MADE TO THE EXCLUSIVE RIGHT TO USE PICTORIAL REPRESENTATION OF THE STATE OF TEXAS, APART FROM THE MARK AS SHOWN.

FOR TRANSPORTATION OF GOODS BY TRUCK (U.S. CLS. 100 AND 105).

FIRST USE 6-25-1996; IN COMMERCE 6-25-1996.
SHAUNIA WALLACE, EXAMINING ATTORNEY

SN 78-839,632. PUBLIC STORAGE, INC., GLENDALE, CA. FILED 3-17-2006.



NO CLAIM IS MADE TO THE EXCLUSIVE RIGHT TO USE "STORAGE", APART FROM THE MARK AS SHOWN. THE COLORS YELLOW AND GREEN ARE CLAIMED AS A FEATURE OF THE MARK.

THE COLOR GREEN APPEARS IN THE WORDING AND THE ARC UNDERNEATH THE WEATHER VANE, AND THE COLOR YELLOW APPEARS IN THE WEATHER VANE AND THE STORAGE BIN DESIGN.

FOR RENTAL OF TRUCKS AND CONTAINERS FOR MOVING AND STORING GOODS; PACKING SERVICES, NAMELY, PACKING ARTICLES FOR TRANSPORTATION AND STORAGE; TRANSPORTATION AND STORAGE OF PACKED CONTAINERS, NAMELY MOVING VAN SERVICES AND WAREHOUSING SERVICES (U.S. CLS. 100 AND 105).

SUNG IN, EXAMINING ATTORNEY

CLASS 39—(Continued).

SN 78-842,717. ALAMO STORAGE, L.C., SALT LAKE CITY, UT. FILED 3-21-2006.

Alamo Storage

THE MARK CONSISTS OF STANDARD CHARACTERS WITHOUT CLAIM TO ANY PARTICULAR FONT, STYLE, SIZE, OR COLOR.

NO CLAIM IS MADE TO THE EXCLUSIVE RIGHT TO USE "STORAGE", APART FROM THE MARK AS SHOWN. FOR STORAGE OF PERSONAL PROPERTY (U.S. CLS. 100 AND 105).

FIRST USE 1-1-1980; IN COMMERCE 1-1-1980.
KATHERINE STOIDES, EXAMINING ATTORNEY

SN 78-847,969. HONDA MOTOR CO., LTD., MINATO-KU, TOKYO, JAPAN, FILED 3-28-2006.

ACURALINK ASSIST

THE MARK CONSISTS OF STANDARD CHARACTERS WITHOUT CLAIM TO ANY PARTICULAR FONT, STYLE, SIZE, OR COLOR.

OWNER OF U.S. REG. NOS. 1,407,602, 2,365,656 AND OTHERS.

NO CLAIM IS MADE TO THE EXCLUSIVE RIGHT TO USE "ASSIST", APART FROM THE MARK AS SHOWN.

FOR PROVIDING EMERGENCY TOWING INFORMATION TO DRIVERS REGARDING THEIR VEHICLES (U.S. CLS. 100 AND 105).

AMY MCMENAMIN, EXAMINING ATTORNEY

SN 78-847,996. GRAND AMERICAN TRAVELS, INC., SAN MARINO, CA. FILED 3-28-2006.

格蘭旅行社

NO CLAIM IS MADE TO THE EXCLUSIVE RIGHT TO USE THE NON-LATIN CHARACTERS THAT MEAN "TRAVEL AGENCY", APART FROM THE MARK AS SHOWN.

THE MARK CONSISTS OF FIVE CHINESE CHARACTERS.

THE ENGLISH TRANSLATION OF THE FOREIGN WORDING IN THE MARK IS "GRAND TRAVEL AGENCY".

THE NON-LATIN CHARACTER(S) IN THE MARK TRANSLITERATE INTO GER LAN LUE HSIN SHEH, AND THIS MEANS GRAND TRAVEL AGENCY IN ENGLISH.

FOR ARRANGING TRAVEL TOURS (U.S. CLS. 100 AND 105).

FIRST USE 10-1-1989; IN COMMERCE 10-1-1989.
ALAIN LAPTER, EXAMINING ATTORNEY

CLASS 39—(Continued).

SN 78-849,298. ILS INTERNATIONAL LAUNCH SERVICES, INC., MCLEAN, VA. FILED 3-29-2006.



THE COLOR(S) BLUE, GRAY AND WHITE IS/ARE CLAIMED AS A FEATURE OF THE MARK.

THE COLOR BLUE APPEARS IN THE LETTERS ILS, THE TIP OF THE TRIANGLE, THE CIRCLES AT THE END OF THE ORBITAL RINGS AND IN THE FIRST, THIRD AND FIFTH SECTIONS OF THE ORBITAL RINGS. THE COLOR WHITE APPEARS IN THE SECOND AND FORTH SECTIONS OF THE ORBITAL RINGS AND IN THE TRIANGULAR SHAPE IN THE MIDDLE OF THE LARGE GRAY CIRCLE.

FOR PRE-LAUNCH PREPARATIONS AND LAUNCHING OF SATELLITES AND SPACE VEHICLES FOR OTHERS (U.S. CLS. 100 AND 105).

FIRST USE 2-28-2001; IN COMMERCE 2-28-2001.
JENNIFER MARTIN, EXAMINING ATTORNEY

CLASS 39—(Continued).

SN 78-858,257. STARWARD VACATIONS, HERNANDO, MS. FILED 4-10-2006.



NO CLAIM IS MADE TO THE EXCLUSIVE RIGHT TO USE "VACATIONS", APART FROM THE MARK AS SHOWN.

THE MARK CONSISTS OF LOGO DESIGN OF THE WORDING STARWARD VACATIONS ON TOP OF A CIRCLE AND STAR.

FOR ORGANISATION OF TRAVEL; TRAVEL BOOKING AGENCIES; TRAVEL, EXCURSION AND CRUISE ARRANGEMENT (U.S. CLS. 100 AND 105).

FIRST USE 2-1-2006; IN COMMERCE 2-1-2006.
DORITT L. CARROLL, EXAMINING ATTORNEY

SN 78-860,998. CONNEXUS ENERGY, RAMSY, MN. FILED 4-13-2006.

SN 78-849,356. AUTOBUSES TIERRA CALIENTE, INC., CEDAR HILL, TX. FILED 3-29-2006.

Autobuses Tierra Caliente

THE MARK CONSISTS OF STANDARD CHARACTERS WITHOUT CLAIM TO ANY PARTICULAR FONT, STYLE, SIZE, OR COLOR.

NO CLAIM IS MADE TO THE EXCLUSIVE RIGHT TO USE "AUTOBUSES", APART FROM THE MARK AS SHOWN.

THE FOREIGN WORDING IN THE MARK TRANSLATES INTO ENGLISH AS HOT EARTH.

FOR TRANSPORTATION OF PASSENGERS AND/OR GOODS BY BUS (U.S. CLS. 100 AND 105).

FIRST USE 0-0-1998; IN COMMERCE 0-0-2000.
JEFF DEFORD, EXAMINING ATTORNEY

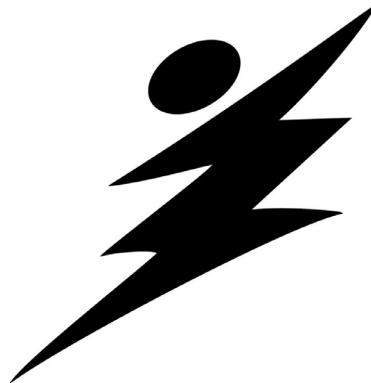

THE MARK CONSISTS OF A STYLIZED LIGHTNING BOLT WITH A DOT ON TOP.

FOR PUBLIC UTILITY SERVICES IN THE NATURE OF ELECTRICITY DISTRIBUTION (U.S. CLS. 100 AND 105).

FIRST USE 8-24-1998; IN COMMERCE 10-1-1998.
LANA PHAM, EXAMINING ATTORNEY

CLASS 39—(Continued).

SN 78-861,715. TECHNOLOGY, AUTOMATION & MANAGEMENT, INC., FALLS CHURCH, VA. FILED 4-14-2006.

BE READY - YOU JUST NEVER
KNOW

THE MARK CONSISTS OF STANDARD CHARACTERS WITHOUT CLAIM TO ANY PARTICULAR FONT, STYLE, SIZE, OR COLOR.

FOR PROVIDING DATABASE ACCOUNTS ACCESSIBLE VIA A GLOBAL COMPUTER NETWORK FOR SUBSCRIBERS IN THE FORM OF VIRTUAL ELECTRONIC FILE CABINETS, NAMELY, ELECTRONIC STORAGE OF FILES AND DOCUMENTS IN THE NATURE OF PERSONAL AND PRIVATE INFORMATION PERTAINING TO THE SUBSCRIBER IN THE FIELDS OF FINANCIAL, MEDICAL, AND OTHER SENSITIVE INFORMATION (U.S. CLS. 100 AND 105).

JESSICA A. POWERS, EXAMINING ATTORNEY

SN 78-861,732. TECHNOLOGY, AUTOMATION & MANAGEMENT, INC., FALLS CHURCH, VA. FILED 4-14-2006.

YOU JUST NEVER KNOW - BE
READY

THE MARK CONSISTS OF STANDARD CHARACTERS WITHOUT CLAIM TO ANY PARTICULAR FONT, STYLE, SIZE, OR COLOR.

FOR PROVIDING DATABASE ACCOUNTS ACCESSIBLE VIA A GLOBAL COMPUTER NETWORK FOR SUBSCRIBERS IN THE FORM OF VIRTUAL ELECTRONIC FILE CABINETS, NAMELY, ELECTRONIC STORAGE OF FILES AND DOCUMENTS IN THE NATURE OF PERSONAL AND PRIVATE INFORMATION PERTAINING TO THE SUBSCRIBER IN THE FIELDS OF FINANCIAL, MEDICAL, AND OTHER SENSITIVE INFORMATION (U.S. CLS. 100 AND 105).

JESSICA A. POWERS, EXAMINING ATTORNEY

SN 78-861,831. BADER, ALTER NATHAN, SAN FRANCISCO, CA. FILED 4-14-2006.

Bed Busters

THE MARK CONSISTS OF STANDARD CHARACTERS WITHOUT CLAIM TO ANY PARTICULAR FONT, STYLE, SIZE, OR COLOR.

NO CLAIM IS MADE TO THE EXCLUSIVE RIGHT TO USE "BED", APART FROM THE MARK AS SHOWN. FOR TRUCK HAULING (U.S. CLS. 100 AND 105). FIRST USE 11-24-2003; IN COMMERCE 11-24-2003.

JENNIFER MARTIN, EXAMINING ATTORNEY

CLASS 39—(Continued).

SN 78-862,126. BADER, ALTER NATHAN, SAN FRANCISCO, CA. FILED 4-14-2006.

junk taxi

THE MARK CONSISTS OF STANDARD CHARACTERS WITHOUT CLAIM TO ANY PARTICULAR FONT, STYLE, SIZE, OR COLOR.

NO CLAIM IS MADE TO THE EXCLUSIVE RIGHT TO USE JUNK, APART FROM THE MARK AS SHOWN.

FOR TRUCK HAULING (U.S. CLS. 100 AND 105).

FIRST USE 9-15-2003; IN COMMERCE 9-15-2003.

JANICE KIM, EXAMINING ATTORNEY

SN 78-862,973. MOORE, JONATHAN D, WASHINGTON, DC. FILED 4-17-2006.

Head of the Trail

THE MARK CONSISTS OF STANDARD CHARACTERS WITHOUT CLAIM TO ANY PARTICULAR FONT, STYLE, SIZE, OR COLOR.

FOR ORGANIZATION, BOOKING AND ARRANGEMENT OF EXCURSIONS, DAY TRIPS AND SIGHTSEEING TOURS; PARCEL DELIVERY; TOUR GUIDE SERVICES; TRANSPORT OF GOODS; TRANSPORT OF PASSENGERS (U.S. CLS. 100 AND 105).

JESSICA A. POWERS, EXAMINING ATTORNEY

SN 78-863,358. BUDGET RENT A CAR SYSTEM, INC., PARSIPPANY, NJ. FILED 4-18-2006.

RENT LIKE A GENIUS

THE MARK CONSISTS OF STANDARD CHARACTERS WITHOUT CLAIM TO ANY PARTICULAR FONT, STYLE, SIZE, OR COLOR.

FOR LEASING OF VEHICLES; RENTAL OF VEHICLES (U.S. CLS. 100 AND 105).

ELIZABETH J. WINTER, EXAMINING ATTORNEY

CLASS 39—(Continued).

SN 78-863,613. STARFLIGHT AVIATION LIMITED, FARNBOROUGH, UNITED KINGDOM, FILED 4-18-2006.

STARFLIGHT

THE MARK CONSISTS OF STANDARD CHARACTERS WITHOUT CLAIM TO ANY PARTICULAR FONT, STYLE, SIZE, OR COLOR.

FOR AVIATION SERVICES, NAMELY, AIR TRANSPORTATION OF PEOPLE, PETS AND CARGO, INCLUDING, BUT NOT LIMITED TO EXECUTIVE JET CHARTER, PRIVATE AIR CHARTER, ARRANGING AND SCHEDULING FLIGHTS ON AIRPLANES (U.S. CLS. 100 AND 105).

FIRST USE 0-0-1990; IN COMMERCE 0-0-1990.

ANNE E. GUSTASON, EXAMINING ATTORNEY

SN 78-865,227. NCL CORPORATION LTD., MIAMI, FL. FILED 4-19-2006.

EASY FLY. WE BRING THE AIRPORT TO YOU!

THE MARK CONSISTS OF STANDARD CHARACTERS WITHOUT CLAIM TO ANY PARTICULAR FONT, STYLE, SIZE, OR COLOR.

FOR AIRPORT PASSENGER CHECK-IN SERVICES; TRANSPORTATION SERVICES, NAMELY, CHECKING OF BAGGAGE (U.S. CLS. 100 AND 105).

SHARON MEIER, EXAMINING ATTORNEY

SN 78-866,809. COMMUNICATION EXPERTS INC., EDISON, NJ. FILED 4-21-2006.

MovingGreeting

THE MARK CONSISTS OF STANDARD CHARACTERS WITHOUT CLAIM TO ANY PARTICULAR FONT, STYLE, SIZE, OR COLOR.

FOR DELIVERY OF GIFTS AND VIDEO MESSAGES CONTAINED ON DIGITAL VIDEO DISCS (U.S. CLS. 100 AND 105).

FIRST USE 4-19-2006; IN COMMERCE 4-19-2006.

CAROLYN GRAY, EXAMINING ATTORNEY

CLASS 39—(Continued).

SN 78-868,595. NATURAL MIGRATIONS, LLC, BEND, OR. FILED 4-25-2006.

NATURAL MIGRATIONS

THE MARK CONSISTS OF STANDARD CHARACTERS WITHOUT CLAIM TO ANY PARTICULAR FONT, STYLE, SIZE, OR COLOR.

FOR ARRANGING, ORGANIZING AND CONDUCTING TRAVEL TOURS AND EXPEDITIONS FOR OTHERS (U.S. CLS. 100 AND 105).

FIRST USE 4-24-2006; IN COMMERCE 4-24-2006.

JOHN WILKE, EXAMINING ATTORNEY

SN 78-871,207. CHARIOT USA INC., LONG BEACH, CA. FILED 4-27-2006.



NO CLAIM IS MADE TO THE EXCLUSIVE RIGHT TO USE "RENT-A-CAR", APART FROM THE MARK AS SHOWN.

THE MARK CONSISTS OF A BOX WHICH CONTAINS A CUT OFF WHEEL REPRESENTING LETTER "C", AND THE WORDS "CHARIOT RENT-A-CAR" WITH LETTER "T" FROM WORDS "CHARIOT" DEPICTING AN AUTOMOBILE SHAPE, AND THE WORDS "SAY GOODBYE TO ORDINARY CAR RENTAL SERVICE!" UNDERNEATH.

FOR LEASING OF CARS; RENTAL CAR RESERVATION; RENTAL OF CARS; RENTAL OF MOVING VANS; RENTAL OF TRACTION VEHICLE AND TRAILERS; RENTAL OF TRUCKS; RENTAL OF VEHICLES; TRUCK AND TRAILER RENTAL (U.S. CLS. 100 AND 105).

FIRST USE 1-1-2006; IN COMMERCE 1-1-2006.

FRED MANDIR, EXAMINING ATTORNEY

SN 78-872,180. HEXASOFT DEVELOPMENT SDN. BHD., BAYAN BARU, MALAYSIA, FILED 4-28-2006.

ZIPCODEWORLD

THE MARK CONSISTS OF STANDARD CHARACTERS WITHOUT CLAIM TO ANY PARTICULAR FONT, STYLE, SIZE, OR COLOR.

FOR PROVIDING A WEBSITE FEATURING INFORMATION IN THE FIELD OF POSTAL CODE AND AREA CODES (U.S. CLS. 100 AND 105).

FIRST USE 1-13-2003; IN COMMERCE 1-13-2003.

SHARON MEIER, EXAMINING ATTORNEY

CLASS 39—(Continued).

SN 78-939,996. NATIONAL ASSOCIATION FOR STOCK CAR AUTO RACING, INC., DAYTONA BEACH, FL. FILED 7-28-2006.

NASCAR VALLEY TOUR

THE MARK CONSISTS OF STANDARD CHARACTERS WITHOUT CLAIM TO ANY PARTICULAR FONT, STYLE, SIZE, OR COLOR.

OWNER OF U.S. REG. NOS. 990,987, 1,974,069 AND OTHERS.

NO CLAIM IS MADE TO THE EXCLUSIVE RIGHT TO USE "TOUR", APART FROM THE MARK AS SHOWN.

FOR ORGANIZING AND ARRANGING SIGHTSEEING TOURS FOR GROUPS OR INDIVIDUALS (U.S. CLS. 100 AND 105).

JOHN E. MICHOS, EXAMINING ATTORNEY

CLASS 40—(Continued).

SN 78-649,952. MANIFATTURA SATTA & BOTTELLI S.P.A., NERVIANO (MILAN), ITALY, FILED 6-14-2005.



PRIORITY CLAIMED UNDER SEC. 44(D) ON ITALY APPLICATION NO. MI2005C00606, FILED 5-30-2005, REG. NO. 1006354, DATED 5-5-2006, EXPIRES 5-30-2015.

NO CLAIM IS MADE TO THE EXCLUSIVE RIGHT TO USE "FINITURA AND "SKILKING, APART FROM THE MARK AS SHOWN.

THE FOREIGN WORDING IN THE MARK TRANSLATES INTO ENGLISH AS DRESSING.

FOR TREATMENT OF FABRICS NAMEDLY SINGEING AND DE-SIZING, MERCERIZATION, BLEACHING, DYEING, SIZING AND DRYING, FINISHING AND MAKING UP OF FABRICS (U.S. CLS. 100, 103 AND 106).
EUGENIA MARTIN, EXAMINING ATTORNEY

CLASS 40—MATERIAL TREATMENT

SN 76-656,407. GRAPHIC SERVICES, LLC, ROCKLAND, MA. FILED 3-10-2006.



NO CLAIM IS MADE TO THE EXCLUSIVE RIGHT TO USE GRAPHICS, APART FROM THE MARK AS SHOWN.

FOR PRINTING SERVICE (U.S. CLS. 100, 103 AND 106).

ERNEST SHOSHO, EXAMINING ATTORNEY

SN 78-703,868. PROMETCO, INC., WOODINVILLE, WA. FILED 8-30-2005.

SN 78-562,579. VOXONIC, INC., NEW YORK, NY. FILED 2-8-2005.



THE COLORS BLACK AND RED ARE CLAIMED AS A FEATURE OF THE MARK.

THE MARK CONSISTS OF VOXONIC WITH A STYLIZED X IN THE COLOR RED, THE WORDING "FREEDOM OF SPEECH" IN THE COLOR RED, AND THE WORDING "IN EVERY LANGUAGE" AND THE LETTERS VO ONIC IN BLACK.

FOR ELECTRONIC REPLICATION OF THE VOICES OF INDIVIDUALS; ELECTRONIC TRANSFORMATION OF VOICES INTO OTHER LANGUAGES (U.S. CLS. 100, 103 AND 106).

FIRST USE 1-5-2004; IN COMMERCE 1-5-2004.

DOMINICK J. SALEMI, EXAMINING ATTORNEY



FOR CUSTOM MANUFACTURING AND FABRICATION OF MACHINES, ADVANCED ROBOTIC EQUIPMENT AND CONVEYORS FOR USE BY OTHERS IN THE FIELDS OF FOOD PROCESSING, BEVERAGE BOTTLING, AND PACKAGING (U.S. CLS. 100, 103 AND 106).

FIRST USE 6-20-1978; IN COMMERCE 6-20-1978.

ZHALEH DELANEY, EXAMINING ATTORNEY

CLASS 40—(Continued).

SN 78-703,869. PROMETCO, INC., WOODINVILLE, WA.
FILED 8-30-2005.

PROMETCO

THE MARK CONSISTS OF STANDARD CHARACTERS WITHOUT CLAIM TO ANY PARTICULAR FONT, STYLE, SIZE, OR COLOR.

FOR CUSTOM MANUFACTURING AND FABRICATION OF MACHINES, ADVANCED ROBOTIC EQUIPMENT AND CONVEYORS FOR USE BY OTHERS IN THE FIELDS OF FOOD PROCESSING, BEVERAGE BOTTLING, AND PACKAGING (U.S. CLS. 100, 103 AND 106).

FIRST USE 6-20-1978; IN COMMERCE 6-20-1978.
ZHALEH DELANEY, EXAMINING ATTORNEY

SN 78-705,808. BOURGEOIS, JASON, PROCTORSVILLE, VT.
AND BEAULIEU, JOHN, PROCTORSVILLE, VT. FILED 9-2-2005.

The Living Tooth Company

THE MARK CONSISTS OF STANDARD CHARACTERS WITHOUT CLAIM TO ANY PARTICULAR FONT, STYLE, SIZE, OR COLOR.

NO CLAIM IS MADE TO THE EXCLUSIVE RIGHT TO USE "COMPANY", APART FROM THE MARK AS SHOWN.

FOR CRYOGENIC PRESERVATION; CUSTOM MANUFACTURE OF DENTAL PROSTHETICS; DENTAL LABORATORIES; DENTAL TECHNICIAN SERVICES (U.S. CLS. 100, 103 AND 106).

DAYNA BROWNE, EXAMINING ATTORNEY

SN 78-713,082. THORWORKS INDUSTRIES, INC., SANDUSKY, OH. FILED 9-14-2005.

THORWORKS INDUSTRIES

THE MARK CONSISTS OF STANDARD CHARACTERS WITHOUT CLAIM TO ANY PARTICULAR FONT, STYLE, SIZE, OR COLOR.

OWNER OF U.S. REG. NO. 3,062,839.

NO CLAIM IS MADE TO THE EXCLUSIVE RIGHT TO USE "INDUSTRIES", APART FROM THE MARK AS SHOWN.

FOR CUSTOM MANUFACTURING OF BITUMEN, TAR AND LATEX SEALANTS FOR PAVEMENT, FOUNDATIONS, AND ROOFS TO THE ORDER AND SPECIFICATIONS OF OTHERS (U.S. CLS. 100, 103 AND 106).

FIRST USE 4-30-2004; IN COMMERCE 4-30-2004.
KATINA MISTER, EXAMINING ATTORNEY

CLASS 40—(Continued).

SN 78-713,676. PPC MARKETING, LTD., PITTSBURG, TX.
FILED 9-15-2005.



NO CLAIM IS MADE TO THE EXCLUSIVE RIGHT TO USE "CONSUMER TESTED" AND "CONSUMER APPROVED", APART FROM THE MARK AS SHOWN.

FOR FOOD PROCESSING FOR POULTRY AND POULTRY PARTS (U.S. CLS. 100, 103 AND 106).

FIRST USE 8-24-2005; IN COMMERCE 9-1-2005.

MARIAM MAHMOUDI, EXAMINING ATTORNEY

SN 78-714,659. IMPRO INDUSTRIES USA, INC., DIAMOND BAR, CA. FILED 9-16-2005.

IMPRO

THE MARK CONSISTS OF STANDARD CHARACTERS WITHOUT CLAIM TO ANY PARTICULAR FONT, STYLE, SIZE, OR COLOR.

FOR CONTRACT INDUSTRIAL MANUFACTURING OF MACHINE PARTS, NAMELY, OF PRECISION INVESTMENT CASTINGS, SAND CASTINGS, LOW-PRESSURE CASTINGS, AUTOMOTIVE PARTS, AEROSPACE PARTS, MACHINE COMPONENTS, AND MARINE METAL COMPONENTS (U.S. CLS. 100, 103 AND 106).

FIRST USE 6-1-1999; IN COMMERCE 6-1-1999.

DAYNA BROWNE, EXAMINING ATTORNEY

SN 78-714,679. IMPRO INDUSTRIES USA, INC., DIAMOND BAR, CA. FILED 9-16-2005.



FOR CONTRACT INDUSTRIAL MANUFACTURING OF MACHINE PARTS, NAMELY, OF PRECISION INVESTMENT CASTINGS, SAND CASTINGS, LOW-PRESSURE CASTINGS, AUTOMOTIVE PARTS, AEROSPACE PARTS, MACHINE COMPONENTS, AND MARINE METAL COMPONENTS (U.S. CLS. 100, 103 AND 106).

FIRST USE 6-15-1999; IN COMMERCE 6-15-1999.

DAYNA BROWNE, EXAMINING ATTORNEY

CLASS 40—(Continued).

SN 78-739,565. RUSSELL, MICHAEL, DBA ANYSUPPLIES, BROOKLYN, NY. FILED 10-24-2005.

Anysupplies

THE MARK CONSISTS OF STANDARD CHARACTERS WITHOUT CLAIM TO ANY PARTICULAR FONT, STYLE, SIZE, OR COLOR.

FOR CUSTOM IMPRINTING OF A WIDE VARIETY OF CONSUMER PRODUCTS FOR USE AS PROMOTIONAL PRODUCTS BY OTHERS, NAMELY, PENS, CALENDARS, CLOTHING, T-SHIRTS, TOWELS, HATS, KEY CHAINS, MOUSE PADS, NOTE PADS, PERSONAL ORGANIZERS, MUGS, CUPS, WATER BOTTLES, TOTE-BAGS, WRISTBANDS AND UMBRELLAS (U.S. CLS. 100, 103 AND 106).

TRACY FLETCHER, EXAMINING ATTORNEY

SN 78-748,080. BARKER, CHRISTOPHER WJ, TUCSON, AZ. FILED 11-6-2005.



NO CLAIM IS MADE TO THE EXCLUSIVE RIGHT TO USE "CLOTHING" AND "COMPANY", APART FROM THE MARK AS SHOWN.

THE MARK CONSISTS OF A STYLIZED CAPITAL LETTER "V" WITH A FIVE POINT STAR ON ITS TOP LEFT SIDE WITH THE STYLIZED WORDING "VILLAIN" AND "CLOTHING" AND "COMPANY" UNDERNEATH WITH A FIVE POINT STAR ON EACH SIDE OF THE WORD "CLOTHING."

FOR IMPRINTING MESSAGES ON T-SHIRTS (U.S. CLS. 100, 103 AND 106).

SONYA STEPHENS, EXAMINING ATTORNEY

SN 78-759,576. THE WALMAN OPTICAL COMPANY, MINNEAPOLIS, MN. FILED 11-22-2005.

PLASMAEYEZ

THE MARK CONSISTS OF STANDARD CHARACTERS WITHOUT CLAIM TO ANY PARTICULAR FONT, STYLE, SIZE, OR COLOR.

FOR PLASMA TREATMENT OF CONTACT LENSES FOR PURPOSES OF PREVENTATIVE CLEANING (U.S. CLS. 100, 103 AND 106).

FIRST USE 6-30-2005; IN COMMERCE 6-30-2005.

SCOTT SISUN, EXAMINING ATTORNEY

CLASS 40—(Continued).

SN 78-760,256. ECRS, LLC, HOLLYWOOD, FL. FILED 11-23-2005.



Hors D'Oeuvres • Canapés
Custom Food Creations

NO CLAIM IS MADE TO THE EXCLUSIVE RIGHT TO USE "HORS D'OEUVRES", "CANAPES", AND "CUSTOM FOOD CREATIONS", APART FROM THE MARK AS SHOWN.

THE MARK CONSISTS OF A MAN IN A CHEF'S HAT AND JACKET HOLDING A SERVING DISH WITH A DOMED COVER. THE WORDING "BIG" APPEARS TO THE RIGHT OF THE CHEF AND THE WORDING "CHEF" APPEARS BELOW THE WORDING "BIG". BELOW THE CHEF AND THE WORDINGS "BIG" AND "CHEF" ARE THE WORDINGS "HORS D'OEUVRES" AND "CANAPES" APPEARING NEXT TO EACH OTHER. BELOW THE CHEF AND ALL OF THE WORDINGS ABOVE ARE THE WORDINGS "CUSTOM FOOD CREATIONS".

FOR FOOD PROCESSING (U.S. CLS. 100, 103 AND 106).

FIRST USE 11-22-2003; IN COMMERCE 11-22-2003.
PETER CHENG, EXAMINING ATTORNEY

SN 78-814,827. AMADOR, LUZ MARIA, FRESNO, CA. FILED 2-14-2006.

Bioaqua

THE MARK CONSISTS OF STANDARD CHARACTERS WITHOUT CLAIM TO ANY PARTICULAR FONT, STYLE, SIZE, OR COLOR.

FOR TREATMENT OF WASTE WATER (U.S. CLS. 100, 103 AND 106).

RONALD MCMORROW, EXAMINING ATTORNEY

CLASS 40—(Continued).

SN 78-823,054. EDGETECH DOCUMENT SERVICES, SARASOTA, FL. FILED 2-24-2006.



THE COLOR(S) REFLEX BLUE, ORANGE, WHITE AND BLACK IS/ARE CLAIMED AS A FEATURE OF THE MARK. THE RECTANGLE WITH TWO ARROWS IS IN REFLEX BLUE, THE SWISH APPEARS IN ORANGE AND THE TWO PIECES OF PAPER ARE IN WHITE WITH A BLACK OUTLINE.

FOR DOCUMENT SHREDDING SERVICES (U.S. CLS. 100, 103 AND 106).

FIRST USE 3-15-2005; IN COMMERCE 3-22-2005.
ELLEN PERKINS, EXAMINING ATTORNEY

SN 78-824,681. BOTTOM LINE BRACELETS, SAN ANTONIO, TX. FILED 2-27-2006.

bottom line bracelets

THE MARK CONSISTS OF STANDARD CHARACTERS WITHOUT CLAIM TO ANY PARTICULAR FONT, STYLE, SIZE, OR COLOR.

NO CLAIM IS MADE TO THE EXCLUSIVE RIGHT TO USE "BRACELETS", APART FROM THE MARK AS SHOWN.

FOR CUSTOM MANUFACTURE OF JEWELRY, NAMELY SILICONE BRACELETS (U.S. CLS. 100, 103 AND 106).

DAVID I, EXAMINING ATTORNEY

SN 78-826,327. PLANT, RENAE, S., LOS ANGELES, CA. FILED 3-1-2006.

[bump] baby under manufacturing process

THE MARK CONSISTS OF STANDARD CHARACTERS WITHOUT CLAIM TO ANY PARTICULAR FONT, STYLE, SIZE, OR COLOR.

FOR IMPRINTING MESSAGES ON T-SHIRTS; T-SHIRT EMBROIDERING SERVICES (U.S. CLS. 100, 103 AND 106).

JUSTINE D. PARKER, EXAMINING ATTORNEY

CLASS 40—(Continued).

SN 78-836,645. ZAMIR, RON, MENIFEE, CA. FILED 3-14-2006.

MARTIAN LASER

THE MARK CONSISTS OF STANDARD CHARACTERS WITHOUT CLAIM TO ANY PARTICULAR FONT, STYLE, SIZE, OR COLOR.

NO CLAIM IS MADE TO THE EXCLUSIVE RIGHT TO USE "LASER", APART FROM THE MARK AS SHOWN, FOR ENGRAVING SERVICES (U.S. CLS. 100, 103 AND 106).

KIMBERLY FRYE, EXAMINING ATTORNEY

SN 78-845,619. PIMENTEL, MICHAEL, SANTA CRUZ, CA. FILED 3-24-2006.

CONNECTED INC . CLOTHING .CO

THE MARK CONSISTS OF STANDARD CHARACTERS WITHOUT CLAIM TO ANY PARTICULAR FONT, STYLE, SIZE, OR COLOR.

NO CLAIM IS MADE TO THE EXCLUSIVE RIGHT TO USE "INC. CLOTHING CO.", APART FROM THE MARK AS SHOWN.

FOR CUSTOM IMPRINTING OF T SHIRTS AND HATS WITH DECORATIVE DESIGNS (U.S. CLS. 100, 103 AND 106).

JAMES STEIN, EXAMINING ATTORNEY

SN 78-848,493. BOANERGES UNLIMITED, INC., WEST PALM BEACH, FL. FILED 3-28-2006.



NO CLAIM IS MADE TO THE EXCLUSIVE RIGHT TO USE "CLOTHING", APART FROM THE MARK AS SHOWN. THE MARK CONSISTS OF A CHI RHO CROSS WITH THE WORDS REBIRTH CLOTHING.

FOR CUSTOM IMPRINTING OF CLOTHING, HATS, AND ACCESSORIES WITH DECORATIVE DESIGNS; MONOGRAMMING OF CLOTHING (U.S. CLS. 100, 103 AND 106).

MICHAEL SOUDERS, EXAMINING ATTORNEY

CLASS 40—(Continued).

SN 78-848,553. CALIFORNIA BREWING COMPANY INC., ANDERSON, CA. FILED 3-29-2006.

Tuscan Brewing Company

THE MARK CONSISTS OF STANDARD CHARACTERS WITHOUT CLAIM TO ANY PARTICULAR FONT, STYLE, SIZE, OR COLOR.

NO CLAIM IS MADE TO THE EXCLUSIVE RIGHT TO USE "BREWING COMPANY", APART FROM THE MARK AS SHOWN.

FOR BREWERY SERVICES (U.S. CLS. 100, 103 AND 106).

KATHERINE CHANG, EXAMINING ATTORNEY

CLASS 40—(Continued).

SN 78-855,475. PALAPA JOES, CORONA, CA. FILED 4-6-2006.



NO CLAIM IS MADE TO THE EXCLUSIVE RIGHT TO USE PALAPA, APART FROM THE MARK AS SHOWN.

FOR CUSTOM MANUFACTURE OF PALAPA UMBRELLAS (U.S. CLS. 100, 103 AND 106).

FIRST USE 3-26-2004; IN COMMERCE 4-4-2004.

STEVEN R. FINE, EXAMINING ATTORNEY

SN 78-852,053. CRAIG A. SELLERS, LINCOLN CITY, OR. FILED 4-2-2006.

JUST ADD SAND

THE MARK CONSISTS OF STANDARD CHARACTERS WITHOUT CLAIM TO ANY PARTICULAR FONT, STYLE, SIZE, OR COLOR.

FOR IMPRINTING MESSAGES ON T-SHIRTS (U.S. CLS. 100, 103 AND 106).

SHARON MEIER, EXAMINING ATTORNEY

SN 78-855,737. 3M COMPANY, ST. PAUL, MN. FILED 4-6-2006.

LATITUDE

THE MARK CONSISTS OF STANDARD CHARACTERS WITHOUT CLAIM TO ANY PARTICULAR FONT, STYLE, SIZE, OR COLOR.

FOR MANUFACTURER OF TRANSDERMAL PATCHES CONTAINING PHARMACEUTICAL PREPARATIONS TO THE ORDER AND SPECIFICATION OF OTHERS (U.S. CLS. 100, 103 AND 106).

FIRST USE 5-30-1996; IN COMMERCE 5-30-1996.

PAM WILLIS, EXAMINING ATTORNEY

SN 78-854,199. MOHAWK SIGN SYSTEMS, INC., AMSTERDAM, NY. FILED 4-5-2006.

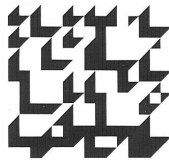

**Mohawk
Sign
Systems**

OWNER OF U.S. REG. NO. 1,980,740. NO CLAIM IS MADE TO THE EXCLUSIVE RIGHT TO USE "SIGN SYSTEMS", APART FROM THE MARK AS SHOWN.

FOR MANUFACTURE OF SIGNS TO THE SPECIFICATIONS OF OTHERS (U.S. CLS. 100, 103 AND 106).

FIRST USE 1-1-1983; IN COMMERCE 1-1-1983.

PETER B. BROMAGHIM, EXAMINING ATTORNEY

SN 78-855,792. 3M COMPANY, ST. PAUL, MN. FILED 4-6-2006.

3M

THE MARK CONSISTS OF STANDARD CHARACTERS WITHOUT CLAIM TO ANY PARTICULAR FONT, STYLE, SIZE, OR COLOR.

FOR MANUFACTURER OF TRANSDERMAL PATCHES CONTAINING PHARMACEUTICAL PREPARATIONS TO THE ORDER AND SPECIFICATION OF OTHERS (U.S. CLS. 100, 103 AND 106).

FIRST USE 5-30-1996; IN COMMERCE 5-30-1996.

PAM WILLIS, EXAMINING ATTORNEY

CLASS 40—(Continued).

SN 78-860,080. WADLEY, PAUL J., VENTURA, CA. FILED 4-12-2006.

Visualize World Peace

THE MARK CONSISTS OF STANDARD CHARACTERS WITHOUT CLAIM TO ANY PARTICULAR FONT, STYLE, SIZE, OR COLOR.

FOR IMPRINTING MESSAGES ON T-SHIRTS (U.S. CLS. 100, 103 AND 106).

SANDRA MANIOS, EXAMINING ATTORNEY

SN 78-860,885. ALLEN EXTRUDERS, INC., HOLLAND, MI. FILED 4-13-2006.



THE MARK CONSISTS OF THE WORD "ALLEN" IN STYLIZED FORM.

FOR CUSTOM MANUFACTURE OF PLASTIC EXTRUSIONS (U.S. CLS. 100, 103 AND 106).

FIRST USE 0-0-1984; IN COMMERCE 0-0-1984.

SUSAN LESLIE DUBOIS, EXAMINING ATTORNEY

SN 78-863,158. INFINISTAR OILFIELD SERVICES, LP, SUGAR LAND, TX. FILED 4-17-2006.

CREATING VALUE WITHOUT BOUNDARIES

THE MARK CONSISTS OF STANDARD CHARACTERS WITHOUT CLAIM TO ANY PARTICULAR FONT, STYLE, SIZE, OR COLOR.

FOR OIL AND GAS WELL TREATMENT SERVICES, NAMELY, PROVIDING COILED TUBING, NITROGEN, AND FLUID PUMPING SERVICES FOR OIL AND GAS WELLS (U.S. CLS. 100, 103 AND 106).

FIRST USE 4-17-2006; IN COMMERCE 4-17-2006.

STEVEN JACKSON, EXAMINING ATTORNEY

CLASS 40—(Continued).

SN 78-863,877. PLASTIC COMPANIES ENTERPRISES, INC., LINCOLN, NE. FILED 4-18-2006.

HTI Plastics

THE MARK CONSISTS OF STANDARD CHARACTERS WITHOUT CLAIM TO ANY PARTICULAR FONT, STYLE, SIZE, OR COLOR.

NO CLAIM IS MADE TO THE EXCLUSIVE RIGHT TO USE "PLASTICS", APART FROM THE MARK AS SHOWN.

FOR CUSTOM THERMOPLASTIC INJECTION MOLDING SERVICES FOR OTHERS, SPECIALIZING IN: (1) PLASTIC PHARMACEUTICAL PRODUCTS SUCH AS APPLICATORS TO DELIVER MEDICATIONS VAGINALLY, ORALLY AND TOPICALLY; (2) PLASTIC PRODUCTS FOR THE HUNTING, FISHING AND SPORTING INDUSTRIES; (3) PLASTIC CONSUMER PACKAGING SUCH AS OVAL CONTAINERS FOR TOWELETTES/WET WIPES; AND (4) CUSTOM PLASTIC ARTICLES AND DEVICES TO ORDER AND SPECIFICATIONS OF OTHERS (U.S. CLS. 100, 103 AND 106).

FIRST USE 2-26-1999; IN COMMERCE 2-26-1999.

MARTHA SANTOMARTINO, EXAMINING ATTORNEY

SN 78-864,441. INTEGRATED RESOURCE GROUP, INC., NORTH MANKATO, MN. FILED 4-19-2006.

WORKSPACE XPRESS

THE MARK CONSISTS OF STANDARD CHARACTERS WITHOUT CLAIM TO ANY PARTICULAR FONT, STYLE, SIZE, OR COLOR.

FOR CUSTOM PRINTING, NAMELY, CUSTOM IMPRINTING OF BUSINESS STATIONERY, LABELS, NOTE PADS, GREETING CARDS, MUGS, PENS AND RUBBER STAMPS (U.S. CLS. 100, 103 AND 106).

CAROLINE WOOD, EXAMINING ATTORNEY

SN 78-866,097. GREENBERG, JOEL, DANVERS, MA. FILED 4-20-2006.

You Have the Right to Remain Violent

THE MARK CONSISTS OF STANDARD CHARACTERS WITHOUT CLAIM TO ANY PARTICULAR FONT, STYLE, SIZE, OR COLOR.

FOR CUSTOM IMPRINTING OF T-SHIRTS WITH DECORATIVE DESIGNS (U.S. CLS. 100, 103 AND 106).

AISHA CLARKE, EXAMINING ATTORNEY

CLASS 40—(Continued).

SN 78-869,582. CROCKEN, NELSON, WARREN, FALLSTON, MD. FILED 4-26-2006.

ENDORPHIN TRIGGER

THE MARK CONSISTS OF STANDARD CHARACTERS WITHOUT CLAIM TO ANY PARTICULAR FONT, STYLE, SIZE, OR COLOR.

FOR IMPRINTING MESSAGES ON T-SHIRTS (U.S. CLS. 100, 103 AND 106).

DAVID COLLIER, EXAMINING ATTORNEY

SN 79-016,825. KROV B.V., NL-7051 HT VARSSEVELD, NETHERLANDS, FILED 7-25-2005.



PRIORITY DATE OF 6-2-2005 IS CLAIMED. OWNER OF INTERNATIONAL REGISTRATION 0866201 DATED 7-25-2005, EXPIRES 7-25-2015.

NO CLAIM IS MADE TO THE EXCLUSIVE RIGHT TO USE "CAST" AND "FORM", APART FROM THE MARK AS SHOWN.

FOR MATERIAL TREATMENT SERVICES RENDERED FOR THE BENEFIT OF AND BY ORDER OF THIRD PARTIES, NAMELY MOLDING OF POLYURETHANE EDGES TO PANELS AND TABLES, NAMELY DESKTOPS, SCHOOL TABLES, TABLE TOPS, AND SERVING TROLLEYS, AND PANELS IN THE FIELD OF INTERIOR DESIGN (U.S. CLS. 100, 103 AND 106).

SUSAN BILHEIMER, EXAMINING ATTORNEY

CLASS 41—EDUCATION AND ENTERTAINMENT

SN 76-299,213. THE GREEN FAMILY PARTNERSHIP, BEVERLY HILLS, CA. FILED 8-15-2001.

MAKE ME LAUGH

FOR ENTERTAINMENT, NAMELY, PRODUCTION OF A TELEVISION SHOW FEATURING COMEDY (U.S. CLS. 100, 101 AND 107).

FIRST USE 3-12-1996; IN COMMERCE 3-12-1996.

ELIZABETH HUGHITT, EXAMINING ATTORNEY

CLASS 41—(Continued).

SN 76-310,872. COGNIMED INC., MADISON, NJ. FILED 9-10-2001.

CIEF

FOR EDUCATIONAL SERVICES, NAMELY, SEMINARS FOR HEALTH CARE PROVIDERS IN THE FIELD OF SEXUAL HEALTH (U.S. CLS. 100, 101 AND 107).

FIRST USE 10-13-2001; IN COMMERCE 10-13-2001.

AISHA CLARKE, EXAMINING ATTORNEY

SN 76-592,693. SILVER CINEMAS ACQUISITION CO., DBA LANDMARK THEATRES, LOS ANGELES, CA. FILED 5-17-2004.

LANDMARK THEATRES

THE MARK CONSISTS OF STANDARD CHARACTERS WITHOUT CLAIM TO ANY PARTICULAR FONT, STYLE, SIZE, OR COLOR.

NO CLAIM IS MADE TO THE EXCLUSIVE RIGHT TO USE THEATRES, APART FROM THE MARK AS SHOWN.

FOR ENTERTAINMENT SERVICES IN THE NATURE OF MOTION PICTURE THEATERS; PROVIDING THEATER LISTINGS; PROVIDING INFORMATION AND REVIEWS CONCERNING PREVIEWS AND REVIEWS OF FILMS, THE FILM INDUSTRY, FILM FESTIVALS, ACTORS, PRODUCERS, DIRECTORS, CONTESTS, PRIZES, MOTION PICTURE GUILDS AND ORGANIZATIONS, TELEVISION PROGRAMS, VIDEO AND AUDIO STREAMING, AND MOTION PICTURE STUDIOS (U.S. CLS. 100, 101 AND 107).

FIRST USE 12-31-1993; IN COMMERCE 12-31-1993.

TIMOTHY FINNEGAN, EXAMINING ATTORNEY

SN 76-641,764. GREER, RONALD S., SPANAWAY, WA. FILED 6-27-2005.

IT'S EVERYTHING..



NO CLAIM IS MADE TO THE EXCLUSIVE RIGHT TO USE "WRESTLING", APART FROM THE MARK AS SHOWN.

THE STIPLING IN THE DRAWING IS FOR SHADING PURPOSES ONLY.

FOR ENTERTAINMENT IN THE NATURE OF PROFESSIONAL WRESTLING EVENTS (U.S. CLS. 100, 101 AND 107).

FIRST USE 6-1-2005; IN COMMERCE 6-1-2005.

JIM RINGLE, EXAMINING ATTORNEY

CLASS 41—(Continued).

SN 76-642,277. FLETCHER, RON, TUCSON, AZ. FILED 7-6-2005.

THE FLETCHER WORK

THE MARK CONSISTS OF STANDARD CHARACTERS WITHOUT CLAIM TO ANY PARTICULAR FONT, STYLE, SIZE, OR COLOR.

OWNER OF U.S. REG. NO. 2,067,146.

THE NAME FLETCHER IDENTIFIES A LIVING INDIVIDUAL WHOSE CONSENT IS OF RECORD.

FOR EDUCATIONAL SERVICES, NAMELY PROVIDING INSTRUCTION AND CONDUCTING PROGRAMS FOR INSTRUCTORS AND STUDENTS ABOUT A PHYSICAL CONDITIONING METHOD, THAT INCLUDES TOWELWORK, FLOORWORK, PERCUSSIVE BREATHING TECHNIQUE, STANDING AND CENTERING AS WELL AS APPARATUS WORK, TO PROMOTE IMPROVED POSTURE AND ALIGNMENT AS WELL AS INCREASED STRENGTH AND FLEXIBILITY (U.S. CLS. 100, 101 AND 107).

FIRST USE 7-16-2004; IN COMMERCE 7-16-2004.

TRICIA SONNEBORN, EXAMINING ATTORNEY

SN 76-643,472. UNIVERSITY OF NORTH CAROLINA AT WILMINGTON, WILMINGTON, NC. FILED 7-22-2005.



OWNER OF U.S. REG. NOS. 1,535,817, 1,545,709 AND 3,048,218.

THE MARK CONSISTS OF AN IMAGE OF A HEAD OF A SEAHAWK BIRD WITH AN IMAGE OF A WAVE AND THE LETTERS UNCW AT THE BASE OF THE DESIGN. THE ENTIRE DESIGN GENERALLY FORMS THE SHAPE OF THE NUMERAL "1".

FOR ENTERTAINMENT SERVICES; NAMELY, CONDUCTING AND PROMOTING MEN'S AND WOMEN'S SPORTING EVENTS AND EDUCATIONAL SERVICES AS A UNIVERSITY; NAMELY, PROVIDING COURSES AT THE UNDERGRADUATE AND GRADUATE LEVELS (U.S. CLS. 100, 101 AND 107).

FIRST USE 7-14-1992; IN COMMERCE 7-14-1992.

LEIGH CAROLINE CASE, EXAMINING ATTORNEY

CLASS 41—(Continued).

SN 76-643,678. VATTEROTT EDUCATIONAL CENTERS, INC., ST. ANN, MO. FILED 7-27-2005.



NO CLAIM IS MADE TO THE EXCLUSIVE RIGHT TO USE L'ÉCOLE CULINAIRE, APART FROM THE MARK AS SHOWN.

THE ENGLISH TRANSLATION OF L'ÉCOLE CULINAIRE IS "THE CULINARY SCHOOL."

FOR EDUCATIONAL SERVICES; NAMELY, CONDUCTING PROFESSIONAL TRAINING IN THE FIELD OF CULINARY ARTS (U.S. CLS. 100, 101 AND 107).

FIRST USE 11-15-2004; IN COMMERCE 11-15-2004.

SAIMA MAKHDOOM, EXAMINING ATTORNEY

SN 76-643,679. VATTEROTT EDUCATIONAL CENTERS, INC., ST. ANN, MO. FILED 7-27-2005.

VATTEROTT COLLEGE

THE MARK CONSISTS OF STANDARD CHARACTERS WITHOUT CLAIM TO ANY PARTICULAR FONT, STYLE, SIZE, OR COLOR.

NO CLAIM IS MADE TO THE EXCLUSIVE RIGHT TO USE "COLLEGE", APART FROM THE MARK AS SHOWN.

SEC. 2(F).

FOR CAREER COUNSELING; EDUCATIONAL SERVICES, NAMELY, VOCATIONAL GUIDANCE AND VOCATIONAL EDUCATION IN THE FIELD OF MECHANICAL, ELECTRICAL, MEDICAL, BUSINESS, COMPUTER, CULINARY, FASHION AND COSMETOLOGY TECHNOLOGY (U.S. CLS. 100, 101 AND 107).

FIRST USE 0-0-1989; IN COMMERCE 0-0-1989.

SAIMA MAKHDOOM, EXAMINING ATTORNEY

CLASS 41—(Continued).

SN 76-644,428. CITY OF PHOENIX, PHOENIX, AZ. FILED 8-5-2005.



NO CLAIM IS MADE TO THE EXCLUSIVE RIGHT TO USE "GANG RESISTANCE EDUCATION AND TRAINING", APART FROM THE MARK AS SHOWN.

THE MARK IS PRESENTED WITH A STYLIZED "G" ENCLOSING STYLIZED LETTERING WITH A PERIOD AFTER EACH LETTER WITH THE WORDS GANG RESISTANCE EDUCATION AND TRAINING APPEARING BENEATH THE ENCLOSURE IN A SEMI-STYLIZED CHARACTER FORMAT.

FOR EDUCATIONAL SERVICES, NAMELY SPONSORING AND CONDUCTING CLASSES, COURSES, WORKSHOPS IN THE FIELD OF LAW ENFORCEMENT AND GANG RESISTANCE EDUCATION (U.S. CLS. 100, 101 AND 107).

FIRST USE 1-15-1992; IN COMMERCE 1-15-1992.
NAAKWAMA ANKRAH, EXAMINING ATTORNEY

SN 76-645,586. PILI INTERNATIONAL MULTIMEDIA CO., LTD., TAIPEI, TAIWAN, FILED 8-24-2005.

FOR ANIMATION PRODUCTION SERVICES, AUDIO RECORDING AND PRODUCTION, MOTION PICTURE FILM PRODUCTION, MOTION PICTURE SONG PRODUCTION, MULTIMEDIA ENTERTAINMENT SOFTWARE PRODUCTION SERVICES, MUSIC PRODUCTION SERVICES, PRODUCTION AND DISTRIBUTION OF MOTION PICTURES, PRODUCTION OF CABLE TELEVISION PROGRAMS, PRODUCTION OF RADIO AND TELEVISION PROGRAMS, DISTRIBUTION OF TELEVISION PROGRAMMING TO CABLE TELEVISION SYSTEMS, SCRIPT WRITING SERVICES, CINEMATOGRAPHIC ADAPTATION AND EDITING, FILM EDITING, VIDEO TAPE EDITING, RENTAL OF CINEMA FILMS, RENTAL OF VIDEOTAPES (U.S. CLS. 100, 101 AND 107).

FIRST USE 7-7-2000; IN COMMERCE 7-7-2000.
PAUL F. GAST, EXAMINING ATTORNEY

CLASS 41—(Continued).

SN 76-645,669. WEALTH BUILDING INSTITUTE, INC., ATLANTA, GA. FILED 8-26-2005.

LUTHER RAGSDALE.COM

THE MARK CONSISTS OF STANDARD CHARACTERS WITHOUT CLAIM TO ANY PARTICULAR FONT, STYLE, SIZE, OR COLOR.

"LUTHER RAGSDALE" IDENTIFIES A LIVING INDIVIDUAL WHOSE CONSENT IS OF RECORD.

FOR ONLINE EDUCATIONAL SERVICES, NAMELY CONDUCTING SEMINARS CONTINUING EDUCATION CLASSES IN THE FIELDS OF REAL ESTATE, REAL ESTATE INVESTMENT AND FINANCIAL INDEPENDENCE, AND DISTRIBUTING COURSE MATERIALS IN CONNECTION THEREWITH (U.S. CLS. 100, 101 AND 107).

FIRST USE 2-8-2003; IN COMMERCE 2-8-2003.
NICHOLAS ALTREE, EXAMINING ATTORNEY

SN 76-647,048. LATINO PUBLIC BROADCASTING, HOLLYWOOD, CA. FILED 9-16-2005.



NO CLAIM IS MADE TO THE EXCLUSIVE RIGHT TO USE "LATINO PUBLIC BROADCASTING", APART FROM THE MARK AS SHOWN.

THE COLOR(S) GREEN, BROWN, RED AND BLACK IS/ARE CLAIMED AS A FEATURE OF THE MARK.

THE MARK CONSISTS OF A GREEN LETTER L AND BROWN AND RED LETTER B SUPERIMPOSED ON A BLACK LETTER P NEXT TO THE CAPITALIZED WORDS "LATINO PUBLIC BROADCASTING".

FOR ENTERTAINMENT SERVICES, NAMELY PRODUCTION OF RADIO AND TELEVISION PROGRAMS BY, FOR AND ABOUT LATINO PEOPLE (U.S. CLS. 100, 101 AND 107).

FIRST USE 3-0-2000; IN COMMERCE 3-0-2000.
RONALD MCMORROW, EXAMINING ATTORNEY

CLASS 41—(Continued).

SN 76-648,390. NEXT VENTURE, LLC, ATLANTA, GA. FILED 10-13-2005.



NO CLAIM IS MADE TO THE EXCLUSIVE RIGHT TO USE "PARTIES" AND "PLAY", APART FROM THE MARK AS SHOWN.

THE COLOR(S) GREEN, RED, YELLOW, PURPLE, AND BLACK IS/ARE CLAIMED AS A FEATURE OF THE MARK. THE WORD "MONKEY" APPEARS IN GREEN WITH A BLACK BORDER. THE WORD "JOE'S" APPEARS IN RED WITH A BLACK BORDER. THE WORDS "PARTIES" AND "PLAY" APPEAR IN YELLOW WITH A BLACK BORDER. THE MONKEY FIGURE APPEARS IN PURPLE WITH A BLACK BORDER, WITH YELLOW AROUND THE OUTSIDE. THE BANANA IN THE MARK APPEARS IN YELLOW WITH A BLACK BORDER.

FOR ENTERTAINMENT SERVICES, NAMELY, INDOOR GYMNASIUMS FOR FAMILY AMUSEMENTS (U.S. CLS. 100, 101 AND 107).
CAROLINE WEIMER, EXAMINING ATTORNEY

SN 76-651,403. RIDIMS MARKETING NETWORK, INC., MIAMI, FL. FILED 12-5-2005.



NO CLAIM IS MADE TO THE EXCLUSIVE RIGHT TO USE "JAMAICAN JERK FESTIVAL", APART FROM THE MARK AS SHOWN.

THE COLORS BLACK, WHITE, GREEN, BLUE, YELLOW, AND ORANGE ARE CLAIMED AS A FEATURE OF THE MARK.

THE COLOR BLACK APPEARS IN THE OUTLINE OF THE WORDING "JAMAICAN JERK FESTIVAL"; THE COLORS WHITE, YELLOW AND ORANGE APPEAR IN THE WORDING "JAMAICAN JERK FESTIVAL"; THE COLORS YELLOW AND ORANGE APPEAR IN THE STYLIZED SMOKE; THE COLOR GREEN APPEARS IN THE PALM TREES, MOUNTAIN LANDSCAPE, AND IN ONE OF THE STRIPES IN THE SKY; THE COLORS WHITE, BLUE AND YELLOW APPEAR IN THE OTHER STRIPES OF THE SKY.

FOR ORGANIZING SPECIAL EVENT FESTIVAL FEATURING A VARIETY OF ACTIVITIES, NAMELY COOKING COMPETITIONS, TASTINGS, COOKING EXHIBITIONS, ARTS AND CRAFTS, AND MUSICAL PERFORMANCES (U.S. CLS. 100, 101 AND 107).

FIRST USE 9-1-2001; IN COMMERCE 9-1-2001.
JOHN KELLY, EXAMINING ATTORNEY

CLASS 41—(Continued).

SN 76-652,647. GOCHA, ALAN, FRANKLIN, MI. FILED 12-29-2005.

CAPTURING THE REAL YOU

THE MARK CONSISTS OF STANDARD CHARACTERS WITHOUT CLAIM TO ANY PARTICULAR FONT, STYLE, SIZE, OR COLOR.

FOR EDITING OR RECORDING OF SOUNDS AND IMAGES; PHOTOGRAPHIC AND VIDEO SERVICES, NAMELY, PHOTOGRAPHY AND VIDEO CAPTURE; PRODUCTION OF VIDEO DISKS FOR OTHERS; ENTERTAINMENT IN THE NATURE OF VISUAL AND AUDIO PERFORMANCES, NAMELY, INTERVIEWS OF INDIVIDUALS; AND SOUND RECORDING STUDIOS (U.S. CLS. 100, 101 AND 107).

TONI HICKEY, EXAMINING ATTORNEY

SN 76-655,453. ELITE PROPERTIES OF AMERICA, INC., COLORADO SPRINGS, CO. FILED 2-22-2006.

FLYING HORSE RANCH

THE MARK CONSISTS OF STANDARD CHARACTERS WITHOUT CLAIM TO ANY PARTICULAR FONT, STYLE, SIZE, OR COLOR.

OWNER OF U.S. REG. NOS. 3,038,231, 3,068,757 AND 3,068,798.

NO CLAIM IS MADE TO THE EXCLUSIVE RIGHT TO USE "HORSE RANCH", APART FROM THE MARK AS SHOWN.

FOR PROVIDING RECREATIONAL AREAS IN THE NATURE OF CHILDREN'S PLAY AREAS (U.S. CLS. 100, 101 AND 107).

BRENDAN REGAN, EXAMINING ATTORNEY

SN 76-656,028. ELITE PROPERTIES OF AMERICA, INC., COLORADO SPRINGS, CO. FILED 3-3-2006.

**FLYING HORSE RANCH**

OWNER OF U.S. REG. NOS. 3,038,231, 3,068,757 AND 3,068,798.

NO CLAIM IS MADE TO THE EXCLUSIVE RIGHT TO USE "HORSE RANCH", APART FROM THE MARK AS SHOWN.

FOR PROVIDING RECREATIONAL AREAS IN THE NATURE OF CHILDREN'S PLAY AREAS (U.S. CLS. 100, 101 AND 107).

BRENDAN REGAN, EXAMINING ATTORNEY

CLASS 41—(Continued).

SN 76-657,019. ZHI GANG SHA, LLC, PETALUMA, CA.
FILED 3-21-2006.

BODY SPACE MEDICINE

THE MARK CONSISTS OF STANDARD CHARACTERS WITHOUT CLAIM TO ANY PARTICULAR FONT, STYLE, SIZE, OR COLOR.

OWNER OF U.S. REG. NO. 3,025,285.

NO CLAIM IS MADE TO THE EXCLUSIVE RIGHT TO USE "BODY" AND "MEDICINE", APART FROM THE MARK AS SHOWN.

FOR EDUCATIONAL SERVICES, NAMELY CONDUCTING CLASSES, COURSES, SEMINARS, CONFERENCES AND WORKSHOPS IN THE FIELD OF ENERGY AND SPIRITUAL HEALING AND PROVIDING COURSE MATERIALS AND SOFTWARE IN CONNECTION THEREWITH (U.S. CLS. 100, 101 AND 107).

FIRST USE 9-3-2004; IN COMMERCE 9-3-2004.
STEVEN JACKSON, EXAMINING ATTORNEY

SN 76-657,685. PRATT, JAROD RHYS, DETROIT, MI. FILED
4-3-2006.

RHYS

THE MARK CONSISTS OF STANDARD CHARACTERS WITHOUT CLAIM TO ANY PARTICULAR FONT, STYLE, SIZE, OR COLOR.

THE NAME RHYS IDENTIFIES A LIVING INDIVIDUAL WHOSE CONSENT IS OF RECORD.

FOR ENTERTAINMENT SERVICES NAMELY, LIVE MUSICAL PERFORMANCES BY A RAP ARTIST; PROVIDING INFORMATION ON A MUSICAL/RAP ARTIST AND SUCH ARTIST'S MUSIC, SOUND AND VIDEO RECORDINGS, PICTURES, NEWS, SPECIAL PROJECTS, TOURS, PERSONAL APPEARANCES AND BIOGRAPHY VIA A WEBSITE ON A GLOBAL COMPUTER NETWORK (U.S. CLS. 100, 101 AND 107).

FIRST USE 4-1-2003; IN COMMERCE 1-22-2004.
TONJA GASKINS, EXAMINING ATTORNEY

SN 76-657,907. ZHI GANG SHA, LLC, PETALUMA, CA.
FILED 4-5-2006.

HEAL THE SOUL FIRST; THEN HEALING OF THE MIND AND BODY WILL FOLLOW

THE MARK CONSISTS OF STANDARD CHARACTERS WITHOUT CLAIM TO ANY PARTICULAR FONT, STYLE, SIZE, OR COLOR.

FOR EDUCATIONAL SERVICES, NAMELY CONDUCTING CLASSES, COURSES, SEMINARS, CONFERENCES AND WORKSHOPS IN THE FIELD OF ENERGY AND SPIRITUAL HEALING AND PROVIDING COURSE MATERIALS AND SOFTWARE IN CONJUNCTION THEREWITH (U.S. CLS. 100, 101 AND 107).

FIRST USE 3-28-2006; IN COMMERCE 3-28-2006.
STEVEN JACKSON, EXAMINING ATTORNEY

CLASS 41—(Continued).

SN 76-657,942. RIVERS, LORETTA J., EAST HARTFORD, CT.
FILED 4-6-2006.

LOJERI PRODUCTIONS

THE MARK CONSISTS OF STANDARD CHARACTERS WITHOUT CLAIM TO ANY PARTICULAR FONT, STYLE, SIZE, OR COLOR.

NO CLAIM IS MADE TO THE EXCLUSIVE RIGHT TO USE "PRODUCTIONS", APART FROM THE MARK AS SHOWN.

FOR ENTERTAINMENT SERVICES, NAMELY, FILM AND VIDEO PRODUCTION AND EDITING; DISTRIBUTION OF FILMS AND PROGRAMMING BROADCAST OVER TELEVISION, SATELLITE, AUDIO, AND VIDEO MEDIA; VIDEOTAPE, DVD, AND CD PRODUCTION; EDITING OF RECORDED SOUNDS AND IMAGES; PHOTOGRAPHY SERVICES, WITH ALL OF THE FOREGOING FEATURING INFORMATION REGARDING MUSEUMS AND NONPROFIT ORGANIZATIONS, FOR BOTH PRIVATE USE AND BROADCAST OVER TELEVISION SATELLITE, INTERNET, AUDIO, AND VIDEO MEDIA (U.S. CLS. 100, 101 AND 107).

FIRST USE 6-3-1996; IN COMMERCE 6-3-1996.
MICHAEL GAAFAR, EXAMINING ATTORNEY

SN 76-658,076. O2 HOLDINGS, LLC, NEW YORK, NY. FILED
4-10-2006.

MO'NIQUE'S FAT CHANCE

THE MARK CONSISTS OF STANDARD CHARACTERS WITHOUT CLAIM TO ANY PARTICULAR FONT, STYLE, SIZE, OR COLOR.

FOR PRODUCTION OF TELEVISION PROGRAMS; PRODUCTION OF RADIO PROGRAMS; EDUCATIONAL AND ENTERTAINMENT SERVICES, NAMELY ONGOING TELEVISION PROGRAMS FEATURING BEAUTY CONTESTS FOR PLUS-SIZED WOMEN PROVIDED BY MEANS OF THE INTERNET, WIRELESS, CABLE, BROADCAST AND SATELLITE TELEVISION; RADIO PROGRAMMING IN THE FIELD OF BEAUTY CONTESTS FOR PLUS-SIZED WOMEN PROVIDED BY MEANS OF THE INTERNET, BROADCAST AND SATELLITE; ELECTRONIC PUBLISHING SERVICES, NAMELY, PUBLICATION OF ARTICLES, QUIZZES, AND PICTURES FEATURING BEAUTY CONTESTS FOR PLUS SIZED WOMEN (U.S. CLS. 100, 101 AND 107).

FIRST USE 8-6-2005; IN COMMERCE 8-6-2005.
ELIZABETH J. WINTER, EXAMINING ATTORNEY

SN 76-658,378. AMERICAN TRANSPORTATION INSTITUTE, INC., FALLS CHURCH, VA. FILED 4-13-2006.

THE AMERICAN DREAM STARTS HERE

THE MARK CONSISTS OF STANDARD CHARACTERS WITHOUT CLAIM TO ANY PARTICULAR FONT, STYLE, SIZE, OR COLOR.

FOR EDUCATIONAL SERVICES, NAMELY THE TRAINING OF OTHERS THROUGH COURSES, SEMINARS, PROGRAMS AND WORKSHOPS IN THE AREAS OF COMPUTER SCIENCE, COMPUTER PROGRAMMING AND COMPUTER NETWORKING, CULINARY ARTS, HOTEL AND EVENT MANAGEMENT, BUSINESS ADMINISTRATION AND HEALTH SCIENCES (U.S. CLS. 100, 101 AND 107).

ELLEN B. AWRICH, EXAMINING ATTORNEY

CLASS 41—(Continued).

SN 76-658,649. QUALITY LIVING INC., OMAHA, NE. FILED 4-18-2006.

JUMPSMART

THE MARK CONSISTS OF STANDARD CHARACTERS WITHOUT CLAIM TO ANY PARTICULAR FONT, STYLE, SIZE, OR COLOR.

FOR BIOMECHANICAL AND NEUROMUSCULAR ATHLETIC TRAINING (U.S. CLS. 100, 101 AND 107).

FIRST USE 1-0-2006; IN COMMERCE 1-0-2006.
CHRISTOPHER BUONGIORNO, EXAMINING ATTORNEY

SN 76-658,700. THINK! INC. NEGOTIATION SOLUTIONS, CHICAGO, IL. FILED 4-19-2006.

THINK!

THE MARK CONSISTS OF STANDARD CHARACTERS WITHOUT CLAIM TO ANY PARTICULAR FONT, STYLE, SIZE, OR COLOR.

FOR SEMINARS AND WORKSHOPS IN THE FIELD OF DEVELOPMENT OF NEGOTIATION, DECISION-MAKING AND CONFLICT RESOLUTIONS SKILLS (U.S. CLS. 100, 101 AND 107).

FIRST USE 9-1-1996; IN COMMERCE 9-1-1996.
KATHRYN COWARD, EXAMINING ATTORNEY

SN 76-661,230. DREAM DINNERS, INC., SNOHOMISH, WA. FILED 6-8-2006.

LIFE JUST GOT EASIER!

THE MARK CONSISTS OF STANDARD CHARACTERS WITHOUT CLAIM TO ANY PARTICULAR FONT, STYLE, SIZE, OR COLOR.

OWNER OF U.S. REG. NO. 2,816,395.
FOR EDUCATIONAL AND ENTERTAINMENT SERVICES IN THE CULINARY FIELD, NAMELY, CONDUCTING CLASSES ON MEAL PLANNING AND PREPARATION, NUTRITION AND THE USE OF CULINARY RESOURCES, EQUIPMENT AND SUPPLIES (U.S. CLS. 100, 101 AND 107).

FIRST USE 6-1-2002; IN COMMERCE 6-1-2002.
JASON ROTH, EXAMINING ATTORNEY

CLASS 41—(Continued).

SN 76-978,015. CHERRY BLOSSOM, INC., BETHESDA, MD. FILED 1-21-2005.

CREDIT UNION

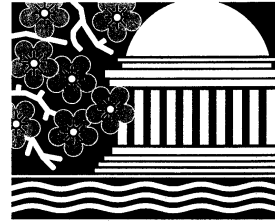

CHERRY BLOSSOM

T E N M I L E R U N

NO CLAIM IS MADE TO THE EXCLUSIVE RIGHT TO USE "TEN MILE RUN", APART FROM THE MARK AS SHOWN.

FOR ARRANGING AND CONDUCTING ATHLETIC COMPETITIONS IN THE NATURE OF A 10 MILE ROAD RACE (U.S. CLS. 100, 101 AND 107).

FIRST USE 0-0-2002; IN COMMERCE 0-0-2002.
RENEE MCCRAY, EXAMINING ATTORNEY

SN 78-326,368. BOMB SQUAD, LLC, FAIRFIELD, CT. FILED 11-11-2003.

THE BOMB SQUAD

THE MARK CONSISTS OF STANDARD CHARACTERS WITHOUT CLAIM TO ANY PARTICULAR FONT, STYLE, SIZE, OR COLOR.

OWNER OF U.S. REG. NO. 3,081,601.
SEC. 2(F).

FOR ENTERTAINMENT SERVICES, NAMELY, LIVE PERFORMANCES BY A MUSICAL GROUP (U.S. CLS. 100, 101 AND 107).

FIRST USE 2-1-2001; IN COMMERCE 2-1-2001.
ANNE MADDEN, EXAMINING ATTORNEY

CLASS 41—(Continued).

SN 78-397,332. AUDIO VISUAL SERVICES CORPORATION,
LONG BEACH, CA. FILED 4-6-2004.

AV2U

THE MARK CONSISTS OF STANDARD CHARACTERS WITHOUT CLAIM TO ANY PARTICULAR FONT, STYLE, SIZE, OR COLOR.

FOR RENTAL OF AUDIO-VISUAL EQUIPMENT FOR MEETING AND CONVENTION FUNCTIONS (U.S. CLS. 100, 101 AND 107).

FIRST USE 1-1-2004; IN COMMERCE 4-1-2004.
NAKWAMA ANKRAH, EXAMINING ATTORNEY

CLASS 41—(Continued).

SN 78-440,980. MANNING, MICHAEL R, PALM COAST, FL.
FILED 6-24-2004.



THE COLORS BLACK, BROWN AND WHITE ARE CLAIMED AS A FEATURE OF THE MARK.

THE COLOR BLACK APPEARS IN THE FIGURES AND THE TOPS OF THE LETTERS; THE COLOR WHITE APPEARS BEHIND THE FIGURES; AND THE REMAINDER OF THE MARK IS BROWN.

THE MARK IS MUDROMP STYLIZED IN BLACK. THE MARK HAS A BROWN SHADE TO IT. THE O IN THE WORD MUDROMP IS LARGER THAN THE OTHER CHARACTERS THAT MAKE UP THE WORD MUDROMP WITH TWO WOMEN IN SILHOUETTE WITHIN THE O. ONE WOMAN IS DEPICTED GRABBING THE OTHER WOMAN'S HAIR.

FOR ENTERTAINMENT IN THE NATURE OF WRESTLING CONTESTS FEATURING WOMEN IN MUD (U.S. CLS. 100, 101 AND 107).

MELVIN AXILBUND, EXAMINING ATTORNEY

SN 78-432,614. COOKIE JAR ENTERTAINMENT INC., MONTREAL, QUEBEC, CANADA, FILED 6-9-2004.

COLISEUM ENTERTAINMENT

THE MARK CONSISTS OF STANDARD CHARACTERS WITHOUT CLAIM TO ANY PARTICULAR FONT, STYLE, SIZE, OR COLOR.

NO CLAIM IS MADE TO THE EXCLUSIVE RIGHT TO USE "ENTERTAINMENT", APART FROM THE MARK AS SHOWN.

FOR ENTERTAINMENT SERVICES FOR CHILDREN, NAMELY, PRODUCTION AND DISTRIBUTION OF ANIMATED TELEVISION PROGRAMS AND MOTION PICTURES FOR CHILDREN; PRODUCTION OF MUSIC FOR CHILDREN; DISTRIBUTION OF ANIMATED TELEVISION PROGRAMS AND MOTION PICTURES FOR CHILDREN ALL FEATURING MUSIC; PROVIDING INFORMATION ONLINE ABOUT ANIMATED CHILDREN'S ENTERTAINMENT PROGRAMS; ELECTRONIC PUBLISHING SERVICES, NAMELY, PUBLISHING OF TEXT AND GRAPHIC WORKS OF OTHERS ON COMPACT DISC, DVD AND ONLINE FEATURING A WIDE RANGE OF ENTERTAINMENT AND EDUCATION SUBJECTS FOR CHILDREN (U.S. CLS. 100, 101 AND 107).

LA TONIA FISHER, EXAMINING ATTORNEY

SN 78-452,141. QUIKSILVER, INC., HUNTINGTON BEACH, CA. FILED 7-16-2004.



OWNER OF U.S. REG. NOS. 2,081,099, 2,211,215 AND 2,765,669.

FOR ENTERTAINMENT IN THE NATURE OF BOARDRIDING SPORTING EVENTS (U.S. CLS. 100, 101 AND 107).

FIRST USE 11-1-1995; IN COMMERCE 11-1-1995.

TONI HICKEY, EXAMINING ATTORNEY

CLASS 41—(Continued).

SN 78-493,081. STODDARD HILL MEDIA HOLDINGS, LLC, DAYTON, OH. FILED 10-1-2004.

CLASS 41—(Continued).

SN 78-506,780. BERG, LORRAINE, MOMENCE, IL. FILED 10-27-2004.

HOSTINGTECH
YOUR CONNECTION TO THE HOSTING INDUSTRY

SEC. 2(F).
FOR PROVIDING NON-DOWNLOADABLE ONLINE ARTICLES AND CURRENT EVENTS NEWS IN THE FIELD OF WEBSITE HOSTING PRODUCTS AND SERVICES (U.S. CLS. 100, 101 AND 107).
FIRST USE 1-11-1999; IN COMMERCE 1-11-1999.
RICHARD WHITE, EXAMINING ATTORNEY



SN 78-495,535. JAMES A. RHODES STATE COLLEGE, LIMA, OH. FILED 10-6-2004.

RHODES
STATE COLLEGE

NO CLAIM IS MADE TO THE EXCLUSIVE RIGHT TO USE "STATE COLLEGE", APART FROM THE MARK AS SHOWN.

THE NAME(S), PORTRAIT(S), AND/OR SIGNATURE(S) SHOWN IN THE MARK DOES NOT IDENTIFY A PARTICULAR LIVING INDIVIDUAL.

FOR EDUCATIONAL SERVICES IN THE NATURE OF COURSES AT THE UNIVERSITY LEVEL, NAMELY, ASSOCIATE DEGREES AND TECHNICAL TRAINING (U.S. CLS. 100, 101 AND 107).

FIRST USE 7-1-2004; IN COMMERCE 7-1-2004.

MATTHEW MCDOWELL, EXAMINING ATTORNEY

NO CLAIM IS MADE TO THE EXCLUSIVE RIGHT TO USE "PERSONAL PROTECTION DOG ASSOCIATION", APART FROM THE MARK AS SHOWN.

THE MARK CONSISTS OF HOUSE WITH A FAMILY OF FOUR LOOKING OUT OF A WINDOW. THE WORDS PERSONAL PROTECTION DIG ASSOCIATION APPEAR BELOW THE HOUSE. THE HOUSE AND WORDING ARE ENCIRCLED BY TWELVE PICTURES OF A FACE OF A DOG.

FOR DOG TRAINING (U.S. CLS. 100, 101 AND 107).

FIRST USE 8-20-1999; IN COMMERCE 8-20-1999.

STEVEN JACKSON, EXAMINING ATTORNEY

CLASS 41—(Continued).

SN 78-513,390. PLAYBOY ENTERPRISES INTERNATIONAL, INC., CHICAGO, IL. FILED 11-8-2004.



THE MARK CONSISTS OF A THREE DIMENSIONAL BUNNY COSTUME WORN BY A WOMAN. THE COSTUME INCLUDES A CORSETED BODICE, BUNNY EARS WORN ON THE HEAD, A BUNNY TAIL ON THE BACK OF THE BODICE, A NAME TAG ON THE FRONT OF THE BODICE, WRIST CUFFS AND A BOW TIE COLLAR. THE DOTTED OUTLINE OF A WOMAN IS NOT A PART OF THE MARK BUT IS MERELY INTENDED TO SHOW THE POSITION OF THE COSTUME.

FOR ENTERTAINMENT SERVICES, NAMELY, PROVIDING AN ON-LINE SERVICE FEATURING IMAGES AND VIDEO CLIPS OF FEMALE MODELS; NEWS REPORTING SERVICES ON THE SUBJECTS OF ART, FASHION, RESTAURANTS, ENTERTAINMENT, TELEVISION, MOVIES, SPORTS, MUSIC, HEALTH, LIFESTYLE, SEX, RELATIONSHIPS, POLITICS AND OTHER AREAS OF GENERAL INTEREST; PROVIDING ON-LINE COMMENTARY AND ARTICLES ON THE SUBJECTS OF ART, ENTERTAINMENT, TELEVISION ENTERTAINMENT, ADULT ENTERTAINMENT, MOVIES, SPORTS, AND MUSIC (U.S. CLS. 100, 101 AND 107).

DAVID TAYLOR, EXAMINING ATTORNEY

CLASS 41—(Continued).

SN 78-520,875. WASHINGTON NATIONALS BASEBALL CLUB, LLC, WASHINGTON, DC. FILED 11-22-2004.



NO CLAIM IS MADE TO THE EXCLUSIVE RIGHT TO USE "DC", APART FROM THE MARK AS SHOWN.

THE MARK CONSISTS OF THE LETTERS "DC" IN STYLIZED FORM.

SEC. 2(F).

FOR ENTERTAINMENT SERVICES, NAMELY, BASEBALL GAMES, COMPETITIONS AND EXHIBITIONS RENDERED LIVE AND THROUGH BROADCAST MEDIA, NAMELY TELEVISION AND RADIO, AND VIA A GLOBAL COMPUTER NETWORK OR A COMMERCIAL ON-LINE SERVICE; INFORMATION SERVICES, NAMELY, PROVIDING INFORMATION IN THE FIELD OF SPORTS, ENTERTAINMENT AND RELATED TOPICS, AND PROVIDING FOR INFORMATIONAL MESSAGES RELATING THERETO; ENTERTAINMENT SERVICES, NAMELY, PROVIDING MULTI-USER INTERACTIVE COMPUTER GAMES ALL VIA A GLOBAL COMPUTER NETWORK OR A COMMERCIAL ON-LINE SERVICE; EDUCATIONAL SERVICES IN THE NATURE OF BASEBALL SKILLS PROGRAMS, BASEBALL CAMPS, SEMINARS AND CLINICS OFFERED LIVE AND THROUGH ON-LINE INSTRUCTION; ENTERTAINMENT SERVICES, NAMELY, PRODUCTION OF PROGRAMMING BROADCAST VIA TELEVISION, RADIO AND A GLOBAL COMPUTER NETWORK OR A COMMERCIAL ON-LINE SERVICE; ORGANIZING COMMUNITY SPORTING EVENTS; PROVIDING FACILITIES FOR SPORTS TOURNAMENTS AND COMPETITIONS RELATING TO BASEBALL; ORGANIZING AND CONDUCTING FANTASY SPORTS, SPORTS CONTESTS AND SWEEPSTAKES; FAN CLUBS; PROVIDING ON-LINE NEWSLETTERS IN THE FIELD OF BASEBALL (U.S. CLS. 100, 101 AND 107).

TIMOTHY FINNEGAN, EXAMINING ATTORNEY

CLASS 41—(Continued).

SN 78-524,477. SAINT-GOBAIN VETROTEx FRANCE S.A.,
CHAMBERY, FRANCE, FILED 11-30-2004.

CLASS 41—(Continued).

SN 78-535,145. CMP MEDIA LLC, MANHASSET, NY. FILED
12-19-2004.

By your side,
worldwide

COMPUTER SECURITY
ALERT

THE MARK CONSISTS OF STANDARD CHARACTERS
WITHOUT CLAIM TO ANY PARTICULAR FONT, STYLE,
SIZE, OR COLOR.

PRIORITY CLAIMED UNDER SEC. 44(D) ON FRANCE
APPLICATION NO. 043318005, FILED 10-13-2004, REG. NO.
043318005, DATED 10-13-2004, EXPIRES 10-13-2014.

FOR EDITING AND PUBLICATION OF NEWSPAPERS,
MAGAZINES, PERIODICALS, BOOKS AND
OTHER PRINTED MATTER; ORGANIZATION OF EDUCATIONAL
CONFERENCES, SYMPOSIUMS, EXHIBITIONS AND SHOWS IN THE FIELD OF
REINFORCEMENT MATERIALS; AND PUBLICATION OF TEXTS OTHER THAN ADVERTISING TEXTS (U.S.
CLS. 100, 101 AND 107).

FIRST USE 10-6-2004; IN COMMERCE 10-6-2004.
STEVEN R. FINE, EXAMINING ATTORNEY

THE MARK CONSISTS OF STANDARD CHARACTERS
WITHOUT CLAIM TO ANY PARTICULAR FONT, STYLE,
SIZE, OR COLOR.

SEC. 2(F).

FOR PROVIDING ONLINE NEWSLETTERS IN THE
FIELDS OF INFORMATION TECHNOLOGY, COMPUTER SECURITY AND NETWORK SECURITY (U.S. CLS.
100, 101 AND 107).

FIRST USE 11-30-1997; IN COMMERCE 11-30-1997.
WENDY GOODMAN, EXAMINING ATTORNEY

SN 78-527,424. BELLEZA DE PUERTO RICO INC., SAN
JUAN, PUERTO RICO, FILED 12-6-2004.

SN 78-553,051. TARRADELLAS, DAN N., LOS ANGELES,
CA. FILED 1-24-2005.



NO CLAIM IS MADE TO THE EXCLUSIVE RIGHT TO
USE "NATIONAL PETITE", APART FROM THE MARK AS
SHOWN.

THE MARK CONSISTS OF A STYLIZED REPRESENTATION
OF A DOLL AND FOUR STARS.

FOR ENTERTAINMENT IN THE NATURE OF
BEAUTY PAGEANTS (U.S. CLS. 100, 101 AND 107).

FIRST USE 8-1-2004; IN COMMERCE 12-1-2004.
RICHARD WHITE, EXAMINING ATTORNEY



FOR ENTERTAINMENT SERVICES, NAMELY, LIVE
PERFORMANCES BY MUSICAL BANDS AND MUSICAL
ROCK BANDS (U.S. CLS. 100, 101 AND 107).

ALLISON HOLTZ, EXAMINING ATTORNEY

CLASS 41—(Continued).

SN 78-555,035. INTERNATIONAL HYPERHIDROSIS SOCIETY, PHILADELPHIA, PA. FILED 1-27-2005.

**International
Hyperhidrosis
Society**

THE MARK CONSISTS OF STANDARD CHARACTERS WITHOUT CLAIM TO ANY PARTICULAR FONT, STYLE, SIZE, OR COLOR.

NO CLAIM IS MADE TO THE EXCLUSIVE RIGHT TO USE "SOCIETY", APART FROM THE MARK AS SHOWN. SEC. 2(F).

FOR EDUCATIONAL SERVICES, NAMELY TEACHING PHYSICIANS AND THE PUBLIC ABOUT HYPERHIDROSIS (U.S. CLS. 100, 101 AND 107).

FIRST USE 9-1-2003; IN COMMERCE 9-1-2004.
STEVEN R. FINE, EXAMINING ATTORNEY

CLASS 41—(Continued).

SN 78-573,608. FOX TELEVISION STUDIOS, INC., LOS ANGELES, CA. FILED 2-23-2005.

WINGWOMEN

THE MARK CONSISTS OF STANDARD CHARACTERS WITHOUT CLAIM TO ANY PARTICULAR FONT, STYLE, SIZE, OR COLOR.

FOR ENTERTAINMENT SERVICES IN THE NATURE OF A TELEVISION SERIES IN THE REALITY GENRE (U.S. CLS. 100, 101 AND 107).

NORA BUCHANAN WILL, EXAMINING ATTORNEY

SN 78-574,155. RESORTS INTERNATIONAL HOTEL, INC., ATLANTIC CITY, NJ. FILED 2-24-2005.

SN 78-571,184. NATURAL SOLUTIONS, INC., IJAMSVILLE, MD. FILED 2-19-2005.



THE MARK CONSISTS OF CLOVER LIKE PLANT HAVING WINGS EXTENDING FROM OPPOSING SIDES WITH A HALO CONTOUR ABOVE THE PLANT AND THE WORDS "NATURAL SOLUTIONS" UNDER THE PLANT.

FOR EDUCATIONAL SERVICES, NAMELY, CONDUCTING CLASSES, WORKSHOPS, SEMINARS, PROGRAMS AND CONFERENCES IN THE FIELD OF HEALTH AND WELLNESS, NAMELY, WEIGHT REDUCTION, NUTRITION, FITNESS, STRESS REDUCTION AND RELAXATION, AND SMOKING CESSATION (U.S. CLS. 100, 101 AND 107).

FIRST USE 1-29-2005; IN COMMERCE 1-29-2005.
IRENE D. WILLIAMS, EXAMINING ATTORNEY



NO CLAIM IS MADE TO THE EXCLUSIVE RIGHT TO USE "CASH", APART FROM THE MARK AS SHOWN.

THE COLORS GREEN, WHITE, AND YELLOW ARE CLAIMED AS A FEATURE OF THE MARK.

THE COLOR GREEN APPEARS IN THE WORDING "EZ CASH", THE COLOR WHITE APPEARS AS A BORDER AROUND THE WORDING; THE COLOR YELLOW APPEARS AS A BACKGROUND.

FOR PROVIDING CASINO SERVICES FEATURING MAGNETICALLY-ENCODED STORED-VALUE TICKETS THAT CAN BE USED TO PLAY SLOT MACHINE GAMES OR BE REDEEMED FOR CASH (U.S. CLS. 100, 101 AND 107).

FIRST USE 4-26-2005; IN COMMERCE 4-26-2005.
KRISTIN DAHLING, EXAMINING ATTORNEY

CLASS 41—(Continued).

SN 78-577,839. WEICHERT CO., MORRIS PLAINS, NJ. FILED 3-1-2005.

Balanced Leadership

THE MARK CONSISTS OF STANDARD CHARACTERS WITHOUT CLAIM TO ANY PARTICULAR FONT, STYLE, SIZE, OR COLOR.

NO CLAIM IS MADE TO THE EXCLUSIVE RIGHT TO USE "LEADERSHIP", APART FROM THE MARK AS SHOWN.

FOR BUSINESS TRAINING IN THE FIELD OF BUSINESS AND PERSONNEL RELOCATION SERVICES; BUSINESS TRAINING IN THE FIELD OF INTERNATIONAL JOB ASSIGNMENT MANAGEMENT SERVICES, NAMELY ADMINISTERING RELOCATION SERVICES ASSOCIATED WITH AN EMPLOYEE'S INTERNATIONAL JOB ASSIGNMENT; AND DISTRIBUTING WRITTEN MATERIALS IN CONNECTION WITH THE TRAINING SERVICES (U.S. CLS. 100, 101 AND 107).

FIRST USE 1-3-2005; IN COMMERCE 1-3-2005.
JOHN KELLY, EXAMINING ATTORNEY

SN 78-583,947. WORDSWORTH, CHLOE FAITH, SCOTTS-DALE, AZ. FILED 3-9-2005.

RESONANCE REPATTERNING

THE MARK CONSISTS OF STANDARD CHARACTERS WITHOUT CLAIM TO ANY PARTICULAR FONT, STYLE, SIZE, OR COLOR.

FOR EDUCATIONAL SERVICES, NAMELY, CONDUCTING SEMINARS, TUTORIALS, CLASSES, EDUCATIONAL DEMONSTRATIONS AND CONFERENCES IN THE FIELD OF HOLISTIC SELF HEALING METHODS OF PERSONAL DEVELOPMENT (U.S. CLS. 100, 101 AND 107).

FIRST USE 3-10-2006; IN COMMERCE 3-10-2006.
KATHERINE STOIDES, EXAMINING ATTORNEY

CLASS 41—(Continued).

SN 78-596,838. WESLEY WORKS, LLC, EMMAUS, PA. FILED 3-29-2005.

WESLEY WORKS

THE MARK CONSISTS OF STANDARD CHARACTERS WITHOUT CLAIM TO ANY PARTICULAR FONT, STYLE, SIZE, OR COLOR.

FOR ENTERTAINMENT SERVICES IN THE NATURE OF DISC JOCKEYS, EMCEES, AND MAGIC SHOWS FOR PARTIES, WEDDINGS, CLASS REUNIONS AND SPECIAL EVENTS; ENTERTAINMENT SERVICES, NAMELY, CONDUCTING PARTIES IN SCHOOLS AND AT SPORTING EVENTS; PHOTOGRAPHY AND VIDEOGRAPHY SERVICES; SPECIAL EVENT PLANNING (U.S. CLS. 100, 101 AND 107).

FIRST USE 7-0-1992; IN COMMERCE 8-0-1999.
SEAN CROWLEY, EXAMINING ATTORNEY

SN 78-605,885. NETWORK ENTERPRISES, INC., NEW YORK, NY. FILED 4-11-2005.

TRUE DADS

THE MARK CONSISTS OF STANDARD CHARACTERS WITHOUT CLAIM TO ANY PARTICULAR FONT, STYLE, SIZE, OR COLOR.

NO CLAIM IS MADE TO THE EXCLUSIVE RIGHT TO USE "DADS", APART FROM THE MARK AS SHOWN.

FOR ENTERTAINMENT SERVICES IN THE NATURE OF A REALITY BASED TELEVISION SERIES FEATURING LIVE ACTION, CLIPS, COMEDY AND DRAMA; PROVIDING ONLINE INFORMATION IN THE FIELD OF ENTERTAINMENT CONCERNING TELEVISION PROGRAMS (U.S. CLS. 100, 101 AND 107).

FIRST USE 12-17-2004; IN COMMERCE 12-17-2004.
DAVID TAYLOR, EXAMINING ATTORNEY

CLASS 41—(Continued).

SN 78-637,316. LOHAN, LARS, SAN FRANCISCO, CA. FILED 5-25-2005.

California Green Girls

THE MARK CONSISTS OF STANDARD CHARACTERS WITHOUT CLAIM TO ANY PARTICULAR FONT, STYLE, SIZE, OR COLOR.

NO CLAIM IS MADE TO THE EXCLUSIVE RIGHT TO USE "CALIFORNIA", APART FROM THE MARK AS SHOWN.

FOR ENTERTAINMENT SERVICES, NAMELY, PROVIDING VISUAL IMAGES AND ARTICLES, IN THE FIELD OF ADULT ENTERTAINMENT VIA A GLOBAL COMPUTER NETWORK, THE INTERNET OR THE WORLD WIDE WEB (U.S. CLS. 100, 101 AND 107).

FIRST USE 1-1-2005; IN COMMERCE 1-1-2005.
JACQUELINE A. LAVINE, EXAMINING ATTORNEY

SN 78-642,127. PRIME WOO CORPORATION, VILLA RICA, GA. FILED 6-2-2005.

Prime Woo

THE MARK CONSISTS OF STANDARD CHARACTERS WITHOUT CLAIM TO ANY PARTICULAR FONT, STYLE, SIZE, OR COLOR.

FOR MUSIC PRODUCTION, MUSIC PUBLISHING, AND MOTION PICTURE PRODUCTION (U.S. CLS. 100, 101 AND 107).

FIRST USE 4-6-2001; IN COMMERCE 3-1-2001.
LESLEY LAMOTHE, EXAMINING ATTORNEY

SN 78-645,851. CORPOSOLAR INC., MIAMI BEACH, FL. FILED 6-7-2005.

La Dieta del Amor

THE MARK CONSISTS OF STANDARD CHARACTERS WITHOUT CLAIM TO ANY PARTICULAR FONT, STYLE, SIZE, OR COLOR.

THE ENGLISH TRANSLATION OF THE WORD "LA DIETA DEL AMOR" IN THE MARK IS "THE LOVE DIET". FOR CONDUCTING SEMINARS AND TRAINING CLASSES AND PRODUCING TELEVISION SHOWS ABOUT INTERPERSONAL RELATIONSHIPS (U.S. CLS. 100, 101 AND 107).

FIRST USE 11-1-2004; IN COMMERCE 11-1-2004.
H. M. FISHER, EXAMINING ATTORNEY

CLASS 41—(Continued).

SN 78-651,284. BROOKS BUFORD INDUSTRIES, INC., NEW YORK, NY. FILED 6-15-2005.

BROOKS BUFORD

THE MARK CONSISTS OF STANDARD CHARACTERS WITHOUT CLAIM TO ANY PARTICULAR FONT, STYLE, SIZE, OR COLOR.

THE NAME(S), PORTRAIT(S), AND/OR SIGNATURE(S) SHOWN IN THE MARK IDENTIFIES JASON BROOKS, WHOSE CONSENT(S) TO REGISTER IS SUBMITTED.

FOR ENTERTAINMENT SERVICES, NAMELY PERFORMANCES BY A LIVE MUSICAL ARTIST AND PROVIDING PRERECORDED MUSIC ONLINE AND INFORMATION REGARDING A MUSICAL ARTIST ONLINE VIA A GLOBAL COMPUTER NETWORK (U.S. CLS. 100, 101 AND 107).

FIRST USE 5-5-2001; IN COMMERCE 5-5-2001.
MARTHA FROMM, EXAMINING ATTORNEY

SN 78-652,569. SEATTLE PACIFIC UNIVERSITY, SEATTLE, WA. FILED 6-16-2005.

COMPETENCE & CHARACTER

THE MARK CONSISTS OF STANDARD CHARACTERS WITHOUT CLAIM TO ANY PARTICULAR FONT, STYLE, SIZE, OR COLOR.

SEC. 2(F).

FOR EDUCATIONAL SERVICES, NAMELY, PROVIDING COURSES OF INSTRUCTION AT THE COLLEGE LEVEL, INCLUDING GRADUATE PROGRAMS (U.S. CLS. 100, 101 AND 107).

FIRST USE 1-0-1998; IN COMMERCE 1-0-1998.
LAURIE MAYES, EXAMINING ATTORNEY

SN 78-656,893. NFL PROPERTIES LLC, NEW YORK, NY. FILED 6-23-2005.

DREAM BIG. PLAY BIG.

THE MARK CONSISTS OF STANDARD CHARACTERS WITHOUT CLAIM TO ANY PARTICULAR FONT, STYLE, SIZE, OR COLOR.

FOR EDUCATION AND ENTERTAINMENT SERVICES, NAMELY, ARRANGING EXHIBITIONS, WORKSHOPS, CLINICS AND COMPETITIONS RELATING TO PHYSICAL FITNESS AND SPORTS; ARRANGING ORGANIZED SPORTS PROGRAMS AND ACTIVITIES; EDUCATION SERVICES, NAMELY PROVIDING WORKSHOPS RELATING TO NUTRITION, HEALTH, PHYSICAL FITNESS AND LIFE SKILLS, NAMELY DECISION MAKING, TIME MANAGEMENT, RESPONSIBILITY, ANGER MANAGEMENT, INTERVIEWING TIPS AND ETIQUETTE AND DISTRIBUTION OF EDUCATIONAL LITERATURE IN CONNECTION THEREWITH; WEB SITE CONTAINING EDUCATION AND ENTERTAINMENT INFORMATION IN THE FIELDS OF PHYSICAL FITNESS AND SPORTS PROGRAMS, NAMELY WORKSHOPS FOCUSED ON YOUTH ISSUES (U.S. CLS. 100, 101 AND 107).

FIRST USE 1-29-2005; IN COMMERCE 1-29-2005.
MICHAEL LEWIS, EXAMINING ATTORNEY

CLASS 41—(Continued).

SN 78-658,181. RECOLLECTION MEDIA, INC., FAIRFIELD, CA. FILED 6-24-2005.

Recollection

THE MARK CONSISTS OF STANDARD CHARACTERS WITHOUT CLAIM TO ANY PARTICULAR FONT, STYLE, SIZE, OR COLOR.

FOR ELECTRONIC PUBLISHING SERVICES, NAMELY, PUBLICATION OF VISIBLY AND AUDIBLY PERCEPTIBLE ANALOG AND DIGITAL WORKS OF OTHERS ON-LINE AND ON REPRODUCIBLE CDS, LASER DISKS AND DVDS, FEATURING LIFE EVENTS; VIDEOTAPE PRODUCTION FEATURING LIFE EVENTS (U.S. CLS. 100, 101 AND 107).

DAWN HAN, EXAMINING ATTORNEY

CLASS 41—(Continued).

SN 78-679,146. MISTER CARMODY PRODUCTIONS, LLC, ANNANDALE, VA. FILED 7-27-2005.

Mystic Harmony

THE MARK CONSISTS OF STANDARD CHARACTERS WITHOUT CLAIM TO ANY PARTICULAR FONT, STYLE, SIZE, OR COLOR.

NO CLAIM IS MADE TO THE EXCLUSIVE RIGHT TO USE "HARMONY", APART FROM THE MARK AS SHOWN. FOR ENTERTAINMENT, NAMELY LIVE PERFORMANCES BY MUSICAL BANDS (U.S. CLS. 100, 101 AND 107).

FIRST USE 6-19-2001; IN COMMERCE 7-17-2005.
YONG KIM, EXAMINING ATTORNEY

SN 78-662,437. SARATOGA AUTOMOBILE MUSEUM, SARATOGA SPRINGS, NY. FILED 7-1-2005.



The logo for Saratoga Automobile Museum features the words "SARATOGA AUTOMOBILE" in a serif font above the word "MUSEUM" in a larger, stylized serif font. A horizontal line is positioned between "AUTOMOBILE" and "MUSEUM".

NO CLAIM IS MADE TO THE EXCLUSIVE RIGHT TO USE "AUTOMOBILE MUSEUM", APART FROM THE MARK AS SHOWN.

SEC. 2(F). FOR AUTOMOBILE MUSEUM SERVICES (U.S. CLS. 100, 101 AND 107).

FIRST USE 6-1-2001; IN COMMERCE 6-1-2001.
ALICE SUE CARRUTHERS, EXAMINING ATTORNEY

SN 78-680,032. DEN-MAT CORPORATION, SANTA MARIA, CA. FILED 7-27-2005.

LUMICAST

THE MARK CONSISTS OF STANDARD CHARACTERS WITHOUT CLAIM TO ANY PARTICULAR FONT, STYLE, SIZE, OR COLOR.

FOR EDUCATIONAL SERVICES, NAMELY, SEMINARS AND TRAINING IN THE FIELD OF DENTISTRY SUITABLE FOR TRANSMISSION VIA GLOBAL COMPUTER NETWORKS (U.S. CLS. 100, 101 AND 107).

FIRST USE 6-20-2005; IN COMMERCE 6-20-2005.
MICHELE SWAIN, EXAMINING ATTORNEY

SN 78-676,524. ENCORE ENTERPRISES, INC., SOUTH HACKENSACK, NJ. FILED 7-22-2005.

Officer Phil

THE MARK CONSISTS OF STANDARD CHARACTERS WITHOUT CLAIM TO ANY PARTICULAR FONT, STYLE, SIZE, OR COLOR.

FOR EDUCATIONAL DEMONSTRATIONS; EDUCATIONAL SERVICES NAMELY CONDUCTING PROGRAMS IN THE FIELD OF CHILDREN'S PERSONAL SAFETY; EDUCATIONAL SERVICES, NAMELY, CONDUCTING WORKSHOPS AND INTERACTIVE PROGRAMS IN THE FIELD OF CHILDREN'S PERSONAL SAFETY AND DISTRIBUTING COURSE MATERIALS IN CONNECTION THEREWITH; INSTRUCTION IN THE FIELD OF CHILDREN'S PERSONAL SAFETY (U.S. CLS. 100, 101 AND 107).

FIRST USE 6-1-1975; IN COMMERCE 6-1-1975.
AMOS T. MATTHEWS, JR., EXAMINING ATTORNEY

SN 78-681,523. NORTH CAROLINA STATE UNIVERSITY, RALEIGH, NC. FILED 7-29-2005.

ClassScape

THE MARK CONSISTS OF STANDARD CHARACTERS WITHOUT CLAIM TO ANY PARTICULAR FONT, STYLE, SIZE, OR COLOR.

FOR EDUCATIONAL SERVICES PROVIDED VIA THE INTERNET IN THE NATURE OF ONLINE MONITORING AND ASSESSMENT BY TEACHERS OF STUDENT PERFORMANCE ON ACADEMIC INDICATORS, NAMELY, ONLINE EDUCATION CREDIT AND DEGREE EVALUATION AND COMPARISON SERVICES (U.S. CLS. 100, 101 AND 107).

FIRST USE 1-26-2005; IN COMMERCE 1-26-2005.
JOHN DWYER, EXAMINING ATTORNEY

CLASS 41—(Continued).

SN 78-683,278. CIS CONFERENCE, INC., SHERMAN, TX.
FILED 8-2-2005.

expanding
excellence

THE COLOR(S) BLUE IS/ARE CLAIMED AS A FEATURE OF THE MARK.

THE MARK CONSISTS OF THE COLOR BLUE WHICH APPEARS IN ALL THE WORDING.

FOR EDUCATIONAL SERVICES, NAMELY, CONDUCTING CONFERENCES FOR UTILITY PERSONNEL IN THE FIELDS OF ELECTRICAL, TELEPHONE, TELEPHONY, GAS, WATER AND SEWER UTILITIES THAT WORK IN COOPERATIVES AND MUNICIPALITIES THROUGHOUT THE UNITED STATES AND FOREIGN COUNTRIES (U.S. CLS. 100, 101 AND 107).

FIRST USE 1-1-2004; IN COMMERCE 1-1-2004.
ANDREA SAUNDERS, EXAMINING ATTORNEY

SN 78-683,576. RISING TIDE ENTERTAINMENT INC., LOS ANGELES, CA. FILED 8-2-2005.

RISING TIDE ENTERTAINMENT

THE MARK CONSISTS OF STANDARD CHARACTERS WITHOUT CLAIM TO ANY PARTICULAR FONT, STYLE, SIZE, OR COLOR.

NO CLAIM IS MADE TO THE EXCLUSIVE RIGHT TO USE "ENTERTAINMENT", APART FROM THE MARK AS SHOWN.

FOR ENTERTAINMENT SERVICES, NAMELY PRODUCTION AND DISTRIBUTION OF FEATURE FILMS, SHORT FILMS, ANIMATED FILMS, DOCUMENTARIES, TELEVISION SHOWS, AND CARTOONS, ALL OF THE ABOVE NOT IN THE FIELD OF POLITICS (U.S. CLS. 100, 101 AND 107).

FIRST USE 2-1-2002; IN COMMERCE 9-1-2005.
SHANNON TWOHIG, EXAMINING ATTORNEY

SN 78-688,426. LIDYARD-MANGUM, SUSAN DANIEL, HOUSTON, TX. FILED 8-9-2005.

CORKY

THE MARK CONSISTS OF STANDARD CHARACTERS WITHOUT CLAIM TO ANY PARTICULAR FONT, STYLE, SIZE, OR COLOR.

THE NAME CORKY DOES NOT IDENTIFY A LIVING INDIVIDUAL.

FOR CONDUCTING ENTERTAINMENT EXHIBITIONS FOR CHILDREN IN THE NATURE OF LIVE PERFORMANCES AT CHILDREN'S BIRTHDAY PARTIES BY A CLOWN, FEATURING PHYSICAL COMEDY, BALLOON SCULPTING AND MAGIC SHOW PERFORMANCES (U.S. CLS. 100, 101 AND 107).

FIRST USE 10-12-1994; IN COMMERCE 10-12-1994.
BARBARA A. LOUGHRAN, EXAMINING ATTORNEY

CLASS 41—(Continued).

SN 78-689,346. M.D. PERRY & ASSOCIATES, KNOXVILLE, TN. FILED 8-10-2005.



THE COLOR(S) RED, GRAY AND BLACK IS/ARE CLAIMED AS A FEATURE OF THE MARK.

THE TWO INACTIVE ATOM PATHS CREATING AN "X" DESIGN ARE RED, THE CIRCLE IS RED, THE HORIZONTAL ATOM PATH IS GRAY WITH A GRAY CIRCLE AND THE WORDING X-QUEST IS BLACK.

FOR EDUCATIONAL SERVICES, NAMELY, CONDUCTING EDUCATIONAL PROGRAMS IN THE FIELD OF SPACE SCIENCES AND DISTRIBUTING COURSE MATERIALS IN CONNECTION THEREWITH; PROVIDING AMUSEMENT FACILITIES; RECREATIONAL CAMPS; SUMMER CAMPS (U.S. CLS. 100, 101 AND 107).

FIRST USE 6-6-2004; IN COMMERCE 5-13-2005.
MICHELE SWAIN, EXAMINING ATTORNEY

SN 78-694,888. JBP COMPANY, DBA GLOWING GREENS, BLOOMINGTON, IL. FILED 8-17-2005.



NO CLAIM IS MADE TO THE EXCLUSIVE RIGHT TO USE "GREENS", APART FROM THE MARK AS SHOWN.

THE MARK CONSISTS OF SCRIPTED LETTERS INCLUDING A FLAG WITH THE NUMBER 18 AS A PART OF THE "L" IN THE WORD GLOWING AND OVERSIZE DOT AS A PART OF THE "I" IN THE WORD GLOWING. THE WORD GREENS IS SCRIPTED UNDERNEATH THE WORD GLOWING AND BOTH WORDS ARE SEMI-SURROUND BY A CONTINUOUS LINE SHAPED LIKE A CONTOURED PUTTING GREEN FROM THE FIRST "G" IN THE WORD GLOWING TO THE LAST "G" IN THE WORD GLOWING.

FOR PROVIDING GOLF FACILITIES (U.S. CLS. 100, 101 AND 107).

FIRST USE 6-1-2005; IN COMMERCE 6-20-2005.
STEPHANIE DAVIS, EXAMINING ATTORNEY

CLASS 41—(Continued).

SN 78-695,552. READING & LANGUAGE ARTS CENTERS, INC., BLOOMFIELD HILLS, MI. FILED 8-18-2005.

BETTER BRAINS CLUB

THE MARK CONSISTS OF STANDARD CHARACTERS WITHOUT CLAIM TO ANY PARTICULAR FONT, STYLE, SIZE, OR COLOR.

NO CLAIM IS MADE TO THE EXCLUSIVE RIGHT TO USE "CLUB", APART FROM THE MARK AS SHOWN.

FOR EDUCATIONAL SERVICES, NAMELY, PROVIDE STUDENT TUTORIAL COURSES IN READING, SPELLING, VOCABULARY, WRITING, AND MATHEMATICS (U.S. CLS. 100, 101 AND 107).

FIRST USE 8-30-2004; IN COMMERCE 11-24-2004.
AMEETA JORDAN, EXAMINING ATTORNEY

SN 78-695,622. XFIT, INC., NEW YORK, NY. FILED 8-18-2005.

X - FIT
EXCELLENCE IN FITNESS

NO CLAIM IS MADE TO THE EXCLUSIVE RIGHT TO USE "EXCELLENCE IN FITNESS", APART FROM THE MARK AS SHOWN.

FOR PERSONAL TRAINING SERVICES, NAMELY STRENGTH AND CONDITIONING TRAINING, PHYSICAL FITNESS INSTRUCTION (U.S. CLS. 100, 101 AND 107).

FIRST USE 8-20-1999; IN COMMERCE 8-20-1999.
ANNE E. GUSTASON, EXAMINING ATTORNEY

SN 78-697,175. SONY PICTURES TELEVISION INC., CULVER CITY, CA. FILED 8-22-2005.

GAY ROBOT

THE MARK CONSISTS OF STANDARD CHARACTERS WITHOUT CLAIM TO ANY PARTICULAR FONT, STYLE, SIZE, OR COLOR.

FOR ENTERTAINMENT SERVICES IN THE NATURE OF A TELEVISION COMEDY SERIES (U.S. CLS. 100, 101 AND 107).

ELIZABETH BEYER, EXAMINING ATTORNEY

CLASS 41—(Continued).

SN 78-698,331. PI BETA PHI FRATERNITY, TOWN & COUNTRY, MO. FILED 8-23-2005.

LEADING WITH VALUES

THE MARK CONSISTS OF STANDARD CHARACTERS WITHOUT CLAIM TO ANY PARTICULAR FONT, STYLE, SIZE, OR COLOR.

FOR EDUCATIONAL SERVICES, NAMELY, WORKSHOPS, SEMINARS, MENTORING PROGRAMS, CULTURAL PROGRAMS, AND INDEPENDENT STUDY IN THE AREAS OF ORGANIZATIONAL KNOWLEDGE, CITIZENSHIP, AND INTELLECTUAL AND LEADERSHIP DEVELOPMENT (U.S. CLS. 100, 101 AND 107).

FIRST USE 6-0-2003; IN COMMERCE 6-0-2003.
DAVID MILLER, EXAMINING ATTORNEY

SN 78-699,375. SPORTSCENTRE AUTHENTICATED, RUTLAND, MA. FILED 8-24-2005.

V.O.A.

THE MARK CONSISTS OF STANDARD CHARACTERS WITHOUT CLAIM TO ANY PARTICULAR FONT, STYLE, SIZE, OR COLOR.

FOR MULTIMEDIA ENTERTAINMENT SOFTWARE PRODUCTION SERVICES (U.S. CLS. 100, 101 AND 107).

FIRST USE 1-1-2004; IN COMMERCE 8-21-2005.

SALLY SHIH, EXAMINING ATTORNEY

SN 78-700,969. BRIEM, GUNNLAUGUR SE, EMERYVILLE, CA. FILED 8-26-2005.

Operina

THE MARK CONSISTS OF STANDARD CHARACTERS WITHOUT CLAIM TO ANY PARTICULAR FONT, STYLE, SIZE, OR COLOR.

OWNER OF U.S. REG. NO. 3,050,545.

FOR PUBLISHING OF BOOKS AND MAGAZINES; PUBLISHING OF ELECTRONIC PUBLICATIONS; ELECTRONIC PUBLISHING SERVICES, NAMELY, PUBLICATION OF TEXT AND GRAPHIC WORKS OF OTHERS ON-LINE FEATURING CLASSIC AND PUBLIC DOMAIN AND OUT-OF-PRINT WORKS (U.S. CLS. 100, 101 AND 107).

FIRST USE 8-5-2006; IN COMMERCE 8-5-2006.
AMY GEARIN, EXAMINING ATTORNEY

CLASS 41—(Continued).

SN 78-701,020. NATIONAL SECURITY AGENCY, FT. MEADE, MD. FILED 8-26-2005.



NO CLAIM IS MADE TO THE EXCLUSIVE RIGHT TO USE "HIGH ASSURANCE INTERNET PROTOCOL ENCRYPTOR", APART FROM THE MARK AS SHOWN.

THE MARK CONSISTS OF A SQUARE WITH CROPPED CORNERS ENCOMPASSING A GLOBE HAVING A V-CUT RIBBON WRAPPED AROUND IT WITH THE CURVED WORD HAIPÉ BENEATH AND THE WORDS HIGH ASSURANCE INTERNET PROTOCOL ENCRYPTOR ABOVE.

FOR ARRANGING OF SEMINARS AND CONFERENCES (U.S. CLS. 100, 101 AND 107).

LAURA HAMMEL, EXAMINING ATTORNEY

CLASS 41—(Continued).

SN 78-703,245. PFIP, LLC, DOVER, NH. FILED 8-30-2005.

JF GYMS

THE MARK CONSISTS OF STANDARD CHARACTERS WITHOUT CLAIM TO ANY PARTICULAR FONT, STYLE, SIZE, OR COLOR.

NO CLAIM IS MADE TO THE EXCLUSIVE RIGHT TO USE "GYMS", APART FROM THE MARK AS SHOWN.

FOR PHYSICAL FITNESS INSTRUCTION AND TRAINING; HEALTH CLUB SERVICES, NAMELY PROVIDING INSTRUCTION AND EQUIPMENT IN THE FIELD OF PHYSICAL EXERCISE (U.S. CLS. 100, 101 AND 107).

MATTHEW PAPPAS, EXAMINING ATTORNEY

SN 78-703,736. NORDFORS, DAVID A., STANFORD, CA. FILED 8-30-2005.

SN 78-702,994. MAINLY MUSIC INCORPORATED, AUCKLAND, NEW ZEALAND, FILED 8-30-2005.

MAINLY MUSIC

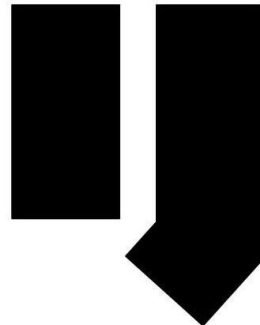

THE MARK CONSISTS OF THE LETTERS "IJ".

FOR ONLINE PUBLICATION OF EDUCATIONAL ARTICLES AND JOURNALS IN THE FIELD OF JOURNALISM COVERING COMMERCIALIZATION OF EMERGING TECHNOLOGIES; EDUCATIONAL SERVICES, NAMELY, ARRANGING AND CONDUCTING CONFERENCES, SYMPOSIUMS, PROGRAMS AND WORKSHOPS IN THE FIELD OF JOURNALISM COVERING COMMERCIALIZATION OF EMERGING TECHNOLOGIES AND DISTRIBUTION OF ELECTRONIC, AUDIO, VIDEO AND PRINTED COURSE MATERIALS THEREWITH (U.S. CLS. 100, 101 AND 107).

ANNE FARRELL, EXAMINING ATTORNEY

THE MARK CONSISTS OF STANDARD CHARACTERS WITHOUT CLAIM TO ANY PARTICULAR FONT, STYLE, SIZE, OR COLOR.

NO CLAIM IS MADE TO THE EXCLUSIVE RIGHT TO USE "MUSIC", APART FROM THE MARK AS SHOWN.

FOR EDUCATIONAL AND ENTERTAINMENT SERVICES, NAMELY, PROVIDING MUSIC CLASSES FOR THE ENJOYMENT OF CHILDREN AND ADULTS (U.S. CLS. 100, 101 AND 107).

FIRST USE 11-2-2004; IN COMMERCE 11-2-2004.
TRICIA SONNEBORN, EXAMINING ATTORNEY

CLASS 41—(Continued).

SN 78-705,479. FRIDAE.COM LIMITED, GEORGE TOWN,
GRAND CAYMAN, CAYMAN ISLANDS, FILED 9-1-2005.

fridæ

CLASS 41—(Continued).

SN 78-707,054. MWM AND ASSOCIATES INCORPORATED,
FORT WAYNE, IN. FILED 9-6-2005.

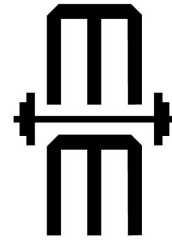

MANAGEMENT
WITH MUSCLE

NO CLAIM IS MADE TO THE EXCLUSIVE RIGHT TO USE "MANAGEMENT", APART FROM THE MARK AS SHOWN.

FOR EDUCATIONAL SERVICES, NAMELY CONDUCTING SEMINARS IN THE FIELD OF BUSINESS MANAGEMENT AND DISTRIBUTING COURSE MATERIALS IN CONNECTION THEREWITH (U.S. CLS. 100, 101 AND 107).

JOHN DALIER, EXAMINING ATTORNEY

SN 78-707,652. FITNESS ANYWHERE, INC., SAN FRANCISCO, CA. FILED 9-6-2005.

FOR ARRANGING OF SEMINARS; CONDUCTING OF SEMINARS RELATED TO PROMOTING THE INTERESTS OF THE GAY COMMUNITY IN THE FIELDS OF POLITICS, HEALTH, ENTERTAINMENT, AND SPORTS; ARRANGING OF SYMPOSIUMS; CONDUCTING OF SYMPOSIUMS RELATED TO PROMOTING THE INTERESTS OF THE GAY COMMUNITY IN THE FIELDS OF POLITICS, HEALTH, ENTERTAINMENT, AND SPORTS; ARRANGING PROFESSIONAL WORKSHOP AND TRAINING COURSES; ARRANGING OF BEAUTY CONTESTS; NIGHTCLUB SERVICES; DISCOTHEQUE SERVICES; PUBLISHING OF ELECTRONIC DESKTOP PUBLISHING; ENTERTAINER SERVICES, NAMELY, LIVE APPEARANCES BY A PROFESSIONAL ENTERTAINER; ENTERTAINMENT SERVICES, NAMELY, BOOKING OF ENTERTAINMENT HALLS; ENTERTAINMENT SERVICES, NAMELY, PROVIDING INFORMATION IN THE FIELD OF MUSIC; PRESENTATION OF LIVE SHOW PERFORMANCES; ORGANIZATION OF BALLS; ORGANIZATION OF COMPETITIONS, NAMELY, GAMES; ORGANIZATION OF DANCE SHOWS; PARTY PLANNING; PRODUCTION OF RADIO AND TELEVISION PROGRAMS; PRODUCTION OF TELEVISION SHOWS; PROVIDING NON-DOWNLOADABLE ON-LINE ELECTRONIC PUBLICATIONS IN THE FIELD OF SPORTS; PUBLICATION OF BOOKS; ONLINE PUBLICATION OF ELECTRONIC BOOKS AND JOURNALS; PUBLICATION OF TEXTS OTHER THAN PUBLICITY TEXTS; RADIO ENTERTAINMENT PRODUCTION; PROVIDING FACILITIES FOR RECREATION ACTIVITIES; PROVIDING INFORMATION IN THE FIELD OF RECREATIONAL ACTIVITIES; ORGANIZATION OF ENTERTAINMENT AND SOCIAL EVENTS, NAMELY, DANCE EVENTS; ORGANIZATION OF RECREATIONAL EVENTS, NAMELY, SPORT FISHING COMPETITIONS (U.S. CLS. 100, 101 AND 107).

DAVID MURRAY, EXAMINING ATTORNEY



OWNER OF U.S. REG. NO. 2,945,125.

"THE COLOR(S) YELLOW, BLACK, AND WHITE IS/ARE CLAIMED AS A FEATURE OF THE MARK."

THE MARK CONSISTS OF THE COLOR YELLOW APPEARING THROUGHOUT THE ENTIRETY OF THE BACKGROUND CIRCLE DESIGN IN THE MARK. THE COLOR WHITE APPEARS IN THE STYLIZED "X" / HUMAN DESIGN ELEMENT IN THE MARK. THE COLOR BLACK APPEARS AS SHADING IN THE STYLIZED "X" / HUMAN DESIGN ELEMENT IN THE MARK.

FOR PHYSICAL FITNESS CONSULTATION; PHYSICAL FITNESS INSTRUCTION (U.S. CLS. 100, 101 AND 107).

FIRST USE 7-1-2004; IN COMMERCE 7-1-2004.

BARBARA A. LOUGHRAN, EXAMINING ATTORNEY

CLASS 41—(Continued).

SN 78-708,076. PFIIP, LLC, DOVER, NH. FILED 9-7-2005.

JFZ GYMS

THE MARK CONSISTS OF STANDARD CHARACTERS WITHOUT CLAIM TO ANY PARTICULAR FONT, STYLE, SIZE, OR COLOR.

NO CLAIM IS MADE TO THE EXCLUSIVE RIGHT TO USE "GYMS", APART FROM THE MARK AS SHOWN.

FOR PHYSICAL FITNESS INSTRUCTION AND TRAINING; HEALTH CLUB SERVICES, NAMELY PROVIDING INSTRUCTION AND EQUIPMENT IN THE FIELD OF PHYSICAL EXERCISE (U.S. CLS. 100, 101 AND 107).

MARTHA SANTOMARTINO, EXAMINING ATTORNEY

SN 78-709,186. INLINE HOCKEY ASSOCIATION, INC., COLORADO SPRINGS, CO. FILED 9-8-2005.



NO CLAIM IS MADE TO THE EXCLUSIVE RIGHT TO USE "INLINE HOCKEY ASSOCIATION", APART FROM THE MARK AS SHOWN.

THE MARK CONSISTS OF THE WORDS "INLINE HOCKEY ASSOCIATION" IN RELATIVELY SMALL TYPE ABOVE THE CAPITAL LETTERS "IHA" ARRANGED ADJACENT TO EACH OTHER, TOGETHER WITH THE DEPICTION OF A HOCKEY PUCK IN FRONT OF THE LETTERS "IHA" AND A DEPICTION OF THE PATH OVER WHICH THAT HOCKEY PUCK HAS MOVED. COLOR IS NOT A FEATURE OF THE MARK.

FOR SPORTING ACTIVITIES, NAMELY, PROVIDING PROFESSIONAL INLINE HOCKEY EXHIBITIONS (U.S. CLS. 100, 101 AND 107).

FIRST USE 8-28-2005; IN COMMERCE 8-28-2005.

ARETHA SOMERVILLE, EXAMINING ATTORNEY

CLASS 41—(Continued).

SN 78-710,745. SUZUKI, KIMIKO, TOKYO, JAPAN, FILED 9-12-2005.

POSTURE STYLIST

THE MARK CONSISTS OF STANDARD CHARACTERS WITHOUT CLAIM TO ANY PARTICULAR FONT, STYLE, SIZE, OR COLOR.

FOR PUBLICATION OF BOOKS IN THE FIELD OF GYMNASTICS; PRODUCTION OF TAPES, COMPACT DISCS AND DIGITAL VIDEO DISCS IN THE FIELD OF GYMNASTICS; ARRANGING AND CONDUCTING EDUCATIONAL CONFERENCES AND SEMINARS RELATING TO THE FIELD OF GYMNASTICS; EDUCATIONAL SERVICES, NAMELY, CONDUCTING CLASSES, SEMINARS, CONFERENCES AND WORKSHOPS IN THE FIELD OF GYMNASTICS AND DISTRIBUTING COURSE MATERIALS IN CONNECTION THEREWITH; PHYSICAL FITNESS INSTRUCTION SERVICES (U.S. CLS. 100, 101 AND 107).

PRISCILLA MILTON, EXAMINING ATTORNEY

SN 78-711,768. THOMAS AND STACEY SIEBEL FOUNDATION, SAN MATEO, CA. FILED 9-13-2005.

NOT EVEN ONCE

THE MARK CONSISTS OF STANDARD CHARACTERS WITHOUT CLAIM TO ANY PARTICULAR FONT, STYLE, SIZE, OR COLOR.

FOR PREPARING AND DISSEMINATING EDUCATIONAL AND PUBLIC SERVICE ADVERTISING MATERIAL RELATED TO THE PREVENTION OF METHAMPHETAMINE ABUSE FOR OTHERS; ELECTRONIC PUBLISHING SERVICES, NAMELY, PUBLICATION OF VIDEO, TEXT, AUDIO, AND GRAPHIC WORKS OF OTHERS ON ELECTRONIC MEDIA, NAMELY, ONLINE WEB AND INTERNET, VIDEOTAPE, CDS, DVDS, RADIO AND TELEVISION, FEATURING METHAMPHETAMINE ABUSE AND PREVENTION INFORMATION (U.S. CLS. 100, 101 AND 107).

FIRST USE 8-30-2005; IN COMMERCE 8-30-2005.

LEIGH CAROLINE CASE, EXAMINING ATTORNEY

SN 78-711,829. WATKINS, MICHAEL, JACKSON, TN. FILED 9-13-2005.

NFINITE

THE MARK CONSISTS OF STANDARD CHARACTERS WITHOUT CLAIM TO ANY PARTICULAR FONT, STYLE, SIZE, OR COLOR.

FOR MUSIC PRODUCTION SERVICES (U.S. CLS. 100, 101 AND 107).

IRENE D. WILLIAMS, EXAMINING ATTORNEY

CLASS 41—(Continued).

SN 78-712,360. BUBBA RAY DUDLEY, INC., LAKE MARY, FL. FILED 9-13-2005.

TEAM 3D

THE MARK CONSISTS OF STANDARD CHARACTERS WITHOUT CLAIM TO ANY PARTICULAR FONT, STYLE, SIZE, OR COLOR.

NO CLAIM IS MADE TO THE EXCLUSIVE RIGHT TO USE "TEAM", APART FROM THE MARK AS SHOWN.

FOR ENTERTAINMENT IN THE NATURE OF WRESTLING CONTESTS (U.S. CLS. 100, 101 AND 107).

FIRST USE 8-26-2005; IN COMMERCE 8-26-2005.
JOHN DALIER, EXAMINING ATTORNEY

SN 78-712,599. NATIONAL WIND WATCH, HAWLEY, MA. FILED 9-14-2005.

Wind Watch

THE MARK CONSISTS OF STANDARD CHARACTERS WITHOUT CLAIM TO ANY PARTICULAR FONT, STYLE, SIZE, OR COLOR.

FOR DEVELOPMENT AND DISSEMINATION OF ORIGINAL EDUCATIONAL MATERIALS AND THOSE OF OTHERS IN THE FIELD OF ENVIRONMENTAL IMPACTS OF INDUSTRIAL WIND ENERGY FACILITIES (U.S. CLS. 100, 101 AND 107).

FIRST USE 5-24-2005; IN COMMERCE 7-20-2005.
JOHN DALIER, EXAMINING ATTORNEY

SN 78-712,876. DISNEY ENTERPRISES, INC., BURBANK, CA. FILED 9-14-2005.

MAGIC YOUR WAY

THE MARK CONSISTS OF STANDARD CHARACTERS WITHOUT CLAIM TO ANY PARTICULAR FONT, STYLE, SIZE, OR COLOR.

FOR AMUSEMENT PARK SERVICES RENDERED VIA A MULTI-PARK ADMISSION TICKET (U.S. CLS. 100, 101 AND 107).

FIRST USE 12-13-2004; IN COMMERCE 12-13-2004.
LEIGH LOWRY, EXAMINING ATTORNEY

CLASS 41—(Continued).

SN 78-713,655. ROCKLAND FESTIVAL CORP., ROCKLAND, ME. FILED 9-15-2005.



THE MARK CONSISTS OF THE PHRASE "MAINE LOBSTER FESTIVAL" WITHIN A CIRCLE SURROUNDING A DEPICTION OF A LOBSTER.

SEC. 2(F) AS TO "MAINE LOBSTER FESTIVAL" AND THE DESIGN OF A LOBSTER.

FOR ORGANIZING FESTIVALS FEATURING A VARIETY OF ACTIVITIES, NAMELY, ART AND PHOTOGRAPHY EXHIBITS, MUSICAL PERFORMANCES, LIVE THEATRICAL PERFORMANCES, COOKING CONTESTS, EATING CONTESTS, EXHIBITS AND THE LIKE (U.S. CLS. 100, 101 AND 107).

FIRST USE 9-15-1995; IN COMMERCE 9-15-1995.
KATRINA EDGE, EXAMINING ATTORNEY

SN 78-714,274. NEW PUBLISHING LLC, ALBUQUERQUE, NM. FILED 9-16-2005.

NEW AT HOME

THE MARK CONSISTS OF STANDARD CHARACTERS WITHOUT CLAIM TO ANY PARTICULAR FONT, STYLE, SIZE, OR COLOR.

FOR PUBLICATION OF PRINTED AND ONLINE MAGAZINES, BOOKS, NEWSLETTERS, AND ARTICLES (U.S. CLS. 100, 101 AND 107).

FIRST USE 12-31-2004; IN COMMERCE 3-15-2005.
HEATHER THOMPSON, EXAMINING ATTORNEY

SN 78-714,426. UNITED STATES ANTI-DOPING AGENCY, COLORADO SPRINGS, CO. FILED 9-16-2005.



FOR DEVELOPMENT AND DISSEMINATION OF SPORTS EDUCATIONAL INFORMATION, SPECIFICALLY INFORMATION CONCERNING ILLEGAL OR PROHIBITED PERFORMANCE ENHANCING SUBSTANCES (U.S. CLS. 100, 101 AND 107).

FIRST USE 6-1-2004; IN COMMERCE 10-8-2004.
JOHN SCHUYLER YARD, EXAMINING ATTORNEY

CLASS 41—(Continued).

SN 78-715,727. FEUERSTEIN, STEVE, BRONX, NY. FILED 9-19-2005.

Arena Institute for Sports Marketing & Event Management

THE MARK CONSISTS OF STANDARD CHARACTERS WITHOUT CLAIM TO ANY PARTICULAR FONT, STYLE, SIZE, OR COLOR.

NO CLAIM IS MADE TO THE EXCLUSIVE RIGHT TO USE "INSTITUTE FOR SPORTS MARKETING & EVENT MANAGEMENT", APART FROM THE MARK AS SHOWN.

FOR EDUCATIONAL SERVICES IN THE NATURE OF CORPORATE AND VOCATIONAL TRAINING, COURSES, SEMINARS, EDUCATIONAL PROGRAMS, MENTORING, AND DEMONSTRATIONS ALL IN THE FIELD OF SPORTS MARKETING AND EVENT MANAGEMENT; CONDUCTING EDUCATIONAL EXHIBITIONS IN THE NATURE OF WORKSHOPS IN THE FIELD OF SPORTS MARKETING AND EVENT MANAGEMENT (U.S. CLS. 100, 101 AND 107).

LINDA ORNDORFF, EXAMINING ATTORNEY

CLASS 41—(Continued).

SN 78-716,263. WINTER, RONNIE HARVEY, JR., MIDDLEBURG, FL. FILED 9-20-2005.

The Red Jumpsuit Apparatus

THE MARK CONSISTS OF STANDARD CHARACTERS WITHOUT CLAIM TO ANY PARTICULAR FONT, STYLE, SIZE, OR COLOR.

FOR ENTERTAINMENT NAMELY, LIVE PERFORMANCES BY A MUSICAL BAND; ENTERTAINMENT, NAMELY LIVE MUSIC CONCERTS (U.S. CLS. 100, 101 AND 107).

FIRST USE 1-1-2003; IN COMMERCE 1-1-2003.

AISHA CLARKE, EXAMINING ATTORNEY

SN 78-718,447. OUTHOUSE CLASSICS, INC., TRENARY, MI. FILED 9-22-2005.

OUTHOUSE CLASSIC

THE MARK CONSISTS OF STANDARD CHARACTERS WITHOUT CLAIM TO ANY PARTICULAR FONT, STYLE, SIZE, OR COLOR.

NO CLAIM IS MADE TO THE EXCLUSIVE RIGHT TO USE "CLASSIC", APART FROM THE MARK AS SHOWN.

SEC. 2(F).

FOR ENTERTAINMENT IN THE NATURE OF COMPETITIONS IN THE FIELD OF OUTHOUSE RACING (U.S. CLS. 100, 101 AND 107).

FIRST USE 1-1-1993; IN COMMERCE 1-1-1993.

BARBARA BROWN, EXAMINING ATTORNEY

SN 78-719,367. YOGA ONE, LLC, CHARLOTTE, NC. FILED 9-23-2005.

YOGA ONE

THE MARK CONSISTS OF AN ATLAS HOLDING A SPHERE.

FOR PROVIDING AN ONLINE ELECTRONIC NEWSLETTER FEATURING PROMOTIONAL INFORMATION ABOUT SPECIAL EVENTS, LOCAL RESTAURANTS, SHOPS AND SPECIALS, DISCOUNTS AND PROMOTIONAL OPPORTUNITIES (U.S. CLS. 100, 101 AND 107).

FIRST USE 3-0-2005; IN COMMERCE 3-0-2005.

MELISSA VALLILLO, EXAMINING ATTORNEY



THE MARK CONSISTS OF STANDARD CHARACTERS WITHOUT CLAIM TO ANY PARTICULAR FONT, STYLE, SIZE, OR COLOR.

NO CLAIM IS MADE TO THE EXCLUSIVE RIGHT TO USE "YOGA", APART FROM THE MARK AS SHOWN.

FOR PROVIDING INSTRUCTION, EQUIPMENT AND FACILITIES IN THE FIELD OF YOGA AND WELLNESS (U.S. CLS. 100, 101 AND 107).

GRETTA YAO, EXAMINING ATTORNEY

CLASS 41—(Continued).

SN 78-719,974. UNIVERSITY OF WEST FLORIDA, PENSACOLA, FL. FILED 9-24-2005.

**ICL INSTITUTE FOR
INNOVATIVE COMMUNITY
LEARNING**

THE MARK CONSISTS OF STANDARD CHARACTERS WITHOUT CLAIM TO ANY PARTICULAR FONT, STYLE, SIZE, OR COLOR.

NO CLAIM IS MADE TO THE EXCLUSIVE RIGHT TO USE INSTITUTE FOR INNOVATIVE COMMUNITY LEARNING, APART FROM THE MARK AS SHOWN.

FOR EDUCATIONAL SERVICES, NAMELY, PROVIDING COURSES OF INSTRUCTION AT THE COLLEGE LEVEL (U.S. CLS. 100, 101 AND 107).

FIRST USE 7-1-2005; IN COMMERCE 7-1-2005.

RUDY R. SINGLETON, EXAMINING ATTORNEY

SN 78-720,550. HILLS, ELIZABETH A., PACIFIC GROVE, CA. AND HUDSON, KAREN M., PACIFIC GROVE, CA. FILED 9-26-2005.

**The Goddess to Goddess
Empower Hour**

THE MARK CONSISTS OF STANDARD CHARACTERS WITHOUT CLAIM TO ANY PARTICULAR FONT, STYLE, SIZE, OR COLOR.

FOR AWARDS PROGRAM FOR MAJOR CORPORATIONS AND INDIVIDUALS WHO HAVE MADE SIGNIFICANT CHARITABLE CONTRIBUTIONS; CABLE TELEVISION PROGRAMMING; CONTESTS AND INCENTIVE AWARD PROGRAMS TO ENCOURAGE STUDENTS AND ORGANIZATION MEMBERS TO SET UP AND ACHIEVE GOALS IN ACADEMICS, ATTENDANCE, CITIZENSHIP AND CONDUCT; DIRECTION OF MAKING RADIO OR TELEVISION PROGRAMS; DISTRIBUTION OF RADIO PROGRAMS FOR OTHERS; DISTRIBUTION OF TELEVISION PROGRAMMING TO CABLE TELEVISION SYSTEMS; DISTRIBUTION OF TELEVISION PROGRAMS FOR OTHERS; DVD AUTHORIZING SERVICES; EDUCATIONAL SERVICES NAMELY CONDUCTING PROGRAMS IN THE FIELD OF SELF-HELP AND EMPOWERMENT; ENTERTAINMENT IN THE NATURE OF ON-GOING TELEVISION PROGRAMS IN THE FIELD OF CHILDREN'S ENTERTAINMENT; ENTERTAINMENT SERVICES, NAMELY, PROVIDING A RADIO PROGRAM IN THE FIELD OF SELF-HELP

CLASS 41—(Continued).

PERSONAL EMPOWERMENT VIA A GLOBAL COMPUTER NETWORK; ENTERTAINMENT SERVICES, NAMELY, PROVIDING A TELEVISION PROGRAM IN THE FIELD OF SELF-HELP PERSONAL EMPOWERMENT VIA A GLOBAL COMPUTER NETWORK; OPERATION OF VIDEO EQUIPMENT OR AUDIO EQUIPMENT ETC; FOR PRODUCTION OF RADIO OR TELEVISION PROGRAMS; PRODUCTION OF CABLE TELEVISION PROGRAMS; PRODUCTION OF CLOSED CAPTION TELEVISION PROGRAMS; PRODUCTION OF RADIO AND TELEVISION PROGRAMS; PRODUCTION OF RADIO OR TELEVISION PROGRAMS; PROGRAMMING ON A GLOBAL COMPUTER NETWORK; RADIO ENTERTAINMENT PRODUCTION; RADIO ENTERTAINMENT SERVICES, NAMELY RADIO PROGRAMS FEATURING PERFORMANCES BY A DUO OF CO-HOSTS, KAREN HUDSON AND ELIZABETH HILLS; RADIO PROGRAMMING; TELEVISION AND RADIO PROGRAMMING; TELEVISION PROGRAM SYNDICATION; TELEVISION PROGRAMMING; TELEVISION SCHEDULING (U.S. CLS. 100, 101 AND 107).

FIRST USE 5-8-2005; IN COMMERCE 5-8-2005.

AISHA CLARKE, EXAMINING ATTORNEY

SN 78-720,664. TELEMUNDO NETWORK GROUP LLC, HIALEAH, FL. FILED 9-26-2005.

CADA DIA

THE MARK CONSISTS OF STANDARD CHARACTERS WITHOUT CLAIM TO ANY PARTICULAR FONT, STYLE, SIZE, OR COLOR.

THE FOREIGN WORDING IN THE MARK TRANSLATES INTO ENGLISH AS EVERYDAY.

FOR ENTERTAINMENT SERVICES, NAMELY, PROVIDING A TELEVISION PROGRAM IN THE FIELD OF NEWS, GENERAL INFORMATION IN THE FIELD OF HEALTH, FITNESS, COOKING, FASHION, ASTROLOGY, ECONOMY, IMMIGRATION; ENTERTAINMENT, NAMELY ARTIST INTERVIEWS, MUSIC PERFORMANCES, AND SPORTS VIA A GLOBAL COMPUTER NETWORK; ENTERTAINMENT, NAMELY A COMEDY, DRAMA, VARIETY AND SPORTS SHOW BROADCAST OVER TELEVISION, SATELLITE, AUDIO AND VIDEO MEDIA (U.S. CLS. 100, 101 AND 107).

JASON TURNER, EXAMINING ATTORNEY

SN 78-723,472. THE AMERICAN ASSEMBLY, NEW YORK, NY. FILED 9-29-2005.

The American Assembly

THE MARK CONSISTS OF STANDARD CHARACTERS WITHOUT CLAIM TO ANY PARTICULAR FONT, STYLE, SIZE, OR COLOR.

SEC. 2(F).

FOR EDUCATIONAL SERVICES, NAMELY, CONDUCTING CONFERENCES IN THE FIELD OF PUBLIC POLICY (U.S. CLS. 100, 101 AND 107).

FIRST USE 8-14-1950; IN COMMERCE 10-18-1950.

PAM WILLIS, EXAMINING ATTORNEY

CLASS 41—(Continued).

SN 78-727,167. DIRECTV, INC., EL SEGUNDO, CA. FILED 10-5-2005.

MASSIVE GAMING LEAGUE

THE MARK CONSISTS OF STANDARD CHARACTERS WITHOUT CLAIM TO ANY PARTICULAR FONT, STYLE, SIZE, OR COLOR.

NO CLAIM IS MADE TO THE EXCLUSIVE RIGHT TO USE "GAMING LEAGUE", APART FROM THE MARK AS SHOWN.

FOR DISTRIBUTION OF TELEVISION PROGRAMS FOR OTHERS; EDUCATIONAL SERVICES, NAMELY, CONDUCTING ON-LINE EXHIBITIONS AND DISPLAYS AND INTERACTIVE EXHIBITS IN THE FIELD OF VIDEO GAMES; ENTERTAINMENT SERVICES, NAMELY, PROVIDING A TELEVISION PROGRAM IN THE FIELD OF VIDEO GAMES VIA A GLOBAL COMPUTER NETWORK; ENTERTAINMENT SERVICES, NAMELY, PROVIDING AN ON-LINE COMPUTER GAME; ENTERTAINMENT SERVICES, NAMELY, PROVIDING ON-LINE COMPUTER GAMES; ENTERTAINMENT SERVICES, NAMELY, PROVIDING ON-LINE REVIEWS OF VIDEO GAMES; ORGANISATION OF GAMES; PROVIDING A COMPUTER GAME THAT MAY BE ACCESSED NETWORK-WIDE BY NETWORK USERS; PROVIDING INFORMATION ON-LINE RELATING TO COMPUTER GAMES AND COMPUTER ENHANCEMENTS FOR GAMES; PROVIDING NEWSLETTERS IN THE FIELD OF VIDEO GAMES VIA E-MAIL; PROVIDING RATINGS FOR TELEVISION, MOVIE, MUSIC, VIDEO AND VIDEO GAME CONTENT; PUBLICATION OF ELECTRONIC MAGAZINES; RENTAL OF VIDEO GAMES; TELEVISION PROGRAMMING; TELEVISION SCHEDULING (U.S. CLS. 100, 101 AND 107).

SKYE YOUNG, EXAMINING ATTORNEY

SN 78-728,640. UNITED STATES ANTI-DOPING AGENCY, COLORADO SPRINGS, CO. FILED 10-7-2005.

SPIRIT OF SPORT

THE MARK CONSISTS OF STANDARD CHARACTERS WITHOUT CLAIM TO ANY PARTICULAR FONT, STYLE, SIZE, OR COLOR.

FOR DEVELOPMENT AND DISSEMINATION OF INFORMATION AND EDUCATIONAL MATERIALS OF OTHERS IN THE FIELD OF ILLEGAL OR PROHIBITED PERFORMANCE ENHANCING SUBSTANCES AND METHODS (U.S. CLS. 100, 101 AND 107).

KATHERINE M. DUBRAY, EXAMINING ATTORNEY

CLASS 41—(Continued).

SN 78-732,182. NORTHSTAR TRAVEL MEDIA, LLC, SECAUCUS, NJ. FILED 10-12-2005.



OWNER OF U.S. REG. NOS. 1,926,150 AND 2,115,995.

NO CLAIM IS MADE TO THE EXCLUSIVE RIGHT TO USE "AWARD", APART FROM THE MARK AS SHOWN.

FOR PROVIDING RECOGNITION BY THE WAY OF AWARDS TO DEMONSTRATE EXCELLENCE IN THE FIELD OF FOOD AND BEVERAGE QUALITY AND SERVICE AT CONFERENCE AND MEETING FACILITIES (U.S. CLS. 100, 101 AND 107).

FIRST USE 1-1-2004; IN COMMERCE 1-1-2004.

SEAN CROWLEY, EXAMINING ATTORNEY

SN 78-735,008. HANSA ONE, INC., PRINCETON, NJ. FILED 10-18-2005.

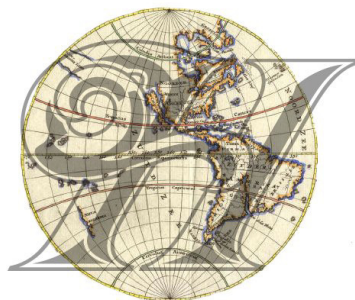

THE COLOR(S) TAN, BLUE, YELLOW, GRAY, AND WHITE IS/ARE CLAIMED AS A FEATURE OF THE MARK.

THE "H" IS GRAY AND WHITE; THE LATITUDE AND LONGITUDE LINES AND THE OTHER WRITING IS GRAY; THE CONTINENTS ARE OUTLINED IN BLUE AND THEN TAN; THE OUTER CIRCLES ARE YELLOW AND GRAY.

FOR EDUCATIONAL SERVICES, NAMELY, PROVIDING CLASSES, SEMINARS AND WORKSHOPS IN THE FIELDS OF LANGUAGE INSTRUCTION, BUSINESS CULTURAL CONSULTING, TRANSLATIONS SERVICES AND LANGUAGE INTERPRETATIONS (U.S. CLS. 100, 101 AND 107).

FIRST USE 10-17-2004; IN COMMERCE 10-17-2004.

PAUL E. FAHRENKOPF, EXAMINING ATTORNEY

CLASS 41—(Continued).

SN 78-735,015. HANSA ONE, INC., PRINCETON, NJ. FILED 10-18-2005.

HANSA ONE

THE MARK CONSISTS OF STANDARD CHARACTERS WITHOUT CLAIM TO ANY PARTICULAR FONT, STYLE, SIZE, OR COLOR.

FOR EDUCATIONAL SERVICES, NAMELY PROVIDING CLASSES, SEMINARS, WORKSHOPS IN THE FIELD OF LANGUAGE INSTRUCTION, BUSINESS CULTURAL CONSULTING, TRANSLATIONS SERVICES AND LANGUAGE INTERPRETATIONS (U.S. CLS. 100, 101 AND 107).

FIRST USE 10-17-2005; IN COMMERCE 10-17-2005.
PAUL E. FAHRENKOPF, EXAMINING ATTORNEY

SN 78-735,017. HANSA ONE, INC., PRINCETON, NJ. FILED 10-18-2005.

THE COLORS BLACK AND BLUE ARE CLAIMED AS A FEATURE OF THE MARK.

THE FIRST "A" IN HANSA IS BLUE; THE OTHER LETTERS ARE BLACK.

FOR EDUCATIONAL SERVICES, NAMELY PROVIDING CLASSES, SEMINARS AND WORKSHOPS IN THE FIELDS OF LANGUAGE INSTRUCTION, BUSINESS CULTURAL CONSULTING, TRANSLATION SERVICES AND LANGUAGE INTERPRETATIONS (U.S. CLS. 100, 101 AND 107).

FIRST USE 10-17-2005; IN COMMERCE 10-17-2005.
PAUL E. FAHRENKOPF, EXAMINING ATTORNEY

SN 78-741,680. TIME TO EAT, LLC, WESTPORT, CT. FILED 10-27-2005.

TIME TO EAT

THE MARK CONSISTS OF STANDARD CHARACTERS WITHOUT CLAIM TO ANY PARTICULAR FONT, STYLE, SIZE, OR COLOR.

FOR EDUCATIONAL SERVICES, NAMELY, CONDUCTING COURSES OF INSTRUCTION IN THE FIELD OF COOKING; ENTERTAINMENT IN THE NATURE OF COOKING SHOWS (U.S. CLS. 100, 101 AND 107).

FIRST USE 9-30-2002; IN COMMERCE 9-30-2002.
BERYL GARDNER, EXAMINING ATTORNEY

CLASS 41—(Continued).

SN 78-742,667. BLUE HEART TOURS, INC., ALEXANDRIA, VA. FILED 10-28-2005.

MELODIA! CHILDREN'S MUSIC FESTIVAL

THE MARK CONSISTS OF STANDARD CHARACTERS WITHOUT CLAIM TO ANY PARTICULAR FONT, STYLE, SIZE, OR COLOR.

NO CLAIM IS MADE TO THE EXCLUSIVE RIGHT TO USE "CHILDREN'S MUSIC FESTIVAL", APART FROM THE MARK AS SHOWN.

FOR ENTERTAINMENT SERVICES, NAMELY, ORGANIZING LIVE MUSIC CONCERTS AND LIVE PERFORMANCES AND CONCERTS BY CHILDREN'S CHOIRS; EDUCATION SERVICES, NAMELY, ORGANIZING AND CONDUCTING MUSICAL WORKSHOPS AND CLASSES FOR CHILDREN (U.S. CLS. 100, 101 AND 107).

FIRST USE 10-22-2005; IN COMMERCE 10-22-2005.
CHARLES L. JENKINS, EXAMINING ATTORNEY

SN 78-745,046. THE SCHILLINGER GROUP LLC, HAMBURG, NJ. FILED 11-2-2005.

Program for Powerful Learning

THE MARK CONSISTS OF STANDARD CHARACTERS WITHOUT CLAIM TO ANY PARTICULAR FONT, STYLE, SIZE, OR COLOR.

NO CLAIM IS MADE TO THE EXCLUSIVE RIGHT TO USE "PROGRAM" AND "LEARNING", APART FROM THE MARK AS SHOWN.

FOR ANALYZING EDUCATIONAL TESTS SCORES AND DATA FOR OTHERS; ARRANGING AND CONDUCTING EDUCATIONAL CONFERENCES; ARRANGING PROFESSIONAL WORKSHOP AND TRAINING COURSES; CONDUCTING WORKSHOPS AND SEMINARS IN LITERACY ACHIEVEMENT; DEVELOPING EDUCATIONAL MANUALS FOR OTHERS IN THE FIELD OF LITERACY; EDUCATION SERVICES, NAMELY, MENTORING IN THE FIELD OF LITERACY; EDUCATION SERVICES, NAMELY, PROVIDING TUTORIAL SESSIONS IN THE FIELD OF LITERACY; EDUCATION SERVICES, NAMELY, PROVIDING SEMINARS, WORKSHOPS, AND DEMONSTRATIONS IN THE FIELD OF LITERACY; EDUCATIONAL DEMONSTRATIONS; EDUCATIONAL SERVICES, NAMELY CONDUCTING PROGRAMS IN THE FIELD OF LITERACY; EDUCATIONAL SERVICES, NAMELY, CONDUCTING WORKSHOPS, SEMINARS AND DEMONSTRATIONS IN THE FIELD OF LITERACY AND DISTRIBUTING COURSE MATERIALS IN CONNECTION THEREWITH; PROVIDING COURSES OF INSTRUCTION AT THE ELEMENTARY, MIDDLE AND HIGH SCHOOL LEVEL; WORKSHOPS AND SEMINARS IN THE FIELD OF LITERACY (U.S. CLS. 100, 101 AND 107).

FIRST USE 7-1-2005; IN COMMERCE 7-1-2005.
JIM RINGLE, EXAMINING ATTORNEY

CLASS 41—(Continued).

SN 78-746,760. WARNER BROS. ENTERTAINMENT INC.,
BURBANK, CA. FILED 11-3-2005.



NO CLAIM IS MADE TO THE EXCLUSIVE RIGHT TO USE "TOON" AND "TV", APART FROM THE MARK AS SHOWN.

FOR ENTERTAINMENT SERVICES, NAMELY, PROVIDING LINKS TO A WEB SITE FEATURING GENERAL INTEREST ENTERTAINMENT PROGRAMMING AND CONTENT (U.S. CLS. 100, 101 AND 107).

MATTHEW PAPPAS, EXAMINING ATTORNEY

SN 78-748,659. SENIOR TRIP, INC., NASHVILLE, TN. FILED
11-7-2005.

MARK LOWRY SENIOR TRIP

THE MARK CONSISTS OF STANDARD CHARACTERS WITHOUT CLAIM TO ANY PARTICULAR FONT, STYLE, SIZE, OR COLOR.

NO CLAIM IS MADE TO THE EXCLUSIVE RIGHT TO USE "SENIOR TRIP", APART FROM THE MARK AS SHOWN.

THE NAME MARK LOWRY IDENTIFIES A LIVING INDIVIDUAL WHOSE CONSENT IS OF RECORD.

FOR ENTERTAINMENT SERVICES, NAMELY PROVIDING MOTIVATIONAL SPEAKERS AND LIVE PERFORMANCES BY MUSICAL BANDS AND COMEDIANS (U.S. CLS. 100, 101 AND 107).

FIRST USE 7-12-2005; IN COMMERCE 7-12-2005.

JASON TURNER, EXAMINING ATTORNEY

CLASS 41—(Continued).

SN 78-750,901. MALAGA, TAMRA, QUEENS, NY. FILED 11-9-2005.

THE JOSH AND TAMRA SHOW

THE MARK CONSISTS OF STANDARD CHARACTERS WITHOUT CLAIM TO ANY PARTICULAR FONT, STYLE, SIZE, OR COLOR.

NO CLAIM IS MADE TO THE EXCLUSIVE RIGHT TO USE "SHOW", APART FROM THE MARK AS SHOWN.

THE NAME JOSH AND TAMRA IDENTIFIES A LIVING INDIVIDUAL WHOSE CONSENT IS OF RECORD.

FOR ENTERTAINMENT IN THE NATURE OF LIVE PERFORMANCES BY INDIVIDUALS AND PUPPETEERS PERFORMING COMEDY SKETCH ROUTINES USING PUPPETS; ENTERTAINMENT IN THE NATURE OF THEATER PRODUCTIONS; ENTERTAINMENT IN THE NATURE OF VISUAL AND AUDIO PERFORMANCES, AND MUSICAL, VARIETY, NEWS AND COMEDY SHOWS; ENTERTAINMENT NAMELY, PRODUCTION OF COMEDY SKETCH ROUTINES USING PUPPETS; ENTERTAINMENT SERVICES NAMELY LIVE APPEARANCES BY A PROFESSIONAL ENTERTAINER (U.S. CLS. 100, 101 AND 107).

FIRST USE 2-15-2001; IN COMMERCE 2-15-2001.

JOHN GARTNER, EXAMINING ATTORNEY

SN 78-757,810. LORI J. WINCHELL, SACO, ME. FILED 11-20-2005.

GOTMICE

THE MARK CONSISTS OF STANDARD CHARACTERS WITHOUT CLAIM TO ANY PARTICULAR FONT, STYLE, SIZE, OR COLOR.

SEC. 2(F).

FOR PHOTOGRAPHY SERVICES (U.S. CLS. 100, 101 AND 107).

JESSICA A. POWERS, EXAMINING ATTORNEY

SN 78-759,712. TATHAM, WILLIAM, JR., SANTA BARBARA, CA. FILED 11-22-2005.

RED ZONE RUGBY WORLD CUP

THE MARK CONSISTS OF STANDARD CHARACTERS WITHOUT CLAIM TO ANY PARTICULAR FONT, STYLE, SIZE, OR COLOR.

NO CLAIM IS MADE TO THE EXCLUSIVE RIGHT TO USE "RUGBY WORLD CUP", APART FROM THE MARK AS SHOWN.

FOR ENTERTAINMENT IN THE NATURE OF RUGBY FOOTBALL GAMES (U.S. CLS. 100, 101 AND 107).

SEAN CROWLEY, EXAMINING ATTORNEY

CLASS 41—(Continued).

SN 78-762,168. KABUSHIKI KAISHA SEGA, DBA SEGA CORPORATION, TOKYO, JAPAN, FILED 11-29-2005.



THE MARK IS NOT IN COLOR.

FOR ENTERTAINMENT IN THE NATURE OF AN ANIMATED TELEVISION SERIES; PRODUCTION OF ANIMATION TELEVISION PROGRAMS AND ANIMATION MOVIES; DISTRIBUTION OF ANIMATION TELEVISION PROGRAMS AND ANIMATION MOVIES FOR OTHERS; PROVIDING A WEBSITE FEATURING ANIMATION; PROVIDING AMUSEMENT FACILITIES (U.S. CLS. 100, 101 AND 107).

YONG KIM, EXAMINING ATTORNEY

SN 78-762,341. FAR EAST BROADCASTING COMPANY, LA MIRADA, CA. FILED 11-29-2005.

FAR EAST BROADCASTING COMPANY

THE MARK CONSISTS OF STANDARD CHARACTERS WITHOUT CLAIM TO ANY PARTICULAR FONT, STYLE, SIZE, OR COLOR.

NO CLAIM IS MADE TO THE EXCLUSIVE RIGHT TO USE "BROADCASTING COMPANY", APART FROM THE MARK AS SHOWN.

SEC. 2(F).

FOR PROVIDING A RADIO PROGRAM FEATURING SEMINARY AND BIBLE CLASSES FOR THE TRAINING OF CHRISTIAN LEADERS AND BELIEVERS IN MATTERS OF CHURCH AND INDIVIDUAL GROWTH, EVANGELISM, PRAYER, MISSIONS, AND DISCIPLESHIP (U.S. CLS. 100, 101 AND 107).

FIRST USE 12-31-1945; IN COMMERCE 12-31-1945.

MARY MUNSON, EXAMINING ATTORNEY

SN 78-766,399. SOWING SEEDS, SAN FRANCISCO, CA. FILED 12-5-2005.

LAUNCHING YOUR LEGACY

THE MARK CONSISTS OF STANDARD CHARACTERS WITHOUT CLAIM TO ANY PARTICULAR FONT, STYLE, SIZE, OR COLOR.

FOR EDUCATIONAL SERVICES, NAMELY, PROVIDING SEMINARS, FORUMS, AND PROFESSIONAL TRAINING, AND FAMILY COACHING IN THE FIELD OF FINANCIAL AND ESTATE PLANNING (U.S. CLS. 100, 101 AND 107).

FIRST USE 10-1-2005; IN COMMERCE 10-1-2005.

ALICE SUE CARRUTHERS, EXAMINING ATTORNEY

CLASS 41—(Continued).

SN 78-766,755. CITY OF PIGEON FORGE, TENNESSEE, PIGEON FORGE, TN. FILED 12-5-2005.

STRING TIME IN THE SMOKIES

THE MARK CONSISTS OF STANDARD CHARACTERS WITHOUT CLAIM TO ANY PARTICULAR FONT, STYLE, SIZE, OR COLOR.

FOR EDUCATIONAL RETREAT SERVICES, NAMELY, PROVIDING CLASSES, WORKSHOPS AND LECTURES IN THE FIELD OF OLD-TIME MOUNTAIN MUSIC AND IN BANJOS, MANDOLINS, FIDDLES, MOUNTAIN DULCIMERS, AND GUITAR; ENTERTAINMENT SERVICES IN THE NATURE OF A MUSIC FESTIVAL AND LIVE PERFORMANCES BY GROUPS AND INDIVIDUALS (U.S. CLS. 100, 101 AND 107).

FIRST USE 1-0-2004; IN COMMERCE 1-0-2004.

MYRIAH HABEEB, EXAMINING ATTORNEY

SN 78-769,587. HDNET LLC, DALLAS, TX. FILED 12-8-2005.

DEADLINE!

THE MARK CONSISTS OF STANDARD CHARACTERS WITHOUT CLAIM TO ANY PARTICULAR FONT, STYLE, SIZE, OR COLOR.

FOR ENTERTAINMENT SERVICES IN THE NATURE OF ON-GOING TELEVISION PROGRAMS IN THE FIELD OF COMEDY (U.S. CLS. 100, 101 AND 107).

FIRST USE 6-3-2005; IN COMMERCE 6-3-2005.

SUSAN RICHARDS, EXAMINING ATTORNEY

SN 78-771,436. GROOVE LABS LLC, AUSTIN, TX. FILED 12-12-2005.

GROOVE LABS

THE MARK CONSISTS OF STANDARD CHARACTERS WITHOUT CLAIM TO ANY PARTICULAR FONT, STYLE, SIZE, OR COLOR.

FOR CONDUCTING MUSIC-BASED CORPORATE TEAM BUILDING WORKSHOPS, CLASSES, SEMINARS AND CONFERENCES RELATING TO LEADERSHIP SKILLS, INTEROFFICE RELATIONSHIPS, TEAMWORK, CREATIVITY SKILLS, AND COMMUNICATION SKILLS, AND DISTRIBUTING COURSE MATERIALS IN CONNECTION THEREWITH (U.S. CLS. 100, 101 AND 107).

FIRST USE 10-25-2002; IN COMMERCE 10-25-2002.

AMY BROZENIC, EXAMINING ATTORNEY

CLASS 41—(Continued).

SN 78-773,421. SHUFFLE MASTER, INC., LAS VEGAS, NV. FILED 12-14-2005.



NO CLAIM IS MADE TO THE EXCLUSIVE RIGHT TO USE "BLACKJACK", APART FROM THE MARK AS SHOWN.

THE MARK CONSISTS OF A FILIGREE AT THE TOP AND BOTTOM PORTIONS OF THE MARK WITH THE STYLIZED WORDS FORTUNE BLACKJACK AND THE ACE OF SPADES AND KING OF SPADES IN THE MIDDLE PORTION OF THE MARK.

FOR ENTERTAINMENT SERVICES, NAMELY PROVIDING LIVE GAMES OF CHANCE TO GAMING ESTABLISHMENTS (U.S. CLS. 100, 101 AND 107).

FIRST USE 9-13-2005; IN COMMERCE 9-13-2005.
TINA BROWN, EXAMINING ATTORNEY

CLASS 41—(Continued).

SN 78-775,119. SCAPELLATO, JAMES EDWARD, ATLANTA, GA. FILED 12-16-2005.

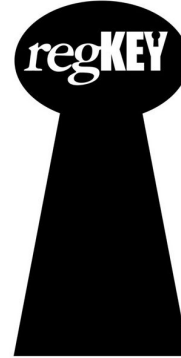

FOR DRIVER SAFETY TRAINING (U.S. CLS. 100, 101 AND 107).

MELISSA VALLILLO, EXAMINING ATTORNEY

SN 78-774,965. GROOVE LABS, AUSTIN, TX. FILED 12-16-2005.

Play with the Pros Music

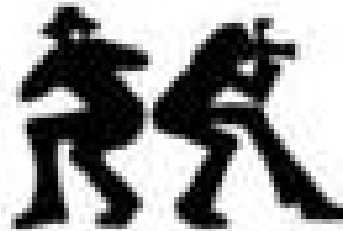

THE MARK CONSISTS OF STANDARD CHARACTERS WITHOUT CLAIM TO ANY PARTICULAR FONT, STYLE, SIZE, OR COLOR.

NO CLAIM IS MADE TO THE EXCLUSIVE RIGHT TO USE "MUSIC", APART FROM THE MARK AS SHOWN.

FOR PROVIDING LIVE KARAOKE SERVICES ALLOWING PARTICIPANTS TO PERFORM WITH A LIVE BAND (U.S. CLS. 100, 101 AND 107).

FIRST USE 10-22-2002; IN COMMERCE 12-18-2002.
AMY BROZENIC, EXAMINING ATTORNEY

SN 78-776,717. PAPARAZZI BY APPOINTMENT, LLC, OMAHA, NE. FILED 12-19-2005.

THE SILHOUETTES OF THE TWO FIGURES ARE BLACK ON A WHITE BACKGROUND WITH THE LENS OF THE CAMERA ALSO APPEARING WHITE.

FOR PHOTOGRAPHY SERVICES (U.S. CLS. 100, 101 AND 107).

FIRST USE 2-1-2001; IN COMMERCE 5-1-2001.
JOHN DWYER, EXAMINING ATTORNEY

CLASS 41—(Continued).

SN 78-776,935. GYM-MARK, INC., SAN FRANCISCO, CA. FILED 12-20-2005.

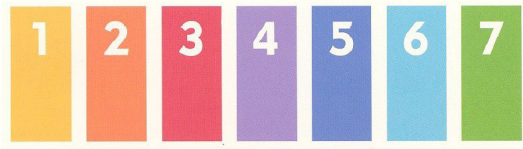

"THE COLOR(S) YELLOW, ORANGE, RED, PURPLE, BLUE, LIGHT BLUE, GREEN, AND WHITE IS/ARE CLAIMED AS A FEATURE OF THE MARK."

STARTING ON THE LEFT, THE COLOR YELLOW APPEARS IN THE FIRST RECTANGLE, THE COLOR ORANGE APPEARS IN THE SECOND RECTANGLE, THE COLOR RED APPEARS IN THE THIRD RECTANGLE, THE COLOR PURPLE APPEARS IN THE FOURTH RECTANGLE, THE COLOR BLUE APPEARS IN THE FIFTH RECTANGLE, THE COLOR LIGHT BLUE APPEARS IN THE SIXTH RECTANGLE, THE COLOR GREEN APPEARS IN THE SEVENTH RECTANGLE. THE NUMBERS ARE COLORED WHITE.

FOR EDUCATIONAL SERVICES, NAMELY, CONDUCTING EDUCATIONAL AND INTERACTIVE CLASSES, PROGRAMS AND WORKSHOPS FEATURING WIDE RANGING, MULTIDISCIPLINARY CURRICULA FOR CHILDREN IN THE FIELD OF SENSORY MOTOR PLAY, GYMNASTICS, SPORTS, PHYSICAL FITNESS AND YOGA, PRE-SCHOOL AND SCHOOL READINESS, DRAMATIC ARTS, MULTI-CULTURAL AND SECOND LANGUAGE PROGRAMS, SOCIAL SKILL DEVELOPMENT, LITERATURE AND STORYTELLING, SCIENCE, MATH, COOKING, SIGN LANGUAGE, ART AND MUSIC; EDUCATIONAL SERVICES, NAMELY, CONDUCTING PARENTAL WORKSHOPS IN THE FIELD OF UNDERSTANDING, IMPROVING AND DEVELOPING PARENTAL CHILD REARING SKILLS AND PARENT-CHILD RELATIONSHIPS; ORGANIZING AND CONDUCTING BIRTHDAY PARTIES FOR CHILDREN; ORGANIZING AND CONDUCTING FAMILY AND CHILDREN'S ENTERTAINMENT EVENTS (U.S. CLS. 100, 101 AND 107).

FIRST USE 9-6-2005; IN COMMERCE 9-6-2005.
HOWARD B. LEVINE, EXAMINING ATTORNEY

SN 78-779,399. FOSTER, PHILLIP, LONG BEACH, CA. FILED 12-22-2005.



NO CLAIM IS MADE TO THE EXCLUSIVE RIGHT TO USE URBAN ARTS & ENTERTAINMENT MAGAZINE, APART FROM THE MARK AS SHOWN.

THE MARK CONSISTS OF A STYLIZED LETTERS "ARRAY".

FOR PUBLICATION OF TEXTS, BOOKS, MAGAZINES AND OTHER PRINTED MATTER (U.S. CLS. 100, 101 AND 107).

LESLEY LAMOTHE, EXAMINING ATTORNEY

CLASS 41—(Continued).

SN 78-782,989. FIRE HORSE PRODUCTIONS, INC., SAN FRANCISCO, CA. FILED 12-30-2005.



Rope
Bondage
Dojo

NO CLAIM IS MADE TO THE EXCLUSIVE RIGHT TO USE "ROPE BONDAGE DOJO" AND THE NON-LATIN CHARACTERS THAT TRANSLITERATE TO "KINBAKU DOJO", APART FROM THE MARK AS SHOWN.

THE NON-LATIN CHARACTERS IN THE MARK TRANSLITERATE TO "KINBAKU DOJO" AND THIS MEANS "TIGHT ROPE DOJO" IN ENGLISH.

FOR INSTRUCTIONAL CLASSES FOR ADULTS INTERESTED IN LEARNING ROPE ART, BONDAGE AND MARTIAL ART SKILLS (U.S. CLS. 100, 101 AND 107).

FIRST USE 6-1-2002; IN COMMERCE 6-1-2002.
MARTHA FROMM, EXAMINING ATTORNEY

SN 78-783,282. KNIGHT, KENNETH, ANDREW, SEVERN, MD. FILED 12-30-2005.

Jesus was a Carpenter

THE MARK CONSISTS OF STANDARD CHARACTERS WITHOUT CLAIM TO ANY PARTICULAR FONT, STYLE, SIZE, OR COLOR.

FOR EDUCATION SERVICES, NAMELY, CONDUCTING SEMINARS, CONFERENCES, WORKSHOPS IN THE FIELD OF IN THE FIELDS OF MATH, SCIENCE AND READING AS THOSE SUBJECTS RELATE TO JOBS, OCCUPATIONS, AND EMPLOYMENT OPPORTUNITIES AND COURSE MATERIALS DISTRIBUTED IN CONNECTION THEREWITH; TRAINING MENTORS IN THE FIELDS OF MATH, SCIENCE AND READING AS THOSE SUBJECTS RELATE TO JOBS, OCCUPATIONS, AND EMPLOYMENT OPPORTUNITIES (U.S. CLS. 100, 101 AND 107).

KRISTINA KLOIBER, EXAMINING ATTORNEY

CLASS 41—(Continued).

SN 78-784,581. DIRT MOTOR SPORTS, INC., NORMAN, OK.
FILED 1-4-2006.

ELITE 11

THE MARK CONSISTS OF STANDARD CHARACTERS WITHOUT CLAIM TO ANY PARTICULAR FONT, STYLE, SIZE, OR COLOR.

NO CLAIM IS MADE TO THE EXCLUSIVE RIGHT TO USE "11", APART FROM THE MARK AS SHOWN.

FOR ENTERTAINMENT IN THE NATURE OF DIRT TRACK AUTO RACING (U.S. CLS. 100, 101 AND 107).

FIRST USE 3-11-2005; IN COMMERCE 3-11-2005.
WENDY JUN, EXAMINING ATTORNEY

SN 78-786,484. MUZE INC., NEW YORK, NY. FILED 1-6-2006.

MuzeBooks Out-of-Print

THE MARK CONSISTS OF STANDARD CHARACTERS WITHOUT CLAIM TO ANY PARTICULAR FONT, STYLE, SIZE, OR COLOR.

NO CLAIM IS MADE TO THE EXCLUSIVE RIGHT TO USE "OUT-OF-PRINT", APART FROM THE MARK AS SHOWN.

FOR PROVIDING AN ONLINE DATABASE OF ENTERTAINMENT-RELATED INFORMATION AVAILABLE FOR LICENSING BY OTHERS (U.S. CLS. 100, 101 AND 107).

FIRST USE 1-31-2002; IN COMMERCE 1-31-2002.
JAMES A. RAUEN, EXAMINING ATTORNEY

SN 78-787,287. MUZE INC., NEW YORK, NY. FILED 1-9-2006.

Muze

THE MARK CONSISTS OF STANDARD CHARACTERS WITHOUT CLAIM TO ANY PARTICULAR FONT, STYLE, SIZE, OR COLOR.

FOR PROVIDING AN ONLINE DATABASE OF ENTERTAINMENT-RELATED INFORMATION, INCLUDING THAT WHICH REGARDS BOOKS, MOVIES, MUSIC AND VIDEO GAMES (U.S. CLS. 100, 101 AND 107).

FIRST USE 2-4-1991; IN COMMERCE 2-4-1991.
JAMES A. RAUEN, EXAMINING ATTORNEY

CLASS 41—(Continued).

SN 78-790,026. PROJECT FIREFLY, LLC, ORLANDO, FL.
FILED 1-12-2006.

PROJECT FIREFLY

THE MARK CONSISTS OF STANDARD CHARACTERS WITHOUT CLAIM TO ANY PARTICULAR FONT, STYLE, SIZE, OR COLOR.

FOR MOTION PICTURE FILM PRODUCTION SERVICES, NAMELY, PROVIDING 2-D AND 3-D ANIMATION SERVICES FOR 2-D AND 3-D COMPUTER GENERATED IMAGES FOR THEATRICAL AND VIDEO RELEASES, TELEVISION SERIES, COMMERCIALS, INTERACTIVE AND INTERNET MEDIA, CHILDREN'S BOOKS, AND EDUCATIONAL FILMS (U.S. CLS. 100, 101 AND 107).

FIRST USE 3-26-2004; IN COMMERCE 3-26-2004.
WANDA KAY PRICE, EXAMINING ATTORNEY

SN 78-792,231. CHICO'S MUSIC PRODUCTIONS, ORLANDO, FL. FILED 1-16-2006.



CHICO'S MUSIC PRODUCTIONS

NO CLAIM IS MADE TO THE EXCLUSIVE RIGHT TO USE MUSIC PRODUCTIONS, APART FROM THE MARK AS SHOWN.

THE COLOR(S) BROWN, BLACK, BLUE AND TAN IS/ARE CLAIMED AS A FEATURE OF THE MARK.

THE COLOR BLUE APPEARS IN THE WORDS CHICO'S MUSIC PRODUCTIONS. THE COLOR BROWN APPEARS IN THE DRUM BARRELS. THE COLOR BLACK APPEARS IN THE LETTERS C AND M. THE COLOR TAN APPEARS IN THE DRUM HEADS.

FOR MUSIC PRODUCTION SERVICES (U.S. CLS. 100, 101 AND 107).

RUSS HERMAN, EXAMINING ATTORNEY

SN 78-792,562. LEAP IN FAITH LLC, BEL AIR, MD. FILED 1-16-2006.

FUNdamentals

ENCOURAGING CHILDHOOD DEVELOPMENT THROUGH
INTERACTIVE PLAY

NO CLAIM IS MADE TO THE EXCLUSIVE RIGHT TO USE "ENCOURAGING CHILDHOOD DEVELOPMENT THROUGH INTERACTIVE PLAY", APART FROM THE MARK AS SHOWN.

THE COLORS RED, BLACK, BLUE, LIGHT BLUE, GRAY, AND TAN ARE CLAIMED AS A FEATURE OF THE MARK.
THE MARK CONSISTS OF FUN IN RED CAPITAL

CLASS 41—(Continued).

LETTERS. IN THE LETTER "U" OF THE WORD "FUN" THERE IS A DEPICTION OF A BOY WITH BLUE PANTS, LIGHT BLUE SHIRT, GRAY SHOES, TAN FACE, TAN HANDS AND BLACK HAIR. THE COLOR BLACK APPEARS IN THE LETTERING "DAMENTALS" OF "FUNDAMENTALS", AND IN THE WORDING "ENCOURAGING CHILDHOOD DEVELOPMENT THROUGH INTERACTIVE PLAY". THE MARK APPEARS ON A TRANSPARENT BACKGROUND, AND NO OTHER COLOR IS CLAIMED AS A PART OF THE MARK.

FOR CHILDREN'S ENTERTAINMENT AND AMUSEMENT CENTERS, NAMELY, INTERACTIVE PLAY AREAS; PROVIDING RECREATIONAL AREAS IN THE NATURE OF CHILDREN'S PLAY AREAS (U.S. CLS. 100, 101 AND 107).

FIRST USE 8-1-2004; IN COMMERCE 8-1-2004.
DAVID MILLER, EXAMINING ATTORNEY

SN 78-793,004. VOID MEDIA, LLC, NEW YORK, NY. FILED 1-17-2006.

Void Magazine

THE MARK CONSISTS OF STANDARD CHARACTERS WITHOUT CLAIM TO ANY PARTICULAR FONT, STYLE, SIZE, OR COLOR.

NO CLAIM IS MADE TO THE EXCLUSIVE RIGHT TO USE "MAGAZINE", APART FROM THE MARK AS SHOWN.

FOR ELECTRONIC PUBLISHING SERVICES, NAMELY, PUBLICATION OF TEXT AND GRAPHIC WORKS OF OTHERS ON ON-LINE FEATURING NEWS/MEDIA, AND LITERATURE; MAGAZINE PUBLISHING; PUBLISHING AND DISTRIBUTION OF BOOKS, REVIEWS AND OTHER PRINTED MATTER AS WELL AS RELATED ELECTRONIC DATA CARRIERS; PUBLISHING OF BOOKS AND REVIEWS; PUBLISHING OF BOOKS, MAGAZINES; PUBLISHING OF ELECTRONIC PUBLICATIONS; PUBLISHING OF REVIEWS; PUBLISHING OF WEB MAGAZINES (U.S. CLS. 100, 101 AND 107).

FIRST USE 7-7-2004; IN COMMERCE 4-16-2005.
JOHN E. MICHOS, EXAMINING ATTORNEY

SN 78-795,254. PERFECT ENEMY, FARMINGTON, MN. FILED 1-19-2006.

PERFECT ENEMY

THE MARK CONSISTS OF STANDARD CHARACTERS WITHOUT CLAIM TO ANY PARTICULAR FONT, STYLE, SIZE, OR COLOR.

FOR ENTERTAINMENT NAMELY, LIVE PERFORMANCES BY A MUSICAL BAND (U.S. CLS. 100, 101 AND 107).

FIRST USE 6-14-2005; IN COMMERCE 6-14-2005.
RUSS HERMAN, EXAMINING ATTORNEY

CLASS 41—(Continued).

SN 78-795,799. PLAYDATE KIDS PUBLISHING, INC., MALIBU, CA. FILED 1-20-2006.

THE PLAYDATE KIDS

THE MARK CONSISTS OF STANDARD CHARACTERS WITHOUT CLAIM TO ANY PARTICULAR FONT, STYLE, SIZE, OR COLOR.

NO CLAIM IS MADE TO THE EXCLUSIVE RIGHT TO USE "KIDS", APART FROM THE MARK AS SHOWN.

FOR FAN CLUBS; FAN CLUB SERVICES (U.S. CLS. 100, 101 AND 107).

RONALD MCMORROW, EXAMINING ATTORNEY

SN 78-798,340. TRANSMEDIA GROUP, LLC, MESA, AZ. FILED 1-24-2006.

WICKEDMAG

THE MARK CONSISTS OF STANDARD CHARACTERS WITHOUT CLAIM TO ANY PARTICULAR FONT, STYLE, SIZE, OR COLOR.

FOR PROVIDING ON-LINE NON-DOWNLOADABLE PUBLICATIONS IN THE NATURE OF MAGAZINES AND COMMENTARY IN THE FIELD OF MOTOR SPORTS (U.S. CLS. 100, 101 AND 107).

FIRST USE 10-31-2001; IN COMMERCE 10-31-2001.
SHAUNIA WALLACE, EXAMINING ATTORNEY

SN 78-799,508. CIRQUE TOURS, INC., POMPANO BEACH, FL. FILED 1-25-2006.

SYMPHONY & CIRQUE POPULAIRE

THE MARK CONSISTS OF STANDARD CHARACTERS WITHOUT CLAIM TO ANY PARTICULAR FONT, STYLE, SIZE, OR COLOR.

NO CLAIM IS MADE TO THE EXCLUSIVE RIGHT TO USE SYMPHONY & CIRQUE, APART FROM THE MARK AS SHOWN.

THE ENGLISH TRANSLATION OF THE WORDING "CIRQUE POPULAIRE" IS "POPULAR CIRCUS."

FOR ENTERTAINMENT SERVICES IN THE NATURE OF THEATRICAL AND CIRCUS PERFORMANCES (U.S. CLS. 100, 101 AND 107).

FIRST USE 6-18-2005; IN COMMERCE 6-18-2005.
TARAH HARDY, EXAMINING ATTORNEY

CLASS 41—(Continued).

SN 78-800,609. WILLEMS, BRENT W., WICHITA, KS. AND RHODES, DAVID S., HESSTON, KS. AND GOOD, MARK A., PARK CITY, KS. FILED 1-26-2006.

HEAVY PORK

THE MARK CONSISTS OF STANDARD CHARACTERS WITHOUT CLAIM TO ANY PARTICULAR FONT, STYLE, SIZE, OR COLOR.

FOR ENTERTAINMENT IN THE NATURE OF TELEVISION COMEDY SERIES (U.S. CLS. 100, 101 AND 107).
FIRST USE 9-12-1998; IN COMMERCE 9-12-1998.
LAURIE KAUFMAN, EXAMINING ATTORNEY

SN 78-805,543. DOVER DOWNS GAMING & ENTERTAINMENT, INC., WILMINGTON, DE. FILED 2-2-2006.

DOVER DOWNS IS COOKING

THE MARK CONSISTS OF STANDARD CHARACTERS WITHOUT CLAIM TO ANY PARTICULAR FONT, STYLE, SIZE, OR COLOR.

OWNER OF U.S. REG. NOS. 2,697,403 AND 2,788,453.
FOR ENTERTAINMENT SERVICES IN THE NATURE OF ON-GOING TELEVISION PROGRAMS IN THE FIELD OF COOKING FEATURING LOCAL AND CELEBRITY CHEFS (U.S. CLS. 100, 101 AND 107).
FIRST USE 11-30-2004; IN COMMERCE 11-30-2004.
BENJAMIN OKEKE, EXAMINING ATTORNEY

CLASS 41—(Continued).

SN 78-808,345. IT LEARNING SOLUTIONS, INC., SAN FERNANDO, CA. FILED 2-6-2006.



Your Answer To Advancing Technology

THE COLOR(S) GREEN, RED, YELLOW, BLUE, AND BLACK IS/ARE CLAIMED AS A FEATURE OF THE MARK.

THE MARK CONSISTS OF THE LETTERS ITLS. THE I IS IN A GREEN COLOR. THE T IS IN A RED COLOR. THE L IS IN A YELLOW COLOR. THE S IS IN A BLUE COLOR. THE EXPRESSION YOUR ANSWER TO ADVANCING TECHNOLOGY IS IN A BLACK COLOR.

FOR COMPUTER EDUCATION TRAINING SERVICES; EDUCATION SERVICES, NAMELY, PROVIDING TUTORIAL SESSIONS IN THE FIELD OF COMPUTERS; EDUCATION SERVICES, NAMELY, PROVIDING CLASSES IN THE FIELD OF COMPUTER TRAINING; EDUCATIONAL SERVICES NAMELY CONDUCTING PROGRAMS IN THE FIELD OF COMPUTER TRAINING; EDUCATIONAL SERVICES, NAMELY, CONDUCTING CLASSES IN THE FIELD OF COMPUTER TRAINING; TRAINING IN THE USE AND OPERATION OF COMPUTERS; VOCATIONAL EDUCATION IN THE FIELD OF COMPUTERS AND DEVELOPMENT AND ACQUISITION OF BUSINESS SKILLS (U.S. CLS. 100, 101 AND 107).

FIRST USE 9-19-2005; IN COMMERCE 9-19-2005.
ANDREA EVANS, EXAMINING ATTORNEY

SN 78-810,599. REAL TIME WORLDS LTD., DUNDEE, UNITED KINGDOM, FILED 2-8-2006.

APB

THE MARK CONSISTS OF STANDARD CHARACTERS WITHOUT CLAIM TO ANY PARTICULAR FONT, STYLE, SIZE, OR COLOR.

FOR ENTERTAINMENT SERVICES, NAMELY, PROVIDING A COMPUTER GAME THAT MAY BE ACCESSED NETWORK-WIDE BY NETWORK USERS, NAMELY, PROVIDING A MULTIPLE-USER AND MULTIPLE-PLAYER ON-LINE VIDEO COMPUTER GAME ON A GLOBAL COMPUTER INFORMATION NETWORK PROVIDED BY MEANS OF COMMUNICATIONS BY COMPUTER TERMINALS OR MOBILE TELEPHONE (U.S. CLS. 100, 101 AND 107).

TINA BROWN, EXAMINING ATTORNEY

CLASS 41—(Continued).

SN 78-810,601. REAL TIME WORLDS LTD., DUNDEE, UNITED KINGDOM, FILED 2-9-2006.

ALL POINTS BULLETIN

THE MARK CONSISTS OF STANDARD CHARACTERS WITHOUT CLAIM TO ANY PARTICULAR FONT, STYLE, SIZE, OR COLOR.

FOR ENTERTAINMENT SERVICES, NAMELY, PROVIDING A COMPUTER GAME THAT MAY BE ACCESSED NETWORK-WIDE BY NETWORK USERS, NAMELY, PROVIDING A MULTIPLE-USER AND MULTIPLE-PLAYER ON-LINE VIDEO COMPUTER GAME ON A GLOBAL COMPUTER INFORMATION NETWORK PROVIDED BY MEANS OF COMMUNICATIONS BY COMPUTER TERMINALS OR MOBILE TELEPHONE (U.S. CLS. 100, 101 AND 107).

TINA BROWN, EXAMINING ATTORNEY

SN 78-814,576. LINCOLN BROADCASTING COMPANY, BRISBANE, CA. FILED 2-14-2006.

話越地平線

THE NON-LATIN CHARACTERS IN THE MARK TRANSLITERATE TO "HWA YU-EH DEE PING SHEN" AND THE MANDARIN CHARACTERS MEAN "TALK ACROSS THE HORIZON".

FOR ENTERTAINMENT SERVICES, NAMELY A TELEVISION PROGRAM IN THE NATURE OF A VARIETY TALK SHOW SERIES (U.S. CLS. 100, 101 AND 107).

FIRST USE 11-6-2000; IN COMMERCE 11-6-2000.

JENNIFER KRISP, EXAMINING ATTORNEY

SN 78-815,582. SCIENCE, NATURALLY! LLC, WASHINGTON, DC. FILED 2-15-2006.



FOR PUBLICATION OF BOOKS ON SCIENCE AND MATH RELATED TOPICS IN PRINT, ON AUDIOCASSETTES AND VIA ELECTRONIC MEDIA (U.S. CLS. 100, 101 AND 107).

FIRST USE 12-16-2005; IN COMMERCE 12-16-2005.

REBECCA POVARCHUK, EXAMINING ATTORNEY

CLASS 41—(Continued).

SN 78-818,566. DUFFY, VERA ELIZABETH, LOS ANGELES, CA. AND KENNY, BARBARA ANN, LOS ANGELES, CA. FILED 2-19-2006.

**Fifi and Bibi Poubelle,
The Poubelle Twins**

THE MARK CONSISTS OF STANDARD CHARACTERS WITHOUT CLAIM TO ANY PARTICULAR FONT, STYLE, SIZE, OR COLOR.

THE NAME FIFI & BIBI POUBELLE, THE POUBELLE TWINS IDENTIFIES LIVING INDIVIDUALS WHOSE CONTENT IS OF RECORD.

THE FOREIGN WORDING IN THE MARK TRANSLATES INTO ENGLISH AS TRASH CAN.

FOR ENTERTAINMENT SERVICES NAMELY LIVE, TELEVISED AND MOVIE APPEARANCES BY A PROFESSIONAL ENTERTAINER (U.S. CLS. 100, 101 AND 107).

TOBY BULLOFF, EXAMINING ATTORNEY

SN 78-820,117. SCARY COW PRODUCTIONS LLC, SAN FRANCISCO, CA. FILED 2-21-2006.

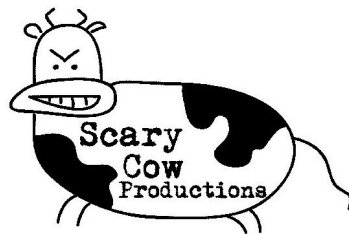

NO CLAIM IS MADE TO THE EXCLUSIVE RIGHT TO USE "PRODUCTIONS", APART FROM THE MARK AS SHOWN.

THE MARK CONSISTS OF AN IMAGE OF A COW, WITH THE WORDS "SCARY COW PRODUCTIONS" APPEARING IN THE BODY.

FOR ENTERTAINMENT NAMELY, PRODUCTION OF MOTION PICTURES (U.S. CLS. 100, 101 AND 107).

FIRST USE 6-12-2005; IN COMMERCE 9-4-2005.

SARA THOMAS, EXAMINING ATTORNEY

CLASS 41—(Continued).

SN 78-820,816. VOGT, KEITH D., TAHOE VISTA, CA. FILED 2-22-2006.



NO CLAIM IS MADE TO THE EXCLUSIVE RIGHT TO USE "THE TAHOE CUP CHALLENGE", APART FROM THE MARK AS SHOWN.

THE MARK CONSISTS OF THE WORD ELEMENT OF THE MARK SUPERIMPOSED OVER A GOLF BALL AND GOLF TEE.

FOR ENTERTAINMENT SERVICES; NAMELY, ORGANIZING AND CONDUCTING AN ANNUAL GOLF TOURNAMENT (U.S. CLS. 100, 101 AND 107).

FIRST USE 1-20-2006; IN COMMERCE 1-20-2006.

DEBRA LEE, EXAMINING ATTORNEY

CLASS 41—(Continued).

SN 78-822,624. LALWANI, STEVEN, S, UPPER MONTCLAIR, NJ. FILED 2-24-2006.

Stay On Top

THE MARK CONSISTS OF STANDARD CHARACTERS WITHOUT CLAIM TO ANY PARTICULAR FONT, STYLE, SIZE, OR COLOR.

FOR PROVIDING ON-LINE NEWS SERVICE IN THE FIELD OF POLITICS, SPORTS, ENTERTAINMENT AND BUSINESS (U.S. CLS. 100, 101 AND 107).

FIRST USE 6-16-2005; IN COMMERCE 6-16-2005.

BENJAMIN OKEKE, EXAMINING ATTORNEY

SN 78-823,059. SIBERIAN CONSULTING, LLC, PORTSMOUTH, NH. FILED 2-24-2006.

THE SECRET OF SECRETS

THE MARK CONSISTS OF STANDARD CHARACTERS WITHOUT CLAIM TO ANY PARTICULAR FONT, STYLE, SIZE, OR COLOR.

FOR ENTERTAINMENT AND EDUCATIONAL SERVICES, NAMELY, ARRANGING AND CONDUCTING CONTESTS, EXHIBITIONS, A LIVE LECTURE SERIES AND SYMPOSIA ALL FEATURING FICTIONAL CONTENT, PROVIDING ON-LINE INTERACTIVE ELECTRONIC COMPUTER GAMES; PROVIDING ON-LINE FICTION BOOKS, CHAPTERS AND EXCERPTS OF BOOKS AND NEWSLETTERS IN THE FIELD OF FICTION (U.S. CLS. 100, 101 AND 107).

MATTHEW PAPPAS, EXAMINING ATTORNEY

SN 78-821,653. TRUE COLORS, INC., SANTA ANA, CA. FILED 2-23-2006.



THE COLOR(S) GREEN, BLUE, ORANGE, RED, AND WHITE IS/ARE CLAIMED AS A FEATURE OF THE MARK.

THE MARK CONSISTS OF A FLOWER WITH A BLUE PETAL, A GREEN PETAL, AN ORANGE PETAL AND RED PETAL. THE CENTER OF THE FLOWER IS WHITE AND EACH PETAL HAS WHITE ACCENTS.

FOR EDUCATIONAL SERVICES, NAMELY, CONDUCTING SEMINARS, TRAININGS AND EDUCATIONAL EVENTS DIRECTED TOWARD PERSONAL AND BEHAVIORAL ANALYSIS AND PERSONALITY TEMPERAMENT (U.S. CLS. 100, 101 AND 107).

FIRST USE 10-1-1988; IN COMMERCE 10-1-1988.

PRISCILLA MILTON, EXAMINING ATTORNEY

SN 78-823,196. IVILLAGE INC., NEW YORK, NY. FILED 2-24-2006.

GARDEN VOICES

THE MARK CONSISTS OF STANDARD CHARACTERS WITHOUT CLAIM TO ANY PARTICULAR FONT, STYLE, SIZE, OR COLOR.

NO CLAIM IS MADE TO THE EXCLUSIVE RIGHT TO USE "GARDEN", APART FROM THE MARK AS SHOWN.

FOR ONLINE JOURNAL AND INFORMATION SERVICES, NAMELY BLOGS IN THE FIELD OF GARDENING (U.S. CLS. 100, 101 AND 107).

FIRST USE 2-6-2006; IN COMMERCE 2-6-2006.

SUNG IN, EXAMINING ATTORNEY

CLASS 41—(Continued).

SN 78-823,383. CENTER FOR SUSTAINABLE LEADERSHIP, KATONAH, NY. FILED 2-25-2006.

Generative Thinking

THE MARK CONSISTS OF STANDARD CHARACTERS WITHOUT CLAIM TO ANY PARTICULAR FONT, STYLE, SIZE, OR COLOR.

FOR EDUCATIONAL SERVICES, NAMELY, CONDUCTING CLASSES, WORKSHOPS AND SEMINARS IN THE FIELD OF WORKPLACE PERFORMANCE (U.S. CLS. 100, 101 AND 107).

FIRST USE 7-7-2005; IN COMMERCE 7-7-2005.
DAWN HAN, EXAMINING ATTORNEY

CLASS 41—(Continued).

SN 78-823,927. RAMBADT, JAMES, SIMI VALLEY, CA. FILED 2-27-2006.



FOR PERSONAL TRAINING SERVICES, NAMELY, STRENGTH AND CONDITIONING TRAINING (U.S. CLS. 100, 101 AND 107).

FIRST USE 10-1-2005; IN COMMERCE 1-1-2006.
JULIE GUTTADAURO, EXAMINING ATTORNEY

SN 78-824,883. THOMPSON, ROBERT DAVID, FLUSHING, NY. FILED 2-28-2006.

**What's Next! What's Next!!
What's Next!!!**

SN 78-823,403. SYRACUSE UNIVERSITY, SYRACUSE, NY. FILED 2-25-2006.



THE MARK CONSISTS OF STANDARD CHARACTERS WITHOUT CLAIM TO ANY PARTICULAR FONT, STYLE, SIZE, OR COLOR.

FOR ENTERTAINMENT SERVICES IN THE NATURE OF A CONTINUING LIVE TELEVISION TALK AND VARIETY SHOW, FEATURING SONGS AND MUSIC, COMEDY AND SATIRICAL SOCIAL COMMENTARY; ENTERTAINMENT SERVICES, NAMELY, PROVIDING WEB SITES FEATURING INFORMATION, VIDEOS AND MUSIC IN THE FIELD OF COMEDY AND SATIRICAL SOCIAL COMMENTARY (U.S. CLS. 100, 101 AND 107).

FIRST USE 8-0-2002; IN COMMERCE 8-0-2002.
ADA HAN, EXAMINING ATTORNEY

SN 78-825,422. A DANCER'S DREAM, INC., MARBLEHEAD, MA. FILED 2-28-2006.

TWIST & SHOUT PARTIES

"THE COLOR(S) ORANGE AND BLUE IS/ARE CLAIMED AS A FEATURE OF THE MARK."

"THE MARK CONSISTS OF AN ORANGE LETTER "S" OUTLINED IN BLUE."

FOR EDUCATION SERVICES IN THE NATURE OF COURSES AT THE UNIVERSITY LEVEL; ENTERTAINMENT IN THE NATURE OF COMPETITIONS IN THE FIELD OF COLLEGE-LEVEL ATHLETICS (U.S. CLS. 100, 101 AND 107).

MICHAEL SOUDERS, EXAMINING ATTORNEY

THE MARK CONSISTS OF STANDARD CHARACTERS WITHOUT CLAIM TO ANY PARTICULAR FONT, STYLE, SIZE, OR COLOR.

NO CLAIM IS MADE TO THE EXCLUSIVE RIGHT TO USE "PARTIES", APART FROM THE MARK AS SHOWN.

FOR ENTERTAINMENT SERVICES - NAMELY, CONDUCTING PARTIES (U.S. CLS. 100, 101 AND 107).

FIRST USE 12-31-1989; IN COMMERCE 12-31-1989.
SANI KHOURI, EXAMINING ATTORNEY

CLASS 41—(Continued).

SN 78-825,658. RIPE DIGITAL ENTERTAINMENT, INC., LOS ANGELES, CA. FILED 2-28-2006.



NO CLAIM IS MADE TO THE EXCLUSIVE RIGHT TO USE "TV", APART FROM THE MARK AS SHOWN.

THE COLOR(S) BROWN AND BLACK IS/ARE CLAIMED AS A FEATURE OF THE MARK.

THE MARK CONSISTS OF A BROWN PAW PRINT WITH THE WORD "ROCKED" IN BLACK LETTERING AND THE WORD "TV" IN BROWN LETTERING.

FOR PROVISION OF NON-DOWNLOADABLE ONGOING AUDIO VISUAL FILM AND TELEVISION PROGRAMS VIA VIDEO ON DEMAND, TELEVISION BROADCAST, CABLE TELEVISION, BROADBAND, INTERNET AND MOBILE DEVICE SERVICES (U.S. CLS. 100, 101 AND 107).

REBECCA GAN, EXAMINING ATTORNEY

SN 78-825,837. REBEL ENTERPRISES LLC, LAS VEGAS, NV. FILED 2-28-2006.



THE MARK CONSISTS OF A RECLINING WOMAN FIGURE WITH THE WORDS "AMERICAN VICE REBEL" APPEARING BELOW THE FIGURE IN A STYLIZED FONT.

FOR CONDUCTING AND PROVIDING FACILITIES FOR SPECIAL EVENTS FEATURING CASINO AND GAMING CONTESTS AND TOURNAMENTS; CONDUCTING ENTERTAINMENT EXHIBITIONS IN THE NATURE OF DISPLAYS, CONVENTIONS, AND CONFERENCES; EDUCATIONAL SERVICES, NAMELY, CONDUCTING ON-LINE EXHIBITIONS AND DISPLAYS AND INTERACTIVE EXHIBITS IN THE FIELD OF ADULT-ORIENTED MATERIALS, HUMAN SEXUALITY, GAMING AND GAMBLING; ELECTRONIC PUBLISHING SERVICES, NAMELY, PUBLICATION OF TEXT AND GRAPHIC WORKS OF OTHERS ON ONLINE FEATURING ADULT-ORIENTED MATERIALS, HUMAN SEXUALITY, GAMING AND GAMBLING; ENTERTAINMENT IN THE NATURE OF PRERECORDED SEX-ORIENTED OR GAMBLING-ORIENTED MESSAGES BY TELEPHONE; ENTERTAINMENT IN THE NATURE OF VISUAL AND AUDIO PERFORMANCES, AND MUSICAL, VARIETY, NEWS AND COMEDY SHOWS; ENTERTAINMENT IN THE NATURE OF CARD OR SLOT TOURNAMENTS; ENTERTAINMENT SERVICES, NAMELY, PERSONAL APPEARANCES BY A MOVIE STAR; ENTERTAINMENT SERVICES, NAMELY, PROVIDING A WEB SITE FEATURING MUSICAL PERFORMANCES, MUSICAL VIDEOS, RELATED FILM CLIPS, PHOTOGRAPHS, AND OTHER MULTIMEDIA MATERIALS; ENTERTAINMENT SERVICES, NAMELY, PROVIDING AN ON-LINE COMPUTER GAME; ENTERTAINMENT SERVICES, NAMELY, PROVIDING ON-

CLASS 41—(Continued).

LINE REVIEWS OF FILMS, WEBSITES AND PUBLICATIONS FEATURING ALCOHOLIC BEVERAGES, ADULT ORIENTED MATERIALS, HUMAN SEXUALITY, GAMING AND GAMBLING; ENTERTAINMENT SERVICES, NAMELY, PROVIDING PRERECORDED MUSIC, INFORMATION IN THE FIELD OF MUSIC, AND COMMENTARY AND ARTICLES ABOUT MUSIC, ALL ONLINE VIA A GLOBAL COMPUTER NETWORK; GAMING SERVICES; ON-LINE LIBRARY SERVICES, NAMELY, PROVIDING ELECTRONIC LIBRARY SERVICES WHICH FEATURE NEWSPAPERS, MAGAZINES, PHOTOGRAPHS AND PICTURES VIA AN ON-LINE COMPUTER NETWORK; ON-LINE PUBLICATION OF ADULT ORIENTED MATERIALS; ONLINE JOURNALS, NAMELY, BLOGS FEATURING COMMENTARY AND REVIEWS OF FILMS, WEBSITES AND PUBLICATIONS ALCOHOLIC BEVERAGES, ADULT ORIENTED MATERIALS, HUMAN SEXUALITY, GAMING AND GAMBLING; PROGRAMMING ON A GLOBAL COMPUTER NETWORK; PROVIDING ON-LINE POKER GAMES (U.S. CLS. 100, 101 AND 107).

KYLE PEETE, EXAMINING ATTORNEY

SN 78-825,839. RIPE DIGITAL ENTERTAINMENT, INC., LOS ANGELES, CA. FILED 2-28-2006.



NO CLAIM IS MADE TO THE EXCLUSIVE RIGHT TO USE "TV", APART FROM THE MARK AS SHOWN.

THE COLOR(S) RED AND BLACK IS/ARE CLAIMED AS A FEATURE OF THE MARK.

THE MARK CONSISTS OF A RED LIPS DESIGN WITH THE WORD "CHUCKLE" IN BLACK LETTERING AND THE WORD "TV" IN RED LETTERING.

FOR PROVISION OF NON-DOWNLOADABLE ONGOING AUDIO VISUAL FILM AND TELEVISION PROGRAMS VIA VIDEO ON DEMAND, TELEVISION BROADCAST, CABLE TELEVISION, BROADBAND, INTERNET AND MOBILE DEVICE SERVICES (U.S. CLS. 100, 101 AND 107).

REBECCA GAN, EXAMINING ATTORNEY

SN 78-827,451. RIPE DIGITAL ENTERTAINMENT, INC., LOS ANGELES, CA. FILED 3-2-2006.

Chuckle TV

THE MARK CONSISTS OF STANDARD CHARACTERS WITHOUT CLAIM TO ANY PARTICULAR FONT, STYLE, SIZE, OR COLOR.

NO CLAIM IS MADE TO THE EXCLUSIVE RIGHT TO USE "TV", APART FROM THE MARK AS SHOWN.

FOR PROVISION OF NON-DOWNLOADABLE ONGOING AUDIO VISUAL FILM AND TELEVISION PROGRAMS VIA VIDEO ON DEMAND, TELEVISION BROADCAST, CABLE TELEVISION, BROADBAND, INTERNET AND MOBILE DEVICE SERVICES (U.S. CLS. 100, 101 AND 107).

REBECCA GAN, EXAMINING ATTORNEY

CLASS 41—(Continued).

SN 78-827,491. RIPE DIGITAL ENTERTAINMENT, INC., LOS ANGELES, CA. FILED 3-2-2006.

Rocked TV

THE MARK CONSISTS OF STANDARD CHARACTERS WITHOUT CLAIM TO ANY PARTICULAR FONT, STYLE, SIZE, OR COLOR.

NO CLAIM IS MADE TO THE EXCLUSIVE RIGHT TO USE "TV", APART FROM THE MARK AS SHOWN.

FOR PROVISION OF NON-DOWNLOADABLE ONGOING AUDIO VISUAL FILM AND TELEVISION PROGRAMS VIA VIDEO ON DEMAND, TELEVISION BROADCAST, CABLE TELEVISION, BROADBAND, INTERNET AND MOBILE DEVICE SERVICES (U.S. CLS. 100, 101 AND 107).

REBECCA GAN, EXAMINING ATTORNEY

SN 78-827,648. RACER PRODUCTIONS, INC., MORGANTOWN, WV. FILED 3-2-2006.

GRAND NATIONAL CROSS COUNTRY

THE MARK CONSISTS OF STANDARD CHARACTERS WITHOUT CLAIM TO ANY PARTICULAR FONT, STYLE, SIZE, OR COLOR.

NO CLAIM IS MADE TO THE EXCLUSIVE RIGHT TO USE "CROSS COUNTRY", APART FROM THE MARK AS SHOWN.

FOR ORGANIZING AND CONDUCTING ATHLETIC COMPETITIONS, SPORTS, EXHIBITIONS, ENTERTAINMENT EVENTS AND CONTESTS INVOLVING MOTOR VEHICLES, MOTORCYCLES AND ATV'S IN THE NATURE OF JUMPS, RACES, EXHIBITIONS AND SKILLS-BASED EVENTS; ENTERTAINMENT SERVICES, NAMELY PROVIDING TELEVISION PROGRAMS, CABLE TELEVISION PROGRAMS, VIDEO AND STILL PHOTO EXHIBITIONS AND WEBCAST TELEVISION AND VIDEO PROGRAMS VIA A GLOBAL COMPUTER NETWORK, ALL IN THE FIELD OF THE FOREGOING SPORTS ENTERTAINMENT EVENTS (U.S. CLS. 100, 101 AND 107).

FIRST USE 3-6-1995; IN COMMERCE 3-6-1995.
HOWARD B. LEVINE, EXAMINING ATTORNEY

CLASS 41—(Continued).

SN 78-829,105. YOUTH LEADERSHIP AMERICA, ANAHEIM, CA. FILED 3-3-2006.

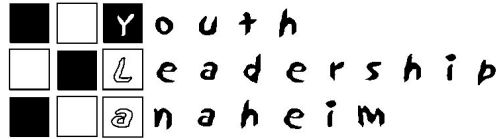

FOR EDUCATIONAL SERVICES, NAMELY, PROVIDING AN EXTENSIVE HANDS-ON LEADERSHIP DEVELOPMENT COURSE TO INFORM, MOTIVATE, AND INCREASE THE AWARENESS OF SELECTED HIGH SCHOOL STUDENTS THROUGH ISSUE-ORIENTED SEMINARS AND INTERACTION WITH COMMUNITY DECISION MAKERS (U.S. CLS. 100, 101 AND 107).

FIRST USE 7-23-2003; IN COMMERCE 9-1-2003.
KIMBERLY FRYE, EXAMINING ATTORNEY

SN 78-829,297. FASTPITCH NOW, INC., MASSAPEQUA, NY. FILED 3-4-2006.

Fastpitch Now, Inc.

NO CLAIM IS MADE TO THE EXCLUSIVE RIGHT TO USE "FASTPITCH" AND "INC.", APART FROM THE MARK AS SHOWN.

THE COLOR(S) PINK AND BLACK ARE CLAIMED AS A FEATURE OF THE MARK.

THE COLOR PINK APPEARS IN THE WORDING 'FASTPITCH NOW, INC.' AND THE COLOR BLACK IS FOUND IN HORIZONTAL LINES POSITIONED ABOVE AND BELOW THE WORDING.

FOR PROVIDING INSTRUCTION AND TRAINING FOR FASTPITCH STYLE SOFTBALL PITCHING, GENERAL GAME INSTRUCTION AND FASTPITCH HITTING INSTRUCTION (U.S. CLS. 100, 101 AND 107).

FIRST USE 12-10-2004; IN COMMERCE 12-10-2004.
KAREN BRACEY, EXAMINING ATTORNEY

SN 78-831,114. NATIONAL ASSOCIATION OF COMMUNITY ACTION AGENCIES (NACAA), WASHINGTON, DC. FILED 3-7-2006.

COMMUNITY LAND SECURITY

THE MARK CONSISTS OF STANDARD CHARACTERS WITHOUT CLAIM TO ANY PARTICULAR FONT, STYLE, SIZE, OR COLOR.

OWNER OF U.S. REG. NOS. 2,353,417 AND 2,723,911.
NO CLAIM IS MADE TO THE EXCLUSIVE RIGHT TO USE COMMUNITY AND SECURITY, APART FROM THE MARK AS SHOWN.

FOR TRAINING SERVICES IN THE FIELD OF SECURITY THREATS TO LOW INCOME COMMUNITIES AND DISSEMINATION OF EDUCATIONAL MATERIALS OF OTHERS IN THE FIELD OF SECURITY THREATS TO LOW INCOME COMMUNITIES (U.S. CLS. 100, 101 AND 107).

FIRST USE 8-31-2002; IN COMMERCE 8-31-2002.
STEVEN JACKSON, EXAMINING ATTORNEY

CLASS 41—(Continued).

SN 78-831,553. BOLDT, LAURENCE G., ASHLAND, OR.
FILED 3-7-2006.

Career Empowerment Program

THE MARK CONSISTS OF STANDARD CHARACTERS WITHOUT CLAIM TO ANY PARTICULAR FONT, STYLE, SIZE, OR COLOR.

NO CLAIM IS MADE TO THE EXCLUSIVE RIGHT TO USE CAREER AND PROGRAM, APART FROM THE MARK AS SHOWN.

FOR EDUCATIONAL SERVICES, NAMELY, DEVELOPING, ARRANGING, AND CONDUCTING EDUCATIONAL CONFERENCES AND PROGRAMS AND PROVIDING COURSES OF INSTRUCTION IN THE FIELD OF CAREERS; PERSONAL COACHING SERVICES IN THE FIELD OF CAREERS; EDUCATIONAL SERVICES, NAMELY, CONDUCTING CLASSES, SEMINARS, CONFERENCES, AND WORKSHOPS IN THE FIELD OF CAREERS AND DISTRIBUTING COURSE MATERIALS IN CONNECTION THEREWITH (U.S. CLS. 100, 101 AND 107).

LOURDES AYALA, EXAMINING ATTORNEY

SN 78-831,599. LINCOLN BROADCASTING COMPANY,
BRISBANE, CA. FILED 3-7-2006.

今夜有話要說

THE MARK CONSISTS OF THE NON-LATIN CHARACTERS IN THE MARK TRANSLITERATE TO "JIN YE YOU HUA YAO SHUO" AND THIS TRANSLATES "TONIGHT GOT SOMETHING TO SAY".

FOR ENTERTAINMENT SERVICES, NAMELY A TELEVISION PROGRAM IN THE NATURE OF A VARIETY TALK SHOW SERIES (U.S. CLS. 100, 101 AND 107).

FIRST USE 2-6-2006; IN COMMERCE 2-6-2006.
JENNIFER KRISP, EXAMINING ATTORNEY

CLASS 41—(Continued).

SN 78-831,603. CHATEAU MONTELENA, CALISTOGA, CA.
FILED 3-7-2006.

UltraMont

THE MARK CONSISTS OF STANDARD CHARACTERS WITHOUT CLAIM TO ANY PARTICULAR FONT, STYLE, SIZE, OR COLOR.

FOR WINE CLUB SERVICES, NAMELY, PERIODICALLY PROVIDING MEMBERS WITH GUIDED WINE TOURS OF WINERIES AND WINE TASTINGS, AND WITH WINE AND WINE PRODUCTS (U.S. CLS. 100, 101 AND 107).

FIRST USE 11-4-2005; IN COMMERCE 11-4-2005.
NAKIA HENRY, EXAMINING ATTORNEY

SN 78-832,643. FEDERAL RESERVE BANK OF ST. LOUIS,
ST. LOUIS, MO. FILED 3-8-2006.

BERG

THE MARK CONSISTS OF STANDARD CHARACTERS WITHOUT CLAIM TO ANY PARTICULAR FONT, STYLE, SIZE, OR COLOR.

FOR ARRANGING AND CONDUCTING EDUCATIONAL CONFERENCES TO PRESENT, DISCUSS, AND COMPARE RESEARCH IN THE FIELDS OF BUSINESS AND ECONOMICS (U.S. CLS. 100, 101 AND 107).

FIRST USE 9-24-2004; IN COMMERCE 9-24-2004.
MARC LEIPZIG, EXAMINING ATTORNEY

SN 78-832,965. ROGER WILLIAMS UNIVERSITY, BRISTOL,
RI. FILED 3-9-2006.

ROGER WILLIAMS UNIVERSITY

THE MARK CONSISTS OF STANDARD CHARACTERS WITHOUT CLAIM TO ANY PARTICULAR FONT, STYLE, SIZE, OR COLOR.

OWNER OF U.S. REG. NOS. 2,866,309, 2,898,927 AND 2,902,854.

NO CLAIM IS MADE TO THE EXCLUSIVE RIGHT TO USE "UNIVERSITY", APART FROM THE MARK AS SHOWN.

THE NAME ROGER WILLIAMS DOES NOT IDENTIFY A LIVING INDIVIDUAL.

FOR EDUCATION SERVICES, NAMELY, PROVIDING COURSES OF INSTRUCTION AND TRAINING AT THE UNIVERSITY LEVEL, INCLUDING THOSE IN THE FIELD OF LAW AND SUBJECTS RELATING TO LAW (U.S. CLS. 100, 101 AND 107).

FIRST USE 5-11-1992; IN COMMERCE 5-11-1992.
ANGELA M. MICHELI, EXAMINING ATTORNEY

CLASS 41—(Continued).

SN 78-833,909. LMH ENTERPRISES LLC, WEST ROXBURY, MA. FILED 3-9-2006.

Gimmie A Break Magazine

THE MARK CONSISTS OF STANDARD CHARACTERS WITHOUT CLAIM TO ANY PARTICULAR FONT, STYLE, SIZE, OR COLOR.

NO CLAIM IS MADE TO THE EXCLUSIVE RIGHT TO USE MAGAZINE, APART FROM THE MARK AS SHOWN.

FOR PROVIDING AN ONLINE PUBLICATION IN THE NATURE OF A MAGAZINE FOR WOMEN, AUTHORED PRIMARILY BY WOMEN, CHILDREN AND MOTHERS AND FEATURING POETRY, PHOTOGRAPHY AND ESSAYS (U.S. CLS. 100, 101 AND 107).

JOHN LINCOSKI, EXAMINING ATTORNEY

SN 78-835,161. ROMEO, AMY, B, CALABASAS, CA. FILED 3-12-2006.

BABY TALK: Foundation Foal Training

THE MARK CONSISTS OF STANDARD CHARACTERS WITHOUT CLAIM TO ANY PARTICULAR FONT, STYLE, SIZE, OR COLOR.

NO CLAIM IS MADE TO THE EXCLUSIVE RIGHT TO USE "FOAL TRAINING", APART FROM THE MARK AS SHOWN.

FOR ARRANGING PROFESSIONAL WORKSHOP AND TRAINING COURSES; CONDUCTING EDUCATIONAL EXHIBITIONS IN THE NATURE OF HORSE TRAINING; DEVELOPING EDUCATIONAL MANUALS FOR OTHERS IN THE FIELD OF HORSE TRAINING; EDUCATIONAL SERVICES, NAMELY, CONDUCTING CLASSES, SEMINARS, WORKSHOPS, TUTORING, AND MENTORING IN THE FIELD OF HORSE TRAINING; HORSE TRAINING (U.S. CLS. 100, 101 AND 107).

FIRST USE 3-21-1998; IN COMMERCE 3-21-1998.
ESTHER A. BORSUK, EXAMINING ATTORNEY

SN 78-836,579. FUSE NETWORKS LLC, BETHPAGE, NY. FILED 3-14-2006.

EMPIRE SQUARE

THE MARK CONSISTS OF STANDARD CHARACTERS WITHOUT CLAIM TO ANY PARTICULAR FONT, STYLE, SIZE, OR COLOR.

FOR ENTERTAINMENT SERVICES, NAMELY, AN ON-GOING TELEVISION PROGRAM IN THE FIELD OF ANIMATED COMEDY. (U.S. CLS. 100, 101 AND 107).

ELLEN B. AWRICH, EXAMINING ATTORNEY

CLASS 41—(Continued).

SN 78-838,087. THE INSPIRATIONAL NETWORK, INC., CHARLOTTE, NC. FILED 3-15-2006.

A Muslim Journey to HOPE

NO CLAIM IS MADE TO THE EXCLUSIVE RIGHT TO USE "MUSLIM", APART FROM THE MARK AS SHOWN.

FOR ENTERTAINMENT SERVICES IN THE NATURE OF A TELEVISION SERIES FEATURING RELIGIOUS INFORMATION AND DISCUSSION, WITH PARTICULAR FOCUS ON THE ISLAMIC AND CHRISTIAN FAITHS (U.S. CLS. 100, 101 AND 107).

FIRST USE 8-4-2005; IN COMMERCE 8-4-2005.

KAPIL BHANOT, EXAMINING ATTORNEY

SN 78-839,681. ARTRANSIT PRODUCTIONS, INC., JACKSONVILLE, FL. FILED 3-17-2006.

ARTRANSIT

THE MARK CONSISTS OF STANDARD CHARACTERS WITHOUT CLAIM TO ANY PARTICULAR FONT, STYLE, SIZE, OR COLOR.

FOR FILM DISTRIBUTION; FILM EDITING; MOTION PICTURE FILM PRODUCTION; OPERATION OF VIDEO EQUIPMENT OR AUDIO EQUIPMENT ETC; FOR PRODUCTION OF RADIO OR TELEVISION PROGRAMS; PHOTOGRAPHIC AND VIDEO SERVICES, NAMELY, PHOTOGRAPHIC AND VIDEO CAPTURE; PHOTOGRAPHY SERVICES; PRODUCTION AND DISTRIBUTION OF MOTION PICTURES; VIDEO EDITING; VIDEO TAPE EDITING; VIDEO TAPE RECORDING FOR OTHERS (U.S. CLS. 100, 101 AND 107).

KELLY CHOE, EXAMINING ATTORNEY

SN 78-840,738. GOODE, MICHAEL, KIRK, SAINT LOUIS, MO. FILED 3-19-2006.

The Everyday Investor

For the ordinary investor who seeks extraordinary profits

NO CLAIM IS MADE TO THE EXCLUSIVE RIGHT TO USE "THE EVERYDAY INVESTOR", APART FROM THE MARK AS SHOWN.

THE COLOR(S) BLACK, AQUAMARINE, WHITE, AND BLUE IS/ARE CLAIMED AS A FEATURE OF THE MARK.

THE MARK CONSISTS OF THE WORDS 'THE EVERYDAY INVESTOR: FOR THE ORDINARY INVESTOR WHO SEEKS EXTRAORDINARY PROFITS' IN BLACK TYPE (EXCEPT FOR THE FIRST AND THIRD WORDS: 'THE' AND 'INVESTOR' ARE IN BLUE TYPE) ON A BACKGROUND THAT IS GRADIATED FROM WHITE AT THE BOTTOM TO AQUAMARINE AT THE TOP.

FOR PROVIDING NEWSLETTERS IN THE FIELD OF INVESTMENT VIA E-MAIL (U.S. CLS. 100, 101 AND 107).

FIRST USE 1-15-2006; IN COMMERCE 1-15-2006.

STEVEN R. FINE, EXAMINING ATTORNEY

CLASS 41—(Continued).

SN 78-841,090. RANDOLPH, GRACE, NEW YORK, NY.
FILED 3-20-2006.

MITA
Monkeys In The Atrium



THE COLOR(S) YELLOW, RED, BLACK, WHITE AND PINK IS/ARE CLAIMED AS A FEATURE OF THE MARK.

THE COLOR YELLOW APPEARS IN THE UPPER LEFT QUADRANT OF THE SHIELD; THE COLOR RED APPEARS IN THE LOWER RIGHT QUADRANT OF THE SHIELD, IN THE MAN'S BOW TIE AND TONGUE; BLACK APPEARS IN ALL WORDING, THE MONKEY, THE MAN'S HAIR AND IN THE OUTLINE AND DETAIL OF THE SHIELD AND THE MAN'S FACE; WHITE APPEARS IN THE UPPER RIGHT AND LOWER LEFT QUADRANTS OF THE SHIELD AND IN THE MAN'S TEETH; AND THE COLOR PINK APPEARS IN THE MAN'S FACE. ON TOP OF THE SHIELD IS "MITA" IN CAPITAL LETTERS UNDERLINED, THEN UNDERNEATH THE LINE IS "MONKEYS IN THE ATRIUM" IN STYLIZED FONT.

FOR ENTERTAINMENT IN THE NATURE OF VISUAL AND AUDIO PERFORMANCES, AND MUSICAL, VARIETY, NEWS AND COMEDY SHOWS; ENTERTAINMENT IN THE NATURE OF LIVE IMPROV AND SKETCH COMEDY SHOWS (U.S. CLS. 100, 101 AND 107).

FIRST USE 7-1-2004; IN COMMERCE 7-1-2004.
ELIZABETH PIGNATELLO, EXAMINING ATTORNEY

SN 78-841,764. PARMER, KELLY A., DBA KELLY A. MCKAY (STAGE NAME), FISHERS, IN. FILED 3-20-2006.

"The Daily Dilemma"

THE MARK CONSISTS OF STANDARD CHARACTERS WITHOUT CLAIM TO ANY PARTICULAR FONT, STYLE, SIZE, OR COLOR.

NO CLAIM IS MADE TO THE EXCLUSIVE RIGHT TO USE "DAILY", APART FROM THE MARK AS SHOWN.

FOR RADIO ENTERTAINMENT SERVICES, NAMELY A RADIO PROGRAM FEATURING A PERFORMANCE BY A RADIO PERSONALITY (U.S. CLS. 100, 101 AND 107).

LESLEY LAMOTHE, EXAMINING ATTORNEY

CLASS 41—(Continued).

SN 78-843,365. THE OKLAHOMA PUBLISHING COMPANY,
OKLAHOMA CITY, OK. FILED 3-22-2006.

OPUBCO

THE MARK CONSISTS OF STANDARD CHARACTERS WITHOUT CLAIM TO ANY PARTICULAR FONT, STYLE, SIZE, OR COLOR.

OWNER OF U.S. REG. NO. 3,000,055.

FOR PUBLISHING AND DISTRIBUTION OF NEWSPAPERS, BOOKS, PERIODICALS, MAGAZINES AND OTHER PRINTED MATERIALS, AS WELL AS RELATED ELECTRONIC DATA CARRIERS (U.S. CLS. 100, 101 AND 107).

FIRST USE 2-12-2006; IN COMMERCE 2-12-2006.
LINDA POWELL, EXAMINING ATTORNEY

SN 78-844,942. HANLEY-WOOD, LLC, WASHINGTON, DC.
FILED 3-23-2006.

**AHF LIVE! THE TAX CREDIT
DEVELOPERS' SUMMIT**

THE MARK CONSISTS OF STANDARD CHARACTERS WITHOUT CLAIM TO ANY PARTICULAR FONT, STYLE, SIZE, OR COLOR.

OWNER OF U.S. REG. NO. 2,413,622.

NO CLAIM IS MADE TO THE EXCLUSIVE RIGHT TO USE "LIVE" AND "THE TAX CREDIT DEVELOPERS' SUMMIT", APART FROM THE MARK AS SHOWN.

FOR EDUCATIONAL SERVICES, NAMELY, CONDUCTING CONFERENCES IN THE FIELD OF HOUSING DEVELOPMENT AND FINANCING AND DISTRIBUTING CONFERENCE MATERIALS IN CONNECTION THEREWITH (U.S. CLS. 100, 101 AND 107).

FIRST USE 11-16-2004; IN COMMERCE 11-16-2004.
SETH A. RAPPAPORT, EXAMINING ATTORNEY

SN 78-845,466. AMERICAN CAREER COLLEGE, COSTA MESA, CA. FILED 3-24-2006.

AMERICAN CAREER COLLEGE

THE MARK CONSISTS OF STANDARD CHARACTERS WITHOUT CLAIM TO ANY PARTICULAR FONT, STYLE, SIZE, OR COLOR.

NO CLAIM IS MADE TO THE EXCLUSIVE RIGHT TO USE "CAREER COLLEGE", APART FROM THE MARK AS SHOWN.

SEC. 2(F).

FOR EDUCATIONAL SERVICES, NAMELY, PROVIDING COURSES OF INSTRUCTION AT THE UNDERGRADUATE AND PROFESSIONAL LEVEL (U.S. CLS. 100, 101 AND 107).

FIRST USE 7-1-1994; IN COMMERCE 11-11-1998.
ELLEN B. AWRICH, EXAMINING ATTORNEY

CLASS 41—(Continued).

SN 78-845,512. AMERICAN CAREER COLLEGE, COSTA MESA, CA. FILED 3-24-2006.



NO CLAIM IS MADE TO THE EXCLUSIVE RIGHT TO USE "CAREER COLLEGE", APART FROM THE MARK AS SHOWN.

THE MARK CONSISTS OF A SMALL CIRCLE WITHIN A LARGER CIRCLE; THE SMALLER CIRCLE BEING DIVIDED INTO FOUR QUADRANTS WITH FOUR IMAGES: A BOOK, A TORCH, A SUN WITH A COMPASS, AND A SUN WITH AN EYE.

SEC. 2(F) "AMERICAN HAS BECOME DISTINCTIVE OF THE GOODS/SERVICES THROUGH THE APPLICANT'S SUBSTANTIALLY EXCLUSIVE AND CONTINUOUS USE IN COMMERCE FOR AT LEAST THE FIVE YEARS IMMEDIATELY BEFORE THE DATE OF THIS STATEMENT."

FOR EDUCATIONAL SERVICES, NAMELY, PROVIDING COURSES OF INSTRUCTION AT THE UNDERGRADUATE AND PROFESSIONAL LEVEL (U.S. CLS. 100, 101 AND 107).

FIRST USE 7-1-1994; IN COMMERCE 11-11-1998.
ELLEN B. AWRICH, EXAMINING ATTORNEY

SN 78-846,680. SAN DIEGO STATE UNIVERSITY RESEARCH FOUNDATION, SAN DIEGO, CA. FILED 3-27-2006.



THE MARK CONSISTS OF THREE EQUILATERAL TRIANGLES FORMING THREE FOURTHS OF A SQUARE BALANCED ON A TIP. THE AREA WHERE THE FOURTH TRIANGLE WOULD COMPLETE THE SQUARE HAS THE NAME 'PROJECT' ABOVE THE NAME 'TRES' BEGIN FLUSH LEFT WITH THE SIDE OF THE LOWER LEFT TRIANGLE. THERE IS A SMALL SEPARATION BETWEEN EACH OF THE TRIANGLES. THE LOWER LEFT TRIANGLE HAS THE WORD 'RESPECT' ACROSS ITS OUTSIDE BORDER. THE UPPER LEFT TRIANGLE HAS THE WORD 'BENEFICENCE' ACROSS ITS OUTSIDE BORDER. THE UPPER RIGHT TRIANGLE HAS THE WORD 'JUSTICE' ACROSS ITS OUTSIDE BORDER.

FOR TRAINING SERVICES IN THE FIELD OF ETHICS CONCERNING HUMAN SUBJECT TESTING (U.S. CLS. 100, 101 AND 107).

FIRST USE 6-30-2004; IN COMMERCE 6-30-2004.
STEPHANIE DAVIS, EXAMINING ATTORNEY

CLASS 41—(Continued).

SN 78-846,911. INTERTECH, INC., EAGAN, MN. FILED 3-27-2006.

THE BUSINESS OF EXPERTISE!

THE MARK CONSISTS OF STANDARD CHARACTERS WITHOUT CLAIM TO ANY PARTICULAR FONT, STYLE, SIZE, OR COLOR.

FOR COMPUTER TRAINING SERVICES (U.S. CLS. 100, 101 AND 107).

FIRST USE 3-13-2006; IN COMMERCE 3-13-2006.
TANYA AMOS, EXAMINING ATTORNEY

SN 78-846,987. MARRERO, HANS J., SCOTTSDALE, AZ. FILED 3-27-2006.



THE NON-LATIN CHARACTERS IN THE MARK TRANSLITERATE TO "CHI" AND THIS MEANS "INNER FORCE" IN ENGLISH.

FOR COMBAT TRAINING SERVICES; CONDUCTING LEADERSHIP WORKSHOPS AND SEMINARS (U.S. CLS. 100, 101 AND 107).

FIRST USE 0-0-1998; IN COMMERCE 0-0-1998.

STANLEY I. OSBORNE, EXAMINING ATTORNEY

SN 78-847,607. SIMON & SCHUSTER, INC., NEW YORK, NY. FILED 3-28-2006.

HOWARD PUBLISHING

THE MARK CONSISTS OF STANDARD CHARACTERS WITHOUT CLAIM TO ANY PARTICULAR FONT, STYLE, SIZE, OR COLOR.

NO CLAIM IS MADE TO THE EXCLUSIVE RIGHT TO USE "PUBLISHING", APART FROM THE MARK AS SHOWN.

FOR PUBLISHING SERVICES, NAMELY, PUBLICATION OF BOOKS, AUDIO BOOKS AND LITERARY WORKS; PROVIDING PUBLISHING INFORMATION PERTAINING TO BOOKS, AUDIOBOOKS, AND LITERARY WORKS BY MEANS OF A GLOBAL COMPUTER NETWORK (U.S. CLS. 100, 101 AND 107).

FIRST USE 12-31-1969; IN COMMERCE 12-31-1969.

KELLY BOULTON, EXAMINING ATTORNEY

CLASS 41—(Continued).

SN 78-847,610. NATIONAL ASSOCIATION OF BOARDS OF PHARMACY, MOUNT PROSPECT, IL. FILED 3-28-2006.

PCOA

THE MARK CONSISTS OF STANDARD CHARACTERS WITHOUT CLAIM TO ANY PARTICULAR FONT, STYLE, SIZE, OR COLOR.

FOR EDUCATIONAL TESTING SERVICES FOR COLLEGES AND SCHOOLS OF PHARMACY TO ASSESS THE OUTCOME OF DIDACTIC TRAINING AND FORMAL COURSE WORK REQUIRED AS PART OF AN ACCREDITED DEGREE PROGRAM FOR LICENSURE AS A PHARMACIST (U.S. CLS. 100, 101 AND 107).

KATHERINE STOIDES, EXAMINING ATTORNEY

SN 78-847,924. UP WEE GROW, INC., SOUTH HUNTINGTON, NY. FILED 3-28-2006.

F.E.A.T.S. - FAMILY-FRIENDLY
EVALUATION AND TEACHING
SYSTEM

THE MARK CONSISTS OF STANDARD CHARACTERS WITHOUT CLAIM TO ANY PARTICULAR FONT, STYLE, SIZE, OR COLOR.

NO CLAIM IS MADE TO THE EXCLUSIVE RIGHT TO USE "EVALUATION AND TEACHING SYSTEM", APART FROM THE MARK AS SHOWN.

FOR PROVIDING AN ONLINE COMPUTER DATABASE AND INTERACTIVE WEBSITE FEATURING EDUCATIONAL INFORMATION, EDUCATIONAL SKILL BUILDING ACTIVITIES AND EDUCATIONAL DEVELOPMENT INFORMATION IN THE FIELD OF CHILD PSYCHOLOGY (U.S. CLS. 100, 101 AND 107).

FIRST USE 8-31-2001; IN COMMERCE 8-31-2001.

HOWARD SMIGA, EXAMINING ATTORNEY

SN 78-847,958. TWO GALLANTS, SAN FRANCISCO, CA. FILED 3-28-2006.

TWO GALLANTS

THE MARK CONSISTS OF STANDARD CHARACTERS WITHOUT CLAIM TO ANY PARTICULAR FONT, STYLE, SIZE, OR COLOR.

FOR ENTERTAINMENT SERVICES, NAMELY, LIVE PERFORMANCES BY A MUSICAL GROUP; AND ENTERTAINMENT SERVICES IN THE NATURE OF WEBSITE PROVIDING INFORMATION ABOUT MUSICAL PERFORMANCES, RECORDINGS, AND THE MUSIC INDUSTRY (U.S. CLS. 100, 101 AND 107).

FIRST USE 6-30-2002; IN COMMERCE 10-31-2002.

KATHERINE STOIDES, EXAMINING ATTORNEY

CLASS 41—(Continued).

SN 78-848,431. BETWEEN THE PIPES GOALIE CLINIC LLC, WILLIAMSBURG, MI. FILED 3-28-2006.



NO CLAIM IS MADE TO THE EXCLUSIVE RIGHT TO USE "GOALIE CLINIC", APART FROM THE MARK AS SHOWN.

FOR EDUCATIONAL SERVICES, NAMELY, CONDUCTING SPORTS CLINICS IN THE FIELD OF HOCKEY GOALTENDING (U.S. CLS. 100, 101 AND 107).

FIRST USE 1-1-2003; IN COMMERCE 1-1-2003.

JIM RINGLE, EXAMINING ATTORNEY

SN 78-849,072. STELLAR CONNECTIONS LLC, DENVER, CO. FILED 3-29-2006.

CONNECTORING

THE MARK CONSISTS OF STANDARD CHARACTERS WITHOUT CLAIM TO ANY PARTICULAR FONT, STYLE, SIZE, OR COLOR.

FOR EDUCATIONAL AND TRAINING SERVICES, NAMELY, CONDUCTING SEMINARS, CLASSES, CONFERENCES AND WORKSHOPS IN THE FIELD OF BUSINESS NETWORKING AND PERSONAL NETWORKING AND DISTRIBUTING COURSE MATERIALS IN CONNECTION THEREWITH; ONLINE PUBLICATIONS, NAMELY, NEWSLETTERS FEATURING INFORMATION IN THE FIELD OF BUSINESS NETWORKING AND PERSONAL NETWORKING (U.S. CLS. 100, 101 AND 107).

KATHERINE STOIDES, EXAMINING ATTORNEY

SN 78-849,485. DOWLING, DAVID JOHN, LOS ANGELES, CA. FILED 3-29-2006.

Las Angelenas

THE MARK CONSISTS OF STANDARD CHARACTERS WITHOUT CLAIM TO ANY PARTICULAR FONT, STYLE, SIZE, OR COLOR.

FOR PHOTOGRAPHY SERVICES (U.S. CLS. 100, 101 AND 107).

KATHRYN COWARD, EXAMINING ATTORNEY

CLASS 41—(Continued).

SN 78-849,596. FARIBORZ DANIEL DOMIRAY, LOUISVILLE, KY. FILED 3-29-2006.

Millennial Academy

THE MARK CONSISTS OF STANDARD CHARACTERS WITHOUT CLAIM TO ANY PARTICULAR FONT, STYLE, SIZE, OR COLOR.

NO CLAIM IS MADE TO THE EXCLUSIVE RIGHT TO USE "ACADEMY", APART FROM THE MARK AS SHOWN.

FOR EDUCATION SERVICES, NAMELY PROVIDING CLASSES, SEMINARS, WORKSHOPS, TUTORING, HOME-SCHOOLING AND MENTORING FROM KINDERGARTEN THROUGH HIGH SCHOOL, IN ALL ACADEMIC FIELDS INCLUDING ENGLISH, MATH, SCIENCE, FOREIGN LANGUAGES, MUSIC, ARTS, HEALTH AND WELLNESS (U.S. CLS. 100, 101 AND 107).
DARRYL SPRUILL, EXAMINING ATTORNEY

CLASS 41—(Continued).

SN 78-850,193. YOU'RE FIRED, LLC, BEDFORD, NH. FILED 3-30-2006.

YOU'RE FIRED

THE MARK CONSISTS OF STANDARD CHARACTERS WITHOUT CLAIM TO ANY PARTICULAR FONT, STYLE, SIZE, OR COLOR.

FOR PROVIDING STUDIO FACILITIES FOR PAINT YOUR OWN POTTERY AND CREATE YOUR OWN MOSAICS; PROVIDING DO-IT-YOURSELF CERAMIC STUDIO FACILITIES WITH PRECAST CERAMIC POTTERY THAT IS PAINTED ON-SITE BY CUSTOMERS AND THEN GLAZED AND/OR KILN-FIRED; AND PROVIDING DO-IT-YOURSELF STUDIO FACILITIES WITH MOSAIC TILES THAT ARE PIECED TOGETHER TO CREATE MOSAICS ON-SITE BY CUSTOMERS (U.S. CLS. 100, 101 AND 107).

FIRST USE 2-3-2003; IN COMMERCE 2-6-2003.

KATHERINE STOIDES, EXAMINING ATTORNEY

SN 78-849,687. SIMPSON, MITCHELL L, TEGA CAY, SC. FILED 3-30-2006.



NO CLAIM IS MADE TO THE EXCLUSIVE RIGHT TO USE "DANCE AND SHOW BAND", APART FROM THE MARK AS SHOWN.

THE GRAY TONE IN THE DRAWING IS FOR SHADING PURPOSES.

FOR ENTERTAINMENT IN THE NATURE OF VISUAL AND AUDIO PERFORMANCES, NAMELY, A MUSICAL BAND PROVIDING LIVE PERFORMANCES (U.S. CLS. 100, 101 AND 107).

FIRST USE 12-1-2003; IN COMMERCE 12-1-2003.

CARYN GLASSER, EXAMINING ATTORNEY

SN 78-850,638. FISHVEGAS.COM, LLC, BOULDER CITY, NV. FILED 3-30-2006.



Your Odds Are Better On The Lake

THE COLOR(S) TURQUOIS, WHITE, GREEN, BLACK, BLUE, YELLOW AND GOLD IS/ARE CLAIMED AS A FEATURE OF THE MARK.

A TURQUOIS FISH WITH A WHITE BELLY BLOWING WHITE BUBBLES, SWIMMING BETWEEN A GREEN CACTUS BUSH AND A GREEN PALM TREE, ABOVE A BLACK LAS VEGAS SKYLINE, WITH A BLUE-SKY BACKGROUND AND A YELLOWISH-GOLD MOON. DIRECTLY UNDER THE FISH ARE YELLOWISH-GOLD WORDS FISHVEGAS.COM OVER BLACK-TYPED WORDS: YOUR ODDS ARE BETTER ON THE LAKE.

FOR FISHING GUIDE SERVICES (U.S. CLS. 100, 101 AND 107).

ARETHA SOMERVILLE, EXAMINING ATTORNEY

CLASS 41—(Continued).

SN 78-851,081. JONES, PHILIP, ATLANTA, GA. FILED 3-31-2006.

THE VIDEO GIRL AWARDS

THE MARK CONSISTS OF STANDARD CHARACTERS WITHOUT CLAIM TO ANY PARTICULAR FONT, STYLE, SIZE, OR COLOR.

NO CLAIM IS MADE TO THE EXCLUSIVE RIGHT TO USE "AWARDS", APART FROM THE MARK AS SHOWN.

FOR ENTERTAINMENT SERVICES, NAMELY, LIVE AND TELEVISED AWARDS CEREMONIES IN THE FIELD OF MUSIC VIDEOS; PROVIDING A WEBSITE FEATURING PRE-RECORDED MUSIC, MUSICAL PERFORMANCES, AUDIO CLIPS, VIDEO CLIPS, PHOTOGRAPHS, NEWS, REVIEWS AND OTHER MULTIMEDIA ARTICLES IN CONNECTION WITH THE FIELD OF MUSIC VIDEOS (U.S. CLS. 100, 101 AND 107).

TRAVIS WHEATLEY, EXAMINING ATTORNEY

SN 78-851,291. WINDSWEPT DUNES, L.L.C., FREEPORT, FL. FILED 3-31-2006.



NO CLAIM IS MADE TO THE EXCLUSIVE RIGHT TO USE "DUNES", APART FROM THE MARK AS SHOWN.

THE COLORS MAROON, PEACH, WHITE, AND BLACK ARE CLAIMED AS A FEATURE OF THE MARK.

THE MARK CONSISTS OF MAROON DUNES WITH PEACH HIGHLIGHTS ATOP THE LITERAL ELEMENT IN MAROON WITH A MAROON FLAGPOLE WITH A MAROON, PEACH, AND WHITE FLAG FLYING, STUCK IN A DUNE. THE COLOR BLACK APPEARS IN THE DUNE GRASSES, THE LETTERING, AND THE DUNES. THE MARK APPEARS ON A TRANSPARENT BACKGROUND, AND NO OTHER COLOR IS CLAIMED AS A FEATURE OF THE MARK.

FOR GOLF COURSES (U.S. CLS. 100, 101 AND 107).
FIRST USE 8-27-2004; IN COMMERCE 8-27-2004.
DAVID MILLER, EXAMINING ATTORNEY

SN 78-851,446. THE BIOSOPHICAL INSTITUTE, INC., BEACHWOOD, OH. FILED 3-31-2006.

P.E.A.C.E. (Peace For Ethical Action Through Creative Education)

THE MARK CONSISTS OF STANDARD CHARACTERS WITHOUT CLAIM TO ANY PARTICULAR FONT, STYLE, SIZE, OR COLOR.

FOR EDUCATIONAL SERVICES, NAMELY, PROVIDING CLASSES, COURSES, SEMINARS, AND WORKSHOPS TO ELEMENTARY SCHOOL CHILDREN IN THE FIELD OF ETHICAL ACTION AND DIVERSITY (U.S. CLS. 100, 101 AND 107).

KAELIE KUNG, EXAMINING ATTORNEY

CLASS 41—(Continued).

SN 78-852,288. BIG APPLE CONSULTING USA, INC., LONGWOOD, FL. FILED 4-3-2006.

FITSPA BIG APPLE

THE MARK CONSISTS OF STANDARD CHARACTERS WITHOUT CLAIM TO ANY PARTICULAR FONT, STYLE, SIZE, OR COLOR.

FOR PROVIDING FITNESS AND EXERCISE FACILITIES FOR OUR EMPLOYEES AS WELL AS FOR THE GENERAL PUBLIC (U.S. CLS. 100, 101 AND 107).

MICHAEL SOUDERS, EXAMINING ATTORNEY

SN 78-852,413. TOWBIN, JOSHUA D., LAS VEGAS, NV. FILED 4-3-2006.

CHOP

THE MARK CONSISTS OF STANDARD CHARACTERS WITHOUT CLAIM TO ANY PARTICULAR FONT, STYLE, SIZE, OR COLOR.

FOR ENTERTAINMENT AND EDUCATIONAL SERVICES, NAMELY LIVE PERFORMANCES BY A MUSICAL ARTIST; PROVIDING MOTIVATIONAL SPEAKING SERVICES (U.S. CLS. 100, 101 AND 107).

CURTIS FRENCH, EXAMINING ATTORNEY

SN 78-852,433. TOWBIN, JOSHUA D., LAS VEGAS, NV. FILED 4-3-2006.

CHOPPER

THE MARK CONSISTS OF STANDARD CHARACTERS WITHOUT CLAIM TO ANY PARTICULAR FONT, STYLE, SIZE, OR COLOR.

FOR ENTERTAINMENT AND EDUCATIONAL SERVICES, NAMELY LIVE PERFORMANCES BY A MUSICAL ARTIST; PROVIDING MOTIVATIONAL SPEAKING SERVICES (U.S. CLS. 100, 101 AND 107).

BRIDGETT SMITH, EXAMINING ATTORNEY

CLASS 41—(Continued).

SN 78-852,469. POETRY ALIVE!, INC., ASHEVILLE, NC. FILED 4-3-2006.

READING, WRITING AND PERFORMING CONNECTION

THE MARK CONSISTS OF STANDARD CHARACTERS WITHOUT CLAIM TO ANY PARTICULAR FONT, STYLE, SIZE, OR COLOR.

NO CLAIM IS MADE TO THE EXCLUSIVE RIGHT TO USE "READING, WRITING AND PERFORMING", APART FROM THE MARK AS SHOWN.

FOR EDUCATIONAL SERVICES NAMELY CONDUCTING PROGRAMS IN THE FIELD OF POETRY WORKSHOPS (U.S. CLS. 100, 101 AND 107).

FIRST USE 11-17-2005; IN COMMERCE 11-17-2005.

JASON ROTH, EXAMINING ATTORNEY

SN 78-852,486. MAKING SENSE OF PLACE, INC., OCONOMOWOC, WI. FILED 4-3-2006.

MAKING SENSE OF PLACE

THE MARK CONSISTS OF STANDARD CHARACTERS WITHOUT CLAIM TO ANY PARTICULAR FONT, STYLE, SIZE, OR COLOR.

FOR ORGANIZING EXHIBITIONS FOR MUSEUMS AND HISTORIC SITES; EDUCATION SERVICES NAMELY, PROVIDING WORKSHOPS IN THE FIELD OF MUSEUMS AND HISTORIC SITES; AND DEVELOPING EDUCATIONAL MANUALS FOR OTHERS IN THE FIELD OF MUSEUMS AND HISTORIC SITES (U.S. CLS. 100, 101 AND 107).

FIRST USE 11-25-2002; IN COMMERCE 11-25-2002.

BARBARA GAYNOR, EXAMINING ATTORNEY

CLASS 41—(Continued).

SN 78-852,646. THE LEAGUE OF AMERICAN THEATRES AND PRODUCERS, INC., NEW YORK, NY. FILED 4-3-2006.



OWNER OF U.S. REG. NOS. 2,846,925, 2,911,583 AND 3,091,739.

NO CLAIM IS MADE TO THE EXCLUSIVE RIGHT TO USE TOURING BROADWAY AWARDS, APART FROM THE MARK AS SHOWN.

FOR ENTERTAINMENT SERVICES, NAMELY, DANCES AND ENTERTAINMENT AND ALSO PROVIDING DINNER IN CONNECTION WITH THE RECOGNITION OF DISTINGUISHED ACHIEVEMENT IN THEATRE; AND THE PRESENTATION OF AWARDS IN RECOGNITION OF DISTINGUISHED ACHIEVEMENT IN THEATRE (U.S. CLS. 100, 101 AND 107).

FIRST USE 12-0-2004; IN COMMERCE 12-0-2004.

KATHERINE STOIDES, EXAMINING ATTORNEY

SN 78-853,280. CHRISTOFIDES, LORI J, DUBLIN, OH. FILED 4-4-2006.

kids in mind

THE MARK CONSISTS OF STANDARD CHARACTERS WITHOUT CLAIM TO ANY PARTICULAR FONT, STYLE, SIZE, OR COLOR.

NO CLAIM IS MADE TO THE EXCLUSIVE RIGHT TO USE KIDS, APART FROM THE MARK AS SHOWN.

FOR PROVIDING RATINGS FOR TELEVISION, MOVIE, MUSIC, VIDEO AND VIDEO GAME CONTENT (U.S. CLS. 100, 101 AND 107).

FIRST USE 9-4-1998; IN COMMERCE 10-1-1998.

RUSS HERMAN, EXAMINING ATTORNEY

CLASS 41—(Continued).

SN 78-853,284. YOUTHFRIENDS, KANSAS CITY, MO.
FILED 4-4-2006.

MENTORS MAKE GREAT PEOPLE
POSSIBLE.

THE MARK CONSISTS OF STANDARD CHARACTERS
WITHOUT CLAIM TO ANY PARTICULAR FONT, STYLE,
SIZE, OR COLOR.

FOR EDUCATIONAL SERVICES, NAMELY, PROVID-
ING TECHNICAL ASSISTANCE TO SCHOOL DISTRICTS
TO FOSTER MENTORING AND TUTORING RELA-
TIONSHIPS BETWEEN ADULTS AND SCHOOL CHIL-
DREN (U.S. CLS. 100, 101 AND 107).

FIRST USE 3-22-2006; IN COMMERCE 3-22-2006.
ALLISON SCHRODY, EXAMINING ATTORNEY

SN 78-853,479. BRADLEY J. NIEDER, DENVER, CO. FILED
4-4-2006.

Healthy Humorist

THE MARK CONSISTS OF STANDARD CHARACTERS
WITHOUT CLAIM TO ANY PARTICULAR FONT, STYLE,
SIZE, OR COLOR.

NO CLAIM IS MADE TO THE EXCLUSIVE RIGHT TO
USE HUMORIST, APART FROM THE MARK AS SHOWN.

FOR ENTERTAINMENT SERVICES, NAMELY, PRE-
SENTATION OF LIVE COMEDY SHOW PERFOR-
MANCES; EDUCATIONAL SERVICES, NAMELY,
CONDUCTING PRESENTATION IN THE FORM OF
SEMINARS, CONFERENCES, AND WORKSHOPS IN
THE FIELD OF COMEDY, WELLNESS ADVICE, AND
THE BENEFITS OF HUMOR AND LAUGHTER (U.S.
CLS. 100, 101 AND 107).

FIRST USE 10-0-2002; IN COMMERCE 12-0-2002.
CAROL SPILS, EXAMINING ATTORNEY

SN 78-853,644. VIACOM INTERNATIONAL INC., NEW
YORK, NY. FILED 4-4-2006.

THE LITTLE TALENT SHOW

THE MARK CONSISTS OF STANDARD CHARACTERS
WITHOUT CLAIM TO ANY PARTICULAR FONT, STYLE,
SIZE, OR COLOR.

FOR ENTERTAINMENT SERVICES IN THE NATURE
OF AN ON-GOING TELEVISION SERIES, FEATURING
LIVE ACTION, COMEDY AND DRAMA; PROVIDING
ONLINE INFORMATION IN THE FIELD OF ENTERTAINMENT
CONCERNING TELEVISION PROGRAMS (U.S. CLS. 100, 101 AND 107).

SUSAN RICHARDS, EXAMINING ATTORNEY

CLASS 41—(Continued).

SN 78-853,700. WEISS, JARA T., ENGLEWOOD CLIFFS, NJ.
FILED 4-4-2006.

The Optimal Health Program

THE MARK CONSISTS OF STANDARD CHARACTERS
WITHOUT CLAIM TO ANY PARTICULAR FONT, STYLE,
SIZE, OR COLOR.

NO CLAIM IS MADE TO THE EXCLUSIVE RIGHT TO
USE "HEALTH PROGRAM", APART FROM THE MARK AS
SHOWN.

FOR EDUCATIONAL SERVICES NAMELY CON-
DUCTING WORKSHOPS, SEMINARS, CLASSES, CON-
FERENCES AND COACHING IN THE FIELD OF MIND
BODY SPIRITUAL WELLNESS AND EMPOWERMENT
PROGRAMS AND DISTRIBUTING COURSE MATERIAL
IN CONNECTION WITH (U.S. CLS. 100, 101 AND 107).

FIRST USE 1-4-2006; IN COMMERCE 1-4-2006.
SARAH WAYDA, EXAMINING ATTORNEY

SN 78-853,719. BRADLEY J. NIEDER, DENVER, CO. FILED
4-4-2006.



THE MARK CONSISTS OF A STETHOSCOPE WITH A
SMILING FACE.

FOR ENTERTAINMENT SERVICES, NAMELY, PRE-
SENTATION OF LIVE COMEDY SHOW PERFOR-
MANCES; EDUCATIONAL SERVICES, NAMELY,
CONDUCTING PRESENTATION IN THE FORM OF
SEMINARS, CONFERENCES, AND WORKSHOPS IN
THE FIELD OF COMEDY, WELLNESS ADVICE, AND
THE BENEFITS OF HUMOR AND LAUGHTER (U.S.
CLS. 100, 101 AND 107).

FIRST USE 10-0-2002; IN COMMERCE 12-0-2002.
CAROL SPILS, EXAMINING ATTORNEY

CLASS 41—(Continued).

SN 78-853,912. FLYNN-WATKINS, COLLEEN, CHANTILLY, VA. AND WATKINS, JEFFREY MILTON, CHANTILLY, VA. FILED 4-4-2006.

Falling Sideways

THE MARK CONSISTS OF STANDARD CHARACTERS WITHOUT CLAIM TO ANY PARTICULAR FONT, STYLE, SIZE, OR COLOR.

FOR ENTERTAINMENT SERVICES, NAMELY, PROVIDING PRERECORDED MUSIC, INFORMATION IN THE FIELD OF MUSIC, AND COMMENTARY AND ARTICLES ABOUT MUSIC, ALL ON-LINE VIA A GLOBAL COMPUTER NETWORK; ENTERTAINMENT, NAMELY LIVE MUSIC CONCERTS; ENTERTAINMENT, NAMELY, LIVE PERFORMANCES BY ROCK GROUPS (U.S. CLS. 100, 101 AND 107).

JOHN SCHUYLER YARD, EXAMINING ATTORNEY

SN 78-853,961. FERRA-GILMORE, CHRISTINA, STEVENSON RANCH, CA. FILED 4-4-2006.

RISING STARS!

THE MARK CONSISTS OF STANDARD CHARACTERS WITHOUT CLAIM TO ANY PARTICULAR FONT, STYLE, SIZE, OR COLOR.

FOR EDUCATIONAL SERVICES IN THE NATURE OF A SCHOOL FOR ACTING, SINGING AND DANCING; PHOTOGRAPHY SERVICES (U.S. CLS. 100, 101 AND 107).

FIRST USE 3-1-2005; IN COMMERCE 3-20-2005.
SKYE YOUNG, EXAMINING ATTORNEY

CLASS 41—(Continued).

SN 78-854,185. DANILOW, JACQUI, NEW YORK, NY. FILED 4-5-2006.

LOST IN THE OPERA

THE MARK CONSISTS OF STANDARD CHARACTERS WITHOUT CLAIM TO ANY PARTICULAR FONT, STYLE, SIZE, OR COLOR.

NO CLAIM IS MADE TO THE EXCLUSIVE RIGHT TO USE "OPERA", APART FROM THE MARK AS SHOWN.

FOR ENTERTAINMENT IN THE NATURE OF A TELEVISION SERIES FEATURING LIVE AND RECORDED EDUCATIONAL SHOWS AND ANIMATED CARTOONS FEATURING VOCAL AND INSTRUMENTAL MUSIC; ENTERTAINMENT SERVICES, NAMELY, PROVIDING AN ON-LINE COMPUTER GAME; ELECTRONIC PUBLICATION SERVICES, NAMELY, PUBLICATION OF ELECTRONIC BOOKS, MAGAZINES AND NEWSLETTERS FEATURING ANIMATED CARTOONS, STORIES AND EDUCATIONAL GAMES, COMPETITIONS AND QUIZZES, AND FAN CLUBS; MOTION PICTURE AND ANIMATED FILM PRODUCTION; LIVE PERFORMANCES AND PERSONAL APPEARANCES BY A COSTUMED CHARACTER; ENTERTAINMENT SERVICES IN THE NATURE OF ORGANIZATION OF COMPETITIONS, NAMELY, ORGANIZATION OF PUZZLES AND QUIZZES; PROVISION OF ONLINE AND WIRELESS INFORMATION RELATING TO ENTERTAINMENT AND EDUCATION; RADIO PROGRAM PRODUCTION; ENTERTAINMENT IN THE NATURE OF LIVE PERFORMANCES BY SINGERS AND MUSICIANS; TELEVISION PROGRAM PRODUCTION; ENTERTAINMENT IN THE NATURE OF A TELEVISION SERIES FEATURING TELEVISION PROGRAMS IN THE FIELD OF MUSIC AND OPERA (U.S. CLS. 100, 101 AND 107).

KELLY MCCOY, EXAMINING ATTORNEY

SN 78-854,218. ODESSA SPORTS, INC., DBA ODESSA JACKALOPES PROFESSIONAL HOCKEY, MIDLAND, TX. FILED 4-5-2006.

JACKALOPES

THE MARK CONSISTS OF STANDARD CHARACTERS WITHOUT CLAIM TO ANY PARTICULAR FONT, STYLE, SIZE, OR COLOR.

OWNER OF U.S. REG. NO. 2,374,582.

FOR ENTERTAINMENT SERVICES, NAMELY HOCKEY GAMES AND EXHIBITIONS, AND LIVE APPEARANCES BY A HOCKEY MASCOT (U.S. CLS. 100, 101 AND 107).

FIRST USE 2-1-1997; IN COMMERCE 2-1-1997.

ELIZABETH J. WINTER, EXAMINING ATTORNEY

CLASS 41—(Continued).

SN 78-854,379. THE HOLDEN ARBORETUM, KIRTLAND, OH. FILED 4-5-2006.

THE HOLDEN ARBORETUM

THE MARK CONSISTS OF STANDARD CHARACTERS WITHOUT CLAIM TO ANY PARTICULAR FONT, STYLE, SIZE, OR COLOR.

NO CLAIM IS MADE TO THE EXCLUSIVE RIGHT TO USE "ARBORETUM", APART FROM THE MARK AS SHOWN.

THE NAME(S), PORTRAIT(S), AND/OR SIGNATURE(S) SHOWN IN THE MARK DOES NOT IDENTIFY A PARTICULAR LIVING INDIVIDUAL.

FOR RECREATIONAL SERVICES IN THE NATURE OF AN ARBORETUM AND MUSEUM; SELF-GUIDED AND GUIDED TOURS TO VIEW THE MUSEUM; EDUCATIONAL SERVICES, NAMELY CONDUCTING WORKSHOPS, WORKSHOPS FOR CHILDREN, LECTURES AND SEMINARS IN THE FIELDS OF HORTICULTURE, CONSERVATION, ARTS AND CULTURE; ENTERTAINMENT IN THE NATURE OF SEASONAL FESTIVALS (U.S. CLS. 100, 101 AND 107).

FIRST USE 10-16-1931; IN COMMERCE 10-16-1931.
CHRISTOPHER OTT, EXAMINING ATTORNEY

SN 78-854,604. LEWIS, SITA (MARGARET), HACKENSACK, NJ. FILED 4-5-2006.

Rhymes 2 Riche\$

THE MARK CONSISTS OF STANDARD CHARACTERS WITHOUT CLAIM TO ANY PARTICULAR FONT, STYLE, SIZE, OR COLOR.

FOR ENTERTAINMENT IN THE NATURE OF ONGOING TELEVISION PROGRAMS IN THE FIELD OF REALITY SHOWS, VARIETY SHOWS AND MUSICAL SHOWS (U.S. CLS. 100, 101 AND 107).

JOHN DWYER, EXAMINING ATTORNEY

SN 78-854,626. VIACOM INTERNATIONAL INC., NEW YORK, NY. FILED 4-5-2006.

U.S. OF ANT

THE MARK CONSISTS OF STANDARD CHARACTERS WITHOUT CLAIM TO ANY PARTICULAR FONT, STYLE, SIZE, OR COLOR.

FOR ENTERTAINMENT SERVICES IN THE NATURE OF TELEVISION SERIES, FEATURING LIVE ACTION, COMEDY AND DRAMA; PROVIDING ONLINE INFORMATION IN THE FIELD OF ENTERTAINMENT CONCERNING TELEVISION PROGRAMS (U.S. CLS. 100, 101 AND 107).

SUSAN RICHARDS, EXAMINING ATTORNEY

CLASS 41—(Continued).

SN 78-854,701. AUDIOFILE PUBLICATIONS, INC., PORTLAND, ME. FILED 4-5-2006.

AUDIOFILE

THE MARK CONSISTS OF STANDARD CHARACTERS WITHOUT CLAIM TO ANY PARTICULAR FONT, STYLE, SIZE, OR COLOR.

OWNER OF U.S. REG. NO. 2,092,669.
FOR PROVIDING REVIEWS OF AUDIOBOOKS VIA THE INTERNET AND EMAIL NEWSLETTERS (U.S. CLS. 100, 101 AND 107).

FIRST USE 12-31-1998; IN COMMERCE 12-31-1998.
DAHLIA GEORGE, EXAMINING ATTORNEY

SN 78-855,124. FITNESS PUBLICATIONS, INC., SANTA MONICA, CA. FILED 4-5-2006.

ARNOLD CLASSIC

THE MARK CONSISTS OF STANDARD CHARACTERS WITHOUT CLAIM TO ANY PARTICULAR FONT, STYLE, SIZE, OR COLOR.

NO CLAIM IS MADE TO THE EXCLUSIVE RIGHT TO USE "CLASSIC", APART FROM THE MARK AS SHOWN.

FOR ENTERTAINMENT SERVICES IN THE NATURE OF FITNESS AND BODYBUILDING COMPETITIONS (U.S. CLS. 100, 101 AND 107).

FIRST USE 0-0-1988; IN COMMERCE 0-0-1988.
DOMINICK J. SALEMI, EXAMINING ATTORNEY

SN 78-855,791. AMERICAN ASSOCIATION FOR ARTIFICIAL INTELLIGENCE, MENLO PARK, CA. FILED 4-6-2006.



THE MARK CONSISTS OF A TRIANGLE THAT IS USED TO REPRESENT THE "A", INSIDE THE TRIANGLE ARE TWO SMALL "I"'S TO REPRESENT THE WORDS INTELLIGENCE AND INTERACTIVE, THE "D" IS REPRESENTED BY A HALF CIRCLE PLACED ON THE SLOPING EDGE OF THE TRIANGLE, AND THE LETTER "E" IS ATTACHED TO THE CIRCULAR SIDE OF THE D.

FOR EDUCATIONAL SERVICES, NAMELY, CONFERENCES IN THE FIELD OF ARTIFICIAL INTELLIGENCE (U.S. CLS. 100, 101 AND 107).

FIRST USE 6-1-2005; IN COMMERCE 6-1-2005.
ANDREA EVANS, EXAMINING ATTORNEY

CLASS 41—(Continued).

SN 78-856,779. SMITH, PHILLIP GARY, EDINA, MN. FILED 4-7-2006.

Phillip Gary Smith

THE MARK CONSISTS OF STANDARD CHARACTERS WITHOUT CLAIM TO ANY PARTICULAR FONT, STYLE, SIZE, OR COLOR.

FOR BOOK AND REVIEW PUBLISHING; EDUCATIONAL AND ENTERTAINMENT SERVICES, NAMELY, PROVIDING MOTIVATIONAL AND EDUCATIONAL SPEAKERS; ENTERTAINMENT SERVICES, NAMELY, PROVIDING A RADIO PROGRAM IN THE FIELD OF MOTIVATION, PERSONAL ACCOMPLISHMENT, BUSINESS ACCOMPLISHMENT, SPORTS ACCOMPLISHMENT VIA A GLOBAL COMPUTER NETWORK; MAGAZINE PUBLISHING; NEWSPAPER PUBLISHING; PUBLISHING AND DISTRIBUTION OF BOOKS, REVIEWS AND OTHER PRINTED MATTER AS WELL AS RELATED ELECTRONIC DATA CARRIERS; PUBLISHING OF BOOKS AND REVIEWS; PUBLISHING OF BOOKS, MAGAZINES; PUBLISHING OF ELECTRONIC PUBLICATIONS; PUBLISHING OF JOURNALS, BOOKS AND HANDBOOKS IN THE FIELD OF MEDICINE; PUBLISHING OF REVIEWS; PUBLISHING OF WEB MAGAZINES; RADIO ENTERTAINMENT PRODUCTION (U.S. CLS. 100, 101 AND 107).

SARA THOMAS, EXAMINING ATTORNEY

SN 78-857,004. NATIONAL AUTOMOTIVE PARTS ASSOCIATION, ATLANTA, GA. FILED 4-7-2006.

TRAINING YOU CAN GET YOUR HANDS ON

THE MARK CONSISTS OF STANDARD CHARACTERS WITHOUT CLAIM TO ANY PARTICULAR FONT, STYLE, SIZE, OR COLOR.

FOR EDUCATIONAL SERVICES, NAMELY CONDUCTING TRAINING PROGRAMS OR WEB-BASED TRAINING PROGRAMS IN THE FIELD OF CHANGING AUTOMOTIVE TECHNOLOGY, AUTOMOBILE DIAGNOSTIC SKILLS AND ESSENTIAL KNOWLEDGE OF AUTOMOBILE SYSTEMS, FOR AFTERMARKET AUTOMOTIVE SERVICE TECHNICIANS (U.S. CLS. 100, 101 AND 107).

FIRST USE 2-0-2005; IN COMMERCE 2-0-2005.

BARBARA A. LOUGHRAN, EXAMINING ATTORNEY

CLASS 41—(Continued).

SN 78-857,046. MONTCRIEFFE, RAUL R., SAN LORENZO, CA. AND SOLORZANO, ERASMO JOSE, SAN PABLO, CA. FILED 4-7-2006.

SON DE CAÑA

THE MARK CONSISTS OF STANDARD CHARACTERS WITHOUT CLAIM TO ANY PARTICULAR FONT, STYLE, SIZE, OR COLOR.

THE FOREIGN WORDING IN THE MARK TRANSLATES INTO ENGLISH AS SOUND OF SWEETNESS.

FOR ENTERTAINMENT SERVICES, NAMELY LIVE PERFORMANCES BY A MUSICAL BAND (U.S. CLS. 100, 101 AND 107).

FIRST USE 0-0-2003; IN COMMERCE 0-0-2003.

REBECCA POVARCHUK, EXAMINING ATTORNEY

SN 78-857,125. SQUID LABS, LLC, EMERYVILLE, CA. FILED 4-7-2006.

INSTRUCTABLES

THE MARK CONSISTS OF STANDARD CHARACTERS WITHOUT CLAIM TO ANY PARTICULAR FONT, STYLE, SIZE, OR COLOR.

FOR PROVIDING AN ONLINE COMPUTERIZED HOW-TO AND DO-IT-YOURSELF PROJECTS DATABASE FEATURING INSTRUCTION IN THE FIELDS OF TECHNOLOGY, COMPUTERS, COMPUTER SOFTWARE, VIDEO GAMES, ELECTRONICS, SCIENCE, MOBILITY AIDS, ROBOTS, MUSIC, CULTURE, PHOTOGRAPHY, ART, TRANSPORTATION, BICYCLES, AUTOMOBILES, TOYS, INNOVATION, WEATHER, CLOTHING AND FASHION, COOKING, FURNITURE AND HOUSEHOLD APPLIANCES, OUTDOOR RECREATION, AND SUBJECTS OF GENERAL INTEREST (U.S. CLS. 100, 101 AND 107).

FIRST USE 8-20-2005; IN COMMERCE 8-20-2005.

AMY MCMENAMIN, EXAMINING ATTORNEY

SN 78-857,271. THE ELLIOT LEADERSHIP INSTITUTE, TARRYTOWN, NY. FILED 4-8-2006.

LEAD: TAKING GREAT PEOPLE TO GREATNESS

THE MARK CONSISTS OF STANDARD CHARACTERS WITHOUT CLAIM TO ANY PARTICULAR FONT, STYLE, SIZE, OR COLOR.

FOR EDUCATION SERVICES, NAMELY, PROVIDING CLASSES, SEMINARS AND WORKSHOPS IN THE FIELD OF BUSINESS MANAGEMENT, AND DISTRIBUTION OF COURSE MATERIALS IN CONNECTION THEREWITH (U.S. CLS. 100, 101 AND 107).

FIRST USE 3-1-2006; IN COMMERCE 3-1-2006.

BARBARA BROWN, EXAMINING ATTORNEY

CLASS 41—(Continued).

SN 78-857,371. ON THE RECORD, INC., SAN DIEGO, CA. FILED 4-9-2006.

ON THE RECORD

THE MARK CONSISTS OF STANDARD CHARACTERS WITHOUT CLAIM TO ANY PARTICULAR FONT, STYLE, SIZE, OR COLOR.

FOR PROVIDING SPORTS AND ENTERTAINMENT-RELATED GAMES AND CONTESTS VIA THE INTERNET WHICH MAY BE ACCESSED VIA THE INTERNET BY SUBSCRIBERS; PROVIDING ON-LINE NEWS AND INFORMATION IN THE FIELDS OF SPORTS AND ENTERTAINMENT GAMES, SPORTS AND ENTERTAINMENT FIGURES, AND SPORTS AND ENTERTAINMENT EVENTS (U.S. CLS. 100, 101 AND 107).

FIRST USE 8-27-2005; IN COMMERCE 8-27-2005.
BRENDAN REGAN, EXAMINING ATTORNEY

SN 78-857,760. BOGART, KARYN, NEW YORK, NY. FILED 4-10-2006.

MoonHeart

THE MARK CONSISTS OF STANDARD CHARACTERS WITHOUT CLAIM TO ANY PARTICULAR FONT, STYLE, SIZE, OR COLOR.

FOR MUSIC PRODUCTION SERVICES; MUSIC PUBLISHING SERVICES (U.S. CLS. 100, 101 AND 107).
WENDY GOODMAN, EXAMINING ATTORNEY

SN 78-857,924. CENTRAL COAST GANG INVESTIGATORS, GILROY, CA. FILED 4-10-2006.



NO CLAIM IS MADE TO THE EXCLUSIVE RIGHT TO USE "THE DESIGN OF THE MAP OF CALIFORNIA", APART FROM THE MARK AS SHOWN.

THE COLORS WHITE, BLACK, RED, ORANGE, LIGHT BLUE, DARK BLUE, GREEN AND YELLOW ARE CLAIMED AS A FEATURE OF THE MARK.

THE MARK CONSISTS OF A GREEN MAP OF CALIFORNIA WITH A YELLOW STAR. ACROSS THE MAP IS THE

CLASS 41—(Continued).

LETTERING CCGI IN BLACK. ABOVE THE LETTERING IS A JESTER AND SKULL DESIGN. THE JESTER'S HAT AND COLLAR ARE IN A REPEATING ORANGE-AND-RED PATTERN WITH BLACK OUTLINING AND WHITE TIPS ON THE END; THE EYES, NOSE AND MOUTH ARE BLACK, AND THE FACE IS WHITE WITH RED AND ORANGE AROUND THE EYES AND MOUTH. BELOW THE WORDING IS A SIMILAR DESIGN, WITH AN ALTERNATING DARK-BLUE AND LIGHT-BLUE COLOR SCHEME FOR THE HAT AND COLLAR, OUTLINED IN BLACK AND WITH WHITE ON THE ENDS. THE EYES, NOSE AND MOUTH ARE BLACK. THE FACE IS WHITE, WITH BLUE AROUND THE EYES AND MOUTH.

FOR CONDUCTING TRAINING FOR LAW ENFORCEMENT PERSONNEL AND CIVILIANS IN THE FIELDS OF GANGS, DRUGS, AND PUBLIC SAFETY (U.S. CLS. 100, 101 AND 107).

KIMBERLY FRYE, EXAMINING ATTORNEY

SN 78-858,174. SYNERGEST, INC., CHICAGO, IL. FILED 4-10-2006.

HAVE FUN WHILE LEARNING ;-)

THE MARK CONSISTS OF STANDARD CHARACTERS WITHOUT CLAIM TO ANY PARTICULAR FONT, STYLE, SIZE, OR COLOR.

FOR CONDUCTING WORKSHOPS AND SEMINARS IN PROJECT MANAGEMENT, QUALITY MANAGEMENT INCLUDING ISO 9000, AND ORGANIZATIONAL DEVELOPMENT (U.S. CLS. 100, 101 AND 107).

FIRST USE 6-1-2000; IN COMMERCE 6-1-2000.
JAMES GRIFFIN, EXAMINING ATTORNEY

SN 78-858,365. WHITE, KIM D, POWAY, CA. FILED 4-10-2006.



NO CLAIM IS MADE TO THE EXCLUSIVE RIGHT TO USE "FINANCE", APART FROM THE MARK AS SHOWN.

THE MARK CONSISTS OF A DESIGN OF TWO BENT LINES ABOVE THE LETTERS AND WORDS "IQ IN FINANCE".

FOR EDUCATION SERVICES, NAMELY, PROVIDING SEMINARS AND WORKSHOPS IN THE FIELDS OF FINANCE EDUCATION, DEBT MANAGEMENT AND CREDIT EDUCATION (U.S. CLS. 100, 101 AND 107).

FIRST USE 12-1-2005; IN COMMERCE 12-1-2005.
CHARLOTTE CORWIN, EXAMINING ATTORNEY

CLASS 41—(Continued).

SN 78-858,495. ROGERS, EDMOND, VALLEY VILLAGE, CA.
FILED 4-11-2006.



FOR ENTERTAINMENT SERVICES IN THE NATURE
OF A LIVE MUSICAL GROUP (U.S. CLS. 100, 101 AND
107).

SUSAN LESLIE DUBOIS, EXAMINING ATTORNEY

SN 78-858,605. VIACOM INTERNATIONAL INC., NEW
YORK, NY. FILED 4-11-2006.

LOGOMOTION

THE MARK CONSISTS OF STANDARD CHARACTERS
WITHOUT CLAIM TO ANY PARTICULAR FONT, STYLE,
SIZE, OR COLOR.

FOR ENTERTAINMENT SERVICES, NAMELY, DIS-
TRIBUTION OF NEWS AND INFORMATION IN THE
FIELD OF RADIO, TELEVISION AND MUSIC PRO-
GRAMMING BY MEANS OF DIGITAL AUDIO AND
VIDEO TRANSMISSION OVER WIRED AND WIRELESS
NETWORK (U.S. CLS. 100, 101 AND 107).

SUSAN RICHARDS, EXAMINING ATTORNEY

SN 78-858,623. NETWORK ENTERPRISES, INC., NEW
YORK, NY. FILED 4-11-2006.

GET MORE ACTION

THE MARK CONSISTS OF STANDARD CHARACTERS
WITHOUT CLAIM TO ANY PARTICULAR FONT, STYLE,
SIZE, OR COLOR.

FOR ENTERTAINMENT SERVICES, NAMELY TELE-
VISION PROGRAMS FEATURING LIVE ACTION, DRAMA,
COMEDY, SCI-FI, ANIMATION, MUSIC, NEWS,
AND GENERAL ENTERTAINMENT; PROVIDING IN-
FORMATION IN THE FIELD OF ENTERTAINMENT
RENDERED VIA COMPUTER BY MEANS OF A GLO-
BAL COMPUTER NETWORK (U.S. CLS. 100, 101 AND
107).

IRENE D. WILLIAMS, EXAMINING ATTORNEY

CLASS 41—(Continued).

SN 78-858,641. VIACOM INTERNATIONAL INC., NEW
YORK, NY. FILED 4-11-2006.

BEST DAY EVER

THE MARK CONSISTS OF STANDARD CHARACTERS
WITHOUT CLAIM TO ANY PARTICULAR FONT, STYLE,
SIZE, OR COLOR.

FOR ENTERTAINMENT SERVICES IN THE NATURE
OF AN ON-GOING TELEVISION SERIES, FEATURING
LIVE ACTION, COMEDY AND DRAMA; PROVIDING
ONLINE INFORMATION IN THE FIELD OF ENTER-
TAINMENT CONCERNING TELEVISION PROGRAMS
(U.S. CLS. 100, 101 AND 107).

SUSAN RICHARDS, EXAMINING ATTORNEY

SN 78-858,661. VIACOM INTERNATIONAL INC., NEW
YORK, NY. FILED 4-11-2006.

AT THE POOCHARELLIS

THE MARK CONSISTS OF STANDARD CHARACTERS
WITHOUT CLAIM TO ANY PARTICULAR FONT, STYLE,
SIZE, OR COLOR.

FOR ENTERTAINMENT SERVICES IN THE NATURE
OF AN ON-GOING TELEVISION SERIES, FEATURING
LIVE ACTION, COMEDY AND DRAMA; PROVIDING
ONLINE INFORMATION IN THE FIELD OF ENTER-
TAINMENT CONCERNING TELEVISION PROGRAMS
(U.S. CLS. 100, 101 AND 107).

MARK PILARO, EXAMINING ATTORNEY

SN 78-858,664. VIACOM INTERNATIONAL INC., NEW
YORK, NY. FILED 4-11-2006.

SENSELESS

THE MARK CONSISTS OF STANDARD CHARACTERS
WITHOUT CLAIM TO ANY PARTICULAR FONT, STYLE,
SIZE, OR COLOR.

OWNER OF U.S. REG. NO. 2,550,562.
FOR ENTERTAINMENT SERVICES IN THE NATURE
OF AN ON-GOING TELEVISION SERIES, FEATURING
LIVE ACTION, COMEDY AND DRAMA; PROVIDING
ONLINE INFORMATION IN THE FIELD OF ENTER-
TAINMENT CONCERNING TELEVISION PROGRAMS
(U.S. CLS. 100, 101 AND 107).

MARK PILARO, EXAMINING ATTORNEY

CLASS 41—(Continued).

SN 78-858,737. THE PARK ACADEMY, MARYLHURST, OR. FILED 4-11-2006.

PARK ACADEMY

THE MARK CONSISTS OF STANDARD CHARACTERS WITHOUT CLAIM TO ANY PARTICULAR FONT, STYLE, SIZE, OR COLOR.

NO CLAIM IS MADE TO THE EXCLUSIVE RIGHT TO USE "ACADEMY", APART FROM THE MARK AS SHOWN.

FOR EDUCATIONAL SERVICES, NAMELY, PROVIDING COURSES OF INSTRUCTION AT THE PRIMARY AND SECONDARY LEVEL (U.S. CLS. 100, 101 AND 107).

FIRST USE 3-19-2005; IN COMMERCE 9-1-2005.
KEVON CHISOLM, EXAMINING ATTORNEY

CLASS 41—(Continued).

SN 78-858,934. VERGENCE ENTERTAINMENT, INC., GLENDALE, CA. FILED 4-11-2006.



THE COLOR(S) BLUE AND SILVER IS/ARE CLAIMED AS A FEATURE OF THE MARK.

THE COLOR BLUE APPEARS WITHIN THE LETTER "V". THE COLOR SILVER APPEARS AS A BORDER TO THE LETTER "V" AND WITHIN TWO INTERSECTING LINES IN THE LETTER "V".

THE MARK CONSISTS OF THE LETTER V IN BLOCK FORMAT WITH BLUE AND SILVER SHADING.

FOR ENTERTAINMENT NAMELY, PRODUCTION OF TELEVISIONS SHOWS, WEBCASTS AND MULTIMEDIA PRESENTATIONS IN THE NATURE OF MULTIMEDIA SLIDE SHOWS, COMMERCIALS, AND MULTIMEDIA BILLBOARDS; MOBILE MEDIA AND ENTERTAINMENT SERVICES IN THE NATURE OF CONTENT PREPARATION; MULTIMEDIA ENTERTAINMENT SOFTWARE PRODUCTION SERVICES (U.S. CLS. 100, 101 AND 107).

DAVID COLLIER, EXAMINING ATTORNEY

SN 78-858,888. NORTH AMERICAN TRANSPLANT COORDINATORS ORGANIZATION, LENEXA, KS. FILED 4-11-2006.

THE FOUR PS OF HD

THE MARK CONSISTS OF STANDARD CHARACTERS WITHOUT CLAIM TO ANY PARTICULAR FONT, STYLE, SIZE, OR COLOR.

FOR EDUCATIONAL SERVICES, NAMELY CONDUCTING WORKSHOPS TO INCREASE HOSPITAL REFERRAL OF POTENTIAL ORGAN AND TISSUE DONORS (U.S. CLS. 100, 101 AND 107).

FIRST USE 3-31-2005; IN COMMERCE 3-31-2005.
DARRYL SPRUILL, EXAMINING ATTORNEY

SN 78-859,359. THE NORRIS GROUP, RIVERSIDE, CA. FILED 4-11-2006.

Real Estate Moodometer

THE MARK CONSISTS OF STANDARD CHARACTERS WITHOUT CLAIM TO ANY PARTICULAR FONT, STYLE, SIZE, OR COLOR.

NO CLAIM IS MADE TO THE EXCLUSIVE RIGHT TO USE REAL ESTATE, APART FROM THE MARK AS SHOWN.

FOR TRAINING SERVICES IN THE FIELD OF REAL ESTATE INVESTMENT (U.S. CLS. 100, 101 AND 107).

FIRST USE 2-26-2006; IN COMMERCE 2-26-2006.
CHRIS WELLS, EXAMINING ATTORNEY

CLASS 41—(Continued).

SN 78-859,366. WORLDWIDE ASHRAM, INC., EMIGRANT, MT. FILED 4-11-2006.

Worldwide Ashram

THE MARK CONSISTS OF STANDARD CHARACTERS WITHOUT CLAIM TO ANY PARTICULAR FONT, STYLE, SIZE, OR COLOR.

FOR ARRANGING OF SEMINARS AND CONFERENCES; PUBLISHING OF ELECTRONIC PUBLICATIONS; AND EDUCATION SERVICES, NAMELY, PROVIDING WORKSHOPS IN THE FIELD OF SPIRITUAL PSYCHOLOGY, SELF-AWARENESS, AND ORGANIZATIONAL HEALTH (U.S. CLS. 100, 101 AND 107).

FIRST USE 1-1-2005; IN COMMERCE 6-2-2005.
CHRIS WELLS, EXAMINING ATTORNEY

SN 78-859,406. BLACKBIRD VENTURES, INC., LA JOLLA, CA. FILED 4-11-2006.

HARNESS YOUR ANGER

THE MARK CONSISTS OF STANDARD CHARACTERS WITHOUT CLAIM TO ANY PARTICULAR FONT, STYLE, SIZE, OR COLOR.

FOR PRODUCTION OF RADIO AND TELEVISION PROGRAMS (U.S. CLS. 100, 101 AND 107).

JACQUELINE A. LAVINE, EXAMINING ATTORNEY

SN 78-859,876. KEYSTONE STUDIOS, LLC, SANTA MONICA, CA. FILED 4-12-2006.

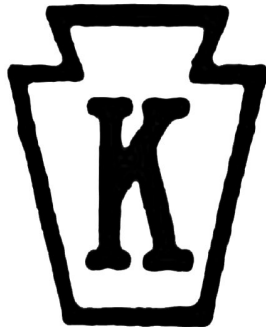

THE MARK CONSISTS OF THE CAPITAL LETTER "K" INSIDE A SHIELD.

FOR PRODUCTION AND DISTRIBUTION OF MOTION PICTURES (U.S. CLS. 100, 101 AND 107).
FIRST USE 2-14-2006; IN COMMERCE 2-14-2006.
DORITT L. CARROLL, EXAMINING ATTORNEY

CLASS 41—(Continued).

SN 78-859,900. YOUNGBLOOD, ED, WESTERVILLE, OH. FILED 4-12-2006.

MOTOHISTORY

THE MARK CONSISTS OF STANDARD CHARACTERS WITHOUT CLAIM TO ANY PARTICULAR FONT, STYLE, SIZE, OR COLOR.

FOR PROVIDING ON-LINE INFORMATION RELATED TO MOTORCYCLE EVENTS, COLLECTIONS, AND HISTORY (U.S. CLS. 100, 101 AND 107).

FIRST USE 12-31-2003; IN COMMERCE 12-31-2003.
LEIGH CAROLINE CASE, EXAMINING ATTORNEY

SN 78-860,048. YOUNGBLOOD, ED, WESTERVILLE, OH. FILED 4-12-2006.



THE MARK CONSISTS OF THE LETTERS "M" AND "H", WINGS AND SPOKES AND HUB OF A WHEEL.

FOR PROVIDING ON-LINE INFORMATION RELATED TO MOTORCYCLE EVENTS, COLLECTIONS, AND HISTORY (U.S. CLS. 100, 101 AND 107).

FIRST USE 12-31-2003; IN COMMERCE 12-31-2003.
LEIGH CAROLINE CASE, EXAMINING ATTORNEY

SN 78-860,314. QUIXOTIC MINISTRIES, INC., CHELSEA, AL. FILED 4-12-2006.

QUIXOTIC MINISTRIES

THE MARK CONSISTS OF STANDARD CHARACTERS WITHOUT CLAIM TO ANY PARTICULAR FONT, STYLE, SIZE, OR COLOR.

NO CLAIM IS MADE TO THE EXCLUSIVE RIGHT TO USE MINISTRIES, APART FROM THE MARK AS SHOWN.

FOR EDUCATIONAL SERVICES, NAMELY, PROVIDING SEMINARS, WORKSHOPS AND CONFERENCES IN THE FIELD OF RELIGION; ENTERTAINMENT SERVICES, NAMELY, PRODUCTION OF TELEVISION AND RADIO PROGRAMS IN THE FIELD OF RELIGION; PROVIDING A TELEVISION AND RADIO PROGRAM IN THE FIELD OF RELIGION VIA THE INTERNET (U.S. CLS. 100, 101 AND 107).

FIRST USE 9-1-2005; IN COMMERCE 9-1-2005.
MARGERY A. TIERNEY, EXAMINING ATTORNEY

CLASS 41—(Continued).

SN 78-860,444. FIRE POWER PRODUCTIONS, LLC, NEW YORK, NY. FILED 4-12-2006.

Urban Mystic Designs

THE MARK CONSISTS OF STANDARD CHARACTERS WITHOUT CLAIM TO ANY PARTICULAR FONT, STYLE, SIZE, OR COLOR.

NO CLAIM IS MADE TO THE EXCLUSIVE RIGHT TO USE "DESIGNS", APART FROM THE MARK AS SHOWN.

FOR MOBILE MEDIA AND ENTERTAINMENT SERVICES IN THE NATURE OF CONTENT PREPARATION (U.S. CLS. 100, 101 AND 107).

JENNY PARK, EXAMINING ATTORNEY

SN 78-860,564. ROBERTS, THOMAS J., LANSDALE, PA. FILED 4-13-2006.

The Independent

THE MARK CONSISTS OF STANDARD CHARACTERS WITHOUT CLAIM TO ANY PARTICULAR FONT, STYLE, SIZE, OR COLOR.

FOR ENTERTAINMENT SERVICES IN THE NATURE OF AN ON-GOING REALITY BASED TELEVISION PROGRAM (U.S. CLS. 100, 101 AND 107).

ADA HAN, EXAMINING ATTORNEY

SN 78-860,692. KENT STATE UNIVERSITY, KENT, OH. FILED 4-13-2006.

COMPLETE TO COMPETE

THE MARK CONSISTS OF STANDARD CHARACTERS WITHOUT CLAIM TO ANY PARTICULAR FONT, STYLE, SIZE, OR COLOR.

FOR EDUCATION SERVICES IN THE NATURE OF COURSES AT THE UNIVERSITY LEVEL (U.S. CLS. 100, 101 AND 107).

NORA BUCHANAN WILL, EXAMINING ATTORNEY

CLASS 41—(Continued).

SN 78-860,785. DOUBLE R LLC, NEW YORK, NY. FILED 4-13-2006.

Flirteve

THE MARK CONSISTS OF STANDARD CHARACTERS WITHOUT CLAIM TO ANY PARTICULAR FONT, STYLE, SIZE, OR COLOR.

FOR SPECIAL EVENT PLANNING (U.S. CLS. 100, 101 AND 107).

FIRST USE 8-1-2005; IN COMMERCE 8-1-2005.

BERNICE HOWSE, EXAMINING ATTORNEY

SN 78-860,930. DRURY UNIVERSITY, SPRINGFIELD, MO. FILED 4-13-2006.



OWNER OF U.S. REG. NO. 2,996,914.

FOR ENTERTAINMENT IN THE NATURE OF INTER-COLLEGIATE SPORTING EVENTS, NAMELY, BASEBALL GAMES, SOFTBALL GAMES, BASKETBALL GAMES, SOCCER MATCHES, GOLF COMPETITIONS, TENNIS MATCHES, SWIMMING COMPETITIONS, DIVING COMPETITIONS, VOLLEYBALL GAMES AND TRACK MEETS; ENTERTAINMENT IN THE NATURE OF EXHIBITIONS IN THE FIELD OF ATHLETICS (U.S. CLS. 100, 101 AND 107).

FIRST USE 1-1-1909; IN COMMERCE 1-1-1909.

JANICE KIM, EXAMINING ATTORNEY

SN 78-860,955. DRURY UNIVERSITY, SPRINGFIELD, MO. FILED 4-13-2006.



THE MARK CONSISTS OF A POUNCING PANTHER.

FOR ENTERTAINMENT IN THE NATURE OF INTER-COLLEGIATE SPORTING EVENTS, NAMELY, BASEBALL GAMES, SOFTBALL GAMES, BASKETBALL GAMES, SOCCER MATCHES, GOLF COMPETITIONS, TENNIS MATCHES, SWIMMING COMPETITIONS, DIVING COMPETITIONS, VOLLEYBALL GAMES AND TRACK MEETS; ENTERTAINMENT IN THE NATURE OF EXHIBITIONS IN THE FIELD OF ATHLETICS (U.S. CLS. 100, 101 AND 107).

FIRST USE 1-1-2000; IN COMMERCE 1-1-2000.

JANICE KIM, EXAMINING ATTORNEY

CLASS 41—(Continued).

SN 78-860,984. THE AMERICAN COLLEGE, BRYN MAWR, PA. FILED 4-13-2006.

LPF

THE MARK CONSISTS OF STANDARD CHARACTERS WITHOUT CLAIM TO ANY PARTICULAR FONT, STYLE, SIZE, OR COLOR.

FOR EDUCATIONAL SERVICES, NAMELY, CONDUCTING CLASSES, SEMINARS, AND CONFERENCES FOR PROFESSIONALS IN THE FIELDS OF FINANCIAL MANAGEMENT, FINANCIAL PLANNING, INVESTMENTS, AND INSURANCE, BY MEANS OF LIVE, ONLINE, AUDIO, AND VIDEO PRESENTATIONS; EDUCATIONAL TESTING SERVICES, NAMELY, OFFERING AND ADMINISTERING EXAMINATIONS ON COMPUTER TERMINALS FOR PROFESSIONALS IN THE FIELDS OF FINANCIAL MANAGEMENT, FINANCIAL PLANNING, INVESTMENTS, AND INSURANCE (U.S. CLS. 100, 101 AND 107).

DEBRA LEE, EXAMINING ATTORNEY

SN 78-860,990. DRURY UNIVERSITY, SPRINGFIELD, MO. FILED 4-13-2006.

DRURY UNIVERSITY

THE MARK CONSISTS OF STANDARD CHARACTERS WITHOUT CLAIM TO ANY PARTICULAR FONT, STYLE, SIZE, OR COLOR.

OWNER OF U.S. REG. NO. 2,996,914.

NO CLAIM IS MADE TO THE EXCLUSIVE RIGHT TO USE UNIVERSITY, APART FROM THE MARK AS SHOWN.

FOR EDUCATION SERVICES IN THE NATURE OF COURSES AT THE UNIVERSITY LEVEL; ENTERTAINMENT IN THE NATURE OF INTERCOLLEGIATE SPORTING EVENTS, NAMELY, BASEBALL GAMES, SOFTBALL GAMES, BASKETBALL GAMES, SOCCER MATCHES, GOLF COMPETITIONS, TENNIS MATCHES, SWIMMING COMPETITIONS, DIVING COMPETITIONS, VOLLEYBALL GAMES AND TRACK MEETS; ENTERTAINMENT IN THE NATURE OF EXHIBITIONS IN THE FIELD OF ATHLETICS; PROVIDING AND SPONSORING EDUCATIONAL CONFERENCES, REUNIONS, AND EVENTS FOR ALUMNI AND THE COMMUNITY (U.S. CLS. 100, 101 AND 107).

FIRST USE 1-1-2000; IN COMMERCE 1-1-2000.

JANICE KIM, EXAMINING ATTORNEY

CLASS 41—(Continued).

SN 78-861,022. DEPATHY, JANET, PLYMOUTH, MA. FILED 4-13-2006.



NO CLAIM IS MADE TO THE EXCLUSIVE RIGHT TO USE "PET SITTERS CONFERENCE", APART FROM THE MARK AS SHOWN.

THE MARK CONSISTS OF STYLIZED WORDS AND GRAPHICS FEATURING PEOPLE AND ANIMALS WITH THE LETTERS CSU IN A BOX.

FOR EDUCATIONAL SERVICES, NAMELY, CONDUCTING CONFERENCES IN THE FIELD OF PET SITTING (U.S. CLS. 100, 101 AND 107).

FIRST USE 1-1-1997; IN COMMERCE 1-1-1997.

MICHAEL KAZAZIAN, EXAMINING ATTORNEY

SN 78-861,160. PALADIN AUTOMOTIVE, LLC, WESTMORELAND, NH. FILED 4-13-2006.



NO CLAIM IS MADE TO THE EXCLUSIVE RIGHT TO USE "RALLY", APART FROM THE MARK AS SHOWN.

THE MARK CONSISTS OF A TIRE ENGULFED IN FLAMES, THE WORDS ARE ABOVE THE TIRE AND OVERLAY THE FLAMES.

FOR SPORTS AND ENTERTAINMENT SERVICES IN THE NATURE OF RALLY RACING BY A PROFESSIONAL RACING TEAM (U.S. CLS. 100, 101 AND 107).

FIRST USE 1-30-2004; IN COMMERCE 1-30-2004.

ANGELA M. MICHELI, EXAMINING ATTORNEY

CLASS 41—(Continued).

SN 78-861,256. PAM MURTAUGH AND COMPANY INC.,
MADISON, WI. FILED 4-13-2006.

PANGAEA QUEST

THE MARK CONSISTS OF STANDARD CHARACTERS WITHOUT CLAIM TO ANY PARTICULAR FONT, STYLE, SIZE, OR COLOR.

THE ENGLISH TRANSLATION OF THE TERM "PANGAEA" IS "ALL EARTH" AND REFERS TO A THEORIZED UNITARY LAND MASS ON EARTH.

FOR ARRANGING AND CONDUCTING EDUCATIONAL CONFERENCES; ARRANGING OF EXHIBITIONS, SEMINARS AND CONFERENCES; EDUCATION SERVICES, NAMELY, PROVIDING CLASSES, SEMINARS, WORKSHOPS, TUTORING AND MENTORING IN THE FIELD OF EXPANDING INTERNATIONAL EXCHANGE ABOUT DIVERSE CULTURES THROUGH MUSIC, FILM, LITERATURE, FOOD AND POLITICAL COMMUNITY ACTION; EDUCATIONAL AND ENTERTAINMENT SERVICES, NAMELY, PROVIDING MOTIVATIONAL AND EDUCATIONAL SPEAKERS; EDUCATIONAL SERVICES, NAMELY, CONDUCTING ON-LINE EXHIBITIONS AND DISPLAYS AND INTERACTIVE EXHIBITS IN THE FIELD OF EXPANDING INTERNATIONAL EXCHANGE ABOUT DIVERSE CULTURES THROUGH MUSIC, FILM, LITERATURE, FOOD AND POLITICAL AND COMMUNITY ACTION; SPONSORING, DEVELOPING, AND CARRYING OUT INTERNATIONAL STUDENT EXCHANGE PROGRAMS (U.S. CLS. 100, 101 AND 107).

MATTHEW MCDOWELL, EXAMINING ATTORNEY

SN 78-861,282. PAM MURTAUGH AND COMPANY INC.,
MADISON, WI. FILED 4-13-2006.

GETTING TO HOPE

THE MARK CONSISTS OF STANDARD CHARACTERS WITHOUT CLAIM TO ANY PARTICULAR FONT, STYLE, SIZE, OR COLOR.

FOR ARRANGING AND CONDUCTING EDUCATIONAL CONFERENCES; ARRANGING OF EXHIBITIONS, SEMINARS AND CONFERENCES; EDUCATION SERVICES, NAMELY, PROVIDING CLASSES, SEMINARS, WORKSHOPS, TUTORING AND MENTORING IN THE FIELD OF EXPANDING INTERNATIONAL EXCHANGE ABOUT DIVERSE CULTURES THROUGH MUSIC, FILM, LITERATURE, FOOD AND POLITICAL COMMUNITY ACTION; EDUCATIONAL AND ENTERTAINMENT SERVICES, NAMELY, PROVIDING MOTIVATIONAL AND EDUCATIONAL SPEAKERS; EDUCATIONAL SERVICES, NAMELY, CONDUCTING ON-LINE EXHIBITIONS AND DISPLAYS AND INTERACTIVE EXHIBITS IN THE FIELD OF EXPANDING INTERNATIONAL EXCHANGE ABOUT DIVERSE CULTURES THROUGH MUSIC, FILM, LITERATURE, FOOD AND POLITICAL AND COMMUNITY ACTION; SPONSORING, DEVELOPING, AND CARRYING OUT INTERNATIONAL STUDENT EXCHANGE PROGRAMS (U.S. CLS. 100, 101 AND 107).

MATTHEW MCDOWELL, EXAMINING ATTORNEY

CLASS 41—(Continued).

SN 78-861,428. GOLDEN TEMPLE OF OREGON, INC.,
EUGENE, OR. FILED 4-13-2006.

CELEBRATE PEACE

THE MARK CONSISTS OF STANDARD CHARACTERS WITHOUT CLAIM TO ANY PARTICULAR FONT, STYLE, SIZE, OR COLOR.

FOR ORGANIZING AND CONDUCTING EXHIBITIONS FEATURING A VARIETY OF ACTIVITIES, NAMELY, LIVE MUSIC CONCERTS, YOGA INSTRUCTION AND SELF AWARENESS, MEDITATION AND INTERFAITH WORKSHOPS (U.S. CLS. 100, 101 AND 107).

FIRST USE 1-28-2005; IN COMMERCE 1-28-2005.
LEIGH LOWRY, EXAMINING ATTORNEY

SN 78-861,448. HUDSONS DESIGNER PORTRAIT IMAGES,
INC., RENTON, WA. FILED 4-13-2006.

RELATIONOGRAPHER

THE MARK CONSISTS OF STANDARD CHARACTERS WITHOUT CLAIM TO ANY PARTICULAR FONT, STYLE, SIZE, OR COLOR.

FOR PHOTOGRAPHY SERVICES; AND EDUCATION COURSES AND TRAINING RELATING TO PHOTOGRAPHY (U.S. CLS. 100, 101 AND 107).

ELIZABETH J. WINTER, EXAMINING ATTORNEY

SN 78-861,524. AMERICAN MULTI-CINEMA, INC., KANSAS
CITY, MO. FILED 4-14-2006.

AMC WEEKDAY ESCAPE

THE MARK CONSISTS OF STANDARD CHARACTERS WITHOUT CLAIM TO ANY PARTICULAR FONT, STYLE, SIZE, OR COLOR.

OWNER OF U.S. REG. NOS. 143,501, 2,805,097 AND OTHERS.

NO CLAIM IS MADE TO THE EXCLUSIVE RIGHT TO USE "WEEKDAY", APART FROM THE MARK AS SHOWN. FOR MOVIE THEATRE SERVICES (U.S. CLS. 100, 101 AND 107).

CIMMERIAN COLEMAN, EXAMINING ATTORNEY

CLASS 41—(Continued).

SN 78-861,691. GOLDEN TEMPLE OF OREGON, INC., EUGENE, OR. FILED 4-14-2006.



THE COLOR(S) RED, GREEN, YELLOW, BLUE, WHITE, PURPLE, ORANGE IS/ARE CLAIMED AS A FEATURE OF THE MARK.

THE MARK CONSISTS OF THE WORD "PEACE" IN LOWER CASE, RED LETTERS, IN THE CENTER OF A SMALL GREEN AND YELLOW SPHERE SURROUNDED BY GREEN PETALS; THE SMALL SPHERE IS CENTERED WITHIN A REPRESENTATION OF THE EARTH, CONTAINING THE COLORS BLUE AND WHITE; THE OUTLINE OF THE EARTH IS SURROUNDED BY PETALS IN VARIOUS SHADES OF BLUE, WHICH IS CENTERED WITHIN ANOTHER LARGER SPHERE COMPRISED OF A DARKER COLOR BLUE AND THE WORDS "IN YOUR HEART" AT THE TOP, "IN YOUR HOME" AT THE LOWER RIGHT, AND "IN THE WORLD" AT THE LOWER LEFT, ALL IN LOWER CASE, ORANGE LETTERS; THE LARGE, DARK BLUE SPHERE IS FURTHER SURROUNDED BY DARK BLUE, RED AND PURPLE PETALS, AND THE ENTIRE DESIGN IS SURROUNDED BY A GLOWING ORANGE BORDER.

FOR ORGANIZING AND CONDUCTING EXHIBITIONS FEATURING A VARIETY OF ACTIVITIES, NAMELY, LIVE MUSIC CONCERTS, YOGA INSTRUCTION AND SELF AWARENESS, MEDITATION AND INTERFAITH WORKSHOPS (U.S. CLS. 100, 101 AND 107).

FIRST USE 9-16-2005; IN COMMERCE 9-16-2005.
LEIGH LOWRY, EXAMINING ATTORNEY

SN 78-861,768. DEEP SOUTH, LLC, NASHVILLE, TN. FILED 4-14-2006.

Deep South

THE MARK CONSISTS OF STANDARD CHARACTERS WITHOUT CLAIM TO ANY PARTICULAR FONT, STYLE, SIZE, OR COLOR.

FOR ENTERTAINMENT, NAMELY, LIVE PERFORMANCES BY A MUSICAL BAND (U.S. CLS. 100, 101 AND 107).

FIRST USE 8-2-2005; IN COMMERCE 8-2-2005.
KATHY DE JONGE, EXAMINING ATTORNEY

CLASS 41—(Continued).

SN 78-861,794. INNERDOORWAY LLC, BOULDER, CO. FILED 4-14-2006.

INNOVISION HEALTH MEDIA

THE MARK CONSISTS OF STANDARD CHARACTERS WITHOUT CLAIM TO ANY PARTICULAR FONT, STYLE, SIZE, OR COLOR.

FOR PROVIDING CONTINUING MEDICAL EDUCATION COURSES (U.S. CLS. 100, 101 AND 107).

FIRST USE 3-24-2006; IN COMMERCE 3-24-2006.
KELLEY WELLS, EXAMINING ATTORNEY

SN 78-861,860. WINACASINO, HOLLYWOOD, CA. FILED 4-14-2006.

WINACASINO

THE MARK CONSISTS OF STANDARD CHARACTERS WITHOUT CLAIM TO ANY PARTICULAR FONT, STYLE, SIZE, OR COLOR.

FOR CASINOS; SWEEPSTAKE SERVICES; TELEVISION SHOW PRODUCTION (U.S. CLS. 100, 101 AND 107).

SANDRA MANIOS, EXAMINING ATTORNEY

SN 78-861,880. MARKET BLEEDER, LLC, MIAMI SPRINGS, FL. FILED 4-14-2006.

MARKET BLEEDER

THE MARK CONSISTS OF STANDARD CHARACTERS WITHOUT CLAIM TO ANY PARTICULAR FONT, STYLE, SIZE, OR COLOR.

FOR SECURITIES DAY TRADING INSTRUCTION (U.S. CLS. 100, 101 AND 107).

COLLEEN DOMBROW, EXAMINING ATTORNEY

CLASS 41—(Continued).

SN 78-862,015. STOKES, TERRY, LAS VEGAS, NV. FILED 4-14-2006.

HYPNOLARIOUS

THE MARK CONSISTS OF STANDARD CHARACTERS WITHOUT CLAIM TO ANY PARTICULAR FONT, STYLE, SIZE, OR COLOR.

FOR ENTERTAINMENT IN THE NATURE OF LIVE PERFORMANCES BY HYPNOSIS (U.S. CLS. 100, 101 AND 107).

FIRST USE 10-1-1995; IN COMMERCE 10-1-1995.
JOANNA DUKOVIC, EXAMINING ATTORNEY

SN 78-862,114. WISHNER, BARRY, WOODSIDE, CA. FILED 4-14-2006.

Barry Wishner, The Maverick

THE MARK CONSISTS OF STANDARD CHARACTERS WITHOUT CLAIM TO ANY PARTICULAR FONT, STYLE, SIZE, OR COLOR.

FOR CONDUCTING WORKSHOPS AND SEMINARS IN THE FIELD OF BUSINESS DEVELOPMENT, ON TOPICS INCLUDING LEADERSHIP, PRODUCTIVITY, PERFORMANCE, BUSINESS EXECUTION, OUTWITTING AND OUTLASTING THE COMPETITION, MOTIVATION, AND SPEAKING AND PRESENTATION SKILLS FOR KEYNOTE SPEECHES, GENERAL SESSIONS AND CLOSING ENDNOTE SPEECHES (U.S. CLS. 100, 101 AND 107).

FIRST USE 12-1-2005; IN COMMERCE 2-1-2006.
DOMINIC FATHY, EXAMINING ATTORNEY

SN 78-862,231. KRAMARZ, ROBERT S., LAGUNA HILLS, CA. FILED 4-14-2006.

Intelliversity

THE MARK CONSISTS OF STANDARD CHARACTERS WITHOUT CLAIM TO ANY PARTICULAR FONT, STYLE, SIZE, OR COLOR.

FOR EDUCATION SERVICES IN THE NATURE OF COURSES AT THE UNIVERSITY LEVEL; EDUCATIONAL RESEARCH (U.S. CLS. 100, 101 AND 107).

TANYA AMOS, EXAMINING ATTORNEY

CLASS 41—(Continued).

SN 78-862,404. SHIVECHARAN, SHAILENDRA, CLERMONT, FL. AND CASEY, CHRISTINE, CLERMONT, FL. FILED 4-16-2006.

AfterThought

THE MARK CONSISTS OF STANDARD CHARACTERS WITHOUT CLAIM TO ANY PARTICULAR FONT, STYLE, SIZE, OR COLOR.

FOR ENTERTAINMENT IN THE NATURE OF A LIVE MUSICAL PERFORMER AND MUSICAL BAND; ENTERTAINMENT IN THE NATURE OF LIVE PERFORMANCES BY A MUSICAL ARTIST AND MUSICAL BAND; ENTERTAINMENT IN THE NATURE OF VISUAL AND AUDIO PERFORMANCES BY A MUSICAL ARTIST AND MUSICAL BAND; ENTERTAINMENT, NAMELY, LIVE MUSIC CONCERTS; ENTERTAINMENT, NAMELY, PERSONAL APPEARANCES BY A MUSICIAN AND MUSICAL BAND; ENTERTAINMENT SERVICES, NAMELY, PROVIDING A WEB SITE FEATURING MUSICAL PERFORMANCES, MUSICAL VIDEOS, RELATED FILM CLIPS, PHOTOGRAPHS, AND OTHER MULTIMEDIA MATERIALS; ENTERTAINMENT SERVICES, NAMELY, PROVIDING PRERECORDED MUSIC, INFORMATION IN THE FIELD OF MUSIC, COMMENTARY AND ARTICLES ABOUT MUSIC, ALL ONLINE VIA A GLOBAL COMPUTER NETWORK (U.S. CLS. 100, 101 AND 107).

JOHN DWYER, EXAMINING ATTORNEY

SN 78-862,421. SUCCESS DESIGN INTERNATIONAL LLC, LOS ANGELES, CA. FILED 4-16-2006.

Feng Shui for the Brain

THE MARK CONSISTS OF STANDARD CHARACTERS WITHOUT CLAIM TO ANY PARTICULAR FONT, STYLE, SIZE, OR COLOR.

FOR SELF IMPROVEMENT TRAINING COURSES (U.S. CLS. 100, 101 AND 107).

FIRST USE 9-1-2003; IN COMMERCE 9-1-2003.
JOHN LINCOSKI, EXAMINING ATTORNEY

CLASS 41—(Continued).

SN 78-862,444. BUVOLI, LUCA, NEW YORK, NY. FILED 4-17-2006.

What's Your Superpower?

THE MARK CONSISTS OF STANDARD CHARACTERS WITHOUT CLAIM TO ANY PARTICULAR FONT, STYLE, SIZE, OR COLOR.

FOR ENTERTAINMENT IN THE NATURE OF A LIVE ACTION, COMEDY, ACTION, DRAMA, DOCUMENTARY, AND/OR ANIMATED TELEVISION SERIES, AND PRODUCTION OF LIVE ACTION, COMEDY, ACTION, DRAMA, DOCUMENTARY AND/OR ANIMATED MOTION PICTURE FILMS PROVIDED THROUGH CABLE TELEVISION, BROADCAST TELEVISION, BROADCAST RADIO, FILM EXHIBITIONS, AND THE GLOBAL COMPUTER INFORMATION NETWORK; EDUCATIONAL SERVICES, NAMELY PROVIDING COURSES AND SEMINARS IN THE FIELD OF HEROISM (U.S. CLS. 100, 101 AND 107).

MICHAEL LEWIS, EXAMINING ATTORNEY

SN 78-862,524. RIPPYFISH RECORDS, LLC., SALT LAKE CITY, UT. FILED 4-17-2006.

RIPPYFISH RECORDS

THE MARK CONSISTS OF STANDARD CHARACTERS WITHOUT CLAIM TO ANY PARTICULAR FONT, STYLE, SIZE, OR COLOR.

NO CLAIM IS MADE TO THE EXCLUSIVE RIGHT TO USE RECORDS, APART FROM THE MARK AS SHOWN.

FOR ART AND ENTERTAINMENT SERVICES, NAMELY, MUSIC PRODUCTION (U.S. CLS. 100, 101 AND 107).

CARYN GLASSER, EXAMINING ATTORNEY

SN 78-862,533. RIPPYFISH RECORDS, LLC., SALT LAKE CITY, UT. FILED 4-17-2006.

RIPPYFEST

THE MARK CONSISTS OF STANDARD CHARACTERS WITHOUT CLAIM TO ANY PARTICULAR FONT, STYLE, SIZE, OR COLOR.

FOR ART AND ENTERTAINMENT SERVICES, NAMELY, PROVIDING A WEBSITE FEATURING AN ON-LINE MUSIC FESTIVAL AND GAMES (U.S. CLS. 100, 101 AND 107).

FIRST USE 3-15-2006; IN COMMERCE 3-15-2006.
CARYN GLASSER, EXAMINING ATTORNEY

CLASS 41—(Continued).

SN 78-862,625. KERSH, JOHN, W., OAK PARK, IL. FILED 4-17-2006.

Citrus Gym

THE MARK CONSISTS OF STANDARD CHARACTERS WITHOUT CLAIM TO ANY PARTICULAR FONT, STYLE, SIZE, OR COLOR.

NO CLAIM IS MADE TO THE EXCLUSIVE RIGHT TO USE GYM, APART FROM THE MARK AS SHOWN.

FOR HEALTH CLUB SERVICES, NAMELY PROVIDING INSTRUCTION AND EQUIPMENT IN THE FIELD OF PHYSICAL EXERCISE (U.S. CLS. 100, 101 AND 107).

TAMARA LEE, EXAMINING ATTORNEY

SN 78-862,780. AMERICAN EXPRESS MARKETING & DEVELOPMENT CORP., NEW YORK, NY. FILED 4-17-2006.

AMEXCELLENCE

THE MARK CONSISTS OF STANDARD CHARACTERS WITHOUT CLAIM TO ANY PARTICULAR FONT, STYLE, SIZE, OR COLOR.

FOR PROVIDING RECOGNITION AND INCENTIVES TO TRAVEL AGENTS TO DEMONSTRATE EXCELLENCE IN THEIR FIELD THROUGH THE USE OF AWARDS (U.S. CLS. 100, 101 AND 107).

MEGAN WHITNEY, EXAMINING ATTORNEY

SN 78-862,822. BELIEFNET, INC., NEW YORK, NY. FILED 4-17-2006.

GLOW

THE MARK CONSISTS OF STANDARD CHARACTERS WITHOUT CLAIM TO ANY PARTICULAR FONT, STYLE, SIZE, OR COLOR.

FOR PROVIDING NEWSLETTERS IN THE FIELD OF SPIRITUALITY VIA E-MAIL (U.S. CLS. 100, 101 AND 107).

FIRST USE 1-25-2006; IN COMMERCE 1-25-2006.
WON TEAK OH, EXAMINING ATTORNEY

CLASS 41—(Continued).

SN 78-862,831. BELIEFNET, INC., NEW YORK, NY. FILED 4-17-2006.

GLOW ENLIGHTEN YOUR LIFE

THE MARK CONSISTS OF STANDARD CHARACTERS WITHOUT CLAIM TO ANY PARTICULAR FONT, STYLE, SIZE, OR COLOR.

FOR PROVIDING NEWSLETTERS IN THE FIELD OF SPIRITUALITY VIA E-MAIL (U.S. CLS. 100, 101 AND 107).

FIRST USE 1-25-2006; IN COMMERCE 1-25-2006.
WON TEAK OH, EXAMINING ATTORNEY

SN 78-862,846. BELIEFNET, INC., NEW YORK, NY. FILED 4-17-2006.



THE COLOR(S) GOLD, TAN, BLUE, LIGHT BLUE, ORANGE IS/ARE CLAIMED AS A FEATURE OF THE MARK.

THE MARK CONSISTS OF THE WORD "GLOW" IN BLUE, THE WORDS "ENLIGHTEN YOUR LIFE" IN LIGHT BLUE, AND A GOLD AND TAN-VERTICALLY STRIPED SPHERE TO THE LEFT OF THE WORD GLOW, WITH ORANGE AT THE BOTTOM OF THE SPHERE WITH WAVY HORIZON.

FOR PROVIDING NEWSLETTERS IN THE FIELD OF SPIRITUALITY VIA E-MAIL (U.S. CLS. 100, 101 AND 107).

FIRST USE 1-25-2006; IN COMMERCE 1-25-2006.
WON TEAK OH, EXAMINING ATTORNEY

SN 78-862,863. BELIEFNET, INC., NEW YORK, NY. FILED 4-17-2006.



THE COLOR(S) GOLD, TAN, BLUE, ORANGE IS/ARE CLAIMED AS A FEATURE OF THE MARK.

THE MARK CONSISTS OF THE WORD "GLOW" IN BLUE AND A GOLD AND TAN-VERTICALLY STRIPED SPHERE TO THE LEFT OF THE WORD GLOW, WITH ORANGE AT THE BOTTOM OF THE SPHERE WITH WAVY HORIZON.

FOR PROVIDING NEWSLETTERS IN THE FIELD OF SPIRITUALITY VIA E-MAIL (U.S. CLS. 100, 101 AND 107).

FIRST USE 1-25-2006; IN COMMERCE 1-25-2006.
WON TEAK OH, EXAMINING ATTORNEY

CLASS 41—(Continued).

SN 78-863,012. NEW ORLEANS ZEPHYRS BASEBALL CLUB, LLC, METAIRIE, LA. FILED 4-17-2006.

ZEPHYRS

THE MARK CONSISTS OF STANDARD CHARACTERS WITHOUT CLAIM TO ANY PARTICULAR FONT, STYLE, SIZE, OR COLOR.

OWNER OF U.S. REG. NOS. 3,026,883 AND 3,026,884.
FOR ENTERTAINMENT SERVICES NAMELY BASEBALL GAMES AND EXHIBITIONS (U.S. CLS. 100, 101 AND 107).

FIRST USE 3-31-1984; IN COMMERCE 3-31-1984.
DOMINIC FATHY, EXAMINING ATTORNEY

SN 78-863,146. BODY HOOPS, LLC, OJAI, CA. FILED 4-17-2006.

BODYHOOPS

THE MARK CONSISTS OF STANDARD CHARACTERS WITHOUT CLAIM TO ANY PARTICULAR FONT, STYLE, SIZE, OR COLOR.

FOR PHYSICAL EXERCISE INSTRUCTION (U.S. CLS. 100, 101 AND 107).

FIRST USE 4-15-2005; IN COMMERCE 4-15-2005.
WON TEAK OH, EXAMINING ATTORNEY

SN 78-863,246. SIRPOLAIDIS, NICHOLAS A., CORONA DEL MAR, CA. FILED 4-17-2006.

August House

THE MARK CONSISTS OF STANDARD CHARACTERS WITHOUT CLAIM TO ANY PARTICULAR FONT, STYLE, SIZE, OR COLOR.

FOR ENTERTAINMENT, NAMELY, LIVE PERFORMANCES BY A MUSICAL BAND (U.S. CLS. 100, 101 AND 107).

CAROL SPILS, EXAMINING ATTORNEY

CLASS 41—(Continued).

SN 78-863,465. VESSEL TO SHORE PRODUCTIONS LLC, WILMETTE, IL. FILED 4-18-2006.

VESSEL TO SHORE PRODUCTIONS

THE MARK CONSISTS OF STANDARD CHARACTERS WITHOUT CLAIM TO ANY PARTICULAR FONT, STYLE, SIZE, OR COLOR.

NO CLAIM IS MADE TO THE EXCLUSIVE RIGHT TO USE "PRODUCTIONS", APART FROM THE MARK AS SHOWN.

FOR TELEVISION AND VIDEOTAPE PRODUCTION (U.S. CLS. 100, 101 AND 107).

LAURIE MAYES, EXAMINING ATTORNEY

SN 78-863,691. SCHMUCKER, MATT, WASHINGTON, DC. FILED 4-18-2006.

9MARKS

THE MARK CONSISTS OF STANDARD CHARACTERS WITHOUT CLAIM TO ANY PARTICULAR FONT, STYLE, SIZE, OR COLOR.

FOR EDUCATION SERVICES NAMELY, MENTORING IN THE FIELD OF RELIGIOUS INSTRUCTION; RELIGIOUS INSTRUCTION SERVICES (U.S. CLS. 100, 101 AND 107).

FIRST USE 1-1-2000; IN COMMERCE 1-1-2000.
MONIQUE MILLER, EXAMINING ATTORNEY

SN 78-863,856. ELIZABETH TRUCK CENTER INC., ELIZABETH, NJ. FILED 4-18-2006.

RIGGED

THE MARK CONSISTS OF STANDARD CHARACTERS WITHOUT CLAIM TO ANY PARTICULAR FONT, STYLE, SIZE, OR COLOR.

FOR ENTERTAINMENT, NAMELY A CONTINUING REALITY-BASED SHOW BROADCAST OVER TELEVISION, SATELLITE, AUDIO, AND VIDEO MEDIA (U.S. CLS. 100, 101 AND 107).

GRETTA YAO, EXAMINING ATTORNEY

CLASS 41—(Continued).

SN 78-863,941. CINCINNATI BELL INC., CINCINNATI, OH. FILED 4-18-2006.

ZOOMNEWS

THE MARK CONSISTS OF STANDARD CHARACTERS WITHOUT CLAIM TO ANY PARTICULAR FONT, STYLE, SIZE, OR COLOR.

FOR NEWSLETTER SENT TO SUBSCRIBERS VIA E-MAIL, FEATURING ARTICLES OF INTEREST TO INTERNET USERS (U.S. CLS. 100, 101 AND 107).

FIRST USE 4-4-2006; IN COMMERCE 4-4-2006.

FRED MANDIR, EXAMINING ATTORNEY

SN 78-864,066. MAYS MARKETING GROUP, ERIE, PA. FILED 4-18-2006.

DECORATED FOR SUCCESS

THE MARK CONSISTS OF STANDARD CHARACTERS WITHOUT CLAIM TO ANY PARTICULAR FONT, STYLE, SIZE, OR COLOR.

FOR EDUCATION SERVICES, NAMELY, PROVIDING CLASSES, SEMINARS, WORKSHOPS IN THE FIELD OF DEVELOPING PROMOTIONAL PRODUCTS (U.S. CLS. 100, 101 AND 107).

JENNIFER VASQUEZ, EXAMINING ATTORNEY

SN 78-864,076. BANG HARD MUSIC CORP., HENDERSON, NV. FILED 4-18-2006.

ATOMIC ARSENAL

THE MARK CONSISTS OF STANDARD CHARACTERS WITHOUT CLAIM TO ANY PARTICULAR FONT, STYLE, SIZE, OR COLOR.

FOR ENTERTAINMENT SERVICES, NAMELY MUSIC PRODUCTION SERVICES AND MUSICAL COMPOSITION, RECORDING AND PRODUCTION FOR USE IN CONNECTION WITH ADVERTISING, ENTERTAINMENT, EDUCATION, EVENTS, FILMS, GAMES, MARKETING, MOTION PICTURES, MULTI-MEDIA APPLICATIONS, PROMOTIONS, TELEVISION, AND/OR VIDEOS (U.S. CLS. 100, 101 AND 107).

GRETTA YAO, EXAMINING ATTORNEY

CLASS 41—(Continued).

SN 78-864,250. SAFETY COMPLIANCE SERVICES, LLC, GLENDALE, CA. FILED 4-18-2006.

OSHURANCE

THE MARK CONSISTS OF STANDARD CHARACTERS WITHOUT CLAIM TO ANY PARTICULAR FONT, STYLE, SIZE, OR COLOR.

FOR EDUCATIONAL SERVICES, NAMELY, CONDUCTING SEMINARS, CONFERENCES AND WORKSHOPS IN THE FIELDS OF WORKPLACE SAFETY AND COMPLIANCE WITH WORKPLACE SAFETY REGULATIONS; EDUCATIONAL SERVICES, NAMELY, CONDUCTING ONLINE SEMINARS AND TUTORIALS IN THE FIELDS OF WORKPLACE SAFETY AND COMPLIANCE WITH WORKPLACE SAFETY REGULATIONS (U.S. CLS. 100, 101 AND 107).

MARY CRAWFORD, EXAMINING ATTORNEY

CLASS 41—(Continued).

SN 78-864,795. HEALTHSIMPLE TOOLS, LLC, MINNEAPOLIS, MN. FILED 4-19-2006.

HEALTHSIMPLE

THE MARK CONSISTS OF STANDARD CHARACTERS WITHOUT CLAIM TO ANY PARTICULAR FONT, STYLE, SIZE, OR COLOR.

FOR EDUCATION SERVICES, NAMELY, PROVIDING WORKSHOPS AND SEMINARS IN THE FIELD OF HEALTH EDUCATION AND LIFESTYLE MANAGEMENT; CONSULTING SERVICES IN CONNECTION WITH PROVIDING PATIENT EDUCATION IN HEALTH AND LIFESTYLE MANAGEMENT (U.S. CLS. 100, 101 AND 107).

RUDY R. SINGLETON, EXAMINING ATTORNEY

SN 78-864,779. HURRICLAIM, LLC, BRANDON, FL. FILED 4-19-2006.

HURRICLAIM

THE MARK CONSISTS OF STANDARD CHARACTERS WITHOUT CLAIM TO ANY PARTICULAR FONT, STYLE, SIZE, OR COLOR.

FOR EDUCATIONAL SERVICES, NAMELY, CONDUCTING CLASSES AND ON-LINE CLASSES IN THE FIELD OF CATASTROPHE CLAIMS ADJUSTING IN THE FIELD OF INSURANCE (U.S. CLS. 100, 101 AND 107).

FIRST USE 5-20-2005; IN COMMERCE 5-20-2005.
MATTHEW MCDOWELL, EXAMINING ATTORNEY

SN 78-865,035. UNIVERSAL CITY STUDIOS LLLP, UNIVERSAL CITY, CA. FILED 4-19-2006.

**THE FAST AND THE FURIOUS:
EXTREME CLOSE-UP**

THE MARK CONSISTS OF STANDARD CHARACTERS WITHOUT CLAIM TO ANY PARTICULAR FONT, STYLE, SIZE, OR COLOR.

FOR ENTERTAINMENT SERVICES IN THE NATURE OF AN AMUSEMENT PARK ATTRACTION (U.S. CLS. 100, 101 AND 107).

DEIRDRE ROBERTSON, EXAMINING ATTORNEY

SN 78-864,786. MANGALICK, ANOOP, K, IRVINE, CA. FILED 4-19-2006.

DigiPunk

THE MARK CONSISTS OF STANDARD CHARACTERS WITHOUT CLAIM TO ANY PARTICULAR FONT, STYLE, SIZE, OR COLOR.

FOR THEATRICAL AND MUSICAL FLOOR SHOWS PROVIDED AT DISCOTHEQUES AND NIGHTCLUBS (U.S. CLS. 100, 101 AND 107).

MATTHEW MCDOWELL, EXAMINING ATTORNEY

SN 78-865,093. MORVAY, JAMES K., SPRING GROVE, IL. FILED 4-19-2006.

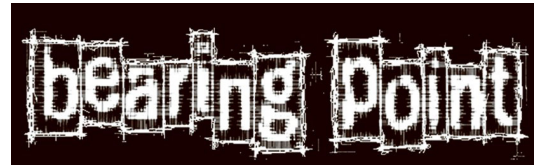

FOR PROVIDING MUSICAL ENTERTAINMENT, NAMELY, LIVE PERFORMANCES BY A MUSICAL BAND, FOR THE AMUSEMENT OR AS A RECREATIONAL ACTIVITY FOR PEOPLE (U.S. CLS. 100, 101 AND 107).

GINA FINK, EXAMINING ATTORNEY

CLASS 41—(Continued).

SN 78-865,178. DIRECTV, INC., EL SEGUNDO, CA. FILED 4-19-2006.

GET THE BEST

THE MARK CONSISTS OF STANDARD CHARACTERS WITHOUT CLAIM TO ANY PARTICULAR FONT, STYLE, SIZE, OR COLOR.

FOR DISTRIBUTION OF TELEVISION PROGRAMS FOR OTHERS; ENTERTAINMENT IN THE NATURE OF TELEVISION NEWS SHOWS; ENTERTAINMENT SERVICES, NAMELY, PROVIDING ON-LINE COMPUTER GAMES; ENTERTAINMENT SERVICES, NAMELY, PROVIDING PRERECORDED MUSIC, INFORMATION IN THE FIELD OF MUSIC, AND COMMENTARY AND ARTICLES ABOUT MUSIC, ALL ON-LINE VIA A GLOBAL COMPUTER NETWORK; PRODUCTION OF RADIO AND TELEVISION PROGRAMS; PRODUCTION OF RADIO OR TELEVISION PROGRAMS; PROGRAMMING ON A GLOBAL COMPUTER NETWORK; PROVIDING A COMPUTER GAME THAT MAY BE ACCESSED NETWORK-WIDE BY NETWORK USERS; TELEVISION PRODUCTION; TELEVISION PROGRAMMING; TELEVISION SCHEDULING; TELEVISION SHOW PRODUCTION (U.S. CLS. 100, 101 AND 107).

NORA BUCHANAN WILL, EXAMINING ATTORNEY

SN 78-865,202. CMI GAMES, INC., HENDERSON, NV. FILED 4-19-2006.

COME PLAY WITH ME

THE MARK CONSISTS OF STANDARD CHARACTERS WITHOUT CLAIM TO ANY PARTICULAR FONT, STYLE, SIZE, OR COLOR.

FOR PROVIDING LIVE, REAL TIME INSTRUCTIONS ON HOW TO PLAY CASINO GAMES OF CHANCE OVER A GLOBAL COMPUTER NETWORK (U.S. CLS. 100, 101 AND 107).

MAUREEN DALL, EXAMINING ATTORNEY

SN 78-865,212. CMI GAMES, INC., HENDERSON, NV. FILED 4-19-2006.

PLAY LIKE A DEALER

THE MARK CONSISTS OF STANDARD CHARACTERS WITHOUT CLAIM TO ANY PARTICULAR FONT, STYLE, SIZE, OR COLOR.

FOR PROVIDING LIVE, REAL TIME INSTRUCTIONS ON HOW TO PLAY CASINO GAMES OF CHANCE OVER A GLOBAL COMPUTER NETWORK (U.S. CLS. 100, 101 AND 107).

MAUREEN DALL, EXAMINING ATTORNEY

CLASS 41—(Continued).

SN 78-865,311. MOUNTAIN MEDICAL SEMINARS, REDWOOD CITY, CA. FILED 4-19-2006.

WMALS

THE MARK CONSISTS OF STANDARD CHARACTERS WITHOUT CLAIM TO ANY PARTICULAR FONT, STYLE, SIZE, OR COLOR.

FOR EDUCATIONAL SERVICES, NAMELY, CONDUCTING WORKSHOPS AND CONFERENCES IN THE FIELD OF ENVIRONMENTAL, WILDERNESS, SURVIVAL AND TRAVEL MEDICINE; PROVIDING CONTINUING MEDICAL EDUCATION COURSES (U.S. CLS. 100, 101 AND 107).

PAM WILLIS, EXAMINING ATTORNEY

SN 78-865,315. SIRENO, STARLA, SAUSALITO, CA. FILED 4-19-2006.

The Fearless Entrepreneur

THE MARK CONSISTS OF STANDARD CHARACTERS WITHOUT CLAIM TO ANY PARTICULAR FONT, STYLE, SIZE, OR COLOR.

NO CLAIM IS MADE TO THE EXCLUSIVE RIGHT TO USE "ENTREPRENEUR", APART FROM THE MARK AS SHOWN.

FOR PERSONAL COACHING SERVICES FOR INDIVIDUALS AND BUSINESS OWNERS IN THE FIELD OF ENTREPRENEURSHIP FEATURING FACE-TO-FACE INSTRUCTION IN BUSINESS DEVELOPMENT, BUSINESS GROWTH AND BUSINESS ASSESSMENTS; CONDUCTING WORKSHOPS AND SEMINARS IN THE FIELD OF ENTREPRENEURSHIP, BUSINESS GROWTH AND BUSINESS DEVELOPMENT (U.S. CLS. 100, 101 AND 107).

FIRST USE 1-2-2006; IN COMMERCE 2-2-2006.

RUSS HERMAN, EXAMINING ATTORNEY

SN 78-865,510. KEY ENTERPRISES LLC, DBA MSP COMMUNICATIONS, MINNEAPOLIS, MN. FILED 4-20-2006.

LIFE IN STYLE

THE MARK CONSISTS OF STANDARD CHARACTERS WITHOUT CLAIM TO ANY PARTICULAR FONT, STYLE, SIZE, OR COLOR.

FOR ONLINE JOURNALS, NAMELY, BLOGS FEATURING SHOPPING (U.S. CLS. 100, 101 AND 107).

FIRST USE 2-1-2006; IN COMMERCE 2-1-2006.

ALLISON SCHRODY, EXAMINING ATTORNEY

CLASS 41—(Continued).

SN 78-865,514. KEY ENTERPRISES LLC, DBA MSP COMMUNICATIONS, MINNEAPOLIS, MN. FILED 4-20-2006.

CHOW & AGAIN

THE MARK CONSISTS OF STANDARD CHARACTERS WITHOUT CLAIM TO ANY PARTICULAR FONT, STYLE, SIZE, OR COLOR.

FOR ONLINE JOURNALS, NAMELY, BLOGS FEATURING FOOD AND DINING (U.S. CLS. 100, 101 AND 107).

FIRST USE 4-10-2006; IN COMMERCE 4-10-2006.
ALLISON SCHRODY, EXAMINING ATTORNEY

CLASS 41—(Continued).

SN 78-865,631. THE FILMPUNKS, HOLLYWOOD, CA. FILED 4-20-2006.

FILMPUNKS

THE MARK CONSISTS OF STANDARD CHARACTERS WITHOUT CLAIM TO ANY PARTICULAR FONT, STYLE, SIZE, OR COLOR.

FOR CINEMATOGRAPHIC ADAPTATION AND EDITING; CONDUCTING ENTERTAINMENT EXHIBITIONS IN THE NATURE OF PREMIER PARTIES; CUSTOM WRITING SERVICES; DIRECTION OF MAKING RADIO OR TELEVISION PROGRAMS; EDITING OR RECORDING OF SOUNDS AND IMAGES; ENTERTAINMENT NAMELY, PREPARATION OF SPECIAL EFFECTS; ENTERTAINMENT NAMELY, PRODUCTION OF MUSIC VIDEOS AND CORPORATE VIDEOS; FILM EDITING; MOTION PICTURE FILM PRODUCTION; PHOTO EDITING; PHOTOGRAPHY SERVICES; POEM AND LYRIC WRITING; SCRIPT WRITING SERVICES; SONG WRITING SERVICES; SPECIAL EVENT PLANNING; TELEVISION PRODUCTION; VIDEO EDITING; VIDEO TAPE EDITING; WRITTEN TEXT EDITING (U.S. CLS. 100, 101 AND 107).

FIRST USE 3-13-2006; IN COMMERCE 3-13-2006.
NAAKWAMA ANKRAH, EXAMINING ATTORNEY

SN 78-865,518. EXTREME PHOTOGRAPHY, ARLINGTON, TX. FILED 4-20-2006.

EXTREME PHOTOGRAPHY

THE MARK CONSISTS OF STANDARD CHARACTERS WITHOUT CLAIM TO ANY PARTICULAR FONT, STYLE, SIZE, OR COLOR.

NO CLAIM IS MADE TO THE EXCLUSIVE RIGHT TO USE "PHOTOGRAPHY", APART FROM THE MARK AS SHOWN.

FOR PHOTOGRAPHY SERVICES AND PORTRAIT PHOTOGRAPHY SERVICES (U.S. CLS. 100, 101 AND 107).

FIRST USE 11-0-1998; IN COMMERCE 11-0-1998.
JOHN GARTNER, EXAMINING ATTORNEY

SN 78-865,754. MONKEY BIZNESS PLAYCENTER, LLC., SMYRNA, GA. FILED 4-20-2006.

MONKEY ADVENTURES

THE MARK CONSISTS OF STANDARD CHARACTERS WITHOUT CLAIM TO ANY PARTICULAR FONT, STYLE, SIZE, OR COLOR.

FOR CHILDREN'S ENTERTAINMENT AND AMUSEMENT CENTERS, NAMELY, INTERACTIVE PLAY AREAS FOR INDOOR USE (U.S. CLS. 100, 101 AND 107).

MARY MUNSON, EXAMINING ATTORNEY

CLASS 41—(Continued).

SN 78-866,034. JAI ENTERTAINMENT, LLC, PHILADELPHIA, PA. FILED 4-20-2006.

Jai Entertainment

THE MARK CONSISTS OF STANDARD CHARACTERS WITHOUT CLAIM TO ANY PARTICULAR FONT, STYLE, SIZE, OR COLOR.

NO CLAIM IS MADE TO THE EXCLUSIVE RIGHT TO USE "ENTERTAINMENT", APART FROM THE MARK AS SHOWN.

THE ENGLISH TRANSLATION OF THE THAI WORD JAI IN THE MARK IS HEART.

FOR ENTERTAINMENT SERVICES, NAMELY, PRESENTING LIVE MUSICAL AND THEATRICAL PERFORMANCES; AND ARRANGING FOR TICKET RESERVATIONS FOR SHOWS AND OTHER ENTERTAINMENT EVENTS (U.S. CLS. 100, 101 AND 107).

ANDREA SAUNDERS, EXAMINING ATTORNEY

CLASS 41—(Continued).

SN 78-866,271. WRIGHT, TOM, PROVO, UT. AND LOCKHART, BARBRA, NORTH SALT LAKE, UT. FILED 4-20-2006.

GAGA

THE MARK CONSISTS OF STANDARD CHARACTERS WITHOUT CLAIM TO ANY PARTICULAR FONT, STYLE, SIZE, OR COLOR.

FOR TELEVISION SHOW PRODUCTION, NAMELY TELEVISION SHOWS ABOUT HEALTHY LIVING, EXERCISE, AND NUTRITION; TELEVISION SHOWS ABOUT BODY, MIND, SPIRIT, AND ACHIEVEMENT (U.S. CLS. 100, 101 AND 107).

FIRST USE 7-15-2005; IN COMMERCE 7-15-2005.
CHRISTOPHER BUONGIORNO, EXAMINING ATTORNEY

SN 78-866,313. NAUMOV, VICTOR N., NEW MILFORD, NJ. FILED 4-20-2006.

Peak Performance Pentagon

THE MARK CONSISTS OF STANDARD CHARACTERS WITHOUT CLAIM TO ANY PARTICULAR FONT, STYLE, SIZE, OR COLOR.

FOR EDUCATION SERVICES, NAMELY, PROVIDING CLASSES, LECTURES, SEMINARS, WORKSHOPS IN THE FIELD OF HEALTH AND HUMAN PERFORMANCE; TRAINING PROGRAMS IN THE FIELD OF HEALTH AND HUMAN PERFORMANCE (U.S. CLS. 100, 101 AND 107).

FIRST USE 9-0-2005; IN COMMERCE 1-0-2006.
DEIRDRE ROBERTSON, EXAMINING ATTORNEY

SN 78-866,166. FARNER, MARK, PETOSKY, MI. FILED 4-20-2006.



THE NAME(S), PORTRAIT(S), AND/OR SIGNATURE(S) SHOWN IN THE MARK IDENTIFIES MARK FARNER, WHOSE CONSENT(S) TO REGISTER IS MADE OF RECORD.

THE COLOR(S) RED, BLACK AND WHITE IS/ARE CLAIMED AS A FEATURE OF THE MARK.

THE COLOR RED APPEARS IN THE STYLIZED LETTERING MARK FARNER AND THE UNDERLINE. THE COLOR BLACK APPEARS IN THE OUTLINING OF ALL THE WORDING IN THE MARK. THE COLOR WHITE APPEARS IN THE LETTERING THE ROCK PATRIOT.

FOR ENTERTAINMENT, NAMELY, LIVE PERFORMANCES BY ROCK GROUPS (U.S. CLS. 100, 101 AND 107).

FIRST USE 3-15-2006; IN COMMERCE 3-15-2006.
HEATHER SAPP, EXAMINING ATTORNEY

SN 78-866,349. TRATON NEWS, LLC, MARIETTA, GA. FILED 4-20-2006.

TRATON

THE MARK CONSISTS OF STANDARD CHARACTERS WITHOUT CLAIM TO ANY PARTICULAR FONT, STYLE, SIZE, OR COLOR.

FOR NEWS REPORTING SERVICES (U.S. CLS. 100, 101 AND 107).

FIRST USE 3-15-2006; IN COMMERCE 3-15-2006.
IRA J. GOODSaid, EXAMINING ATTORNEY

CLASS 41—(Continued).

SN 78-866,383. MUDD, CHARLES LEE JR., CHICAGO, IL. AND MUDD, KATHERINE ELIZABETH, CHICAGO, IL. FILED 4-21-2006.

Tanchakat

THE MARK CONSISTS OF STANDARD CHARACTERS WITHOUT CLAIM TO ANY PARTICULAR FONT, STYLE, SIZE, OR COLOR.

FOR ENTERTAINMENT NAMELY, PRODUCTION OF FILMS, TELEVISION, RECORDED AUDIO AND VISUAL PROGRAMS; FILM DISTRIBUTION; FILM EDITING; FILM STUDIOS; MOTION PICTURE FILM PRODUCTION; MOVIE STUDIOS; OPERATING OF FILM STUDIOS; PRODUCTION AND DISTRIBUTION OF MOTION PICTURES (U.S. CLS. 100, 101 AND 107).

FIRST USE 2-9-2006; IN COMMERCE 2-9-2006.
JAMES GRIFFIN, EXAMINING ATTORNEY

CLASS 41—(Continued).

SN 78-866,903. SEANOVA, NUUFOLAU JOEL, BEVERLY HILLS, CA. FILED 4-21-2006.

SAMOA JOE

THE MARK CONSISTS OF STANDARD CHARACTERS WITHOUT CLAIM TO ANY PARTICULAR FONT, STYLE, SIZE, OR COLOR.

THE NAME SAMOA JOE IDENTIFIES A LIVING INDIVIDUAL WHOSE CONSENT IS OF RECORD.

FOR ENTERTAINMENT IN THE NATURE OF WRESTLING CONTESTS; ENTERTAINMENT SERVICES IN THE NATURE OF A WRESTLING CLUB; ENTERTAINMENT SERVICES NAMELY LIVE, TELEVISED AND MOVIE APPEARANCES BY A PROFESSIONAL ENTERTAINER; ENTERTAINMENT SERVICES, NAMELY, PERSONAL APPEARANCES BY A PROFESSIONAL WRESTLER (U.S. CLS. 100, 101 AND 107).

FIRST USE 9-30-1999; IN COMMERCE 9-30-1999.
ELIZABETH PIGNATELLO, EXAMINING ATTORNEY

SN 78-866,562. FARNER, MARK, PETOSKY, MI. FILED 4-21-2006.

Rock Patriot

THE MARK CONSISTS OF STANDARD CHARACTERS WITHOUT CLAIM TO ANY PARTICULAR FONT, STYLE, SIZE, OR COLOR.

FOR ENTERTAINMENT, NAMELY, LIVE PERFORMANCES BY ROCK GROUPS (U.S. CLS. 100, 101 AND 107).

FIRST USE 3-15-2006; IN COMMERCE 3-15-2006.
HEATHER SAPP, EXAMINING ATTORNEY

SN 78-867,377. YURKANIS, NAN, E., SEATTLE, WA. FILED 4-22-2006.

The Quest for Rest

THE MARK CONSISTS OF STANDARD CHARACTERS WITHOUT CLAIM TO ANY PARTICULAR FONT, STYLE, SIZE, OR COLOR.

FOR CONDUCTING WORKSHOPS AND SEMINARS IN THE FIELD OF SELF HEALTH CARE (U.S. CLS. 100, 101 AND 107).

FIRST USE 12-1-2004; IN COMMERCE 1-11-2005.
KAREN K. BUSH, EXAMINING ATTORNEY

SN 78-866,730. UNIVERSAL CITY STUDIOS LLLP, UNIVERSAL CITY, CA. FILED 4-21-2006.

UNIVERSAL 360

THE MARK CONSISTS OF STANDARD CHARACTERS WITHOUT CLAIM TO ANY PARTICULAR FONT, STYLE, SIZE, OR COLOR.

OWNER OF U.S. REG. NOS. 1,144,545, 2,565,904 AND OTHERS.

FOR AMUSEMENT PARK SERVICES (U.S. CLS. 100, 101 AND 107).

DEIRDRE ROBERTSON, EXAMINING ATTORNEY

SN 78-867,426. ROSEN, DENNIS L., LAWRENCE, KS. FILED 4-22-2006.

WINFLUENCE

THE MARK CONSISTS OF STANDARD CHARACTERS WITHOUT CLAIM TO ANY PARTICULAR FONT, STYLE, SIZE, OR COLOR.

FOR WORKSHOPS, SEMINARS AND TRAINING ON PERSUASION, PERCEPTION FORMATION AND CHANGE, ATTITUDE FORMATION AND CHANGE, BEHAVIOR AND BEHAVIORAL CHANGE (U.S. CLS. 100, 101 AND 107).

FIRST USE 3-24-2006; IN COMMERCE 3-24-2006.
PETER CHENG, EXAMINING ATTORNEY

CLASS 41—(Continued).

SN 78-867,480. GENESIS FITNESS, LLC, DENVER, CO.
FILED 4-22-2006.



NO CLAIM IS MADE TO THE EXCLUSIVE RIGHT TO USE "FITNESS", APART FROM THE MARK AS SHOWN.
THE MARK CONSISTS OF A CRESCENT WITH GENESIS EXTENDING FROM IT AND FITNESS UNDERNEATH.
FOR PHYSICAL FITNESS INSTRUCTION; PROVIDING FITNESS AND EXERCISE FACILITIES (U.S. CLS. 100, 101 AND 107).

FIRST USE 5-1-2003; IN COMMERCE 5-1-2003.
KYLE PEETE, EXAMINING ATTORNEY

SN 78-868,355. NEW YORK CITY CENTER, NEW YORK, NY.
FILED 4-24-2006.

FALL FOR DANCE

THE MARK CONSISTS OF STANDARD CHARACTERS WITHOUT CLAIM TO ANY PARTICULAR FONT, STYLE, SIZE, OR COLOR.

NO CLAIM IS MADE TO THE EXCLUSIVE RIGHT TO USE "DANCE", APART FROM THE MARK AS SHOWN.

FOR ENTERTAINMENT IN THE NATURE OF DANCE PERFORMANCES AND DANCE FESTIVALS (U.S. CLS. 100, 101 AND 107).

FIRST USE 7-31-2004; IN COMMERCE 7-31-2004.
ESTHER BELENKER, EXAMINING ATTORNEY

SN 78-868,357. O.R. NURSES, INC., GERMANTOWN, TN.
FILED 4-24-2006.

TIME Training Individuals for Medical Excellence

THE MARK CONSISTS OF STANDARD CHARACTERS WITHOUT CLAIM TO ANY PARTICULAR FONT, STYLE, SIZE, OR COLOR.

NO CLAIM IS MADE TO THE EXCLUSIVE RIGHT TO USE "TRAINING INDIVIDUALS FOR MEDICAL EXCELLENCE", APART FROM THE MARK AS SHOWN.

FOR MEDICAL TRAINING AND TEACHING (U.S. CLS. 100, 101 AND 107).

FIRST USE 5-1-2004; IN COMMERCE 5-1-2004.
DEIRDRE ROBERTSON, EXAMINING ATTORNEY

CLASS 41—(Continued).

SN 78-868,373. O.R. NURSES, INC., GERMANTOWN, TN.
FILED 4-24-2006.



NO CLAIM IS MADE TO THE EXCLUSIVE RIGHT TO USE "TRAINING INDIVIDUALS FOR MEDICAL EXCELLENCE", APART FROM THE MARK AS SHOWN.

THE COLOR(S) BLUE, GREEN, WHITE IS/ARE CLAIMED AS A FEATURE OF THE MARK.

THE MARK CONSISTS OF A DESIGN OF A CLOCK-LIKE FACE FEATURED IN GREEN WITH HATCH MARKS FEATURED IN BLUE SUPERIMPOSED AGAINST A CIRCLE WITH A BLUE BACKGROUND WITH A TRIANGULAR SHAPED SECTION OVERLAYING A PORTION OF THE CLOCK-LIKE FACE. THE WORDING "TRAINING INDIVIDUALS - FOR MEDICAL EXCELLENCE -" IS FEATURED IN BLUE SURROUNDING THE OUTSIDE OF THE BLUE CIRCLE. INSIDE THE CLOCK-LIKE DESIGN IS A LIGHT GREEN CIRCLE, FOLLOWED BY A WHITE CIRCLE, FOLLOWED BY A BLUE CIRCLE REPRESENTING THE LETTER "O." THE BACKGROUND OF THE "O" IS FEATURED IN GREEN AND WHITE. THE TERM "TIME" IS FEATURED IN BLUE WITH A WHITE RECTANGULAR BACKGROUND IN THE LEFT HALF OF THE "O" DESIGN. A STYLIZED "R" FEATURED IN WHITE AND BLUE WITH CLOCK HANDS IN WHITE AND BLUE EXTENDING OUT TO THE BLUE CIRCLE REPRESENTING THE BACK OF THE "R" AND THE LEG OF THE "R" FEATURED IN THE RIGHT HALF OF THE "O" DESIGN.

FOR MEDICAL TRAINING AND TEACHING (U.S. CLS. 100, 101 AND 107).

FIRST USE 5-1-2004; IN COMMERCE 5-1-2004.

DEIRDRE ROBERTSON, EXAMINING ATTORNEY

SN 78-868,391. ROCKY GENNARO, CESARE DI PIETRO, RICHARD CIMINI, TONY PISEGNA PARTNERSHIP, THE, BOLTON, ONTARIO, CANADA, FILED 4-24-2006.

Grounded

THE MARK CONSISTS OF STANDARD CHARACTERS WITHOUT CLAIM TO ANY PARTICULAR FONT, STYLE, SIZE, OR COLOR.

FOR ENTERTAINMENT IN THE NATURE OF VISUAL AND AUDIO PERFORMANCES, NAMELY, MUSICAL BAND, ROCK GROUP, GYMNASTIC, DANCE, AND BALLET PERFORMANCES (U.S. CLS. 100, 101 AND 107).

MARIA-VICTORIA SUAREZ, EXAMINING ATTORNEY

CLASS 41—(Continued).

SN 78-868,637. GIVON FLYING CLUB INC., DUMONT, NJ. FILED 4-25-2006.

The Hobby Quest

THE MARK CONSISTS OF STANDARD CHARACTERS WITHOUT CLAIM TO ANY PARTICULAR FONT, STYLE, SIZE, OR COLOR.

NO CLAIM IS MADE TO THE EXCLUSIVE RIGHT TO USE "HOBBY", APART FROM THE MARK AS SHOWN.

FOR EDUCATION SERVICES, NAMELY, PROVIDING HANDS-ON EDUCATIONAL CLASSES, WORKSHOPS, IN-SCHOOL PROGRAMS, PARTIES, CAMPS IN THE FIELD OF HOBBIES AND CRAFTSMANSHIP (U.S. CLS. 100, 101 AND 107).

FIRST USE 7-1-2005; IN COMMERCE 8-10-2005.
VERNA BETH RIRIE, EXAMINING ATTORNEY

SN 78-868,646. CORMIER, ROY, BROOKLYN, NY. AND JONES, CLIFF, BROOKLYN, NY. AND JACKSON, ERROL, BROOKLYN, NY. FILED 4-25-2006.

LET'S CALL IT HIP HOP

THE MARK CONSISTS OF STANDARD CHARACTERS WITHOUT CLAIM TO ANY PARTICULAR FONT, STYLE, SIZE, OR COLOR.

FOR ARRANGING OF SEMINARS AND CONFERENCES (U.S. CLS. 100, 101 AND 107).

AMY GEARIN, EXAMINING ATTORNEY

SN 78-869,038. GROOVE EVENTS AND ENTERTAINMENT, INC., TARRYTOWN, NY. FILED 4-25-2006.

AFTER MIDNIGHT

THE MARK CONSISTS OF STANDARD CHARACTERS WITHOUT CLAIM TO ANY PARTICULAR FONT, STYLE, SIZE, OR COLOR.

FOR ENTERTAINMENT NAMELY, LIVE PERFORMANCES BY A MUSICAL BAND (U.S. CLS. 100, 101 AND 107).

FIRST USE 2-1-2002; IN COMMERCE 2-1-2002.
TARAH HARDY, EXAMINING ATTORNEY

CLASS 41—(Continued).

SN 78-869,068. MOELLER, KIM, JERSEY CITY, NJ. FILED 4-25-2006.

MULTIMAN

THE MARK CONSISTS OF STANDARD CHARACTERS WITHOUT CLAIM TO ANY PARTICULAR FONT, STYLE, SIZE, OR COLOR.

FOR ENTERTAINMENT SERVICES, NAMELY MUSIC PRODUCTION (U.S. CLS. 100, 101 AND 107).

INGRID C. EULIN, EXAMINING ATTORNEY

SN 78-869,447. BROWN, JEFFREY BELL, MARSHFIELD, MA. FILED 4-25-2006.

MIDNIGHT OWL

THE MARK CONSISTS OF STANDARD CHARACTERS WITHOUT CLAIM TO ANY PARTICULAR FONT, STYLE, SIZE, OR COLOR.

FOR MUSIC PUBLISHING SERVICES (U.S. CLS. 100, 101 AND 107).

ESTHER BELENKER, EXAMINING ATTORNEY

SN 78-869,583. LEE, BURTON, HOYT, ARLINGTON, VA. FILED 4-26-2006.

Innovarium

THE MARK CONSISTS OF STANDARD CHARACTERS WITHOUT CLAIM TO ANY PARTICULAR FONT, STYLE, SIZE, OR COLOR.

FOR GUIDED TOURS OF A MUSEUM OR RELATED EDUCATIONAL AND RESEARCH FACILITY; MUSEUMS; RUNNING OF MUSEUMS (U.S. CLS. 100, 101 AND 107).

DAVID COLLIER, EXAMINING ATTORNEY

CLASS 41—(Continued).

SN 78-869,584. HOLMES, GREGORY A., PHILADELPHIA, PA. FILED 4-26-2006.

HuNDreD GrAnD

THE MARK CONSISTS OF STANDARD CHARACTERS WITHOUT CLAIM TO ANY PARTICULAR FONT, STYLE, SIZE, OR COLOR.

THE NAME(S), PORTRAIT(S), AND/OR SIGNATURE(S) SHOWN IN THE MARK IDENTIFIES HUNDRED GRAND, WHOSE CONSENT(S) TO REGISTER IS SUBMITTED.

FOR RECORD PRODUCTION; AUDIO PRODUCTION; ENTERTAINMENT SERVICES BY A MUSIC PRODUCER, NAMELY, MUSICAL COMPOSITION FOR OTHERS AND PRODUCTION OF MUSICAL SOUND RECORDINGS; SONG WRITING SERVICES (U.S. CLS. 100, 101 AND 107).

DAVID COLLIER, EXAMINING ATTORNEY

SN 78-869,999. PRIN, JOHN HOWARD, EDINA, MN. FILED 4-26-2006.

THE 4 SQUARES OF LIFE

THE MARK CONSISTS OF STANDARD CHARACTERS WITHOUT CLAIM TO ANY PARTICULAR FONT, STYLE, SIZE, OR COLOR.

FOR EDUCATIONAL SERVICES, NAMELY, CONDUCTING SEMINARS, WORKSHOPS AND CONFERENCES IN THE FIELD OF ADDICTION, RECOVERY, PSYCHOLOGY, CORRECTIONS AND BEHAVIORAL HEALTH AND DISTRIBUTING COURSE MATERIALS IN CONNECTION THEREWITH (U.S. CLS. 100, 101 AND 107).

FIRST USE 8-31-2004; IN COMMERCE 3-13-2006.
HOWARD B. LEVINE, EXAMINING ATTORNEY

CLASS 41—(Continued).

SN 78-870,396. KESSLER, DANIEL J., TEMPE, AZ. FILED 4-26-2006.

ANGELS WITH ATTITUDE

THE MARK CONSISTS OF STANDARD CHARACTERS WITHOUT CLAIM TO ANY PARTICULAR FONT, STYLE, SIZE, OR COLOR.

FOR EDUCATION SERVICES, NAMELY, PROVIDING CLASSES, SEMINARS, CONFERENCES AND WORKSHOPS IN THE FIELD OF SELF-DEFENSE, SELF-IMPROVEMENT AND SELF-ESTEEM; EDUCATIONAL AND ENTERTAINMENT SERVICES, NAMELY, PROVIDING MOTIVATIONAL AND EDUCATIONAL SPEAKERS; EDUCATIONAL SERVICES NAMELY CONDUCTING PROGRAMS IN THE FIELD OF SELF-DEFENSE, SELF-IMPROVEMENT AND SELF-ESTEEM (U.S. CLS. 100, 101 AND 107).

FIRST USE 10-1-2004; IN COMMERCE 10-1-2004.

JAMES MACFARLANE, EXAMINING ATTORNEY

SN 78-870,431. CORINTHIAN COLLEGES, INC., SANTA ANA, CA. FILED 4-26-2006.

EVEREST UNIVERSITY

THE MARK CONSISTS OF STANDARD CHARACTERS WITHOUT CLAIM TO ANY PARTICULAR FONT, STYLE, SIZE, OR COLOR.

OWNER OF U.S. REG. NO. 2,798,638.

NO CLAIM IS MADE TO THE EXCLUSIVE RIGHT TO USE "UNIVERSITY", APART FROM THE MARK AS SHOWN.

FOR EDUCATIONAL SERVICES, NAMELY, PROVIDING CAREER-ORIENTED POST-SECONDARY EDUCATION IN THE ACCOUNTING, ADMINISTRATIVE, BUSINESS, COMPUTER SCIENCE, HEALTHCARE, INFORMATION TECHNOLOGY, TECHNICAL, TECHNOLOGY, LEGAL, CRIMINAL JUSTICE, TRAVEL AND HOSPITALITY FIELDS (U.S. CLS. 100, 101 AND 107).

ANNE FARRELL, EXAMINING ATTORNEY

SN 78-871,384. JONES, JASON S., BELLEVIEW, FL. FILED 4-27-2006.

Skitz Beatz

THE MARK CONSISTS OF STANDARD CHARACTERS WITHOUT CLAIM TO ANY PARTICULAR FONT, STYLE, SIZE, OR COLOR.

FOR MUSIC PRODUCTION AND RECORDING (U.S. CLS. 100, 101 AND 107).

BARNEY CHARLON, EXAMINING ATTORNEY

CLASS 41—(Continued).

SN 78-871,636. FRANKS, DUANE, MILL VALLEY, CA.
FILED 4-27-2006.



THE MARK CONSISTS OF STYLIZED TEXT OF THE WORDING TRIFINITI WITH AN INTERTWINED DESIGN ABOVE IT.

FOR PHYSICAL FITNESS CONSULTATION; SPORT CAMPS (U.S. CLS. 100, 101 AND 107).

FIRST USE 1-15-2004; IN COMMERCE 1-31-2004.
KENNETH E. SHARPERSON, EXAMINING ATTORNEY

SN 78-872,666. LEPPER, DALE, SAN DIEGO, CA. FILED 4-28-2006.

The Vital Triangle

THE MARK CONSISTS OF STANDARD CHARACTERS WITHOUT CLAIM TO ANY PARTICULAR FONT, STYLE, SIZE, OR COLOR.

FOR PHYSICAL FITNESS CONSULTATION (U.S. CLS. 100, 101 AND 107).

FIRST USE 1-1-2000; IN COMMERCE 1-1-2006.
SONYA STEPHENS, EXAMINING ATTORNEY

SN 78-872,670. CEASER, JAMIE E, CHICAGO, IL. FILED 4-28-2006.

DOGumentary

THE MARK CONSISTS OF STANDARD CHARACTERS WITHOUT CLAIM TO ANY PARTICULAR FONT, STYLE, SIZE, OR COLOR.

FOR PHOTOGRAPHIC AND VIDEO SERVICES, NAMELY, PHOTOGRAPHIC AND VIDEO CAPTURE (U.S. CLS. 100, 101 AND 107).

FIRST USE 2-20-2002; IN COMMERCE 12-10-2003.
SONYA STEPHENS, EXAMINING ATTORNEY

CLASS 41—(Continued).

SN 78-872,824. MODERN WARRIOR, LINDENHURST, NY.
FILED 4-29-2006.

Modern Warrior

THE MARK CONSISTS OF STANDARD CHARACTERS WITHOUT CLAIM TO ANY PARTICULAR FONT, STYLE, SIZE, OR COLOR.

OWNER OF U.S. REG. NO. 2,546,187.
FOR EDUCATIONAL SERVICES; NAMELY, CONDUCTING CLASSES IN POLICE AND CIVILIAN SELF DEFENSE (U.S. CLS. 100, 101 AND 107).

FIRST USE 10-1-1982; IN COMMERCE 10-1-1982.
LEIGH LOWRY, EXAMINING ATTORNEY

SN 78-872,961. HOULE, DAVID, CHICAGO, IL. FILED 4-30-2006.

EVOLUTION SHIFT

THE MARK CONSISTS OF STANDARD CHARACTERS WITHOUT CLAIM TO ANY PARTICULAR FONT, STYLE, SIZE, OR COLOR.

FOR ENTERTAINMENT AND EDUCATION SERVICES, NAMELY, AN ONLINE JOURNAL PROVIDING INFORMATION, COMMENTARY AND ARTICLES ABOUT THE FUTURE (U.S. CLS. 100, 101 AND 107).

FIRST USE 4-14-2006; IN COMMERCE 4-14-2006.
SUZANNE BLANE, EXAMINING ATTORNEY

CLASS 41—(Continued).

SN 78-873,274. AGUA CALIENTE CULTURAL MUSEUM, PALM SPRINGS, CA. FILED 5-1-2006.

THE SPIRIT LIVES

THE MARK CONSISTS OF STANDARD CHARACTERS WITHOUT CLAIM TO ANY PARTICULAR FONT, STYLE, SIZE, OR COLOR.

OWNER OF U.S. REG. NO. 2,865,302.

FOR NATIVE AMERICAN ARTIFACTS MUSEUM; MUSEUM SERVICES, NAMELY, PROVIDING MUSEUM CLASSES, SEMINARS, COURSES OF INSTRUCTION, AND WORKSHOPS IN THE FIELD OF NATIVE AMERICAN ART, CULTURE, HISTORY AND CRAFTS; EDUCATIONAL AND ENTERTAINMENT SERVICES, NAMELY, PROVIDING COURSES OF INSTRUCTION, CLASSES, SEMINARS AND LECTURES IN THE FIELD OF NATIVE AMERICAN ART, CULTURE, HISTORY AND CRAFTS; ENTERTAINMENT IN THE NATURE OF LIVE STORYTELLING PROGRAMS IN THE FIELD OF NATIVE AMERICAN ART, CULTURE, HISTORY AND CRAFTS; ENTERTAINMENT AND EDUCATIONAL EXHIBITIONS IN THE NATURE OF FILM OR VIDEO PRESENTATIONS IN THE FIELD OF NATIVE AMERICAN ART, CULTURE, HISTORY AND CRAFTS; LIVE PERFORMANCE ART EXHIBITIONS; EDUCATIONAL LECTURES IN THE FIELD OF NATIVE AMERICAN ART, CULTURE, HISTORY AND CRAFTS, FEATURING LIVE ARTIST DEMONSTRATIONS (U.S. CLS. 100, 101 AND 107).

FIRST USE 4-23-1991; IN COMMERCE 10-22-1992.
GILBERT SWIFT, EXAMINING ATTORNEY

SN 78-874,089. FINISHRICH, INC., NEW YORK, NY. FILED 5-2-2006.

START LATE, FINISH RICH

THE MARK CONSISTS OF STANDARD CHARACTERS WITHOUT CLAIM TO ANY PARTICULAR FONT, STYLE, SIZE, OR COLOR.

OWNER OF U.S. REG. NOS. 2,671,222, 2,694,730 AND 2,867,154.

FOR EDUCATIONAL SERVICES, NAMELY, CONDUCTING SEMINARS IN THE FIELDS OF INVESTMENT ADVICE AND FINANCIAL PLANNING (U.S. CLS. 100, 101 AND 107).

FIRST USE 0-0-2005; IN COMMERCE 0-0-2005.
GEORGIA CARTY, EXAMINING ATTORNEY

CLASS 41—(Continued).

SN 78-874,479. ZULA USA, LLC, BURBANK, CA. FILED 5-2-2006.

THE ZULA PATROL

THE MARK CONSISTS OF STANDARD CHARACTERS WITHOUT CLAIM TO ANY PARTICULAR FONT, STYLE, SIZE, OR COLOR.

OWNER OF U.S. REG. NOS. 2,225,766, 2,713,929 AND 2,742,600.

FOR ENTERTAINMENT AND EDUCATION SERVICES IN THE NATURE OF ON-GOING TELEVISION PROGRAMS IN THE FIELD OF CHILDREN'S EDUCATION AND ENTERTAINMENT (U.S. CLS. 100, 101 AND 107).

FIRST USE 9-15-2005; IN COMMERCE 9-15-2005.
WOODROW HARTZOG, EXAMINING ATTORNEY

SN 78-874,739. SAFDARI, CYRUS, HOBOKEN, NJ. FILED 5-2-2006.

Prosperous Web

THE MARK CONSISTS OF STANDARD CHARACTERS WITHOUT CLAIM TO ANY PARTICULAR FONT, STYLE, SIZE, OR COLOR.

NO CLAIM IS MADE TO THE EXCLUSIVE RIGHT TO USE "WEB", APART FROM THE MARK AS SHOWN.

FOR PROVIDING NEWS IN THE NATURE OF CURRENT EVENT REPORTING (U.S. CLS. 100, 101 AND 107).
ANNE FARRELL, EXAMINING ATTORNEY

SN 78-875,491. CORINTHIAN COLLEGES, INC., SANTA ANA, CA. FILED 5-3-2006.

EVEREST INSTITUTE

THE MARK CONSISTS OF STANDARD CHARACTERS WITHOUT CLAIM TO ANY PARTICULAR FONT, STYLE, SIZE, OR COLOR.

OWNER OF U.S. REG. NO. 2,798,638.

NO CLAIM IS MADE TO THE EXCLUSIVE RIGHT TO USE "INSTITUTE", APART FROM THE MARK AS SHOWN.

FOR EDUCATIONAL SERVICES, NAMELY, PROVIDING CAREER-ORIENTED POST-SECONDARY EDUCATION IN THE ACCOUNTING, ADMINISTRATIVE, BUSINESS, COMPUTER SCIENCE, HEALTHCARE, INFORMATION TECHNOLOGY, TECHNICAL, TECHNOLOGY, LEGAL, CRIMINAL JUSTICE, TRAVEL AND HOSPITALITY FIELDS (U.S. CLS. 100, 101 AND 107).

FIRST USE 2-0-2005; IN COMMERCE 2-0-2005.
ANNE FARRELL, EXAMINING ATTORNEY

CLASS 41—(Continued).

SN 78-875,586. MIDCURRENT LLC, FORT MYERS, FL.
FILED 5-3-2006.

MIDCURRENT

THE MARK CONSISTS OF STANDARD CHARACTERS WITHOUT CLAIM TO ANY PARTICULAR FONT, STYLE, SIZE, OR COLOR.

FOR ENTERTAINMENT AND EDUCATIONAL SERVICES, NAMELY, PROVIDING A WEBSITE ON THE SUBJECT OF FLY FISHING (U.S. CLS. 100, 101 AND 107).

FIRST USE 3-1-2003; IN COMMERCE 3-1-2003.
IRA J. GOODSAD, EXAMINING ATTORNEY

SN 78-876,434. BLACK ENTERTAINMENT TELEVISION LLC, WASHINGTON, DC. FILED 5-4-2006.

NOTARIZED

THE MARK CONSISTS OF STANDARD CHARACTERS WITHOUT CLAIM TO ANY PARTICULAR FONT, STYLE, SIZE, OR COLOR.

FOR ENTERTAINMENT, NAMELY A CONTINUING MUSIC VIDEO SHOW BROADCAST OVER THE INTERNET, TELEVISION, CABLE, AND WIRELESS (U.S. CLS. 100, 101 AND 107).

TRAVIS WHEATLEY, EXAMINING ATTORNEY

SN 78-876,505. BLACK ENTERTAINMENT TELEVISION LLC, WASHINGTON, DC. FILED 5-4-2006.

BET HOTWYRED

THE MARK CONSISTS OF STANDARD CHARACTERS WITHOUT CLAIM TO ANY PARTICULAR FONT, STYLE, SIZE, OR COLOR.

OWNER OF U.S. REG. NOS. 1,511,259, 2,566,667 AND OTHERS.

FOR ENTERTAINMENT, NAMELY A CONTINUING MUSIC VIDEO SHOW BROADCAST OVER THE INTERNET, TELEVISION, CABLE, AND WIRELESS (U.S. CLS. 100, 101 AND 107).

TRAVIS WHEATLEY, EXAMINING ATTORNEY

CLASS 41—(Continued).

SN 78-878,095. MICROSOFT CORPORATION, REDMOND, WA. FILED 5-5-2006.

TURN 10

THE MARK CONSISTS OF STANDARD CHARACTERS WITHOUT CLAIM TO ANY PARTICULAR FONT, STYLE, SIZE, OR COLOR.

FOR ENTERTAINMENT SERVICES, NAMELY, PROVIDING INTERACTIVE MULTIPLAYER GAME SERVICES FOR GAMES PLAYED OVER COMPUTER NETWORKS AND GLOBAL COMMUNICATIONS NETWORKS; PROVIDING COMPUTER GAMES AND VIDEO GAMES THAT CAN BE ACCESSED, PLAYED AND DOWNLOADED OVER COMPUTER NETWORKS AND GLOBAL COMMUNICATIONS NETWORKS; PROVIDING INFORMATION ON THE VIDEO GAME AND COMPUTER GAME INDUSTRIES AND INFORMATION ON VIDEO GAMES, COMPUTER GAMES AND RELATED PRODUCTS; ARRANGING AND CONDUCTING COMPETITIONS FOR VIDEO GAME PLAYERS AND COMPUTER GAME PLAYERS; AND PUBLICATION OF ELECTRONIC MAGAZINES (U.S. CLS. 100, 101 AND 107).

DAVID ELTON, EXAMINING ATTORNEY

SN 78-879,095. SCHOLASTIC INC., NEW YORK, NY. FILED 5-8-2006.

BUGABLES

THE MARK CONSISTS OF STANDARD CHARACTERS WITHOUT CLAIM TO ANY PARTICULAR FONT, STYLE, SIZE, OR COLOR.

FOR ENTERTAINMENT, NAMELY PRODUCTION OF AN ONGOING TELEVISION SERIES FOR CHILDREN (U.S. CLS. 100, 101 AND 107).

FIRST USE 3-27-2006; IN COMMERCE 3-27-2006.
ANDREA EVANS, EXAMINING ATTORNEY

SN 78-881,693. VIACOM INTERNATIONAL INC., NEW YORK, NY. FILED 5-11-2006.

WIFEY

THE MARK CONSISTS OF STANDARD CHARACTERS WITHOUT CLAIM TO ANY PARTICULAR FONT, STYLE, SIZE, OR COLOR.

FOR ENTERTAINMENT SERVICES IN THE NATURE OF TELEVISION SERIES, FEATURING LIVE ACTION, COMEDY AND DRAMA; PROVIDING ONLINE INFORMATION IN THE FIELD OF ENTERTAINMENT CONCERNING TELEVISION PROGRAMS (U.S. CLS. 100, 101 AND 107).

SUSAN RICHARDS, EXAMINING ATTORNEY

CLASS 41—(Continued).

SN 78-882,826. UNIVERSAL CITY STUDIOS LLLP, UNIVERSAL CITY, CA. FILED 5-12-2006.

ANIMAL ACTORS ON LOCATION

THE MARK CONSISTS OF STANDARD CHARACTERS WITHOUT CLAIM TO ANY PARTICULAR FONT, STYLE, SIZE, OR COLOR.

OWNER OF U.S. REG. NO. 1,661,152.

NO CLAIM IS MADE TO THE EXCLUSIVE RIGHT TO USE "ANIMAL ACTORS", APART FROM THE MARK AS SHOWN.

FOR ENTERTAINMENT SERVICES IN THE NATURE OF AN AMUSEMENT PARK ATTRACTION (U.S. CLS. 100, 101 AND 107).

DEIRDRE ROBERTSON, EXAMINING ATTORNEY

SN 78-883,938. COPYRIGHT CLEARANCE CENTER, INC., DANVERS, MA. FILED 5-15-2006.

BEYOND THE BOOK

THE MARK CONSISTS OF STANDARD CHARACTERS WITHOUT CLAIM TO ANY PARTICULAR FONT, STYLE, SIZE, OR COLOR.

FOR EDUCATIONAL SERVICES, NAMELY, CONDUCTING CONFERENCES, SEMINARS AND WORKSHOPS IN THE FIELD OF WRITING AND PUBLISHING (U.S. CLS. 100, 101 AND 107).

FIRST USE 4-5-2002; IN COMMERCE 4-5-2002.

H. M. FISHER, EXAMINING ATTORNEY

SN 78-884,811. VIACOM INTERNATIONAL INC., NEW YORK, NY. FILED 5-16-2006.

MEET OR DELETE

THE MARK CONSISTS OF STANDARD CHARACTERS WITHOUT CLAIM TO ANY PARTICULAR FONT, STYLE, SIZE, OR COLOR.

FOR ENTERTAINMENT SERVICES IN THE NATURE OF TELEVISION SERIES, FEATURING LIVE ACTION, COMEDY AND DRAMA; PROVIDING ONLINE INFORMATION IN THE FIELD OF ENTERTAINMENT CONCERNING TELEVISION PROGRAMS (U.S. CLS. 100, 101 AND 107).

FIRST USE 5-10-2006; IN COMMERCE 5-10-2006.

SUSAN RICHARDS, EXAMINING ATTORNEY

CLASS 41—(Continued).

SN 78-885,363. EXPERT TRADING, LIMITED, COLUMBIA, MD. FILED 5-17-2006.

Face To Face

THE MARK CONSISTS OF STANDARD CHARACTERS WITHOUT CLAIM TO ANY PARTICULAR FONT, STYLE, SIZE, OR COLOR.

FOR PUBLICATION OF BOOKS; PUBLICATION OF TEXTS, BOOKS, MAGAZINES AND OTHER PRINTED MATTER; PUBLISHING OF ELECTRONIC PUBLICATIONS (U.S. CLS. 100, 101 AND 107).

ALLISON HOLTZ, EXAMINING ATTORNEY

SN 78-890,530. VIVA VISION, INC., SAN DIEGO, CA. FILED 5-23-2006.

THE MOBILE WORD

THE MARK CONSISTS OF STANDARD CHARACTERS WITHOUT CLAIM TO ANY PARTICULAR FONT, STYLE, SIZE, OR COLOR.

FOR PROVIDING INFORMATION IN THE FIELD OF RELIGION INSTRUCTION VIA THE INTERNET AND WIRELESS DEVICES (U.S. CLS. 100, 101 AND 107).

FIRST USE 5-25-2006; IN COMMERCE 5-25-2006.

JOHN LINCOSKI, EXAMINING ATTORNEY

SN 78-897,522. CMP MEDIA LLC, MANHASSET, NY. FILED 5-31-2006.

BUSINESS COMMUNICATIONS
REVIEW

THE MARK CONSISTS OF STANDARD CHARACTERS WITHOUT CLAIM TO ANY PARTICULAR FONT, STYLE, SIZE, OR COLOR.

OWNER OF U.S. REG. NO. 1,256,839.

SEC. 2(F).

FOR PROVIDING INFORMATION ONLINE RELATING TO EDUCATIONAL EXHIBITIONS AND CONFERENCES IN THE FIELDS OF PROFESSIONAL NETWORKING, TELECOMMUNICATIONS, INFORMATION TECHNOLOGY, TECHNICAL BUSINESS MANAGEMENT SERVICES; ARRANGING AND CONDUCTING EDUCATIONAL EXHIBITIONS AND CONFERENCES IN THE FIELDS OF PROFESSIONAL NETWORKING, TELECOMMUNICATIONS, INFORMATION TECHNOLOGY, TECHNICAL BUSINESS MANAGEMENT SERVICES (U.S. CLS. 100, 101 AND 107).

FIRST USE 10-18-1996; IN COMMERCE 10-18-1996.

ALEXANDER L. POWERS, EXAMINING ATTORNEY

CLASS 41—(Continued).

SN 78-898,834. O2 HOLDINGS, LLC, NEW YORK, NY. FILED 6-2-2006.

TAKING FASHION INTO YOUR
OWN HANDS

THE MARK CONSISTS OF STANDARD CHARACTERS WITHOUT CLAIM TO ANY PARTICULAR FONT, STYLE, SIZE, OR COLOR.

FOR PRODUCTION OF TELEVISION PROGRAMS ON STYLE-RELATED INFORMATION FOR WOMEN; EDUCATIONAL AND ENTERTAINMENT SERVICES, NAMELY ONGOING TELEVISION PROGRAMS FEATURING STYLE-RELATED INFORMATION FOR WOMEN PROVIDED BY MEANS OF BROADCAST, CABLE AND SATELLITE TELEVISION, THE INTERNET, VIDEO-ON-DEMAND AND ONLINE AND OTHER DIGITAL TRANSMISSIONS (U.S. CLS. 100, 101 AND 107).

AMY MCMENAMIN, EXAMINING ATTORNEY

SN 78-903,584. ROCHE DIAGNOSTICS GMBH, D-68305 MANNHEIM, FED REP GERMANY, FILED 6-8-2006.

LIVE LIFE. THE WAY YOU
WANT.

THE MARK CONSISTS OF STANDARD CHARACTERS WITHOUT CLAIM TO ANY PARTICULAR FONT, STYLE, SIZE, OR COLOR.

OWNER OF U.S. REG. NOS. 2,803,675, 3,125,806 AND 3,125,807.

FOR EDUCATION AND TEACHING, NAMELY, PROVIDING CLASSES, WORKSHOPS AND SEMINARS IN THE FIELD OF DIABETES MANAGEMENT; PUBLICATION OF PRINTED PRODUCTS, NAMELY BOOKS, BROCHURES, LEAFLETS, AND JOURNALS RELATED TO THE FIELD OF DIABETES FOR PROFESSIONALS AND PATIENTS (U.S. CLS. 100, 101 AND 107).

TINA BROWN, EXAMINING ATTORNEY

SN 78-905,665. VMDIRECT, LLC, LAS VEGAS, NV. FILED 6-12-2006.

GOLDEN CAM

THE MARK CONSISTS OF STANDARD CHARACTERS WITHOUT CLAIM TO ANY PARTICULAR FONT, STYLE, SIZE, OR COLOR.

FOR PROVIDING RECOGNITION AND INCENTIVES BY THE WAY OF AWARDS TO DEMONSTRATE EXCELLENCE IN THE FIELD OF VIDEO PRODUCTION AND RELATED CATEGORIES (U.S. CLS. 100, 101 AND 107).

JACQUELINE A. LAVINE, EXAMINING ATTORNEY

CLASS 41—(Continued).

SN 78-913,143. YOU'RE FIRED, LLC, BEDFORD, NH. FILED 6-21-2006.

GET FIRED

THE MARK CONSISTS OF STANDARD CHARACTERS WITHOUT CLAIM TO ANY PARTICULAR FONT, STYLE, SIZE, OR COLOR.

FOR PROVIDING STUDIO FACILITIES FOR PAINT YOUR OWN POTTERY AND CREATE YOUR OWN MOSAICS; PROVIDING DO-IT-YOURSELF CERAMIC STUDIO FACILITIES WITH PRECAST CERAMIC POTTERY THAT IS PAINTED ON-SITE BY CUSTOMERS AND THEN GLAZED AND/OR KILN-FIRED; AND PROVIDING DO-IT-YOURSELF STUDIO FACILITIES WITH MOSAIC TILES THAT ARE PIECED TOGETHER TO CREATE MOSAICS ON-SITE BY CUSTOMERS (U.S. CLS. 100, 101 AND 107).

KATHERINE STOIDES, EXAMINING ATTORNEY

SN 78-917,097. PREFERRED COMMERCE, INC., WEST PALM BEACH, FL. FILED 6-26-2006.

EDGE2EDGE LEARNING

THE MARK CONSISTS OF STANDARD CHARACTERS WITHOUT CLAIM TO ANY PARTICULAR FONT, STYLE, SIZE, OR COLOR.

NO CLAIM IS MADE TO THE EXCLUSIVE RIGHT TO USE "LEARNING", APART FROM THE MARK AS SHOWN.

FOR EDUCATIONAL SERVICES, NAMELY, PROVIDING ONLINE COURSES IN THE FIELD OF HORTICULTURE AND GARDENING (U.S. CLS. 100, 101 AND 107).

FIRST USE 11-30-2005; IN COMMERCE 11-30-2005.
COLLEEN KEARNEY, EXAMINING ATTORNEY

CLASS 41—(Continued).

SN 78-918,094. KUDOS, INC., LOS ANGELES, CA. FILED 6-27-2006.



FOR EDUCATIONAL SERVICES, NAMELY, TRAINING OF COACHES AND AWARDING OF CERTIFICATES IN THE FIELD OF LOVE, RELATIONSHIPS AND INTIMACY (U.S. CLS. 100, 101 AND 107).
FIRST USE 5-6-1996; IN COMMERCE 5-6-1996.
CATHERINE FAINT, EXAMINING ATTORNEY

SN 78-918,243. HOODLOVE LIMITED LIABILITY COMPANY, EAST ORANGE, NJ. FILED 6-27-2006.

HOOD LOVE

THE MARK CONSISTS OF STANDARD CHARACTERS WITHOUT CLAIM TO ANY PARTICULAR FONT, STYLE, SIZE, OR COLOR.

FOR EDUCATIONAL SERVICES NAMELY CONDUCTING PROGRAMS IN THE FIELD OF COMMUNITY OUTREACH, BUSINESS AND NETWORKING; ENTERTAINMENT SERVICES, NAMELY, ARRANGING AND CONDUCTING OF COMPETITIONS FOR TALENT, COMEDY, MUSIC, SINGING, DANCING, SPORTS; ENTERTAINMENT SERVICES, NAMELY, CONDUCTING CONTESTS; ENTERTAINMENT SERVICES, NAMELY, CONDUCTING PARTIES; ENTERTAINMENT SERVICES, NAMELY, PROVIDING A WEB SITE FEATURING MUSICAL PERFORMANCES, MUSICAL VIDEOS, RELATED FILM CLIPS, PHOTOGRAPHS, AND OTHER MULTIMEDIA MATERIALS; ENTERTAINMENT SERVICES, NAMELY, PROVIDING ON-LINE COMPUTER GAMES; ENTERTAINMENT SERVICES, NAMELY, PROVIDING ON-LINE REVIEWS OF MOVIE THEATRES, BARS, NIGHT CLUBS, RESTAURANTS, BASKETBALL COURTS, PLAYGROUNDS, PARKS, MUSIC VENUES, RETAIL SHOPS, CONCERT HALLS, BEAUTY SALONS, BARBER SHOPS, CLOTHING STORES, SHOE STORES, INNER-CITY LANDMARKS, SPORTING EVENTS, ARCADES, TATTOO PARLORS, CAR AND MOTORCYCLE DEALERSHIPS AND REPAIR SHOPS, POOL AND BILLIARD HALLS; ENTERTAINMENT SERVICES, NAMELY, PROVIDING PRERECORDED MUSIC, INFORMATION IN THE FIELD OF MUSIC, AND COMMENTARY AND ARTICLES ABOUT MUSIC, ALL ON-LINE VIA A GLOBAL COMPUTER NETWORK; HEALTH CLUB SERVICES, NAMELY PROVIDING INSTRUCTION AND EQUIPMENT IN THE FIELD OF PHYSICAL EXERCISE; PROVIDING BILLIARD ROOMS; PROVIDING FITNESS AND EXERCISE FACILITIES; PROVIDING INFORMATION IN THE FIELD OF EXERCISE TRAINING (U.S. CLS. 100, 101 AND 107).

BARBARA BROWN, EXAMINING ATTORNEY

CLASS 41—(Continued).

SN 78-922,377. RATTLETRAP PRODUCTIONS, INC., MADISON, TN. FILED 7-5-2006.

STACEY DAVID'S GEARZ

THE MARK CONSISTS OF STANDARD CHARACTERS WITHOUT CLAIM TO ANY PARTICULAR FONT, STYLE, SIZE, OR COLOR.

THE NAME STACEY DAVID IDENTIFIES A LIVING INDIVIDUAL WHOSE CONSENT IS OF RECORD.

FOR ENTERTAINMENT IN THE NATURE OF ONGOING TELEVISION PROGRAMS IN THE FIELD OF AUTOMOTIVE REPAIR, MAINTENANCE AND MODIFICATION (U.S. CLS. 100, 101 AND 107).

MICHELLE DUBOIS, EXAMINING ATTORNEY

SN 78-935,695. VIACOM INTERNATIONAL INC., NEW YORK, NY. FILED 7-24-2006.

VMTV

THE MARK CONSISTS OF STANDARD CHARACTERS WITHOUT CLAIM TO ANY PARTICULAR FONT, STYLE, SIZE, OR COLOR.

FOR ENTERTAINMENT SERVICES IN THE NATURE OF AN ON-LINE INTERACTIVE GAME PROVIDED BY MEANS OF GLOBAL AND LOCAL AREA COMPUTER NETWORKS (U.S. CLS. 100, 101 AND 107).

SUSAN RICHARDS, EXAMINING ATTORNEY

CLASS 42—SCIENTIFIC, COMPUTER AND LEGAL SERVICES

SN 76-607,263. QUANTA BASICS, INC., OMAHA, NE. FILED 8-11-2004.



THE MARK CONSISTS OF THE WORDS AND DESIGN QUANTA BASICS IN STYLIZED FORM. THE WORD QUANTA IS CAPITALIZED AND IN BLOCK LETTER FORM. THE WORD BASICS IS CAPITALIZED, BUT NOT IN BLOCK LETTER FORM AND IS STACKED BELOW THE WORD QUANTA. TO THE LEFT OF THE LETTER Q IN QUANTA AND THE LETTER B IN BASICS IS A LARGE CIRCLE WITH THREE SMALLER CIRCLES OF DISSIMILAR SIZE ON THE OUTER PERIMETER OF THE LARGER CIRCLE.

FOR WEBSITE DEVELOPMENT SERVICES (U.S. CLS. 100 AND 101).

FIRST USE 6-15-2004; IN COMMERCE 6-15-2004.
ANGELA M. MICHELI, EXAMINING ATTORNEY

SN 76-622,621. GLASS, JERRY, LOUISVILLE, KY. FILED 11-30-2004.



NO CLAIM IS MADE TO THE EXCLUSIVE RIGHT TO USE "CHILD SUPPORT SOCIETY OF AMERICA", APART FROM THE MARK AS SHOWN.

FOR CONSULTING SERVICES, NAMELY, SELECTING AND PROCURING LEGAL SERVICES FOR CHILD SUPPORT DEFENDANTS (U.S. CLS. 100 AND 101).

CHRISTOPHER BUONGIORNO, EXAMINING ATTORNEY

CLASS 42—(Continued).

SN 76-627,633. THE AMERICAN WATERWAYS OPERATORS, INC., ARLINGTON, VA. FILED 1-12-2005.

RESPONSIBLE CARRIER PROGRAM

THE MARK CONSISTS OF STANDARD CHARACTERS WITHOUT CLAIM TO ANY PARTICULAR FONT, STYLE, SIZE, OR COLOR.

FOR ADMINISTRATION OF A QUALITY ASSURANCE SERVICES PROGRAM IN THE FIELD OF MARINE VEHICLE QUALITY AND SAFETY TO ENSURE SAFE OPERATION OF TUGBOATS, TOWBOATS AND BARGES AND PROTECTION OF THE ENVIRONMENTS IN WHICH THEY OPERATE (U.S. CLS. 100 AND 101).

FIRST USE 12-7-1994; IN COMMERCE 12-7-1994.
GIANCARLO CASTRO, EXAMINING ATTORNEY

SN 76-647,193. AMERICAN COLLEGE OF CARDIOLOGY FOUNDATION, BETHESDA, MD. FILED 9-21-2005.



NO CLAIM IS MADE TO THE EXCLUSIVE RIGHT TO USE "ICD REGISTRY", APART FROM THE MARK AS SHOWN.

THE MARK CONSISTS OF THE WORDS ICD REGISTRY IN A STYLIZED FORMAT ALONG WITH THE DESIGN OF AN INSTALLED IMPLANTABLE CARDIOVERTER DEFIBRILLATOR.

FOR PROVIDING QUALITY ASSURANCE MEASUREMENT FOR IMPLANTABLE CARDIOVERTER DEFIBRILLATOR SERVICES FOR DOCTORS, HOSPITALS, AND LABS IN THE FIELD OF CARDIOLOGY AND CARDIOVASCULAR MEDICINE AND HEALTH (U.S. CLS. 100 AND 101).

FIRST USE 6-30-2005; IN COMMERCE 6-30-2005.
REBECCA GAN, EXAMINING ATTORNEY

SN 76-647,194. AMERICAN COLLEGE OF CARDIOLOGY FOUNDATION, BETHESDA, MD. FILED 9-21-2005.



NO CLAIM IS MADE TO THE EXCLUSIVE RIGHT TO USE "REGISTRY", APART FROM THE MARK AS SHOWN. THE MARK CONSISTS OF THE WORDS CATHPCI REGISTRY IN A STYLIZED FORMAT ALONG WITH THE DESIGN OF A DEPLOYED CORONARY ARTERY STENT.

FOR PROVIDING QUALITY ASSURANCE MEASUREMENT FOR DIAGNOSTIC CARDIAC CATHETERIZATIONS AND PERCUTANEOUS CORONARY INTERVENTION SERVICES FOR DOCTORS, HOSPITALS, AND LABS IN THE FIELD OF CARDIOLOGY AND CARDIOVASCULAR MEDICINE AND HEALTH (U.S. CLS. 100 AND 101).

FIRST USE 6-30-2005; IN COMMERCE 6-30-2005.
REBECCA GAN, EXAMINING ATTORNEY

CLASS 42—(Continued).

SN 76-652,502. EAGLE VISION COMMUNICATIONS L.L.P., HOUSTON, TX. FILED 12-21-2005.

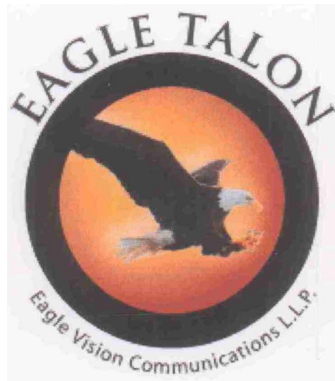

NO CLAIM IS MADE TO THE EXCLUSIVE RIGHT TO USE "COMMUNICATIONS L.L.P.", APART FROM THE MARK AS SHOWN.

THE COLOR(S) BLACK, BROWN, ORANGE, WHITE AND YELLOW IS/ARE CLAIMED AS A FEATURE OF THE MARK.

THE COLOR BLACK APPEARS IN THE WORDING AROUND THE LOGO. AS WELL AS IN THE OUTER CIRCLE OF THE LOGO. THE COLOR BROWN APPEARS IN THE BODY OF THE EAGLE. THE COLOR ORANGE APPEARS IN THE BACKGROUND OF THE LOGO THAT IS INSIDE THE OUTER BLACK RING OF THE LOGO. THE COLOR WHITE APPEARS IN THE EAGLES HEAD AND TAIL. THE COLOR YELLOW APPEARS IN THE EAGLES BEAK AND FEET.

FOR DEVELOPMENT OF COMPUTER SOFTWARE FOR USE IN DEFAULT MORTGAGE SERVICING APPLICATIONS (U.S. CLS. 100 AND 101).

KATHERINE STOIDES, EXAMINING ATTORNEY

SN 76-658,754. FREEDOM PRESS, INC., TOPANGA, CA. FILED 4-17-2006.

HAVE A SAFE TRIP

THE MARK CONSISTS OF STANDARD CHARACTERS WITHOUT CLAIM TO ANY PARTICULAR FONT, STYLE, SIZE, OR COLOR.

FOR EDUCATIONAL SERVICES, NAMELY PROVIDING ENVIRONMENTAL EDUCATIONAL INFORMATION CONTENT BY MEANS OF A GLOBAL COMPUTER NETWORK (U.S. CLS. 100 AND 101).

SARAH WAYDA, EXAMINING ATTORNEY

CLASS 42—(Continued).

SN 78-450,912. IPVENTURE, INC., LOS ALTOS, CA. FILED 7-14-2004.

INTELLECTUALWARE

THE MARK CONSISTS OF STANDARD CHARACTERS WITHOUT CLAIM TO ANY PARTICULAR FONT, STYLE, SIZE, OR COLOR.

FOR INTELLECTUAL PROPERTY CONSULTATION; LICENSING OF INTELLECTUAL PROPERTY; DEVELOPMENT OF NEW TECHNOLOGIES AND NEW PRODUCTS TO ACQUIRE INTELLECTUAL PROPERTY THAT BENEFITS OTHERS (U.S. CLS. 100 AND 101).

FIRST USE 12-19-2002; IN COMMERCE 12-19-2002.
ANGELA M. MICHELI, EXAMINING ATTORNEY

SN 78-484,816. 3SI HOLDINGS, INC., CENTENNIAL, CO. FILED 9-16-2004.



FOR DESIGN, DEVELOPMENT AND IMPLEMENTATION OF INTEGRATED SOFTWARE SOLUTIONS FOR COMMERCIAL AND GOVERNMENT ENTERPRISE APPLICATIONS (U.S. CLS. 100 AND 101).

FIRST USE 1-1-2000; IN COMMERCE 1-1-2000.
CAROLYN GRAY, EXAMINING ATTORNEY

SN 78-531,856. CANDELORE, CRAIG A., SAN DIEGO, CA. FILED 12-13-2004.

**MEN'S LEGAL CENTER
FAMILY LAW
ADVOCATES**

THE MARK CONSISTS OF STANDARD CHARACTERS WITHOUT CLAIM TO ANY PARTICULAR FONT, STYLE, SIZE, OR COLOR.

NO CLAIM IS MADE TO THE EXCLUSIVE RIGHT TO USE "LEGAL CENTER FAMILY LAW ADVOCATES", APART FROM THE MARK AS SHOWN.

FOR LEGAL SERVICES (U.S. CLS. 100 AND 101).
FIRST USE 1-1-1999; IN COMMERCE 1-1-1999.

NAKWAMA ANKRAH, EXAMINING ATTORNEY

CLASS 42—(Continued).

SN 78-580,765. SOCIETY OF MANUFACTURING ENGINEERS, DEARBORN, MI. FILED 3-4-2005.

CLASS 42—(Continued).

SN 78-636,461. EC POWER INTERNATIONAL, INC., HOUSTON, TX. FILED 5-24-2005.

**CERTIFIED
MANUFACTURING
ENGINEER**

ENSOURCE POWER

THE MARK CONSISTS OF STANDARD CHARACTERS WITHOUT CLAIM TO ANY PARTICULAR FONT, STYLE, SIZE, OR COLOR.

NO CLAIM IS MADE TO THE EXCLUSIVE RIGHT TO USE "MANUFACTURING ENGINEER", APART FROM THE MARK AS SHOWN.

SEC. 2(F).
FOR PROVIDING INFORMATION IN THE FIELD OF ENGINEERING (U.S. CLS. 100 AND 101).

FIRST USE 0-0-1972; IN COMMERCE 0-0-1972.
STEVEN PEREZ, EXAMINING ATTORNEY

THE MARK CONSISTS OF STANDARD CHARACTERS WITHOUT CLAIM TO ANY PARTICULAR FONT, STYLE, SIZE, OR COLOR.

NO CLAIM IS MADE TO THE EXCLUSIVE RIGHT TO USE "POWER", APART FROM THE MARK AS SHOWN.

FOR APPLICATION SERVICE PROVIDER (ASP) FEATURING SOFTWARE FOR TRANSACTION MANAGEMENT, PROCESSING, AND ACCOUNTING IN THE FIELD OF ELECTRIC POWER PURCHASING AND CONSUMPTION (U.S. CLS. 100 AND 101).

TASNEEM HUSSAIN, EXAMINING ATTORNEY

SN 78-637,887. ARTISAN CREATIVE, INC., LOS ANGELES, CA. FILED 5-26-2005.

SN 78-631,638. HLK ENTERPRISES, INC., CUMMING, GA. FILED 5-17-2005.



NO CLAIM IS MADE TO THE EXCLUSIVE RIGHT TO USE "AUTO FINDER", APART FROM THE MARK AS SHOWN.

THE COLORS YELLOW, WHITE, AND BLUE ARE CLAIMED AS A FEATURE OF THE MARK.

THE MARK CONSIST OF THE WORD AUTO, THE CAR, AND THE MAGNIFYING GLASS ARE WHITE; FINDER IS YELLOW; ALL ARE ON A BLUE BACKGROUND.

FOR PROVIDING A CUSTOMIZED SEARCH OF NEW VEHICLE QUOTES AS REQUESTED BY CUSTOMERS VIA THE INTERNET (U.S. CLS. 100 AND 101).

FIRST USE 1-30-1999; IN COMMERCE 1-30-1999.
PAUL E. FAHRENKOPF, EXAMINING ATTORNEY



OWNER OF U.S. REG. NO. 2,258,595.
FOR GRAPHIC ART DESIGN AND GRAPHIC ILLUSTRATION SERVICES FOR OTHERS; DESIGN AND DEVELOPMENT OF NETWORK WEB-PAGES FOR OTHERS; DESIGN AND DEVELOPMENT OF MULTIMEDIA APPLICATIONS FOR OTHERS (U.S. CLS. 100 AND 101).

FIRST USE 1-1-2001; IN COMMERCE 1-1-2001.
BARBARA GAYNOR, EXAMINING ATTORNEY

CLASS 42—(Continued).

SN 78-648,725. ROBILLARD, DANIEL, CAMBRIDGE, MA. FILED 6-10-2005.

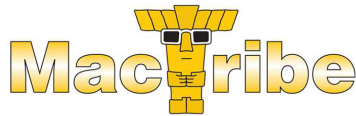

THE COLOR(S) GOLD, BLACK AND WHITE IS/ARE CLAIMED AS A FEATURE OF THE MARK.

THE COLOR(S) GOLD, BLACK AND WHITE ARE CLAIMED AS A FEATURE OF THE MARK. THE WORDING AND THE STYLIZED LETTER T ARE GOLD WITH WHITE SHADING IN THE CENTER OF EACH LETTER. THE FRAME OF THE GLASSES IS WHITE. THE LETTERS AND DESIGN ARE OUTLINED IN BLACK AND THE LENSES OF THE GLASSES ARE BLACK. THE OUTLINE AND FEATURES OF THE CHARACTER COMPRISING THE LETTER T ARE IN BLACK.

FOR PROVIDING ON-LINE INFORMATION AND NEWS IN THE FIELD OF TECHNOLOGY VIA A WEB SITE (U.S. CLS. 100 AND 101).

FIRST USE 9-1-2004; IN COMMERCE 6-1-2005.
SHARON MEIER, EXAMINING ATTORNEY

SN 78-654,922. OHIO AEROSPACE INSTITUTE, BROOK-PARK, OH. FILED 6-21-2005.

OhioView

THE MARK CONSISTS OF STANDARD CHARACTERS WITHOUT CLAIM TO ANY PARTICULAR FONT, STYLE, SIZE, OR COLOR.

NO CLAIM IS MADE TO THE EXCLUSIVE RIGHT TO USE "OHIO", APART FROM THE MARK AS SHOWN.

FOR RESEARCH SERVICES IN THE FIELDS OF AGRICULTURE, GEOLOGY, GEOGRAPHY, CIVIL ENGINEERING, COMPUTER SCIENCE, LIBRARY SCIENCE, ENVIRONMENTAL SCIENCE AND URBAN STUDIES; PREPARATION OF MATERIALS PERTAINING TO SUCH RESEARCH (U.S. CLS. 100 AND 101).

FIRST USE 6-1-1999; IN COMMERCE 6-1-1999.
ESTHER A. BORSUK, EXAMINING ATTORNEY

CLASS 42—(Continued).

SN 78-655,997. TRAXI TECHNOLOGIES, LLC, NEW YORK CITY, NY. FILED 6-22-2005.

Volcrum - leveraging voice technology

THE MARK CONSISTS OF STANDARD CHARACTERS WITHOUT CLAIM TO ANY PARTICULAR FONT, STYLE, SIZE, OR COLOR.

FOR COMPUTER SOFTWARE DESIGN AND MAINTENANCE; TECHNOLOGICAL CONSULTATION IN THE TECHNOLOGIES FIELDS OF TELECOMMUNICATIONS, VOICE OVER INTERNET PROTOCOL (VOIP) COMMUNICATIONS, ENTERPRISE COMMUNICATIONS AND INFORMATION TECHNOLOGY (U.S. CLS. 100 AND 101).

FIRST USE 6-16-2005; IN COMMERCE 6-16-2005.
JOHN DALIER, EXAMINING ATTORNEY

SN 78-663,410. LIVEHELP.COM, LLC, PLANO, TX. FILED 7-5-2005.

LIVEHELP.COM

THE MARK CONSISTS OF STANDARD CHARACTERS WITHOUT CLAIM TO ANY PARTICULAR FONT, STYLE, SIZE, OR COLOR.

FOR ONLINE TECHNICAL SUPPORT SERVICES, NAMELY, SUPPORTING BUSINESS COMMUNITIES IN TROUBLESHOOTING OF COMPUTER HARDWARE AND SOFTWARE PROBLEMS FOR CUSTOMERS (U.S. CLS. 100 AND 101).

FIRST USE 7-6-2005; IN COMMERCE 7-6-2005.
CHRIS WELLS, EXAMINING ATTORNEY

SN 78-667,626. NEOHAPSIS, INC., CHICAGO, IL. FILED 7-11-2005.

QUELLE

THE MARK CONSISTS OF STANDARD CHARACTERS WITHOUT CLAIM TO ANY PARTICULAR FONT, STYLE, SIZE, OR COLOR.

FOR PROVIDING ONLINE INFORMATION IN THE FIELD OF COMPUTER SECURITY, IT SECURITY, AND IT COMPLIANCE ISSUES (U.S. CLS. 100 AND 101).

JOHN E. MICHOS, EXAMINING ATTORNEY

CLASS 42—(Continued).

SN 78-672,267. NEOHAPSIS, INC., CHICAGO, IL. FILED 7-18-2005.

QWELLE

THE MARK CONSISTS OF STANDARD CHARACTERS WITHOUT CLAIM TO ANY PARTICULAR FONT, STYLE, SIZE, OR COLOR.

FOR PROVIDING ONLINE INFORMATION IN THE FIELD OF COMPUTER SECURITY, IT SECURITY, AND IT COMPLIANCE ISSUES (U.S. CLS. 100 AND 101).

JOHN E. MICHOS, EXAMINING ATTORNEY

SN 78-676,214. NETWORKED INFORMATION SYSTEMS, LLC, WOBURN, MA. FILED 7-22-2005.

netinfosystems.net

THE MARK CONSISTS OF STANDARD CHARACTERS WITHOUT CLAIM TO ANY PARTICULAR FONT, STYLE, SIZE, OR COLOR.

FOR COMPUTER NETWORK DESIGN FOR OTHERS (U.S. CLS. 100 AND 101).

DAVID TAYLOR, EXAMINING ATTORNEY

SN 78-676,801. SOLCENT CORPORATION, RESTON, VA. FILED 7-23-2005.



THE APPLICANT CLAIMS COLOR AS A FEATURE OF THE MARK, NAMELY, BLACK AND YELLOW.

THE MARK CONSISTS OF SOLCENT IS THE WORD. THE O IN SOLCENT IS A SUN. THE SUN IS ROUND WITH 4 TRIANGLES AT THE 12, 3, 6 AND 9 O'CLOCK POSITION EXTERNAL TO THE SUN. THE SUN IS YELLOW IN COLOR WITH THE REMAINING LETTERS -SLCENT - IN BLACK. THE S AND THE C ARE CAPITALIZED THE REMAINING LETTERS- LENT - ARE NOT CAPITALIZED.

FOR TECHNOLOGY CONSULTATION AND RESEARCH IN THE FIELD OF COMPUTER ENGINEERING (U.S. CLS. 100 AND 101).

FIRST USE 1-1-2005; IN COMMERCE 1-1-2005.

ANN E. SAPPENFIELD, EXAMINING ATTORNEY

CLASS 42—(Continued).

SN 78-689,557. IMARKS WEB SOLUTIONS, LLC, LITTLETON, CO. FILED 8-10-2005.



NO CLAIM IS MADE TO THE EXCLUSIVE RIGHT TO USE "WEB SOLUTIONS", APART FROM THE MARK AS SHOWN.

THE MARK CONSISTS OF IMARKS WEB SOLUTIONS LITERAL ELEMENT WITH SWIRL/VORTEX DESIGN ELEMENT.

FOR CREATION AND MAINTENANCE OF WEB SITES FOR OTHERS (U.S. CLS. 100 AND 101).

FIRST USE 6-14-2001; IN COMMERCE 6-14-2001.

ESTHER A. BORSUK, EXAMINING ATTORNEY

SN 78-691,703. XANTHOS SYSTEMS LLC, RANCHO CORDOVA, CA. FILED 8-12-2005.

Xanthos Systems

THE MARK CONSISTS OF STANDARD CHARACTERS WITHOUT CLAIM TO ANY PARTICULAR FONT, STYLE, SIZE, OR COLOR.

NO CLAIM IS MADE TO THE EXCLUSIVE RIGHT TO USE "SYSTEMS", APART FROM THE MARK AS SHOWN.

FOR PROVIDING TEMPORARY USE OF NON-DOWNLOADABLE SOFTWARE FOR USE BY THE INSURANCE INDUSTRY FOR RISK ASSESSMENT, RISK MANAGEMENT AND LOSS PREVENTION (U.S. CLS. 100 AND 101).

FIRST USE 1-1-2005; IN COMMERCE 6-13-2005.

MYRIAH HABEEB, EXAMINING ATTORNEY

CLASS 42—(Continued).

SN 78-693,613. EVERYCLICK LTD, STOW ON THE WOLD, GLOUCESTERSHIRE, UNITED KINGDOM, FILED 8-16-2005.



PRIORITY CLAIMED UNDER SEC. 44(D) ON ERPN CMNTY TM OFC APPLICATION NO. 004295441, FILED 2-17-2005, REG. NO. 004295441, DATED 3-15-2006, EXPIRES 2-17-2015.

FOR COMPUTER SERVICES, NAMELY, PROVIDING SEARCH ENGINES FOR OBTAINING DATA ON A GLOBAL COMPUTER NETWORK; MAINTENANCE AND UPDATING OF A TELECOMMUNICATION NETWORK SEARCH ENGINE FOR OTHERS (U.S. CLS. 100 AND 101).

BARBARA A. LOUGHRAN, EXAMINING ATTORNEY

SN 78-695,564. ME DOT COM, INC., SAN JOSE, CA. FILED 8-18-2005.

snapp

THE MARK CONSISTS OF STANDARD CHARACTERS WITHOUT CLAIM TO ANY PARTICULAR FONT, STYLE, SIZE, OR COLOR.

FOR APPLICATION SERVICE PROVIDER (ASP) FEATURING SOFTWARE IN THE FIELD OF SOCIAL NETWORKING; APPLICATION SERVICE PROVIDER (ASP), NAMELY, HOSTING COMPUTER SOFTWARE APPLICATIONS OF OTHERS FOR CREATING, ORGANIZING, MAINTAINING, HOSTING, DESIGNING AND ACCESSING ON-LINE CHAT ROOMS, ELECTRONIC BULLETIN BOARDS, EMAIL, CALENDARS, ADDRESS BOOKS, WEB SITES AND PAGES, AND TRANSMISSION OF INSTANT MESSAGES, PHOTOGRAPHS, MUSIC, VIDEO AND INFORMATION AMONG USERS IN THE FIELD OF SOCIAL NETWORKING AND PERSONALIZED WEB COMMUNITIES; APPLICATION SERVICE PROVIDER (ASP), NAMELY, HOSTING COMPUTER SOFTWARE APPLICATIONS OF OTHERS FOR CREATING, ORGANIZING, CONDUCTING AND ACCESSING ONLINE MEETINGS, GATHERINGS, AND INTERACTIVE DISCUSSIONS IN THE FIELDS OF SOCIAL NETWORKING AND PERSONALIZED WEB COMMUNITIES. (U.S. CLS. 100 AND 101).

FIRST USE 7-2-2005; IN COMMERCE 7-2-2005.

CATHERINE FAINT, EXAMINING ATTORNEY

CLASS 42—(Continued).

SN 78-701,202. MATRIX TELECOM, INC., OKLAHOMA CITY, OK. FILED 8-26-2005.



FOR NON-DOWNLOADABLE ONLINE ACCOUNT MANAGEMENT COMPUTER TOOL THAT ALLOWS CUSTOMERS TO ACCESS, VIEW, AND MAKE CHANGES TO THEIR TELECOMMUNICATION SERVICES ACCOUNT (U.S. CLS. 100 AND 101).

FIRST USE 8-26-2005; IN COMMERCE 10-1-2005.

IRENE D. WILLIAMS, EXAMINING ATTORNEY

SN 78-701,634. RPATH, INC., CARY, NC. FILED 8-26-2005.

CONARY

THE MARK CONSISTS OF STANDARD CHARACTERS WITHOUT CLAIM TO ANY PARTICULAR FONT, STYLE, SIZE, OR COLOR.

FOR APPLICATION SERVICE PROVIDER FEATURING SOFTWARE TO ENABLE USERS TO COMBINE THEIR OWN SOFTWARE WITH OTHER SOFTWARE COMPONENTS SOURCED FROM MULTIPLE POINTS OF ORIGIN (U.S. CLS. 100 AND 101).

JENNIFER KRISP, EXAMINING ATTORNEY

SN 78-701,898. RAYMOND, JOHN, WOODBURY, CT. FILED 8-27-2005.

PowerIT

THE MARK CONSISTS OF STANDARD CHARACTERS WITHOUT CLAIM TO ANY PARTICULAR FONT, STYLE, SIZE, OR COLOR.

FOR PROVIDING ONLINE NON-DOWNLOADABLE SOFTWARE FOR MANAGING WEB-BASED COMMUNICATIONS AND INFORMATION SYSTEMS, NAMELY WEBSITE CONTENT MANAGEMENT, EMAIL, NEWSLETTERS, CALENDARS, SURVEYS, INTRANETS, ON-LINE LEARNING TOOLS, GRADE BOOKS, AND PROVIDING SERVICES IN SUPPORT OF THE USE OF THIS SOFTWARE, NAMELY, WEBSITE DESIGN, WEB HOSTING, AND TECHNICAL SUPPORT SERVICES, NAMELY, TROUBLESHOOTING OF COMPUTER HARDWARE AND SOFTWARE PROBLEMS (U.S. CLS. 100 AND 101).

FIRST USE 8-25-2005; IN COMMERCE 8-25-2005.

TIMOTHY FINNEGAN, EXAMINING ATTORNEY

CLASS 42—(Continued).

SN 78-718,938. GLOBAL SUSTAINMENT AND COMPONENT SOLUTIONS, INC., FARMERS BRANCH, TX. FILED 9-22-2005.



THE APPLICANT CLAIMS COLOR AS A FEATURE OF THE MARK, NAMELY, BLUE AND BLACK.

THE MARK CONSISTS OF BLUE FOR THE LETTERS "SYSTAI" AND BLACK FOR THE LETTERS "NET" (OMITTING THE QUOTATIONS).

FOR PROVIDING TEMPORARY USE OF NON-DOWNLOADABLE COMPUTER SOFTWARE FOR USE IN DATABASE MANAGEMENT FOR BUSINESS EVALUATION, NAMELY MONITORING OF ACTIVE AND PASSIVE ELECTRONIC, SOLENOID, AND ELECTROMECHANICAL CONNECTORS AND FASTENERS (U.S. CLS. 100 AND 101).

FIRST USE 8-11-2004; IN COMMERCE 8-24-2004.
WENDY JUN, EXAMINING ATTORNEY

CLASS 42—(Continued).

SN 78-731,411. PIXELJOCKEY LLC, NEW YORK, NY. FILED 10-12-2005.

better is better

THE MARK CONSISTS OF STANDARD CHARACTERS WITHOUT CLAIM TO ANY PARTICULAR FONT, STYLE, SIZE, OR COLOR.

FOR GRAPHIC DESIGN SERVICES (U.S. CLS. 100 AND 101).

THEODORE MCBRIDE, EXAMINING ATTORNEY

SN 78-733,415. PIXELJOCKEY LLC, NEW YORK, NY. FILED 10-14-2005.

what can we do better for you?

THE MARK CONSISTS OF STANDARD CHARACTERS WITHOUT CLAIM TO ANY PARTICULAR FONT, STYLE, SIZE, OR COLOR.

FOR GRAPHIC DESIGN SERVICES (U.S. CLS. 100 AND 101).

JESSICA A. POWERS, EXAMINING ATTORNEY

SN 78-739,491. XENOWIZE, LLC, CHICAGO, IL. FILED 10-24-2005.



THE COLOR(S) BLACK, DARK BLUE, BLUE AND LIGHT BLUE IS/ARE CLAIMED AS A FEATURE OF THE MARK.

THE MARK CONSISTS OF THE LETTERING OF "AUTOMOTIVE-CONNECTION" IS IN BLACK WITH A SINGLE SPACE BETWEEN EACH LETTER INCLUDING THE "." AND INCLUDES A STYLIZED LETTER "X" WITH UPPER LEGS OF A LONGER LENGTH THAN ITS LOWER LEGS THAT IMMEDIATELY FOLLOWS "AUTOMOTIVE-CONNECTION"; THE COLORS OF THE STYLIZED "X" FROM LEFT TO RIGHT ARE BLACK AT THE UPPER LEFT TIP, BLENDING INTO DARK BLUE, WITH THE LOWER LEFT TIP BEGINNING AT DARK BLUE, THEN BOTH TIPS FADING TO BLUE ALONG THE MIDDLE OF THE X AND THE UPPER AND LOWER RIGHT TIPS, THEN FADING TO LIGHT BLUE ON THE LOWER RIGHT TIP.

FOR PROVIDING TEMPORARY USE OF ONLINE, NON-DOWNLOADABLE SOFTWARE THAT ALLOWS CUSTOMERS TO PERFORM PAYROLL, ACCOUNTING, WORKLOAD, SCHEDULING AND OTHER SERVICES RELATED TO MANAGING A COMPANY (U.S. CLS. 100 AND 101).

KIMBERLY FRYE, EXAMINING ATTORNEY

SN 78-719,991. UNIVERSITY OF WEST FLORIDA, PENSACOLA, FL. FILED 9-24-2005.

THE LESSON ARCHITECT

THE MARK CONSISTS OF STANDARD CHARACTERS WITHOUT CLAIM TO ANY PARTICULAR FONT, STYLE, SIZE, OR COLOR.

NO CLAIM IS MADE TO THE EXCLUSIVE RIGHT TO USE "LESSON", APART FROM THE MARK AS SHOWN.

FOR PROVIDING TEMPORARY USE OF ON-LINE NON-DOWNLOADABLE SOFTWARE FOR USE IN PLANNING LESSONS BY TEACHERS AND EDUCATORS (U.S. CLS. 100 AND 101).

FIRST USE 9-1-1997; IN COMMERCE 9-1-1997.
ERNEST SHOSHO, EXAMINING ATTORNEY

SN 78-729,608. KUNG, PANG-JEN, CRAIG, CARY, NC. FILED 10-10-2005.

OPTOTRACK
Enabling the Future

THE MARK CONSISTS OF STANDARD CHARACTERS WITHOUT CLAIM TO ANY PARTICULAR FONT, STYLE, SIZE, OR COLOR.

FOR TECHNOLOGY CONSULTATION AND RESEARCH IN THE FIELD OF MICROFABRICATION AND NANOTECHNOLOGY (U.S. CLS. 100 AND 101).

FIRST USE 11-18-2002; IN COMMERCE 11-18-2002.
JUSTINE D. PARKER, EXAMINING ATTORNEY

CLASS 42—(Continued).

SN 78-742,395. ADWRITER, INC., SANDUSKY, OH. FILED 10-28-2005.



THE MARK IS NOT IN COLOR.
 FOR PROVIDING TEMPORARY USE OF ON-LINE NON-DOWNLOADABLE SOFTWARE FOR WRITING AND PUBLISHING ADVERTISEMENTS FOR PRINT PUBLICATIONS AND FOR INTERNET ADVERTISEMENTS; AND PROVIDING TEMPORARY USE OF ON-LINE NON-DOWNLOADABLE SOFTWARE FOR ACCOUNTING, MANAGEMENT, EXPENSE REPORTING AND TRACKING, ALL RELATED TO PLACING ADVERTISEMENTS IN PUBLICATIONS (U.S. CLS. 100 AND 101).

FIRST USE 10-0-2005; IN COMMERCE 10-0-2005.
 LAURA KOVALSKY, EXAMINING ATTORNEY

SN 78-770,717. COLVIN, TAURUS M., ANN ARBOR, MI. FILED 12-10-2005.

nextk12

THE MARK CONSISTS OF STANDARD CHARACTERS WITHOUT CLAIM TO ANY PARTICULAR FONT, STYLE, SIZE, OR COLOR.

FOR PROVIDING ONLINE NON-DOWNLOADABLE SOFTWARE FOR USE IN ALLOWING STUDENTS, PARENTS, TEACHERS, AND SCHOOL PERSONNEL TO ACCESS SCHOOL AND STUDENT-RELATED INFORMATION AND DATA IN REAL TIME. (U.S. CLS. 100 AND 101).

HOWARD SMIGA, EXAMINING ATTORNEY

SN 78-775,619. COHEN, YEHONATHAN, WASHINGTON, DC. AND RIDDELL, ALLEN, DURHAM, NC. FILED 12-17-2005.

BEBLOX

THE MARK CONSISTS OF STANDARD CHARACTERS WITHOUT CLAIM TO ANY PARTICULAR FONT, STYLE, SIZE, OR COLOR.

FOR INTERACTIVE HOSTING OF DIGITAL CONTENT ON THE INTERNET (U.S. CLS. 100 AND 101).

FIRST USE 11-15-2005; IN COMMERCE 11-30-2005.
 TONI HICKEY, EXAMINING ATTORNEY

CLASS 42—(Continued).

SN 78-782,178. PARTNERS INTERNATIONAL FOUNDATION, NEWTOWN, CT. AND MORRIS, ROBERT C. JR., YORKTOWN, VA. FILED 12-29-2005.



NO CLAIM IS MADE TO THE EXCLUSIVE RIGHT TO USE "CENTER", APART FROM THE MARK AS SHOWN.

"THE COLOR(S) BLUE AND BLACK ARE CLAIMED AS A FEATURE OF THE MARK IS/ARE CLAIMED AS A FEATURE OF THE MARK."

THE MARK CONSISTS OF A STYLIZED MODERN IDEOGRAM FOR A MEETING PLACE CONSISTING OF FOUR BLACK ARROWS POINTING TO A CENTER POINT THAT IS A STYLIZED BLACK CIRCLE WITH A BLUE POINT AT ITS CENTER. THE WORDS "CENTER FOR APPLIED INNOVATION" ARE ARRANGED VERTICALLY TO THE RIGHT. THE LETTERS "C" AND "A" ARE BLUE. THE WORDS "MAKE ALL THINGS CLEAR" ARE IN THE COLOR BLUE AND APPEAR IN SCRIPT BELOW THE STYLIZED MODERN IDEOGRAM OF FOUR BLACK ARROWS POINTING TO THE STYLIZED BLACK CIRCLE WITH A BLUE POINT AT ITS CENTER

FOR ACCREDITATION SERVICES, NAMELY, DEVELOPING, EVALUATING, AND TESTING STANDARDS FOR INTERNATIONAL RELIEF ORGANIZATIONS, STANDARDS WITHIN THE HUMANITARIAN COMMUNITY, ADAPTIVE PLANNING AND EXECUTION, AIR PLATFORMS, CHEMICAL AND BIOLOGICAL DEFENSE, COGNITIVE AND NEURAL SCIENCES, COMMAND, CONTROL, COORDINATION, COMPLEX EMERGENCIES, CONCEPT DEVELOPMENT, CONTRACTING, COST-BENEFIT ANALYSIS, DISASTER PLANNING, DISASTER PREPAREDNESS, DISASTER RELIEF, EDUCATION, EMERGENCY MANAGEMENT PLANNING, TRAINING AND RESPONSE, EXPERIMENTATION, FACILITIES, FISCAL PLANNING, FORCE PROTECTION, FUNCTIONAL SOLUTION ANALYSIS, HUMAN RESOURCES, HUMAN SYSTEMS, HUMANITARIAN PROGRAMS, INFORMATION AWARENESS, INFORMATION DOMINANCE INFORMATION OPERATIONS, INFORMATION SYSTEMS TECHNOLOGY, LOGISTICS, MODELING AND SIMULATION, PROCUREMENT, QUALITY ASSURANCE, QUALITY SURVEILLANCE, RISK ASSESSMENT AND MITIGATION, SENSORS AND ELECTRONICS, SITUATIONAL AWARENESS, SPACE PLATFORMS, STRATEGIC PLANNING, SYSTEMS INTEGRATION, VULNERABILITY ANALYSIS FOR THE PURPOSE OF ACCREDITATION; ADVISORY SERVICES IN THE FIELD OF PRODUCT DEVELOPMENT AND QUALITY IMPROVEMENT OF SOFTWARE; AGRICULTURAL RESEARCH; AIRCRAFT DESIGN; ANIMATION AND SPECIAL-EFFECTS DESIGN FOR OTHERS; APPLICATION SERVICE PROVIDER (ASP) FEATURING SOFTWARE IN THE FIELD OF EDUCATION, ADAPTIVE PLANNING AND EXECUTION, ATMOSPHERE AND SPACE SCIENCES, BATTLEFIELD ENVIRONMENTS, BATTLESPACE AWARENESS, BIO ENGINEERING SCIENCES, BIOLOGICAL SCIENCES, CHEMICAL AND BIOLOGICAL DEFENSE, COGNITIVE AND NEURAL SCIENCES, COMMAND, CONTROL, COORDINATION, COMPLEX EMERGENCIES, CONCEPT DEVELOPMENT, CONTRACTING, COST-BENEFIT ANALYSIS, DISASTER PLANNING, DISASTER PREPAREDNESS, DISASTER RELIEF, EDUCATION, EMERGENCY MANAGEMENT PLANNING, TRAINING AND RESPONSE, EXPERIMENTAL TECHNOLOGY DEMONSTRATIONS AND OTHER VENUES, EXPERIMENTATION, FISCAL PLANNING, FORCE PROTECTION, FUNCTIONAL SOLUTION ANALYSIS, HUMAN RESOURCES, HUMAN SYSTEMS, HUMANITARIAN PROGRAMS, INFORMATION AWARENESS, INFORMATION DOMINANCE, INFORMATION OPERATIONS, INFORMATION SYSTEMS TECHNOLOGY, INNOVATION, LOGISTICS, MARKETING, TO INCLUDE

CLASS 42—(Continued).

INTEGRATED MARKETING STRATEGIES, STRATEGIC MARKETING, MEDIA BUYS, EVENTS, SPONSORSHIP, MATHEMATICS AND COMPUTER SCIENCES, MODELING AND SIMULATION, NANO SCIENCES, NON-GOVERNMENT ORGANIZATIONS, PERCEPTION MANAGEMENT, PHYSICS, PROCUREMENT, QUALITY ASSURANCE PLANNING, QUALITY SURVEILLANCE, RISK ASSESSMENT AND MITIGATION, SECURITY, SENSORS AND ELECTRONICS, SITUATIONAL AWARENESS, SPACE TECHNOLOGY, STORYTELLING, STRATEGIC PLANNING, SURVEY SERVICES, SYSTEMS INTEGRATION, TECHNOLOGY INSERTION, TERRESTRIAL AND OCEAN SCIENCES, TRAINING, TRANSPORTATION, VISUALIZATION, VULNERABILITY ANALYSIS; APPLICATION SERVICE PROVIDER (ASP), NAMELY, HOSTING COMPUTER SOFTWARE APPLICATIONS OF OTHERS; ARCHITECTURAL DESIGN; ATTORNEY SERVICES; CHARITABLE SERVICES, NAMELY, PROVIDING COMPUTER EQUIPMENT TO SCHOOLS; CHARITABLE SERVICES, NAMELY, PROVIDING WEB SITE DESIGN FOR OTHERS; CIVIL ENGINEERING FOR THE DESIGN OF CITY PLANNING, SANITATION, WASTE TREATMENT, WASTE MANAGEMENT, ROAD CONSTRUCTION, GENERAL CONSTRUCTION, BUILDING, REVITALIZATION, RENOVATION, RESTORATION, GENERAL ENGINEERING, DESIGN, ENGINEERING, CONSTRUCTION, DESIGN/BUILD, FINANCE/DESIGN/BUILD, PERMITTING, PROJECT FINANCE, PROJECT SOURCING, DEVELOPMENT, PROJECT FINANCE, RISK MANAGEMENT, SOURCING DESIGN, CONSTRUCTION, CONSTRUCTION MANAGEMENT, TURN KEY SOLUTIONS; COMMERCIAL ART DESIGN; COMPUTER AIDED DESIGN FOR OTHERS; COMPUTER CONSULTATION; COMPUTER CONSULTATION IN THE FIELD OF COMPUTER SECURITY; COMPUTER DIAGNOSTIC SERVICES; COMPUTER GRAPHICS SERVICES; COMPUTER HARDWARE DEVELOPMENT; COMPUTER NETWORK DESIGN FOR OTHERS; COMPUTER PROJECT MANAGEMENT SERVICES; COMPUTER SECURITY SERVICE, NAMELY, RESTRICTING ACCESS TO AND BY COMPUTER NETWORKS TO AND OF UNDESIRE WEB SITES, MEDIA AND INDIVIDUALS AND FACILITIES; COMPUTER SERVICE, NAMELY, ACTING AS AN APPLICATION SERVICE PROVIDER IN THE FIELD OF KNOWLEDGE MANAGEMENT TO HOST COMPUTER APPLICATION SOFTWARE FOR CREATING SEARCHABLE DATABASES OF INFORMATION AND DATA; COMPUTER SERVICE, NAMELY, ACTING AS AN APPLICATION SERVICE PROVIDER IN THE FIELD OF KNOWLEDGE MANAGEMENT TO HOST COMPUTER APPLICATION SOFTWARE FOR SEARCHING AND RETRIEVING INFORMATION FROM DATABASES AND COMPUTER NETWORKS; COMPUTER SERVICE, NAMELY, ACTING AS AN APPLICATION SERVICE PROVIDER IN THE FIELD OF KNOWLEDGE MANAGEMENT TO HOST COMPUTER APPLICATION SOFTWARE FOR THE COLLECTION, EDITING, ORGANIZING, MODIFYING, BOOK MARKING, TRANSMISSION, STORAGE AND SHARING OF DATA AND INFORMATION; COMPUTER SERVICES, NAMELY CREATING INDEXES OF INFORMATION, SITES AND OTHER RESOURCES AVAILABLE ON COMPUTER NETWORKS; COMPUTER SERVICES, NAMELY MONITORING AND REPORTING ON THE PERFORMANCE, AVAILABILITY, AND ERRORS OF WEBSITES OF OTHERS; COMPUTER SERVICES, NAMELY MONITORING, TESTING, ANALYZING, AND REPORTING ON THE INTERNET TRAFFIC CONTROL AND CONTENT CONTROL OF THE WEBSITES OF OTHERS; COMPUTER SERVICES, NAMELY, CREATING AND MAINTAINING WEB SITES FOR OTHERS; COMPUTER SERVICES, NAMELY, DATA RECOVERY SERVICES; COMPUTER SERVICES, NAMELY, DESIGNING AND IMPLEMENTING NETWORK WEB PAGES FOR OTHERS; COMPUTER SERVICES, NAMELY, DESIGNING AND IMPLEMENTING WEB SITES FOR OTHERS; COMPUTER SERVICES, NAMELY, MANAGING WEB SITES FOR OTHERS; COMPUTER SERVICES, NAMELY, MONITORING THE WEBSITES OF OTHERS TO IMPROVE SCALABILITY AND PERFORMANCE OF WEBSITES OF OTHERS; COMPUTER SERVICES, NAMELY, PROVIDING SEARCH ENGINES FOR OBTAINING DATA ON A GLOBAL COMPUTER NETWORK; COMPUTER SERVICES, NAMELY, REDIRECTING ELECTRONIC MAIL TO CHANGED PERSONAL ELECTRONIC ADDRESS; COMPUTER SERVICES,

CLASS 42—(Continued).

NAMELY, REMOTE AND ON-SITE MANAGEMENT OF ELECTRONIC MESSAGING SYSTEMS AND APPLICATIONS FOR OTHERS; COMPUTER SITE DESIGN; COMPUTER SOFTWARE CONSULTATION; COMPUTER SOFTWARE DESIGN FOR OTHERS; COMPUTER SOFTWARE DESIGN, COMPUTER PROGRAMMING, OR MAINTENANCE OF COMPUTER SOFTWARE; COMPUTER SOFTWARE DEVELOPMENT; COMPUTER SYSTEMS ANALYSIS; COMPUTER TIME-SHARING SERVICES; COMPUTER VIRUS PROTECTION SERVICES; COMPUTER-AIDED ENGINEERING SERVICES FOR OTHERS; CONDUCTING ELECTRONIC DISCOVERY SERVICES VIA GLOBAL COMPUTER NETWORKS FOR LAWYERS AND CORPORATIONS; CONSULTANCY IN THE FIELD OF SOFTWARE DESIGN; CONSULTATION SERVICES IN THE FIELDS OF SELECTION, IMPLEMENTATION AND USE OF COMPUTER HARDWARE AND SOFTWARE SYSTEMS FOR OTHERS; CONSULTING AND LEGAL SERVICES IN THE FIELD OF PRIVACY AND SECURITY LAWS, REGULATIONS, AND REQUIREMENTS; CONSULTING SERVICES IN THE FIELD OF DESIGN, SELECTION, IMPLEMENTATION AND USE OF COMPUTER HARDWARE AND SOFTWARE SYSTEMS FOR OTHERS; CONSULTING SERVICES IN THE FIELD OF OFFICE AND WORKPLACE AUTOMATION; COPYRIGHT MANAGEMENT CONSULTATION; CUSTOM DESIGN AND ENGINEERING OF TELEPHONY SYSTEMS, CABLE TELEVISION SYSTEMS AND FIBER OPTICS; DATA AUTOMATION AND COLLECTION SERVICE USING PROPRIETARY SOFTWARE TO EVALUATE, ANALYZE AND COLLECT SERVICE DATA; DATA ENCRYPTION SERVICES; DATABASE DEVELOPMENT SERVICES; DESIGN AND DEVELOPMENT OF INFORMATION AND DATA BASES; DESIGN AND DEVELOPMENT OF MULTIMEDIA PRODUCTS; DESIGN AND DEVELOPMENT OF NETWORKS; DESIGN AND DEVELOPMENT OF ONLINE COMPUTER SOFTWARE SYSTEMS; DESIGN AND MAINTENANCE OF COMPUTER SITES FOR THIRD PARTIES; DESIGN AND TESTING FOR NEW PRODUCT DEVELOPMENT; DESIGN AND TESTING OF NEW PRODUCTS FOR OTHERS; DESIGN FOR OTHERS IN THE FIELD OF ADAPTIVE PLANNING AND EXECUTION, AIR PLATFORMS, ATMOSPHERE AND SPACE SCIENCES, BATTLEFIELD ENVIRONMENTS, BATTLESPACE AWARENESS, BIOLOGICAL SCIENCES, CHEMICAL AND BIOLOGICAL DEFENSE, COGNITIVE AND NEURAL SCIENCES, COMMAND, CONTROL, COORDINATION, DEFENSE, CONCEPT DEVELOPMENT, DISASTER PLANNING, DISASTER PREPAREDNESS, DISASTER RELIEF, EDUCATION, ELECTRONICS, EMERGENCY MANAGEMENT PLANNING, TRAINING AND RESPONSE, EXPERIMENTAL TECHNOLOGY DEMONSTRATIONS AND OTHER VENUES, EXPERIMENTATION, FACILITIES, FORCE PROTECTION, GROUND AND SEA VEHICLES, HUMAN RESOURCES, HUMAN SYSTEMS, HUMANITARIAN PROGRAMS, INFORMATION AWARENESS, INFORMATION DOMINANCE, INFORMATION OPERATIONS, INFORMATION SYSTEMS TECHNOLOGY, INNOVATION, INTERNATIONAL AGREEMENTS, LOGISTICS, MATHEMATICS AND COMPUTER SCIENCES, MECHANICS, MODELING AND SIMULATION, NANO SCIENCES, NON-GOVERNMENT ORGANIZATIONS, PHYSICS, PROTOTYPING, PUBLIC AND PRIVATE PARTNERSHIPS, PUBLIC RELATIONS TO INCLUDE-STRATEGIC COMMUNICATIONS, CRISIS COMMUNICATIONS, MEDIA EVENTS, MESSAGE DEVELOPMENT, QUALITY ASSURANCE, QUALITY SURVEILLANCE, SENSORS AND ELECTRONICS, SITUATIONAL AWARENESS, SPACE PLATFORMS, SPACE TECHNOLOGY, STORYTELLING, STRATEGIC PLANNING, SURVEY SERVICES, SYSTEMS INTEGRATION, TECHNOLOGY INSERTION, TERRESTRIAL AND OCEAN SCIENCES, TRAINING, TRANSPORTATION, VISUALIZATION; DESIGN OF COMPUTER PROGRAMS AND SOFTWARE RELATING TO AIRCRAFT; DESIGN OF COMPUTERS FOR OTHERS; DESIGN OF FACTORY BUILDINGS; DESIGN OF HOME PAGES, COMPUTER SOFTWARE AND WEB SITES; DESIGN OF HOMEPAGES AND WEB-SITES; DESIGN OF MECHANICAL AND MICROMECHANICAL COMPONENTS; DESIGN OF MECHANICAL, ELECTROMECHANICAL AND OPTOELECTRONIC APPARATUS AND INSTRUMENTS; DESIGN OF PRODUCTION FACILITIES; DESIGN SERVICES IN THE FIELD OF NAVAL SHIPBUILDING; DESIGN, CREATION, HOSTING AND MAINTENANCE

CLASS 42—(Continued).

OF INTERNET SITES FOR THIRD PARTIES; DESIGN, CREATION, HOSTING, MAINTENANCE OF WEBSITES FOR OTHERS; DESIGN, DEVELOPMENT AND IMPLEMENTATION OF SOFTWARE; DESIGNING COMPUTER SOFTWARE FOR CONTROLLING SELF-SERVICE TERMINALS; DESIGNING OF MACHINES, APPARATUS, INSTRUMENTS OR SYSTEMS COMPOSED OF SUCH MACHINES, APPARATUS AND INSTRUMENTS; DESIGNING WEBSITES FOR ADVERTISING PURPOSES; DEVELOPING OF DRIVER AND OPERATING SYSTEM SOFTWARE; DEVELOPING PROGRAMS FOR SIMULATING EXPERIMENTS OR SERIES OF EXPERIMENTS IN A VIRTUAL OPTICAL LABORATORY; DEVELOPMENT OF COMPUTER PROGRAMS RECORDED ON DATA MEDIA (SOFTWARE) DESIGNED FOR USE IN CONSTRUCTION AND AUTOMATED MANUFACTURING (CAD/CAM); DEVELOPMENT OF DATA PROCESSING PROGRAMS BY ORDER OF THIRD PARTIES; DEVELOPMENT OF NEW TECHNOLOGY FOR OTHERS IN THE FIELD OF ADAPTIVE PLANNING AND EXECUTION, AIR PLATFORMS, ATMOSPHERE AND SPACE SCIENCES, BATTLEFIELD ENVIRONMENTS, BATTLESPACE AWARENESS, BIO ENGINEERING SCIENCES, BIOLOGICAL SCIENCES, CHEMICAL AND BIOLOGICAL DEFENSE, COGNITIVE AND NEURAL SCIENCES, COMMAND, CONTROL, COORDINATION, DEFENSE, COMPLEX EMERGENCIES, CAPABILITIES DEVELOPMENT, DISASTER PLANNING, DISASTER PREPAREDNESS, DISASTER RELIEF, EDUCATION, EMERGENCY MANAGEMENT PLANNING, TRAINING AND RESPONSE, EXPERIMENTAL TECHNOLOGY, EXPERIMENTATION, FORCE PROTECTION, FUNCTIONAL SOLUTION ANALYSIS, GROUND AND SEA VEHICLES, HUMAN SYSTEMS, HUMANITARIAN PROGRAMS, INFORMATION AWARENESS, INFORMATION DOMINANCE, INFORMATION OPERATIONS, INFORMATION SYSTEMS, INTERNATIONAL AGREEMENTS, LOGISTICS, MATHEMATICS AND COMPUTER SCIENCES, MECHANICS, MODELING AND SIMULATION, NANO SCIENCES, PERCEPTION MANAGEMENT, PHYSICS, QUALITY SURVEILLANCE, RISK ASSESSMENT AND MITIGATION, SECURITY, SENSORS AND ELECTRONICS, SITUATIONAL AWARENESS, SPACE PLATFORMS, SPACE TECHNOLOGY, STORYTELLING, SYSTEMS INTEGRATION, TERRESTRIAL AND OCEAN SCIENCES, TRAINING, TRANSPORTATION, VISUALIZATION, VULNERABILITY ANALYSIS; DEVELOPMENT OF SOFTWARE FOR SECURE NETWORK OPERATIONS; DEVELOPMENT OF TECHNOLOGIES FOR THE FABRICATION OF CIRCUITS FOR WIRELESS COMMUNICATION, ELECTRONIC DATA PROCESSING, CONSUMER ELECTRONIC, AUTOMOTIVE ELECTRONICS; DEVELOPMENT, DESIGN AND UPDATING OF HOME PAGES; DEVELOPMENT, MAINTENANCE AND UPDATING OF A TELECOMMUNICATION NETWORK SEARCH ENGINE; DEVELOPMENT, UPDATING AND MAINTENANCE OF SOFTWARE AND DATA BASES; DOCUMENT DATA TRANSFER AND PHYSICAL CONVERSION SERVICES FROM ONE MEDIA TO ANOTHER; E-MAIL SYSTEM DESIGN AND IMPLEMENTATION FOR OTHERS; ENGINEERING SERVICES FOR THE CONSTRUCTION OF WATER TREATMENT AND PURIFICATION PLANTS, SOLID WASTE TREATMENT PLANTS AND OTHER MUNICIPAL INFRASTRUCTURE FACILITIES; ENVIRONMENTAL SERVICES, NAMELY, DETECTION OF CONTAMINANTS IN WATER; EXPERT WITNESS SERVICES IN THE FIELD OF ADAPTIVE PLANNING AND EXECUTION, AIR PLATFORMS, ARBITRATION, ATMOSPHERE AND SPACE SCIENCES, BATTLEFIELD ENVIRONMENTS, BATTLESPACE AWARENESS, BIO ENGINEERING SCIENCES, BIOLOGICAL SCIENCES, CHEMICAL AND BIOLOGICAL DEFENSE, COGNITIVE AND NEURAL SCIENCES, COMMAND, CONTROL, COORDINATION, DEFENSE, COMPLEX EMERGENCIES, CONCEPT DEVELOPMENT, CONTRACTING, DISASTER PLANNING, DISASTER PREPAREDNESS, DISASTER RELIEF, EDUCATION, EMERGENCY MANAGEMENT PLANNING, TRAINING AND RESPONSE, EXPERIMENTAL TECHNOLOGY, EXPERIMENTATION, FORCE PROTECTION, FUNCTIONAL SOLUTION ANALYSIS, HUMAN RESOURCES, HUMAN SYSTEMS, HUMANITARIAN PROGRAMS, INFORMATION AWARENESS, INFORMATION DOMINANCE, INFORMATION OPERATIONS, INFORMATION SYSTEMS TECHNOLOGY, INTERNATIONAL AGREEMENTS, LOGISTICS, COMPUTER SCIENCES, MODELING AND

CLASS 42—(Continued).

SIMULATION, NANO SCIENCES, PROCUREMENT, PROTOTYPING, PUBLIC AND PRIVATE PARTNERSHIPS, STRATEGIC COMMUNICATIONS, CRISIS COMMUNICATIONS, QUALITY ASSURANCE, QUALITY SURVEILLANCE, RISK ASSESSMENT AND MITIGATION, SECURITY, SENSORS AND ELECTRONICS, SITUATIONAL AWARENESS, SPACE PLATFORMS, SPACE TECHNOLOGY, SYSTEMS INTEGRATION, TERRESTRIAL AND OCEAN SCIENCES, TRAINING, TRANSPORTATION, VISUALIZATION, VULNERABILITY ANALYSIS; GRAPHIC ART DESIGN; GRAPHIC DESIGN SERVICES; GRAPHIC ILLUSTRATION SERVICES FOR OTHERS; IMAGE PROCESSING SOFTWARE DESIGN; INDUSTRIAL DESIGN; INFORMATION TECHNOLOGY CONSULTATION; INSPECTION SERVICES FOR NEW AND USED VEHICLES FOR PERSONS BUYING OR SELLING THEIR VEHICLES; INTELLECTUAL PROPERTY CONSULTATION; LABOR NEGOTIATION INFORMATION SERVICES; LEGAL RESEARCH; LEGAL SERVICES; LEGAL SERVICES, NAMELY, PROCESS SERVING; LICENSING OF INTELLECTUAL PROPERTY ; LITIGATION CONSULTANCY; LITIGATION SUPPORT SERVICES; MANAGEMENT AND CONSULTATION IN THE FIELD OF HUMAN FACTORS ENGINEERING; MECHANICAL RESEARCH; MEDIATION ; NOTARY PUBLIC SERVICES; ON-LINE BATCH COMPUTER SERVICES; ON-LINE SECURITY SERVICES, NAMELY, PROVIDING SECURITY AND ANONYMITY FOR ELECTRONICALLY TRANSMITTED CREDIT CARD TRANSACTIONS; PACKAGING DESIGN FOR OTHERS; PARALEGAL SERVICES; PATENT AGENCY AND INDUSTRIAL PROPERTY CONSULTATION; PRODUCT DEVELOPMENT; PRODUCT DEVELOPMENT CONSULTATION; PRODUCT DEVELOPMENT FOR OTHERS; PRODUCT RESEARCH; PRODUCT RESEARCH AND DEVELOPMENT; PROFESSIONAL CONSULTING SERVICES AND ADVICE ABOUT AGRICULTURAL CHEMISTRY; PROVIDING INFORMATION RELATING TO LEGAL AFFAIRS; PROVIDING QUALITY ASSURANCE SERVICES IN THE FIELD OF AIR PLATFORMS, COMMAND, CONTROL, COORDINATION, DEFENSE, COMPLEX EMERGENCIES, CONCEPT DEVELOPMENT, CONTRACTING, DISASTER RELIEF, ELECTRONICS, EMERGENCY MANAGEMENT PLANNING, TRAINING AND RESPONSE, EXPERIMENTAL TECHNOLOGY, EXPERIMENTATION, FACILITIES, FISCAL PLANNING, GROUND AND SEA VEHICLES, HUMAN RESOURCES, HUMAN SYSTEMS, HUMANITARIAN PROGRAMS, INFORMATION OPERATIONS, INFORMATION SYSTEMS TECHNOLOGY, INNOVATION, INTERNATIONAL AGREEMENTS, LOGISTICS, MECHANICS, MODELING AND SIMULATION, PROCUREMENT, PROTOTYPING, QUALITY SURVEILLANCE, RISK ASSESSMENT AND MITIGATION, SENSORS AND ELECTRONICS, SPACE PLATFORMS, SYSTEMS INTEGRATION, TECHNOLOGY INSERTION, TRAINING, TRANSPORTATION, VISUALIZATION; PUBLIC DOCUMENT FILING SERVICES; REAL ESTATE RESEARCH SERVICES; RESEARCH AND DEVELOPMENT FOR NEW PRODUCTS FOR OTHERS; RESEARCH IN THE FIELD OF INTELLIGENCE AND SECURITY; RESEARCH IN THE FIELD OF PHYSICS; RESEARCH ON BUILDING CONSTRUCTION OR CITY PLANNING; RESEARCH RELATING TO MECHANICAL ENGINEERING; SCIENTIFIC RESEARCH; SCIENTIFIC RESEARCH AND DEVELOPMENT; SHOP INTERIOR DESIGN; STOCK PHOTOGRAPHY SERVICES, NAMELY, LEASING REPRODUCTION RIGHTS OF PHOTOGRAPHS AND TRANSPARENCIES TO OTHERS; TECHNICAL CONSULTATION IN THE FIELD OF REAL-TIME RECONFIGURABLE WIRELESS COMMUNICATION HANDSETS AND NETWORK EQUIPMENT FOR USE IN WIDEBAND COMMUNICATIONS; TECHNICAL MONITORING SERVICES FOR CONDITIONS OF WATER; TECHNICAL RESEARCH IN THE FIELD OF AERONAUTICS; TECHNICAL SUPPORT SERVICES, NAMELY, TROUBLESHOOTING OF COMPUTER HARDWARE AND SOFTWARE PROBLEMS; TECHNOLOGICAL CONSULTATION IN THE TECHNOLOGY FIELD OF AIR PLATFORMS, BIO ENGINEERING SCIENCES, COMMAND, CONTROL, COORDINATION, DEFENSE, EXPERIMENTATION, FACILITIES, GROUND AND SEA VEHICLES, HUMAN SYSTEMS, INFORMATION AWARENESS, INFORMATION SYSTEMS TECHNOLOGY, LOGISTICS, MATHEMATICS AND COMPUTER SCIENCES, MECHANICS, MODELING AND SIMULATION, NANO

CLASS 42—(Continued).

SCIENCES, PROTOTYPING, CRISIS COMMUNICATIONS, SENSORS AND ELECTRONICS, SPACE PLATFORMS, SPACE TECHNOLOGY, SYSTEMS INTEGRATION, TECHNOLOGY INSERTION, VISUALIZATION; TECHNOLOGY CONSULTATION AND RESEARCH IN THE FIELD OF ADAPTIVE PLANNING AND EXECUTION, AIR PLATFORMS, ATMOSPHERE AND SPACE SCIENCES, BATTLEFIELD ENVIRONMENTS, BATTLESPACE AWARENESS, BIO ENGINEERING SCIENCES, BIOLOGICAL SCIENCES, CHEMICAL AND BIOLOGICAL DEFENSE, COGNITIVE AND NEURAL SCIENCES, COMMAND, CONTROL, COORDINATION, DEFENSE, COMPLEX EMERGENCIES, CONCEPT DEVELOPMENT, DISASTER PLANNING, DISASTER PREPAREDNESS, DISASTER RELIEF, EDUCATION, EMERGENCY MANAGEMENT PLANNING, TRAINING AND RESPONSE, EXPERIMENTATION, FACILITIES, FISCAL PLANNING, FORCE PROTECTION, FUNCTIONAL SOLUTION ANALYSIS, GROUND AND SEA VEHICLES, HUMAN RESOURCES, HUMAN SYSTEMS, HUMANITARIAN PROGRAMS, INFORMATION AWARENESS, INFORMATION DOMINANCE, INFORMATION OPERATIONS, INFORMATION SYSTEMS TECHNOLOGY, INNOVATION, INTERNATIONAL AGREEMENTS, LIAISON SERVICES, LOGISTICS, MATHEMATICS AND COMPUTER SCIENCES, MECHANICS, MODELING AND SIMULATION, NANO SCIENCES, NON-GOVERNMENT PERCEPTION MANAGEMENT, PHYSICS, PROCUREMENT, PROTOTYPING, PRIVATE SECTOR, PUBLIC AND PRIVATE PARTNERSHIPS, PUBLIC RELATIONS, PUBLIC RELATIONS, TO INCLUDE- STRATEGIC COMMUNICATIONS, CRISIS COMMUNICATIONS, MEDIA EVENTS, MESSAGE DEVELOPMENT, SENSORS AND ELECTRONICS, SITUATIONAL AWARENESS, SPACE PLATFORMS, SPACE TECHNOLOGY, STORYTELLING, STRATEGIC PLANNING, SURVEY SERVICES, SYSTEMS INTEGRATION, TECHNOLOGY INSERTION, TERRESTRIAL AND OCEAN SCIENCES, TRAINING, TRANSPORTATION, VISUALIZATION; TECHNOLOGY CONSULTATION IN THE FIELD OF ADAPTIVE PLANNING AND EXECUTION, AIR PLATFORMS, ATMOSPHERE AND SPACE SCIENCES, BATTLEFIELD ENVIRONMENTS, BATTLESPACE AWARENESS, BIO ENGINEERING SCIENCES, BIOLOGICAL SCIENCES, CHEMICAL AND BIOLOGICAL DEFENSE, COGNITIVE AND NEURAL SCIENCES, COMMAND, CONTROL, COORDINATION, DEFENSE, COMPLEX EMERGENCIES, CONCEPT DEVELOPMENT, DISASTER PLANNING, DISASTER PREPAREDNESS, DISASTER RELIEF, EDUCATION, EMERGENCY MANAGEMENT PLANNING, TRAINING AND RESPONSE, EXPERIMENTATION, FACILITIES, FISCAL PLANNING, FORCE PROTECTION, FUNCTIONAL SOLUTION ANALYSIS, GROUND AND SEA VEHICLES, HUMAN RESOURCES, HUMAN SYSTEMS, HUMANITARIAN PROGRAMS, INFORMATION AWARENESS, INFORMATION DOMINANCE, INFORMATION OPERATIONS, INFORMATION SYSTEMS TECHNOLOGY, INNOVATION, INTERNATIONAL AGREEMENTS, LIAISON SERVICES, LOGISTICS, MATHEMATICS AND COMPUTER SCIENCES, MECHANICS, MODELING AND SIMULATION, NANO SCIENCES, NON-GOVERNMENT PERCEPTION MANAGEMENT, PHYSICS, PROCUREMENT, PROTOTYPING, PRIVATE SECTOR, PUBLIC AND PRIVATE PARTNERSHIPS, PUBLIC RELATIONS, PUBLIC RELATIONS, TO INCLUDE- STRATEGIC COMMUNICATIONS, CRISIS COMMUNICATIONS, MEDIA EVENTS, MESSAGE DEVELOPMENT, SENSORS AND ELECTRONICS, SITUATIONAL AWARENESS, SPACE PLATFORMS, SPACE TECHNOLOGY, STORYTELLING, STRATEGIC PLANNING, SURVEY SERVICES, SYSTEMS INTEGRATION, TECHNOLOGY INSERTION, TERRESTRIAL AND OCEAN SCIENCES, TRAINING, TRANSPORTATION, VISUALIZATION; TESTING OR RESEARCH ON CIVIL ENGINEERING; TESTING OR RESEARCH ON MACHINES, APPARATUS AND INSTRUMENTS; TESTING OR RESEARCH ON PREVENTION OF POLLUTION; TESTING, ANALYSIS AND EVALUATION OF THE GOODS AND SERVICES OF OTHERS FOR THE PURPOSE OF CERTIFICATION; UNDERWATER STRUCTURAL INSPECTION SERVICES; WATER QUALITY CONTROL SERVICES (U.S. CLS. 100 AND 101).

FIRST USE 3-2-1997; IN COMMERCE 3-2-1997.

ARETHA SOMERVILLE, EXAMINING ATTORNEY

CLASS 42—(Continued).

SN 78-782,446. THOMAS, CRYSTAL JONES, ANTELOPE, CA. FILED 12-29-2005.

Cranky Girl

THE MARK CONSISTS OF STANDARD CHARACTERS WITHOUT CLAIM TO ANY PARTICULAR FONT, STYLE, SIZE, OR COLOR.

FOR COMMERCIAL ART DESIGN; COMPUTER GRAPHICS SERVICES; DESIGNING WEBSITES FOR ADVERTISING PURPOSES (U.S. CLS. 100 AND 101).

FIRST USE 4-18-2005; IN COMMERCE 5-1-2005.

JERI J. FICKES, EXAMINING ATTORNEY

SN 78-784,069. ACULIX, INC., WOODSTOCK, GA. FILED 1-3-2006.

No Bull BI

THE MARK CONSISTS OF STANDARD CHARACTERS WITHOUT CLAIM TO ANY PARTICULAR FONT, STYLE, SIZE, OR COLOR.

NO CLAIM IS MADE TO THE EXCLUSIVE RIGHT TO USE "BI", APART FROM THE MARK AS SHOWN.

FOR COMPUTER SOFTWARE CONSULTING SERVICES (U.S. CLS. 100 AND 101).

FIRST USE 5-1-2005; IN COMMERCE 10-1-2005.

ANN E. SAPPENFIELD, EXAMINING ATTORNEY

CLASS 42—(Continued).

SN 78-787,583. ROAT CORP., FISHERS, IN. FILED 1-9-2006.

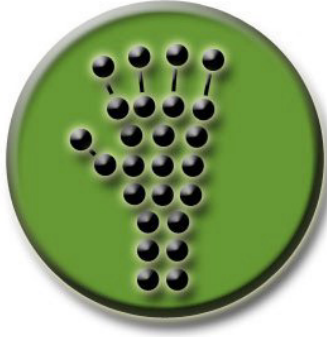

THE COLOR(S) GREEN, GRAY, AND BLACK IS/ARE CLAIMED AS A FEATURE OF THE MARK.

THE MARK CONSISTS OF A GREEN CIRCLE. THE BORDER OF THE CIRCLE IS SHADED FROM BLACK TO GRAY. THE HAND IS COMPRISED OF CIRCLES AND LINES THAT ARE MOSTLY BLACK WITH SHADES OF GRAY IN THE UPPER LEFT CORNERS.

FOR COMPUTER SERVICES, NAMELY WEBSITE DESIGN AND DEVELOPMENT FOR OTHERS; REGISTRATION OF DOMAIN NAMES FOR IDENTIFICATION OF USERS ON A GLOBAL COMPUTER NETWORK; HOSTING OF WEBSITES FOR OTHERS; DATABASE DEVELOPMENT SERVICES; AND NEW PRODUCT DEVELOPMENT FOR OTHERS, NAMELY, DEVELOPING TRAINING PROGRAMS FOR OTHERS THAT CAN BE USED IN ONLINE TRAINING OR DISTRIBUTED VIA CD-ROMS (U.S. CLS. 100 AND 101).

FIRST USE 3-1-2005; IN COMMERCE 3-1-2005.
GINA FINK, EXAMINING ATTORNEY

SN 78-789,071. INOVIS USA, INC., ALPHARETTA, GA. FILED 1-11-2006.

INOVIS CATALOGUE

THE MARK CONSISTS OF STANDARD CHARACTERS WITHOUT CLAIM TO ANY PARTICULAR FONT, STYLE, SIZE, OR COLOR.

NO CLAIM IS MADE TO THE EXCLUSIVE RIGHT TO USE "CATALOGUE", APART FROM THE MARK AS SHOWN.

FOR COMPUTER SERVICES, NAMELY, APPLICATION SERVICE PROVIDER FEATURING SOFTWARE FOR THE RETAIL INDUSTRY THAT ENABLES UPLOADING AND SEARCHING OF RETAIL PRODUCT DATA BASED ON OVER 500 PRODUCT ATTRIBUTES, NAMELY, PRICE, STYLE, COLOR AND SIZE (U.S. CLS. 100 AND 101).

FIRST USE 11-15-2004; IN COMMERCE 11-15-2004.
WENDY JUN, EXAMINING ATTORNEY

CLASS 42—(Continued).

SN 78-791,408. SENIZERGUES, PIERRE ANDRE, NEWPORT BEACH, CA. FILED 1-13-2006.

PAS ECOSKATE HOUSE

THE MARK CONSISTS OF STANDARD CHARACTERS WITHOUT CLAIM TO ANY PARTICULAR FONT, STYLE, SIZE, OR COLOR.

NO CLAIM IS MADE TO THE EXCLUSIVE RIGHT TO USE "HOUSE", APART FROM THE MARK AS SHOWN.

FOR ARCHITECTURAL DESIGN; INTERIOR DECORATING; PLANNING OF BUILDINGS AND INFRASTRUCTURE SYSTEMS FOR BUILDINGS (U.S. CLS. 100 AND 101).

DANNEAN HETZEL, EXAMINING ATTORNEY

SN 78-793,859. GREENLEAF GENETICS LLC, OMAHA, NE. FILED 1-18-2006.

GREENLEAF GENETICS

THE MARK CONSISTS OF STANDARD CHARACTERS WITHOUT CLAIM TO ANY PARTICULAR FONT, STYLE, SIZE, OR COLOR.

NO CLAIM IS MADE TO THE EXCLUSIVE RIGHT TO USE GENETICS, APART FROM THE MARK AS SHOWN.

FOR RESEARCH AND DEVELOPMENT AND CONSULTATION RELATED THERETO IN THE FIELD OF AGRICULTURE FOR THE DEVELOPMENT OF TECHNOLOGY FOR CONVENTIONAL AND GENETICALLY MODIFIED CORN AND SOYBEAN SEED (U.S. CLS. 100 AND 101).

GEORGE LORENZO, EXAMINING ATTORNEY

SN 78-802,285. RESERVOIR CONSULTING, INC., CAMBRIDGE, MA. FILED 1-30-2006.

ZYNC

THE MARK CONSISTS OF STANDARD CHARACTERS WITHOUT CLAIM TO ANY PARTICULAR FONT, STYLE, SIZE, OR COLOR.

FOR COMPUTER SERVICES, NAMELY, PROVIDING TEMPORARY USE OF NON-DOWNLOADABLE SOFTWARE FOR MAINTAINING AND UPDATING CALENDARS AMONG MULTIPLE USERS, NAMELY, ARRANGING MEETINGS, LOCAL EVENTS AND ACTIVITIES AMONG USERS THROUGH CALENDAR SHARING, AND EXPLOITING DYNAMIC CALENDARING AMONG MULTIPLE USERS TO PROVIDE CONTROLLED VISIBILITY ACROSS USERS' CALENDARS (U.S. CLS. 100 AND 101).

AMY MCMENAMIN, EXAMINING ATTORNEY

CLASS 42—(Continued).

SN 78-802,965. GENERIC SYSTEMS, INC., SYLVANIA, OH. FILED 1-31-2006.



NO CLAIM IS MADE TO THE EXCLUSIVE RIGHT TO USE "SYSTEMS", APART FROM THE MARK AS SHOWN. FOR DESIGN FOR OTHERS IN THE FIELD OF SPRAY EQUIPMENT SYSTEMS, ELECTRICAL CONTROL SYSTEMS, AND ROBOTIC SYSTEMS FOR OTHERS; AND SOFTWARE DESIGN AND PROGRAMMING OF COMPUTER CONTROL SYSTEMS FOR OTHERS (U.S. CLS. 100 AND 101).

FIRST USE 4-0-1996; IN COMMERCE 4-0-1996.
ALICE BENMAMAN, EXAMINING ATTORNEY

SN 78-814,708. INTERACTIVE BUSINESS SYSTEMS, INC., OAK BROOK, IL. FILED 2-14-2006.

REVAMP

THE MARK CONSISTS OF STANDARD CHARACTERS WITHOUT CLAIM TO ANY PARTICULAR FONT, STYLE, SIZE, OR COLOR.

FOR COMPUTER CONSULTING SERVICES (U.S. CLS. 100 AND 101).

FIRST USE 2-1-2006; IN COMMERCE 2-1-2006.
DAVID MILLER, EXAMINING ATTORNEY

CLASS 42—(Continued).

SN 78-820,288. ACCREDITATION COMMISSION FOR HEALTH CARE, INC., RALEIGH, NC. FILED 2-22-2006.



"THE COLOR(S) DARK GREEN, LIGHT GREEN, AND WHITE IS/ARE CLAIMED AS A FEATURE OF THE MARK." THE COLOR DARK GREEN APPEARS IN THE BACKGROUND OF THE SQUARE AND IN THE BORDER OUTLINING THE SQUARE, THE COLOR LIGHT GREEN APPEARS IN THE COLUMN DESIGN, AND THE COLOR WHITE APPEARS IN THE WORDING ACHC ACCREDITATION COMMISSION FOR HEALTH CARE, INC. AND IN THE BORDER OF THE SQUARE.

THE MARK CONSISTS OF A WHITE COLUMN DESIGN IN A SQUARE BOX WITH A GREEN BACKGROUND AND THE LETTERS "ACHC" FOLLOWED BY THE WORDS "ACCREDITATION COMMISSION FOR HEALTH CARE, INC." WRITTEN BELOW THE DESIGN WITHIN THE BOX. SEC. 2(F) AS TO "ACCREDITATION COMMISSION FOR HEALTH CARE, INC."

FOR ACCREDITATION SERVICES, NAMELY, DEVELOPING STANDARDS AND EVALUATING BUSINESSES FOR COMPLIANCE WITH THOSE STANDARDS FOR PURPOSES OF ACCREDITATION, FOR HEALTH CARE SERVICES INCLUDING HOME CARE AIDE, HOME HEALTH, INFUSION NURSING, CLINICAL RESPIRATORY CARE, HOSPICE, MEDICAL SUPPLY PROVIDER, REHABILITATION TECHNOLOGY SUPPLY PROVIDER, RESPIRATORY NEBULIZER MEDICATION, PHARMACY, POST MASTECTOMY FITTER SERVICES FOR BREAST CANCER SURGERY RELATED PRODUCTS, AMBULATORY INFUSION CENTER, HOME/DURABLE MEDICAL EQUIPMENT, PRIVATE DUTY NURSING, AND PRIVATE DUTY AIDE SERVICE (U.S. CLS. 100 AND 101).

FIRST USE 8-2-2005; IN COMMERCE 8-2-2005.
ATTIYA MALIK, EXAMINING ATTORNEY

SN 78-821,937. QUERREY & HARROW, LTD., CHICAGO, IL. FILED 2-23-2006.

querrey.com

THE MARK CONSISTS OF STANDARD CHARACTERS WITHOUT CLAIM TO ANY PARTICULAR FONT, STYLE, SIZE, OR COLOR.

FOR ATTORNEY SERVICES (U.S. CLS. 100 AND 101).
FIRST USE 5-29-1997; IN COMMERCE 5-29-1997.

JENNIFER KRISP, EXAMINING ATTORNEY

CLASS 42—(Continued).

SN 78-826,378. BERMAN, MIKE, VALENCIA, CA. FILED 3-1-2006.

AUCCWISH LIST

THE MARK CONSISTS OF STANDARD CHARACTERS WITHOUT CLAIM TO ANY PARTICULAR FONT, STYLE, SIZE, OR COLOR.

NO CLAIM IS MADE TO THE EXCLUSIVE RIGHT TO USE "LIST", APART FROM THE MARK AS SHOWN.

FOR CUSTOMIZED SEARCHING SERVICES, NAMELY, PROVIDING SPECIFIC INFORMATION VIA THE INTERNET AS REQUESTED BY CUSTOMERS BY MEANS OF MOBILE COMMUNICATIONS DEVICES (U.S. CLS. 100 AND 101).

ROBERT LAVACHE, EXAMINING ATTORNEY

SN 78-827,367. ASF-KEYSTONE, INC., GRANITE CITY, IL. FILED 3-2-2006.

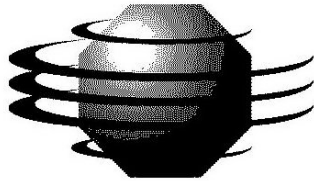

BLUE-WAVE

OWNER OF U.S. REG. NOS. 3,039,462 AND 3,039,463. THE STIPPLING IN THE MARK IS TO SHOW GRADATION FROM LIGHT TO DARK AND IS NOT A FEATURE OF THE MARK.

THE MARK CONSISTS OF A POLYGON HAVING PARTIALLY COMPLETED BANDS OR RINGS SURROUNDING IT, WITH THE WORDS BLUE-WAVE UNDERNEATH.

FOR QUALITY CONTROL FOR OTHERS (U.S. CLS. 100 AND 101).

FIRST USE 9-15-2004; IN COMMERCE 9-15-2004. TRACY CROSS, EXAMINING ATTORNEY

SN 78-828,013. DEVELOPMENT GURU, INC., ALISO VIEJO, CA. FILED 3-2-2006.



NO CLAIM IS MADE TO THE EXCLUSIVE RIGHT TO USE "INC.", APART FROM THE MARK AS SHOWN.

FOR INFORMATION TECHNOLOGY CONSULTATION (U.S. CLS. 100 AND 101).

FIRST USE 2-1-2003; IN COMMERCE 2-1-2003. KELLY MCCOY, EXAMINING ATTORNEY

CLASS 42—(Continued).

SN 78-830,306. KHAMJANI, SEPEHRAM, SAN FRANCISCO, CA. FILED 3-6-2006.



NO CLAIM IS MADE TO THE EXCLUSIVE RIGHT TO USE "ARCHITECTS", APART FROM THE MARK AS SHOWN.

THE MARK CONSISTS OF STYLIZED LETTERS. THE FOREIGN WORDING IN THE MARK TRANSLATES INTO ENGLISH AS ABSENT.

FOR DESIGN FOR OTHERS IN THE FIELD OF ARCHITECTURE (U.S. CLS. 100 AND 101).

MARILYN IZZI, EXAMINING ATTORNEY

SN 78-832,859. MICROSOFT CORPORATION, REDMOND, WA. FILED 3-8-2006.



FOR HOUSE MARK FOR A FULL LINE OF ONLINE NON-DOWNLOADABLE SOFTWARE (U.S. CLS. 100 AND 101).

KYLE PEETE, EXAMINING ATTORNEY

SN 78-837,673. UPSIDE SOFTWARE INC., EDMONTON, ALBERTA, CANADA, FILED 3-15-2006.

UpsideLive

THE MARK CONSISTS OF STANDARD CHARACTERS WITHOUT CLAIM TO ANY PARTICULAR FONT, STYLE, SIZE, OR COLOR.

PRIORITY CLAIMED UNDER SEC. 44(D) ON CANADA APPLICATION NO. 1293074, FILED 3-9-2006.

OWNER OF U.S. REG. NOS. 2,932,274 AND 2,954,056.

FOR APPLICATION SERVICE PROVIDER (ASP) FEATURING SOFTWARE IN THE FIELD OF USE FOR ASSISTING CLIENTS IN THE PROCESSING AND STORAGE OF INFORMATION RELATED TO CONTRACT DOCUMENTS, AND BUSINESS RELATIONSHIPS AND TRANSACTIONS (U.S. CLS. 100 AND 101).

FIRST USE 2-8-2006; IN COMMERCE 2-8-2006. DARRYL SPRUILL, EXAMINING ATTORNEY

CLASS 42—(Continued).

SN 78-837,821. I4DESIGN, LLC, CHICAGO, IL. FILED 3-15-2006.

i4design, LLC

THE MARK CONSISTS OF STANDARD CHARACTERS WITHOUT CLAIM TO ANY PARTICULAR FONT, STYLE, SIZE, OR COLOR.

NO CLAIM IS MADE TO THE EXCLUSIVE RIGHT TO USE "LLC", APART FROM THE MARK AS SHOWN.

FOR INTERIOR DESIGN; INTERIOR DECORATING; HOME AND BUSINESS INTERIOR DESIGN AND DECORATING CONSULTATION (U.S. CLS. 100 AND 101).

FIRST USE 7-15-1996; IN COMMERCE 0-0-1997.

DORITT L. CARROLL, EXAMINING ATTORNEY

CLASS 42—(Continued).

SN 78-845,242. EXCEPTIONAL INNOVATION LLC, WESTERVILLE, OH. FILED 3-24-2006.

life|assist

SN 78-838,338. FOSTER PEPPER PLLC, SEATTLE, WA. FILED 3-15-2006.



FOSTER PEPPER PLLC

OWNER OF U.S. REG. NOS. 2,424,679, 2,592,136 AND OTHERS.

NO CLAIM IS MADE TO THE EXCLUSIVE RIGHT TO USE "PLLC", APART FROM THE MARK AS SHOWN.

THE MARK CONSISTS OF FP LOGO DESIGN AND THE WORD FOSTER PEPPER PLLC.

FOR LEGAL SERVICES (U.S. CLS. 100 AND 101).

FIRST USE 1-1-2006; IN COMMERCE 1-1-2006.

MICHAEL WIENER, EXAMINING ATTORNEY

SN 78-843,197. BLOOMINGTON GOLD ENTERPRISES, INC., MARENGO, IL. FILED 3-22-2006.

SURVIVOR CERTIFIED

THE MARK CONSISTS OF STANDARD CHARACTERS WITHOUT CLAIM TO ANY PARTICULAR FONT, STYLE, SIZE, OR COLOR.

OWNER OF U.S. REG. NO. 1,590,274.

NO CLAIM IS MADE TO THE EXCLUSIVE RIGHT TO USE "CERTIFIED", APART FROM THE MARK AS SHOWN.

FOR INSPECTION OF VEHICLES FOR THE PURPOSE OF CERTIFYING THAT THEY ARE UNRESTORED AND UNALTERED (U.S. CLS. 100 AND 101).

MICHAEL WEBSTER, EXAMINING ATTORNEY

FOR TECHNICAL SUPPORT SERVICES SPECIFICALLY DIRECTED TO INSTALLERS AND CUSTOMERS OF APPLICANT'S PROPRIETARY HARDWARE, FIRMWARE, AND SOFTWARE SYSTEMS, NAMELY, TROUBLESHOOTING OF COMPUTER HARDWARE AND SOFTWARE USED FOR CONTROLLING AND OPERATING MULTIPLE DEVICES, NAMELY, CLIMATE AND ENVIRONMENT SYSTEMS, NAMELY, HEATING, AIR-CONDITIONING, VENTILATION AND CIRCULATION SYSTEMS, SECURITY SYSTEMS, NAMELY, SECURITY SYSTEMS FOR PERIMETER AND INTRUSION DETECTION, FIRE, SMOKE AND GAS DETECTION, AND AUDIO AND VIDEO SURVEILLANCE OF INTERIOR AND EXTERIOR OF PREMISES, LIGHTING SYSTEMS, NAMELY, INTERIOR AND EXTERIOR LIGHTS, WINDOW TREATMENTS, NAMELY, DRAPES, CURTAINS, BLINDS, MINI-BLINDS AND SHADES, AUDIO AND AUDIOVISUAL ENTERTAINMENT SYSTEMS, NAMELY, FUNCTIONS OF AUDIO AND AUDIOVISUAL EQUIPMENT SUCH AS CD, DVD AND VCR PLAYERS AND RECORDERS, RADIO, TV AND SATELLITE TUNERS, LASER DISC PLAYERS, MP3 PLAYERS, AND CRT, LCD, DIGITAL LIGHT PROCESSING, PLASMA AND VIDEO PROJECTOR DISPLAYS, AUDIO AND AUDIOVISUAL ENTERTAINMENT DISTRIBUTION SYSTEMS, NAMELY, DISTRIBUTION OF AUDIO AND AUDIOVISUAL ENTERTAINMENT MEDIA TO AUDIOVISUAL DEVICES, VIDEO DISPLAY COMPONENTS AND MOUNTINGS, NAMELY, MECHANIZED MOUNTINGS AND RECEPTACLES FOR VIDEO PROJECTORS, VIDEO PROJECTION SCREENS AND PANELS, AND POOL AND SPA CONTROLS FOR THE CONTROL AND MONITORING OF TEMPERATURE, CLEANING CYCLES AND DISPLAY OF ALARM EVENTS (U.S. CLS. 100 AND 101).

JENNIFER WILLISTON, EXAMINING ATTORNEY

CLASS 42—(Continued).

SN 78-845,262. EXCEPTIONAL INNOVATION LLC, WESTERVILLE, OH. FILED 3-24-2006.

life|support

FOR TECHNICAL SUPPORT SERVICES SPECIFICALLY DIRECTED TO INSTALLERS AND CUSTOMERS OF APPLICANT'S PROPRIETARY HARDWARE, FIRMWARE, AND SOFTWARE SYSTEMS, NAMELY, TROUBLESHOOTING OF COMPUTER HARDWARE AND SOFTWARE USED FOR CONTROLLING AND OPERATING MULTIPLE DEVICES, NAMELY, CLIMATE AND ENVIRONMENT SYSTEMS, NAMELY, HEATING, AIR-CONDITIONING, VENTILATION AND CIRCULATION SYSTEMS, SECURITY SYSTEMS, NAMELY, SECURITY SYSTEMS FOR PERIMETER AND INTRUSION DETECTION, FIRE, SMOKE AND GAS DETECTION, AND AUDIO AND VIDEO SURVEILLANCE OF INTERIOR AND EXTERIOR OF PREMISES, LIGHTING SYSTEMS, NAMELY, INTERIOR AND EXTERIOR LIGHTS, WINDOW TREATMENTS, NAMELY, DRAPES, CURTAINS, BLINDS, MINI-BLINDS AND SHADES, AUDIO AND AUDIOVISUAL ENTERTAINMENT SYSTEMS, NAMELY, FUNCTIONS OF AUDIO AND AUDIOVISUAL EQUIPMENT SUCH AS CD, DVD AND VCR PLAYERS AND RECORDERS, RADIO, TV AND SATELLITE TUNERS, LASER DISC PLAYERS, MP3 PLAYERS, AND CRT, LCD, DIGITAL LIGHT PROCESSING, PLASMA AND VIDEO PROJECTOR DISPLAYS, AUDIO AND AUDIOVISUAL ENTERTAINMENT DISTRIBUTION SYSTEMS, NAMELY, DISTRIBUTION OF AUDIO AND AUDIOVISUAL ENTERTAINMENT MEDIA TO AUDIOVISUAL DEVICES, VIDEO DISPLAY COMPONENTS AND MOUNTINGS, NAMELY, MECHANIZED MOUNTINGS AND RECEPTACLES FOR VIDEO PROJECTORS, VIDEO PROJECTION SCREENS AND PANELS, AND POOL AND SPA CONTROLS FOR THE CONTROL AND MONITORING OF TEMPERATURE, CLEANING CYCLES AND DISPLAY OF ALARM EVENTS (U.S. CLS. 100 AND 101).

JENNIFER WILLISTON, EXAMINING ATTORNEY

SN 78-846,651. LEVY CONSULTING INCORPORATED, SANTA MONICA, CA. FILED 3-27-2006.

GATHERSPACE.COM

THE MARK CONSISTS OF STANDARD CHARACTERS WITHOUT CLAIM TO ANY PARTICULAR FONT, STYLE, SIZE, OR COLOR.

FOR PROVIDING ONLINE NON-DOWNLOADABLE SOFTWARE FOR CENTRALIZING, MODELING AND SHARING SOFTWARE REQUIREMENTS (U.S. CLS. 100 AND 101).

FIRST USE 8-1-2005; IN COMMERCE 9-1-2005.

KATHERINE STOIDES, EXAMINING ATTORNEY

CLASS 42—(Continued).

SN 78-848,127. REDPATH INTEGRATED PATHOLOGY, INC., PITTSBURGH, PA. FILED 3-28-2006.

PATHFINDERTG

THE MARK CONSISTS OF STANDARD CHARACTERS WITHOUT CLAIM TO ANY PARTICULAR FONT, STYLE, SIZE, OR COLOR.

FOR MEDICAL LABORATORY SERVICES, NAMELY, TESTING AND ANALYSIS OF TISSUE OR FLUIDS FOR DIAGNOSTIC AND FORENSIC PURPOSES (U.S. CLS. 100 AND 101).

FIRST USE 7-1-2004; IN COMMERCE 7-1-2004.

HEATHER SAPP, EXAMINING ATTORNEY

SN 78-849,301. RIGGS HEINRICH MEDIA, INC., TULSA, OK. FILED 3-29-2006.

IMIRUS

THE MARK CONSISTS OF STANDARD CHARACTERS WITHOUT CLAIM TO ANY PARTICULAR FONT, STYLE, SIZE, OR COLOR.

FOR APPLICATION SERVICE PROVIDER FEATURING SOFTWARE IN THE FIELD OF ONLINE PUBLICATIONS FOR BRINGING PRINT MATERIALS ONLINE AND FOR EDITING ONLINE PRINT MATERIALS BY ADDING TO SUCH MATERIAL VARIOUS INTERACTIVE AND MEDIA ELEMENTS SUCH AS VIDEO, AUDIO AND CATALOG SHOPPING (U.S. CLS. 100 AND 101).

ROBERT STRUCK, EXAMINING ATTORNEY

CLASS 42—(Continued).

SN 78-849,961. DADE MOELLER & ASSOCIATES, RICH-
LAND, WA. FILED 3-30-2006.

Dade Moeller Technical Services

THE MARK CONSISTS OF STANDARD CHARACTERS WITHOUT CLAIM TO ANY PARTICULAR FONT, STYLE, SIZE, OR COLOR.

NO CLAIM IS MADE TO THE EXCLUSIVE RIGHT TO USE "TECHNICAL SERVICES", APART FROM THE MARK AS SHOWN.

THE NAME, PORTRAIT, AND/OR SIGNATURE SHOWN IN THE MARK IDENTIFIES DADE MOELLER, WHOSE CONSENT TO REGISTER IS SUBMITTED.

FOR TECHNICAL CONSULTING SERVICES IN ENVIRONMENTAL SAFETY AND HEALTH PHYSICS; ENVIRONMENTAL CONSULTING IN THE FIELD OF RADIATION PROTECTION AND RADIATION SAFETY COMPLIANCE; RADIOLOGICAL ENGINEERING; INTERNAL AND EXTERNAL DOSIMETRY SERVICES, NAMELY DOSIMETER PROCESSING AND PERSONNEL RADIATION EXPOSURE MONITORING AND REPORTING; ENVIRONMENTAL HEALTH AND SAFETY SERVICES, NAMELY, ENVIRONMENTAL AIR MONITORING (U.S. CLS. 100 AND 101).

FIRST USE 1-24-2006; IN COMMERCE 1-24-2006.
JANICE KIM, EXAMINING ATTORNEY

CLASS 42—(Continued).

SN 78-850,053. DADE MOELLER & ASSOCIATES, RICH-
LAND, WA. FILED 3-30-2006.

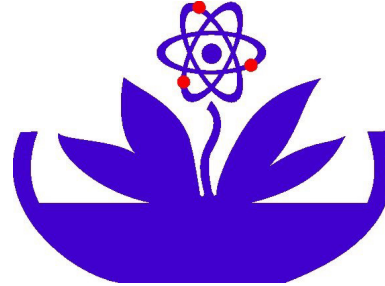

THE COLORS BLUE AND RED ARE CLAIMED AS A FEATURE OF THE MARK.

THE MARK CONSISTS OF A BLUE POT, BLUE PLANT, BLUE ATOM NUCLEUS AS BLOSSOM WITH ORBITING RED ELECTRONS.

FOR TECHNICAL CONSULTING SERVICES IN ENVIRONMENTAL SAFETY AND HEALTH PHYSICS; ENVIRONMENTAL CONSULTING IN THE FIELD OF RADIATION PROTECTION AND RADIATION SAFETY COMPLIANCE; RADIOLOGICAL ENGINEERING; INTERNAL AND EXTERNAL DOSIMETRY SERVICES, NAMELY DOSIMETER PROCESSING AND PERSONNEL RADIATION EXPOSURE MONITORING AND REPORTING; ENVIRONMENTAL HEALTH AND SAFETY SERVICES, NAMELY, ENVIRONMENTAL AIR MONITORING (U.S. CLS. 100 AND 101).

FIRST USE 1-24-2006; IN COMMERCE 1-24-2006.
JANICE KIM, EXAMINING ATTORNEY

SN 78-850,006. DADE MOELLER & ASSOCIATES, RICH-
LAND, WA. FILED 3-30-2006.

Dade Moeller TS

THE MARK CONSISTS OF STANDARD CHARACTERS WITHOUT CLAIM TO ANY PARTICULAR FONT, STYLE, SIZE, OR COLOR.

THE NAME, PORTRAIT, AND/OR SIGNATURE SHOWN IN THE MARK IDENTIFIES DADE MOELLER, WHOSE CONSENT TO REGISTER IS SUBMITTED.

FOR TECHNICAL CONSULTING SERVICES IN ENVIRONMENTAL SAFETY AND HEALTH PHYSICS; ENVIRONMENTAL CONSULTING IN THE FIELD OF RADIATION PROTECTION AND RADIATION SAFETY COMPLIANCE; RADIOLOGICAL ENGINEERING; INTERNAL AND EXTERNAL DOSIMETRY SERVICES, NAMELY DOSIMETER PROCESSING AND PERSONNEL RADIATION EXPOSURE MONITORING AND REPORTING; ENVIRONMENTAL HEALTH AND SAFETY SERVICES, NAMELY, ENVIRONMENTAL AIR MONITORING (U.S. CLS. 100 AND 101).

FIRST USE 1-24-2006; IN COMMERCE 1-24-2006.
JANICE KIM, EXAMINING ATTORNEY

SN 78-850,355. BIT BUCKET COMPUTER SERVICES, LLC,
HOPKINS, MN. FILED 3-30-2006.

Bit Bucket

THE MARK CONSISTS OF STANDARD CHARACTERS WITHOUT CLAIM TO ANY PARTICULAR FONT, STYLE, SIZE, OR COLOR.

FOR COMPUTER NETWORK DESIGN FOR OTHERS; COMPUTER SERVICES, NAMELY CREATING INDEXES OF INFORMATION, SITES AND OTHER RESOURCES AVAILABLE ON COMPUTER NETWORKS; COMPUTER SERVICES, NAMELY, DATA RECOVERY SERVICES; COMPUTER SERVICES, NAMELY, FILTERING OF UNWANTED E-MAILS; COMPUTER SERVICES, NAMELY, PROVIDING SEARCH ENGINES FOR OBTAINING DATA ON A GLOBAL COMPUTER NETWORK; COMPUTER SERVICES, NAMELY, REDIRECTING ELECTRONIC MAIL TO CHANGED PERSONAL ELECTRONIC ADDRESS; COMPUTER SERVICES, NAMELY, REMOTE AND ON-SITE MANAGEMENT OF ELECTRONIC MESSAGING SYSTEMS AND APPLICATIONS FOR OTHERS; DATABASE DEVELOPMENT SERVICES; DESIGN AND DEVELOPMENT OF INFORMATION AND DATA BASES; DESIGN AND DEVELOPMENT OF NETWORKS (U.S. CLS. 100 AND 101).

FIRST USE 11-29-2004; IN COMMERCE 11-29-2004.
DAVID ELTON, EXAMINING ATTORNEY

CLASS 42—(Continued).

SN 78-852,766. TUV AMERICA HEALTHCARE SPECIALISTS TUV SUD GROUP, LLC, CINCINNATI, OH. FILED 4-3-2006.

"When there is no margin
for error..."

THE MARK CONSISTS OF STANDARD CHARACTERS WITHOUT CLAIM TO ANY PARTICULAR FONT, STYLE, SIZE, OR COLOR.

FOR ACCREDITATION SERVICES, NAMELY, DEVELOPING, EVALUATING, AND TESTING STANDARDS FOR HOSPITALS AND OTHER HEALTHCARE ORGANIZATIONS FOR THE PURPOSE OF ACCREDITATION (U.S. CLS. 100 AND 101).

FIRST USE 6-20-2005; IN COMMERCE 6-20-2005.
JUDITH HELFMAN, EXAMINING ATTORNEY

SN 78-854,358. PAGE-ZONE WEB HOSTING, WAUSEON, OH. FILED 4-5-2006.

PAGE-ZONE

THE MARK CONSISTS OF STANDARD CHARACTERS WITHOUT CLAIM TO ANY PARTICULAR FONT, STYLE, SIZE, OR COLOR.

FOR INTERNET SERVICES, NAMELY HOSTING THE WEB SITES OF OTHERS ON A COMPUTER SERVER FOR A GLOBAL COMPUTER NETWORK AND REGISTRATION OF DOMAIN NAMES FOR IDENTIFICATION OF USERS ON A GLOBAL COMPUTER NETWORK (U.S. CLS. 100 AND 101).

FIRST USE 8-1-1998; IN COMMERCE 8-1-1998.
MARY MUNSON, EXAMINING ATTORNEY

SN 78-854,520. SUMPTER & GONZALEZ, L.L.P., AUSTIN, TX. FILED 4-5-2006.

Defending what matters
most.

THE MARK CONSISTS OF STANDARD CHARACTERS WITHOUT CLAIM TO ANY PARTICULAR FONT, STYLE, SIZE, OR COLOR.

FOR ATTORNEY SERVICES (U.S. CLS. 100 AND 101).
FIRST USE 4-5-2006; IN COMMERCE 4-5-2006.
JOHN DWYER, EXAMINING ATTORNEY

CLASS 42—(Continued).

SN 78-854,754. MINITAB INC., STATE COLLEGE, PA. FILED 4-5-2006.

QUALITY TRAINER BY MINITAB

THE MARK CONSISTS OF STANDARD CHARACTERS WITHOUT CLAIM TO ANY PARTICULAR FONT, STYLE, SIZE, OR COLOR.

OWNER OF U.S. REG. NOS. 2,251,375, 2,760,749 AND OTHERS.

NO CLAIM IS MADE TO THE EXCLUSIVE RIGHT TO USE "QUALITY TRAINER", APART FROM THE MARK AS SHOWN.

FOR PROVIDING TEMPORARY USE OF ON-LINE NON-DOWNLOADABLE SOFTWARE FOR USE IN TRAINING AND AS AN E-LEARNING TOOL IN THE FIELD OF STATISTICS, STATISTICAL SOFTWARE, QUALITY IMPROVEMENT AND DATA ANALYSIS (U.S. CLS. 100 AND 101).

MICHAEL LEWIS, EXAMINING ATTORNEY

SN 78-855,059. JADED PIXEL TECHNOLOGIES INC., OTTAWA, ONTARIO, CANADA, FILED 4-5-2006.

 **jadedpixel**

FOR DESIGN, CREATION, HOSTING AND MAINTENANCE OF INTERNET SITES FOR THIRD PARTIES (U.S. CLS. 100 AND 101).

FIRST USE 8-27-2005; IN COMMERCE 8-27-2005.
DANNEAN HETZEL, EXAMINING ATTORNEY

SN 78-855,662. GEORGENES, CHRISTOPHER, WELLESLEY, MA. FILED 4-6-2006.

mudbubble

THE MARK CONSISTS OF STANDARD CHARACTERS WITHOUT CLAIM TO ANY PARTICULAR FONT, STYLE, SIZE, OR COLOR.

FOR ANIMATION DESIGN FOR OTHERS; MOTION GRAPHIC DESIGN SERVICES; GRAPHIC ILLUSTRATION SERVICES FOR OTHERS; DESIGN SERVICES, NAMELY, WEBSITE DESIGN, COMPUTER SOFTWARE DESIGN, NAMELY, DESIGN OF VIDEO GAME PROGRAMS AND INTERACTIVE VIDEO GAME PROGRAMS; ANIMATION DESIGN FOR OTHERS, NAMELY, DESIGN OF ANIMATED CONTENT ALL OF THE FOREMENTIONED FOR USE ONLINE, OFFLINE AND ON TELEVISION (U.S. CLS. 100 AND 101).

FIRST USE 3-23-2002; IN COMMERCE 3-23-2002.
TINA BROWN, EXAMINING ATTORNEY

CLASS 42—(Continued).

SN 78-855,750. NEPHROGENEX, INC, CARY, NC. FILED 4-6-2006.

GLOMBASE

THE MARK CONSISTS OF STANDARD CHARACTERS WITHOUT CLAIM TO ANY PARTICULAR FONT, STYLE, SIZE, OR COLOR.

FOR COMPUTER AND SCIENTIFIC RESEARCH SERVICES, NAMELY, PROVIDING DATABASE SERVICES, COMPUTER PROGRAMMING SERVICES, AND SCIENTIFIC RESEARCH FOR GLOMERULAR NUCLEIC ACID OR PROTEIN EXPRESSION PROFILING, OR GLOMERULAR METABOLITE PRODUCTION PROFILING (U.S. CLS. 100 AND 101).

MONIQUE MILLER, EXAMINING ATTORNEY

SN 78-856,164. CREATIVE SCIENCE SYSTEMS, INC., CAMPBELL, CA. FILED 4-6-2006.

ACHIEVE SOA

THE MARK CONSISTS OF STANDARD CHARACTERS WITHOUT CLAIM TO ANY PARTICULAR FONT, STYLE, SIZE, OR COLOR.

NO CLAIM IS MADE TO THE EXCLUSIVE RIGHT TO USE "SOA", APART FROM THE MARK AS SHOWN.

FOR RESEARCH AND DEVELOPMENT SERVICES FOR OTHERS IN THE FIELD OF ENTERPRISE SOFTWARE INFRASTRUCTURE; DESIGN AND DEVELOPMENT OF COMPUTER SOFTWARE FOR OTHERS; DESIGN, DEVELOPMENT AND DEPLOYMENT OF DISTRIBUTED ENTERPRISE COMPUTER SYSTEMS BASED ON PROPRIETARY MIDDLEWARE AND ENTERPRISE SOFTWARE INFRASTRUCTURE TECHNOLOGY; CONSULTATION FOR OTHERS IN THE FIELD OF ENTERPRISE COMPUTER SYSTEMS ARCHITECTURE, DEVELOPMENT AND INTEGRATION; CONSULTING SERVICES IN THE FIELD OF DESIGNING, CUSTOMIZING AND IMPLEMENTING SOFTWARE FOR USE IN BUSINESS ENTERPRISE SOLUTIONS (U.S. CLS. 100 AND 101).

FIRST USE 3-0-1998; IN COMMERCE 3-0-1998.
DAHLIA GEORGE, EXAMINING ATTORNEY

SN 78-856,940. AMERICAN LEISURE CORPORATION, NANUET, NY. FILED 4-7-2006.

AQUAGROTTO

THE MARK CONSISTS OF STANDARD CHARACTERS WITHOUT CLAIM TO ANY PARTICULAR FONT, STYLE, SIZE, OR COLOR.

FOR DESIGN OF LIFESTYLE FACILITIES, SPAS AND FITNESS CENTERS (U.S. CLS. 100 AND 101).

DOMINICK J. SALEMI, EXAMINING ATTORNEY

CLASS 42—(Continued).

SN 78-857,214. JMRA CORPORATION, LAS VEGAS, NV. FILED 4-8-2006.

JMRA

THE MARK CONSISTS OF STANDARD CHARACTERS WITHOUT CLAIM TO ANY PARTICULAR FONT, STYLE, SIZE, OR COLOR.

FOR CONSULTING SERVICES IN THE FIELD OF DESIGN, SELECTION, IMPLEMENTATION AND USE OF COMPUTER HARDWARE AND SOFTWARE SYSTEMS (U.S. CLS. 100 AND 101).

FIRST USE 12-31-2002; IN COMMERCE 2-18-2006.
BARBARA A. LOUGHRAN, EXAMINING ATTORNEY

SN 78-857,628. BODE INSPECTION INC., BEAVERTON, OR. FILED 4-10-2006.



BODE INSPECTION, INC.

NO CLAIM IS MADE TO THE EXCLUSIVE RIGHT TO USE "INSPECTION, INC.", APART FROM THE MARK AS SHOWN.

THE MARK CONSISTS OF LETTER "B" INSIDE A TRIANGLE.

FOR INSPECTIONS OF TREATED WOOD PRODUCTS (U.S. CLS. 100 AND 101).

FIRST USE 7-6-1953; IN COMMERCE 7-6-1953.
ATTIYA MALIK, EXAMINING ATTORNEY

SN 78-857,743. MILLER, CANFIELD, PADDOCK AND STONE, P.L.C., DETROIT, MI. FILED 4-10-2006.

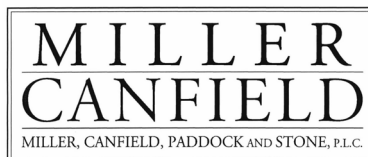

NO CLAIM IS MADE TO THE EXCLUSIVE RIGHT TO USE "P.L.C.", APART FROM THE MARK AS SHOWN.

THE MARK CONSISTS OF THE WORDS MILLER CANFIELD MILLER CANFIELD PADDOCK AND STONE, P.L.C. IN A RECTANGULAR DESIGN.

FOR LEGAL SERVICES (U.S. CLS. 100 AND 101).
FIRST USE 9-1-1997; IN COMMERCE 9-1-1997.
WENDY GOODMAN, EXAMINING ATTORNEY

CLASS 42—(Continued).

SN 78-858,699. ALCHIP TECHNOLOGIES, LTD., TAIPEI, TAIWAN, FILED 4-11-2006.

TOMORROW'S SOC SOLUTIONS
TODAY

THE MARK CONSISTS OF STANDARD CHARACTERS WITHOUT CLAIM TO ANY PARTICULAR FONT, STYLE, SIZE, OR COLOR.

FOR COMPUTER SOFTWARE CONSULTATION; COMPUTER SYSTEMS ANALYSIS; DESIGN, DEVELOPMENT AND IMPLEMENTATION OF SOFTWARE; INSTALLATION OF COMPUTER SOFTWARE; MAINTENANCE OF COMPUTER SOFTWARE; UP-DATING OF COMPUTER SOFTWARE (U.S. CLS. 100 AND 101).

FIRST USE 10-14-2005; IN COMMERCE 10-14-2005.
ALLISON HOLTZ, EXAMINING ATTORNEY

SN 78-858,714. GUNNELS, FREDERICK R, PALMYRA, VA. FILED 4-11-2006.

ToClosing.com

THE MARK CONSISTS OF STANDARD CHARACTERS WITHOUT CLAIM TO ANY PARTICULAR FONT, STYLE, SIZE, OR COLOR.

FOR COMPUTER SERVICE, NAMELY, ACTING AS AN APPLICATION SERVICE PROVIDER IN THE FIELD OF KNOWLEDGE MANAGEMENT TO HOST COMPUTER APPLICATION SOFTWARE FOR THE COLLECTION, EDITING, ORGANIZING, MODIFYING, BOOK MARKING, TRANSMISSION, STORAGE AND SHARING OF DATA AND INFORMATION (U.S. CLS. 100 AND 101).

RONALD MCMORROW, EXAMINING ATTORNEY

SN 78-858,894. SYNTEL, INC., TROY, MI. FILED 4-11-2006.

SYNAPPTOOL

THE MARK CONSISTS OF STANDARD CHARACTERS WITHOUT CLAIM TO ANY PARTICULAR FONT, STYLE, SIZE, OR COLOR.

OWNER OF U.S. REG. NOS. 1,692,076, 2,875,965 AND 2,932,357.

FOR CONSULTATION CONCERNING COMPUTER SOFTWARE AND SYSTEMS TESTING; CONSULTING SERVICES IN THE FIELD OF DESIGN AND IMPLEMENTATION OF SOFTWARE FOR OTHERS IN THE FIELD OF SYSTEMS TESTING (U.S. CLS. 100 AND 101).

ALEXANDER L. POWERS, EXAMINING ATTORNEY

CLASS 42—(Continued).

SN 78-859,584. SYNTEL, INC., TROY, MI. FILED 4-12-2006.

SYN-RISE

THE MARK CONSISTS OF STANDARD CHARACTERS WITHOUT CLAIM TO ANY PARTICULAR FONT, STYLE, SIZE, OR COLOR.

OWNER OF U.S. REG. NOS. 1,692,076, 2,875,965 AND 2,932,357.

FOR COMPUTER CONSULTING SERVICES, NAMELY DESIGN, IMPLEMENTATION AND TECHNOLOGY AUDIT SERVICES FOR OTHERS IN THE FIELD OF INFRASTRUCTURE AND INFRASTRUCTURE-RELATED SOFTWARE AND PROCESSES (U.S. CLS. 100 AND 101).

ALEXANDER L. POWERS, EXAMINING ATTORNEY

SN 78-859,602. EMERCENT SOLUTIONS, LLC, CHICAGO, IL. FILED 4-12-2006.

EMERCENT

THE MARK CONSISTS OF STANDARD CHARACTERS WITHOUT CLAIM TO ANY PARTICULAR FONT, STYLE, SIZE, OR COLOR.

FOR COMPUTER SERVICES, NAMELY, DESIGNING AND MAINTAINING WEBSITES FOR OTHERS; COMPUTER SOFTWARE DEVELOPMENT FOR OTHERS, NAMELY, DEVELOPMENT OF SOFTWARE FOR USE IN THE FIELD OF ONLINE MARKETING AND SALES; CONSULTING SERVICES IN THE FIELD OF COMPUTER SYSTEMS AND SOFTWARE FOR USE IN THE FIELD OF ONLINE MARKETING AND SALES (U.S. CLS. 100 AND 101).

FIRST USE 3-1-1999; IN COMMERCE 3-1-1999.

NAKIA HENRY, EXAMINING ATTORNEY

CLASS 42—(Continued).

SN 78-859,631. ROVING SOFTWARE INCORPORATED, DBA CONSTANT CONTACT, WALTHAM, MA. FILED 4-12-2006.

SPEAK UP

THE MARK CONSISTS OF STANDARD CHARACTERS WITHOUT CLAIM TO ANY PARTICULAR FONT, STYLE, SIZE, OR COLOR.

FOR PROVIDING TEMPORARY USE OF NON-DOWNLOADABLE COMPUTER SOFTWARE FOR CREATING, MANAGING, TRACKING, AND MEASURING ONLINE MARKETING AND ADVERTISING CAMPAIGNS, NAMELY, SOFTWARE DESIGNED TO ASSIST WEB SITE OWNERS IN GENERATING LISTS OF PERMISSION-BASED ELECTRONIC MAIL ADDRESSES AND OTHER CUSTOMER INFORMATION, AND IN CREATING, SCHEDULING, AND DISTRIBUTING CUSTOMIZED ELECTRONIC MAIL COMMUNICATIONS, NEWSLETTERS, ANNOUNCEMENTS, AND PROMOTIONS, AND ANALYZING AND REPORTING OF CAMPAIGN RESULTS, AND CUSTOMER AND SALES DATA (U.S. CLS. 100 AND 101).

ELLEN BURNS, EXAMINING ATTORNEY

SN 78-859,637. ROBERT WALTER HARVEY, DEL MAR, CA. FILED 4-12-2006.

COMPX

THE MARK CONSISTS OF STANDARD CHARACTERS WITHOUT CLAIM TO ANY PARTICULAR FONT, STYLE, SIZE, OR COLOR.

FOR COMPUTATIONAL MODELING SERVICES FOR USE IN A VARIETY OF PHYSICAL PROCESSES; DEVELOPMENT AND CUSTOM DESIGN OF COMPUTER SOFTWARE (U.S. CLS. 100 AND 101).

ANDREA EVANS, EXAMINING ATTORNEY

SN 78-859,701. VOCADA, INC., DALLAS, TX. FILED 4-12-2006.

VERIPHY

THE MARK CONSISTS OF STANDARD CHARACTERS WITHOUT CLAIM TO ANY PARTICULAR FONT, STYLE, SIZE, OR COLOR.

FOR APPLICATION SERVICE PROVIDER FEATURING SOFTWARE IN THE FIELD OF HEALTH CARE DELIVERY FOR PROVIDING STORAGE AND RETRIEVAL OF LABORATORY TEST RESULTS INFORMATION (U.S. CLS. 100 AND 101).

GISELLE AGOSTO, EXAMINING ATTORNEY

CLASS 42—(Continued).

SN 78-860,449. THOMAS TITLE & ESCROW, LLC, SCOTTSDALE, AZ. FILED 4-12-2006.

THOMAS TITLE & ESCROW

THE MARK CONSISTS OF STANDARD CHARACTERS WITHOUT CLAIM TO ANY PARTICULAR FONT, STYLE, SIZE, OR COLOR.

NO CLAIM IS MADE TO THE EXCLUSIVE RIGHT TO USE "TITLE AND ESCROW", APART FROM THE MARK AS SHOWN.

FOR REAL ESTATE CLOSING SERVICES; REAL ESTATE SETTLEMENT SERVICES; TITLE SEARCHING (U.S. CLS. 100 AND 101).

FIRST USE 1-3-2006; IN COMMERCE 1-3-2006.

KIMBERLY FRYE, EXAMINING ATTORNEY

SN 78-860,674. NEXT, LLC, CONYERS, GA. FILED 4-13-2006.



THE MARK CONSISTS OF AN IMAGE OF A BUILDING TURNED ON ITS SIDE WITH THE LETTER N FORMING A DOORWAY AT THE BASE OF THE LARGE BUILDING AND A SMALLER BUILDING TURNED ON ITS SIDE SUPERIMPOSED IN THE ROOF OF THE LARGE BUILDING FORMING THE LETTER E AND A DOORWAY IN THE SMALL BUILDING, AND THE LETTERS X AND T.

FOR ENVIRONMENTAL COMPLIANCE MANAGEMENT FOR OTHERS; REVIEWING STANDARDS AND PRACTICES TO ASSURE COMPLIANCE WITH ENVIRONMENTAL LAWS AND REGULATIONS; PREPARING ENVIRONMENTAL COMPLIANCE REPORTS; ENVIRONMENTAL SERVICES, NAMELY, TECHNICAL CONSULTATION IN THE FIELD OF ENVIRONMENTAL COMPLIANCE (U.S. CLS. 100 AND 101).

FIRST USE 12-1-2005; IN COMMERCE 12-1-2005.

NORA BUCHANAN WILL, EXAMINING ATTORNEY

CLASS 42—(Continued).

SN 78-860,765. 1 DAWG, LLC, LEAWOOD, KS. FILED 4-13-2006.

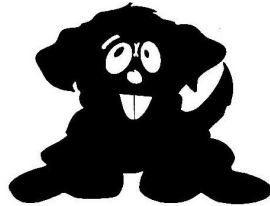

THE MARK CONSISTS OF A DRAWING OF A DOG, FOR PROVIDING TEMPORARY USE OF WEB-BASED, NON-DOWNLOADABLE COMPUTER SOFTWARE THAT CONVERTS THE FORMAT OF MEDIA FILES AND FACILITATES FILE SHARING (U.S. CLS. 100 AND 101).
SARA THOMAS, EXAMINING ATTORNEY

SN 78-860,789. 1 DAWG, LLC, LEAWOOD, KS. FILED 4-13-2006.

1 DAWG

THE MARK CONSISTS OF STANDARD CHARACTERS WITHOUT CLAIM TO ANY PARTICULAR FONT, STYLE, SIZE, OR COLOR.
FOR PROVIDING TEMPORARY USE OF WEB-BASED, NON-DOWNLOADABLE COMPUTER SOFTWARE THAT CONVERTS THE FORMAT OF MEDIA FILES AND FACILITATES FILE SHARING (U.S. CLS. 100 AND 101).
SARA THOMAS, EXAMINING ATTORNEY

SN 78-860,805. 1 DAWG, LLC, LEAWOOD, KS. FILED 4-13-2006.

INTERNET MEDIA UNLEASHED

THE MARK CONSISTS OF STANDARD CHARACTERS WITHOUT CLAIM TO ANY PARTICULAR FONT, STYLE, SIZE, OR COLOR.
NO CLAIM IS MADE TO THE EXCLUSIVE RIGHT TO USE "INTERNET MEDIA", APART FROM THE MARK AS SHOWN.
FOR PROVIDING TEMPORARY USE OF WEB-BASED, NON-DOWNLOADABLE COMPUTER SOFTWARE THAT CONVERTS THE FORMAT OF MEDIA FILES AND FACILITATES FILE SHARING (U.S. CLS. 100 AND 101).
SARA THOMAS, EXAMINING ATTORNEY

CLASS 42—(Continued).

SN 78-860,817. 1 DAWG, LLC, LEAWOOD, KS. FILED 4-13-2006.

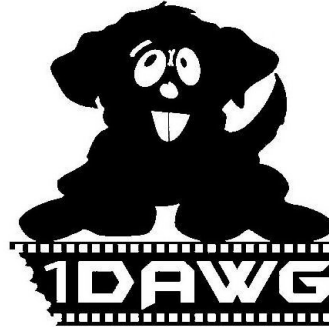

THE MARK CONSISTS OF A DRAWING OF A DOG POSITIONED ABOVE A DEPICTION OF A SEGMENT OF FILM, WITH THE WORDING 1 DAWG SUPERIMPOSED ON THE FILM.
FOR PROVIDING TEMPORARY USE OF WEB-BASED, NON-DOWNLOADABLE COMPUTER SOFTWARE THAT CONVERTS THE FORMAT OF MEDIA FILES AND FACILITATES FILE SHARING (U.S. CLS. 100 AND 101).
SARA THOMAS, EXAMINING ATTORNEY

SN 78-861,338. MORTRAX CORPORATION, CORAL GABLES, FL. FILED 4-13-2006.



FOR DESIGN AND DEVELOPMENT OF COMPUTER SOFTWARE SYSTEMS (U.S. CLS. 100 AND 101).
FIRST USE 10-4-2005; IN COMMERCE 10-4-2005.
KATHERINE CONNOLLY, EXAMINING ATTORNEY

SN 78-861,935. SALARY.COM, INC., WALTHAM, MA. FILED 4-14-2006.

COMPANALYST

THE MARK CONSISTS OF STANDARD CHARACTERS WITHOUT CLAIM TO ANY PARTICULAR FONT, STYLE, SIZE, OR COLOR.
FOR PROVIDING ONLINE NON-DOWNLOADABLE SOFTWARE FOR COMPARING JOB SALARIES, MANAGING SURVEYS, AND PROVIDING REPORTS AND DATA ASSESSMENT (U.S. CLS. 100 AND 101).
FIRST USE 7-25-2001; IN COMMERCE 7-25-2001.
MICHAEL SOUDERS, EXAMINING ATTORNEY

CLASS 42—(Continued).

SN 78-861,941. SALARY.COM, INC., WALTHAM, MA. FILED 4-14-2006.

COMPANALYST EXECUTIVE

THE MARK CONSISTS OF STANDARD CHARACTERS WITHOUT CLAIM TO ANY PARTICULAR FONT, STYLE, SIZE, OR COLOR.

NO CLAIM IS MADE TO THE EXCLUSIVE RIGHT TO USE "EXECUTIVE", APART FROM THE MARK AS SHOWN.

FOR PROVIDING ONLINE NON-DOWNLOADABLE SOFTWARE FOR ENABLING USER ACCESS TO PUBLIC COMPANY PROXY AND RELATED DATA (U.S. CLS. 100 AND 101).

MICHAEL SOUDERS, EXAMINING ATTORNEY

CLASS 42—(Continued).

SN 78-862,770. GLOBOMAX, LLC, ELLICOTT CITY, MD. FILED 4-17-2006.

ICON DEVELOPMENT SOLUTIONS

THE MARK CONSISTS OF STANDARD CHARACTERS WITHOUT CLAIM TO ANY PARTICULAR FONT, STYLE, SIZE, OR COLOR.

NO CLAIM IS MADE TO THE EXCLUSIVE RIGHT TO USE "DEVELOPMENT SOLUTIONS", APART FROM THE MARK AS SHOWN.

FOR PRODUCT DEVELOPMENT SERVICES AND PRODUCT DEVELOPMENT CONSULTATION TO OTHERS IN THE FIELD OF PHARMACEUTICALS FROM DRUG CONCEPT TO APPROVAL (U.S. CLS. 100 AND 101).

SANDRA MANIOS, EXAMINING ATTORNEY

SN 78-862,043. CELLGATE, INC., REDWOOD CITY, CA. FILED 4-14-2006.

CELLGATE

THE MARK CONSISTS OF STANDARD CHARACTERS WITHOUT CLAIM TO ANY PARTICULAR FONT, STYLE, SIZE, OR COLOR.

FOR RESEARCH AND DEVELOPMENT SERVICES FOR OTHERS RELATED TO CHEMICAL AND PHARMACEUTICAL PRODUCTS (U.S. CLS. 100 AND 101).

ANDREA EVANS, EXAMINING ATTORNEY

SN 78-863,917. WEIL, GOTSHAL & MANGES LLP, NEW YORK, NY. FILED 4-18-2006.

**WEIL GOTSHAL PRO BONO -
OUR FINEST HOURS**

THE MARK CONSISTS OF STANDARD CHARACTERS WITHOUT CLAIM TO ANY PARTICULAR FONT, STYLE, SIZE, OR COLOR.

NO CLAIM IS MADE TO THE EXCLUSIVE RIGHT TO USE "PRO BONO", APART FROM THE MARK AS SHOWN.

FOR LEGAL SERVICES, NAMELY, PROVIDING FREE LEGAL SERVICES TO INDIGENT MEMBERS OF THE COMMUNITY AND NONPROFIT ORGANIZATIONS (U.S. CLS. 100 AND 101).

FIRST USE 3-29-2006; IN COMMERCE 3-29-2006.
WANDA KAY PRICE, EXAMINING ATTORNEY

SN 78-862,721. DELORI DESIGNS LLC, COLBERT, WA. FILED 4-17-2006.

BUCKLE BABES

THE MARK CONSISTS OF STANDARD CHARACTERS WITHOUT CLAIM TO ANY PARTICULAR FONT, STYLE, SIZE, OR COLOR.

NO CLAIM IS MADE TO THE EXCLUSIVE RIGHT TO USE "BUCKLE", APART FROM THE MARK AS SHOWN.

FOR DESIGN FOR OTHERS IN THE FIELD OF BELT BUCKLES (U.S. CLS. 100 AND 101).

FIRST USE 1-28-2006; IN COMMERCE 1-28-2006.
TRACY CROSS, EXAMINING ATTORNEY

SN 78-864,231. DELORI DESIGNS LLC, COLBERT, WA. FILED 4-18-2006.

DeLori Designs

THE MARK CONSISTS OF STANDARD CHARACTERS WITHOUT CLAIM TO ANY PARTICULAR FONT, STYLE, SIZE, OR COLOR.

NO CLAIM IS MADE TO THE EXCLUSIVE RIGHT TO USE "DESIGNS", APART FROM THE MARK AS SHOWN.

FOR DESIGN FOR OTHERS IN THE FIELD OF BELT BUCKLES (U.S. CLS. 100 AND 101).

FIRST USE 7-0-2005; IN COMMERCE 1-28-2006.
TRACY CROSS, EXAMINING ATTORNEY

CLASS 42—(Continued).

SN 78-864,239. TECHNETIUM, INC., LONG BEACH, CA.
FILED 4-18-2006.

Green Hosting

THE MARK CONSISTS OF STANDARD CHARACTERS WITHOUT CLAIM TO ANY PARTICULAR FONT, STYLE, SIZE, OR COLOR.

NO CLAIM IS MADE TO THE EXCLUSIVE RIGHT TO USE "HOSTING", APART FROM THE MARK AS SHOWN.

FOR APPLICATION SERVICE PROVIDER (ASP), NAMELY, HOSTING COMPUTER SOFTWARE APPLICATIONS OF OTHERS; COMPUTER SERVICE, NAMELY, ACTING AS AN APPLICATION SERVICE PROVIDER IN THE FIELD OF KNOWLEDGE MANAGEMENT TO HOST COMPUTER APPLICATION SOFTWARE FOR CREATING SEARCHABLE DATABASES OF INFORMATION AND DATA; COMPUTER SERVICE, NAMELY, ACTING AS AN APPLICATION SERVICE PROVIDER IN THE FIELD OF KNOWLEDGE MANAGEMENT TO HOST COMPUTER APPLICATION SOFTWARE FOR SEARCHING AND RETRIEVING INFORMATION FROM DATABASES AND COMPUTER NETWORKS; COMPUTER SERVICE, NAMELY, ACTING AS AN APPLICATION SERVICE PROVIDER IN THE FIELD OF KNOWLEDGE MANAGEMENT TO HOST COMPUTER APPLICATION SOFTWARE FOR THE COLLECTION, EDITING, ORGANIZING, MODIFYING, BOOK MARKING, TRANSMISSION, STORAGE AND SHARING OF DATA AND INFORMATION; DESIGN, CREATION, HOSTING AND MAINTENANCE OF INTERNET SITES FOR THIRD PARTIES; DESIGN, CREATION, HOSTING, MAINTENANCE OF WEBSITES FOR OTHERS; HOSTING OF DIGITAL CONTENT ON THE INTERNET; HOSTING THE WEB SITES OF OTHERS ON A COMPUTER SERVER FOR A GLOBAL COMPUTER NETWORK (U.S. CLS. 100 AND 101).

MATTHEW MCDOWELL, EXAMINING ATTORNEY

SN 78-864,578. OVAMAX LLC, SUMMIT, NJ. FILED 4-19-2006.

Ovamax

THE MARK CONSISTS OF STANDARD CHARACTERS WITHOUT CLAIM TO ANY PARTICULAR FONT, STYLE, SIZE, OR COLOR.

FOR SCIENTIFIC RESEARCH AND DEVELOPMENT (U.S. CLS. 100 AND 101).

MELVIN AXILBUND, EXAMINING ATTORNEY

CLASS 42—(Continued).

SN 78-864,699. PONIC, LLC, PLANO, TX. FILED 4-19-2006.

ponic
Managing risk. Enabling business.

FOR TECHNOLOGY CONSULTATION IN THE FIELD OF SECURITY AND PRIVACY (U.S. CLS. 100 AND 101).
FIRST USE 12-15-2005; IN COMMERCE 4-1-2006.
TINA L. SNAPP, EXAMINING ATTORNEY

SN 78-865,170. GAS TECHNOLOGIES LLC, WALLOON LAKE, MI. FILED 4-19-2006.

GASTECHNO

THE MARK CONSISTS OF STANDARD CHARACTERS WITHOUT CLAIM TO ANY PARTICULAR FONT, STYLE, SIZE, OR COLOR.

FOR PATENT LICENSING AND DESIGN AND ENGINEERING OF CHEMICAL PROCESSES AND PROCESSING PLANTS (U.S. CLS. 100 AND 101).

PAULA MAYS, EXAMINING ATTORNEY

SN 78-865,372. ASKAROUND INC., MOUNT VERNON, NY.
FILED 4-19-2006.

The Power Of Us

THE MARK CONSISTS OF STANDARD CHARACTERS WITHOUT CLAIM TO ANY PARTICULAR FONT, STYLE, SIZE, OR COLOR.

FOR PROVIDING SPECIFIC INFORMATION AS REQUESTED BY CUSTOMERS VIA THE INTERNET (U.S. CLS. 100 AND 101).

MARIA-VICTORIA SUAREZ, EXAMINING ATTORNEY

CLASS 42—(Continued).

SN 78-865,594. NOBLITT & GILMORE, LLC, SCOTTSDALE, AZ. FILED 4-20-2006.



THE MARK CONSISTS OF THE LETTER 'N' BOUNDED FROM APPROXIMATELY 0 RADIANS TO 3PI/2 RADIANS (AS MEASURED WITH RESPECT TO THE CENTER OF THE LETTER 'N') BY A SUBSTANTIALLY UNIFORM LINEAR BORDER COMPRISING JOINED ORTHOGONAL PROJECTIONS, AND THE LETTER 'G' DISPOSED WITHIN THE QUADRANT CORRESPONDING TO APPROXIMATELY 3PI/2 RADIANS TO 2PI RADIANS (AS MEASURED WITH RESPECT TO THE CENTER OF THE LETTER 'N') AND OFFSET APPROXIMATELY HALF OF THE FONT PITCH DOWN AND HALF OF THE FONT PITCH TO THE RIGHT SUCH THAT THE UPPER-LEFT ARC OF THE LETTER 'G' APPROXIMATELY INTERSECTS THE CENTER OF THE LETTER 'N'.

FOR LEGAL SERVICES (U.S. CLS. 100 AND 101).
FIRST USE 6-30-2003; IN COMMERCE 6-30-2003.
GEORGE LORENZO, EXAMINING ATTORNEY

SN 78-865,667. THE FILMPUNKS, HOLLYWOOD, CA. FILED 4-20-2006.

FILMPUNKS

THE MARK CONSISTS OF STANDARD CHARACTERS WITHOUT CLAIM TO ANY PARTICULAR FONT, STYLE, SIZE, OR COLOR.

FOR COMMERCIAL ART DESIGN; DESIGN OF HOMEPAGES AND WEB-SITES; GRAPHIC ART DESIGN (U.S. CLS. 100 AND 101).

FIRST USE 3-13-2006; IN COMMERCE 3-13-2006.
NAAKWAMA ANKRAH, EXAMINING ATTORNEY

CLASS 42—(Continued).

SN 78-866,029. OMEGA BLUE, INC., MALIBU, CA. FILED 4-20-2006.

SKYWRITER

THE MARK CONSISTS OF STANDARD CHARACTERS WITHOUT CLAIM TO ANY PARTICULAR FONT, STYLE, SIZE, OR COLOR.

FOR APPLICATION SERVICE PROVIDER (ASP) FEATURING SOFTWARE IN THE FIELD OF AUTHORING OPERATION AND MAINTENANCE MANUALS; AND APPLICATION SERVICE PROVIDER (ASP) FEATURING SOFTWARE IN THE FIELD OF AUTHORING COMMERCIAL AEROSPACE OPERATION AND MAINTENANCE MANUALS (U.S. CLS. 100 AND 101).

LEIGH CAROLINE CASE, EXAMINING ATTORNEY

SN 78-866,145. PATE PIERCE & BAIRD, P.C., SALT LAKE CITY, UT. FILED 4-20-2006.

CREATE IT OWN IT

THE MARK CONSISTS OF STANDARD CHARACTERS WITHOUT CLAIM TO ANY PARTICULAR FONT, STYLE, SIZE, OR COLOR.

FOR LEGAL SERVICES (U.S. CLS. 100 AND 101).
FIRST USE 2-1-2006; IN COMMERCE 2-1-2006.
CIMMERIAN COLEMAN, EXAMINING ATTORNEY

SN 78-866,210. STUDENT, MANAGEMENT, ACCOUNTABILITY, REPORTING, TRACKING, INC., CHANDLER, AZ. FILED 4-20-2006.



THE MARK CONSISTS OF THE WORD "SMART" SEPARATED BY STARS WITH THE LETTER "S" BEING TOPPED WITH A GRADUATION CAP.

FOR PROVIDING ONLINE NON-DOWNLOADABLE SOFTWARE FOR MAINTAINING AND MANAGING RECORDS OF STUDENT AND PARENT DATA (U.S. CLS. 100 AND 101).

FIRST USE 3-15-2005; IN COMMERCE 3-15-2005.
MARGERY A. TIERNEY, EXAMINING ATTORNEY

CLASS 42—(Continued).

SN 78-866,439. HIGH CLARITY INTERNATIONAL LIMITED, SOUTHPORT QLD, AUSTRALIA, FILED 4-21-2006.

PMOZ

THE MARK CONSISTS OF STANDARD CHARACTERS WITHOUT CLAIM TO ANY PARTICULAR FONT, STYLE, SIZE, OR COLOR.

FOR COMPUTER SERVICES, NAMELY, PROVIDING SEARCH ENGINES FOR OBTAINING DATA ON A GLOBAL COMPUTER NETWORK; PROVIDING SPECIFIC INFORMATION AS REQUESTED BY CUSTOMERS VIA THE INTERNET (U.S. CLS. 100 AND 101).

JUSTINE D. PARKER, EXAMINING ATTORNEY

SN 78-866,630. VISTA IP LAW GROUP LLP, IRVINE, CA. FILED 4-21-2006.

VISTA

THE MARK CONSISTS OF STANDARD CHARACTERS WITHOUT CLAIM TO ANY PARTICULAR FONT, STYLE, SIZE, OR COLOR.

FOR LEGAL SERVICES (U.S. CLS. 100 AND 101).

FIRST USE 2-1-2006; IN COMMERCE 2-1-2006.

ALEX KEAM, EXAMINING ATTORNEY

SN 78-867,053. WORLD COMPLIANCE, INC., MIAMI, FL. FILED 4-21-2006.

WORLD COMPLIANCE

THE MARK CONSISTS OF STANDARD CHARACTERS WITHOUT CLAIM TO ANY PARTICULAR FONT, STYLE, SIZE, OR COLOR.

FOR DEVELOPMENT OF COMPUTER SOFTWARE DESIGNED TO STREAMLINE DUE DILIGENCE PROCEDURES (U.S. CLS. 100 AND 101).

FIRST USE 12-31-2001; IN COMMERCE 1-20-2002.

GIANCARLO CASTRO, EXAMINING ATTORNEY

CLASS 42—(Continued).

SN 78-867,182. AMERICAN HOMEOWNERSHIP ASSOCIATION LLC, ROYAL OAK, MI. FILED 4-21-2006.

MYSPENDINGPLAN

THE MARK CONSISTS OF STANDARD CHARACTERS WITHOUT CLAIM TO ANY PARTICULAR FONT, STYLE, SIZE, OR COLOR.

FOR PROVIDING ONLINE NON-DOWNLOADABLE SOFTWARE FOR HOUSEHOLD FINANCE, ACCOUNTING, BUDGETING, CASH FLOW TRACKING, BILL PAYING AND REMINDER ALERTS, ACCOUNT DATA AGGREGATION, SHOPPING COMPARISONS, SAVINGS ALERTS, AND PERSONAL FINANCIAL MANAGEMENT (U.S. CLS. 100 AND 101).

FIRST USE 10-18-2005; IN COMMERCE 1-8-2006.

CHERYL CLAYTON, EXAMINING ATTORNEY

SN 78-867,265. PONIC LLC, PLANO, TX. FILED 4-21-2006.

CISO-in-a-BOX

THE MARK CONSISTS OF STANDARD CHARACTERS WITHOUT CLAIM TO ANY PARTICULAR FONT, STYLE, SIZE, OR COLOR.

FOR TECHNOLOGY CONSULTATION IN THE FIELD OF SECURITY AND PRIVACY (U.S. CLS. 100 AND 101).

FIRST USE 12-15-2005; IN COMMERCE 4-1-2006.

TINA L. SNAPP, EXAMINING ATTORNEY

SN 78-867,269. WAK LLC, HONOLULU, HI. FILED 4-21-2006.

deciph●

FOR COMPUTER SERVICES, NAMELY, PROVIDING SEARCH ENGINES FOR OBTAINING DATA ON A GLOBAL COMPUTER NETWORK (U.S. CLS. 100 AND 101).

FIRST USE 3-1-2006; IN COMMERCE 3-1-2006.

PAUL E. FAHRENKOPF, EXAMINING ATTORNEY

CLASS 42—(Continued).

SN 78-867,308. MICROSOFT CORPORATION, REDMOND, WA. FILED 4-21-2006.

FOREFRONT

THE MARK CONSISTS OF STANDARD CHARACTERS WITHOUT CLAIM TO ANY PARTICULAR FONT, STYLE, SIZE, OR COLOR.

FOR COMPUTER VIRUS PROTECTION SERVICES; COMPUTER SECURITY SERVICES, NAMELY, RESTRICTING ACCESS TO AND BY COMPUTERS AND COMPUTER NETWORKS TO AND OF UNDESIRE WEB SITES, MEDIA, INDIVIDUALS AND FACILITIES; AND PROVIDING INFORMATION IN THE FIELD OF COMPUTER AND NETWORKS SECURITY AND PROTECTION (U.S. CLS. 100 AND 101).

DAVID ELTON, EXAMINING ATTORNEY

SN 78-867,427. FREAS, WALTER S., KNOXVILLE, MD. FILED 4-22-2006.

AQCA

THE MARK CONSISTS OF STANDARD CHARACTERS WITHOUT CLAIM TO ANY PARTICULAR FONT, STYLE, SIZE, OR COLOR.

FOR TESTING, ANALYSIS AND EVALUATION OF THE GOODS AND SERVICES OF OTHERS FOR THE PURPOSE OF CERTIFICATION (U.S. CLS. 100 AND 101). FIRST USE 3-10-2006; IN COMMERCE 4-15-2006.

PATRICIA EVANKO, EXAMINING ATTORNEY

SN 78-867,475. CATALYST NETWORKS, INC., WOODSTOCK, GA. FILED 4-22-2006.

ITSFORSALE

THE MARK CONSISTS OF STANDARD CHARACTERS WITHOUT CLAIM TO ANY PARTICULAR FONT, STYLE, SIZE, OR COLOR.

FOR COMPUTER SERVICES, NAMELY, DESIGN, DEVELOPMENT, MAINTENANCE, AND HOSTING OF INTERNET WEBSITES FOR OTHERS; DESIGN, DEVELOPMENT, MAINTENANCE, CUSTOMIZATION AND MODIFICATION OF COMPUTER SOFTWARE FOR OTHERS; AND, COMPUTER CONSULTATION SERVICES (U.S. CLS. 100 AND 101).

FIRST USE 4-10-2006; IN COMMERCE 4-10-2006.
ANDREA SAUNDERS, EXAMINING ATTORNEY

CLASS 42—(Continued).

SN 78-867,479. CATALYST NETWORKS, INC., WOODSTOCK, GA. FILED 4-22-2006.



THE COLOR(S) GREEN, WHITE, AND BLACK IS/ARE CLAIMED AS A FEATURE OF THE MARK.

THE MARK CONSISTS OF THE OUTLINE OF A HOUSE IN WHITE ON A GREEN, CIRCULAR BACKGROUND; TO THE RIGHT OF THE HOUSE DESIGN IS THE WORD MARK ITSFORSALE IN PROGRESSIVELY THICKER BLACK LETTERS.

FOR COMPUTER SERVICES, NAMELY, DESIGN, DEVELOPMENT, MAINTENANCE, AND HOSTING OF INTERNET WEBSITES FOR OTHERS; DESIGN, DEVELOPMENT, MAINTENANCE, CUSTOMIZATION AND MODIFICATION OF COMPUTER SOFTWARE FOR OTHERS; AND, COMPUTER CONSULTATION SERVICES (U.S. CLS. 100 AND 101).

FIRST USE 4-10-2006; IN COMMERCE 4-10-2006.
ANDREA SAUNDERS, EXAMINING ATTORNEY

SN 78-867,970. SIMPLE BUSINESS SYSTEMS, INC., SCOTTS VALLEY, CA. AND YOUNG, ALASTAIR NEIL, LIVERMORE, CA. FILED 4-24-2006.

KWIKPAL

THE MARK CONSISTS OF STANDARD CHARACTERS WITHOUT CLAIM TO ANY PARTICULAR FONT, STYLE, SIZE, OR COLOR.

FOR ONLINE APPLICATION SERVICE PROVIDER (ASP) FEATURING SOFTWARE IN THE FIELD OF TRANSACTION PROCESSING THAT PERMITS UPLOADING OF ASP TRANSACTIONAL DATA AND CONVERSION THEREOF TO DATA FORMATS THAT MAY BE USED WITH CONSUMER FINANCIAL SOFTWARE PROGRAMS (U.S. CLS. 100 AND 101).

FIRST USE 3-1-2006; IN COMMERCE 3-1-2006.
KELLY BOULTON, EXAMINING ATTORNEY

SN 78-868,451. OBVERSE, INC., WASHINGTON, DC. FILED 4-24-2006.

THE MARK CONSISTS OF A CIRCLE WITH TWO STRIPES ON THE RIGHT SIDE AND THE STYLIZED TEXT OBVERSE.

FOR INFORMATION TECHNOLOGY CONSULTATION (U.S. CLS. 100 AND 101).

FIRST USE 1-17-2002; IN COMMERCE 3-8-2002.
GRETTA YAO, EXAMINING ATTORNEY

CLASS 42—(Continued).

SN 78-868,508. ENFUSION2, LLC, FAYETTEVILLE, AR. FILED 4-24-2006.

enFusion[®]

THE MARK CONSISTS OF SPACED LETTERS WITH A SUPERSCRIP 2 AFTER THE LAST LETTER FORMING A NAME.

FOR ARCHITECTURAL DESIGN; COMPUTER AIDED DESIGN FOR OTHERS; DESIGN OF SPECIALTY INTERIOR AND EXTERIOR ENVIRONMENT SETTINGS; INTERIOR DECORATION CONSULTATION; SHOP INTERIOR DESIGN (U.S. CLS. 100 AND 101).

LEIGH CAROLINE CASE, EXAMINING ATTORNEY

SN 78-868,515. ENFUSION2, LLC, FAYETTEVILLE, AR. FILED 4-24-2006.



THE MARK CONSISTS OF LOWERCASE G AND E, VIGNAGORGIALLA LETTERS, ENCASED IN A LARGE RECTANGLE WITH A HORIZONTAL SLIM RECTANGLE CENTERED ON LARGE RECTANGLE AND THE G AND E.

FOR ARCHITECTURAL DESIGN; COMPUTER AIDED DESIGN FOR OTHERS; DESIGN OF SPECIALTY INTERIOR AND EXTERIOR ENVIRONMENT SETTINGS; INTERIOR DECORATION CONSULTATION; SHOP INTERIOR DESIGN (U.S. CLS. 100 AND 101).

LEIGH CAROLINE CASE, EXAMINING ATTORNEY

SN 78-869,140. OLENICK AND ASSOCIATES, INC., CHICAGO, IL. FILED 4-25-2006.

**Talented People. Raising
the Bar.**

THE MARK CONSISTS OF STANDARD CHARACTERS WITHOUT CLAIM TO ANY PARTICULAR FONT, STYLE, SIZE, OR COLOR.

FOR COMPUTER CONSULTATION; COMPUTER CONSULTATION IN THE FIELD OF COMPUTER SECURITY; COMPUTER PROJECT MANAGEMENT SERVICES; COMPUTER SOFTWARE CONSULTATION (U.S. CLS. 100 AND 101).

FIRST USE 4-1-2006; IN COMMERCE 4-1-2006.

SHAUNIA WALLACE, EXAMINING ATTORNEY

CLASS 42—(Continued).

SN 78-869,925. LASHER HOLZAPFEL SPERRY & EBBERTSON, SEATTLE, WA. FILED 4-26-2006.

We Make Law Make Sense.

THE MARK CONSISTS OF STANDARD CHARACTERS WITHOUT CLAIM TO ANY PARTICULAR FONT, STYLE, SIZE, OR COLOR.

FOR LEGAL SERVICES (U.S. CLS. 100 AND 101).

FIRST USE 4-22-2002; IN COMMERCE 4-22-2002.

KATINA MISTER, EXAMINING ATTORNEY

SN 78-871,481. JEFFERSON COULTER PLLC, SEATTLE, WA. FILED 4-27-2006.

**Because Ideas Don't
Protect Themselves.**

THE MARK CONSISTS OF STANDARD CHARACTERS WITHOUT CLAIM TO ANY PARTICULAR FONT, STYLE, SIZE, OR COLOR.

FOR CONSULTING AND LEGAL SERVICES IN THE FIELD OF PRIVACY AND SECURITY LAWS, REGULATIONS, AND REQUIREMENTS; LEGAL RESEARCH; LEGAL SERVICES; LICENSING OF INTELLECTUAL PROPERTY; PROVIDING INFORMATION RELATING TO LEGAL AFFAIRS (U.S. CLS. 100 AND 101).

FIRST USE 1-1-2005; IN COMMERCE 1-1-2005.

KRISTINA KLOIBER, EXAMINING ATTORNEY

SN 78-871,577. IMMIGRATION LAW OFFICES OF M. YEHLEN BROOKS, INC., STOCKTON, CA. FILED 4-27-2006.

**America is Built on the
Backs of Immigrants**

THE MARK CONSISTS OF STANDARD CHARACTERS WITHOUT CLAIM TO ANY PARTICULAR FONT, STYLE, SIZE, OR COLOR.

FOR LEGAL SERVICES (U.S. CLS. 100 AND 101).

FIRST USE 1-15-1999; IN COMMERCE 1-15-1999.

GRETTA YAO, EXAMINING ATTORNEY

CLASS 42—(Continued).

SN 78-872,568. FLAGSHIP CUSTOMS SERVICES, INC., SILVER SPRING, MD. FILED 4-28-2006.

EXPORT2000

THE MARK CONSISTS OF STANDARD CHARACTERS WITHOUT CLAIM TO ANY PARTICULAR FONT, STYLE, SIZE, OR COLOR.

FOR COMPUTER SERVICE, NAMELY, ACTING AS AN APPLICATION SERVICE PROVIDER IN THE FIELD OF KNOWLEDGE MANAGEMENT TO HOST COMPUTER APPLICATION SOFTWARE FOR THE COLLECTION, EDITING, ORGANIZING, MODIFYING, BOOK MARKING, TRANSMISSION, STORAGE AND SHARING OF DATA AND INFORMATION (U.S. CLS. 100 AND 101).

FIRST USE 6-9-1997; IN COMMERCE 6-9-1997.
STEVEN JACKSON, EXAMINING ATTORNEY

SN 78-873,886. RED PEBBLE INC., CLARKSVILLE, MD. FILED 5-1-2006.



THE MARK CONSISTS OF ONE BIG OVAL AND 7 SMALLER OVALS.

FOR COMPUTER PROGRAMMING FOR OTHERS; COMPUTER SERVICES, NAMELY, CREATING AND MAINTAINING WEB SITES FOR OTHERS; COMPUTER SOFTWARE CONSULTATION; COMPUTER SOFTWARE DESIGN FOR OTHERS; COMPUTER SOFTWARE DESIGN, COMPUTER PROGRAMMING, OR MAINTENANCE OF COMPUTER SOFTWARE; COMPUTER SOFTWARE DEVELOPMENT (U.S. CLS. 100 AND 101).

FIRST USE 5-5-2000; IN COMMERCE 5-5-2000.
STEVEN JACKSON, EXAMINING ATTORNEY

SN 78-874,529. CHRISTOPHER & WEISBERG, P.A., FORT LAUDERDALE, FL. FILED 5-2-2006.



THE MARK CONSISTS OF A WING.
FOR LEGAL SERVICES (U.S. CLS. 100 AND 101).
FIRST USE 8-30-2004; IN COMMERCE 8-30-2004.
FRED CARL, EXAMINING ATTORNEY

CLASS 42—(Continued).

SN 78-875,531. HUTCHISON LAW GROUP PLLC, RALEIGH, NC. FILED 5-3-2006.

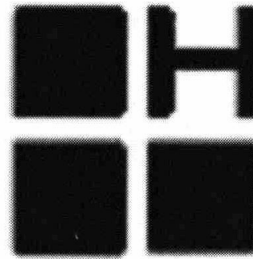

THE MARK CONSISTS OF THREE SHADED SQUARES ARRANGED IN A LARGER SQUARE WITH THE LETTER "H" IN THE TOP RIGHT CORNER MAKING THE LARGER SQUARE.

FOR LEGAL SERVICES (U.S. CLS. 100 AND 101).
FIRST USE 5-1-2006; IN COMMERCE 5-1-2006.
WON TEAK OH, EXAMINING ATTORNEY

SN 78-876,691. WILLIS, LARA E, STEWARTSVILLE, NJ. FILED 5-4-2006.



THE MARK CONSISTS OF THE STYLIZED LETTERS "LPD".

FOR (BASED ON USE IN COMMERCE) COMMERCIAL ART DESIGN; COMPUTER AIDED DESIGN FOR OTHERS; COMPUTER GRAPHICS SERVICES; CONSULTING SERVICES IN THE FIELD OF DESIGN OF NEWSLETTERS; DESIGNING OF PACKAGING AND WRAPPING MATERIALS; GRAPHIC ART DESIGN; GRAPHIC DESIGN SERVICES; PACKAGING DESIGN FOR OTHERS; (BASED ON INTENT TO USE) COMPUTER SERVICES, NAMELY, DESIGNING AND IMPLEMENTING WEB SITES FOR OTHERS; COMPUTER SITE DESIGN; DESIGN AND DEVELOPMENT OF MULTIMEDIA PRODUCTS; DESIGN OF HOME PAGES; DESIGN OF HOME PAGES, COMPUTER SOFTWARE AND WEB SITES; DESIGN OF HOMEPAGES AND WEBSITES; DESIGN OF HOMEPAGES AND WEBSITES; DESIGN, CREATION, HOSTING, MAINTENANCE OF WEBSITES FOR OTHERS; DEVELOPMENT, DESIGN AND UPDATING OF HOME PAGES (U.S. CLS. 100 AND 101).

FIRST USE 4-1-2006; IN COMMERCE 4-1-2006.
PAUL F. GAST, EXAMINING ATTORNEY

CLASS 42—(Continued).

SN 78-877,271. ADVANCED MICRO DEVICES, INC., SUNNYVALE, CA. FILED 5-5-2006.

THE GREEN GRID

THE MARK CONSISTS OF STANDARD CHARACTERS WITHOUT CLAIM TO ANY PARTICULAR FONT, STYLE, SIZE, OR COLOR.

FOR INFORMATION SERVICES, NAMELY, PROVIDING INFORMATION IN THE AREA OF ENERGY UTILIZATION AND EFFICIENCY OF DATA PROCESSING SYSTEMS (U.S. CLS. 100 AND 101).

FIRST USE 4-19-2006; IN COMMERCE 4-19-2006.
ANDREA SAUNDERS, EXAMINING ATTORNEY

SN 78-881,414. MEDTRONIC, INC., MINNEAPOLIS, MN. FILED 5-11-2006.

MEDTRONIC PAINFREE

THE MARK CONSISTS OF STANDARD CHARACTERS WITHOUT CLAIM TO ANY PARTICULAR FONT, STYLE, SIZE, OR COLOR.

FOR MEDICAL AND SCIENTIFIC RESEARCH, NAMELY CONDUCTING CLINICAL TRIALS (U.S. CLS. 100 AND 101).

ROBIN CHOSID, EXAMINING ATTORNEY

SN 78-884,165. FREAS, WALTER S., KNOXVILLE, MD. FILED 5-16-2006.

QCC  AQCA

FOR TESTING, ANALYSIS AND EVALUATION OF THE GOODS AND SERVICES OF OTHERS FOR THE PURPOSE OF CERTIFICATION (U.S. CLS. 100 AND 101).

FIRST USE 4-15-2006; IN COMMERCE 5-9-2006.
PATRICIA EVANKO, EXAMINING ATTORNEY

CLASS 42—(Continued).

SN 78-897,950. MICRO ELECTRONICS, INC., HILLIARD, OH. FILED 6-1-2006.

DATASURE

THE MARK CONSISTS OF STANDARD CHARACTERS WITHOUT CLAIM TO ANY PARTICULAR FONT, STYLE, SIZE, OR COLOR.

OWNER OF U.S. REG. NO. 3,072,081.
FOR COMPUTER SECURITY SERVICE, NAMELY, HARD DRIVE ERASURE (U.S. CLS. 100 AND 101).

FIRST USE 5-17-2006; IN COMMERCE 5-17-2006.
CARRIE ACHEN, EXAMINING ATTORNEY

SN 78-903,299. ITRON, INC., SPOKANE, WA. FILED 6-7-2006.

OPENWAY

THE MARK CONSISTS OF STANDARD CHARACTERS WITHOUT CLAIM TO ANY PARTICULAR FONT, STYLE, SIZE, OR COLOR.

FOR COMPUTER RELATED SERVICES AND CONSULTING FOR THE UTILITY, POWER, ENERGY AND WATER INDUSTRIES, NAMELY COMPUTER-RELATED CONSULTING FOR THE DESIGN, IMPLEMENTATION, AND MAINTENANCE OF INTEGRATED COMMUNICATIONS NETWORKS AND DATA COLLECTION COMPUTER AND COMMUNICATION NETWORK SYSTEMS FOR DATA COLLECTION APPLICATIONS, NAMELY AUTOMATED METER READING, DEMAND RESPONSE, DATA PRESENTATION, IN-HOME CONTROL, REMOTE AND TWO-WAY COMMUNICATIONS BETWEEN NETWORKS AND UTILITY METERS, VIA THE INTERNET, INTRANETS, EXTRANETS, RADIO FREQUENCY NETWORKS, SATELLITE, WIRELESS NETWORKS, AND TELEPHONE LINES, ALL FOR USE IN THE UTILITY, POWER, ENERGY AND WATER INDUSTRIES; TECHNICAL SUPPORT, NAMELY MONITORING OF NETWORK SYSTEMS FOR THE UTILITY, POWER, ENERGY AND WATER INDUSTRIES AND TROUBLESHOOTING OF COMPUTER SOFTWARE PROBLEMS VIA TELEPHONE, IN PERSON, AND OVER THE INTERNET; PROVIDING TEMPORARY USE OF ON-LINE NON-DOWNLOADABLE SOFTWARE FOR USE OF AND ACCESS TO INTEGRATED COMMUNICATIONS NETWORKS, DATA COLLECTION COMPUTER AND COMMUNICATION NETWORK SYSTEMS, COMPUTER OPERATING SOFTWARE, AND COMPUTER SOFTWARE FOR DATA COLLECTION APPLICATIONS, NAMELY, AUTOMATED METER READING, REMOTE AND TWO-WAY COMMUNICATIONS BETWEEN NETWORKS AND UTILITY METERS, VIA THE INTERNET, INTRANETS, EXTRANETS, RADIO FREQUENCY NETWORKS, SATELLITE, WIRELESS NETWORKS, AND TELEPHONE, ALL FOR USE IN THE UTILITY, POWER, ENERGY AND WATER INDUSTRIES; PROVIDING TEMPORARY USE OF ON-LINE NON-DOWNLOADABLE SOFTWARE FOR ENABLING UTILITIES AND ENERGY PROVIDERS TO GATHER UTILITY, ELECTRICITY, NATURAL GAS AND WATER USAGE DATA TO SUPPORT TIME-BASED RATES AND ENABLE CONSUMERS AND BUSINESSES TO MAKE CHOICES ABOUT UTILITY, POWER, ENERGY AND WATER USAGE IN RESPONSE TO MARKET AND PRICE SIGNALS, AS WELL AS SYSTEM CONDITIONS; PROVIDING TEMPORARY USE OF ON-LINE NON-DOWNLOADABLE SOFTWARE FOR PROVIDING

CLASS 42—(Continued).

ALERTS OF UTILITY, POWER OUTAGES, POWER RESTORATION AND WATER LEAKS; PROVIDING TEMPORARY USE OF ON-LINE NON-DOWNLOADABLE SOFTWARE FOR PROVIDING CONSUMERS AND BUSINESSES WITH ACCESS TO THEIR USAGE DATA AND REMOTE DISCONNECTION AND RECONNECTION OF UTILITY SERVICES; PROVIDING TEMPORARY USE OF ON-LINE NON-DOWNLOADABLE SOFTWARE FOR CONNECTIVITY TO AND MANAGEMENT OF IN-HOME APPLIANCES AND DEVICES SUCH AS THERMOSTATS, WATER HEATERS, POOL HEATERS, DIRECTLY OR VIA IN-HOME GATEWAY(S) SO THAT USE OF THOSE DEVICES CAN BE ALTERED AS CONDITIONS WARRANT; PROVIDING TEMPORARY USE OF ON-LINE NON-DOWNLOADABLE COMMUNICATION SOFTWARE FOR USE IN THE UTILITY, POWER, ENERGY AND WATER INDUSTRIES; PROVIDING TEMPORARY USE OF ON-LINE NON-DOWNLOADABLE SOFTWARE FOR DATA COLLECTION APPLICATIONS, NAMELY, AUTOMATED METER READING, DISTRIBUTION AUTOMATION, TWO-WAY COMMUNICATIONS BETWEEN NETWORKS AND UTILITY METERS, AND DEMAND SIDE MANAGEMENT APPLICATIONS VIA THE INTERNET, INTRANETS, EXTRANETS, RADIO FREQUENCY NETWORKS, SATELLITE, WIRELESS NETWORKS, TELEPHONE LINES, AND INTEGRATED COMMUNICATIONS NETWORKS, NAMELY, PUBLIC SWITCHED TELEPHONE NETWORKS, VIRTUAL PRIVATE NETWORKS, PRIVATE NETWORKS, PUBLIC NETWORKS, AND CELLULAR NETWORKS, ALL FOR USE IN THE UTILITY, POWER, ENERGY AND WATER INDUSTRIES; PROVIDING TEMPORARY USE OF ON-LINE NON-DOWNLOADABLE COMPUTER OPERATING SOFTWARE FOR DATA COLLECTION AND REMOTE PROGRAMMING APPLICATIONS, NAMELY, ONE-WAY AND TWO-WAY AUTOMATED METER READING, DISTRIBUTION AUTOMATION, REMOTE COMMUNICATIONS BETWEEN NETWORKS AND BETWEEN AND AMONG UTILITY METERS, AND DEMAND SIDE MANAGEMENT APPLICATIONS VIA THE INTERNET, INTRANETS, EXTRANETS, RADIO FREQUENCY NETWORKS, SATELLITE, WIRELESS NETWORKS, TELEPHONE LINES, AND INTEGRATED COMMUNICATIONS NETWORKS, NAMELY, PUBLIC SWITCHED TELEPHONE NETWORKS, IP-BASED PUBLIC NETWORKS, VIRTUAL PRIVATE NETWORKS, PRIVATE NETWORKS, POWERLINE AND BROADBAND OVER POWERLINE NETWORKS, PUBLIC NETWORKS AND CELLULAR NETWORKS FOR ENERGY, WATER AND FUEL DATA, AND OTHER UTILITY METER MONITORING POINTS (U.S. CLS. 100 AND 101).

KATHLEEN M. VANSTON, EXAMINING ATTORNEY

CLASS 42—(Continued).

SN 78-903,401. LICENSERY CORPORATION, SEATTLE, WA. AND WANG, EDWARD D. H., SEATTLE, WA. FILED 6-8-2006.

Licensery

THE MARK CONSISTS OF STANDARD CHARACTERS WITHOUT CLAIM TO ANY PARTICULAR FONT, STYLE, SIZE, OR COLOR.

FOR ACCREDITATION SERVICES, NAMELY, DEVELOPING, EVALUATING, AND TESTING STANDARDS FOR INTELLECTUAL PROPERTY FOR THE PURPOSE OF ACCREDITATION; APPLICATION SERVICE PROVIDER (ASP) FEATURING SOFTWARE IN THE FIELD OF INTELLECTUAL PROPERTY; COMPUTER SECURITY SERVICE, NAMELY, RESTRICTING ACCESS TO AND BY COMPUTER NETWORKS TO AND OF UNDESIRE WEB SITES, MEDIA AND INDIVIDUALS AND FACILITIES; COMPUTER SERVICE, NAMELY, ACTING AS AN APPLICATION SERVICE PROVIDER IN THE FIELD OF KNOWLEDGE MANAGEMENT TO HOST COMPUTER APPLICATION SOFTWARE FOR SEARCHING AND RETRIEVING INFORMATION FROM DATABASES AND COMPUTER NETWORKS; COPYRIGHT MANAGEMENT; COPYRIGHT MANAGEMENT CONSULTATION; DEVELOPMENT OF VOLUNTARY STANDARDS FOR INTELLECTUAL PROPERTY; EXPERT WITNESS SERVICES IN THE FIELD OF INTELLECTUAL PROPERTY; INTELLECTUAL PROPERTY CONSULTATION; LEGAL SERVICES; LICENSING OF INTELLECTUAL PROPERTY; LITIGATION SUPPORT SERVICES; MEDIATION; NOTARY PUBLIC SERVICES; PARALEGAL SERVICES; PATENT AGENCY AND INDUSTRIAL PROPERTY CONSULTATION; PATENT LICENSING; PHARMACEUTICAL DRUG DEVELOPMENT SERVICES; PROVIDING QUALITY ASSURANCE SERVICES IN THE FIELD OF INTELLECTUAL PROPERTY; STOCK PHOTOGRAPHY SERVICES, NAMELY, LEASING REPRODUCTION RIGHTS OF PHOTOGRAPHS AND TRANSPARENCIES TO OTHERS (U.S. CLS. 100 AND 101).

SEAN CROWLEY, EXAMINING ATTORNEY

SN 78-911,209. SYNTEL, INC., TROY, MI. FILED 6-19-2006.

SYNTELOVATION

THE MARK CONSISTS OF STANDARD CHARACTERS WITHOUT CLAIM TO ANY PARTICULAR FONT, STYLE, SIZE, OR COLOR.

OWNER OF U.S. REG. NOS. 1,692,076, 2,875,965 AND 2,932,357.

FOR CONSULTING SERVICES IN THE FIELD OF ANALYSIS, ARCHITECTURE, DESIGN, DEVELOPMENT, TESTING, DOCUMENTATION, IMPLEMENTATION AND SUPPORT OF SOFTWARE FOR OTHERS (U.S. CLS. 100 AND 101).

FIRST USE 6-14-2006; IN COMMERCE 6-14-2006.

ALEXANDER L. POWERS, EXAMINING ATTORNEY

CLASS 42—(Continued).

SN 78-947,342. SITE FOUNDATION, NEW YORK, NY. FILED 8-8-2006.

IRF

THE MARK CONSISTS OF STANDARD CHARACTERS WITHOUT CLAIM TO ANY PARTICULAR FONT, STYLE, SIZE, OR COLOR.

FOR RESEARCH ON THE IMPORTANCE OF MOTIVATION AND INCENTIVE PROGRAMS IN PROMOTING INCREASED PRODUCTIVITY AND QUALITY ACHIEVEMENT OF PREDETERMINED GOALS AND OBJECTIVES (U.S. CLS. 100 AND 101).

HEATHER SAPP, EXAMINING ATTORNEY

SN 78-949,041. BURCHFIELD, NORMAN T., ALLEN, TX. FILED 8-10-2006.

Clan-Solutions.com

THE MARK CONSISTS OF STANDARD CHARACTERS WITHOUT CLAIM TO ANY PARTICULAR FONT, STYLE, SIZE, OR COLOR.

FOR COMPUTER SERVICE, NAMELY, ACTING AS AN APPLICATION SERVICE PROVIDER IN THE FIELD OF KNOWLEDGE MANAGEMENT TO HOST COMPUTER APPLICATION SOFTWARE FOR CREATING SEARCHABLE DATABASES OF INFORMATION AND DATA; COMPUTER SERVICE, NAMELY, ACTING AS AN APPLICATION SERVICE PROVIDER IN THE FIELD OF KNOWLEDGE MANAGEMENT TO HOST COMPUTER APPLICATION SOFTWARE FOR SEARCHING AND RETRIEVING INFORMATION FROM DATABASES AND COMPUTER NETWORKS; DESIGN, CREATION, HOSTING AND MAINTENANCE OF INTERNET SITES FOR THIRD PARTIES; DESIGN, CREATION, HOSTING, MAINTENANCE OF WEBSITES FOR OTHERS; HOSTING OF DIGITAL CONTENT ON THE INTERNET; HOSTING THE DIGITAL AUDIO AND VIDEO CONTENT OF OTHERS FOR THE PURPOSE OF ENABLING HOTEL, INN, AND OTHER LODGING ESTABLISHMENT GUESTS TO DOWNLOAD THE CONTENT ON A PAY PER VIEW BASIS; HOSTING THE WEB SITES OF OTHERS ON A COMPUTER SERVER FOR A GLOBAL COMPUTER NETWORK; WEB SITE HOSTING SERVICES (U.S. CLS. 100 AND 101).

FIRST USE 2-1-2003; IN COMMERCE 2-1-2003.

WILLIAM P. SHANAHAN, EXAMINING ATTORNEY

CLASS 42—(Continued).

SN 79-009,411. ALPHALYSE A/S, DENMARK, FILED 12-20-2004.

PICK 'N POST

THE MARK CONSISTS OF STANDARD CHARACTERS WITHOUT CLAIM TO ANY PARTICULAR FONT, STYLE, SIZE, OR COLOR.

PRIORITY DATE OF 6-30-2004 IS CLAIMED.

OWNER OF INTERNATIONAL REGISTRATION 0844953 DATED 12-20-2004, EXPIRES 12-20-2014.

FOR SCIENTIFIC RESEARCH SERVICES IN THE FIELD OF IDENTIFYING AND ANALYZING PROTEINS IN THE BODY (U.S. CLS. 100 AND 101).

ROBERT C. CLARK JR., EXAMINING ATTORNEY

SN 79-010,963. FORGE INFORMATION TECHNOLOGY PTY LTD, AUSTRALIA, FILED 2-17-2005.

Map Intelligence

THE MARK CONSISTS OF STANDARD CHARACTERS WITHOUT CLAIM TO ANY PARTICULAR FONT, STYLE, SIZE, OR COLOR.

OWNER OF INTERNATIONAL REGISTRATION 0849740 DATED 2-17-2005, EXPIRES 2-17-2015.

NO CLAIM IS MADE TO THE EXCLUSIVE RIGHT TO USE MAP, APART FROM THE MARK AS SHOWN.

FOR DESIGN AND DEVELOPMENT OF COMPUTER HARDWARE AND SOFTWARE (U.S. CLS. 100 AND 101).

RON FAIRBANKS, EXAMINING ATTORNEY

SN 79-014,317. GENETIC TECHNOLOGIES LIMITED, AUSTRALIA, FILED 7-29-2005.

ACTN3 SPORTS GENE

THE MARK CONSISTS OF STANDARD CHARACTERS WITHOUT CLAIM TO ANY PARTICULAR FONT, STYLE, SIZE, OR COLOR.

PRIORITY DATE OF 2-2-2005 IS CLAIMED.

OWNER OF INTERNATIONAL REGISTRATION 0859091 DATED 7-29-2005, EXPIRES 7-29-2015.

NO CLAIM IS MADE TO THE EXCLUSIVE RIGHT TO USE ACTN3 AND GENE, APART FROM THE MARK AS SHOWN.

FOR GENETIC TESTING SERVICES, NAMELY, TESTING OF HUMAN GENES FOR ASSESSING SPORT PERFORMANCE POTENTIAL (U.S. CLS. 100 AND 101).

ERNEST SHOSHO, EXAMINING ATTORNEY

CLASS 42—(Continued).

SN 79-017,123. BÜHLER AG, SWITZERLAND, FILED 7-27-2005.

VersiShot

THE MARK CONSISTS OF STANDARD CHARACTERS WITHOUT CLAIM TO ANY PARTICULAR FONT, STYLE, SIZE, OR COLOR.

PRIORITY DATE OF 3-31-2005 IS CLAIMED.
OWNER OF INTERNATIONAL REGISTRATION 0866956 DATED 7-27-2005, EXPIRES 7-27-2015.
FOR LEGAL COUNSELING AND REPRESENTATION (U.S. CLS. 100 AND 101).
DAYNA BROWNE, EXAMINING ATTORNEY

SN 79-017,124. BÜHLER AG, SWITZERLAND, FILED 7-27-2005.

VoluShot

THE MARK CONSISTS OF STANDARD CHARACTERS WITHOUT CLAIM TO ANY PARTICULAR FONT, STYLE, SIZE, OR COLOR.

PRIORITY DATE OF 3-31-2005 IS CLAIMED.
OWNER OF INTERNATIONAL REGISTRATION 0866957 DATED 7-27-2005, EXPIRES 7-27-2015.
FOR LEGAL COUNSELING AND REPRESENTATION (U.S. CLS. 100 AND 101).
DAYNA BROWNE, EXAMINING ATTORNEY

SN 79-017,125. BÜHLER AG, SWITZERLAND, FILED 7-27-2005.

PreciShot

THE MARK CONSISTS OF STANDARD CHARACTERS WITHOUT CLAIM TO ANY PARTICULAR FONT, STYLE, SIZE, OR COLOR.

PRIORITY DATE OF 3-31-2005 IS CLAIMED.
OWNER OF INTERNATIONAL REGISTRATION 0866958 DATED 7-27-2005, EXPIRES 7-27-2015.
FOR LEGAL COUNSELING AND REPRESENTATION (U.S. CLS. 100 AND 101).
DAYNA BROWNE, EXAMINING ATTORNEY

CLASS 42—(Continued).

SN 79-017,126. BÜHLER AG, SWITZERLAND, FILED 7-27-2005.

PowerShot

THE MARK CONSISTS OF STANDARD CHARACTERS WITHOUT CLAIM TO ANY PARTICULAR FONT, STYLE, SIZE, OR COLOR.

PRIORITY DATE OF 3-31-2005 IS CLAIMED.
OWNER OF INTERNATIONAL REGISTRATION 0866959 DATED 7-27-2005, EXPIRES 7-27-2015.
FOR LEGAL COUNSELING AND REPRESENTATION (U.S. CLS. 100 AND 101).
DAYNA BROWNE, EXAMINING ATTORNEY

SN 79-017,912. ENDOLAB MECHANICAL ENGINEERING GMBH, FED REP GERMANY, FILED 8-24-2005.

Endo1ab

THE MARK CONSISTS OF STANDARD CHARACTERS WITHOUT CLAIM TO ANY PARTICULAR FONT, STYLE, SIZE, OR COLOR.

OWNER OF INTERNATIONAL REGISTRATION 0763195 DATED 2-9-2001, EXPIRES 2-9-2011.
FOR PRODUCT DEVELOPMENT AND TESTING FOR OTHERS OF MECHANICAL COMPONENTS, IN PARTICULAR MEDICAL PRODUCTS, AS WELL AS PRODUCT DEVELOPMENT OF TEST EQUIPMENT FOR MECHANICAL TESTING OF MEDICAL COMPONENTS FOR THIRD PARTIES (U.S. CLS. 100 AND 101).
KAELIE KUNG, EXAMINING ATTORNEY

CLASS 43—HOTEL AND RESTAURANT SERVICES

SN 76-358,374. MAKRIS, JULIA, ALPINE, NJ. FILED 1-14-2002.



THE GREEK CHARACTER TRANSLITERATES TO "THALASSA", AND THIS MEANS "SEA" IN THE ENGLISH LANGUAGE.

FOR RESTAURANT SERVICES, NAMELY, STORE-FRONT AND STAND-ALONE RESTAURANTS SPECIALIZING IN GREEK FOOD (U.S. CLS. 100 AND 101).
FIRST USE 1-1-2000; IN COMMERCE 1-1-2000.
BENJAMIN OKEKE, EXAMINING ATTORNEY

CLASS 43—(Continued).

SN 76-599,774. SJE HOLDINGS, INC., OMAHA, NE. FILED 6-25-2004.

SCOOTERS

THE MARK CONSISTS OF STANDARD CHARACTERS WITHOUT CLAIM TO ANY PARTICULAR FONT, STYLE, SIZE, OR COLOR.

FOR COFFEE HOUSE SERVICES FEATURING COUNTER-ORDERING OF SPECIALTY COFFEE DRINKS AND SMOOTHIES (U.S. CLS. 100 AND 101).

FIRST USE 9-0-2003; IN COMMERCE 9-0-2003.
MICHELE SWAIN, EXAMINING ATTORNEY

SN 76-643,064. PANDELPHIA CORP., LAS VEGAS, NV. FILED 7-18-2005.

LEMON GRILL

THE MARK CONSISTS OF STANDARD CHARACTERS WITHOUT CLAIM TO ANY PARTICULAR FONT, STYLE, SIZE, OR COLOR.

FOR RESTAURANT SERVICES (U.S. CLS. 100 AND 101).

GRETTA YAO, EXAMINING ATTORNEY

SN 76-644,412. THE DREAM TEAM, LLC, MIAMI BEACH, FL. FILED 8-8-2005.

WHERE THE BEAUTIFUL PEOPLE COME TO GET UGLY

THE MARK CONSISTS OF STANDARD CHARACTERS WITHOUT CLAIM TO ANY PARTICULAR FONT, STYLE, SIZE, OR COLOR.

THE CONCURRENT USER IS SPORTS ENTERTAINMENT, INC., DOING BUSINESS AT 2954 PERKINS ROAD, BATON ROUGE, LOUISIANA, 70808. ON OCTOBER 10, 2003, SPORTS ENTERTAINMENT, INC. APPLIED TO REGISTER THE MARK WHERE BEAUTIFUL PEOPLE COME TO GET UGLY ON THE U.S. PATENT AND TRADEMARK OFFICE PRINCIPAL REGISTER, AND WHICH, ON APRIL 19, 2005, WAS SUBSEQUENTLY ISSUED U.S. TRADEMARK REG. NO. 2941226. SPORTS ENTERTAINMENT, INC. REGISTERED THE MARK WHERE BEAUTIFUL PEOPLE COME TO GET UGLY IN INTERNATIONAL CLASS 25 FOR T-SHIRTS, AND INTERNATIONAL CLASS 43 FOR RESTAURANT SERVICES. UPON INFORMATION AND BELIEF, SPORTS ENTERTAINMENT, INC. HAS BEEN USING THE MARK SINCE 1991. APPLICANT CLAIMS EXCLUSIVE RIGHT TO USE THE MARK FOR RESTAURANT AND BAR SERVICES IN THE AREA COMPRISING THE ENTIRE UNITED STATES EXCEPT FOR THE STATE OF LOUISIANA.

FOR RESTAURANT AND BAR SERVICES (U.S. CLS. 100 AND 101).

FIRST USE 5-15-2002; IN COMMERCE 5-15-2002.
KAREN BRACEY, EXAMINING ATTORNEY

CLASS 43—(Continued).

SN 76-647,451. BINICI, KEMAL, NEW YORK, NY. FILED 9-26-2005.

Zeytin

THE MARK CONSISTS OF STANDARD CHARACTERS WITHOUT CLAIM TO ANY PARTICULAR FONT, STYLE, SIZE, OR COLOR.

THE ENGLISH TRANSLATION OF THE WORD "ZEYTIN" IN THE MARK IS "OLIVES".

FOR RESTAURANT AND BAR SERVICES (U.S. CLS. 100 AND 101).

FIRST USE 3-0-2004; IN COMMERCE 3-0-2004.
STEPHANIE DAVIS, EXAMINING ATTORNEY

SN 76-647,571. BINICI, KEMAL, NEW YORK, NY. FILED 9-26-2005.



THE NAME "ZEYTIN" OVER AN OLIVE BRANCH WITH THREE OLIVES AND EIGHT LEAVES.

THE ENGLISH TRANSLATION OF THE WORD "ZEYTIN" IN THE MARK IS "OLIVES".

FOR RESTAURANT AND BAR SERVICES (U.S. CLS. 100 AND 101).

FIRST USE 3-0-2004; IN COMMERCE 3-0-2004.
STEPHANIE DAVIS, EXAMINING ATTORNEY

SN 76-658,641. POTATOES, POTATOES, POTATOES INC., AGOURA HILLS, CA. FILED 4-18-2006.

THE BEST BBQ UNDER ONE WOOF

THE MARK CONSISTS OF STANDARD CHARACTERS WITHOUT CLAIM TO ANY PARTICULAR FONT, STYLE, SIZE, OR COLOR.

FOR PROVIDING FOOD AND DRINK IN THE FORM OF EAT-IN AND TAKEOUT, FOR BARBECUE AND OTHER FOOD (U.S. CLS. 100 AND 101).

FIRST USE 2-10-2006; IN COMMERCE 4-4-2006.

ARETHA SOMERVILLE, EXAMINING ATTORNEY

CLASS 43—(Continued).

SN 76-661,261. DREAM DINNERS, INC., SNOHOMISH, WA.
FILED 6-8-2006.

LIFE JUST GOT EASIER!

THE MARK CONSISTS OF STANDARD CHARACTERS WITHOUT CLAIM TO ANY PARTICULAR FONT, STYLE, SIZE, OR COLOR.

OWNER OF U.S. REG. NO. 2,816,395.
FOR PERSONALIZED MENU AND FOOD PREPARATION AND FOOD CATERING FOR THE GENERAL PUBLIC (U.S. CLS. 100 AND 101).
FIRST USE 6-1-2002; IN COMMERCE 6-1-2002.
JASON ROTH, EXAMINING ATTORNEY

CLASS 43—(Continued).

SN 78-646,320. EARL OF SANDWICH (USA), LLC, ORLANDO, FL. FILED 6-8-2005.

**THE ORIGINAL SANDWICH
SINCE 1762**

THE MARK CONSISTS OF STANDARD CHARACTERS WITHOUT CLAIM TO ANY PARTICULAR FONT, STYLE, SIZE, OR COLOR.

NO CLAIM IS MADE TO THE EXCLUSIVE RIGHT TO USE "THE ORIGINAL SANDWICH", APART FROM THE MARK AS SHOWN.

FOR RESTAURANT SERVICES (U.S. CLS. 100 AND 101).

FIRST USE 3-31-2004; IN COMMERCE 3-31-2004.
MONIQUE MILLER, EXAMINING ATTORNEY

SN 78-539,182. RESTAURANT PEONY, L.P., OAKLAND, CA.
FILED 12-28-2004.

CAFE 88

THE MARK CONSISTS OF STANDARD CHARACTERS WITHOUT CLAIM TO ANY PARTICULAR FONT, STYLE, SIZE, OR COLOR.

NO CLAIM IS MADE TO THE EXCLUSIVE RIGHT TO USE CAFE, APART FROM THE MARK AS SHOWN.

FOR RESTAURANT SERVICES (U.S. CLS. 100 AND 101).

FIRST USE 10-23-2004; IN COMMERCE 10-23-2004.

ANNE FARRELL, EXAMINING ATTORNEY

SN 78-663,729. D'INTINO, NOELLE L., NORTH ATTLEBORO, MA. AND CHACE, SARAH R., NORTH ATTLEBORO, MA. FILED 7-5-2005.

SN 78-542,432. C. C YOUNG MEMORIAL HOME, DALLAS, TX. FILED 1-5-2005.

C. C. YOUNG
WHERE THE SPIRIT IS AGELESS

C. C. YOUNG DOES NOT IDENTIFY A PARTICULAR LIVING INDIVIDUAL.

THE MARK CONSISTS OF THE WORDS, "C. C. YOUNG WHERE THE SPIRIT IS AGELESS" WRITTEN IN STYLIZED FONT BELOW AN OUTLINE DRAWING OF A HORIZON CONSISTING OF A SUN SETTING INTO WAVES.

FOR SENIOR CITIZEN LIVING FACILITIES IN THE NATURE OF RETIREMENT HOMES AND ASSISTED LIVING FACILITIES (U.S. CLS. 100 AND 101).

FIRST USE 10-20-2004; IN COMMERCE 10-20-2004.

HOWARD B. LEVINE, EXAMINING ATTORNEY

**ScribbleTime A Center for
Early Learning**

THE MARK CONSISTS OF STANDARD CHARACTERS WITHOUT CLAIM TO ANY PARTICULAR FONT, STYLE, SIZE, OR COLOR.

NO CLAIM IS MADE TO THE EXCLUSIVE RIGHT TO USE "A CENTER FOR EARLY LEARNING", APART FROM THE MARK AS SHOWN.

FOR DAY CARE SERVICES FOR CHILDREN BETWEEN THE AGES OF 6 WEEKS AND 9 ½ YEARS (U.S. CLS. 100 AND 101).

FIRST USE 1-1-2005; IN COMMERCE 1-1-2005.

EVELYN BRADLEY, EXAMINING ATTORNEY

CLASS 43—(Continued).

SN 78-675,144. CHRYSALIS SHELTER FOR VICTIMS OF DOMESTIC VIOLENCE, INC., PHOENIX, AZ. FILED 7-21-2005.



NO CLAIM IS MADE TO THE EXCLUSIVE RIGHT TO USE "TRANSFORMING LIVES", APART FROM THE MARK AS SHOWN.

THE COLOR(S) GREEN, WHITE AND BLACK IS/ARE CLAIMED AS A FEATURE OF THE MARK.

THE MARK CONSISTS OF THE COLORS GREEN, WHITE AND BLACK APPEARING IN BUTTERFLY DESIGN WITH THE OUTLINE OF THE BUTTERFLY DESIGN IN THE COLOR BLACK, AND THE COLOR BLACK APPEARS IN THE WORDING 'CHRYSALIS TRANSFORMING LIVES'.

FOR EMERGENCY SHELTER SERVICES, NAMELY, PROVIDING TEMPORARY HOUSING (U.S. CLS. 100 AND 101).

FIRST USE 10-1-2003; IN COMMERCE 10-1-2003.
ATTIYA MALIK, EXAMINING ATTORNEY

SN 78-685,653. PRL USA HOLDINGS, INC., WILMINGTON, DE. FILED 8-4-2005.

RUGBY

THE MARK CONSISTS OF STANDARD CHARACTERS WITHOUT CLAIM TO ANY PARTICULAR FONT, STYLE, SIZE, OR COLOR.

OWNER OF U.S. REG. NOS. 2,139,322, 3,060,044 AND OTHERS.

FOR CAFES; RESTAURANT SERVICES; RESTAURANTS (U.S. CLS. 100 AND 101).

WON TEAK OH, EXAMINING ATTORNEY

SN 78-687,645. WW HANDSOME HARRY'S OF NAPLES, LLC, NAPLES, FL. FILED 8-8-2005.

HANDSOME HARRY'S

THE MARK CONSISTS OF STANDARD CHARACTERS WITHOUT CLAIM TO ANY PARTICULAR FONT, STYLE, SIZE, OR COLOR.

THE NAME "HANDSOME HARRY'S" DOES NOT IDENTIFY A LIVING INDIVIDUAL.

FOR RESTAURANT AND BAR SERVICES (U.S. CLS. 100 AND 101).

MATTHEW PAPPAS, EXAMINING ATTORNEY

CLASS 43—(Continued).

SN 78-688,183. THE AMERICAN JEWISH JOINT DISTRIBUTION COMMITTEE, INC., NEW YORK, NY. FILED 8-8-2005.

A joint effort, a jewish future.

THE MARK CONSISTS OF STANDARD CHARACTERS WITHOUT CLAIM TO ANY PARTICULAR FONT, STYLE, SIZE, OR COLOR.

NO CLAIM IS MADE TO THE EXCLUSIVE RIGHT TO USE "JEWISH", APART FROM THE MARK AS SHOWN.

FOR CHARITABLE SERVICES, NAMELY PROVIDING FOOD TO NEEDY PERSONS; PROVIDING TEMPORARY HOUSING ACCOMODATIONS (U.S. CLS. 100 AND 101).

SKYE YOUNG, EXAMINING ATTORNEY

SN 78-688,455. SAPA, INC., NEW YORK, NY. FILED 8-9-2005.

SAPA

THE MARK CONSISTS OF STANDARD CHARACTERS WITHOUT CLAIM TO ANY PARTICULAR FONT, STYLE, SIZE, OR COLOR.

FOR RESTAURANT AND BAR (U.S. CLS. 100 AND 101).

FIRST USE 2-15-2004; IN COMMERCE 2-15-2004.
KHANH LE, EXAMINING ATTORNEY

SN 78-690,828. O'CHARLEY'S MANAGEMENT COMPANY, INC., NASHVILLE, TN. FILED 8-11-2005.



OWNER OF U.S. REG. NOS. 1,788,688, 2,956,593 AND OTHERS.

FOR RESTAURANT SERVICES; RESTAURANT TAKE OUT SERVICE (U.S. CLS. 100 AND 101).

FIRST USE 6-16-2005; IN COMMERCE 6-16-2005.
ODESSA BIBBINS, EXAMINING ATTORNEY

CLASS 43—(Continued).

SN 78-694,482. OAKMOOR INC., WEST DES MOINES, IA.
FILED 8-17-2005.

COSMOPOLITAN LOUNGE

THE MARK CONSISTS OF STANDARD CHARACTERS
WITHOUT CLAIM TO ANY PARTICULAR FONT, STYLE,
SIZE, OR COLOR.

NO CLAIM IS MADE TO THE EXCLUSIVE RIGHT TO
USE "LOUNGE", APART FROM THE MARK AS SHOWN.

FOR BAR SERVICES; COCKTAIL LOUNGES (U.S.
CLS. 100 AND 101).

FIRST USE 11-1-2001; IN COMMERCE 11-1-2001.
SEAN CROWLEY, EXAMINING ATTORNEY

SN 78-701,485. RIVERA, MICHELLE, LOS ANGELES, CA.
FILED 8-26-2005.

CHATEAU MARMUTT

THE MARK CONSISTS OF STANDARD CHARACTERS
WITHOUT CLAIM TO ANY PARTICULAR FONT, STYLE,
SIZE, OR COLOR.

FOR DOG BOARDING SERVICES (U.S. CLS. 100 AND
101).

FIRST USE 8-0-1999; IN COMMERCE 8-0-1999.
MARC LEIPZIG, EXAMINING ATTORNEY

SN 78-707,377. FLAVOR SOLUTIONS, TEMECULA, CA.
FILED 9-6-2005.

FLAVOR PYRAMID

THE MARK CONSISTS OF STANDARD CHARACTERS
WITHOUT CLAIM TO ANY PARTICULAR FONT, STYLE,
SIZE, OR COLOR.

NO CLAIM IS MADE TO THE EXCLUSIVE RIGHT TO
USE "FLAVOR", APART FROM THE MARK AS SHOWN.

FOR PROVIDING INFORMATION IN THE FIELD OF
CULINARY ARTS, NAMELY, FLAVOR CONCEPTS
FEATURING EMOTIONAL PERCEPTIONS OF FOOD,
FOOD VISUAL APPEARANCE, TEXTURE, AROMAS
AND BASIC TASTES TO THE CONSUMER SEGMENT,
TRADE SEGMENT AND INDUSTRIAL SEGMENT OF
THE FOOD INDUSTRY (U.S. CLS. 100 AND 101).

FIRST USE 9-20-2005; IN COMMERCE 3-1-2006.
HOWARD SMIGA, EXAMINING ATTORNEY

CLASS 43—(Continued).

SN 78-720,168. THREE HEADED PRODUCTIONS, CHICA-
GO, IL. FILED 9-26-2005.

SALUD TEQUILA LOUNGE

THE MARK CONSISTS OF STANDARD CHARACTERS
WITHOUT CLAIM TO ANY PARTICULAR FONT, STYLE,
SIZE, OR COLOR.

NO CLAIM IS MADE TO THE EXCLUSIVE RIGHT TO
USE "TEQUILA LOUNGE", APART FROM THE MARK AS
SHOWN.

THE ENGLISH TRANSLATION OF THE WORD SALUD
IN THE MARK IS "TO TOAST OR DRINK TO GOOD
HEALTH".

FOR RESTAURANT AND BAR SERVICES (U.S. CLS.
100 AND 101).

ARETHA SOMERVILLE, EXAMINING ATTORNEY

SN 78-720,170. THREE HEADED PRODUCTIONS, CHICA-
GO, IL. FILED 9-26-2005.

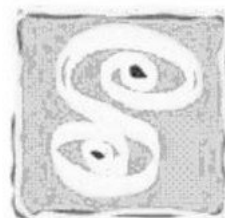

salud
tequila lounge

NO CLAIM IS MADE TO THE EXCLUSIVE RIGHT TO
USE "TEQUILA LOUNGE", APART FROM THE MARK AS
SHOWN.

THE ENGLISH TRANSLATION OF THE WORD SALUD
IN THE MARK IS TO TOAST OR DRINK TO GOOD
HEALTH.

FOR RESTAURANT AND BAR SERVICES (U.S. CLS.
100 AND 101).

CIMMERIAN COLEMAN, EXAMINING ATTORNEY

CLASS 43—(Continued).

SN 78-782,137. MR. GATTI'S, L.P., AUSTIN, TX. FILED 12-29-2005.



OWNER OF U.S. REG. NOS. 2,126,057, 2,810,201 AND OTHERS.
 NO CLAIM IS MADE TO THE EXCLUSIVE RIGHT TO USE "PIZZA", APART FROM THE MARK AS SHOWN.
 SEC. 2(F) AS TO "GATTI'S".
 FOR RESTAURANTS, CARRY-OUT RESTAURANTS AND RESTAURANTS FEATURING HOME DELIVERY SERVICES (U.S. CLS. 100 AND 101).
 FIRST USE 7-16-2005; IN COMMERCE 7-16-2005.
 TRACY CROSS, EXAMINING ATTORNEY

SN 78-782,241. MR. GATTI'S, L.P., AUSTIN, TX. FILED 12-29-2005.



OWNER OF U.S. REG. NOS. 2,126,057, 2,810,201 AND OTHERS.
 NO CLAIM IS MADE TO THE EXCLUSIVE RIGHT TO USE "PIZZA", APART FROM THE MARK AS SHOWN.
 THE COLOR(S) WHITE, ORANGE, TEAL AND BLACK IS/ ARE CLAIMED AS A FEATURE OF THE MARK.
 THE MARK CONSISTS OF THE WORDS GATTI'S PIZZA IN WHITE WITH BLACK SHADOWING, WITH AN ORANGE BACKDROP, AND A TEAL SIGN SILHOUETTE BEHIND THE WORDS.
 FOR RESTAURANTS, CARRY-OUT RESTAURANTS AND RESTAURANTS FEATURING HOME DELIVERY SERVICES (U.S. CLS. 100 AND 101).
 FIRST USE 7-16-2005; IN COMMERCE 7-16-2005.
 TRACY CROSS, EXAMINING ATTORNEY

SN 78-791,377. SENIZERGUES, PIERRE ANDRE, NEWPORT BEACH, CA. FILED 1-13-2006.

PAS PROJECT

THE MARK CONSISTS OF STANDARD CHARACTERS WITHOUT CLAIM TO ANY PARTICULAR FONT, STYLE, SIZE, OR COLOR.
 NO CLAIM IS MADE TO THE EXCLUSIVE RIGHT TO USE "PROJECT", APART FROM THE MARK AS SHOWN.
 FOR PROVISION OF CONFERENCE, EXHIBITION AND MEETING FACILITIES (U.S. CLS. 100 AND 101).
 DANNEAN HETZEL, EXAMINING ATTORNEY

CLASS 43—(Continued).

SN 78-792,266. SENIZERGUES, PIERRE ANDRE, NEWPORT BEACH, CA. FILED 1-16-2006.

PAS ECOSKATE HOUSE

THE MARK CONSISTS OF STANDARD CHARACTERS WITHOUT CLAIM TO ANY PARTICULAR FONT, STYLE, SIZE, OR COLOR.
 NO CLAIM IS MADE TO THE EXCLUSIVE RIGHT TO USE "HOUSE", APART FROM THE MARK AS SHOWN.
 FOR PROVISION OF CONFERENCE, EXHIBITION AND MEETING FACILITIES (U.S. CLS. 100 AND 101).
 DANNEAN HETZEL, EXAMINING ATTORNEY

SN 78-799,889. JOHN M HOGANCAMP, LEBANON, TN. FILED 1-26-2006.

Ribbons of Chocolate

THE MARK CONSISTS OF STANDARD CHARACTERS WITHOUT CLAIM TO ANY PARTICULAR FONT, STYLE, SIZE, OR COLOR.
 FOR FOOD PREPARATION; CATERING (U.S. CLS. 100 AND 101).
 FIRST USE 1-1-2003; IN COMMERCE 1-1-2003.
 JEFF DEFORD, EXAMINING ATTORNEY

SN 78-803,550. E.C. ICE CREAM, LLC, SOUTH MILLS, NC. FILED 1-31-2006.

Nu Quality Ice Cream

THE MARK CONSISTS OF STANDARD CHARACTERS WITHOUT CLAIM TO ANY PARTICULAR FONT, STYLE, SIZE, OR COLOR.
 NO CLAIM IS MADE TO THE EXCLUSIVE RIGHT TO USE "QUALITY ICE CREAM", APART FROM THE MARK AS SHOWN.
 FOR RESTAURANT SERVICES (U.S. CLS. 100 AND 101).
 FIRST USE 1-1-1960; IN COMMERCE 1-1-1960.
 CYNTHIA SLOAN, EXAMINING ATTORNEY

CLASS 43—(Continued).

SN 78-812,128. VINUNICI, LLC, LEWISVILLE, TX. FILED 2-10-2006.

unique wines . . . from
the road less traveled

THE MARK CONSISTS OF STANDARD CHARACTERS WITHOUT CLAIM TO ANY PARTICULAR FONT, STYLE, SIZE, OR COLOR.

NO CLAIM IS MADE TO THE EXCLUSIVE RIGHT TO USE "WINES", APART FROM THE MARK AS SHOWN.

FOR PROVIDING INFORMATION ABOUT WINE CHARACTERISTICS (U.S. CLS. 100 AND 101).

FIRST USE 1-25-2006; IN COMMERCE 1-25-2006.
LAURIE KAUFMAN, EXAMINING ATTORNEY

SN 78-813,774. VIEWEUROPE.COM INCORPORATED, DBA INSTYLE HOTELS, MOUNT KISCO, NY. FILED 2-13-2006.

INSTYLE
HOTELS

NO CLAIM IS MADE TO THE EXCLUSIVE RIGHT TO USE "HOTELS", APART FROM THE MARK AS SHOWN.

FOR GLOBAL HOTEL RESERVATION BOOKING SERVICES FOR BOUTIQUE AND DESIGN HOTELS, VIA A WEBSITE (U.S. CLS. 100 AND 101).

SANI KHOURI, EXAMINING ATTORNEY

SN 78-820,785. ALUMNI HOUSE, INC., RIDGELAND, MS. FILED 2-22-2006.

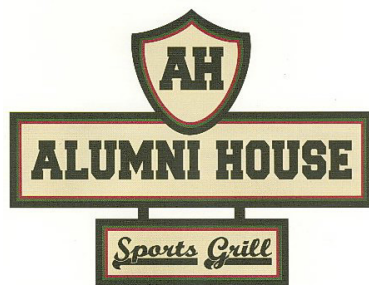

NO CLAIM IS MADE TO THE EXCLUSIVE RIGHT TO USE "SPORTS GRILL", APART FROM THE MARK AS SHOWN.

THE COLOR(S) BLACK, GREEN, RED AND IVORY IS/ ARE CLAIMED AS A FEATURE OF THE MARK.

THE MARK CONSISTS OF A SHIELD-TYPE FIGURE OUTLINED IN BLACK. INSIDE THE BLACK LINE IS LINED WITH GREEN, INSIDE THE GREEN LINE IS LINED WITH RED, BACKGROUND OF EMBLEM IS IVORY AND THE LETTERS AH ARE CENTERED IN THE EMBLEM IN BLACK. A RECTANGLE BANNER IS ATTACHED TO THE EMBLEM AND BELOW THE EMBLEM AND IS OUTLINED IN BLACK, THE LINE INSIDE THE BLACK LINE IS

CLASS 43—(Continued).

GREEN, THE LINE INSIDE THE GREEN LINE IS RED, THE BACKGROUND IS IVORY AND THE WORDS ALUMNI HOUSE ARE CENTERED AND ARE BLACK. BELOW THE RECTANGLE HANGS A SMALLER RECTANGLE BANNER ATTACHED BY TWO BLACK LINES, THE SMALLER BANNER IS OUTLINED IN BLACK, INSIDE THE BLACK LINE IS A GREEN LINE, INSIDE THE GREEN LINE IS A RED LINE, THE BACKGROUND IS IVORY AND IN THE CENTER OF THE SMALLER BANNER ARE THE WORDS "SPORTS GRILL" IN ITALICS AND IN BLACK.

FOR RESTAURANT AND BAR SERVICES (U.S. CLS. 100 AND 101).

FIRST USE 2-13-2006; IN COMMERCE 2-13-2006.
CHRIS WELLS, EXAMINING ATTORNEY

SN 78-823,898. ONE SCOTTSDALE HOLDINGS LLC, SCOTTSDALE, AZ. FILED 2-27-2006.



ONE SCOTTSDALE

NO CLAIM IS MADE TO THE EXCLUSIVE RIGHT TO USE "SCOTTSDALE", APART FROM THE MARK AS SHOWN.

FOR HEALTH RESORT SERVICES, NAMELY, PROVIDING FOOD AND LODGING THAT SPECIALIZE IN PROMOTING PATRONS' GENERAL HEALTH AND WELL-BEING; SPA SERVICES, NAMELY, PROVIDING TEMPORARY ACCOMMODATIONS AND MEALS TO CLIENTS OF A HEALTH OR BEAUTY SPA (U.S. CLS. 100 AND 101).

CAROLYN CATALDO, EXAMINING ATTORNEY

SN 78-825,525. GNLV CORP., LAS VEGAS, NV. FILED 2-28-2006.

LILLIE'S NOODLE HOUSE

THE MARK CONSISTS OF STANDARD CHARACTERS WITHOUT CLAIM TO ANY PARTICULAR FONT, STYLE, SIZE, OR COLOR.

NO CLAIM IS MADE TO THE EXCLUSIVE RIGHT TO USE "NOODLE HOUSE", APART FROM THE MARK AS SHOWN.

FOR RESTAURANT, BAR AND LOUNGE SERVICES (U.S. CLS. 100 AND 101).

FIRST USE 2-17-2006; IN COMMERCE 2-17-2006.
BERYL GARDNER, EXAMINING ATTORNEY

CLASS 43—(Continued).

SN 78-827,314. CAPTAIN D'S HOLDINGS, INC., NASHVILLE, TN. FILED 3-2-2006.



OWNER OF U.S. REG. NOS. 1,029,629, 1,661,241 AND 2,558,642.

NO CLAIM IS MADE TO THE EXCLUSIVE RIGHT TO USE "EST. 1969" AND "SEAFOOD KITCHEN", APART FROM THE MARK AS SHOWN.

THE MARK CONSISTS OF A STYLIZED IMAGE OF A FISH AND WATER, AND THE WORDING "CAPTAIN D'S SEAFOOD KITCHEN EST. 1969".

FOR RESTAURANT SERVICES (U.S. CLS. 100 AND 101).

FIRST USE 8-14-2006; IN COMMERCE 8-14-2006.
JENNIFER KRISP, EXAMINING ATTORNEY

SN 78-834,322. CHIRNOMULA, PRASAD, RIDGEFIELD, CT. FILED 3-10-2006.

Thali

NO CLAIM IS MADE TO THE EXCLUSIVE RIGHT TO USE "THALI", APART FROM THE MARK AS SHOWN.

THE TERM "THALI" HAS NO DIRECT TRANSLATION IN ENGLISH. IT IS AN INDIAN MEAL WHOSE CONTENTS VARY FROM ONE REGIONAL CUISINE TO ANOTHER.

FOR RESTAURANT, BAR AND COCKTAIL LOUNGE SERVICES, SPECIALIZING IN REGIONAL CUISINES OF INDIA (U.S. CLS. 100 AND 101).

FIRST USE 5-31-2001; IN COMMERCE 6-30-2003.
CARYN GLASSER, EXAMINING ATTORNEY

CLASS 43—(Continued).

SN 78-835,403. PROHOTEL MANAGEMENT, INC., HOUSTON, TX. FILED 3-13-2006.

Hotel Esencia

THE MARK CONSISTS OF STANDARD CHARACTERS WITHOUT CLAIM TO ANY PARTICULAR FONT, STYLE, SIZE, OR COLOR.

NO CLAIM IS MADE TO THE EXCLUSIVE RIGHT TO USE "HOTEL", APART FROM THE MARK AS SHOWN.

THE FOREIGN WORDING IN THE MARK TRANSLATES INTO ENGLISH AS ESSENCE HOTEL.

FOR HOTELS, RESORT HOTELS, HOTEL SERVICES FOR PREFERRED CUSTOMERS, MAKING HOTEL RESERVATIONS FOR OTHERS, HEALTH RESORT SERVICES, NAMELY, PROVIDING FOOD AND LODGING THAT SPECIALIZE IN PROMOTING PATRONS' GENERAL HEALTH AND WELL-BEING, RESTAURANTS AND BAR SERVICES (U.S. CLS. 100 AND 101).

FIRST USE 1-10-2006; IN COMMERCE 1-10-2006.
MARK SPARACINO, EXAMINING ATTORNEY

SN 78-839,555. 1300 SEASIDE INC., REDONDO BEACH, CA. FILED 3-16-2006.

OLÉ FIREGRILLED FRESHMEX

THE MARK CONSISTS OF STANDARD CHARACTERS WITHOUT CLAIM TO ANY PARTICULAR FONT, STYLE, SIZE, OR COLOR.

NO CLAIM IS MADE TO THE EXCLUSIVE RIGHT TO USE "FIREGRILLED FRESHMEX", APART FROM THE MARK AS SHOWN.

FOR RESTAURANT SERVICES (U.S. CLS. 100 AND 101).

FIRST USE 7-12-2005; IN COMMERCE 7-12-2005.
AMY MCMENAMIN, EXAMINING ATTORNEY

SN 78-845,857. PET SOCIAL CLUB AND HOTEL, INC., FREMONT, CA. FILED 3-24-2006.

PET SOCIAL CLUB

THE MARK CONSISTS OF STANDARD CHARACTERS WITHOUT CLAIM TO ANY PARTICULAR FONT, STYLE, SIZE, OR COLOR.

NO CLAIM IS MADE TO THE EXCLUSIVE RIGHT TO USE PET, APART FROM THE MARK AS SHOWN.

FOR PET BOARDING SERVICES; PET DAY CARE SERVICES (U.S. CLS. 100 AND 101).

FRED CARL, EXAMINING ATTORNEY

CLASS 43—(Continued).

SN 78-845,991. FIRST CLASS MEALS, INC., COLORADO SPRINGS, CO. FILED 3-24-2006.



NO CLAIM IS MADE TO THE EXCLUSIVE RIGHT TO USE "FIRST CLASS MEALS", APART FROM THE MARK AS SHOWN.

THE COLOR(S) GOLD, BLUE AND YELLOW IS/ARE CLAIMED AS A FEATURE OF THE MARK.

THE MARK CONSISTS OF A BLUE AIRPLANE SURROUNDED BY A GOLD STYLIZED PLATE WITH BLUE TRIM, WITH A GOLD CURVE TO THE LEFT DOWN TO THE WORD "FIRST" WHICH IS ALSO IN GOLD AND BOTH THE CURVE AND THE WORD ARE OUTLINED IN THE COLOR BLUE. THE WORDS "CLASS MEALS" APPEAR IN THE COLOR BLUE AND IS SET DIRECTLY BELOW THE WORDS FIRST. THE PHRASE "EXPECT A GREAT MEAL WHEN YOU FLY" IS SET BELOW THE WORDS "CLASS MEALS" AND IS IN THE COLORS GOLD AND YELLOW.

FOR PROVIDING IN-FLIGHT MEAL SERVICES IN AN AIRPLANE (U.S. CLS. 100 AND 101).
MICHAEL LEWIS, EXAMINING ATTORNEY

CLASS 43—(Continued).

SN 78-848,146. BUFFET PARTNERS, L.P., PLANO, TX. FILED 3-28-2006.

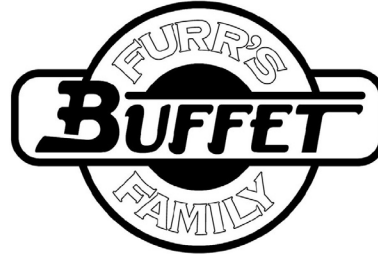

OWNER OF U.S. REG. NOS. 1,129,705, 1,878,073 AND OTHERS.

NO CLAIM IS MADE TO THE EXCLUSIVE RIGHT TO USE "FAMILY BUFFET", APART FROM THE MARK AS SHOWN.

THE MARK CONSISTS OF THE WORD BUFFET IN STYLIZED FORM WITH THE WORD FURR'S ABOVE IT AND THE WORD FAMILY BELOW IT IN A CIRCULAR FASHION WITH A LINE OUTLINING THE LOGO.

FOR RESTAURANT SERVICES (U.S. CLS. 100 AND 101).

FIRST USE 6-1-2000; IN COMMERCE 6-1-2000.
JASON ROTH, EXAMINING ATTORNEY

SN 78-846,388. BARNHILL'S BUFFET, INC., MADISON, TN. FILED 3-26-2006.



UNLIMITED SELECTIONS... ONE LOW PRICE!

OWNER OF U.S. REG. NOS. 2,355,314, 3,116,976 AND OTHERS.

NO CLAIM IS MADE TO THE EXCLUSIVE RIGHT TO USE "SALADS BUFFET CATERING" OR "ONE LOW PRICE!", APART FROM THE MARK AS SHOWN.

THE COLORS RED, WHITE, GREEN, YELLOW AND BLACK ARE CLAIMED AS FEATURES OF THE MARK.

THE COLOR RED APPEARS IN THE BACKGROUND OF THE WORDING BARNHILL'S AND ONE LOW PRICE!, IN THE WORDING UNLIMITED SELECTIONS AND THE BARN; THE COLOR WHITE APPEARS IN THE WORDING BARNHILL'S AND THE BACKGROUND OF THE WORDING UNLIMITED SELECTIONS; THE COLOR GREEN APPEARS IN THE BACKGROUND OF THE WORDING SALADS . BUFFET . CATERING; THE COLOR YELLOW APPEARS IN THE WORDING SALADS . BUFFET . CATERING. THE OUTLINE OF THE BANNER AND THE WINDOWS; THE COLOR BLACK APPEARS IN THE ROOSTER, THE OUTLINE OF THE ELEMENTS AND THE SHADOW.

FOR RESTAURANT SERVICES (U.S. CLS. 100 AND 101).
FIRST USE 9-21-2005; IN COMMERCE 9-21-2005.
LEIGH LOWRY, EXAMINING ATTORNEY

SN 78-848,154. BUFFET PARTNERS, L.P., PLANO, TX. FILED 3-28-2006.

FURR'S FRESH BUFFET

THE MARK CONSISTS OF STANDARD CHARACTERS WITHOUT CLAIM TO ANY PARTICULAR FONT, STYLE, SIZE, OR COLOR.

OWNER OF U.S. REG. NOS. 1,129,705, 1,878,073 AND OTHERS.

NO CLAIM IS MADE TO THE EXCLUSIVE RIGHT TO USE "FRESH BUFFET", APART FROM THE MARK AS SHOWN.

FOR RESTAURANT SERVICES (U.S. CLS. 100 AND 101).

FIRST USE 2-15-2003; IN COMMERCE 2-15-2003.
JASON ROTH, EXAMINING ATTORNEY

CLASS 43—(Continued).

SN 78-848,159. BUFFET PARTNERS, L.P., PLANO, TX.
FILED 3-28-2006.



OWNER OF U.S. REG. NOS. 1,129,705, 1,878,073 AND OTHERS.

NO CLAIM IS MADE TO THE EXCLUSIVE RIGHT TO USE "FRESH BUFFET", APART FROM THE MARK AS SHOWN.

FOR RESTAURANT SERVICES (U.S. CLS. 100 AND 101).

FIRST USE 6-16-2004; IN COMMERCE 6-16-2004.
JASON ROTH, EXAMINING ATTORNEY

SN 78-848,164. BUFFET PARTNERS, L.P., PLANO, TX.
FILED 3-28-2006.

FURR'S FAMILY BUFFET

THE MARK CONSISTS OF STANDARD CHARACTERS WITHOUT CLAIM TO ANY PARTICULAR FONT, STYLE, SIZE, OR COLOR.

OWNER OF U.S. REG. NOS. 1,129,705, 1,878,073 AND OTHERS.

NO CLAIM IS MADE TO THE EXCLUSIVE RIGHT TO USE "FAMILY BUFFET", APART FROM THE MARK AS SHOWN.

SEC. 2(F) AS TO "FURR'S",
FOR RESTAURANT SERVICES (U.S. CLS. 100 AND 101).

FIRST USE 6-1-2000; IN COMMERCE 6-1-2000.
JASON ROTH, EXAMINING ATTORNEY

CLASS 43—(Continued).

SN 78-853,305. U.S. RESTAURANTS CORPORATION, ARDEN HILLS, MN. FILED 4-4-2006.

EATING FIT!

THE MARK CONSISTS OF STANDARD CHARACTERS WITHOUT CLAIM TO ANY PARTICULAR FONT, STYLE, SIZE, OR COLOR.

FOR RESTAURANT SERVICES (U.S. CLS. 100 AND 101).

FIRST USE 1-21-2004; IN COMMERCE 1-21-2004.
BARBARA RUTLAND, EXAMINING ATTORNEY

SN 78-853,948. SFO*MEDIA LLC, BOSTON, MA. FILED 4-4-2006.



FOR PROVIDING INFORMATION, REVIEWS, AND STORIES CONCERNING HOTELS AROUND THE WORLD (U.S. CLS. 100 AND 101).

FIRST USE 10-30-2003; IN COMMERCE 10-30-2003.
TRACY CROSS, EXAMINING ATTORNEY

SN 78-854,471. CARIBCO SHRIMP CORPORATION, AVEN-
TURA, FL. FILED 4-5-2006.

SHRIMP MARKET

THE MARK CONSISTS OF STANDARD CHARACTERS WITHOUT CLAIM TO ANY PARTICULAR FONT, STYLE, SIZE, OR COLOR.

NO CLAIM IS MADE TO THE EXCLUSIVE RIGHT TO USE "SHRIMP", APART FROM THE MARK AS SHOWN.

FOR RESTAURANT SERVICES (U.S. CLS. 100 AND 101).

NORA BUCHANAN WILL, EXAMINING ATTORNEY

CLASS 43—(Continued).

SN 78-855,972. BRINKER INTERNATIONAL HOLDINGS, L.P., DALLAS, TX. FILED 4-6-2006.



OWNER OF U.S. REG. NOS. 2,093,049, 2,680,174 AND OTHERS.

THE COLOR(S) RED AND GREEN IS/ARE CLAIMED AS A FEATURE OF THE MARK.

THE MARK CONSISTS OF A PEPPER DESIGN. THE PEPPER BODY IS CLAIMED IN THE COLOR RED. THE LETTER S, THE PEPPER STEM AND LEAF CAP OF THE PEPPER LOGO ARE CLAIMED IN THE COLOR GREEN.

FOR RESTAURANT, BAR AND CATERING SERVICES (U.S. CLS. 100 AND 101).

FIRST USE 3-1-2001; IN COMMERCE 3-1-2001.
KATHERINE STOIDES, EXAMINING ATTORNEY

SN 78-856,268. HIOTIS, STELIOS, BAY SHORE, NY. FILED 4-7-2006.

salad head

THE MARK CONSISTS OF STANDARD CHARACTERS WITHOUT CLAIM TO ANY PARTICULAR FONT, STYLE, SIZE, OR COLOR.

NO CLAIM IS MADE TO THE EXCLUSIVE RIGHT TO USE "SALAD", APART FROM THE MARK AS SHOWN.

FOR SALAD BARS (U.S. CLS. 100 AND 101).
HEATHER THOMPSON, EXAMINING ATTORNEY

SN 78-856,419. ALL SAINTS' ALL DAY CHILD CARE CENTER, INC., CHEVY CHASE, MD. FILED 4-7-2006.

WONDERS CHILD CARE CENTER

THE MARK CONSISTS OF STANDARD CHARACTERS WITHOUT CLAIM TO ANY PARTICULAR FONT, STYLE, SIZE, OR COLOR.

NO CLAIM IS MADE TO THE EXCLUSIVE RIGHT TO USE "CHILD CARE CENTER", APART FROM THE MARK AS SHOWN.

FOR CHILD CARE SERVICES; DAY CARE CENTERS (U.S. CLS. 100 AND 101).
MARILYN IZZI, EXAMINING ATTORNEY

CLASS 43—(Continued).

SN 78-856,420. ROMIO'S OF CALIFORNIA, INC., CALABASAS, CA. FILED 4-7-2006.



THE COLORS RED, GREEN, YELLOW, BLACK, WHITE, AND GRAY ARE CLAIMED AS A FEATURE OF THE MARK.

THE COLOR RED APPEARS IN THE CHEF'S HAT AND SCARF, AND ON THE PIZZA. THE COLORS GREEN AND YELLOW APPEAR ON THE PIZZA. THE CHEF IS OUTLINED IN BLACK, AND THE COLOR BLACK APPEARS IN THE CHEF'S HAIR AND FACIAL HAIR, THE PIZZA TRAY, AND THE LARGE CIRCLE BEHIND THE CHEF. THE COLOR WHITE APPEARS ON THE CHEF'S CLOTHING, SKIN, AND HAT, AND INSIDE THE LARGE CIRCLE. THE COLOR GRAY APPEARS IN THE STEAM RISING FROM THE PIZZA. THE MARK APPEARS ON A TRANSPARENT BACKGROUND, AND NO OTHER COLOR IS CLAIMED AS A FEATURE OF THE MARK.

FOR RESTAURANT SERVICES AND RESTAURANTS FEATURING HOME DELIVERY (U.S. CLS. 100 AND 101).

FIRST USE 9-2-2004; IN COMMERCE 9-2-2004.
DAVID MILLER, EXAMINING ATTORNEY

SN 78-856,423. ALL SAINTS' ALL DAY CHILD CARE CENTER, INC., CHEVY CHASE, MD. FILED 4-7-2006.



NO CLAIM IS MADE TO THE EXCLUSIVE RIGHT TO USE "CHILD CARE CENTER", APART FROM THE MARK AS SHOWN.

FOR CHILD CARE SERVICES; DAY CARE CENTERS (U.S. CLS. 100 AND 101).
MARILYN IZZI, EXAMINING ATTORNEY

CLASS 43—(Continued).

SN 78-856,443. BRINKER INTERNATIONAL HOLDINGS, L.P., DALLAS, TX. FILED 4-7-2006.



OWNER OF U.S. REG. NOS. 2,093,049, 2,680,174 AND OTHERS.

THE COLOR(S) GREEN AND RED IS/ARE CLAIMED AS A FEATURE OF THE MARK.

THE MARK CONSISTS OF A PEPPER DESIGN. THE PEPPER BODY AND LETTER S ARE CLAIMED IN THE COLOR RED. THE PEPPER STEM AND LEAF CAP OF THE PEPPER LOGO ARE CLAIMED IN THE COLOR GREEN.

FOR RESTAURANT, BAR AND CATERING SERVICES (U.S. CLS. 100 AND 101).

FIRST USE 3-1-2001; IN COMMERCE 3-1-2001.

KATHERINE STOIDES, EXAMINING ATTORNEY

SN 78-857,640. DUCK'S DRIVE IN, INC., DBA GENE'S AND JUDE'S, RIVER GROVE, IL. FILED 4-10-2006.

GENE'S & JUDE'S

THE MARK CONSISTS OF STANDARD CHARACTERS WITHOUT CLAIM TO ANY PARTICULAR FONT, STYLE, SIZE, OR COLOR.

FOR RESTAURANT SERVICES (U.S. CLS. 100 AND 101).

FIRST USE 0-0-1951; IN COMMERCE 0-0-1951.

GEORGE LORENZO, EXAMINING ATTORNEY

SN 78-858,501. MERROTICA'S COFFEE CAFE, STUART, FL. FILED 4-11-2006.

MERROTICA'S COFFEE CAFE

THE MARK CONSISTS OF STANDARD CHARACTERS WITHOUT CLAIM TO ANY PARTICULAR FONT, STYLE, SIZE, OR COLOR.

NO CLAIM IS MADE TO THE EXCLUSIVE RIGHT TO USE "COFFEE CAFE", APART FROM THE MARK AS SHOWN.

FOR RESTAURANT SERVICES FEATURING COFFEE (U.S. CLS. 100 AND 101).

FIRST USE 2-1-2006; IN COMMERCE 2-1-2006.

JESSICA A. POWERS, EXAMINING ATTORNEY

CLASS 43—(Continued).

SN 78-858,601. FAT DOG ENTERPRISES, LLC, WASHINGTON, DC. FILED 4-11-2006.

Build a Better Dog!

THE MARK CONSISTS OF STANDARD CHARACTERS WITHOUT CLAIM TO ANY PARTICULAR FONT, STYLE, SIZE, OR COLOR.

FOR RESTAURANT SERVICES (U.S. CLS. 100 AND 101).

FIRST USE 4-4-2005; IN COMMERCE 4-4-2005.

MARY ROSSMAN, EXAMINING ATTORNEY

SN 78-859,880. COYOTE JOE'S COFFEE COMPANY, NEWBERG, OR. FILED 4-12-2006.

COYOTE JOE'S COFFEE

THE MARK CONSISTS OF STANDARD CHARACTERS WITHOUT CLAIM TO ANY PARTICULAR FONT, STYLE, SIZE, OR COLOR.

NO CLAIM IS MADE TO THE EXCLUSIVE RIGHT TO USE "COFFEE", APART FROM THE MARK AS SHOWN.

FOR COFFEE-HOUSE AND SNACK-BAR SERVICES (U.S. CLS. 100 AND 101).

FIRST USE 6-1-2005; IN COMMERCE 6-1-2005.

DAVID MILLER, EXAMINING ATTORNEY

SN 78-859,889. COYOTE JOE'S COFFEE COMPANY, NEWBERG, OR. FILED 4-12-2006.

COYOTE JOE'S

THE MARK CONSISTS OF STANDARD CHARACTERS WITHOUT CLAIM TO ANY PARTICULAR FONT, STYLE, SIZE, OR COLOR.

FOR RESTAURANT SERVICES (U.S. CLS. 100 AND 101).

FIRST USE 6-1-2005; IN COMMERCE 6-1-2005.

DAVID MILLER, EXAMINING ATTORNEY

CLASS 43—(Continued).

SN 78-860,438. SUSHI RUNNER CORP, DORAL, FL. FILED 4-12-2006.



NO CLAIM IS MADE TO THE EXCLUSIVE RIGHT TO USE "CHICKEN" AND "CHOPPED CHICKEN", APART FROM THE MARK AS SHOWN.

THE APPLICANT CLAIMS COLOR AS A FEATURE OF THE MARK, NAMELY, RED, ORANGE, YELLOW AND WHITE.

THE COLOR RED APPEARS IN THE WORDING CHICKEN RUNNER AND CHOPPED CHICKEN, AND ON THE STYLIZED COMB OF THE EGG. THE COLOR ORANGE APPEARS IN THE OUTLINE OF THE WORDS CHOPPED CHICKEN AND IN THE OUTLINE OF THE STYLIZED COMB OF THE EGG. THE COLOR YELLOW APPEARS IN THE LEGS OF THE EGG. THE COLOR WHITE APPEARS IN THE BODY OF THE EGG.

THE MARK CONSISTS OF AN RUNNING WHITE EGG WITH YELLOW LEGS, WITH THE WORDS "CHICKEN RUNNER" AND "CHOPPED CHICKEN" IN RED, SPLASHED OVER THE EGG.

FOR CAFE-RESTAURANTS; CARRY-OUT RESTAURANTS; DELICATESSENS ; FAST FOOD AND NON-STOP RESTAURANT SERVICES; FAST-FOOD RESTAURANTS; FAST-FOOD RESTAURANTS AND SNACK-BARS; HOTEL, BAR AND RESTAURANT SERVICES; PROVIDING ONLINE REVIEWS OF RESTAURANTS AND HOTELS; RESERVATION OF RESTAURANTS; RESTAURANT AND BAR SERVICES; RESTAURANT SERVICES; RESTAURANTS; RESTAURANTS FEATURING HOME DELIVERY; SELF SERVICE RESTAURANTS; SELF-SERVICE RESTAURANTS; TAKE-OUT RESTAURANT SERVICES; TRAVEL AGENCY SERVICES, NAMELY, MAKING RESERVATIONS AND BOOKINGS FOR RESTAURANTS AND MEALS (U.S. CLS. 100 AND 101).

DAVID TAYLOR, EXAMINING ATTORNEY

SN 78-860,671. MDR ENTERPRISE, INC., MILWAUKEE, WI. FILED 4-13-2006.

PIZZAWAY

THE MARK CONSISTS OF STANDARD CHARACTERS WITHOUT CLAIM TO ANY PARTICULAR FONT, STYLE, SIZE, OR COLOR.

FOR RESTAURANT SERVICES (U.S. CLS. 100 AND 101).

KATRINA EDGE, EXAMINING ATTORNEY

CLASS 43—(Continued).

SN 78-860,780. HABANA HOLDINGS, LLC, BROOKLYN, NY. FILED 4-13-2006.

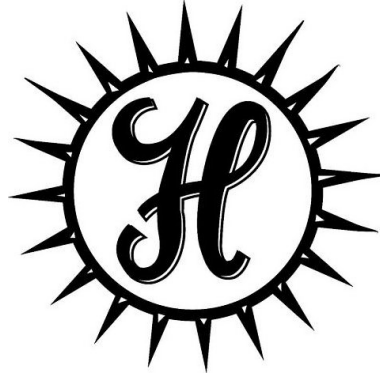

FOR RESTAURANTS (U.S. CLS. 100 AND 101).
FIRST USE 1-1-1998; IN COMMERCE 1-1-1998.
BERNICE HOWSE, EXAMINING ATTORNEY

SN 78-860,988. AFTER MIDNIGHT MANAGEMENT COMPANY, LP, NEW YORK, NY. FILED 4-13-2006.

MIDNIGHT COWBOY

THE MARK CONSISTS OF STANDARD CHARACTERS WITHOUT CLAIM TO ANY PARTICULAR FONT, STYLE, SIZE, OR COLOR.

FOR BAR AND RESTAURANTS (U.S. CLS. 100 AND 101).

DEBRA LEE, EXAMINING ATTORNEY

SN 78-861,308. LARKSPUR HOTELS, LLC, CORTE MADERA, CA. FILED 4-13-2006.

CASA MUNRAS

THE MARK CONSISTS OF STANDARD CHARACTERS WITHOUT CLAIM TO ANY PARTICULAR FONT, STYLE, SIZE, OR COLOR.

NO CLAIM IS MADE TO THE EXCLUSIVE RIGHT TO USE "CASA", APART FROM THE MARK AS SHOWN.

THE ENGLISH TRANSLATION OF THE WORD CASA IN THE MARK IS HOUSE.

FOR HOTELS; PROVIDING TEMPORARY HOUSING ACCOMMODATIONS (U.S. CLS. 100 AND 101).

FIRST USE 0-0-1941; IN COMMERCE 0-0-1941.

LINDA ESTRADA, EXAMINING ATTORNEY

CLASS 43—(Continued).

SN 78-862,488. BRINKER INTERNATIONAL HOLDINGS, L.P., DALLAS, TX. FILED 4-17-2006.



OWNER OF U.S. REG. NOS. 2,093,049, 2,680,174 AND OTHERS.

NO CLAIM IS MADE TO THE EXCLUSIVE RIGHT TO USE MARGARITA BAR, APART FROM THE MARK AS SHOWN.

FOR RESTAURANT, BAR AND CATERING SERVICES (U.S. CLS. 100 AND 101).

FIRST USE 2-1-2005; IN COMMERCE 2-1-2005.

KATHERINE STOIDES, EXAMINING ATTORNEY

CLASS 43—(Continued).

SN 78-864,160. WALIN, ROBERT R., SAN DIEGO, CA. FILED 4-18-2006.

THE SHOUT! HOUSE

THE MARK CONSISTS OF STANDARD CHARACTERS WITHOUT CLAIM TO ANY PARTICULAR FONT, STYLE, SIZE, OR COLOR.

FOR RESTAURANT AND BAR SERVICES (U.S. CLS. 100 AND 101).

FIRST USE 3-24-2004; IN COMMERCE 3-24-2004.

ODESSA BIBBINS, EXAMINING ATTORNEY

SN 78-863,037. PANINOTECA ITALIANA CORP., WILLISTON PARK, NY. FILED 4-17-2006.

FIANCI'S

THE MARK CONSISTS OF STANDARD CHARACTERS WITHOUT CLAIM TO ANY PARTICULAR FONT, STYLE, SIZE, OR COLOR.

THE NAME(S), PORTRAIT(S), AND/OR SIGNATURE(S) SHOWN IN THE MARK DOES NOT IDENTIFY A PARTICULAR LIVING INDIVIDUAL.

FOR CAFES; CARRY-OUT RESTAURANTS; CATERING; DELICATESSENS; FOOD PREPARATION; PREPARATION OF FOOD AND BEVERAGES; RESTAURANTS; SALAD BARS; SERVING OF FOOD AND DRINK/BEVERAGES; SNACK BARS; TAKE-OUT RESTAURANT SERVICES (U.S. CLS. 100 AND 101).

TARAH HARDY, EXAMINING ATTORNEY

SN 78-864,400. WHG TM CORP., LAS VEGAS, NV. FILED 4-19-2006.

KNIGHTS INN & SUITES

THE MARK CONSISTS OF STANDARD CHARACTERS WITHOUT CLAIM TO ANY PARTICULAR FONT, STYLE, SIZE, OR COLOR.

OWNER OF U.S. REG. NOS. 1,150,070, 1,962,870 AND OTHERS.

NO CLAIM IS MADE TO THE EXCLUSIVE RIGHT TO USE "INN & SUITES", APART FROM THE MARK AS SHOWN.

FOR HOTELS; MAKING HOTEL RESERVATIONS FOR OTHERS; MOTELS (U.S. CLS. 100 AND 101).

PATRICIA EVANKO, EXAMINING ATTORNEY

SN 78-864,081. SURLY WENCH PUB, INC., TUCSON, AZ. FILED 4-18-2006.

Surly Wench Pub

THE MARK CONSISTS OF STANDARD CHARACTERS WITHOUT CLAIM TO ANY PARTICULAR FONT, STYLE, SIZE, OR COLOR.

NO CLAIM IS MADE TO THE EXCLUSIVE RIGHT TO USE "PUB", APART FROM THE MARK AS SHOWN.

FOR BAR SERVICES (U.S. CLS. 100 AND 101).

FIRST USE 3-9-2004; IN COMMERCE 3-9-2004.

GRETTA YAO, EXAMINING ATTORNEY

SN 78-864,984. BOOT CONSULTING COMPANY, INC., MILL VALLEY, CA. FILED 4-19-2006.

Intimi

THE MARK CONSISTS OF STANDARD CHARACTERS WITHOUT CLAIM TO ANY PARTICULAR FONT, STYLE, SIZE, OR COLOR.

FOR CAFE-RESTAURANTS; COFFEE SHOPS; RESTAURANT AND BAR SERVICES; WINE BARS (U.S. CLS. 100 AND 101).

PAULA MAYS, EXAMINING ATTORNEY

CLASS 43—(Continued).

SN 78-865,125. S.T. MANAGEMENT GROUP, INC., NEW YORK, NY. FILED 4-19-2006.

METROMARCHÉ

THE MARK CONSISTS OF STANDARD CHARACTERS WITHOUT CLAIM TO ANY PARTICULAR FONT, STYLE, SIZE, OR COLOR.

FOR RESTAURANT, BAR, CATERING AND TAKE-OUT FOOD SERVICES (U.S. CLS. 100 AND 101).
STANLEY I. OSBORNE, EXAMINING ATTORNEY

SN 78-866,320. DIBRI INC., DBA- CREPE CONNECTION CAFE, MIAMI, FL. FILED 4-20-2006.

Crepe Connection Cafe

THE MARK CONSISTS OF STANDARD CHARACTERS WITHOUT CLAIM TO ANY PARTICULAR FONT, STYLE, SIZE, OR COLOR.

NO CLAIM IS MADE TO THE EXCLUSIVE RIGHT TO USE "CREPE" OR "CAFE", APART FROM THE MARK AS SHOWN.

FOR CATERING; RESTAURANTS (U.S. CLS. 100 AND 101).

FIRST USE 10-30-2005; IN COMMERCE 10-30-2005.
ELIZABETH PIGNATELLO, EXAMINING ATTORNEY

SN 78-867,746. OS ASSET, INC., TAMPA, FL. FILED 4-24-2006.

No Worries

THE MARK CONSISTS OF STANDARD CHARACTERS WITHOUT CLAIM TO ANY PARTICULAR FONT, STYLE, SIZE, OR COLOR.

FOR CARRY-OUT RESTAURANTS; RESTAURANT SERVICES; RESTAURANTS (U.S. CLS. 100 AND 101).
JIM RINGLE, EXAMINING ATTORNEY

CLASS 43—(Continued).

SN 78-868,847. ONE HUNDRED PERCENT SOUL FOODS, LLC., NEWTONVILLE, MA. FILED 4-25-2006.

100% SOUL FOODS

THE MARK CONSISTS OF STANDARD CHARACTERS WITHOUT CLAIM TO ANY PARTICULAR FONT, STYLE, SIZE, OR COLOR.

NO CLAIM IS MADE TO THE EXCLUSIVE RIGHT TO USE "SOUL FOODS", APART FROM THE MARK AS SHOWN.

FOR RESTAURANT SERVICES (U.S. CLS. 100 AND 101).

FIRST USE 3-24-2006; IN COMMERCE 3-24-2006.
KATRINA EDGE, EXAMINING ATTORNEY

SN 78-868,936. CREAMA, LLC, NORWALK, CA. FILED 4-25-2006.

Creama

THE MARK CONSISTS OF STANDARD CHARACTERS WITHOUT CLAIM TO ANY PARTICULAR FONT, STYLE, SIZE, OR COLOR.

FOR CAFE-RESTAURANTS (U.S. CLS. 100 AND 101).

FIRST USE 11-1-2004; IN COMMERCE 12-1-2005.
CHERYL CLAYTON, EXAMINING ATTORNEY

SN 78-869,588. WILLIAMS, AMY, LYNN, HARTLAND, WI. AND WILLIAMS, NICHOLAS, GORDON, HARTLAND, WI. FILED 4-26-2006.

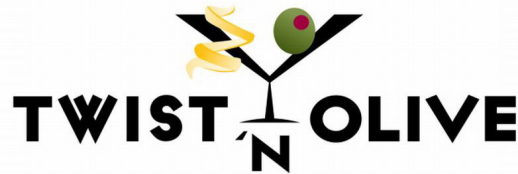

THE APPLICANT CLAIMS COLOR AS A FEATURE OF THE MARK, NAMELY, YELLOW, GREEN, RED, AND BLACK.

THE MARK CONSISTS OF A BLACK MARTINI GLASS WITH A YELLOW LEMON TWIST AND A GREEN OLIVE WITH A RED PIMENTO. LEMON TWIST AND OLIVE ARE IN MARTINI GLASS.

FOR BAR SERVICES (U.S. CLS. 100 AND 101).
FIRST USE 3-1-2006; IN COMMERCE 3-1-2006.
DAVID COLLIER, EXAMINING ATTORNEY

CLASS 43—(Continued).

SN 78-870,206. KEVIN L KIRBY INC., CHARLOTTESVILLE, VA. FILED 4-26-2006.

LAZY PARROT

THE MARK CONSISTS OF STANDARD CHARACTERS WITHOUT CLAIM TO ANY PARTICULAR FONT, STYLE, SIZE, OR COLOR.
FOR RESTAURANT AND BAR SERVICES (U.S. CLS. 100 AND 101).
ESTHER BELENKER, EXAMINING ATTORNEY

SN 78-870,827. GUMBERT, GERALD P., FORT WORTH, TX. FILED 4-27-2006.

Balls! Sports Bar

THE MARK CONSISTS OF STANDARD CHARACTERS WITHOUT CLAIM TO ANY PARTICULAR FONT, STYLE, SIZE, OR COLOR.
NO CLAIM IS MADE TO THE EXCLUSIVE RIGHT TO USE "SPORTS BAR", APART FROM THE MARK AS SHOWN.
FOR RESTAURANT AND BAR SERVICES (U.S. CLS. 100 AND 101).
KATINA MISTER, EXAMINING ATTORNEY

SN 78-871,495. HOTTIES LLC, ORLANDO, FL. FILED 4-27-2006.

FRESH, FAMILY & FUN

THE MARK CONSISTS OF STANDARD CHARACTERS WITHOUT CLAIM TO ANY PARTICULAR FONT, STYLE, SIZE, OR COLOR.
FOR RESTAURANT SERVICES; RESTAURANT SERVICES FEATURING DONUTS (U.S. CLS. 100 AND 101).
AMY GEARIN, EXAMINING ATTORNEY

CLASS 43—(Continued).

SN 78-871,843. AMERICAN DAIRY QUEEN CORPORATION, EDINA, MN. FILED 4-28-2006.

A SMILE AND A STORY

THE MARK CONSISTS OF STANDARD CHARACTERS WITHOUT CLAIM TO ANY PARTICULAR FONT, STYLE, SIZE, OR COLOR.
FOR RESTAURANT SERVICES; TAKE-OUT RESTAURANT SERVICES (U.S. CLS. 100 AND 101).
FIRST USE 4-27-2006; IN COMMERCE 4-27-2006.
JASON ROTH, EXAMINING ATTORNEY

SN 78-872,684. FIX MANAGEMENT, LLC, LAS VEGAS, NV. FILED 4-28-2006.

QUICK FIX

THE MARK CONSISTS OF STANDARD CHARACTERS WITHOUT CLAIM TO ANY PARTICULAR FONT, STYLE, SIZE, OR COLOR.
FOR RESTAURANT SERVICES (U.S. CLS. 100 AND 101).
DARRYL SPRUILL, EXAMINING ATTORNEY

SN 78-918,240. HOODLOVE LIMITED LIABILITY COMPANY, EAST ORANGE, NJ. FILED 6-27-2006.

HOOD LOVE

THE MARK CONSISTS OF STANDARD CHARACTERS WITHOUT CLAIM TO ANY PARTICULAR FONT, STYLE, SIZE, OR COLOR.
FOR CAFE-RESTAURANTS (U.S. CLS. 100 AND 101).
BARBARA BROWN, EXAMINING ATTORNEY

CLASS 43—(Continued).

SN 79-020,248. 509 PITT STREET PTY LIMITED, SYDNEY, NEW SOUTH WALES, 2000, AUSTRALIA, FILED 10-11-2005.

wake up!

OWNER OF INTERNATIONAL REGISTRATION 0818973 DATED 11-10-2003, EXPIRES 11-10-2013.
FOR TOURIST HOMES, TOURIST HOSTELS, TOURIST INNS, TOURIST HOTELS, TOURIST MOTELS AND PROVIDING TEMPORARY HOUSING ACCOMMODATIONS FOR TOURISTS (U.S. CLS. 100 AND 101).
ZHALEH DELANEY, EXAMINING ATTORNEY

SN 79-021,718. GRUPO PESTANA, S.G.P.S. S.A., P-9000-022 FUNCHAL, PORTUGAL, FILED 12-30-2005.

Pestana

THE MARK CONSISTS OF STANDARD CHARACTERS WITHOUT CLAIM TO ANY PARTICULAR FONT, STYLE, SIZE, OR COLOR.

OWNER OF INTERNATIONAL REGISTRATION 0879165 DATED 12-30-2005, EXPIRES 12-30-2015.

THE ENGLISH TRANSLATION OF THE WORD PESTANA IN THE MARK IS LASH OR EYELASH.

FOR HOTEL AND PROVIDING TEMPORARY ACCOMMODATION SERVICES; RENTAL AND RESERVATION OF VACATION ACCOMMODATIONS IN THE NATURE OF ROOMS AND RESERVATION OF TEMPORARY ACCOMMODATION IN THE NATURE OF ROOMS; RESTAURANT SERVICES; SNACK BAR SERVICES; SELF-SERVICE RESTAURANTS; CAFETERIA SERVICES; BAR SERVICES AND CATERING SERVICES; CATERING FOR THE PROVISION OF FOOD AND BEVERAGES (U.S. CLS. 100 AND 101).
SUSAN RICHARDS, EXAMINING ATTORNEY

CLASS 44—MEDICAL, BEAUTY AND AGRICULTURAL SERVICES

SN 76-486,340. FIRST CHOICE PHYSICIANS LLC, TA SPORT & SPINE REHAB, ROCKVILLE, MD. FILED 1-29-2003.

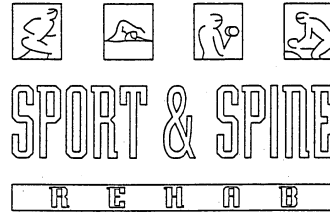

NO CLAIM IS MADE TO THE EXCLUSIVE RIGHT TO USE SPORT AND SPINE REHAB, APART FROM THE MARK AS SHOWN.

FOR MEDICAL SERVICES; CHIROPRACTIC SERVICES; PHYSICAL THERAPY; PHYSICAL REHABILITATION; AND ALTERNATIVE THERAPIES, NAMELY, MASSAGE THERAPY, MAGNETIC FIELD THERAPY, PSYCHOPHYSICAL INTEGRATION THERAPY AND REIKI (U.S. CLS. 100 AND 101).

FIRST USE 6-13-2000; IN COMMERCE 6-13-2000.
ALLISON HOLTZ, EXAMINING ATTORNEY

SN 76-635,837. PARK, SANGHEA, AKA KATHERINE PARK, ENGLEWOOD, NJ. FILED 4-11-2005.

KATHERINE'S AESTHETICS

FOR SKIN CARE SALONS (U.S. CLS. 100 AND 101).
FIRST USE 10-19-1998; IN COMMERCE 10-19-1998.
RONALD AIKENS, EXAMINING ATTORNEY

SN 76-636,268. NATIONAL GARDENING ASSOCIATION, INC., SOUTH BURLINGTON, VT. FILED 4-15-2005.

GIVE A GARDEN

THE MARK CONSISTS OF STANDARD CHARACTERS WITHOUT CLAIM TO ANY PARTICULAR FONT, STYLE, SIZE, OR COLOR.

FOR PROVIDING INFORMATION IN THE FIELD OF GARDENING (U.S. CLS. 100 AND 101).

FIRST USE 1-0-2005; IN COMMERCE 1-0-2005.
CHRIS WELLS, EXAMINING ATTORNEY

CLASS 44—(Continued).

SN 76-645,799. ABADI, HENRY, PALISADES, NJ. AND RHEE, TAI HE, PALISADES, NJ. FILED 8-29-2005.

KING SPA SAUNA

THE MARK CONSISTS OF STANDARD CHARACTERS WITHOUT CLAIM TO ANY PARTICULAR FONT, STYLE, SIZE, OR COLOR.

NO CLAIM IS MADE TO THE EXCLUSIVE RIGHT TO USE "SPA SAUNA", APART FROM THE MARK AS SHOWN. FOR PROVIDING BATH HOUSES AND MASSAGE THERAPY, SKIN CARE SALONS, MANICURING AND PEDICURING (U.S. CLS. 100 AND 101).

FIRST USE 8-17-2003; IN COMMERCE 8-17-2003.
AMEETA JORDAN, EXAMINING ATTORNEY

SN 76-646,416. SPEEDREADING PEOPLE, LLC, HARTFORD, CT. FILED 9-8-2005.

ESP

THE MARK CONSISTS OF STANDARD CHARACTERS WITHOUT CLAIM TO ANY PARTICULAR FONT, STYLE, SIZE, OR COLOR.

FOR PSYCHOLOGICAL TESTING AND INFORMATION SERVICES, NAMELY, PROVIDING ON-LINE PERSONALITY TYPE TESTING SERVICES WHICH YIELD A PERSON'S PERSONALITY PROFILE AND OFFERS SUGGESTIONS ON HOW BEST TO COMMUNICATE WITH THAT PERSON (U.S. CLS. 100 AND 101).

FIRST USE 7-23-2004; IN COMMERCE 7-23-2004.
STEVEN PEREZ, EXAMINING ATTORNEY

SN 76-652,126. AUDREY A. FOROUTAN DMD AND MICHAEL M. TARIGHATI DMD, PROFESSIONAL DENTAL CORPORATION, ENCINITAS, CA. FILED 12-12-2005.

**CREATING GORGEOUS SMILES,
ONE PATIENT AT A TIME!**

THE MARK CONSISTS OF STANDARD CHARACTERS WITHOUT CLAIM TO ANY PARTICULAR FONT, STYLE, SIZE, OR COLOR.

FOR GENERAL AND COSMETIC DENTISTRY (U.S. CLS. 100 AND 101).

FIRST USE 7-2-2005; IN COMMERCE 7-2-2005.
GINA FINK, EXAMINING ATTORNEY

CLASS 44—(Continued).

SN 76-655,606. STRATHMORE PARTNERS LP, CONCORD, NH. FILED 2-24-2006.

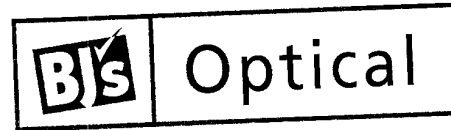

OWNER OF U.S. REG. NOS. 1,751,720, 2,531,703 AND OTHERS.

NO CLAIM IS MADE TO THE EXCLUSIVE RIGHT TO USE "OPTICAL", APART FROM THE MARK AS SHOWN.

FOR OPTOMETRY SERVICES (U.S. CLS. 100 AND 101).
FIRST USE 9-4-2003; IN COMMERCE 9-4-2003.
MYRIAH HABEEB, EXAMINING ATTORNEY

SN 76-658,295. MASER, JENNIFER L., AUGRES, MI. FILED 4-12-2006.

CREW CUT

THE MARK CONSISTS OF STANDARD CHARACTERS WITHOUT CLAIM TO ANY PARTICULAR FONT, STYLE, SIZE, OR COLOR.

FOR HAIR STYLING AND CUTTING SERVICES PRIMARILY FOR AUTOMOTIVE RACE CAR CREW MEMBERS (U.S. CLS. 100 AND 101).

KELLY BOULTON, EXAMINING ATTORNEY

SN 76-658,490. ALEXANDER EYE INSTITUTE, S.C., APPLETON, WI. FILED 4-17-2006.

VeraClear

FOR OPHTHALMIC SERVICES TO IMPLANT A MICROTHIN LENS BETWEEN NATURAL LENS OF THE EYE AND THE CORNEA FOR REFRACTIVE PURPOSES (U.S. CLS. 100 AND 101).

FIRST USE 8-1-2005; IN COMMERCE 8-1-2005.
JENNIFER DIXON, EXAMINING ATTORNEY

CLASS 44—(Continued).

SN 76-658,502. NOCTURNA SLEEP CENTER, LLC, HENDERSON, NV. FILED 4-17-2006.

NOCTURNA

THE MARK CONSISTS OF STANDARD CHARACTERS WITHOUT CLAIM TO ANY PARTICULAR FONT, STYLE, SIZE, OR COLOR.

THE ENGLISH TRANSLATION OF THE WORD "NOCTURNA" IN THE MARK IS "NIGHT".

FOR MEDICAL SERVICES, NAMELY, MEDICAL CLINICS PROVIDING TESTING, COUNSELING, THERAPY, EVALUATION, TREATMENT, AND DIAGNOSTIC SERVICES IN THE NATURE OF SLEEP DISORDERS (U.S. CLS. 100 AND 101).

FIRST USE 8-15-2001; IN COMMERCE 8-15-2001.
DEBRA LEE, EXAMINING ATTORNEY

SN 76-658,570. CAMELOT NURSERIES, INC., DBA MOUNTAIN STATES WHOLESALE NURSERY, LITCHFIELD PARK, AZ. FILED 4-17-2006.

PLANTIS

THE MARK CONSISTS OF STANDARD CHARACTERS WITHOUT CLAIM TO ANY PARTICULAR FONT, STYLE, SIZE, OR COLOR.

FOR SEARCHABLE COMPUTER DATABASE CONTAINING INFORMATION CONCERNING PLANTS AND PLANT SELECTION (U.S. CLS. 100 AND 101).

FIRST USE 9-1-2004; IN COMMERCE 9-1-2004.
MONIQUE MILLER, EXAMINING ATTORNEY

SN 76-658,645. ARJO, INC., ROSELLE, IL. FILED 4-18-2006.



FOR CONSULTING SERVICES IN THE FIELD OF LONG TERM PATIENT CARE FACILITIES (U.S. CLS. 100 AND 101).

FIRST USE 2-28-2006; IN COMMERCE 2-28-2006.
ARETHA SOMERVILLE, EXAMINING ATTORNEY

CLASS 44—(Continued).

SN 76-658,869. MURAD, HOWARD, EL SEGUNDO, CA. FILED 4-24-2006.

INCLUSIVE HEALTH CENTER

THE MARK CONSISTS OF STANDARD CHARACTERS WITHOUT CLAIM TO ANY PARTICULAR FONT, STYLE, SIZE, OR COLOR.

NO CLAIM IS MADE TO THE EXCLUSIVE RIGHT TO USE "HEALTH CENTER", APART FROM THE MARK AS SHOWN.

FOR FULL SERVICE SALON PROVIDING BEAUTY AND SKIN CARE SERVICES: SPA SERVICES, NAMELY, DAY SPAS FEATURING COSMETIC, BODY AND SKIN CARE SERVICES (U.S. CLS. 100 AND 101).

DEZMONA MIZELLE, EXAMINING ATTORNEY

SN 76-659,837. ALEXANDER EYE INSTITUTE, S.C., APPLETON, WI. FILED 5-10-2006.

UltraSight

FOR OPHTHALMIC SERVICES, NAMELY, BLADELESS ALL LASER VISION CORRECTION (U.S. CLS. 100 AND 101).

FIRST USE 1-23-2002; IN COMMERCE 1-23-2002.
JENNIFER DIXON, EXAMINING ATTORNEY

SN 78-517,012. FIREMAN'S CHARITABLE & BENEVOLENT ASSOCIATION, NEW ORLEANS, LA. FILED 11-15-2004.

Where Heroes Rest

THE MARK CONSISTS OF STANDARD CHARACTERS WITHOUT CLAIM TO ANY PARTICULAR FONT, STYLE, SIZE, OR COLOR.

FOR CEMETERY SERVICES, NAMELY THE PERPETUAL CARE AND UPKEEP OF CEMETERY PLOTS (U.S. CLS. 100 AND 101).

FIRST USE 10-31-2004; IN COMMERCE 10-31-2004.
SEAN CROWLEY, EXAMINING ATTORNEY

CLASS 44—(Continued).

SN 78-518,316. HEALTH SYNDICATE TRUST, COMPRISING JOHN WOOD AND RICHARD DEANDREA, BOTH U.S. CITIZENS, VENICE, CA. FILED 11-17-2004.



THE COLOR(S) RED, GREEN, WHITE, BEIGE IS/ARE CLAIMED AS A FEATURE OF THE MARK.

THE MARK CONSISTS OF A BEIGE SQUARE WITH DARK GREEN OUTLINE FEATURING FOUR GREEN LEAVES WITH A WHITE SHADOW IN A RED CROSS.

FOR WEIGHT REDUCTION DIET PLANNING AND SUPERVISION, PROVIDING INFORMATION ABOUT DIETARY SUPPLEMENTS AND NUTRITION; NUTRITION COUNSELING (U.S. CLS. 100 AND 101).

FIRST USE 1-1-2001; IN COMMERCE 1-1-2001.
KIMBERLY FRYE, EXAMINING ATTORNEY

SN 78-548,617. MOBILE MOHS INC., ORANGE, CA. FILED 1-17-2005.

Mobile Mohs

THE MARK CONSISTS OF STANDARD CHARACTERS WITHOUT CLAIM TO ANY PARTICULAR FONT, STYLE, SIZE, OR COLOR.

NO CLAIM IS MADE TO THE EXCLUSIVE RIGHT TO USE "MOBILE", APART FROM THE MARK AS SHOWN. SEC. 2(F).

FOR MEDICAL SERVICES, NAMELY, MOBILE HISTOLOGY TECHNICIAN SERVICES (U.S. CLS. 100 AND 101).

FIRST USE 1-1-1979; IN COMMERCE 1-1-1979.
CHERYL CLAYTON, EXAMINING ATTORNEY

CLASS 44—(Continued).

SN 78-593,857. MINDFUL MOODS, LLP, DENVER, CO. FILED 3-23-2005.

Mindful Moods

THE MARK CONSISTS OF STANDARD CHARACTERS WITHOUT CLAIM TO ANY PARTICULAR FONT, STYLE, SIZE, OR COLOR.

FOR PSYCHONUEROBIOLOGICAL THERAPEUTIC SERVICES IN THE NATURE OF PSYCHOLOGICAL CONSULTATION USED TO CULTIVATE THE UNDERSTANDING OF PHYSIOLOGICAL STATES, NEUROPSYCHOLOGICAL STATES OR GENERAL MOODS IN UNDERSTANDING MIND-BODY CONNECTIONS AND ADDRESSING HUMAN BEHAVIOR (U.S. CLS. 100 AND 101).

FIRST USE 1-18-2005; IN COMMERCE 3-2-2005.
KIMBERLY PERRY, EXAMINING ATTORNEY

SN 78-640,470. MCKESSON CORPORATION, SAN FRANCISCO, CA. FILED 5-31-2005.

HEALTH ACROSS AMERICA KEEPING PHARMACY CARE PERSONAL

THE MARK CONSISTS OF STANDARD CHARACTERS WITHOUT CLAIM TO ANY PARTICULAR FONT, STYLE, SIZE, OR COLOR.

FOR CONDUCTING FREE HEALTHCARE SCREENINGS FOR CONSUMERS OF PHARMACIES FOR BLOOD PRESSURE, BLOOD SUGAR AND CHOLESTEROL TESTING AND MONITORING (U.S. CLS. 100 AND 101).

FIRST USE 5-16-2005; IN COMMERCE 5-20-2005.
CAROLYN CATALDO, EXAMINING ATTORNEY

SN 78-687,209. GRIMWOOD, NEIL W., MARINA DEL REY, CA. AND BRENNAN, JULIE, MARINA DEL REY, CA. FILED 8-6-2005.



THE COLOR(S) BLACK, GREEN, BLUE, PURPLE, PINK, RED, ORANGE, AND YELLOW ARE CLAIMED AS A FEATURE OF THE MARK

THE COLOR BLACK APPEARS IN THE OUTLINE OF THE LETTERING KILLERSTARCH AND THE OUTLINE OF THE DROP-LIKE DESIGN ELEMENTS APPEARING IN THE MARK. THE COLOR GREEN APPEARS IN THE LETTER K AND IT FADES INTO THE COLOR BLUE. THE COLOR BLUE APPEARS IN THE LETTERS ILLE AND THE TOP PORTION OF THE LETTERS R AND S. THE COLOR PURPLE APPEARS IN THE MIDDLE PORTION OF THE

CLASS 44—(Continued).

LETTERS R AND S. THE COLOR PINK APPEARS IN THE BOTTOM RIGHT HAND SIDE OF THE LETTER S AND IN THE LETTER T. THE COLOR RED APPEARS IN THE LETTER A AND FADES INTO THE LETTER R. THE COLOR ORANGE APPEARS IN THE LETTER R AND THE LEFT HAND SIDE OF THE LETTER C. THE COLOR YELLOW APPEARS IN THE RIGHT HAND PORTION OF THE LETTER C AND FADES INTO THE LETTER H. THE DROP LIKE DESIGNS APPEAR IN BLUE, PURPLE, PINK, RED, ORANGE YELLOW, AND GREEN, FROM LEFT TO RIGHT IN THE MARK. THE MARK IS PRESENTED ON A TRANSPARENT BACKGROUND AND NO OTHER COLORS ARE CLAIMED.

FOR PROVIDING HEALTH INFORMATION (U.S. CLS. 100 AND 101).

FIRST USE 7-1-2004; IN COMMERCE 7-1-2004.
COLLEEN KEARNEY, EXAMINING ATTORNEY

SN 78-688,623. D'ALERTA, MARIO, MIAMI, FL. FILED 8-9-2005.

PAINOUT

THE MARK CONSISTS OF STANDARD CHARACTERS WITHOUT CLAIM TO ANY PARTICULAR FONT, STYLE, SIZE, OR COLOR.

OWNER OF U.S. REG. NO. 2,300,187.
FOR MEDICAL SERVICES, NAMELY, APPLYING PAIN-REDUCING ELECTRICAL ENERGY TO THE BODY (U.S. CLS. 100 AND 101).

LEIGH CAROLINE CASE, EXAMINING ATTORNEY

SN 78-693,119. MAZIN K. YALDO, M.D., ORCHARD LAKE, MI. FILED 8-15-2005.

YALDO EYE CENTER

THE MARK CONSISTS OF STANDARD CHARACTERS WITHOUT CLAIM TO ANY PARTICULAR FONT, STYLE, SIZE, OR COLOR.

NO CLAIM IS MADE TO THE EXCLUSIVE RIGHT TO USE "EYE CENTER", APART FROM THE MARK AS SHOWN.

SEC. 2(F).
FOR VISION CORRECTION SERVICES, NAMELY, EYE EXAMINATIONS, EVALUATION AND CONSULTATION IN THE FIELD OF VISION CORRECTION, AND TREATMENT OF VISION DISORDERS. (U.S. CLS. 100 AND 101).

FIRST USE 12-1-2001; IN COMMERCE 12-1-2001.
MICHELE SWAIN, EXAMINING ATTORNEY

CLASS 44—(Continued).

SN 78-703,569. HIKARI HOLDINGS, L.C., VALLEY CENTER, CA. FILED 8-30-2005.

DISCOVER THE ALKALARIAN APPROACH TO OPTIMAL LIVING

THE MARK CONSISTS OF STANDARD CHARACTERS WITHOUT CLAIM TO ANY PARTICULAR FONT, STYLE, SIZE, OR COLOR.

NO CLAIM IS MADE TO THE EXCLUSIVE RIGHT TO USE "ALKALARIAN", APART FROM THE MARK AS SHOWN.

FOR PROVIDING INFORMATION ABOUT DIETARY SUPPLEMENTS, NUTRITION, HEALTH AND HEALTHY LIFESTYLES (U.S. CLS. 100 AND 101).

FIRST USE 10-31-2004; IN COMMERCE 10-31-2004.
SUSAN STIGLITZ, EXAMINING ATTORNEY

SN 78-708,663. GRAHAM, JEANINE R., LEMONT, IL. FILED 9-8-2005.

JOIE DÈ DERM

THE MARK CONSISTS OF STANDARD CHARACTERS WITHOUT CLAIM TO ANY PARTICULAR FONT, STYLE, SIZE, OR COLOR.

NO CLAIM IS MADE TO THE EXCLUSIVE RIGHT TO USE "DERM", APART FROM THE MARK AS SHOWN.

THE ENGLISH TRANSLATION OF THE FRENCH WORDS JOIE DE DERM IS "JOY OF SKIN".

FOR HEALTH SPA SERVICES, NAMELY, COSMETIC BODY CARE SERVICES (U.S. CLS. 100 AND 101).

SCOTT SISUN, EXAMINING ATTORNEY

SN 78-712,871. MAGASSY, CSABA L., MCLEAN, VA. FILED 9-14-2005.

Botticelli MedSpa

THE MARK CONSISTS OF STANDARD CHARACTERS WITHOUT CLAIM TO ANY PARTICULAR FONT, STYLE, SIZE, OR COLOR.

NO CLAIM IS MADE TO THE EXCLUSIVE RIGHT TO USE "MED SPA", APART FROM THE MARK AS SHOWN.

FOR MEDICAL SERVICES IN A SPA ENVIRONMENT; PLASTIC AND COSMETIC SURGERY SERVICES IN THE FIELD OF FACIAL AND BODY ENHANCEMENTS; MEDICAL SERVICES, NAMELY, AESTHETIC MEDICAL TREATMENTS; MEDICAL SERVICES, NAMELY, DERMATOLOGICAL TREATMENTS (U.S. CLS. 100 AND 101).

CAROLYN CATALDO, EXAMINING ATTORNEY

CLASS 44—(Continued).

SN 78-714,337. JOHN ALLAN COMPANY, LLC, NEW YORK, NY. FILED 9-16-2005.

WHERE SERVICE MEETS STYLE

THE MARK CONSISTS OF STANDARD CHARACTERS WITHOUT CLAIM TO ANY PARTICULAR FONT, STYLE, SIZE, OR COLOR.

FOR MEN'S AND WOMEN'S HAIR CUTTING SERVICES, MEN'S GROOMING SERVICES, BEAUTY SALON SERVICES (U.S. CLS. 100 AND 101).

ARETHA SOMERVILLE, EXAMINING ATTORNEY

SN 78-718,275. OUTER BANKS FAMILY & COSMETIC DENTISTRY, VIRGINIA BEACH, VA. FILED 9-22-2005.



NO CLAIM IS MADE TO THE EXCLUSIVE RIGHT TO USE "OUTER BANKS FAMILY & COSMETIC DENTISTRY", APART FROM THE MARK AS SHOWN.

FOR DENTIST SERVICES (U.S. CLS. 100 AND 101).

FIRST USE 7-25-2005; IN COMMERCE 7-25-2005.

STEVEN PEREZ, EXAMINING ATTORNEY

SN 78-743,191. SUNDARA 1 LLC, NEW YORK, NY. FILED 10-29-2005.



NO CLAIM IS MADE TO THE EXCLUSIVE RIGHT TO USE "ADVANCED AIRBRUSH TANNING", APART FROM THE MARK AS SHOWN.

THE FOREIGN WORDING IN THE MARK TRANSLATES INTO ENGLISH AS BEAUTIFUL.

FOR TANNING SALONS (U.S. CLS. 100 AND 101).

FIRST USE 5-11-2005; IN COMMERCE 5-18-2005.

JOHN DWYER, EXAMINING ATTORNEY

CLASS 44—(Continued).

SN 78-751,177. H.E. LUPIEN, INC., NEWTON, MA. FILED 11-10-2005.



FOR LANDSCAPING SERVICES AND LANDSCAPE MAINTENANCE SERVICES, NAMELY, GARDEN TREE AND PLANT PLANTING, CARE AND REMOVAL SERVICES, LAWN CARE SERVICES, AND LANDSCAPE GARDENING DESIGN FOR OTHERS (U.S. CLS. 100 AND 101).

FIRST USE 2-1-2005; IN COMMERCE 2-1-2005.

ANDREW RHIM, EXAMINING ATTORNEY

SN 78-760,624. SPORTS, ORTHOPEDIC AND REHABILITATION MEDICINE ASSOCIATES, REDWOOD CITY, CA. FILED 11-23-2005.



THE MARK CONSISTS OF A REPRESENTATION OF A HUMAN FIGURE IN A HURDLING POSITION.

FOR MEDICAL SERVICES (U.S. CLS. 100 AND 101).

FIRST USE 7-1-1992; IN COMMERCE 7-1-1992.

C. DIONNE CLYBURN, EXAMINING ATTORNEY

SN 78-760,631. SPORTS, ORTHOPEDIC AND REHABILITATION MEDICINE ASSOCIATES, REDWOOD CITY, CA. FILED 11-23-2005.



THE MARK CONSISTS OF A REPRESENTATION OF A HUMAN FIGURE IN A HURDLING POSITION ABOVE THE WORDS SOAR THE TEAM APPROACH.

FOR MEDICAL SERVICES (U.S. CLS. 100 AND 101).

FIRST USE 7-1-1992; IN COMMERCE 7-1-1992.

C. DIONNE CLYBURN, EXAMINING ATTORNEY

CLASS 44—(Continued).

SN 78-786,870. GRACE CLINIC CHRISTIAN COUNSELING, INC., WINTER PARK, FL. FILED 1-6-2006.



CHRISTIAN COUNSELING

FOR MENTAL HEALTH COUNSELING AND PSYCHOTHERAPY AS IT RELATES TO RELATIONSHIPS (U.S. CLS. 100 AND 101).

FIRST USE 1-1-1999; IN COMMERCE 3-1-2003.
RICHARD WHITE, EXAMINING ATTORNEY

SN 78-792,439. EAST-WEST MANAGEMENT SERVICES, LLC, OSWEGO, NY. FILED 1-16-2006.



NO CLAIM IS MADE TO THE EXCLUSIVE RIGHT TO USE "DENTURE", APART FROM THE MARK AS SHOWN. THE COLOR(S) RED AND BLUE IS/ARE CLAIMED AS A FEATURE OF THE MARK.

THE MARK CONSISTS OF THE WORD DENTURE IN BLUE CAPITAL LETTERS, WITH THE WORD WORKS IN SMALLER RED CAPITAL LETTERS NEXT TO IT, WITH A COLOR BLUE FIVE POINT STAR TO THE LEFT OF AND ABOVE THE WORD WORKS.

FOR DENTAL SERVICES (U.S. CLS. 100 AND 101).
FIRST USE 12-15-2005; IN COMMERCE 1-6-2006.
ODESSA BIBBINS, EXAMINING ATTORNEY

SN 78-809,205. CONNAUGHT TECHNOLOGY CORPORATION, GREENVILLE, DE. FILED 2-7-2006.



PertussisProtection
Around the Whole Family

NO CLAIM IS MADE TO THE EXCLUSIVE RIGHT TO USE PERTUSSIS PROTECTION, APART FROM THE MARK AS SHOWN.

THE MARK IS NOT IN COLOR. THE MARK CONSISTS OF A STYLIZED REPRESENTATION OF A MAN, A WOMAN AND A CHILD, WITH THE STYLIZED WORDS PERTUSSIS PROTECTION AROUND THE WHOLE FAMILY BELOW THE DESIGN.

FOR PROVIDING INFORMATION TO OTHERS REGARDING THE IMPORTANCE AND NEED FOR PERTUSSIS IMMUNIZATION (U.S. CLS. 100 AND 101).

STANLEY I. OSBORNE, EXAMINING ATTORNEY

CLASS 44—(Continued).

SN 78-809,544. MANI M.D. , NASRIN, LA JOLLA, CA. FILED 2-7-2006.



NO CLAIM IS MADE TO THE EXCLUSIVE RIGHT TO USE "LA JOLLA COSMETIC LASER CLINIC", APART FROM THE MARK AS SHOWN.

FOR MEDICAL SERVICES, NAMELY, COSMETIC LASER TREATMENTS, LASER HAIR REMOVAL, LASER SKIN RESURFACING, LASER VEIN THERAPY, MICRODERMABRASION, SCLEROTHERAPY, LASER WRINKLE REDUCTION, SKIN PHOTOREJUVENATION, SUNSPOT REMOVAL, CHEMICAL PEELS FOR SKIN, ACNE TREATMENT, ANTIAGING TREATMENT, COMPLEXION ANALYSIS, PHOTOFACIALS, FACIALS, LASER WRINKLE REDUCTION, INJECTION WRINKLE AND LINE REDUCTION, INJECTION FILLING OF CREASES AND WRINKLES, SKIN TIGHTENING, TISSUE TIGHTENING AND SKIN LIGHTENING (U.S. CLS. 100 AND 101).

FIRST USE 12-12-2005; IN COMMERCE 12-12-2005.
KATHERINE E. HALMEN, EXAMINING ATTORNEY

SN 78-809,547. MANI M.D. , NASRIN, LA JOLLA, CA. FILED 2-7-2006.

LOOK YOUR BEST . . .
MORNING, NOON AND NIGHT!

THE MARK CONSISTS OF STANDARD CHARACTERS WITHOUT CLAIM TO ANY PARTICULAR FONT, STYLE, SIZE, OR COLOR.

FOR MEDICAL SERVICES, NAMELY, COSMETIC LASER TREATMENTS, LASER HAIR REMOVAL, LASER SKIN RESURFACING, LASER VEIN THERAPY, MICRODERMABRASION, SCLEROTHERAPY, LASER WRINKLE REDUCTION, SKIN PHOTOREJUVENATION, SUNSPOT REMOVAL, CHEMICAL PEELS FOR SKIN, ACNE TREATMENT, ANTIAGING TREATMENT, COMPLEXION ANALYSIS, PHOTOFACIALS, FACIALS, LASER WRINKLE REDUCTION, INJECTION WRINKLE AND LINE REDUCTION, INJECTION FILLING OF CREASES AND WRINKLES, SKIN TIGHTENING, TISSUE TIGHTENING AND SKIN LIGHTENING (U.S. CLS. 100 AND 101).

FIRST USE 1-12-2006; IN COMMERCE 1-12-2006.
KATHERINE E. HALMEN, EXAMINING ATTORNEY

CLASS 44—(Continued).

SN 78-812,225. TIGER J., LLC, NEW YORK, NY. FILED 2-10-2006.

IVY HILL GARDENS

THE MARK CONSISTS OF STANDARD CHARACTERS WITHOUT CLAIM TO ANY PARTICULAR FONT, STYLE, SIZE, OR COLOR.

NO CLAIM IS MADE TO THE EXCLUSIVE RIGHT TO USE "GARDENS", APART FROM THE MARK AS SHOWN.

FOR ARRANGEMENT OF LIVE PLANTS, FLOWERS AND/OR OTHER HORTICULTURAL PRODUCTS (U.S. CLS. 100 AND 101).

DAVID TAYLOR, EXAMINING ATTORNEY

SN 78-823,881. ONE SCOTTSDALE HOLDINGS LLC, SCOTTSDALE, AZ. FILED 2-27-2006.

**ONE SCOTTSDALE**

NO CLAIM IS MADE TO THE EXCLUSIVE RIGHT TO USE "SCOTTSDALE", APART FROM THE MARK AS SHOWN.

FOR HEALTH SPA SERVICES FOR HEALTH AND WELLNESS OF THE BODY AND SPIRIT OFFERED AT A HEALTH RESORT; HEALTH SPA SERVICES, NAMELY, COSMETIC BODY CARE SERVICES (U.S. CLS. 100 AND 101).

CAROLYN CATALDO, EXAMINING ATTORNEY

CLASS 44—(Continued).

SN 78-824,369. CONNAUGHT TECHNOLOGY CORPORATION, GREENVILLE, DE. FILED 2-27-2006.



NO CLAIM IS MADE TO THE EXCLUSIVE RIGHT TO USE IMMUNIZE, APART FROM THE MARK AS SHOWN.

THE MARK CONSISTS OF THE DESIGN OF A SHIELD THAT CONTAINS FOUR SEPARATE SECTIONS, EACH ONE WITH A STYLIZED REPRESENTATION OF A PERSON. TO THE RIGHT OF THE DESIGN ARE THE STYLIZED WORDS "IMMUNIZE FIRST SAFEGUARDING THE HEALTH OF THE HEALTH-CARE WORKER".

FOR PROVIDING INFORMATION TO HEALTH CARE PROFESSIONALS REGARDING THE IMPORTANCE AND NEED FOR THEM TO BE IMMUNIZED TO PROTECT THEMSELVES AND THEIR PATIENTS (U.S. CLS. 100 AND 101).

STANLEY I. OSBORNE, EXAMINING ATTORNEY

SN 78-832,376. WELCOME BACK INC., PHILADELPHIA, PA. FILED 3-8-2006.

ANCORA IMPARO

THE MARK CONSISTS OF STANDARD CHARACTERS WITHOUT CLAIM TO ANY PARTICULAR FONT, STYLE, SIZE, OR COLOR.

THE FOREIGN WORDING IN THE MARK TRANSLATES INTO ENGLISH AS "AGAIN" OR "STILL" "LEARNING".

FOR MASSAGE SERVICES (U.S. CLS. 100 AND 101).

FIRST USE 9-9-2004; IN COMMERCE 9-9-2004.

DAVID ELTON, EXAMINING ATTORNEY

SN 78-833,869. IDEAL REHABILITATION PLLC, GOOD-YEAR, AZ. FILED 3-9-2006.

IDEAL REHABILITATION

THE MARK CONSISTS OF STANDARD CHARACTERS WITHOUT CLAIM TO ANY PARTICULAR FONT, STYLE, SIZE, OR COLOR.

NO CLAIM IS MADE TO THE EXCLUSIVE RIGHT TO USE "REHABILITATION", APART FROM THE MARK AS SHOWN.

FOR HEALTH CARE SERVICES, NAMELY, PHYSICAL REHABILITATION THERAPY, MASSAGE THERAPY, OCCUPATIONAL THERAPY, HAND THERAPY AND SPEECH THERAPY (U.S. CLS. 100 AND 101).

TIMOTHY FINNEGAN, EXAMINING ATTORNEY

CLASS 44—(Continued).

SN 78-836,774. KENTUCKY ACADEMY OF FAMILY PHYSICIANS FOUNDATION, FLATWOOD, KY. FILED 3-14-2006.

equip-4-pcps

THE MARK CONSISTS OF STANDARD CHARACTERS WITHOUT CLAIM TO ANY PARTICULAR FONT, STYLE, SIZE, OR COLOR.
FOR PHYSICIAN SERVICES (U.S. CLS. 100 AND 101).
JASON LOTT, EXAMINING ATTORNEY

SN 78-847,673. BARIMD, INC., FT. LAUDERDALE, FL. FILED 3-28-2006.

INTERACT!

THE MARK CONSISTS OF STANDARD CHARACTERS WITHOUT CLAIM TO ANY PARTICULAR FONT, STYLE, SIZE, OR COLOR.
FOR PROVIDING INFORMATION ABOUT BARIATRIC AND GENERAL MEDICAL WEIGHT LOSS VIA A GLOBAL COMMUNICATION NETWORK (U.S. CLS. 100 AND 101).
CARRIE ACHEN, EXAMINING ATTORNEY

SN 78-848,384. DNA DIRECT, INC., SAN FRANCISCO, CA. FILED 3-28-2006.

DNA DIRECT

THE MARK CONSISTS OF STANDARD CHARACTERS WITHOUT CLAIM TO ANY PARTICULAR FONT, STYLE, SIZE, OR COLOR.
NO CLAIM IS MADE TO THE EXCLUSIVE RIGHT TO USE "DNA", APART FROM THE MARK AS SHOWN.
FOR FACILITATION OF GENETIC TESTING FOR HEALTH OR MEDICAL PURPOSES; INTERPRETATION OF AND COUNSELING REGARDING GENETIC TESTING RESULTS FOR HEALTH OR MEDICAL PURPOSES; PROVIDING INFORMATION IN THE FIELD OF HEALTH, MEDICINE, GENETICS, AND GENETIC TESTING (U.S. CLS. 100 AND 101).
FIRST USE 3-0-2005; IN COMMERCE 3-0-2005.
KEVIN CORWIN, EXAMINING ATTORNEY

CLASS 44—(Continued).

SN 78-849,065. TAMARA HARTSTEN, SAN DIEGO, CA. FILED 3-29-2006.

Lounge ESTHETIQUE

THE MARK CONSISTS OF STANDARD CHARACTERS WITHOUT CLAIM TO ANY PARTICULAR FONT, STYLE, SIZE, OR COLOR.
THE ENGLISH TRANSLATION OF THE WORD ESTHETIQUE IN THE MARK IS AESTHETIC.
FOR BEAUTY SALON SERVICES (U.S. CLS. 100 AND 101).
DOMINIC J. FERRAIUOLO, EXAMINING ATTORNEY

SN 78-850,500. VANCOUVER RADIOLOGISTS, P.C., VANCOUVER, WA. FILED 3-30-2006.



NO CLAIM IS MADE TO THE EXCLUSIVE RIGHT TO USE "VANCOUVER RADIOLOGISTS, P.C.", APART FROM THE MARK AS SHOWN.
THE MARK CONSISTS OF A STYLISTIC HALF OVAL WITH A STYLIZED CAPITAL LETTER "V" AND "R" INTERCONNECTED, WITH A STANDARD LETTERED "VANCOUVER RADIOLOGISTS, P.C." ALL WITHIN THE STYLIZED HALF OVAL.
FOR MEDICAL RADIOLOGY SERVICES (U.S. CLS. 100 AND 101).
FIRST USE 7-10-2003; IN COMMERCE 8-1-2003.
LA TONIA FISHER, EXAMINING ATTORNEY

SN 78-852,362. PENNSYLVANIA COLLEGE OF OPTOMETRY, ELKINS PARK, PA. FILED 4-3-2006.

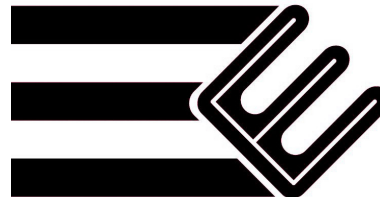

THE MARK CONSISTS OF STYLIZED "E" WITH THREE HORIZONTAL BARS.
FOR OPHTHALMOLOGY SERVICES; OPTOMETRY SERVICES; MEDICAL SERVICES, NAMELY, DIAGNOSIS AND TREATMENT OF VISION IMPAIRMENT AND DISEASES OF THE EYE; LASER AND OTHER SURGICAL PROCEDURES TO CORRECT AND IMPROVE VISION (U.S. CLS. 100 AND 101).
CAROLINE WEIMER, EXAMINING ATTORNEY

CLASS 44—(Continued).

SN 78-856,122. AAE CLINICS INC, LAS VEGAS, NV. FILED 4-7-2006.

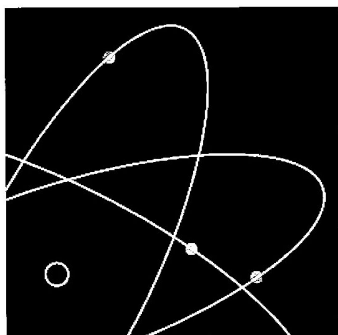

FOR HEALTH CARE (U.S. CLS. 100 AND 101).
FIRST USE 3-18-1998; IN COMMERCE 3-18-1998.
JEAN IM, EXAMINING ATTORNEY

SN 78-856,278. TALLAHASSEE MEMORIAL HEALTHCARE, INC, TALLAHASSEE, FL. FILED 4-7-2006.



**Tallahassee Memorial
HealthCare**

NO CLAIM IS MADE TO THE EXCLUSIVE RIGHT TO USE "TALLAHASSEE MEMORIAL HEALTHCARE", APART FROM THE MARK AS SHOWN.
FOR MEDICAL SERVICES (U.S. CLS. 100 AND 101).
FIRST USE 4-23-1998; IN COMMERCE 4-23-1998.
HEATHER THOMPSON, EXAMINING ATTORNEY

SN 78-856,489. COHEN, STEVEN D., MARLBOROUGH, MA. FILED 4-7-2006.

Cohen-si-dentally

THE MARK CONSISTS OF STANDARD CHARACTERS WITHOUT CLAIM TO ANY PARTICULAR FONT, STYLE, SIZE, OR COLOR.
FOR DENTAL SERVICES, NAMELY DENTISTRY (U.S. CLS. 100 AND 101).
FIRST USE 3-1-2006; IN COMMERCE 3-1-2006.
KAPIL BHANOT, EXAMINING ATTORNEY

CLASS 44—(Continued).

SN 78-857,155. UNIVERSAL CITY MEDICAL WELLNESS GROUP, LOS ANGELES, CA. FILED 4-7-2006.

Green Spa

THE MARK CONSISTS OF STANDARD CHARACTERS WITHOUT CLAIM TO ANY PARTICULAR FONT, STYLE, SIZE, OR COLOR.

NO CLAIM IS MADE TO THE EXCLUSIVE RIGHT TO USE "SPA", APART FROM THE MARK AS SHOWN.

FOR BEAUTY SALONS; HEALTH SPA SERVICES FOR HEALTH AND WELLNESS OF THE BODY AND SPIRIT OFFERED AT A HEALTH RESORT; HEALTH SPA SERVICES, NAMELY, COSMETIC BODY CARE SERVICES; SKIN CARE SALONS; AROMATHERAPY SERVICES; MUSIC THERAPY FOR PHYSICAL, PSYCHOLOGICAL AND COGNITIVE PURPOSES; VITAMIN THERAPY; MASSAGE; PERMANENT HAIR REMOVAL AND REDUCTION; MICRODERMABRASION, NAMELY, A TOPICAL SKIN TREATMENT INVOLVING ABRASION OF THE SKIN WITH A HIGH-PRESSURE FLOW OF CRYSTALS; LEASING SKIN CARE EQUIPMENT; PROVIDING INFORMATION ABOUT BEAUTY; PROVIDING INFORMATION ABOUT DIETARY SUPPLEMENTS AND NUTRITION; COSMETIC ELECTROLYSIS; COSMETOLOGY SERVICES (U.S. CLS. 100 AND 101).

PATRICIA EVANKO, EXAMINING ATTORNEY

SN 78-858,963. HE'S NOT HERE HOLDINGS, LLC, MYRTLE BEACH, SC. FILED 4-11-2006.

**HE'S NOT HERE
HNH
BARBER SPA FOR MEN**

NO CLAIM IS MADE TO THE EXCLUSIVE RIGHT TO USE "BARBER" AND "SPA FOR MEN", APART FROM THE MARK AS SHOWN.

THE MARK CONSISTS OF HE'S NOT HERE, FOLLOWED BY THE LETTERS HNH, FOLLOWED BY THE WORDS BARBER SPA FOR MEN. A DIAMOND SEPARATES THE WORDS BARBER AND SPA.

FOR HEALTH SPA SERVICES, NAMELY, COSMETIC BODY CARE SERVICES; MASSAGE AND BARBER SERVICES (U.S. CLS. 100 AND 101).

FIRST USE 6-1-2004; IN COMMERCE 6-1-2004.
DAVID COLLIER, EXAMINING ATTORNEY

CLASS 44—(Continued).

SN 78-859,603. MANCE, HOLLY A, ALABASTER, AL. FILED 4-12-2006.

Aurissage

THE MARK CONSISTS OF STANDARD CHARACTERS WITHOUT CLAIM TO ANY PARTICULAR FONT, STYLE, SIZE, OR COLOR.

FOR INFORMATION RELATING TO MASSAGE (U.S. CLS. 100 AND 101).

FIRST USE 10-10-2005; IN COMMERCE 2-15-2006.
NAKIA HENRY, EXAMINING ATTORNEY

CLASS 44—(Continued).

SN 78-862,338. VENICE NUTRITION, INC., VALENCIA, CA. FILED 4-16-2006.



THE COLOR(S) YELLOW, BLUE, AND ORANGE IS/ARE CLAIMED AS A FEATURE OF THE MARK.

THE MARK CONSISTS OF THE TOP MOST PORTION OF THE MARK CONSISTS OF A STYLIZED YELLOW "V" ON TOP OF A STYLIZED BLUE "N". BELOW THAT ARE THE WORDS "CLUB VENICE" THAT ARE ALL OUTLINED IN BLUE. WITHIN THE BLUE OUTLINE, THE TOPS OF THE LETTERS ARE YELLOW, WITH THE YELLOW BECOMING DARKER FADING INTO ORANGE AT THE BOTTOM OF THE LETTERS.

FOR PROVIDING AN ON-LINE COMPUTER DATABASE IN THE FIELD OF NUTRITION COUNSELING (U.S. CLS. 100 AND 101).

FIRST USE 3-1-2006; IN COMMERCE 3-1-2006.
KATHERINE CHANG, EXAMINING ATTORNEY

SN 78-860,135. DMI TRANSITIONS, INC., BRECKSVILLE, OH. FILED 4-12-2006.

REFLECTIONS

THE MARK CONSISTS OF STANDARD CHARACTERS WITHOUT CLAIM TO ANY PARTICULAR FONT, STYLE, SIZE, OR COLOR.

OWNER OF U.S. REG. NOS. 1,404,457 AND 1,518,528.
FOR PROFESSIONAL AND TECHNICAL MEDICAL RADIOLOGY SERVICES, NAMELY, DIAGNOSTIC RADIOLOGY, ULTRASOUND, MAMMOGRAPHY, PET SCANS, CT SCANS, MRI SCANS, NUCLEAR MEDICINE, INTERVENTIONAL RADIOLOGY, AND OTHER MEDICAL RADIOLOGY SERVICES USED TO PRODUCE IMAGES OF THE HUMAN BODY AND ITS ORGANS (U.S. CLS. 100 AND 101).

FIRST USE 10-11-1985; IN COMMERCE 10-11-1985.
HANNO RITTNER, EXAMINING ATTORNEY

SN 78-863,024. CAPLAN, JUDY, OAKTON, VA. FILED 4-17-2006.

GOOD NUTRITION IN A NUTSHELL

SN 78-860,815. BIOGRASS SOD FARMS, INC., SANDY, UT. FILED 4-13-2006.

THE SCIENCE OF GREAT SOD

THE MARK CONSISTS OF STANDARD CHARACTERS WITHOUT CLAIM TO ANY PARTICULAR FONT, STYLE, SIZE, OR COLOR.

FOR SOD FARM SERVICES; CONSULTING IN THE FIELD OF SOD FARMS; PLANT BREEDING IN THE FIELD OF SOD AND OTHER GROUND COVERS (U.S. CLS. 100 AND 101).

FIRST USE 10-18-2002; IN COMMERCE 10-18-2002.
TRAVIS WHEATLEY, EXAMINING ATTORNEY

THE MARK CONSISTS OF STANDARD CHARACTERS WITHOUT CLAIM TO ANY PARTICULAR FONT, STYLE, SIZE, OR COLOR.

NO CLAIM IS MADE TO THE EXCLUSIVE RIGHT TO USE "NUTRITION", APART FROM THE MARK AS SHOWN.

FOR DIETARY AND NUTRITIONAL GUIDANCE; FOOD NUTRITION CONSULTATION; NUTRITION COUNSELING (U.S. CLS. 100 AND 101).

FIRST USE 3-1-2006; IN COMMERCE 3-1-2006.
CARYN GLASSER, EXAMINING ATTORNEY

CLASS 44—(Continued).

SN 78-863,954. SHIRE HUMAN GENETIC THERAPIES, INC.,
CAMBRIDGE, MA. FILED 4-18-2006.



THE MARK CONSISTS OF THE WORDS ONEPATH AND THE WAY TO CARE AND THE DESIGN OF THREE CURVED, NESTED TRIANGULAR SHAPES, HAVING A CONVEX SIDE ON THE LEFT AND A CONCAVE SIDE ON THE RIGHT.

FOR PROVIDING HEALTH AND MEDICAL INFORMATION TO HUNTER'S SYNDROME PATIENTS, THEIR FAMILIES AND THEIR HEALTH CARE PROVIDERS; PROVIDING HEALTH CARE INFORMATION BY TELEPHONE AND THE INTERNET FEATURING INFORMATION RELATING TO HUNTER'S SYNDROME AND ENZYME DEFICIENCIES AND THE STEPS REQUIRED TO OBTAIN TREATMENT; PHARMACEUTICAL ADVICE; HEALTH CARE SERVICES, NAMELY, MONITORING AND REGULATING PATIENTS' COMPLIANCE WITH PRESCRIBED TREATMENT PROCEDURES IN THE FIELD OF ENZYME REPLACEMENT THERAPY (U.S. CLS. 100 AND 101).
DEZMONA MIZELLE, EXAMINING ATTORNEY

SN 78-864,137. US RADIOLOGY ON-CALL, SANTA MONICA, CA. FILED 4-18-2006.



NO CLAIM IS MADE TO THE EXCLUSIVE RIGHT TO USE "U.S. RADIOLOGY ON-CALL", APART FROM THE MARK AS SHOWN.

THE MARK CONSISTS OF STYLIZED WORDS "U.S. RADIOLOGY ON-CALL" WITH THE LETTERS U.S. IN A HOUSE SHAPED BOX.

FOR MEDICAL RADIOLOGY SERVICES (U.S. CLS. 100 AND 101).

FIRST USE 1-1-2002; IN COMMERCE 1-5-2002.
ANDREA EVANS, EXAMINING ATTORNEY

SN 78-864,375. D. MARINA JOHNSON MD, PA, DALLAS, TX.
FILED 4-19-2006.

SOLUTIONS, NOT SUPPRESSION

THE MARK CONSISTS OF STANDARD CHARACTERS WITHOUT CLAIM TO ANY PARTICULAR FONT, STYLE, SIZE, OR COLOR.

FOR MEDICAL SERVICES (U.S. CLS. 100 AND 101).
BARNEY CHARLON, EXAMINING ATTORNEY

CLASS 44—(Continued).

SN 78-864,497. HEAD COACH, LLC, SIMPSONVILLE, SC.
FILED 4-19-2006.

HEAD COACH

THE MARK CONSISTS OF STANDARD CHARACTERS WITHOUT CLAIM TO ANY PARTICULAR FONT, STYLE, SIZE, OR COLOR.

FOR HAIRCUTTING AND STYLING, NAMELY SPORTS-THEMED HAIRCUTTING SERVICES (U.S. CLS. 100 AND 101).

FIRST USE 3-31-2005; IN COMMERCE 3-31-2005.
CAROLYN CATALDO, EXAMINING ATTORNEY

SN 78-864,833. NORTHWEST COMMUNITY HOSPITAL,
ARLINGTON HEIGHTS, IL. FILED 4-19-2006.

Experience Excellence

THE MARK CONSISTS OF STANDARD CHARACTERS WITHOUT CLAIM TO ANY PARTICULAR FONT, STYLE, SIZE, OR COLOR.

FOR HOSPITALS; MEDICAL SERVICES (U.S. CLS. 100 AND 101).

FIRST USE 2-5-2006; IN COMMERCE 2-5-2006.
SONYA STEPHENS, EXAMINING ATTORNEY

SN 78-864,891. FEATHER TOUCH DENTISTRY, ALLEN, TX.
FILED 4-19-2006.

Feather Touch

THE MARK CONSISTS OF STANDARD CHARACTERS WITHOUT CLAIM TO ANY PARTICULAR FONT, STYLE, SIZE, OR COLOR.

FOR COSMETIC DENTISTRY; DENTISTRY (U.S. CLS. 100 AND 101).

FIRST USE 7-0-2000; IN COMMERCE 6-0-2001.
WILLIAM BRECKENFELD, EXAMINING ATTORNEY

CLASS 44—(Continued).

SN 78-865,807. SAVASENIORCARE ADMINISTRATIVE SERVICES, LLC, ATLANTA, GA. FILED 4-20-2006.



THE MARK CONSISTS OF THE STYLIZED LETTERS SSC.

FOR HEALTH CARE SERVICES, NAMELY, PROVIDING ASSISTED LIVING, RETIREMENT AND NURSING HOME SERVICES, IN-PATIENT HEALTH CARE AND OUT-PATIENT HEALTH CARE, NAMELY, COMPREHENSIVE MEDICAL AND PHYSICAL THERAPY AND REHABILITATION SERVICES AND PROVIDING NURSING AND HOSPICE SERVICES (U.S. CLS. 100 AND 101). FIRST USE 10-1-2005; IN COMMERCE 10-1-2005. LINDA ESTRADA, EXAMINING ATTORNEY

SN 78-866,663. DIETERS EDGE LLC, WOODBURY, CT. FILED 4-21-2006.



NO CLAIM IS MADE TO THE EXCLUSIVE RIGHT TO USE DIETERS, APART FROM THE MARK AS SHOWN.

THE MARK CONSISTS OF FIGURE WITH ARMS RAISED WITH SUN BURST BACKGROUND AND DIETERS EDGE BANNER.

FOR WEIGHT REDUCTION DIET PLANNING AND SUPERVISION (U.S. CLS. 100 AND 101). FIRST USE 6-1-2005; IN COMMERCE 7-1-2005. CAROLYN GRAY, EXAMINING ATTORNEY

CLASS 44—(Continued).

SN 78-867,979. SMITHKLINE BEECHAM CORPORATION, PHILADELPHIA, PA. FILED 4-24-2006.

PARKINSONSHOPE.COM

THE MARK CONSISTS OF STANDARD CHARACTERS WITHOUT CLAIM TO ANY PARTICULAR FONT, STYLE, SIZE, OR COLOR.

FOR ONLINE INFORMATION SERVICES PERTAINING TO THE TREATMENT AND MANAGEMENT OF PARKINSON'S DISEASE (U.S. CLS. 100 AND 101). DAYNA BROWNE, EXAMINING ATTORNEY

SN 78-868,422. SJMD SADECV, AUSTIN, TX. FILED 4-24-2006.

CANCEREND

THE MARK CONSISTS OF STANDARD CHARACTERS WITHOUT CLAIM TO ANY PARTICULAR FONT, STYLE, SIZE, OR COLOR.

FOR MEDICAL SERVICES (U.S. CLS. 100 AND 101). HOWARD B. LEVINE, EXAMINING ATTORNEY

SN 78-868,921. RIVERVIEW HOSPITAL, NOBELSVILLE, IN. FILED 4-25-2006.



FOR MEDICAL TESTING SERVICES, NAMELY, FITNESS EVALUATION (U.S. CLS. 100 AND 101). FIRST USE 2-2-2004; IN COMMERCE 2-2-2004. CHERYL CLAYTON, EXAMINING ATTORNEY

CLASS 44—(Continued).

SN 78-869,121. FOY, DAVID B., ANTHEM, AZ. FILED 4-25-2006.

INCREDIMED

THE MARK CONSISTS OF STANDARD CHARACTERS WITHOUT CLAIM TO ANY PARTICULAR FONT, STYLE, SIZE, OR COLOR.

FOR DRIVE THRU NON-URGENT MEDICAL CARE SERVICES (U.S. CLS. 100 AND 101).

DAVID C. REIHNER, EXAMINING ATTORNEY

SN 78-869,487. DIETERS EDGE LLC, WOODBURY, CT. FILED 4-25-2006.



NO CLAIM IS MADE TO THE EXCLUSIVE RIGHT TO USE DIETERS; PERMANENT WEIGHT MANAGEMENT, APART FROM THE MARK AS SHOWN.

THE MARK CONSISTS OF THE LOGO HAS A FIGURE WITH ARMS RAISED WITH A SUN BURST BEHIND THE FIGURE AND A BANNER WITH LETTERING DIETERS EDGE CURVING ACROSS THE FIGURE. THE WORDS PERMANENT WEIGHT MANAGEMENT FORM A CIRCULAR PATTERN AROUND THE FIGURE.

FOR WEIGHT REDUCTION DIET PLANNING AND SUPERVISION (U.S. CLS. 100 AND 101).

CAROLYN GRAY, EXAMINING ATTORNEY

SN 78-870,565. COTHERIX, INC., SOUTH SAN FRANCISCO, CA. FILED 4-26-2006.

**TRANSFORMING PAH
EXPERIENCE INTO
KNOWLEDGE**

THE MARK CONSISTS OF STANDARD CHARACTERS WITHOUT CLAIM TO ANY PARTICULAR FONT, STYLE, SIZE, OR COLOR.

FOR PROVIDING ELECTRONIC DATABASES FEATURING COLLECTED AND REVIEWED DISEASE MANAGEMENT INFORMATION IN THE FIELD OF PULMONARY ARTERIAL HYPERTENSION (U.S. CLS. 100 AND 101).

JASON ROTH, EXAMINING ATTORNEY

CLASS 44—(Continued).

SN 78-870,586. PACIFICSUN.LA SOLARIUM, LLC, SHERMAN OAKS, CA. FILED 4-26-2006.

MORE THAN JUST A TAN

THE MARK CONSISTS OF STANDARD CHARACTERS WITHOUT CLAIM TO ANY PARTICULAR FONT, STYLE, SIZE, OR COLOR.

FOR HEALTH SPA SERVICES, NAMELY, COSMETIC BODY CARE SERVICES; TANNING SALONS (U.S. CLS. 100 AND 101).

JASON ROTH, EXAMINING ATTORNEY

SN 78-871,177. MORTON, VICTORIA M., CLEARWATER, FL. FILED 4-27-2006.



OWNER OF U.S. REG. NOS. 2,212,248, 2,423,784 AND 2,897,782.

NO CLAIM IS MADE TO THE EXCLUSIVE RIGHT TO USE "THE BODY WRAP", APART FROM THE MARK AS SHOWN.

THE COLORS GOLD, BLUE, GRAY, TAN AND WHITE ARE CLAIMED AS A FEATURE OF THE MARK.

THE COLOR GOLD APPEARS IN THE PYRAMID, WITH THE FRONT SIDE OF THE PYRAMID LIGHTER THAN THE LOWER SIDE FACING TO THE RIGHT, THE COLOR BLUE APPEARS IN THE LINES FORMING A TRIANGLE SHOWN IN THE OVALS BELOW THE PYRAMID, THE COLOR GRAY APPEARS IN THE CONCENTRIC OVALS BELOW THE PYRAMID, THE COLOR TAN APPEARS IN THE WORDS THE BODY WRAP AND THE UNDERLINING BELOW THE, AND THE COLOR WHITE APPEARS AS THE BASE OF THE PYRAMID AND IN CONCENTRIC OVALS ALTERNATING WITH THE GRAY OVALS.

FOR SKIN CARE SALONS; WEIGHT REDUCTION DIET PLANNING AND SUPERVISION (U.S. CLS. 100 AND 101).

FIRST USE 2-23-2006; IN COMMERCE 2-23-2006.

ESTHER BELENKER, EXAMINING ATTORNEY

CLASS 44—(Continued).

SN 78-872,159. DERMIS SKIN CARE COMPANY, CHICAGO, IL. FILED 4-28-2006.



THE APPLICANT CLAIMS COLOR AS A FEATURE OF THE MARK, NAMELY, LILAC, BLUE, GREEN, YELLOW, RED, PINK, GREY, BLACK.

THE MARK CONSISTS OF A FLOWER ON THE LEFT SIDE (COLOR: LILAC, PINK, GREEN, BLUE, YELLOW, GREY, BLACK) AND OF THE LOWERCASE WORD "DERMIS" (COLOR: LILAC, PINK, THIN BLUE-BLACK BORDER AND GREY SHADES).

FOR COSMETOLOGY SERVICES (U.S. CLS. 100 AND 101).

FIRST USE 4-20-2006; IN COMMERCE 4-20-2006.

MATTHEW MCDOWELL, EXAMINING ATTORNEY

SN 78-873,804. COTHERIX, INC., SOUTH SAN FRANCISCO, CA. FILED 5-1-2006.

REVEAL

FOR PROVIDING ELECTRONIC DATABASES FEATURING COLLECTED AND REVIEWED DISEASE MANAGEMENT INFORMATION IN THE FIELD OF PULMONARY ARTERIAL HYPERTENSION (U.S. CLS. 100 AND 101).

JASON ROTH, EXAMINING ATTORNEY

SN 78-873,814. JD3 SOLUTIONS L.L.C., BROWNSBURG, IN. FILED 5-1-2006.

TIME 2 TRACK

FOR PROVIDING AN ON-LINE COMPUTER DATABASE IN THE FIELD OF MENTAL HEALTH SERVICES (U.S. CLS. 100 AND 101).

FIRST USE 3-15-2006; IN COMMERCE 3-15-2006.

JACQUELINE A. LAVINE, EXAMINING ATTORNEY

CLASS 44—(Continued).

SN 78-873,993. FRANKLIN SQUARE HOSPITAL CENTER, INC., BALTIMORE, MD. FILED 5-2-2006.

FRANKLIN SQUARE

THE MARK CONSISTS OF STANDARD CHARACTERS WITHOUT CLAIM TO ANY PARTICULAR FONT, STYLE, SIZE, OR COLOR.

SEC. 2(F).

FOR MEDICAL SERVICES; HOSPITAL SERVICES; HEALTH CARE SERVICES; PHYSICAL REHABILITATION SERVICES (U.S. CLS. 100 AND 101).

FIRST USE 6-13-1901; IN COMMERCE 6-13-1901.

SUSAN STIGLITZ, EXAMINING ATTORNEY

SN 78-874,286. ALLERGAN, INC., IRVINE, CA. FILED 5-2-2006.

SHAPE YOUR LIFE

THE MARK CONSISTS OF STANDARD CHARACTERS WITHOUT CLAIM TO ANY PARTICULAR FONT, STYLE, SIZE, OR COLOR.

FOR PROVIDING INFORMATION TO CONSUMERS AND PATIENTS CONCERNING MAKING THE DECISION TO HAVE A BREAST IMPLANT (U.S. CLS. 100 AND 101).

CATHERINE FAINT, EXAMINING ATTORNEY

SN 78-874,294. ALLERGAN, INC., IRVINE, CA. FILED 5-2-2006.

WOMEN IN TRANSFORMATION

THE MARK CONSISTS OF STANDARD CHARACTERS WITHOUT CLAIM TO ANY PARTICULAR FONT, STYLE, SIZE, OR COLOR.

NO CLAIM IS MADE TO THE EXCLUSIVE RIGHT TO USE "WOMEN", APART FROM THE MARK AS SHOWN.

FOR PROVIDING INFORMATION TO CONSUMERS CONCERNING MAKING THE DECISION TO HAVE A BREAST IMPLANT (U.S. CLS. 100 AND 101).

CATHERINE FAINT, EXAMINING ATTORNEY

CLASS 45—PERSONAL SERVICES

SN 76-628,863. RICHMOND, DWAYLON, MITCHELVILLE, MD. AND RICHMOND, LISA, MITCHELVILLE, MD. FILED 1-27-2005.



NO CLAIM IS MADE TO THE EXCLUSIVE RIGHT TO USE "MARYLAND" AND "SPORT RIDERS MC", APART FROM THE MARK AS SHOWN.

THE MARK CONSISTS OF A DOG WEARING CLOTHING SITTING ON A MOTORCYCLE WITH SQUARES AND CURVED LINES IN THE BACKGROUND. THE WORD MARYLAND APPEARS ABOVE THE DOG AND THE WORDING SPORT RIDERS MC APPEARS IN A BANNER BELOW THE DOG.

FOR "MOTORCYCLE CLUB SERVICES, NAMELY, SOCIAL CLUB SERVICES FOR MOTORCYCLE ENTHUSIASTS" (U.S. CLS. 100 AND 101).

FIRST USE 5-0-2004; IN COMMERCE 5-0-2004.
KRISTINA KLOIBER, EXAMINING ATTORNEY

SN 78-643,060. NATIONAL INTERFAITH CABLE COALITION, INC., NEW YORK, NY. FILED 6-3-2005.

CAMPUSQUEST

THE MARK CONSISTS OF STANDARD CHARACTERS WITHOUT CLAIM TO ANY PARTICULAR FONT, STYLE, SIZE, OR COLOR.

FOR PROVIDING INFORMATION IN THE FIELDS OF INTERFAITH DIALOGUES BY MEANS OF THE INTERNET (U.S. CLS. 100 AND 101).

FIRST USE 10-0-2004; IN COMMERCE 10-0-2004.
DOMINICK J. SALEMI, EXAMINING ATTORNEY

CLASS 45—(Continued).

SN 78-674,856. CHRIST THE GOOD SHEPHERD WORLDWIDE CHURCH, INC., TULSA, OK. FILED 7-20-2005.

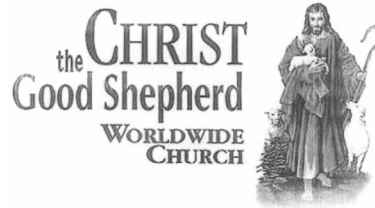

NO CLAIM IS MADE TO THE EXCLUSIVE RIGHT TO USE "CHRIST AND WORLDWIDE CHURCH", APART FROM THE MARK AS SHOWN.

THE STIPPLING IS FOR SHADING PURPOSES ONLY.

THE MARK CONSISTS OF "CHRIST" IN LARGE PRINT AND CAPITAL LETTERS WITH THE WORD "THE" TO "THE" LEFT OF IT ABOVE "GOOD SHEPHERD" IN SMALLER PRINT AND CAPS AND SMALL LETTERS ABOVE "WORLDWIDE CHURCH" IN ALL CAPS ALL NEXT TO A PICTURE OF JESUS AND A SHEEP.

FOR EVANGELISTIC AND MINISTERIAL SERVICES (U.S. CLS. 100 AND 101).

FIRST USE 1-1-2003; IN COMMERCE 1-1-2003.

ELISSA GARBER KON, EXAMINING ATTORNEY

SN 78-729,351. AMICA MIA, LLC, LAKE BLUFF, IL. FILED 10-7-2005.

AMICA MIA

THE MARK CONSISTS OF STANDARD CHARACTERS WITHOUT CLAIM TO ANY PARTICULAR FONT, STYLE, SIZE, OR COLOR.

THE FOREIGN WORDING IN THE MARK TRANSLATES INTO ENGLISH AS "MY FRIEND".

FOR PERSONAL GIFT SELECTION FOR OTHERS, PREPARATION OF CUSTOMIZED GIFT BASKETS (U.S. CLS. 100 AND 101).

FIRST USE 8-25-2004; IN COMMERCE 9-9-2004.

JENNIFER KRISP, EXAMINING ATTORNEY

CLASS 45—(Continued).

SN 78-740,733. LIFE-PRINTS SOLUTIONS, LLC, CRANBURY, NJ. FILED 10-26-2005.



FOR IDENTIFICATION VERIFICATION SERVICES, NAMELY, PROVIDING AUTHENTICATION OF VITAL DESCRIPTIVE PERSONAL IDENTIFICATION INFORMATION VIA SECURE STORAGE AND TRANSMITTING SUCH INFORMATION VIA THE INTERNET FOR AID IN LOCATING AND IDENTIFYING INDIVIDUAL CHILDREN OR ADULTS WHO BECOME MISSING; MISSING PERSON RECOVERY SERVICE, NAMELY, COLLECTING, ORGANIZING AND PROVIDING VITAL DESCRIPTIVE PERSONAL IDENTIFICATION INFORMATION AND STATISTICS, DIGITAL PHOTOGRAPHS, AND FINGERPRINTS OF INDIVIDUAL CHILDREN OR ADULTS USEFUL IN LOCATING AND IDENTIFYING INDIVIDUAL CHILDREN OR ADULTS WHO BECOME MISSING (U.S. CLS. 100 AND 101).

FIRST USE 9-6-2005; IN COMMERCE 9-6-2005.
MARIAM MAHMOUDI, EXAMINING ATTORNEY

SN 78-756,569. C.A.T.S. COMMUNICATION INC, IRVINE, CA. FILED 11-17-2005.

CAT TRAX

THE MARK CONSISTS OF STANDARD CHARACTERS WITHOUT CLAIM TO ANY PARTICULAR FONT, STYLE, SIZE, OR COLOR.

FOR GPS TRACKING SERVICES, NAMELY, MONITORING AND TRACKING THE LOCATION OF CHILDREN AND ADULT HUMANS (U.S. CLS. 100 AND 101).

FIRST USE 12-13-2005; IN COMMERCE 12-13-2005.
SUSAN STIGLITZ, EXAMINING ATTORNEY

SN 78-761,111. SOLE SOLUTIONS LLC, PLANO, TX. FILED 11-27-2005.

Just take it!

THE MARK CONSISTS OF STANDARD CHARACTERS WITHOUT CLAIM TO ANY PARTICULAR FONT, STYLE, SIZE, OR COLOR.

FOR PROVIDING USER AUTHENTICATION SERVICES IN E-COMMERCE TRANSACTIONS (U.S. CLS. 100 AND 101).

FIRST USE 11-26-2005; IN COMMERCE 11-26-2005.
ALICE BENMAMAN, EXAMINING ATTORNEY

CLASS 45—(Continued).

SN 78-792,870. GENWORTH MORTGAGE HOLDINGS, LLC, RALEIGH, NC. FILED 1-17-2006.

SECUREFIRST

THE MARK CONSISTS OF STANDARD CHARACTERS WITHOUT CLAIM TO ANY PARTICULAR FONT, STYLE, SIZE, OR COLOR.

FOR ELECTRONIC FRAUD DETECTION SERVICES IN THE FIELD OF MORTGAGE LOANS (U.S. CLS. 100 AND 101).

FIRST USE 3-1-2005; IN COMMERCE 3-13-2005.
KATINA MISTER, EXAMINING ATTORNEY

SN 78-811,269. MYCRIB, INC., WALNUT CREEK, CA. FILED 2-9-2006.

MYCrib

FOR INTERNET BASED SOCIAL NETWORKING SERVICES (U.S. CLS. 100 AND 101).

FIRST USE 1-29-2006; IN COMMERCE 1-29-2006.
DOMINICK J. SALEMI, EXAMINING ATTORNEY

SN 78-818,938. CHRIST IN YOUTH, INC., JOPLIN, MO. FILED 2-20-2006.

SuperStart

THE MARK CONSISTS OF STANDARD CHARACTERS WITHOUT CLAIM TO ANY PARTICULAR FONT, STYLE, SIZE, OR COLOR.

FOR CONDUCTING RELIGIOUS AND CHURCH SERVICES TO PROMOTE CHRISTIAN BELIEFS, NAMELY EVANGELISTIC AND MINISTERIAL SERVICES, CHILDREN'S MINISTRY SERVICES, YOUTH MINISTRY SERVICES, RELIGIOUS COUNSELING SERVICES (U.S. CLS. 100 AND 101).

TIMOTHY FINNEGAN, EXAMINING ATTORNEY

CLASS 45—(Continued).

SN 78-821,225. KEY FIRE INVESTIGATIONS, INC., GREENWOOD, IN. FILED 2-22-2006.

"From Ashes to Answers"

THE MARK CONSISTS OF STANDARD CHARACTERS WITHOUT CLAIM TO ANY PARTICULAR FONT, STYLE, SIZE, OR COLOR.

FOR INVESTIGATION SERVICES RELATED TO INSURANCE CLAIMS (U.S. CLS. 100 AND 101).
FIRST USE 6-29-2000; IN COMMERCE 6-29-2000.
SARAH WAYDA, EXAMINING ATTORNEY

SN 78-823,856. ONE SCOTTSDALE HOLDINGS LLC, SCOTTSDALE, AZ. FILED 2-27-2006.



ONE SCOTTSDALE

NO CLAIM IS MADE TO THE EXCLUSIVE RIGHT TO USE "SCOTTSDALE", APART FROM THE MARK AS SHOWN.

FOR CONCIERGE SERVICES FOR OTHERS COMPRISING MAKING REQUESTED PERSONAL ARRANGEMENTS AND RESERVATIONS AND PROVIDING CUSTOMER-SPECIFIC INFORMATION TO MEET INDIVIDUAL NEEDS RENDERED TOGETHER IN A MIXED USE ENVIRONMENT OF RESIDENTIAL, CORPORATE AND COMMERCIAL BUSINESSES; HOTEL CONCIERGE SERVICES (U.S. CLS. 100 AND 101).
CAROLYN CATALDO, EXAMINING ATTORNEY

CLASS 45—(Continued).

SN 78-829,355. ALLAN, COREY D., ALLEN, TX. FILED 3-4-2006.

Marriage Fully Alive

THE MARK CONSISTS OF STANDARD CHARACTERS WITHOUT CLAIM TO ANY PARTICULAR FONT, STYLE, SIZE, OR COLOR.

NO CLAIM IS MADE TO THE EXCLUSIVE RIGHT TO USE "MARRIAGE", APART FROM THE MARK AS SHOWN.
FOR MARRIAGE COUNSELING SERVICES; MINISTERING TO MARRIAGES, NAMELY, COUNSELING SERVICES IN THE FIELD OF CHRISTIAN CONDUCT IN PERSONAL RELATIONSHIPS (U.S. CLS. 100 AND 101).

AMY ALFIERI, EXAMINING ATTORNEY

SN 78-838,527. NATIONAL ALERT REGISTRY, DELAND, FL. FILED 3-16-2006.

BE AWARE · BE ALERT · BE SAFE

THE MARK CONSISTS OF STANDARD CHARACTERS WITHOUT CLAIM TO ANY PARTICULAR FONT, STYLE, SIZE, OR COLOR.

FOR PROVIDING ONLINE INFORMATION ABOUT SEX OFFENDERS; PROVIDING INFORMATION ABOUT SEX OFFENDERS (U.S. CLS. 100 AND 101).

FIRST USE 9-22-2003; IN COMMERCE 9-22-2003.
JOHN DWYER, EXAMINING ATTORNEY

SN 78-844,778. LEVS, JOSHUA, ATLANTA, GA. FILED 3-23-2006.

PROPOSE LIKE A STUD

THE MARK CONSISTS OF STANDARD CHARACTERS WITHOUT CLAIM TO ANY PARTICULAR FONT, STYLE, SIZE, OR COLOR.

NO CLAIM IS MADE TO THE EXCLUSIVE RIGHT TO USE PROPOSE, APART FROM THE MARK AS SHOWN.

FOR MARRIAGE PROPOSAL CONSULTING IN THE NATURE OF ASSISTING MEN AND WOMEN TO CREATE, PLAN, PREPARE AND EXECUTE PROPOSALS OF MARRIAGE (U.S. CLS. 100 AND 101).

FRED CARL, EXAMINING ATTORNEY

CLASS 45—(Continued).

SN 78-844,782. LEVS, JOSHUA, ATLANTA, GA. FILED 3-23-2006.

CLASS 45—(Continued).

SN 78-853,954. EQUIPMENT FINDERS USA LLC, SAINT LEONARD, MD. FILED 4-4-2006.

MAGIC PROPOSALS



THE MARK CONSISTS OF STANDARD CHARACTERS WITHOUT CLAIM TO ANY PARTICULAR FONT, STYLE, SIZE, OR COLOR.

NO CLAIM IS MADE TO THE EXCLUSIVE RIGHT TO USE PROPOSALS, APART FROM THE MARK AS SHOWN.

FOR MARRIAGE PROPOSAL CONSULTING IN THE NATURE OF ASSISTING MEN AND WOMEN TO CREATE, PLAN, PREPARE AND EXECUTE PROPOSALS OF MARRIAGE (U.S. CLS. 100 AND 101).

FIRST USE 1-25-2006; IN COMMERCE 1-25-2006.
FRED CARL, EXAMINING ATTORNEY

NO CLAIM IS MADE TO THE EXCLUSIVE RIGHT TO USE "USA," "EQUIPMENT FINDERS USA," OR THE REPRESENTATION OF THE MAP OF NORTH AMERICA AND PART OF SOUTH AMERICA, APART FROM THE MARK AS SHOWN.

FOR LOST AND STOLEN VEHICLE RECOVERY SERVICES (U.S. CLS. 100 AND 101).

ESTHER BELENKER, EXAMINING ATTORNEY

SN 78-850,672. MATCH PURSUITS LLC, FAIRFAX, VA. FILED 3-30-2006.

SN 78-857,716. SITTER SERVICES INC., SACRAMENTO, CA. FILED 4-10-2006.

LAWYERS IN LOVE



THE MARK CONSISTS OF STANDARD CHARACTERS WITHOUT CLAIM TO ANY PARTICULAR FONT, STYLE, SIZE, OR COLOR.

NO CLAIM IS MADE TO THE EXCLUSIVE RIGHT TO USE "LAWYERS", APART FROM THE MARK AS SHOWN. FOR ONLINE DATING SERVICES FOR LAWYERS (U.S. CLS. 100 AND 101).

FIRST USE 2-14-2005; IN COMMERCE 2-14-2005.
ROBERT STRUCK, EXAMINING ATTORNEY

NO CLAIM IS MADE TO THE EXCLUSIVE RIGHT TO USE "SITTER SERVICES, INC.", APART FROM THE MARK AS SHOWN.

FOR CHILD SITTING, HOUSE SITTING, COMPANIONSHIP SERVICES FOR ELDERLY (U.S. CLS. 100 AND 101).

FIRST USE 3-3-2006; IN COMMERCE 3-10-2006.
DAVID TAYLOR, EXAMINING ATTORNEY

CLASS 45—(Continued).

SN 78-859,976. BLUE RIDGE ELECTRIC COOPERATIVE, PICKENS, SC. FILED 4-12-2006.

BLUELINK24

THE MARK CONSISTS OF STANDARD CHARACTERS WITHOUT CLAIM TO ANY PARTICULAR FONT, STYLE, SIZE, OR COLOR.

FOR SECURITY SYSTEM SERVICES, NAMELY, MONITORING TELEPHONE AND RADIO TRANSCEIVER CALLS FROM SUBSCRIBERS AND NOTIFYING EMERGENCY FACILITIES, MONITORING SECURITY SYSTEMS, MONITORING BURGLAR AND SECURITY ALARMS AND ALARM RESPONSE AND VERIFICATION SERVICES (U.S. CLS. 100 AND 101).

FIRST USE 3-31-2006; IN COMMERCE 3-31-2006.
JOHN SCHUYLER YARD, EXAMINING ATTORNEY

CLASS 45—(Continued).

SN 78-860,869. SOLES4SOULS, INC., WADLEY, AL. FILED 4-13-2006.



THE COLOR(S) YELLOW, ORANGE, BLACK AND BLUE IS/ARE CLAIMED AS A FEATURE OF THE MARK.

THE MARK CONSISTS OF DESIGN OF A SHOE PRINT IN BLACK AND BLUE WITH A YELLOW AND ORANGE HALO ENCIRCLING THE TOE AND THE WORDS "SOLES 4 SOULS" IN BLUE.

FOR CHARITABLE SERVICES, NAMELY, PROVIDING SHOES TO NATURAL DISASTER VICTIMS (U.S. CLS. 100 AND 101).

FIRST USE 3-28-2006; IN COMMERCE 3-28-2006.
SETH A. RAPPAPORT, EXAMINING ATTORNEY

SN 78-862,366. BILSBORROW-KOO, RYAN T., DURHAM, NC. FILED 4-16-2006.

socialyte

THE MARK CONSISTS OF STANDARD CHARACTERS WITHOUT CLAIM TO ANY PARTICULAR FONT, STYLE, SIZE, OR COLOR.

FOR SOCIAL NETWORKING WEBSITE ENABLING USERS TO CREATE AND SHARE DATA ABOUT THEMSELVES, LOCATIONS, AND EVENTS (U.S. CLS. 100 AND 101).

CURTIS FRENCH, EXAMINING ATTORNEY

SN 78-860,669. BLUE RIDGE ELECTRIC COOPERATIVE, PICKENS, SC. FILED 4-13-2006.



SN 78-862,612. IDOLOGY, INC, ATLANTA, GA. FILED 4-17-2006.

ExpectID

THE MARK CONSISTS OF STANDARD CHARACTERS WITHOUT CLAIM TO ANY PARTICULAR FONT, STYLE, SIZE, OR COLOR.

FOR IDENTITY AND AGE VERIFICATION SERVICES (U.S. CLS. 100 AND 101).

FIRST USE 4-13-2006; IN COMMERCE 4-13-2006.
AMY GEARIN, EXAMINING ATTORNEY

FOR SECURITY SYSTEM SERVICES, NAMELY, MONITORING TELEPHONE AND RADIO TRANSCEIVER CALLS FROM SUBSCRIBERS AND NOTIFYING EMERGENCY FACILITIES, MONITORING SECURITY SYSTEMS, MONITORING BURGLAR AND SECURITY ALARMS, AND ALARM RESPONSE AND VERIFICATION SERVICES (U.S. CLS. 100 AND 101).

FIRST USE 3-31-2006; IN COMMERCE 3-31-2006.
JOHN SCHUYLER YARD, EXAMINING ATTORNEY

CLASS 45—(Continued).

SN 78-863,258. PUGH, SHAWANNA, FORESTVILLE, MD. AND SAUNDERS, PATRICIA, FORESTVILLE, MD. FILED 4-17-2006.

ComputerLove

THE MARK CONSISTS OF STANDARD CHARACTERS WITHOUT CLAIM TO ANY PARTICULAR FONT, STYLE, SIZE, OR COLOR.

FOR SOCIAL INTRODUCTION AGENCIES (U.S. CLS. 100 AND 101).
CAROL SPILS, EXAMINING ATTORNEY

CLASS 45—(Continued).

SN 78-867,049. MOMJUNCTION, INC., MORRISTOWN, NJ. FILED 4-21-2006.

MOMJUNCTION

THE MARK CONSISTS OF STANDARD CHARACTERS WITHOUT CLAIM TO ANY PARTICULAR FONT, STYLE, SIZE, OR COLOR.

FOR PROVIDING A WEBSITE FEATURING A SOCIAL NETWORKING SERVICE AND AN ONLINE COMMUNITY THAT CONNECTS NETWORKS OF MOTHERS (U.S. CLS. 100 AND 101).
DAVID TAYLOR, EXAMINING ATTORNEY

SN 78-865,920. JACKMAN FINANCIAL CORP., CHICAGO, IL. FILED 4-20-2006.

atneed.com

THE MARK CONSISTS OF STANDARD CHARACTERS WITHOUT CLAIM TO ANY PARTICULAR FONT, STYLE, SIZE, OR COLOR.

FOR FUNERAL SERVICE UNDERTAKING (U.S. CLS. 100 AND 101).
JEFF DEFORD, EXAMINING ATTORNEY

SN 78-871,104. CHOICEPOINT ASSET COMPANY, ALPHARETTA, GA. FILED 4-27-2006.

CADIA

THE MARK CONSISTS OF STANDARD CHARACTERS WITHOUT CLAIM TO ANY PARTICULAR FONT, STYLE, SIZE, OR COLOR.

FOR BACKGROUND CHECKING; BACKGROUND INVESTIGATION AND RESEARCH SERVICES; PRE-EMPLOYMENT BACKGROUND INVESTIGATION SERVICES; PRE-EMPLOYMENT BACKGROUND SCREENING (U.S. CLS. 100 AND 101).
WILLIAM BRECKENFELD, EXAMINING ATTORNEY

SN 78-865,937. JACKMAN FINANCIAL CORP., CHICAGO, IL. FILED 4-20-2006.

AT-NEED

THE MARK CONSISTS OF STANDARD CHARACTERS WITHOUT CLAIM TO ANY PARTICULAR FONT, STYLE, SIZE, OR COLOR.

FOR FUNERAL SERVICE UNDERTAKING (U.S. CLS. 100 AND 101).
JEFF DEFORD, EXAMINING ATTORNEY

SN 78-872,352. HITLIN, JOAN, EMERYVILLE, CA. FILED 4-28-2006.

MOJOTIVITY

THE MARK CONSISTS OF STANDARD CHARACTERS WITHOUT CLAIM TO ANY PARTICULAR FONT, STYLE, SIZE, OR COLOR.

FOR PERSONAL GROWTH AND MOTIVATION CONSULTING SERVICES (U.S. CLS. 100 AND 101).
FIRST USE 1-15-2006; IN COMMERCE 2-1-2006.
ELIZABETH PIGNATELLO, EXAMINING ATTORNEY

CLASS 45—(Continued).

SN 78-872,747. FULTON, CONCHETTA WHITE, NEW ORLEANS, LA. FILED 4-28-2006.

Chetiquette

THE MARK CONSISTS OF STANDARD CHARACTERS WITHOUT CLAIM TO ANY PARTICULAR FONT, STYLE, SIZE, OR COLOR.
FOR COUNSELING IN ETIQUETTE AND PROTOCOL (U.S. CLS. 100 AND 101).
MARTHA SANTOMARTINO, EXAMINING ATTORNEY

SN 78-875,477. BUSTED, INC., MARIETTA, GA. FILED 5-3-2006.

BUSTED

THE MARK CONSISTS OF STANDARD CHARACTERS WITHOUT CLAIM TO ANY PARTICULAR FONT, STYLE, SIZE, OR COLOR.
FOR PRIVATE DETECTIVE INVESTIGATIVE SERVICES (U.S. CLS. 100 AND 101).
FIRST USE 7-6-2004; IN COMMERCE 7-6-2004.
SARAH WAYDA, EXAMINING ATTORNEY

CLASS 45—(Continued).

SN 78-882,041. KOSKIMAKI, JASON, CARROLLTON, TX. FILED 5-12-2006.

YAP

THE MARK CONSISTS OF STANDARD CHARACTERS WITHOUT CLAIM TO ANY PARTICULAR FONT, STYLE, SIZE, OR COLOR.
FOR SOCIAL INTRODUCTION AGENCIES (U.S. CLS. 100 AND 101).
FIRST USE 3-17-2003; IN COMMERCE 3-17-2003.
SUSAN STIGLITZ, EXAMINING ATTORNEY

SN 78-957,352. MATCH PURSUITS LLC, FAIRFAX, VA. FILED 8-22-2006.



NO CLAIM IS MADE TO THE EXCLUSIVE RIGHT TO USE "LAWYERS", APART FROM THE MARK AS SHOWN. THE MARK CONSISTS OF A SCALE WITH TWO HEARTS AND TO THE RIGHT OF IT THE STYLIZED TEXT OF THE WORDING "LAWYERS IN LOVE".
FOR COMPUTER DATING SERVICES (U.S. CLS. 100 AND 101).
FIRST USE 2-14-2005; IN COMMERCE 2-14-2005.
ROBERT STRUCK, EXAMINING ATTORNEY

* * * * *

SECTION 4.—PRIOR UNITED STATES CLASSIFICATION

APPLICATION IN ONE CLASS

COLLECTIVE MEMBERSHIP MARKS

CLASS 200—COLLECTIVE MEMBERSHIP
SN 78-697,466. DELAY, STEPHEN, OMAHA, NE. FILED 8-22-2005.



NO CLAIM IS MADE TO THE EXCLUSIVE RIGHT TO USE "RIDERS GROUP", APART FROM THE MARK AS SHOWN.
FOR TO INDICATE MEMBERSHIP IN A MOTORCYCLE SOCIAL CLUB.
NELSON SNYDER, EXAMINING ATTORNEY

SN 78-789,187. HOME BUILDERS ASSOCIATION OF LEXINGTON, INC., LEXINGTON, KY. FILED 1-11-2006.



NO CLAIM IS MADE TO THE EXCLUSIVE RIGHT TO USE "HOME BUILDERS ASSOCIATION OF LEXINGTON", APART FROM THE MARK AS SHOWN.
THE COLOR(S) BLUE AND GREEN AND BLACK IS/ARE CLAIMED AS A FEATURE OF THE MARK.
THE 'HB' IS BLUE, THE HOUSE IS GREEN, AND ALL OTHER WORDING IS BLACK.
FOR INDICATING MEMBERSHIP IN A(N) TRADE ASSOCIATION INVOLVED IN THE RESIDENTIAL DEVELOPMENT, CONSTRUCTION AND REMODELING INDUSTRY.
AISHA CLARKE, EXAMINING ATTORNEY

SN 78-836,924. FINANCIAL EXECUTIVES INTERNATIONAL, FLORHAM PARK, NJ. FILED 3-14-2006.



OWNER OF U.S. REG. NOS. 822,400, 3,125,952 AND OTHERS.
THE COLORS BLUE AND GREEN IS/ARE CLAIMED AS A FEATURE OF THE MARK.
THE MARK CONSISTS OF A DESIGN ON AN EAGLE IN FLIGHT WITH FOUR FEATHER-LIKE SHAPES IN BLUE ON THE LEFT PART OF THE DESIGN AND FOUR FEATHER-LIKE SHAPES IN GREEN ON THE RIGHT PART OF THE DESIGN. THE EAGLE DESIGN IS CIRCULAR IN SHAPE. IMMEDIATELY TO THE RIGHT OF THE EAGLE DESIGN ARE THE STYLIZED LOWER CASE LETTERS "FEI" WRITTEN IN BLUE.
FOR INDICATING MEMBERSHIP OF A(N) ASSOCIATION FOR CORPORATE FINANCIAL EXECUTIVES.
FIRST USE 11-3-2000; IN COMMERCE 11-3-2000.
SANI KHOURI, EXAMINING ATTORNEY

CERTIFICATION MARKS

CLASS B—SERVICES

SN 78-763,877. PINK SHEETS LLC, NEW YORK, NY. FILED 11-30-2005.



THE MARK CONSISTS OF STANDARD CHARACTERS WITHOUT CLAIM TO ANY PARTICULAR FONT, STYLE, SIZE, OR COLOR.
THE CERTIFICATION MARK IS INTENDED TO BE USED BY AUTHORIZED PERSONS TO CERTIFY THAT IN CERTIFIER'S OPINION AND IN ACCORDANCE WITH CERTIFIER'S PUBLISHED STANDARDS, THE ISSUER OF THE SUBJECT SECURITY IS OF THE SIZE AND QUALITY TO LIST ON A NATIONAL STOCK EXCHANGE.
FOR FINANCIAL INVESTMENT SERVICES IN THE FORM OF FINANCIAL SECURITIES, NAMELY STOCKS.
JESSICA A. POWERS, EXAMINING ATTORNEY

SN 78-820,287. ACCREDITATION COMMISSION FOR HEALTH CARE, INC., RALEIGH, NC. FILED 2-22-2006.



ACCREDITED

NO CLAIM IS MADE TO THE EXCLUSIVE RIGHT TO USE "ACCREDITED", APART FROM THE MARK AS SHOWN.

THE COLOR(S) DARK GREEN, LIGHT GREEN, WHITE, AND BLACK IS/ARE CLAIMED AS A FEATURE OF THE MARK.

THE COLOR DARK GREEN APPEARS IN THE BACKGROUND OF THE SQUARE AND IN THE BORDER OUTLINING THE SQUARE, THE COLOR LIGHT GREEN APPEARS IN THE COLUMN DESIGN, THE COLOR WHITE APPEARS IN THE LETTERS ACHC AND IN THE BORDER OF THE SQUARE, AND THE COLOR BLACK APPEARS IN THE WORDING ACCREDITED LOCATED BELOW AND OUTSIDE THE SQUARE BOX.

THE CERTIFICATION MARK, AS USED BY PERSONS AUTHORIZED BY THE CERTIFIER, CERTIFIES THAT THE PERSONS DISPLAYING THE MARK HAVE DEMONSTRATED, THROUGH AN APPLICATION AND ON-SITE SURVEY, THAT THEY SATISFY THE STANDARDS OF THE CERTIFIER TO BE OF HIGH QUALITY, PROFESSIONAL AND EFFICIENT HEALTH CARE.

FOR HEALTH CARE SERVICES INCLUDING HOME CARE AIDE, HOME HEALTH, INFUSION NURSING, CLINICAL RESPIRATORY CARE, HOSPICE, MEDICAL SUPPLY PROVIDER, REHABILITATION TECHNOLOGY SUPPLY PROVIDER, RESPIRATORY NEBULIZER MEDICATION, PHARMACY, POST MASTECTOMY FITTER SERVICES FOR BREAST CANCER SURGERY RELATED PRODUCTS, AMBULATORY INFUSION CENTER, HOME/DURABLE MEDICAL EQUIPMENT, PRIVATE DUTY NURSING, AND PRIVATE DUTY AIDE SERVICES.

FIRST USE 9-27-2005; IN COMMERCE 9-27-2005. ATTIYA MALIK, EXAMINING ATTORNE

* * * * *

TRADEMARK REGISTRATIONS ISSUED

PRINCIPAL REGISTER

SECTION 1.— INTERNATIONAL CLASSIFICATION

The short titles associated below with the international class numbers are terms designed merely for quick identification and are not an official part of the international classification. The full names of international classes are given in section 6.1 of the trademark rules of practice.

The designation "U.S. Cl." appearing in this section refers to the U.S. class in effect prior to Sep. 1, 1973 rather than the international class which applies to applications filed on or after that date. For adoption of international classification see notice in the OFFICIAL GAZETTE of Jun. 26, 1973 (911 O.G. TM 210).

CLASS 1—CHEMICALS

- 3,175,827. **SAVINGS ARE REAL WITH POLY-TUFF (BLOCK FORM)**, POLY-TUFF SYSTEMS INTERNATIONAL CORPORATION, (U.S. CLS. 1, 5, 6, 10, 26 AND 46). SN 76-616,701. PUB. 9-12-2006. FILED 10-20-2004.
- 3,176,026. **HI-WETT (BLOCK FORM)**, ELLIOTT CHEMICALS LIMITED, (U.S. CLS. 1, 5, 6, 10, 26 AND 46). SN 78-475,539. PUB. 9-12-2006. FILED 8-30-2004.
- 3,176,213. **M MARICHEM MARIGASES WORLDWIDE SERVICES AND DESIGN**, MARICHEM MARIGASES HELLAS LTD., MULTIPLE CLASS, (INT. CLS. 1, 2 AND 3), (U.S. CLS. 1, 4, 5, 6, 10, 11, 16, 26, 46, 50, 51 AND 52). SN 78-618,528. PUB. 9-12-2006. FILED 4-27-2005.
- 3,176,438. **MEGAPOL (BLOCK FORM)**, HANDY CHEMICALS LIMITED, (U.S. CLS. 1, 5, 6, 10, 26 AND 46). SN 78-681,743. PUB. 9-12-2006. FILED 7-29-2005.
- 3,176,513. **REACTOPAQUE (BLOCK FORM)**, OMNOVA SOLUTIONS INC., (U.S. CLS. 1, 5, 6, 10, 26 AND 46). SN 78-714,800. PUB. 9-12-2006. FILED 9-16-2005.
- 3,176,629. **MISCELLANEOUS DESIGN**, ROTUBA EXTRUDERS, INC., (U.S. CLS. 1, 5, 6, 10, 26 AND 46). SN 78-749,804. PUB. 9-12-2006. FILED 11-8-2005.
- 3,176,656. **THE STABILIZED NITROGEN CYCLE AND DESIGN**, AGROTAIN INTERNATIONAL, LLC, (U.S. CLS. 1, 5, 6, 10, 26 AND 46). SN 78-756,180. PUB. 9-12-2006. FILED 11-17-2005.
- 3,176,717. **VALLEY "ULTRA-THIN" (BLOCK FORM)**, VALLEY RESEARCH, INC., (U.S. CLS. 1, 5, 6, 10, 26 AND 46). SN 78-772,851. PUB. 9-12-2006. FILED 12-14-2005.
- 3,177,030. **FRESH 'N CLEAR (BLOCK FORM)**, LESLIE'S POOLMART, INC., (U.S. CLS. 1, 5, 6, 10, 26 AND 46). SN 78-793,675. PUB. 9-12-2006. FILED 1-18-2006.
- 3,177,064. **STEALTH MARK (BLOCK FORM)**, SMI HOLDINGS, INC., (U.S. CLS. 1, 5, 6, 10, 26 AND 46). SN 78-794,552. PUB. 9-12-2006. FILED 1-19-2006.
- 3,177,149. **POOL LOGIC (BLOCK FORM)**, ALLIANCE TRADING, INC., (U.S. CLS. 1, 5, 6, 10, 26 AND 46). SN 78-809,804. PUB. 9-12-2006. FILED 2-8-2006.
- 3,177,214. **MISCELLANEOUS DESIGN**, MIDAS PHARMA GMBH, MULTIPLE CLASS, (INT. CLS. 1, 3, 5, 35, 36, 40 AND 42), (U.S. CLS. 1, 4, 5, 6, 10, 18, 26, 44, 46, 50, 51, 52, 100, 101, 102, 103 AND 106). SN 79-010,950. PUB. 9-12-2006. FILED 7-5-2004.
- 3,177,216. **MECACYL AND DESIGN**, ETS PERSYN- RIMA SARL, (U.S. CLS. 1, 5, 6, 10, 26 AND 46). SN 79-011,220. PUB. 9-12-2006. FILED 3-29-2005.
- 3,177,217. **SOLESENCE (BLOCK FORM)**, FIRMENICH SA, MULTIPLE CLASS, (INT. CLS. 1 AND 30), (U.S. CLS. 1, 5, 6, 10, 26 AND 46). SN 79-011,329. PUB. 9-12-2006. FILED 6-1-2005.
- 3,177,238. **B-COOL (BLOCK FORM)**, BLASER SWISSLUBE AG, MULTIPLE CLASS, (INT. CLS. 1 AND 4), (U.S. CLS. 1, 5, 6, 10, 15, 26 AND 46). SN 79-013,142. PUB. 9-12-2006. FILED 6-20-2005.
- 3,177,265. **POLYENE (BLOCK FORM)**, KERAKOLL S.P.A., (U.S. CLS. 1, 5, 6, 10, 26 AND 46). SN 79-014,658. PUB. 9-12-2006. FILED 5-2-2005.
- 3,177,275. **QROP AND DESIGN**, SQM NORTH AMERICA CORPORATION, A NEW YORK CORPORATION, (U.S.

CLS. 1, 5, 6, 10, 26 AND 46). SN 79-015,467. PUB. 8-15-2006. FILED 4-18-2005.

- 3,177,280. **MISCELLANEOUS DESIGN**, ALFRED KÄRCHER GMBH & CO. KG, MULTIPLE CLASS, (INT. CLS. 1, 3, 5, 6, 7, 9, 11, 12, 20, 21, 22, 37 AND 42), (U.S. CLS. 1, 2, 4, 5, 6, 7, 10, 12, 13, 14, 18, 19, 21, 22, 23, 25, 26, 29, 30, 31, 32, 33, 34, 35, 36, 38, 40, 42, 44, 46, 50, 51, 52, 100, 101, 103 AND 106). SN 79-016,158. PUB. 9-12-2006. FILED 10-14-2004.
- 3,177,305. **ROWA GROUP (STYLIZED)**, ROWA GMBH ROHSTOFF WASCH- UND AUFBEREITUNGSWERK, MULTIPLE CLASS, (INT. CLS. 1, 2, 17 AND 42), (U.S. CLS. 1, 5, 6, 10, 11, 12, 13, 16, 26, 35, 46, 50, 100 AND 101). SN 79-018,649. PUB. 9-12-2006. FILED 3-23-2005.

CLASS 2—PAINTS

- 3,175,838. **CULINARY EXTRACTS AND DESIGN**, KALSEC, INC., MULTIPLE CLASS, (INT. CLS. 2 AND 30), (U.S. CLS. 6, 11, 16 AND 46). SN 76-636,550. PUB. 9-12-2006. FILED 4-20-2005.
- 3,175,942. **POLYCURE**, MIROTONE PTY LIMITED, (U.S. CLS. 6, 11 AND 16). SN 78-189,738. PUB. 5-10-2005. FILED 11-27-2002.
- 3,176,191. **XTREME (BLOCK FORM)**, THE TORO COMPANY, (U.S. CLS. 6, 11 AND 16). SN 78-608,417. PUB. 9-12-2006. FILED 4-14-2005.
- 3,176,213 (*See Class 1 for this trademark*).
- 3,176,759. **INTERIOR LO SLIP (BLOCK FORM)**, C.A.I., INC., (U.S. CLS. 6, 11 AND 16). SN 78-776,846. PUB. 9-12-2006. FILED 12-20-2005.
- 3,176,801. **AQUADECK (BLOCK FORM)**, SCOTT PAINT COMPANY, INC., (U.S. CLS. 6, 11 AND 16). SN 78-780,097. PUB. 9-12-2006. FILED 12-23-2005.
- 3,176,802. **SCRUBMASTER (BLOCK FORM)**, SCOTT PAINT COMPANY, INC., (U.S. CLS. 6, 11 AND 16). SN 78-780,165. PUB. 9-12-2006. FILED 12-23-2005.
- 3,176,823. **PATCHAL (BLOCK FORM)**, RPM WOOD FINISHES GROUP, INC., (U.S. CLS. 6, 11 AND 16). SN 78-781,642. PUB. 9-12-2006. FILED 12-28-2005.
- 3,177,303. **HEMUDUR (BLOCK FORM)**, HEMPEL A/S, (U.S. CLS. 6, 11 AND 16). SN 79-018,158. PUB. 9-12-2006. FILED 7-14-2005.
- 3,177,305 (*See Class 1 for this trademark*).

CLASS 3—COSMETICS AND CLEANING PREPARATIONS

- 3,175,762. **TALBOT RUNHOF**, RUNHOF, ADRIAN, AND TALBOT, JOHNNY, MULTIPLE CLASS, (INT. CLS. 3, 9, 14, 16, 20, 21, 23, 24, 25, 26, 27, 28, 35, 36, 42 AND 45), (U.S. CLS. 1, 2, 4, 5, 6, 13, 19, 20, 21, 22, 23, 25, 26, 27, 28, 29, 30, 32, 33, 36, 37, 38, 39, 40, 42, 43, 50, 51, 52, 100, 101 AND 102). SN 76-157,016. PUB. 9-12-2006. FILED 10-30-2000.
- 3,175,773. **BLUE AND DESIGN**, BRUNNER, BARBARA, (U.S. CLS. 1, 4, 6, 50, 51 AND 52). SN 76-420,975. PUB. 9-12-2006.

- FILED 6-14-2002.
- 3,175,798. **ESTRUS MIGENE GONZALEZ WIPPLER AND DESIGN. NIRVANA OF NEW YORK**, (U.S. CLS. 1, 4, 6, 50, 51 AND 52). SN 76-567,924. PUB. 9-12-2006. FILED 12-19-2003.
- 3,175,843. **DDF (STYLIZED)**. HDS COSMETICS LAB, INC., MULTIPLE CLASS, (INT. CLS. 3 AND 5), (U.S. CLS. 1, 4, 6, 18, 44, 46, 50, 51 AND 52). SN 76-638,650. PUB. 9-12-2006. FILED 5-17-2005.
- 3,175,854. **SKIN RX (BLOCK FORM)**. PATEL, EVA, (U.S. CLS. 1, 4, 6, 50, 51 AND 52). SN 76-641,025. PUB. 9-12-2006. FILED 6-7-2005.
- 3,175,891. **SPLISH SPLASH (BLOCK FORM)**. SPLISH SPLASH CLEANERS, INC., (U.S. CLS. 1, 4, 6, 50, 51 AND 52). SN 76-649,872. PUB. 9-12-2006. FILED 11-7-2005.
- 3,175,900. **DRAIN RELIEF (BLOCK FORM)**. BIOSTIM, L.L.C., (U.S. CLS. 1, 4, 6, 50, 51 AND 52). SN 76-652,201. PUB. 9-12-2006. FILED 12-20-2005.
- 3,175,911. **WEATHERGUARD (BLOCK FORM)**. DIAMOND SHINE, INC., (U.S. CLS. 1, 4, 6, 50, 51 AND 52). SN 76-652,639. PUB. 9-12-2006. FILED 12-29-2005.
- 3,175,924. **I APPLY (STYLIZED)**. ORLANDI, INC., (U.S. CLS. 1, 4, 6, 50, 51 AND 52). SN 76-653,100. PUB. 9-12-2006. FILED 1-9-2006.
- 3,175,964. **I LOVE MUSIC (BLOCK FORM)**. 19 ENTERTAINMENT LIMITED, MULTIPLE CLASS, (INT. CLS. 3, 6, 9, 14, 16, 18, 20, 21, 24, 25, 28 AND 41), (U.S. CLS. 1, 2, 3, 4, 5, 6, 12, 13, 14, 21, 22, 23, 25, 26, 27, 28, 29, 30, 32, 33, 36, 37, 38, 39, 40, 41, 42, 50, 51, 52, 100, 101 AND 107). SN 78-322,365. PUB. 9-12-2006. FILED 11-3-2003.
- 3,176,089. **KEYS (BLOCK FORM)**. ORION LEARNING INTERNATIONAL, INC., (U.S. CLS. 1, 4, 6, 50, 51 AND 52). SN 78-535,873. PUB. 9-12-2006. FILED 12-20-2004.
- 3,176,105. **DAY SPRING (BLOCK FORM)**. ENVIROTEK CORPORATION, (U.S. CLS. 1, 4, 6, 50, 51 AND 52). SN 78-553,012. PUB. 9-12-2006. FILED 1-24-2005.
- 3,176,120. **DKS DIVERSIFIED KITCHEN SOLUTIONS AND DESIGN. INSTREET ENTERPRISES, INC.**, MULTIPLE CLASS, (INT. CLS. 3, 11, 21 AND 37), (U.S. CLS. 1, 2, 4, 6, 13, 21, 23, 29, 30, 31, 33, 34, 40, 50, 51, 52, 100, 103 AND 106). SN 78-562,233. PUB. 9-12-2006. FILED 2-7-2005.
- 3,176,177. **MIGHTY TIDY (BLOCK FORM)**. MLIQUE PRODUCTIONS INC, (U.S. CLS. 1, 4, 6, 50, 51 AND 52). SN 78-602,011. PUB. 9-12-2006. FILED 4-5-2005.
- 3,176,192. **FAHRENHEIT DIOR AND DESIGN. PARFUMS CHRISTIAN DIOR**, (U.S. CLS. 1, 4, 6, 50, 51 AND 52). SN 78-608,891. PUB. 9-12-2006. FILED 4-14-2005.
- 3,176,194. **DIOR HOMME DIOR AND DESIGN. PARFUMS CHRISTIAN DIOR**, (U.S. CLS. 1, 4, 6, 50, 51 AND 52). SN 78-609,162. PUB. 9-12-2006. FILED 4-14-2005.
- 3,176,213 (*See Class 1 for this trademark*).
- 3,176,262. **IOPS INSIDE OUT PERFECTING SYSTEM AND DESIGN. KAO KABUSHIKI KAISHA, TA KAO CORPORATION**, (U.S. CLS. 1, 4, 6, 50, 51 AND 52). SN 78-629,902. PUB. 9-12-2006. FILED 5-13-2005.
- 3,176,291. **IMMUNE PERFECT (BLOCK FORM)**. B & P COMPANY, INC., (U.S. CLS. 1, 4, 6, 50, 51 AND 52). SN 78-635,408. PUB. 9-12-2006. FILED 5-23-2005.
- 3,176,523. **FISH FOAM (BLOCK FORM)**. FISH WINDOW CLEANING SERVICES, INC., (U.S. CLS. 1, 4, 6, 50, 51 AND 52). SN 78-717,001. PUB. 9-12-2006. FILED 9-20-2005.
- 3,176,549. **OCCASIO THERAPY (BLOCK FORM)**. LITTLE THINGS, LLC, (U.S. CLS. 1, 4, 6, 50, 51 AND 52). SN 78-724,819. PUB. 9-12-2006. FILED 10-2-2005.
- 3,176,579. **OSMOXA AND DESIGN. LHASA OMS, INC.**, (U.S. CLS. 1, 4, 6, 50, 51 AND 52). SN 78-737,113. PUB. 9-12-2006. FILED 10-20-2005.
- 3,176,601. **KINO TOX INTERNATIONAL (BLOCK FORM)**. HEALTHY HABITS, LLC, MULTIPLE CLASS, (INT. CLS. 3 AND 5), (U.S. CLS. 1, 4, 6, 18, 44, 46, 50, 51 AND 52). SN 78-745,764. PUB. 9-12-2006. FILED 11-2-2005.
- 3,176,603. **O2BETA (STYLIZED)**. UNIVERSAL BIOLOGICS, INC., (U.S. CLS. 1, 4, 6, 50, 51 AND 52). SN 78-746,467. PUB. 9-12-2006. FILED 11-3-2005.
- 3,176,771. **SEGURA (BLOCK FORM)**. FINANCIERE CONTRAST S.A.S., MULTIPLE CLASS, (INT. CLS. 3, 9 AND 14), (U.S. CLS. 1, 2, 4, 6, 21, 23, 26, 27, 28, 36, 38, 50, 51 AND 52). SN 78-778,260. PUB. 9-12-2006. FILED 12-21-2005.
- 3,176,815. **PIONA (BLOCK FORM)**. GRAND STREAM ENTERPRISE, INC., (U.S. CLS. 1, 4, 6, 50, 51 AND 52). SN 78-781,050. PUB. 9-12-2006. FILED 12-27-2005.
- 3,176,840. **ENCHANTED AROMAS (BLOCK FORM)**. INTEGRATED BUSINESS SOLUTIONS, (U.S. CLS. 1, 4, 6, 50, 51 AND 52). SN 78-782,718. PUB. 9-12-2006. FILED 12-29-2005.
- 3,176,935. **GEM-SPARKLE AND DESIGN. SPEED BRITE, INC.**, (U.S. CLS. 1, 4, 6, 50, 51 AND 52). SN 78-788,540. PUB. 9-12-2006. FILED 1-10-2006.
- 3,177,036. **SACHA (BLOCK FORM)**. SACHA COSMETICS LIMITED, (U.S. CLS. 1, 4, 6, 50, 51 AND 52). SN 78-793,793. PUB. 9-12-2006. FILED 1-18-2006.
- 3,177,114. **AWIS (BLOCK FORM)**. YOUAKIM, FERIAL, (U.S. CLS. 1, 4, 6, 50, 51 AND 52). SN 78-797,366. PUB. 9-12-2006. FILED 1-23-2006.
- 3,177,150. **OLE HENRIKSEN (BLOCK FORM)**. OLE HENRIKSEN OF DENMARK, INC., (U.S. CLS. 1, 4, 6, 50, 51 AND 52). SN 78-810,272. PUB. 9-12-2006. FILED 2-8-2006.
- 3,177,194. **LA ROSE DE ROSINE (STYLIZED)**. LES PARFUMS DE ROSINE SOCIÉTÉ À RESPONSABILITÉ LIMITÉE, (U.S. CLS. 1, 4, 6, 50, 51 AND 52). SN 79-006,051. PUB. 9-12-2006. FILED 9-21-2004.
- 3,177,202. **SUN TRAINER (BLOCK FORM)**. INSTITUT ESTHEDERM, (U.S. CLS. 1, 4, 6, 50, 51 AND 52). SN 79-008,663. PUB. 9-12-2006. FILED 12-17-2004.
- 3,177,212. **24 FAUBOURG (BLOCK FORM)**. COMPTOIR NOUVEAU DE LA PARFUMERIE, (U.S. CLS. 1, 4, 6, 50, 51 AND 52). SN 79-010,816. PUB. 9-12-2006. FILED 4-25-2005.
- 3,177,214 (*See Class 1 for this trademark*).
- 3,177,222. **COMPASS AND DESIGN. "STS HOLDING GROUP" OOD**, MULTIPLE CLASS, (INT. CLS. 3, 8 AND 21), (U.S. CLS. 1, 2, 4, 6, 13, 23, 28, 29, 30, 33, 40, 44, 50, 51 AND 52). SN 79-011,742. PUB. 9-12-2006. FILED 11-11-2004.
- 3,177,229. **SKIN FILL MEDICAL COSMETIC RESEARCH MAVEGYD AND DESIGN. PROMOITALIA COSMETIC LINE S.R.L.**, MULTIPLE CLASS, (INT. CLS. 3 AND 5), (U.S. CLS. 1, 4, 6, 18, 44, 46, 50, 51 AND 52). SN 79-012,343. PUB. 9-12-2006. FILED 4-26-2005.
- 3,177,240. **OPTIDEE (BLOCK FORM)**. DIETER TIEN, MULTIPLE CLASS, (INT. CLS. 3, 5, 11, 20, 21 AND 24), (U.S. CLS. 1, 2, 4, 6, 13, 18, 21, 22, 23, 25, 29, 30, 31, 32, 33, 34, 40, 42, 44, 46, 50, 51 AND 52). SN 79-013,210. PUB. 9-12-2006. FILED 11-29-2004.
- 3,177,243. **I LIGHTIMPACT (STYLIZED)**. LIGHT IMPACT (U.K) LIMITED, MULTIPLE CLASS, (INT. CLS. 3, 4, 11 AND 21), (U.S. CLS. 1, 2, 4, 6, 13, 15, 21, 23, 29, 30, 31, 33, 34, 40, 50, 51 AND 52). SN 79-013,404. PUB. 9-12-2006. FILED 3-16-2005.
- 3,177,251. **Z.ONE CONCEPT (BLOCK FORM)**. PANZERI DIFFUSION S.R.L., MULTIPLE CLASS, (INT. CLS. 3, 8 AND 21), (U.S. CLS. 1, 2, 4, 6, 13, 23, 28, 29, 30, 33, 40, 44, 50, 51 AND 52). SN 79-013,652. PUB. 9-12-2006. FILED 4-15-2005.
- 3,177,252. **URBAN:TRIBE (BLOCK FORM)**. PANZERI DIFFUSION S.R.L., MULTIPLE CLASS, (INT. CLS. 3, 8 AND 21), (U.S. CLS. 1, 2, 4, 6, 13, 23, 28, 29, 30, 33, 40, 44, 50, 51 AND 52). SN 79-013,653. PUB. 9-12-2006. FILED 4-15-2005.
- 3,177,258. **EVE LOM DYNASPOT (BLOCK FORM)**. EVE LOM COMPLEXIONS CO LTD, (U.S. CLS. 1, 4, 6, 50, 51 AND 52). SN 79-014,160. PUB. 9-12-2006. FILED 6-22-2005.
- 3,177,280 (*See Class 1 for this trademark*).
- 3,177,309. **EMSIBETH (BLOCK FORM)**. EMSIBETH S.P.A., (U.S. CLS. 1, 4, 6, 50, 51 AND 52). SN 79-019,309. PUB. 9-12-2006. FILED 7-29-2005.

CLASS 4—LUBRICANTS AND FUELS

- 3,175,780. **CONTINENT OIL & GAS INDUSTRIES AND DESIGN. CONTINENT OIL, INC.**, MULTIPLE CLASS, (INT. CLS. 4 AND 35), (U.S. CLS. 1, 6, 15, 100, 101 AND 102). SN 76-525,310. PUB. 2-28-2006. FILED 6-17-2003.
- 3,175,996. **DI JET (STYLIZED)**. MOTUL, (U.S. CLS. 1, 6 AND 15). SN 78-427,844. PUB. 9-12-2006. FILED 6-1-2004.
- 3,176,354. **DUREX (BLOCK FORM)**. HAJ, INC., (U.S. CLS. 1, 6 AND 15). SN 78-651,988. PUB. 9-12-2006. FILED 6-16-2005.
- 3,176,763. **76 (BLOCK FORM)**. CONOCOPHILLIPS COMPANY, (U.S. CLS. 1, 6 AND 15). SN 78-777,430. PUB. 9-12-

2006. FILED 12-20-2005.
 3,176,781. **MAST - PETERS (BLOCK FORM)**. MAST - PETERS, LLC, (U.S. CLS. 1, 6 AND 15). SN 78-779,078. PUB. 9-12-2006. FILED 12-22-2005.
 3,176,813. **SPERMWAX (BLOCK FORM)**. BARNET PRODUCTS CORP., (U.S. CLS. 1, 6 AND 15). SN 78-780,949. PUB. 9-12-2006. FILED 12-27-2005.
 3,177,111. **SOYROMA (BLOCK FORM)**. SOY PRODUCTS INTERNATIONAL INC., (U.S. CLS. 1, 6 AND 15). SN 78-797,179. PUB. 9-12-2006. FILED 1-23-2006.
 3,177,238 (*See Class 1 for this trademark*).
 3,177,243 (*See Class 3 for this trademark*).

CLASS 5—PHARMACEUTICALS

- 3,175,843 (*See Class 3 for this trademark*).
 3,175,862. **HOODIAFAST (BLOCK FORM)**. HOODIAFAST INC., (U.S. CLS. 6, 18, 44, 46, 51 AND 52). SN 76-643,072. PUB. 9-12-2006. FILED 7-18-2005.
 3,175,955. **MACKWOODS**. MACKWOODS LIMITED, MULTIPLE CLASS, (INT. CLS. 5, 30, 35 AND 42), (U.S. CLS. 6, 18, 44, 46, 51, 52, 100, 101 AND 102). SN 78-275,091. PUB. 1-10-2006. FILED 7-16-2003.
 3,175,980. **MULTIPATH (BLOCK FORM)**. C GROUP, INC., THE, (U.S. CLS. 6, 18, 44, 46, 51 AND 52). SN 78-382,921. PUB. 9-12-2006. FILED 3-12-2004.
 3,175,987. **NEUROPRION (BLOCK FORM)**. COMMISSARIAT A L'ENERGIE ATOMIQUE, MULTIPLE CLASS, (INT. CLS. 5, 42 AND 44), (U.S. CLS. 6, 18, 44, 46, 51, 52, 100 AND 101). SN 78-396,640. PUB. 9-12-2006. FILED 4-5-2004.
 3,175,988. **ABASOL (BLOCK FORM)**. YORK PHARMA PLC, (U.S. CLS. 6, 18, 44, 46, 51 AND 52). SN 78-397,167. PUB. 9-12-2006. FILED 4-6-2004.
 3,175,997. **AMD AND DESIGN**. TYCO HEALTHCARE GROUP LP, MULTIPLE CLASS, (INT. CLS. 5 AND 10), (U.S. CLS. 6, 18, 26, 39, 44, 46, 51 AND 52). SN 78-428,751. PUB. 9-12-2006. FILED 6-2-2004.
 3,175,999. **B CLEAR (BLOCK FORM)**. B CLEAR, INC., (U.S. CLS. 6, 18, 44, 46, 51 AND 52). SN 78-430,455. PUB. 9-12-2006. FILED 6-4-2004.
 3,176,023. **COLIMUNE (BLOCK FORM)**. BIONICHE LIFE SCIENCES INC., (U.S. CLS. 6, 18, 44, 46, 51 AND 52). SN 78-474,180. PUB. 9-12-2006. FILED 8-26-2004.
 3,176,039. **CARE DIAGNOSTICA (BLOCK FORM)**. CARE DIAGNOSTICA PRODUKTIONS-UND VERTRIEBSGESELLSCHAFT M.B.H., (U.S. CLS. 6, 18, 44, 46, 51 AND 52). SN 78-487,968. PUB. 9-12-2006. FILED 9-22-2004.
 3,176,046. **SAN (BLOCK FORM)**. S.A.N CORPORATION, (U.S. CLS. 6, 18, 44, 46, 51 AND 52). SN 78-495,766. PUB. 9-12-2006. FILED 10-6-2004.
 3,176,077. **ZONVOY (BLOCK FORM)**. GLAXO GROUP LIMITED, (U.S. CLS. 6, 18, 44, 46, 51 AND 52). SN 78-526,176. PUB. 9-12-2006. FILED 12-2-2004.
 3,176,110. **NEURO CAMPOLON ENERGY (BLOCK FORM)**. LABORATORIOS VIJOSA, S.A. DE C.V., (U.S. CLS. 6, 18, 44, 46, 51 AND 52). SN 78-557,034. PUB. 6-27-2006. FILED 1-31-2005.
 3,176,136. **LYCOPENE ADVANCED (BLOCK FORM)**. PHARMAVITE, LLC, (U.S. CLS. 6, 18, 44, 46, 51 AND 52). SN 78-578,265. PUB. 9-12-2006. FILED 3-2-2005.
 3,176,139. **RELIAMED (BLOCK FORM)**. RGH ENTERPRISES, INC., (U.S. CLS. 6, 18, 44, 46, 51 AND 52). SN 78-581,575. PUB. 9-12-2006. FILED 3-7-2005.
 3,176,170. **ENER GI (BLOCK FORM)**. VIRTUS NUTRITION, LLC, (U.S. CLS. 6, 18, 44, 46, 51 AND 52). SN 78-599,503. PUB. 9-12-2006. FILED 3-31-2005.
 3,176,176. **CRECI-12 (BLOCK FORM)**. MENPER DISTRIBUTORS INC., (U.S. CLS. 6, 18, 44, 46, 51 AND 52). SN 78-601,933. PUB. 9-12-2006. FILED 4-5-2005.
 3,176,224. **DYNAGRAFT (STYLIZED)**. ISOTIS ORTHOBIOLOGICS, INC., MULTIPLE CLASS, (INT. CLS. 5 AND 10), (U.S. CLS. 6, 18, 26, 39, 44, 46, 51 AND 52). SN 78-623,292. PUB. 9-12-2006. FILED 5-4-2005.
 3,176,296. **ARTRAMIN AND DESIGN**. HERBALUXX CORP., (U.S. CLS. 6, 18, 44, 46, 51 AND 52). SN 78-636,406. PUB. 9-12-2006. FILED 5-24-2005.
 3,176,299. **ORAMAGIC PLUS (BLOCK FORM)**. MPM MEDICAL, INC., (U.S. CLS. 6, 18, 44, 46, 51 AND 52). SN 78-637,118. PUB. 9-12-2006. FILED 5-25-2005.
 3,176,320. **NUTRAMIRACLE (BLOCK FORM)**. SIELECKI, LEONARD E, (U.S. CLS. 6, 18, 44, 46, 51 AND 52). SN 78-640,863. PUB. 9-12-2006. FILED 6-1-2005.
 3,176,374. **GLYCOTEA (BLOCK FORM)**. INNOVATIVE TECHNOLOGIES CORPORATION OF AMERICA, INC, (U.S. CLS. 6, 18, 44, 46, 51 AND 52). SN 78-656,271. PUB. 9-12-2006. FILED 6-22-2005.
 3,176,380. **VAMOOSE (BLOCK FORM)**. SULLIVAN, TIMOTHY, (U.S. CLS. 6, 18, 44, 46, 51 AND 52). SN 78-657,522. PUB. 9-12-2006. FILED 6-24-2005.
 3,176,397. **DR. THEO'S (BLOCK FORM)**. SUPPLEMENT TESTING INSTITUTE, INC., (U.S. CLS. 6, 18, 44, 46, 51 AND 52). SN 78-661,124. PUB. 9-12-2006. FILED 6-29-2005.
 3,176,413. **LECTEMIV (BLOCK FORM)**. GLAXO GROUP LIMITED, (U.S. CLS. 6, 18, 44, 46, 51 AND 52). SN 78-667,481. PUB. 9-12-2006. FILED 7-11-2005.
 3,176,415. **VONAREC (BLOCK FORM)**. GLAXO GROUP LIMITED, (U.S. CLS. 6, 18, 44, 46, 51 AND 52). SN 78-667,644. PUB. 9-12-2006. FILED 7-11-2005.
 3,176,416. **ZERNILOR (BLOCK FORM)**. GLAXO GROUP LIMITED, (U.S. CLS. 6, 18, 44, 46, 51 AND 52). SN 78-667,648. PUB. 9-12-2006. FILED 7-11-2005.
 3,176,417. **ZUPERON (BLOCK FORM)**. GLAXO GROUP LIMITED, (U.S. CLS. 6, 18, 44, 46, 51 AND 52). SN 78-667,652. PUB. 9-12-2006. FILED 7-11-2005.
 3,176,511. **4-PLUS (BLOCK FORM)**. ALBION LABORATORIES, INC., MULTIPLE CLASS, (INT. CLS. 5 AND 31), (U.S. CLS. 1, 6, 18, 44, 46, 51 AND 52). SN 78-714,595. PUB. 9-12-2006. FILED 9-16-2005.
 3,176,515. **VITAL LADY (BLOCK FORM)**. MAHARISHI AYUR-VED PRODUCTS INTERNATIONAL, INC., (U.S. CLS. 6, 18, 44, 46, 51 AND 52). SN 78-714,942. PUB. 9-12-2006. FILED 9-16-2005.
 3,176,551. **TREKKIS (BLOCK FORM)**. NOVARTIS AG, (U.S. CLS. 6, 18, 44, 46, 51 AND 52). SN 78-725,138. PUB. 9-12-2006. FILED 10-3-2005.
 3,176,574. **C AND DESIGN**. KINETIC TECHNOLOGIES LLC, (U.S. CLS. 6, 18, 44, 46, 51 AND 52). SN 78-735,384. PUB. 9-12-2006. FILED 10-18-2005.
 3,176,583. **MAUI NONI INDIAN MULBERRY AND DESIGN**. HERB'S HERBS INC., (U.S. CLS. 6, 18, 44, 46, 51 AND 52). SN 78-739,526. PUB. 9-12-2006. FILED 10-24-2005.
 3,176,596. **VITAL MAN (BLOCK FORM)**. MAHARISHI AYUR-VED PRODUCTS INTERNATIONAL, INC., (U.S. CLS. 6, 18, 44, 46, 51 AND 52). SN 78-745,122. PUB. 9-12-2006. FILED 11-2-2005.
 3,176,601 (*See Class 3 for this trademark*).
 3,176,608. **DURAFLOW (BLOCK FORM)**. FRICKE, LAWRENCE R., JR., (U.S. CLS. 6, 18, 44, 46, 51 AND 52). SN 78-746,988. PUB. 9-12-2006. FILED 11-4-2005.
 3,176,711. **THERAPAUSE (BLOCK FORM)**. DEL PHARMACEUTICALS, INC., (U.S. CLS. 6, 18, 44, 46, 51 AND 52). SN 78-772,066. PUB. 9-12-2006. FILED 12-13-2005.
 3,176,722. **NUTRISOL (BLOCK FORM)**. MALEK, S. SHANE, (U.S. CLS. 6, 18, 44, 46, 51 AND 52). SN 78-773,556. PUB. 9-12-2006. FILED 12-14-2005.
 3,176,736. **VIRAWALL (BLOCK FORM)**. GREENE, STUART EVAN, (U.S. CLS. 6, 18, 44, 46, 51 AND 52). SN 78-774,721. PUB. 9-12-2006. FILED 12-16-2005.
 3,176,796. **EXTREME AMINO (BLOCK FORM)**. TSN LABS, INC., (U.S. CLS. 6, 18, 44, 46, 51 AND 52). SN 78-779,686. PUB. 9-12-2006. FILED 12-22-2005.
 3,176,838. **PRINCIPAL (BLOCK FORM)**. JB PRIMETTYME MEDICAL SUPPLY, INC., (U.S. CLS. 6, 18, 44, 46, 51 AND 52). SN 78-782,632. PUB. 9-12-2006. FILED 12-29-2005.
 3,176,887. **BASIC ESSENCE (BLOCK FORM)**. PESKIN, STEPHEN, (U.S. CLS. 6, 18, 44, 46, 51 AND 52). SN 78-785,841. PUB. 9-12-2006. FILED 1-5-2006.
 3,176,926. **RISHI AND DESIGN**. SHARMA, ADITYA, AND SHARMA, GEETA, (U.S. CLS. 6, 18, 44, 46, 51 AND 52). SN 78-787,901. PUB. 9-12-2006. FILED 1-9-2006.
 3,176,938. **OMEGALEAN (BLOCK FORM)**. OMEGALEAN, (U.S. CLS. 6, 18, 44, 46, 51 AND 52). SN 78-788,754. PUB. 9-12-2006. FILED 1-10-2006.
 3,176,950. **SLIM 4 LIFE (BLOCK FORM)**. SLIM FOR LIFE,

- INC., (U.S. CLS. 6, 18, 44, 46, 51 AND 52). SN 78-789,400. PUB. 9-12-2006. FILED 1-11-2006.
- 3,176,970. **MISCELLANEOUS DESIGN**. WALCO INTERNATIONAL, INC., (U.S. CLS. 6, 18, 44, 46, 51 AND 52). SN 78-791,114. PUB. 9-12-2006. FILED 1-13-2006.
- 3,176,976. **ONE & DONE (BLOCK FORM)**. BONIDE PRODUCTS, INC., (U.S. CLS. 6, 18, 44, 46, 51 AND 52). SN 78-791,510. PUB. 9-12-2006. FILED 1-13-2006.
- 3,176,990. **FREEGEN (BLOCK FORM)**. NUTREND HEALTH INSTITUTE, INC., (U.S. CLS. 6, 18, 44, 46, 51 AND 52). SN 78-792,292. PUB. 9-12-2006. FILED 1-16-2006.
- 3,176,991. **POWER OPC (BLOCK FORM)**. NUTREND HEALTH INSTITUTE, INC., (U.S. CLS. 6, 18, 44, 46, 51 AND 52). SN 78-792,299. PUB. 9-12-2006. FILED 1-16-2006.
- 3,177,125. **SILVAFRESH (BLOCK FORM)**. CHRISTY, JOSEPH, AND CHRISTY, MARTHA, (U.S. CLS. 6, 18, 44, 46, 51 AND 52). SN 78-798,132. PUB. 9-12-2006. FILED 1-24-2006.
- 3,177,154. **NO ESCAPE (BLOCK FORM)**. BONIDE PRODUCTS, INC., (U.S. CLS. 6, 18, 44, 46, 51 AND 52). SN 78-815,550. PUB. 9-12-2006. FILED 2-15-2006.
- 3,177,197. **WILATE (BLOCK FORM)**. OCTAPHARMA AG, (U.S. CLS. 6, 18, 44, 46, 51 AND 52). SN 79-007,182. PUB. 9-12-2006. FILED 12-1-2004.
- 3,177,214 (*See Class 1 for this trademark*).
- 3,177,229 (*See Class 3 for this trademark*).
- 3,177,240 (*See Class 3 for this trademark*).
- 3,177,280 (*See Class 1 for this trademark*).
- 3,177,287. **GESA (BLOCK FORM)**. GEMÜSESAFT GMBH, MULTIPLE CLASS, (INT. CLS. 5, 29, 30 AND 32), (U.S. CLS. 6, 18, 44, 45, 46, 48, 51 AND 52). SN 79-016,522. PUB. 9-12-2006. FILED 2-16-2005.
- 3,177,294. **PAILL (BLOCK FORM)**. AMT PTY LTD, MULTIPLE CLASS, (INT. CLS. 5 AND 44), (U.S. CLS. 6, 18, 44, 46, 51, 52, 100 AND 101). SN 79-017,193. PUB. 9-12-2006. FILED 10-20-2005.
- 3,177,295. **MEDESA (BLOCK FORM)**. WT ENERGIESYSTEME GMBH, MULTIPLE CLASS, (INT. CLS. 5, 7, 11, 32 AND 37), (U.S. CLS. 6, 13, 18, 19, 21, 23, 31, 34, 35, 44, 45, 46, 48, 51, 52, 100, 103 AND 106). SN 79-017,472. PUB. 9-12-2006. FILED 1-13-2005.
- 3,177,316. **JUNOVAN (BLOCK FORM)**. I.D.M. IMMUNO-DESIGNED MOLECULES, (U.S. CLS. 6, 18, 44, 46, 51 AND 52). SN 79-020,936. PUB. 9-12-2006. FILED 9-13-2005.
-
- CLASS 6—METAL GOODS**
- 3,175,792. **CB&I AND DESIGN**. CHICAGO BRIDGE & IRON COMPANY, MULTIPLE CLASS, (INT. CLS. 6, 37, 40 AND 42), (U.S. CLS. 2, 12, 13, 14, 23, 25, 50, 100, 101, 103 AND 106). SN 76-555,173. PUB. 9-12-2006. FILED 10-29-2003.
- 3,175,820. **WEARSERT (BLOCK FORM)**. NIRO AS, MULTIPLE CLASS, (INT. CLS. 6, 7 AND 11), (U.S. CLS. 2, 12, 13, 14, 19, 21, 23, 25, 31, 34, 35 AND 50). SN 76-614,467. PUB. 7-4-2006. FILED 10-1-2004.
- 3,175,834. **HUANG (BLOCK FORM)**. TEH YOR CO., LTD., MULTIPLE CLASS, (INT. CLS. 6, 7 AND 20), (U.S. CLS. 2, 12, 13, 14, 19, 21, 22, 23, 25, 31, 32, 34, 35 AND 50). SN 76-633,660. PUB. 9-12-2006. FILED 3-18-2005.
- 3,175,878. **PRIME-LINE (BLOCK FORM)**. PRIME-LINE PRODUCTS COMPANY, MULTIPLE CLASS, (INT. CLS. 6 AND 20), (U.S. CLS. 2, 12, 13, 14, 22, 23, 25, 32 AND 50). SN 76-647,282. PUB. 9-12-2006. FILED 9-22-2005.
- 3,175,923. **AM ACME MONACO (STYLIZED)**. ACME-MONACO CORPORATION, MULTIPLE CLASS, (INT. CLS. 6 AND 10), (U.S. CLS. 2, 12, 13, 14, 23, 25, 26, 39, 44 AND 50). SN 76-653,079. PUB. 9-12-2006. FILED 1-9-2006.
- 3,175,934. **ACME MONACO (BLOCK FORM)**. ACME-MONACO CORPORATION, MULTIPLE CLASS, (INT. CLS. 6 AND 10), (U.S. CLS. 2, 12, 13, 14, 23, 25, 26, 39, 44 AND 50). SN 76-655,175. PUB. 9-12-2006. FILED 2-15-2006.
- 3,175,958. **C/S GROUP (BLOCK FORM)**. EMEH, INC., MULTIPLE CLASS, (INT. CLS. 6, 11, 17, 19, 20, 22, 27 AND 35), (U.S. CLS. 1, 2, 5, 7, 12, 13, 14, 19, 20, 21, 22, 23, 25, 31, 32, 33, 34, 35, 37, 42, 50, 100, 101 AND 102). SN 78-299,768. PUB. 9-12-2006. FILED 9-12-2003.
- 3,175,964 (*See Class 3 for this trademark*).
- 3,175,966. **MESSER AND DESIGN**. MESSER GROUP GMBH, (U.S. CLS. 2, 12, 13, 14, 23, 25 AND 50). SN 78-332,939. PUB. 9-12-2006. FILED 11-25-2003.
- 3,175,989. **MULTIMOUNT (BLOCK FORM)**. ALLEN PRODUCTS COMPANY, INC., (U.S. CLS. 2, 12, 13, 14, 23, 25 AND 50). SN 78-400,461. PUB. 9-12-2006. FILED 4-12-2004.
- 3,176,035. **GREY BOND (BLOCK FORM)**. L&P PROPERTY MANAGEMENT COMPANY, MULTIPLE CLASS, (INT. CLS. 6 AND 20), (U.S. CLS. 2, 12, 13, 14, 22, 23, 25, 32 AND 50). SN 78-483,829. PUB. 9-12-2006. FILED 9-15-2004.
- 3,176,164. **SOUTHWESTERN WIRE CLOTH (BLOCK FORM)**. M-I L.L.C., (U.S. CLS. 2, 12, 13, 14, 23, 25 AND 50). SN 78-598,532. PUB. 9-12-2006. FILED 3-30-2005.
- 3,176,166. **AERODYNE ALLOYS YOUR SOURCE FOR SPECIALTY METALS AND DESIGN**. AERODYNE ALLOYS, LLC, (U.S. CLS. 2, 12, 13, 14, 23, 25 AND 50). SN 78-598,952. PUB. 9-12-2006. FILED 3-31-2005.
- 3,176,189. **TREE NEEDLES AND DESIGN**. D.L.I., INC., MULTIPLE CLASS, (INT. CLS. 6 AND 37), (U.S. CLS. 2, 12, 13, 14, 23, 25, 50, 100, 103 AND 106). SN 78-607,345. PUB. 9-12-2006. FILED 4-12-2005.
- 3,176,210. **NORWESCO (BLOCK FORM)**. NOLL MANUFACTURING COMPANY, MULTIPLE CLASS, (INT. CLS. 6, 12, 19 AND 21), (U.S. CLS. 1, 2, 12, 13, 14, 19, 21, 23, 25, 29, 30, 31, 33, 35, 40, 44 AND 50). SN 78-616,966. PUB. 9-12-2006. FILED 4-26-2005.
- 3,176,255. **BUY ME-RENT ME (BLOCK FORM)**. DIRECT SURPLUS SALES, INC., MULTIPLE CLASS, (INT. CLS. 6 AND 39), (U.S. CLS. 2, 12, 13, 14, 23, 25, 50, 100 AND 105). SN 78-628,900. PUB. 9-12-2006. FILED 5-12-2005.
- 3,176,418. **THE AMERICAN STANDARD FOR STRENGTH AND SECURITY (BLOCK FORM)**. SONNY SCAFFOLDS, INC., MULTIPLE CLASS, (INT. CLS. 6 AND 12), (U.S. CLS. 2, 12, 13, 14, 19, 21, 23, 25, 31, 35, 44 AND 50). SN 78-667,824. PUB. 4-25-2006. FILED 7-11-2005.
- 3,176,445. **IDEAL DOOR AND DESIGN**. CLOPAY BUILDING PRODUCTS R&D COMPANY, INC., DBA CLOPAY BUILDING PRODUCTS COMPANY, INC., (U.S. CLS. 2, 12, 13, 14, 23, 25 AND 50). SN 78-688,528. PUB. 9-12-2006. FILED 8-9-2005.
- 3,176,487. **HODGEPODGE HARDWARE (BLOCK FORM)**. STAMPIN' UP! INC., (U.S. CLS. 2, 12, 13, 14, 23, 25 AND 50). SN 78-705,484. PUB. 9-12-2006. FILED 9-1-2005.
- 3,176,488. **PANDA AND DESIGN**. SHOSHAN, EYAL AVI, (U.S. CLS. 2, 12, 13, 14, 23, 25 AND 50). SN 78-705,948. PUB. 9-12-2006. FILED 9-2-2005.
- 3,176,532. **OMAHA AK-SAR-BEN KNIGHTS AK AND DESIGN**. AK-SAR-BEN/CALGARY HOCKEY, INC., (U.S. CLS. 2, 12, 13, 14, 23, 25 AND 50). SN 78-721,173. PUB. 9-12-2006. FILED 9-27-2005.
- 3,176,560. **PENSEAL PLUS (BLOCK FORM)**. EXPANSION JOINT SYSTEMS, INC., (U.S. CLS. 2, 12, 13, 14, 23, 25 AND 50). SN 78-728,348. PUB. 9-12-2006. FILED 10-6-2005.
- 3,176,563. **DIMENSION DIMENSION FABRICATORS, INC. AND DESIGN**. DIMENSION FABRICATORS, INC., (U.S. CLS. 2, 12, 13, 14, 23, 25 AND 50). SN 78-729,527. PUB. 9-12-2006. FILED 10-9-2005.
- 3,177,096. **BASIX (BLOCK FORM)**. PEACHTREE DOORS AND WINDOWS, INC., (U.S. CLS. 2, 12, 13, 14, 23, 25 AND 50). SN 78-796,141. PUB. 9-12-2006. FILED 1-20-2006.
- 3,177,203. **ROBOJIG (BLOCK FORM)**. KUKA SCHWEISSANLAGEN GMBH, MULTIPLE CLASS, (INT. CLS. 6, 7 AND 9), (U.S. CLS. 2, 12, 13, 14, 19, 21, 23, 25, 26, 31, 34, 35, 36, 38 AND 50). SN 79-008,776. PUB. 9-12-2006. FILED 3-3-2004.
- 3,177,234. **MICRO STIX AND DESIGN**. OSG CORPORATION, MULTIPLE CLASS, (INT. CLS. 6 AND 20), (U.S. CLS. 2, 12, 13, 14, 22, 23, 25, 32 AND 50). SN 79-012,983. PUB. 9-12-2006. FILED 7-2-2004.
- 3,177,242. **CONERGY (STYLIZED)**. CONERGY AG, MULTIPLE CLASS, (INT. CLS. 6, 9, 11, 37, 38, 40 AND 42), (U.S. CLS. 2, 12, 13, 14, 21, 23, 25, 26, 31, 34, 36, 38, 50, 100, 101, 103, 104 AND 106). SN 79-013,300. PUB. 9-12-2006. FILED 12-15-2004.
- 3,177,264. **RODINOX PLUS (STYLIZED)**. RODACCIAI S.P.A., (U.S. CLS. 2, 12, 13, 14, 23, 25 AND 50). SN 79-014,533. PUB. 9-12-2006. FILED 6-10-2005.
- 3,177,280 (*See Class 1 for this trademark*).
- 3,177,290. **DVD-GARAGE (BLOCK FORM)**. MICHAEL DEAN,

- MULTIPLE CLASS, (INT. CLS. 6, 9 AND 20), (U.S. CLS. 2, 12, 13, 14, 21, 22, 23, 25, 26, 32, 36, 38 AND 50). SN 79-016,562. PUB. 9-12-2006. FILED 8-15-2005.
- 3,177,308. **CAPAMOLD (STYLIZED)**. SIDEL, MULTIPLE CLASS, (INT. CLS. 6, 7, 9 AND 42), (U.S. CLS. 2, 12, 13, 14, 19, 21, 23, 25, 26, 31, 34, 35, 36, 38, 50, 100 AND 101). SN 79-019,077. PUB. 9-12-2006. FILED 9-20-2005.
-
- CLASS 7—MACHINERY**
- 3,175,794. **ECO-ACTIVITIES AND DESIGN**. BRIDGESTONE CORPORATION, MULTIPLE CLASS, (INT. CLS. 7, 9, 11, 12, 17, 18, 19, 20, 24, 25, 27, 28 AND 37), (U.S. CLS. 1, 2, 3, 5, 12, 13, 19, 20, 21, 22, 23, 25, 26, 31, 32, 33, 34, 35, 36, 37, 38, 39, 41, 42, 44, 50, 100, 103 AND 106). SN 76-560,650. PUB. 5-30-2006. FILED 11-18-2003.
- 3,175,816. **LIBURDI (BLOCK FORM)**. LIBURDI ENGINEERING LIMITED, MULTIPLE CLASS, (INT. CLS. 7, 9 AND 37), (U.S. CLS. 13, 19, 21, 23, 26, 31, 34, 35, 36, 38, 100, 103 AND 106). SN 76-609,498. PUB. 9-12-2006. FILED 8-31-2004. 3,175,820 (*See Class 6 for this trademark*).
- 3,175,823. **HP RACING (STYLIZED)**. HURRICANE POWER, INC., MULTIPLE CLASS, (INT. CLS. 7 AND 12), (U.S. CLS. 13, 19, 21, 23, 31, 34, 35 AND 44). SN 76-615,822. PUB. 9-12-2006. FILED 10-12-2004.
- 3,175,828. **MR. TUFF SCREEN AND DESIGN**. CONN-WELD INDUSTRIES, INC., (U.S. CLS. 13, 19, 21, 23, 31, 34 AND 35). SN 76-618,521. PUB. 9-12-2006. FILED 10-29-2004.
- 3,175,831. **MOORMASTER (STYLIZED)**. MOORING SYSTEMS LIMITED, MULTIPLE CLASS, (INT. CLS. 7, 9 AND 37), (U.S. CLS. 13, 19, 21, 23, 26, 31, 34, 35, 36, 38, 100, 103 AND 106). SN 76-621,300. PUB. 7-4-2006. FILED 11-18-2004.
- 3,175,834 (*See Class 6 for this trademark*).
- 3,175,853. **ALLION (BLOCK FORM)**. MORI SEIKI CO., LTD., (U.S. CLS. 13, 19, 21, 23, 31, 34 AND 35). SN 76-640,974. PUB. 9-12-2006. FILED 6-15-2005.
- 3,175,897. **ORR (BLOCK FORM)**. THE ORR FELT COMPANY, (U.S. CLS. 13, 19, 21, 23, 31, 34 AND 35). SN 76-652,026. PUB. 9-12-2006. FILED 12-19-2005.
- 3,175,898. **AP (STYLIZED)**. GOERLICH'S, INC., (U.S. CLS. 13, 19, 21, 23, 31, 34 AND 35). SN 76-652,144. PUB. 9-12-2006. FILED 12-12-2005.
- 3,175,940. **SACHS AND DESIGN**. ZF SACHS AG, MULTIPLE CLASS, (INT. CLS. 7, 12 AND 17), (U.S. CLS. 1, 5, 12, 13, 19, 21, 23, 31, 34, 35, 44 AND 50). SN 78-158,075. PUB. 9-12-2006. FILED 8-27-2002.
- 3,176,137. **X-RING (BLOCK FORM)**. DAIDO KOGYO CO., LTD., (U.S. CLS. 13, 19, 21, 23, 31, 34 AND 35). SN 78-579,096. PUB. 9-12-2006. FILED 3-3-2005.
- 3,176,138. **KOENIG CRANES NORTH AMERICA (BLOCK FORM)**. EAGLE WEST TOWER CRANE INC., (U.S. CLS. 13, 19, 21, 23, 31, 34 AND 35). SN 78-580,232. PUB. 9-12-2006. FILED 3-4-2005.
- 3,176,180. **SILVER GHOST (BLOCK FORM)**. BSH BOSCH UND SIEMENS HAUSGERATE GMBH, (U.S. CLS. 13, 19, 21, 23, 31, 34 AND 35). SN 78-603,590. PUB. 7-11-2006. FILED 4-7-2005.
- 3,176,218. **A & S FERSA (BLOCK FORM)**. FABRICAS EUROPEAS DE RODAMIENTOS S.A., (U.S. CLS. 13, 19, 21, 23, 31, 34 AND 35). SN 78-620,712. PUB. 9-12-2006. FILED 5-2-2005.
- 3,176,247. **TRACE ANALYTICAL (BLOCK FORM)**. AMETEK, INC., MULTIPLE CLASS, (INT. CLS. 7 AND 9), (U.S. CLS. 13, 19, 21, 23, 26, 31, 34, 35, 36 AND 38). SN 78-627,974. PUB. 9-12-2006. FILED 5-11-2005.
- 3,176,263. **FERRATOR (BLOCK FORM)**. FERRATE TREATMENT TECHNOLOGIES, LLC, MULTIPLE CLASS, (INT. CLS. 7, 11 AND 37), (U.S. CLS. 13, 19, 21, 23, 31, 34, 35, 100, 103 AND 106). SN 78-630,001. PUB. 9-12-2006. FILED 5-13-2005.
- 3,176,308. **NIJAL (BLOCK FORM)**. NIJAL, (U.S. CLS. 13, 19, 21, 23, 31, 34 AND 35). SN 78-638,927. PUB. 9-12-2006. FILED 5-27-2005.
- 3,176,314. **XACT (BLOCK FORM)**. ADVANCE MERCHANDISING COMPANY, INC., (U.S. CLS. 13, 19, 21, 23, 31, 34 AND 35). SN 78-640,089. PUB. 9-12-2006. FILED 5-31-2005.
- 3,176,385. **OPTIMA AND DESIGN**. SPECIALTY BLADES, INC., MULTIPLE CLASS, (INT. CLS. 7 AND 8), (U.S. CLS. 13, 19, 21, 23, 28, 31, 34, 35 AND 44). SN 78-659,061. PUB. 9-12-2006. FILED 6-27-2005.
- 3,176,387. **RESUN AND DESIGN**. SHENZHEN XINGRISHENG INDUSTRIAL CO., LTD, MULTIPLE CLASS, (INT. CLS. 7, 11 AND 16), (U.S. CLS. 2, 5, 13, 19, 21, 22, 23, 29, 31, 34, 35, 37, 38 AND 50). SN 78-659,420. PUB. 9-12-2006. FILED 6-28-2005.
- 3,176,607. **APPRENTICE (BLOCK FORM)**. RICHPOWER INDUSTRIES INC., (U.S. CLS. 13, 19, 21, 23, 31, 34 AND 35). SN 78-746,880. PUB. 9-12-2006. FILED 11-3-2005.
- 3,176,698. **ORTMAN CYLINDERS (BLOCK FORM)**. COLTEC INDUSTRIES INC., (U.S. CLS. 13, 19, 21, 23, 31, 34 AND 35). SN 78-767,439. PUB. 9-12-2006. FILED 12-6-2005.
- 3,176,940. **SCREWVEYOR (BLOCK FORM)**. WILLIAM W. MEYER & SONS, INC., (U.S. CLS. 13, 19, 21, 23, 31, 34 AND 35). SN 78-788,828. PUB. 9-12-2006. FILED 1-10-2006.
- 3,177,028. **INK-O-DEM (BLOCK FORM)**. TONERHEAD, INC., (U.S. CLS. 13, 19, 21, 23, 31, 34 AND 35). SN 78-793,619. PUB. 9-12-2006. FILED 1-18-2006.
- 3,177,033. **SPECIAL OPS (BLOCK FORM)**. Q INDUSTRIES, INC., DBA DV INNOVATIONS, (U.S. CLS. 13, 19, 21, 23, 31, 34 AND 35). SN 78-793,762. PUB. 9-12-2006. FILED 1-18-2006.
- 3,177,035. **DUALIE (BLOCK FORM)**. Q INDUSTRIES, INC., DBA DV INNOVATIONS, (U.S. CLS. 13, 19, 21, 23, 31, 34 AND 35). SN 78-793,789. PUB. 9-12-2006. FILED 1-18-2006.
- 3,177,192. **GULPER (BLOCK FORM)**. MUNSTER SIMMS ENGINEERING LIMITED, (U.S. CLS. 13, 19, 21, 23, 31, 34 AND 35). SN 79-003,870. PUB. 9-12-2006. FILED 3-29-2004.
- 3,177,200. **THE ART OF GRINDING**. STUDER AND DESIGN. FRITZ STUDER AG, MULTIPLE CLASS, (INT. CLS. 7, 8, 37 AND 42), (U.S. CLS. 13, 19, 21, 23, 28, 31, 34, 35, 44, 100, 101, 103 AND 106). SN 79-008,447. PUB. 9-12-2006. FILED 9-16-2004.
- 3,177,203 (*See Class 6 for this trademark*).
- 3,177,209. **SAUERMANN AND DESIGN**. SAUERMANN INDUSTRIE, MULTIPLE CLASS, (INT. CLS. 7, 11 AND 37), (U.S. CLS. 13, 19, 21, 23, 31, 34, 35, 100, 103 AND 106). SN 79-010,589. PUB. 9-12-2006. FILED 4-14-2005.
- 3,177,213. **ADDMAT (BLOCK FORM)**. LEMO MASCHINENBAU GMBH, (U.S. CLS. 13, 19, 21, 23, 31, 34 AND 35). SN 79-010,857. PUB. 9-12-2006. FILED 3-23-2005.
- 3,177,230. **MISCELLANEOUS DESIGN**. TOX PRESSOTECHNIK GMBH & CO. KG, MULTIPLE CLASS, (INT. CLS. 7 AND 8), (U.S. CLS. 13, 19, 21, 23, 28, 31, 34, 35 AND 44). SN 79-012,475. PUB. 9-12-2006. FILED 1-26-2005.
- 3,177,245. **FRESHLINE DIRECT STREAM AND DESIGN**. FRESHLINE MACHINES PTY LTD, (U.S. CLS. 13, 19, 21, 23, 31, 34 AND 35). SN 79-013,520. PUB. 9-12-2006. FILED 11-25-2004.
- 3,177,255. **TITANIUM POWER (STYLIZED)**. SPEED FRANCE (SOCIÉTÉ ANONYME), MULTIPLE CLASS, (INT. CLS. 7, 17 AND 28), (U.S. CLS. 1, 5, 12, 13, 19, 21, 22, 23, 31, 34, 35, 38 AND 50). SN 79-013,909. PUB. 9-12-2006. FILED 5-27-2005.
- 3,177,273. **ORATO (BLOCK FORM)**. SOMFY SAS, MULTIPLE CLASS, (INT. CLS. 7 AND 9), (U.S. CLS. 13, 19, 21, 23, 26, 31, 34, 35, 36 AND 38). SN 79-015,243. PUB. 9-12-2006. FILED 7-29-2005.
- 3,177,279. **HIGHFIL (STYLIZED)**. ZHEJIANG DONGYUAN JICHE BUJIAN CO., LTD., (U.S. CLS. 13, 19, 21, 23, 31, 34 AND 35). SN 79-015,976. PUB. 9-12-2006. FILED 4-7-2005.
- 3,177,280 (*See Class 1 for this trademark*).
- 3,177,295 (*See Class 5 for this trademark*).
- 3,177,308 (*See Class 6 for this trademark*).
-
- CLASS 8—HAND TOOLS**
- 3,175,869. **NATIONAL PARK SERVICE AND DESIGN**. DEPARTMENT OF THE INTERIOR, MULTIPLE CLASS, (INT. CLS. 8, 14, 16, 18, 25 AND 41), (U.S. CLS. 1, 2, 3, 5, 22, 23, 27, 28, 29, 37, 38, 39, 41, 44, 50, 100, 101 AND 107). SN 76-646,136. PUB. 9-12-2006. FILED 9-2-2005.
- 3,175,962. **M AND DESIGN**. MAKING MEMORIES WHOLESALE, INC., MULTIPLE CLASS, (INT. CLS. 8 AND 16),

- (U.S. CLS. 2, 5, 22, 23, 28, 29, 37, 38, 44 AND 50). SN 78-310,527. PUB. 9-12-2006. FILED 10-7-2003.
- 3,176,115. **ILKO 3D-SAFE (BLOCK FORM)**. VIRUTEX ILKO S.A., MULTIPLE CLASS, (INT. CLS. 8 AND 21), (U.S. CLS. 2, 13, 23, 28, 29, 30, 33, 40, 44 AND 50). SN 78-560,640. PUB. 7-4-2006. FILED 2-4-2005.
- 3,176,385 (*See Class 7 for this trademark*).
- 3,176,426. **BIRD LAND (BLOCK FORM)**. CARL JIMUKI KABUSHIKI KAISHA, TA CARL MANUFACTURING CO., LTD., (U.S. CLS. 23, 28 AND 44). SN 78-673,089. PUB. 6-6-2006. FILED 7-19-2005.
- 3,176,506. **LEGENDS OF THE WEST (BLOCK FORM)**. GERONIMO PRODUCTIONS, INC., (U.S. CLS. 23, 28 AND 44). SN 78-712,462. PUB. 9-12-2006. FILED 9-14-2005.
- 3,176,599. **TOUGHSKIN (BLOCK FORM)**. ROOSTER PRODUCTS INTERNATIONAL, INC., MULTIPLE CLASS, (INT. CLS. 8 AND 18), (U.S. CLS. 1, 2, 3, 22, 23, 28, 41 AND 44). SN 78-745,603. PUB. 9-12-2006. FILED 11-2-2005.
- 3,176,606. **RYUMON AND DESIGN**. MASTER CUTLERY, INC. (U.S. CLS. 23, 28 AND 44). SN 78-746,817. PUB. 9-12-2006. FILED 11-3-2005.
- 3,176,964. **WOODPECKERS (BLOCK FORM)**. WOODPECKERS, INC., MULTIPLE CLASS, (INT. CLS. 8 AND 35), (U.S. CLS. 23, 28, 44, 100, 101 AND 102). SN 78-791,009. PUB. 9-12-2006. FILED 1-13-2006.
- 3,177,016. **EZE EVOLUTIONARY (BLOCK FORM)**. MERRY CHANCE INDUSTRIES LTD., MULTIPLE CLASS, (INT. CLS. 8 AND 21), (U.S. CLS. 2, 13, 23, 28, 29, 30, 33, 40, 44 AND 50). SN 78-793,299. PUB. 9-12-2006. FILED 1-17-2006.
- 3,177,200 (*See Class 7 for this trademark*).
- 3,177,222 (*See Class 3 for this trademark*).
- 3,177,227. **FLUFFY DUCK BUFFER (BLOCK FORM)**. AUSTRALIAN BEAUTY SOLUTIONS PTY LTD, (U.S. CLS. 23, 28 AND 44). SN 79-012,277. PUB. 9-12-2006. FILED 5-30-2005.
- 3,177,230 (*See Class 7 for this trademark*).
- 3,177,251 (*See Class 3 for this trademark*).
- 3,177,252 (*See Class 3 for this trademark*).
- 3,177,254. **CERION (BLOCK FORM)**. TONDEO-WERK GMBH, MULTIPLE CLASS, (INT. CLS. 8, 9 AND 11), (U.S. CLS. 13, 21, 23, 26, 28, 31, 34, 36, 38 AND 44). SN 79-013,883. PUB. 9-12-2006. FILED 6-22-2005.
- 3,177,268. **AA ASHANTI (STYLIZED)**. ASHANTI S.R.L., MULTIPLE CLASS, (INT. CLS. 8 AND 21), (U.S. CLS. 2, 13, 23, 28, 29, 30, 33, 40, 44 AND 50). SN 79-014,760. PUB. 9-12-2006. FILED 6-10-2005.
-
- CLASS 9—ELECTRICAL AND SCIENTIFIC APPARATUS**
- 3,175,759. **FRAMUS**. WILFER, HANS-PETER, MULTIPLE CLASS, (INT. CLS. 9 AND 15), (U.S. CLS. 2, 21, 23, 26, 36 AND 38). SN 76-076,857. PUB. 9-12-2006. FILED 6-26-2000.
- 3,175,760. **REALFLAT**. REALSYNC U.S.A., (U.S. CLS. 21, 23, 26, 36 AND 38). SN 76-089,241. PUB. 11-11-2003. FILED 7-14-2000.
- 3,175,762 (*See Class 3 for this trademark*).
- 3,175,771. **GN**. GN STORE NORD A/S, MULTIPLE CLASS, (INT. CLS. 9, 10 AND 38), (U.S. CLS. 21, 23, 26, 36, 38, 39, 44, 100, 101 AND 104). SN 76-418,571. PUB. 5-30-2006. FILED 6-7-2002.
- 3,175,794 (*See Class 7 for this trademark*).
- 3,175,795. **SEE FUNCTIONAL (STYLIZED)**. INFORMATIQUE GRAPHISME ENERGETIQUE - I.G.E., MULTIPLE CLASS, (INT. CLS. 9 AND 42), (U.S. CLS. 21, 23, 26, 36, 38, 100 AND 101). SN 76-561,173. PUB. 9-12-2006. FILED 11-20-2003.
- 3,175,797. **DOCTAN (BLOCK FORM)**. DOCTER OPTICS GMBH, MULTIPLE CLASS, (INT. CLS. 9, 21, 40 AND 42), (U.S. CLS. 2, 13, 21, 23, 26, 29, 30, 33, 36, 38, 40, 50, 100, 101, 103 AND 106). SN 76-565,799. PUB. 9-12-2006. FILED 12-4-2003.
- 3,175,805. **FAR-PRO FAR COMPLIANT PROCUREMENT AND DESIGN**. PALOMA SYSTEMS, INC., (U.S. CLS. 21, 23, 26, 36 AND 38). SN 76-586,939. PUB. 9-12-2006. FILED 4-13-2004.
- 3,175,811. **MICROSCOUT (BLOCK FORM)**. BRUKER DALTONIK GMBH, (U.S. CLS. 21, 23, 26, 36 AND 38). SN 76-602,280. PUB. 9-12-2006. FILED 7-14-2004.
- 3,175,815. **FX FILTER (BLOCK FORM)**. PLANET GROUP, INC., MULTIPLE CLASS, (INT. CLS. 9 AND 36), (U.S. CLS. 21, 23, 26, 36, 38, 100, 101 AND 102). SN 76-606,863. PUB. 9-12-2006. FILED 8-11-2004.
- 3,175,816 (*See Class 7 for this trademark*).
- 3,175,819. **MEGACAP TYPE (BLOCK FORM)**. TDK CORPORATION, (U.S. CLS. 21, 23, 26, 36 AND 38). SN 76-613,990. PUB. 5-9-2006. FILED 9-30-2004.
- 3,175,824. **VINKO THE DANCING BEAR (BLOCK FORM)**. GENIUS PRODUCTS, INC., MULTIPLE CLASS, (INT. CLS. 9, 16, 25 AND 28), (U.S. CLS. 2, 5, 21, 22, 23, 26, 29, 36, 37, 38, 39 AND 50). SN 76-616,626. PUB. 9-12-2006. FILED 10-18-2004.
- 3,175,825. **OBOE THE MONKEY (BLOCK FORM)**. GENIUS PRODUCTS, INC., MULTIPLE CLASS, (INT. CLS. 9, 16, 25 AND 28), (U.S. CLS. 2, 5, 21, 22, 23, 26, 29, 36, 37, 38, 39 AND 50). SN 76-616,627. PUB. 9-12-2006. FILED 10-18-2004.
- 3,175,826. **IDATA (BLOCK FORM)**. QUANTUM3D, INC., (U.S. CLS. 21, 23, 26, 36 AND 38). SN 76-616,644. PUB. 9-12-2006. FILED 10-18-2004.
- 3,175,829. **BORRAN CONNECT! (BLOCK FORM)**. KENECK VENTURES INC., MULTIPLE CLASS, (INT. CLS. 9 AND 36), (U.S. CLS. 21, 23, 26, 36, 38, 100, 101 AND 102). SN 76-618,586. PUB. 9-12-2006. FILED 10-29-2004.
- 3,175,831 (*See Class 7 for this trademark*).
- 3,175,842. **PDSTORE (BLOCK FORM)**. OLSEN MANUFACTURING CO., INC., (U.S. CLS. 21, 23, 26, 36 AND 38). SN 76-638,384. PUB. 9-12-2006. FILED 5-11-2005.
- 3,175,846. **DIGIRAY (STYLIZED)**. DIGIRAY CORPORATION, MULTIPLE CLASS, (INT. CLS. 9 AND 10), (U.S. CLS. 21, 23, 26, 36, 38, 39 AND 44). SN 76-638,939. PUB. 9-12-2006. FILED 5-19-2005.
- 3,175,847. **COPIA (BLOCK FORM)**. ORCHARD SOFTWARE CORPORATION, MULTIPLE CLASS, (INT. CLS. 9 AND 42), (U.S. CLS. 21, 23, 26, 36, 38, 100 AND 101). SN 76-638,950. PUB. 9-12-2006. FILED 5-19-2005.
- 3,175,850. **VISIONXTEND (BLOCK FORM)**. DELTEK SYSTEMS, INC., (U.S. CLS. 21, 23, 26, 36 AND 38). SN 76-640,301. PUB. 9-12-2006. FILED 6-7-2005.
- 3,175,856. **THE BLESSED LIFE (BLOCK FORM)**. GATEWAY CHURCH., MULTIPLE CLASS, (INT. CLS. 9 AND 16), (U.S. CLS. 2, 5, 21, 22, 23, 26, 29, 36, 37, 38 AND 50). SN 76-641,610. PUB. 9-12-2006. FILED 6-24-2005.
- 3,175,858. **FULLCASE (BLOCK FORM)**. JUSTICE SYSTEMS, INC., MULTIPLE CLASS, (INT. CLS. 9 AND 35), (U.S. CLS. 21, 23, 26, 36, 38, 100, 101 AND 102). SN 76-641,880. PUB. 9-12-2006. FILED 6-29-2005.
- 3,175,894. **TECNEC (BLOCK FORM)**. TOWER PRODUCTS INCORPORATED, (U.S. CLS. 21, 23, 26, 36 AND 38). SN 76-650,087. PUB. 9-12-2006. FILED 11-9-2005.
- 3,175,916. **FIRST WATT (BLOCK FORM)**. GENERAL AMPLIFIER, INC., (U.S. CLS. 21, 23, 26, 36 AND 38). SN 76-652,843. PUB. 9-12-2006. FILED 1-4-2006.
- 3,175,943. **METHODA**. METHODA COMPUTERS LTD., (U.S. CLS. 21, 23, 26, 36 AND 38). SN 78-196,542. PUB. 9-12-2006. FILED 12-20-2002.
- 3,175,944. **OLISA**. APIBIO, (U.S. CLS. 21, 23, 26, 36 AND 38). SN 78-201,531. PUB. 9-13-2005. FILED 1-9-2003.
- 3,175,945. **DIGITALLFREEDOM**. SAMSUNG ELECTRONICS CO., LTD., (U.S. CLS. 21, 23, 26, 36 AND 38). SN 78-206,569. PUB. 9-12-2006. FILED 1-23-2003.
- 3,175,950. **VENDA**. VENDA LIMITED, MULTIPLE CLASS, (INT. CLS. 9, 35, 36, 38 AND 42), (U.S. CLS. 21, 23, 26, 36, 38, 100, 101, 102 AND 104). SN 78-251,396. PUB. 9-12-2006. FILED 5-19-2003.
- 3,175,951. **LTSP**. DISKLESSWORKSTATIONS.COM, LLC, (U.S. CLS. 21, 23, 26, 36 AND 38). SN 78-251,905. PUB. 9-12-2006. FILED 5-20-2003.
- 3,175,959. **AGILIS 91X**. DIEBOLD, INCORPORATED, (U.S. CLS. 21, 23, 26, 36 AND 38). SN 78-303,308. PUB. 9-12-2006. FILED 9-22-2003.
- 3,175,960. **AGILIS NDX**. DIEBOLD, INCORPORATED, (U.S. CLS. 21, 23, 26, 36 AND 38). SN 78-303,321. PUB. 9-12-2006. FILED 9-22-2003.
- 3,175,961. **AGILIS 3X**. DIEBOLD, INCORPORATED, (U.S. CLS. 21, 23, 26, 36 AND 38). SN 78-303,329. PUB. 9-12-2006. FILED 9-22-2003.

- 3,175,964 (*See Class 3 for this trademark*).
- 3,175,975. **BOARDBUG (BLOCK FORM)**. BOARDBUG LIMITED, MULTIPLE CLASS, (INT. CLS. 9, 38 AND 42), (U.S. CLS. 21, 23, 26, 36, 38, 100, 101 AND 104). SN 78-374,588. PUB. 1-24-2006. FILED 2-26-2004.
- 3,175,983. **MISCELLANEOUS DESIGN**. CLS UK INTERMEDIATE HOLDINGS LTD, MULTIPLE CLASS, (INT. CLS. 9, 36, 38 AND 42), (U.S. CLS. 21, 23, 26, 36, 38, 100, 101, 102 AND 104). SN 78-387,514. PUB. 1-10-2006. FILED 3-19-2004.
- 3,175,986. **PRIVASAFE (BLOCK FORM)**. AFFINITY MARKETING PARTNERS, LLC, MULTIPLE CLASS, (INT. CLS. 9 AND 38), (U.S. CLS. 21, 23, 26, 36, 38, 100, 101 AND 104). SN 78-393,761. PUB. 9-12-2006. FILED 3-31-2004.
- 3,175,995. **MEDREEL AND DESIGN**. APC GROUP, INCORPORATED, (U.S. CLS. 21, 23, 26, 36 AND 38). SN 78-423,138. PUB. 9-12-2006. FILED 5-21-2004.
- 3,176,029. **MINIKET (BLOCK FORM)**. SAMSUNG ELECTRONICS CO., LTD., (U.S. CLS. 21, 23, 26, 36 AND 38). SN 78-478,675. PUB. 9-12-2006. FILED 9-3-2004.
- 3,176,045. **ENIGMATEC (BLOCK FORM)**. ENIGMATEC CORPORATION LIMITED, MULTIPLE CLASS, (INT. CLS. 9, 38 AND 42), (U.S. CLS. 21, 23, 26, 36, 38, 100, 101 AND 104). SN 78-495,417. PUB. 5-30-2006. FILED 10-6-2004.
- 3,176,054. **ODYSSEY AND DESIGN**. PANTHEON INC., (U.S. CLS. 21, 23, 26, 36 AND 38). SN 78-502,487. PUB. 9-12-2006. FILED 10-19-2004.
- 3,176,056. **VIDEO GAMING TECHNOLOGIES (BLOCK FORM)**. VIDEO GAMING TECHNOLOGIES, INC., (U.S. CLS. 21, 23, 26, 36 AND 38). SN 78-504,390. PUB. 9-12-2006. FILED 10-22-2004.
- 3,176,061. **AFINETY SYSTEM (BLOCK FORM)**. AMERICAN FIBERTEK, INC., (U.S. CLS. 21, 23, 26, 36 AND 38). SN 78-511,069. PUB. 9-12-2006. FILED 11-4-2004.
- 3,176,062. **RAPID FIRE (BLOCK FORM)**. WASEL, JOEL, AND FONTAINE, BRUCE, MULTIPLE CLASS, (INT. CLS. 9, 25 AND 41), (U.S. CLS. 21, 22, 23, 26, 36, 38, 39, 100, 101 AND 107). SN 78-511,496. PUB. 1-31-2006. FILED 11-4-2004.
- 3,176,063. **THE ORIGINAL RESUME (BLOCK FORM)**. GOVE, THOMAS P., JR., MULTIPLE CLASS, (INT. CLS. 9 AND 35), (U.S. CLS. 21, 23, 26, 36, 38, 100, 101 AND 102). SN 78-514,125. PUB. 9-12-2006. FILED 11-9-2004.
- 3,176,067. **CREATE THE PROFESSIONAL CHOICE (STYLIZED)**. CREATE MAGIC, INC., MULTIPLE CLASS, (INT. CLS. 9 AND 11), (U.S. CLS. 13, 21, 23, 26, 31, 34, 36 AND 38). SN 78-517,904. PUB. 9-12-2006. FILED 11-16-2004.
- 3,176,068. **MULTIDISC (BLOCK FORM)**. PHOTOFLEX, INC., (U.S. CLS. 21, 23, 26, 36 AND 38). SN 78-520,414. PUB. 9-12-2006. FILED 11-19-2004.
- 3,176,071. **TORAH 201 (BLOCK FORM)**. SIMCHAT TORAH BEIT MIDRASH, INC., MULTIPLE CLASS, (INT. CLS. 9, 16 AND 41), (U.S. CLS. 2, 5, 21, 22, 23, 26, 29, 36, 37, 38, 50, 100, 101 AND 107). SN 78-523,525. PUB. 9-12-2006. FILED 11-29-2004.
- 3,176,079. **MYSTERIES OF INDIA (BLOCK FORM)**. ATRONIC INTERNATIONAL GMBH, MULTIPLE CLASS, (INT. CLS. 9 AND 28), (U.S. CLS. 21, 22, 23, 26, 36, 38 AND 50). SN 78-527,128. PUB. 9-12-2006. FILED 12-4-2004.
- 3,176,081. **ROAD RAGE MOTORCYCLES AND DESIGN**. SAL R. GRASSADONIA AND LISA M. LOHREY PARTNERSHIP, THE, MULTIPLE CLASS, (INT. CLS. 9 AND 25), (U.S. CLS. 21, 22, 23, 26, 36, 38 AND 39). SN 78-528,045. PUB. 9-12-2006. FILED 12-7-2004.
- 3,176,116. **CREATE DEPLOY CONVERGE AND DESIGN**. CONTINUOUS COMPUTING CORPORATION, (U.S. CLS. 21, 23, 26, 36 AND 38). SN 78-560,716. PUB. 9-12-2006. FILED 2-4-2005.
- 3,176,123. **ON THE MAT (BLOCK FORM)**. NELSON, SCOTT, MULTIPLE CLASS, (INT. CLS. 9 AND 25), (U.S. CLS. 21, 22, 23, 26, 36, 38 AND 39). SN 78-565,731. PUB. 9-12-2006. FILED 2-11-2005.
- 3,176,125. **GOTSMILEY (BLOCK FORM)**. CLARIA CORPORATION, (U.S. CLS. 21, 23, 26, 36 AND 38). SN 78-568,135. PUB. 9-12-2006. FILED 2-15-2005.
- 3,176,129. **I.C. TREASURES (BLOCK FORM)**. ATRONIC INTERNATIONAL GMBH, MULTIPLE CLASS, (INT. CLS. 9 AND 28), (U.S. CLS. 21, 22, 23, 26, 36, 38 AND 50). SN 78-573,026. PUB. 9-12-2006. FILED 2-23-2005.
- 3,176,143. **THE EZRA PROJECT CONNECTING GOD'S PEOPLE TO GOD'S WORD AND DESIGN**. HUTH, ALLEN, J, MULTIPLE CLASS, (INT. CLS. 9, 16 AND 41), (U.S. CLS. 2, 5, 21, 22, 23, 26, 29, 36, 37, 38, 50, 100, 101 AND 107). SN 78-584,967. PUB. 9-12-2006. FILED 3-10-2005.
- 3,176,157. **DARYL HALL JOHN OATES (BLOCK FORM)**. WHOLE OATS ENTERPRISES, (U.S. CLS. 21, 23, 26, 36 AND 38). SN 78-595,103. PUB. 9-12-2006. FILED 3-25-2005.
- 3,176,167. **BEAUTIXX CREATIVE (BLOCK FORM)**. BSH BOSCH UND SIEMENS HAUSGERATE GMBH, (U.S. CLS. 21, 23, 26, 36 AND 38). SN 78-599,152. PUB. 7-4-2006. FILED 3-31-2005.
- 3,176,188. **SIMULVUE (BLOCK FORM)**. UNILENS CORP. U.S.A., (U.S. CLS. 21, 23, 26, 36 AND 38). SN 78-606,739. PUB. 5-23-2006. FILED 4-12-2005.
- 3,176,199. **EASYGUARD (BLOCK FORM)**. TOSHIBA AMERICA INFORMATION SYSTEMS, INC., (U.S. CLS. 21, 23, 26, 36 AND 38). SN 78-610,777. PUB. 9-12-2006. FILED 4-18-2005.
- 3,176,204. **MYOFFICE (STYLIZED)**. ELBEE PTY LTD, MULTIPLE CLASS, (INT. CLS. 9 AND 20), (U.S. CLS. 2, 13, 21, 22, 23, 25, 26, 32, 36, 38 AND 50). SN 78-612,451. PUB. 9-12-2006. FILED 4-20-2005.
- 3,176,231. **DART (BLOCK FORM)**. MEADWESTVACO PACKAGING SYSTEMS, LLC, (U.S. CLS. 21, 23, 26, 36 AND 38). SN 78-625,200. PUB. 9-12-2006. FILED 5-9-2005.
- 3,176,243. **STARINVERTER AND DESIGN**. PV POWERED, LLC, (U.S. CLS. 21, 23, 26, 36 AND 38). SN 78-627,091. PUB. 9-12-2006. FILED 5-10-2005.
- 3,176,247 (*See Class 7 for this trademark*).
- 3,176,248. **SCALA RIDER (BLOCK FORM)**. CARDO SYSTEMS, INC., (U.S. CLS. 21, 23, 26, 36 AND 38). SN 78-628,030. PUB. 9-12-2006. FILED 5-11-2005.
- 3,176,259. **UNIVERSAL STORE (BLOCK FORM)**. NEXUS BIOSYSTEMS, INC., (U.S. CLS. 21, 23, 26, 36 AND 38). SN 78-629,159. PUB. 9-12-2006. FILED 5-12-2005.
- 3,176,283. **MISCELLANEOUS DESIGN**. WQUEST COMMUNICATIONS, INC., (U.S. CLS. 21, 23, 26, 36 AND 38). SN 78-632,733. PUB. 9-12-2006. FILED 5-18-2005.
- 3,176,301. **TRUEPAIR (BLOCK FORM)**. SERIALIO, LLC, (U.S. CLS. 21, 23, 26, 36 AND 38). SN 78-637,543. PUB. 9-12-2006. FILED 5-25-2005.
- 3,176,323. **PORTAL (BLOCK FORM)**. DELAWARE CAPITAL FORMATION, INC., (U.S. CLS. 21, 23, 26, 36 AND 38). SN 78-641,956. PUB. 9-12-2006. FILED 6-2-2005.
- 3,176,348. **DIVINSA (BLOCK FORM)**. DIVINSA LLC, (U.S. CLS. 21, 23, 26, 36 AND 38). SN 78-649,343. PUB. 9-12-2006. FILED 6-13-2005.
- 3,176,359. **COPYMATE (BLOCK FORM)**. CONTEX A/S, (U.S. CLS. 21, 23, 26, 36 AND 38). SN 78-652,736. PUB. 9-12-2006. FILED 6-17-2005.
- 3,176,370. **GIGA-BIKE (BLOCK FORM)**. GIGA-BIKE INC., (U.S. CLS. 21, 23, 26, 36 AND 38). SN 78-654,687. PUB. 9-12-2006. FILED 6-20-2005.
- 3,176,371. **DAS KEYBOARD (BLOCK FORM)**. METADOT CORPORATION, (U.S. CLS. 21, 23, 26, 36 AND 38). SN 78-655,044. PUB. 9-12-2006. FILED 6-21-2005.
- 3,176,372. **MISCELLANEOUS DESIGN**. ALLEGRO MULTIMEDIA, INC., (U.S. CLS. 21, 23, 26, 36 AND 38). SN 78-655,429. PUB. 9-12-2006. FILED 6-21-2005.
- 3,176,377. **TRUTHPARTNER (BLOCK FORM)**. TRUTH FOR LIFE, (U.S. CLS. 21, 23, 26, 36 AND 38). SN 78-657,095. PUB. 9-12-2006. FILED 6-23-2005.
- 3,176,392. **ER (BLOCK FORM)**. WARNER BROS. ENTERTAINMENT INC., (U.S. CLS. 21, 23, 26, 36 AND 38). SN 78-660,239. PUB. 9-12-2006. FILED 6-28-2005.
- 3,176,393. **POWERLIGHT (BLOCK FORM)**. POWERLIGHT CORPORATION, MULTIPLE CLASS, (INT. CLS. 9 AND 19), (U.S. CLS. 1, 12, 21, 23, 26, 33, 36, 38 AND 50). SN 78-660,287. PUB. 9-12-2006. FILED 6-28-2005.
- 3,176,398. **ETHNIO (BLOCK FORM)**. BOLT PETERS, INC., MULTIPLE CLASS, (INT. CLS. 9 AND 42), (U.S. CLS. 21, 23, 26, 36, 38, 100 AND 101). SN 78-661,660. PUB. 9-12-2006. FILED 6-30-2005.
- 3,176,404. **FERROXDURE (BLOCK FORM)**. FERROXDURE S.A., (U.S. CLS. 21, 23, 26, 36 AND 38). SN 78-664,238. PUB. 9-12-2006. FILED 7-6-2005.
- 3,176,431. **APPLIED SYSTEMS AND DESIGN**. APPLIED SYSTEMS, INC., (U.S. CLS. 21, 23, 26, 36 AND 38). SN 78-

- 678,396. PUB. 9-12-2006. FILED 7-26-2005.
- 3,176,432. **I-LIGN (BLOCK FORM)**. I-LIGN LIMITED, MULTIPLE CLASS, (INT. CLS. 9 AND 42), (U.S. CLS. 21, 23, 26, 36, 38, 100 AND 101). SN 78-678,400. PUB. 9-12-2006. FILED 7-26-2005.
- 3,176,433. **ET AND DESIGN**. TRIDONICATCO GMBH & CO. KG, MULTIPLE CLASS, (INT. CLS. 9 AND 11), (U.S. CLS. 13, 21, 23, 26, 31, 34, 36 AND 38). SN 78-678,524. PUB. 9-12-2006. FILED 7-26-2005.
- 3,176,434. **NAG (STYLIZED)**. THE NUMERICAL ALGORITHMS GROUP LIMITED, MULTIPLE CLASS, (INT. CLS. 9 AND 16), (U.S. CLS. 2, 5, 21, 22, 23, 26, 29, 36, 37, 38 AND 50). SN 78-679,294. PUB. 9-12-2006. FILED 7-27-2005.
- 3,176,451. **7 AND DESIGN**. BANGKOK BROADCASTING & TV CO., LTD., MULTIPLE CLASS, (INT. CLS. 9, 38 AND 41), (U.S. CLS. 21, 23, 26, 36, 38, 100, 101, 104 AND 107). SN 78-690,264. PUB. 9-12-2006. FILED 8-11-2005.
- 3,176,452. **OCTOPLEX AND DESIGN**. CARLING TECHNOLOGIES, INC., (U.S. CLS. 21, 23, 26, 36 AND 38). SN 78-690,374. PUB. 9-12-2006. FILED 8-11-2005.
- 3,176,454. **CCI SOLUTIONS BE SEEN. BE HEARD. AND DESIGN**. CAPITAL COMMUNICATIONS INDUSTRIES, INC., MULTIPLE CLASS, (INT. CLS. 9, 11, 35, 37, 40 AND 42), (U.S. CLS. 13, 21, 23, 26, 31, 34, 36, 38, 100, 101, 102, 103 AND 106). SN 78-691,039. PUB. 9-12-2006. FILED 8-11-2005.
- 3,176,471. **ILLUMINE (BLOCK FORM)**. 5AM SOLUTIONS, INC., (U.S. CLS. 21, 23, 26, 36 AND 38). SN 78-698,799. PUB. 9-12-2006. FILED 8-23-2005.
- 3,176,472. **COMBISEP AND DESIGN**. COMBISEP, INC., (U.S. CLS. 21, 23, 26, 36 AND 38). SN 78-699,953. PUB. 9-12-2006. FILED 8-24-2005.
- 3,176,480. **QUADSTAR (BLOCK FORM)**. INFICON GMBH, (U.S. CLS. 21, 23, 26, 36 AND 38). SN 78-703,601. PUB. 9-12-2006. FILED 8-30-2005.
- 3,176,489. **LUNAR (BLOCK FORM)**. GAME ARTS CO., LTD, (U.S. CLS. 21, 23, 26, 36 AND 38). SN 78-707,346. PUB. 9-12-2006. FILED 9-6-2005.
- 3,176,491. **THE MIXER (BLOCK FORM)**. TREW AUDIO NASHVILLE, INC., MULTIPLE CLASS, (INT. CLS. 9 AND 16), (U.S. CLS. 2, 5, 21, 22, 23, 26, 29, 36, 37, 38 AND 50). SN 78-707,534. PUB. 9-12-2006. FILED 9-6-2005.
- 3,176,492. **KOOBOX (BLOCK FORM)**. LINSPIRE, INC., (U.S. CLS. 21, 23, 26, 36 AND 38). SN 78-707,603. PUB. 5-23-2006. FILED 9-6-2005.
- 3,176,494. **FASTWEL AND DESIGN**. FASTWEL INC, (U.S. CLS. 21, 23, 26, 36 AND 38). SN 78-708,415. PUB. 9-12-2006. FILED 9-7-2005.
- 3,176,498. **PROCESSMAKER (BLOCK FORM)**. COLOSA, MULTIPLE CLASS, (INT. CLS. 9 AND 42), (U.S. CLS. 21, 23, 26, 36, 38, 100 AND 101). SN 78-710,679. PUB. 9-12-2006. FILED 9-11-2005.
- 3,176,499. **MOVEMATE (BLOCK FORM)**. COBBE, ELLEN, (U.S. CLS. 21, 23, 26, 36 AND 38). SN 78-711,489. PUB. 9-12-2006. FILED 9-13-2005.
- 3,176,505. **JUPITERIMAGES (BLOCK FORM)**. JUPITERMEDIA CORPORATION, MULTIPLE CLASS, (INT. CLS. 9 AND 35), (U.S. CLS. 21, 23, 26, 36, 38, 100, 101 AND 102). SN 78-712,191. PUB. 9-12-2006. FILED 9-13-2005.
- 3,176,508. **FPML (BLOCK FORM)**. INTERNATIONAL SWAPS AND DERIVATIVES ASSOCIATION, INC., MULTIPLE CLASS, (INT. CLS. 9, 16, 35, 36 AND 41), (U.S. CLS. 2, 5, 21, 22, 23, 26, 29, 36, 37, 38, 50, 100, 101, 102 AND 107). SN 78-713,928. PUB. 9-12-2006. FILED 9-15-2005.
- 3,176,517. **MISCELLANEOUS DESIGN**. ACRONIS INC., (U.S. CLS. 21, 23, 26, 36 AND 38). SN 78-715,657. PUB. 9-12-2006. FILED 9-19-2005.
- 3,176,524. **SPECTOR CNE (BLOCK FORM)**. SPECTORSOFT CORPORATION, (U.S. CLS. 21, 23, 26, 36 AND 38). SN 78-718,559. PUB. 9-12-2006. FILED 9-22-2005.
- 3,176,544. **GEOAUTHOR (BLOCK FORM)**. INTERNATIONAL COMPUTER WORKS, INC., (U.S. CLS. 21, 23, 26, 36 AND 38). SN 78-722,719. PUB. 9-12-2006. FILED 9-28-2005.
- 3,176,565. **SCYLD POLICYMANAGER (BLOCK FORM)**. SCYLD COMPUTING CORPORATION, (U.S. CLS. 21, 23, 26, 36 AND 38). SN 78-730,273. PUB. 9-12-2006. FILED 10-10-2005.
- 3,176,585. **TRADING BLOX (BLOCK FORM)**. TRADING BLOX, LLC, (U.S. CLS. 21, 23, 26, 36 AND 38). SN 78-740,508. PUB. 9-12-2006. FILED 10-26-2005.
- 3,176,600. **PROTXCOL (BLOCK FORM)**. BARRETT, RON W, AND BARRETT, BARBARA, (U.S. CLS. 21, 23, 26, 36 AND 38). SN 78-745,760. PUB. 9-12-2006. FILED 11-2-2005.
- 3,176,602. **CONTOUR FIT LOGIC (BLOCK FORM)**. HILSINGER COMPANY, THE, (U.S. CLS. 21, 23, 26, 36 AND 38). SN 78-746,114. PUB. 9-12-2006. FILED 11-3-2005.
- 3,176,612. **PAYPLAY (BLOCK FORM)**. GOYKHMEN, ELIOT, (U.S. CLS. 21, 23, 26, 36 AND 38). SN 78-747,872. PUB. 9-12-2006. FILED 11-5-2005.
- 3,176,635. **FTI AND DESIGN**. FUTURE TECHNOLOGIES INC., (U.S. CLS. 21, 23, 26, 36 AND 38). SN 78-751,304. PUB. 9-12-2006. FILED 11-10-2005.
- 3,176,637. **BACKUPANDBURN AND DESIGN**. BACKUPANDBURN LLC, (U.S. CLS. 21, 23, 26, 36 AND 38). SN 78-751,750. PUB. 9-12-2006. FILED 11-10-2005.
- 3,176,642. **POMOGO (BLOCK FORM)**. POMOGO CORPORATION, (U.S. CLS. 21, 23, 26, 36 AND 38). SN 78-752,735. PUB. 9-12-2006. FILED 11-12-2005.
- 3,176,652. **TALENTPRO (BLOCK FORM)**. FREIBERGER, BENJIE, (U.S. CLS. 21, 23, 26, 36 AND 38). SN 78-755,532. PUB. 9-12-2006. FILED 11-16-2005.
- 3,176,658. **GAME DEVELOPER (BLOCK FORM)**. CMP MEDIA LLC, (U.S. CLS. 21, 23, 26, 36 AND 38). SN 78-757,005. PUB. 9-12-2006. FILED 11-18-2005.
- 3,176,671. **OUTRIDER (BLOCK FORM)**. SILVER BULLET TECHNOLOGY, INC., (U.S. CLS. 21, 23, 26, 36 AND 38). SN 78-761,285. PUB. 9-12-2006. FILED 11-28-2005.
- 3,176,673. **DOCUCASS (BLOCK FORM)**. CIMA SOFTWARE CORPORATION, (U.S. CLS. 21, 23, 26, 36 AND 38). SN 78-761,510. PUB. 9-12-2006. FILED 11-28-2005.
- 3,176,701. **ZILLABAR (BLOCK FORM)**. INTERNATIONAL SOFTWARE SYSTEMS SOLUTIONS, INC., (U.S. CLS. 21, 23, 26, 36 AND 38). SN 78-768,173. PUB. 9-12-2006. FILED 12-7-2005.
- 3,176,709. **OUTRIDER AND DESIGN**. SILVER BULLET TECHNOLOGY, INC., (U.S. CLS. 21, 23, 26, 36 AND 38). SN 78-770,108. PUB. 9-12-2006. FILED 12-9-2005.
- 3,176,715. **MDASHBOARD (BLOCK FORM)**. PYXIS MOBILE, INC., (U.S. CLS. 21, 23, 26, 36 AND 38). SN 78-772,583. PUB. 9-12-2006. FILED 12-13-2005.
- 3,176,728. **PLEOMAX (BLOCK FORM)**. SAMSUNG CORPORATION, (U.S. CLS. 21, 23, 26, 36 AND 38). SN 78-774,143. PUB. 9-12-2006. FILED 12-15-2005.
- 3,176,733. **SUPPORTLOGIK (BLOCK FORM)**. LOGIKONLINE INC., (U.S. CLS. 21, 23, 26, 36 AND 38). SN 78-774,657. PUB. 9-12-2006. FILED 12-15-2005.
- 3,176,734. **STORELOGIK (BLOCK FORM)**. LOGIKONLINE INC., (U.S. CLS. 21, 23, 26, 36 AND 38). SN 78-774,660. PUB. 9-12-2006. FILED 12-15-2005.
- 3,176,748. **INTEGRA (BLOCK FORM)**. SYSTECH, INC., (U.S. CLS. 21, 23, 26, 36 AND 38). SN 78-775,744. PUB. 9-12-2006. FILED 12-18-2005.
- 3,176,771 (*See Class 3 for this trademark*).
- 3,176,776. **TOPZONE (BLOCK FORM)**. TOPSONIC, INC., (U.S. CLS. 21, 23, 26, 36 AND 38). SN 78-778,752. PUB. 9-12-2006. FILED 12-21-2005.
- 3,176,780. **NOAA RNC (BLOCK FORM)**. NATIONAL OCEANIC AND ATMOSPHERIC ADMINISTRATION, U.S. DEPARTMENT OF COMMERCE, (U.S. CLS. 21, 23, 26, 36 AND 38). SN 78-779,055. PUB. 9-12-2006. FILED 12-22-2005.
- 3,176,791. **OPTICAL CRACK TRACER (BLOCK FORM)**. LA VISION GMBH, (U.S. CLS. 21, 23, 26, 36 AND 38). SN 78-779,433. PUB. 9-12-2006. FILED 12-22-2005.
- 3,176,793. **SOOTMASTER (BLOCK FORM)**. LA VISION GMBH, (U.S. CLS. 21, 23, 26, 36 AND 38). SN 78-779,581. PUB. 9-12-2006. FILED 12-22-2005.
- 3,176,795. **STRAINMASTER (BLOCK FORM)**. LAVISION GMBH, (U.S. CLS. 21, 23, 26, 36 AND 38). SN 78-779,657. PUB. 9-12-2006. FILED 12-22-2005.
- 3,176,804. **SLICK SLEUTH (BLOCK FORM)**. INTEROCEAN SYSTEMS, INC., (U.S. CLS. 21, 23, 26, 36 AND 38). SN 78-780,264. PUB. 9-12-2006. FILED 12-23-2005.
- 3,176,805. **SLICK SLEUTH AND DESIGN**. INTEROCEAN SYSTEMS, INC., (U.S. CLS. 21, 23, 26, 36 AND 38). SN 78-780,350. PUB. 9-12-2006. FILED 12-23-2005.
- 3,176,807. **SELETRADIO AND DESIGN**. CARDON VENTURES, LLC, (U.S. CLS. 21, 23, 26, 36 AND 38). SN 78-

- 780,472. PUB. 9-12-2006. FILED 12-23-2005.
- 3,176,809. **MICROTELECOM (BLOCK FORM)**. SHECHTER, YONATHAN, (U.S. CLS. 21, 23, 26, 36 AND 38). SN 78-780,759. PUB. 9-12-2006. FILED 12-26-2005.
- 3,176,816. **WEAR YOUR HEART ON YOUR WRIST (BLOCK FORM)**. HIGH GEAR USA, INC., (U.S. CLS. 21, 23, 26, 36 AND 38). SN 78-781,064. PUB. 9-12-2006. FILED 12-27-2005.
- 3,176,824. **LINEGRABBER (BLOCK FORM)**. SIGMA COMMUNICATIONS, LLC, (U.S. CLS. 21, 23, 26, 36 AND 38). SN 78-781,656. PUB. 9-12-2006. FILED 12-28-2005.
- 3,176,863. **CONQUISTADOR (BLOCK FORM)**. MARWITZ, HANS-JOACHIM, (U.S. CLS. 21, 23, 26, 36 AND 38). SN 78-784,561. PUB. 9-12-2006. FILED 1-4-2006.
- 3,176,889. **ACCUNOM (BLOCK FORM)**. CENTERPOINT ENERGY FIELD SERVICES, INC., (U.S. CLS. 21, 23, 26, 36 AND 38). SN 78-785,858. PUB. 9-12-2006. FILED 1-5-2006.
- 3,176,893. **A (STYLIZED)**. ALLIED ELECTRONICS INC., (U.S. CLS. 21, 23, 26, 36 AND 38). SN 78-786,089. PUB. 9-12-2006. FILED 1-6-2006.
- 3,176,907. **CADLOCK (BLOCK FORM)**. CADLOCK, INC., (U.S. CLS. 21, 23, 26, 36 AND 38). SN 78-786,871. PUB. 9-12-2006. FILED 1-6-2006.
- 3,176,915. **ILLUMINATION WITH CHARM (BLOCK FORM)**. HUSBANDS, JOSEPH WHITTLE, (U.S. CLS. 21, 23, 26, 36 AND 38). SN 78-787,156. PUB. 9-12-2006. FILED 1-8-2006.
- 3,176,918. **VIVIDEA (BLOCK FORM)**. VIVIDEA, INC., (U.S. CLS. 21, 23, 26, 36 AND 38). SN 78-787,419. PUB. 9-12-2006. FILED 1-9-2006.
- 3,176,920. **LIFETIMEPHS (BLOCK FORM)**. VIVIDEA, INC., (U.S. CLS. 21, 23, 26, 36 AND 38). SN 78-787,432. PUB. 9-12-2006. FILED 1-9-2006.
- 3,176,936. **EVEREADY (BLOCK FORM)**. EVEREADY BATTERY COMPANY, INC., (U.S. CLS. 21, 23, 26, 36 AND 38). SN 78-788,598. PUB. 9-12-2006. FILED 1-10-2006.
- 3,176,967. **EXCURSION (BLOCK FORM)**. OCEANIC, (U.S. CLS. 21, 23, 26, 36 AND 38). SN 78-791,077. PUB. 9-12-2006. FILED 1-13-2006.
- 3,176,968. **HANDAPPS (BLOCK FORM)**. CALIENES, RICHARD J., (U.S. CLS. 21, 23, 26, 36 AND 38). SN 78-791,098. PUB. 9-12-2006. FILED 1-13-2006.
- 3,176,977. **VAPANET (BLOCK FORM)**. VENTROL AIR HANDLING SYSTEMS, INC., (U.S. CLS. 21, 23, 26, 36 AND 38). SN 78-791,578. PUB. 9-12-2006. FILED 1-13-2006.
- 3,176,979. **ABUNDANT & CONSTANT (BLOCK FORM)**. BOUNTIFUL WIFI LLC, (U.S. CLS. 21, 23, 26, 36 AND 38). SN 78-791,659. PUB. 9-12-2006. FILED 1-13-2006.
- 3,177,019. **USBEE (BLOCK FORM)**. HARVEY, TIMOTHY JOHN, (U.S. CLS. 21, 23, 26, 36 AND 38). SN 78-793,432. PUB. 9-12-2006. FILED 1-17-2006.
- 3,177,021. **REIKO (STYLIZED)**. REIKO WIRELESS INC., (U.S. CLS. 21, 23, 26, 36 AND 38). SN 78-793,487. PUB. 9-12-2006. FILED 1-18-2006.
- 3,177,048. **HOW DOES YOUR COMPANY PRESENT ITSELF? (BLOCK FORM)**. STREAMSERVE, INC., (U.S. CLS. 21, 23, 26, 36 AND 38). SN 78-794,109. PUB. 9-12-2006. FILED 1-18-2006.
- 3,177,049. **MISCELLANEOUS DESIGN**. STREAMSERVE, INC., (U.S. CLS. 21, 23, 26, 36 AND 38). SN 78-794,150. PUB. 9-12-2006. FILED 1-18-2006.
- 3,177,053. **STREAMSERVE AND DESIGN**. STREAMSERVE, INC., (U.S. CLS. 21, 23, 26, 36 AND 38). SN 78-794,159. PUB. 9-12-2006. FILED 1-18-2006.
- 3,177,060. **ANALYSIS SERVER (BLOCK FORM)**. PHOENIX INTEGRATION, INC., (U.S. CLS. 21, 23, 26, 36 AND 38). SN 78-794,513. PUB. 9-12-2006. FILED 1-19-2006.
- 3,177,061. **WIZZARD (BLOCK FORM)**. WIZZARD SOFTWARE CORPORATION, (U.S. CLS. 21, 23, 26, 36 AND 38). SN 78-794,515. PUB. 9-12-2006. FILED 1-19-2006.
- 3,177,062. **CAMP (BLOCK FORM)**. CAMP COMPANY OF ST. PETERSBURG, (U.S. CLS. 21, 23, 26, 36 AND 38). SN 78-794,542. PUB. 9-12-2006. FILED 1-19-2006.
- 3,177,073. **MICROBIRD (BLOCK FORM)**. ASCENSION TECHNOLOGY CORPORATION, (U.S. CLS. 21, 23, 26, 36 AND 38). SN 78-794,802. PUB. 9-12-2006. FILED 1-19-2006.
- 3,177,075. **PHASORBIRD (BLOCK FORM)**. ASCENSION TECHNOLOGY CORPORATION, (U.S. CLS. 21, 23, 26, 36 AND 38). SN 78-794,827. PUB. 9-12-2006. FILED 1-19-2006.
- 3,177,095. **FAITH COMPASS (BLOCK FORM)**. HEARTLAND, PAULA R., (U.S. CLS. 21, 23, 26, 36 AND 38). SN 78-796,079. PUB. 9-12-2006. FILED 1-20-2006.
- 3,177,116. **TRU-COST ESTIMATING AND DESIGN**. NELSON DESIGN GROUP, LLC, (U.S. CLS. 21, 23, 26, 36 AND 38). SN 78-797,400. PUB. 9-12-2006. FILED 1-23-2006.
- 3,177,130. **VIVIDEA AND DESIGN**. VIVIDEA, INC., (U.S. CLS. 21, 23, 26, 36 AND 38). SN 78-798,561. PUB. 9-12-2006. FILED 1-24-2006.
- 3,177,142. **SPECTRACK AND DESIGN**. DADE BEHRING INC., (U.S. CLS. 21, 23, 26, 36 AND 38). SN 78-804,584. PUB. 9-12-2006. FILED 2-1-2006.
- 3,177,143. **SCADAMESH (BLOCK FORM)**. DESILVIO, LOUIS F., (U.S. CLS. 21, 23, 26, 36 AND 38). SN 78-805,166. PUB. 9-12-2006. FILED 2-2-2006.
- 3,177,191. **PARKEON (STYLIZED)**. PARKEON, MULTIPLE CLASS, (INT. CLS. 9, 35, 37, 38, 39 AND 42), (U.S. CLS. 21, 23, 26, 36, 38, 100, 101, 102, 103, 104, 105 AND 106). SN 79-003,796. PUB. 9-12-2006. FILED 2-25-2004.
- 3,177,193. **MADE 2 RACE AND DESIGN**. AUSTUS INVESTMENTS PTY LTD, MULTIPLE CLASS, (INT. CLS. 9 AND 25), (U.S. CLS. 21, 22, 23, 26, 36, 38 AND 39). SN 79-004,182. PUB. 9-12-2006. FILED 4-15-2004.
- 3,177,196. **SPIUK HIGH TECHNOLOGY AND DESIGN**. JOSE MANUEL FERNANDEZ ARZA, MULTIPLE CLASS, (INT. CLS. 9 AND 25), (U.S. CLS. 21, 22, 23, 26, 36, 38 AND 39). SN 79-007,144. PUB. 9-12-2006. FILED 7-1-2004.
- 3,177,199. **MIM MIRROR-INVERSE-MIRROR AND DESIGN**. OVD KINEGRAM AG, MULTIPLE CLASS, (INT. CLS. 9, 16 AND 17), (U.S. CLS. 1, 2, 5, 12, 13, 21, 22, 23, 26, 29, 35, 36, 37, 38 AND 50). SN 79-007,475. PUB. 9-12-2006. FILED 11-2-2004.
- 3,177,203 (*See Class 6 for this trademark*).
- 3,177,215. **VIDAL (BLOCK FORM)**. VIDAL, MULTIPLE CLASS, (INT. CLS. 9, 16, 35, 38, 40, 41, 42 AND 44), (U.S. CLS. 2, 5, 21, 22, 23, 26, 29, 36, 37, 38, 50, 100, 101, 102, 103, 104, 106 AND 107). SN 79-011,188. PUB. 9-12-2006. FILED 8-31-2004.
- 3,177,218. **ACTIONAID INTERNATIONAL (BLOCK FORM)**. ACTIONAID, MULTIPLE CLASS, (INT. CLS. 9, 16, 35, 36 AND 41), (U.S. CLS. 2, 5, 21, 22, 23, 26, 29, 36, 37, 38, 50, 100, 101, 102 AND 107). SN 79-011,600. PUB. 9-12-2006. FILED 4-22-2005.
- 3,177,220. **BM SYNC-DRIVE (BLOCK FORM)**. BAUMÜLLER ANLAGEN-SYSTEMTECHNIK GMBH & CO., (U.S. CLS. 21, 23, 26, 36 AND 38). SN 79-011,640. PUB. 9-12-2006. FILED 2-18-2005.
- 3,177,225. **SANI-ALARM (BLOCK FORM)**. SOCIETE FRANCAISE D'ASSAINISSEMENT-SFA, (U.S. CLS. 21, 23, 26, 36 AND 38). SN 79-012,063. PUB. 9-12-2006. FILED 6-3-2005.
- 3,177,226. **TWINTORCH (STYLIZED)**. NEXANS, (U.S. CLS. 21, 23, 26, 36 AND 38). SN 79-012,086. PUB. 9-12-2006. FILED 11-5-2004.
- 3,177,242 (*See Class 6 for this trademark*).
- 3,177,248. **VARILUX COMPUTER (BLOCK FORM)**. ESSILOR INTERNATIONAL (COMPAGNIE GENERALE D'OPTIQUE), (U.S. CLS. 21, 23, 26, 36 AND 38). SN 79-013,580. PUB. 9-12-2006. FILED 6-29-2005.
- 3,177,253. **EAGLE AND DESIGN**. KEE TECHNOLOGIES PTY LTD, (U.S. CLS. 21, 23, 26, 36 AND 38). SN 79-013,793. PUB. 9-12-2006. FILED 4-13-2005.
- 3,177,254 (*See Class 8 for this trademark*).
- 3,177,256. **MLSC (BLOCK FORM)**. EPCOS AG, (U.S. CLS. 21, 23, 26, 36 AND 38). SN 79-013,914. PUB. 9-12-2006. FILED 6-29-2005.
- 3,177,257. **LINEAR MATRIX (BLOCK FORM)**. SPICON INDUSTRIES PTY LTD, (U.S. CLS. 21, 23, 26, 36 AND 38). SN 79-013,994. PUB. 9-12-2006. FILED 4-1-2005.
- 3,177,262. **MIER AND DESIGN**. MIER COMUNICACIONES S.A., (U.S. CLS. 21, 23, 26, 36 AND 38). SN 79-014,308. PUB. 9-12-2006. FILED 6-16-2005.
- 3,177,266. **ADNOVUM (BLOCK FORM)**. ADNOVUM INFORMATIK AG, MULTIPLE CLASS, (INT. CLS. 9, 16, 35, 38, 41 AND 42), (U.S. CLS. 2, 5, 21, 22, 23, 26, 29, 36, 37, 38, 50, 100, 101, 102, 104 AND 107). SN 79-014,700. PUB. 9-12-2006. FILED 4-19-2005.
- 3,177,267. **GST AND DESIGN**. GULF SECURITY TECHNOLOGY CO., LTD., (U.S. CLS. 21, 23, 26, 36 AND 38). SN 79-014,701. PUB. 9-12-2006. FILED 5-9-2005.
- 3,177,273 (*See Class 7 for this trademark*).

- 3,177,277. **SVEC AND DESIGN**. SICHUAN VIDEO ELECTRONIC CO., LTD., (U.S. CLS. 21, 23, 26, 36 AND 38). SN 79-015,653. PUB. 9-12-2006. FILED 8-8-2005.
- 3,177,278. **FREE7 (BLOCK FORM)**. POWER-BIKE GMBH, MULTIPLE CLASS, (INT. CLS. 9 AND 25), (U.S. CLS. 21, 22, 23, 26, 36, 38 AND 39). SN 79-015,739. PUB. 9-12-2006. FILED 7-1-2005.
- 3,177,280 (*See Class 1 for this trademark*).
- 3,177,282. **BLUE SOLEIL (STYLIZED)**. IVT SOFTWARE TECHNOLOGY INC., (U.S. CLS. 21, 23, 26, 36 AND 38). SN 79-016,218. PUB. 9-12-2006. FILED 11-22-2004.
- 3,177,283. **CONTROLS AND DESIGN**. MIGUEL ANGEL IGLESIAS BALLESTER, MULTIPLE CLASS, (INT. CLS. 9 AND 19), (U.S. CLS. 1, 12, 21, 23, 26, 33, 36, 38 AND 50). SN 79-016,288. PUB. 9-12-2006. FILED 12-20-2004.
- 3,177,286. **KRYPTO AND DESIGN**. STMICROELECTRONICS S.R.L., (U.S. CLS. 21, 23, 26, 36 AND 38). SN 79-016,469. PUB. 9-12-2006. FILED 4-27-2005.
- 3,177,288. **AIRSENSE AND DESIGN**. AIRSENSE ANALYTICS GMBH, MULTIPLE CLASS, (INT. CLS. 9 AND 42), (U.S. CLS. 21, 23, 26, 36, 38, 100 AND 101). SN 79-016,533. PUB. 9-12-2006. FILED 8-26-2005.
- 3,177,289. **B-NET (STYLIZED)**. KABA BENZING GMBH, (U.S. CLS. 21, 23, 26, 36 AND 38). SN 79-016,559. PUB. 9-12-2006. FILED 9-8-2005.
- 3,177,290 (*See Class 6 for this trademark*).
- 3,177,292. **BACKHOME (BLOCK FORM)**. VIRBAC S.A., MULTIPLE CLASS, (INT. CLS. 9, 10, 18 AND 45), (U.S. CLS. 1, 2, 3, 21, 22, 23, 26, 36, 38, 39, 41, 44, 100 AND 101). SN 79-016,619. PUB. 9-12-2006. FILED 8-4-2005.
- 3,177,297. **NASP (BLOCK FORM)**. NASP III/V GMBH, MULTIPLE CLASS, (INT. CLS. 9, 41 AND 42), (U.S. CLS. 21, 23, 26, 36, 38, 100, 101 AND 107). SN 79-017,869. PUB. 9-12-2006. FILED 4-1-2005.
- 3,177,299. **SHOULDERS OF GIANTS (BLOCK FORM)**. COMPTON HOUSE PUBLISHING LIMITED, MULTIPLE CLASS, (INT. CLS. 9, 16, 35 AND 41), (U.S. CLS. 2, 5, 21, 22, 23, 26, 29, 36, 37, 38, 50, 100, 101, 102 AND 107). SN 79-017,943. PUB. 9-12-2006. FILED 3-23-2005.
- 3,177,300. **ZELIX (BLOCK FORM)**. ZELIX PTY LTD, (U.S. CLS. 21, 23, 26, 36 AND 38). SN 79-017,949. PUB. 9-12-2006. FILED 11-7-2005.
- 3,177,306. **PHYSIO (BLOCK FORM)**. ESSLOR INTERNATIONAL (COMPAGNIE GENERALE D'OPTIQUE), (U.S. CLS. 21, 23, 26, 36 AND 38). SN 79-018,693. PUB. 9-12-2006. FILED 11-7-2005.
- 3,177,308 (*See Class 6 for this trademark*).
- 3,177,318. **LIVE AT FIRST SIGHT (BLOCK FORM)**. WAVE-LIGHT LASER TECHNOLOGIE AG, MULTIPLE CLASS, (INT. CLS. 9, 10, 37 AND 41), (U.S. CLS. 21, 23, 26, 36, 38, 39, 44, 100, 101, 103, 106 AND 107). SN 79-021,432. PUB. 9-12-2006. FILED 12-12-2005.
- 3,177,319. **THINLAY (BLOCK FORM)**. UPM RAFLATA OY, MULTIPLE CLASS, (INT. CLS. 9 AND 16), (U.S. CLS. 2, 5, 21, 22, 23, 26, 29, 36, 37, 38 AND 50). SN 79-022,251. PUB. 9-12-2006. FILED 9-7-2005.
- 3,177,320. **FREIGHTDATA 2000 AND DESIGN**. FREIGHTDATA 2000 LTD, (U.S. CLS. 21, 23, 26, 36 AND 38). SN 79-023,166. PUB. 9-12-2006. FILED 11-26-2005.
- 3,177,321. **SHOTO AND DESIGN**. JIANGSU SHUANGDENG DIANYUAN; YOUXIAN GONGSI, (U.S. CLS. 21, 23, 26, 36 AND 38). SN 79-023,378. PUB. 9-12-2006. FILED 1-5-2006.
- 9-12-2006. FILED 12-23-2005.
- 3,175,923 (*See Class 6 for this trademark*).
- 3,175,934 (*See Class 6 for this trademark*).
- 3,175,965. **R RESISTA-TEMPS, INC. AND DESIGN**. RESISTA-TEMPS INC., (U.S. CLS. 26, 39 AND 44). SN 78-325,204. PUB. 10-25-2005. FILED 11-9-2003.
- 3,175,997 (*See Class 5 for this trademark*).
- 3,176,090. **ALPS (BLOCK FORM)**. ALPS SOUTH CORPORATION, (U.S. CLS. 26, 39 AND 44). SN 78-536,176. PUB. 9-12-2006. FILED 12-21-2004.
- 3,176,134. **XIA PRECISION SYSTEM (BLOCK FORM)**. HOWMEDICA OSTEONICS CORP., (U.S. CLS. 26, 39 AND 44). SN 78-577,535. PUB. 9-12-2006. FILED 3-1-2005.
- 3,176,146. **RELIEVA (BLOCK FORM)**. ACCLARENT, INC., (U.S. CLS. 26, 39 AND 44). SN 78-587,020. PUB. 9-12-2006. FILED 3-14-2005.
- 3,176,162. **ECHO BED (BLOCK FORM)**. MEDICAL POSITIONING, INC., (U.S. CLS. 26, 39 AND 44). SN 78-598,090. PUB. 9-12-2006. FILED 3-30-2005.
- 3,176,224 (*See Class 5 for this trademark*).
- 3,176,287. **MEGATIP (BLOCK FORM)**. MEGADYNE MEDICAL PRODUCTS, INC., (U.S. CLS. 26, 39 AND 44). SN 78-634,378. PUB. 9-12-2006. FILED 5-20-2005.
- 3,176,386. **MAGIC BALLS (BLOCK FORM)**. JILL R. PAYNE, P.C., (U.S. CLS. 26, 39 AND 44). SN 78-659,170. PUB. 9-12-2006. FILED 6-27-2005.
- 3,176,457. **TTBIO AND DESIGN**. THUNDER TIGER CORPORATION, (U.S. CLS. 26, 39 AND 44). SN 78-692,107. PUB. 9-12-2006. FILED 8-13-2005.
- 3,176,540. **TRION:Z AND DESIGN**. COLANTOTTE INTERNATIONAL, INC., (U.S. CLS. 26, 39 AND 44). SN 78-721,808. PUB. 9-12-2006. FILED 9-27-2005.
- 3,176,568. **MAGNA-SITE (BLOCK FORM)**. INAMED MEDICAL PRODUCTS CORPORATION, (U.S. CLS. 26, 39 AND 44). SN 78-730,842. PUB. 9-12-2006. FILED 10-11-2005.
- 3,176,575. **MANAN (BLOCK FORM)**. MANAN MEDICAL PRODUCTS, INC., (U.S. CLS. 26, 39 AND 44). SN 78-735,673. PUB. 9-12-2006. FILED 10-18-2005.
- 3,176,648. **TZ AND DESIGN**. SCOTT, JOHN, (U.S. CLS. 26, 39 AND 44). SN 78-754,363. PUB. 9-12-2006. FILED 11-15-2005.
- 3,176,684. **OPTRAPOL (BLOCK FORM)**. IVOCLAR VIVADENT, INC., (U.S. CLS. 26, 39 AND 44). SN 78-764,395. PUB. 9-12-2006. FILED 12-1-2005.
- 3,176,731. **DOUBLEWIRE (BLOCK FORM)**. ALTO DEVELOPMENT CORPORATION, (U.S. CLS. 26, 39 AND 44). SN 78-774,437. PUB. 9-12-2006. FILED 12-15-2005.
- 3,176,827. **QUICKCUT (BLOCK FORM)**. ABBOTT VASCULAR INC., (U.S. CLS. 26, 39 AND 44). SN 78-781,758. PUB. 9-12-2006. FILED 12-28-2005.
- 3,176,830. **MODUPRO (BLOCK FORM)**. ACADENTAL, INC., (U.S. CLS. 26, 39 AND 44). SN 78-782,124. PUB. 9-12-2006. FILED 12-29-2005.
- 3,176,882. **RHOTON (BLOCK FORM)**. RHOTON, ALBERT L., JR., (U.S. CLS. 26, 39 AND 44). SN 78-785,458. PUB. 9-12-2006. FILED 1-5-2006.
- 3,177,067. **GX (BLOCK FORM)**. GENDEX CORPORATION, (U.S. CLS. 26, 39 AND 44). SN 78-794,590. PUB. 9-12-2006. FILED 1-19-2006.
- 3,177,068. **765DC (BLOCK FORM)**. GENDEX CORPORATION, (U.S. CLS. 26, 39 AND 44). SN 78-794,594. PUB. 9-12-2006. FILED 1-19-2006.
- 3,177,207. **CONSEAL (BLOCK FORM)**. COLOPLAST A/S, (U.S. CLS. 26, 39 AND 44). SN 79-009,622. PUB. 9-12-2006. FILED 2-21-2005.
- 3,177,210. **NOTCH-LOCK (BLOCK FORM)**. WALDEMAR LINK GMBH & CO. KG, (U.S. CLS. 26, 39 AND 44). SN 79-010,648. PUB. 9-12-2006. FILED 3-23-2005.
- 3,177,261. **THD (BLOCK FORM)**. G.F. SRL, (U.S. CLS. 26, 39 AND 44). SN 79-014,298. PUB. 9-12-2006. FILED 6-21-2005.
- 3,177,292 (*See Class 9 for this trademark*).
- 3,177,318 (*See Class 9 for this trademark*).
- 3,177,322. **AMBIX (BLOCK FORM)**. FRESINIUS KABI AG, (U.S. CLS. 26, 39 AND 44). SN 79-024,240. PUB. 9-12-2006. FILED 1-23-2006.

CLASS 10—MEDICAL APPARATUS

- 3,175,771 (*See Class 9 for this trademark*).
- 3,175,782. **K-POWERGRIP (STYLIZED)**. KALTENBACH & VOIGT GMBH & CO. KG, FORMERLY KALTENBACH & VOIGT GMBH & CO., (U.S. CLS. 26, 39 AND 44). SN 76-528,792. PUB. 12-21-2004. FILED 7-9-2003.
- 3,175,841. **UNIBAL (BLOCK FORM)**. YUSHIN MEDICAL, CO., LTD., (U.S. CLS. 26, 39 AND 44). SN 76-637,847. PUB. 9-12-2006. FILED 5-2-2005.
- 3,175,846 (*See Class 9 for this trademark*).
- 3,175,906. **MISCELLANEOUS DESIGN**. AXIS DENTAL CORPORATION, (U.S. CLS. 26, 39 AND 44). SN 76-652,453. PUB.

CLASS 11—ENVIRONMENTAL CONTROL APPARATUS

- 3,175,785. **LUMIPURE**. D&M SALES, INC., (U.S. CLS. 13, 21, 23, 31 AND 34). SN 76-539,663. PUB. 9-12-2006. FILED 8-25-2003.
- 3,175,794 (*See Class 7 for this trademark*).
- 3,175,804. **WB AND DESIGN**. LIN, XUANDONG, (U.S. CLS. 13, 21, 23, 31 AND 34). SN 76-586,372. PUB. 9-12-2006. FILED 4-7-2004.
- 3,175,812. **CHAMBERMAID ASEPI-CLAVE (STYLIZED)**. O'NEAL, WILLIAM E, (U.S. CLS. 13, 21, 23, 31 AND 34). SN 76-602,331. PUB. 9-12-2006. FILED 7-14-2004.
- 3,175,820 (*See Class 6 for this trademark*).
- 3,175,837. **JAVAFLOW AND DESIGN**. JAVAFLOW, LLC, (U.S. CLS. 13, 21, 23, 31 AND 34). SN 76-636,232. PUB. 9-12-2006. FILED 4-18-2005.
- 3,175,931. **QUITE REVOLUTIONARY (STYLIZED)**. MILLICAN, DEWITT T., (U.S. CLS. 13, 21, 23, 31 AND 34). SN 76-653,553. PUB. 9-12-2006. FILED 1-17-2006.
- 3,175,958 (*See Class 6 for this trademark*).
- 3,176,006. **SCRAPS ARTERNATIVE DESIGNS DIVISION OF CYCLONE PRINTING INC. AND DESIGN**. CYCLONE PRINTING, INC., (U.S. CLS. 13, 21, 23, 31 AND 34). SN 78-442,169. PUB. 9-12-2006. FILED 6-28-2004.
- 3,176,052. **PROFILES SPA (BLOCK FORM)**. APPLICA CONSUMER PRODUCTS, INC., MULTIPLE CLASS, (INT. CLS. 11, 20 AND 21), (U.S. CLS. 2, 13, 21, 22, 23, 25, 29, 30, 31, 32, 33, 34, 40 AND 50). SN 78-500,630. PUB. 9-12-2006. FILED 10-15-2004.
- 3,176,067 (*See Class 9 for this trademark*).
- 3,176,088. **XTEC (BLOCK FORM)**. AU-LITE LIGHTING INC., (U.S. CLS. 13, 21, 23, 31 AND 34). SN 78-534,938. PUB. 9-12-2006. FILED 12-17-2004.
- 3,176,120 (*See Class 3 for this trademark*).
- 3,176,124. **ORION COOKER AND DESIGN**. FC INDUSTRIES, LLC, (U.S. CLS. 13, 21, 23, 31 AND 34). SN 78-566,946. PUB. 9-12-2006. FILED 2-14-2005.
- 3,176,126. **SUNLINK AND DESIGN**. SOURCE PRO US, LLC, (U.S. CLS. 13, 21, 23, 31 AND 34). SN 78-568,796. PUB. 9-12-2006. FILED 2-16-2005.
- 3,176,154. **EXCALIBUR AND DESIGN**. KILLER BAIT, INC., (U.S. CLS. 13, 21, 23, 31 AND 34). SN 78-590,702. PUB. 9-12-2006. FILED 3-18-2005.
- 3,176,193. **ANYWHERE ANYWHERE (BLOCK FORM)**. HYDRATION TECHNOLOGIES, INC., (U.S. CLS. 13, 21, 23, 31 AND 34). SN 78-609,102. PUB. 9-12-2006. FILED 4-14-2005.
- 3,176,232. **EQUATOR WATER HEATERS ENTER THE HEAT ZONE AND DESIGN**. PLUMBERS' SUCCESS INTERNATIONAL, LLC, (U.S. CLS. 13, 21, 23, 31 AND 34). SN 78-625,390. PUB. 9-12-2006. FILED 5-9-2005.
- 3,176,263 (*See Class 7 for this trademark*).
- 3,176,276. **BABYLISS PRO TT (BLOCK FORM)**. CONAIR CORPORATION, (U.S. CLS. 13, 21, 23, 31 AND 34). SN 78-631,796. PUB. 9-12-2006. FILED 5-17-2005.
- 3,176,288. **MISCELLANEOUS DESIGN**. PHILLIPS PLASTICS CORPORATION, (U.S. CLS. 13, 21, 23, 31 AND 34). SN 78-634,563. PUB. 9-12-2006. FILED 5-23-2005.
- 3,176,387 (*See Class 7 for this trademark*).
- 3,176,402. **CT COOLTEK AND DESIGN**. SHANGHAI COOL-AIR TRANSPORT REFRIGERATION EQUIPMENT CO., LTD., (U.S. CLS. 13, 21, 23, 31 AND 34). SN 78-664,020. PUB. 9-12-2006. FILED 7-5-2005.
- 3,176,424. **BERYL (STYLIZED)**. LEI, CHARLES, AND CHUANG, JOHN, (U.S. CLS. 13, 21, 23, 31 AND 34). SN 78-670,067. PUB. 9-12-2006. FILED 7-13-2005.
- 3,176,433 (*See Class 9 for this trademark*).
- 3,176,442. **PLATINO SPA (BLOCK FORM)**. EUROPEAN TOUCH HOLDINGS, INC., (U.S. CLS. 13, 21, 23, 31 AND 34). SN 78-685,798. PUB. 9-12-2006. FILED 8-4-2005.
- 3,176,454 (*See Class 9 for this trademark*).
- 3,176,459. **ICE ZAPPER (BLOCK FORM)**. SKYVISION, INC., (U.S. CLS. 13, 21, 23, 31 AND 34). SN 78-693,316. PUB. 9-12-2006. FILED 8-16-2005.
- 3,176,483. **MISCELLANEOUS DESIGN**. FUSAN MACHINERY CO., LTD., (U.S. CLS. 13, 21, 23, 31 AND 34). SN 78-704,191. PUB. 9-12-2006. FILED 8-31-2005.
- 3,176,545. **DECOLAV (BLOCK FORM)**. DECO LAV, INC., MULTIPLE CLASS, (INT. CLS. 11, 20 AND 21), (U.S. CLS. 2,

- 13, 21, 22, 23, 25, 29, 30, 31, 32, 33, 34, 40 AND 50). SN 78-722,734. PUB. 9-12-2006. FILED 9-28-2005.
- 3,176,634. **CLEAR CHOICE (BLOCK FORM)**. AQUASTAR POOL PRODUCTS, INC., (U.S. CLS. 13, 21, 23, 31 AND 34). SN 78-750,456. PUB. 9-12-2006. FILED 11-9-2005.
- 3,176,799. **CHLORPLUS (BLOCK FORM)**. PENTAIR FILTRATION, INC., (U.S. CLS. 13, 21, 23, 31 AND 34). SN 78-780,031. PUB. 9-12-2006. FILED 12-23-2005.
- 3,176,978. **VAPASORB (BLOCK FORM)**. VENTROL AIR HANDLING SYSTEMS, INC., (U.S. CLS. 13, 21, 23, 31 AND 34). SN 78-791,627. PUB. 9-12-2006. FILED 1-13-2006.
- 3,177,185. **BRIO II (BLOCK FORM)**. MAAX CANADA INC., (U.S. CLS. 13, 21, 23, 31 AND 34). SN 78-849,850. PUB. 9-12-2006. FILED 3-30-2006.
- 3,177,209 (*See Class 7 for this trademark*).
- 3,177,240 (*See Class 3 for this trademark*).
- 3,177,242 (*See Class 6 for this trademark*).
- 3,177,243 (*See Class 3 for this trademark*).
- 3,177,254 (*See Class 8 for this trademark*).
- 3,177,280 (*See Class 1 for this trademark*).
- 3,177,291. **ISOTHERM (STYLIZED)**. THERMOPRODUKTER AB, (U.S. CLS. 13, 21, 23, 31 AND 34). SN 79-016,613. PUB. 9-12-2006. FILED 6-27-2005.
- 3,177,295 (*See Class 5 for this trademark*).

CLASS 12—VEHICLES

- 3,175,757. **MISCELLANEOUS DESIGN**. SHELBY, CARROLL, (U.S. CLS. 19, 21, 23, 31, 35 AND 44). SN 75-586,777. PUB. 11-13-2001. FILED 11-12-1998.
- 3,175,772. **POWER IN SAFE HANDS AND DESIGN**. PIRELLI PNEUMATICI S.P.A., MULTIPLE CLASS, (INT. CLS. 12 AND 35), (U.S. CLS. 19, 21, 23, 31, 35, 44, 100, 101 AND 102). SN 76-418,972. PUB. 9-12-2006. FILED 6-7-2002.
- 3,175,794 (*See Class 7 for this trademark*).
- 3,175,818. **PIGGY BACKER (BLOCK FORM)**. TRAILER CORPORATION OF AMERICA, INC., (U.S. CLS. 19, 21, 23, 31, 35 AND 44). SN 76-613,584. PUB. 9-12-2006. FILED 9-30-2004.
- 3,175,823 (*See Class 7 for this trademark*).
- 3,175,940 (*See Class 7 for this trademark*).
- 3,176,069. **S SPIGALY AND DESIGN**. MALDONADO, JOSE A, (U.S. CLS. 19, 21, 23, 31, 35 AND 44). SN 78-521,707. PUB. 9-12-2006. FILED 11-23-2004.
- 3,176,159. **SERIES 1500 (BLOCK FORM)**. MTD PRODUCTS INC, (U.S. CLS. 19, 21, 23, 31, 35 AND 44). SN 78-597,165. PUB. 9-12-2006. FILED 3-29-2005.
- 3,176,160. **SERIES 2500 (BLOCK FORM)**. MTD PRODUCTS INC, (U.S. CLS. 19, 21, 23, 31, 35 AND 44). SN 78-597,204. PUB. 9-12-2006. FILED 3-29-2005.
- 3,176,210 (*See Class 6 for this trademark*).
- 3,176,273. **NXT (BLOCK FORM)**. NEMESIS AIR RACING, (U.S. CLS. 19, 21, 23, 31, 35 AND 44). SN 78-631,570. PUB. 9-12-2006. FILED 5-17-2005.
- 3,176,401. **POLYTRAXX (BLOCK FORM)**. MANTC HOLDINGS PTY LTD, (U.S. CLS. 19, 21, 23, 31, 35 AND 44). SN 78-663,797. PUB. 9-12-2006. FILED 7-5-2005.
- 3,176,418 (*See Class 6 for this trademark*).
- 3,176,455. **VOLATUS (BLOCK FORM)**. ITOCHU CORPORATION, (U.S. CLS. 19, 21, 23, 31, 35 AND 44). SN 78-691,778. PUB. 9-12-2006. FILED 8-12-2005.
- 3,176,456. **EXCELON (BLOCK FORM)**. ITOCHU CORPORATION, (U.S. CLS. 19, 21, 23, 31, 35 AND 44). SN 78-691,809. PUB. 9-12-2006. FILED 8-12-2005.
- 3,176,465. **R.2 SPORT WHEELS AND DESIGN**. AYNEHCHI, SHAHRAM, (U.S. CLS. 19, 21, 23, 31, 35 AND 44). SN 78-694,969. PUB. 9-12-2006. FILED 8-17-2005.
- 3,176,493. **E EXOMOS AND DESIGN**. EXOMOS FZCO, (U.S. CLS. 19, 21, 23, 31, 35 AND 44). SN 78-708,051. PUB. 9-12-2006. FILED 9-7-2005.
- 3,176,707. **LOGOTAILS (BLOCK FORM)**. GNJ VENTURES, LLP, (U.S. CLS. 19, 21, 23, 31, 35 AND 44). SN 78-769,754. PUB. 9-12-2006. FILED 12-8-2005.
- 3,176,922. **FIROVAC (BLOCK FORM)**. REBERLAND EQUIPMENT, INC., (U.S. CLS. 19, 21, 23, 31, 35 AND 44). SN 78-787,641. PUB. 9-12-2006. FILED 1-9-2006.
- 3,176,932. **CEDAR COVE (BLOCK FORM)**. SKYLINE COR-

- PORATION, (U.S. CLS. 19, 21, 23, 31, 35 AND 44). SN 78-788,420. PUB. 9-12-2006. FILED 1-10-2006.
- 3,176,933. **LAKEVIEW (BLOCK FORM)**. SKYLINE CORPORATION, (U.S. CLS. 19, 21, 23, 31, 35 AND 44). SN 78-788,423. PUB. 9-12-2006. FILED 1-10-2006.
- 3,176,934. **MOUNTAIN VIEW (BLOCK FORM)**. SKYLINE CORPORATION, (U.S. CLS. 19, 21, 23, 31, 35 AND 44). SN 78-788,428. PUB. 9-12-2006. FILED 1-10-2006.
- 3,176,942. **S AND DESIGN**. LIAONING SG INDUSTRY GROUP CO., LTD., (U.S. CLS. 19, 21, 23, 31, 35 AND 44). SN 78-788,971. PUB. 9-12-2006. FILED 1-10-2006.
- 3,177,101. **BEYERN (BLOCK FORM)**. JUST WHEELS & TIRES CO., (U.S. CLS. 19, 21, 23, 31, 35 AND 44). SN 78-796,194. PUB. 9-12-2006. FILED 1-20-2006.
- 3,177,147. **MANDRUS (BLOCK FORM)**. JUST WHEELS & TIRES CO., (U.S. CLS. 19, 21, 23, 31, 35 AND 44). SN 78-808,004. PUB. 9-12-2006. FILED 2-6-2006.
- 3,177,153. **FST (BLOCK FORM)**. POLARIS INDUSTRIES INC., (U.S. CLS. 19, 21, 23, 31, 35 AND 44). SN 78-815,129. PUB. 9-12-2006. FILED 2-15-2006.
- 3,177,165. **RMK (BLOCK FORM)**. POLARIS INDUSTRIES INC., (U.S. CLS. 19, 21, 23, 31, 35 AND 44). SN 78-828,202. PUB. 9-12-2006. FILED 3-3-2006.
- 3,177,236. **SHENGQIBAO AND DESIGN**. WUYI SHENGQI MOTION APPARATUS CO., LTD., (U.S. CLS. 19, 21, 23, 31, 35 AND 44). SN 79-013,025. PUB. 9-12-2006. FILED 2-21-2005.
- 3,177,280 (*See Class 1 for this trademark*).
- 3,177,310. **G 650 (BLOCK FORM)**. BAYERISCHE MOTORENWERKE AKTIENGESELLSCHAFT, (U.S. CLS. 19, 21, 23, 31, 35 AND 44). SN 79-019,363. PUB. 9-12-2006. FILED 10-28-2005.
- 3,177,315. **ALFINE (STYLIZED)**. SHIMANO INC., (U.S. CLS. 19, 21, 23, 31, 35 AND 44). SN 79-020,331. PUB. 9-12-2006. FILED 11-1-2005.

CLASS 13—FIREARMS

- 3,176,548. **LEGENDS OF THE WEST (BLOCK FORM)**. GERONIMO PRODUCTIONS, INC., (U.S. CLS. 2 AND 9). SN 78-724,034. PUB. 9-12-2006. FILED 9-30-2005.
- 3,176,929. **OMNI-POTENT SIX-SHOOTER (BLOCK FORM)**. U.S. FIRE ARMS MANUFACTURING CO. INC., (U.S. CLS. 2 AND 9). SN 78-788,212. PUB. 9-12-2006. FILED 1-10-2006.
- 3,177,181. **DYNA-STAR (BLOCK FORM)**. HALLIBURTON ENERGY SERVICES, INC., (U.S. CLS. 2 AND 9). SN 78-841,485. PUB. 9-12-2006. FILED 3-20-2006.

CLASS 14—JEWELRY

- 3,175,762 (*See Class 3 for this trademark*).
- 3,175,865. **KARMA CHARMS BY BARBARA BURZILLO (STYLIZED)**. BURZILLO, BARBARA, (U.S. CLS. 2, 27, 28 AND 50). SN 76-643,643. PUB. 9-12-2006. FILED 7-26-2005.
- 3,175,869 (*See Class 8 for this trademark*).
- 3,175,964 (*See Class 3 for this trademark*).
- 3,176,040. **MISCELLANEOUS DESIGN**. CAROLE ACCESSORIES, (U.S. CLS. 2, 27, 28 AND 50). SN 78-491,465. PUB. 9-12-2006. FILED 9-29-2004.
- 3,176,092. **YOU CAN HOPE OR YOU CAN HELP (BLOCK FORM)**. HIRSHBERG FOUNDATION FOR PANCREATIC CANCER RESEARCH, MULTIPLE CLASS, (INT. CLS. 14 AND 36), (U.S. CLS. 2, 27, 28, 50, 100, 101 AND 102). SN 78-539,190. PUB. 9-12-2006. FILED 12-28-2004.
- 3,176,666. **CHI PHI 1824 AND DESIGN**. THE CHI PHI FRATERNITY, INC., MULTIPLE CLASS, (INT. CLS. 14 AND 25), (U.S. CLS. 2, 22, 27, 28, 39 AND 50). SN 78-758,002. PUB. 9-12-2006. FILED 11-21-2005.
- 3,176,771 (*See Class 3 for this trademark*).
- 3,176,900. **ANTHOLOGY AND DESIGN**. ALUMA USA INC., (U.S. CLS. 2, 27, 28 AND 50). SN 78-786,307. PUB. 9-12-2006. FILED 1-6-2006.
- 3,177,228. **DELOVE (STYLIZED)**. JEAN-JACQUES FRADKOFF, MULTIPLE CLASS, (INT. CLS. 14 AND 37), (U.S. CLS.

- 2, 27, 28, 50, 100, 103 AND 106). SN 79-012,336. PUB. 9-12-2006. FILED 4-21-2005.
- 3,177,232. **FLEURS DE MALTE VACHERON & CONSTANTIN (BLOCK FORM)**. RICHEMONT INTERNATIONAL SA, (U.S. CLS. 2, 27, 28 AND 50). SN 79-012,844. PUB. 9-12-2006. FILED 6-23-2005.
- 3,177,296. **WW AND DESIGN**. BACKHAUSEN INTERIOR TEXTILES GMBH, MULTIPLE CLASS, (INT. CLS. 14, 16, 18, 21, 24, 25 AND 27), (U.S. CLS. 1, 2, 3, 5, 13, 19, 20, 22, 23, 27, 28, 29, 30, 33, 37, 38, 39, 40, 41, 42 AND 50). SN 79-017,518. PUB. 9-12-2006. FILED 2-18-2005.

CLASS 15—MUSICAL INSTRUMENTS

- 3,175,759 (*See Class 9 for this trademark*).
- 3,175,839. **MASTERBILT (BLOCK FORM)**. GIBSON GUITAR CORP., (U.S. CLS. 2, 21 AND 36). SN 76-636,841. PUB. 9-12-2006. FILED 4-22-2005.
- 3,176,207. **ALLIANCE VIVACE (BLOCK FORM)**. SAVAREZ, (U.S. CLS. 2, 21 AND 36). SN 78-616,248. PUB. 9-12-2006. FILED 4-25-2005.
- 3,176,561. **MISCELLANEOUS DESIGN**. BURNS LONDON LTD., (U.S. CLS. 2, 21 AND 36). SN 78-728,752. PUB. 9-12-2006. FILED 10-7-2005.

CLASS 16—PAPER GOODS AND PRINTED MATTER

- 3,175,762 (*See Class 3 for this trademark*).
- 3,175,763. **CITYVIEW**. CITYVIEW PUBLISHING, INC., (U.S. CLS. 2, 5, 22, 23, 29, 37, 38 AND 50). SN 76-207,047. PUB. 9-12-2006. FILED 2-8-2001.
- 3,175,770. **O'SCRAP! (BLOCK FORM)**. IMAGINATIONS!, INC., (U.S. CLS. 2, 5, 22, 23, 29, 37, 38 AND 50). SN 76-415,716. PUB. 9-12-2006. FILED 5-29-2002.
- 3,175,783. **CAISSE DE RETRAITE FAM AND DESIGN**. THE TRUSTEES OF THE AMERICAN FEDERATION OF MUSICIANS' AND EMPLOYERS' PENSION WELFARE FUND, MULTIPLE CLASS, (INT. CLS. 16, 24, 25, 28 AND 36), (U.S. CLS. 2, 5, 22, 23, 29, 37, 38, 39, 42, 50, 100, 101 AND 102). SN 76-531,848. PUB. 9-12-2006. FILED 7-24-2003.
- 3,175,784. **AFM-EPW FUND AND DESIGN**. THE TRUSTEES OF THE AMERICAN FEDERATION OF MUSICIANS' AND EMPLOYERS' PENSION WELFARE FUND, MULTIPLE CLASS, (INT. CLS. 16, 24, 25, 28 AND 36), (U.S. CLS. 2, 5, 22, 23, 29, 37, 38, 39, 42, 50, 100, 101 AND 102). SN 76-531,849. PUB. 9-12-2006. FILED 7-24-2003.
- 3,175,789. **H AND DESIGN**. VERBAND HANNOVERSCHER WARMBLUTZUCHTER E.V., MULTIPLE CLASS, (INT. CLS. 16, 35, 41, 42 AND 44), (U.S. CLS. 2, 5, 22, 23, 29, 37, 38, 50, 100, 101, 102 AND 107). SN 76-547,848. PUB. 9-12-2006. FILED 9-29-2003.
- 3,175,796. **360 RING AND DESIGN**. AVERY DENNISON CORPORATION, (U.S. CLS. 2, 5, 22, 23, 29, 37, 38 AND 50). SN 76-565,691. PUB. 9-12-2006. FILED 12-8-2003.
- 3,175,810. **ECOTRENDS (BLOCK FORM)**. INSTITUTE FOR TREND RESEARCH, INC., MULTIPLE CLASS, (INT. CLS. 16 AND 41), (U.S. CLS. 2, 5, 22, 23, 29, 37, 38, 50, 100, 101 AND 107). SN 76-598,155. PUB. 9-12-2006. FILED 6-18-2004.
- 3,175,824 (*See Class 9 for this trademark*).
- 3,175,825 (*See Class 9 for this trademark*).
- 3,175,856 (*See Class 9 for this trademark*).
- 3,175,869 (*See Class 8 for this trademark*).
- 3,175,876. **MODELLO (BLOCK FORM)**. MODELLO DESIGN GROUP, LLC, MULTIPLE CLASS, (INT. CLS. 16 AND 40), (U.S. CLS. 2, 5, 22, 23, 29, 37, 38, 50, 100, 103 AND 106). SN 76-647,096. PUB. 9-12-2006. FILED 9-19-2005.
- 3,175,886. **THE MODESTO BEE (BLOCK FORM)**. MCCLATCHY MANAGEMENT SERVICES, INC., (U.S. CLS. 2, 5, 22, 23, 29, 37, 38 AND 50). SN 76-648,669. PUB. 9-12-2006. FILED 10-17-2005.
- 3,175,889. **QUÉ MÁS (BLOCK FORM)**. EMERALD WAVE MEDIA, (U.S. CLS. 2, 5, 22, 23, 29, 37, 38 AND 50). SN 76-

- 649,107. PUB. 9-12-2006. FILED 10-21-2005.
- 3,175,907. **L LEVIATHAN COMICS AND DESIGN. BANKS, JAMES MATTHEW, JR.**, (U.S. CLS. 2, 5, 22, 23, 29, 37, 38 AND 50). SN 76-652,515. PUB. 9-12-2006. FILED 12-21-2005.
- 3,175,915. **TIDYBAG (BLOCK FORM). SMITH, KEVIN L.**, (U.S. CLS. 2, 5, 22, 23, 29, 37, 38 AND 50). SN 76-652,838. PUB. 9-12-2006. FILED 1-4-2006.
- 3,175,946. **DISCREET-CARE AND DESIGN. INNOVATIVE HYGIENE PRODUCTS, INC.**, MULTIPLE CLASS, (INT. CLS. 16 AND 21), (U.S. CLS. 2, 5, 13, 22, 23, 29, 30, 33, 37, 38, 40 AND 50). SN 78-211,550. PUB. 5-25-2004. FILED 2-6-2003.
- 3,175,953. **ANYTHING FOR KIDS. DODGE, KAREN**, (U.S. CLS. 2, 5, 22, 23, 29, 37, 38 AND 50). SN 78-263,171. PUB. 9-12-2006. FILED 6-17-2003.
- 3,175,962 (*See Class 8 for this trademark*).
- 3,175,964 (*See Class 3 for this trademark*).
- 3,176,007. **EQUESTRIAN RETAILER (BLOCK FORM). MCC MAGAZINES, LLC**, (U.S. CLS. 2, 5, 22, 23, 29, 37, 38 AND 50). SN 78-446,498. PUB. 9-12-2006. FILED 7-6-2004.
- 3,176,030. **ROWF AND DESIGN. ROWF, LLC**, (U.S. CLS. 2, 5, 22, 23, 29, 37, 38 AND 50). SN 78-479,139. PUB. 9-12-2006. FILED 9-6-2004.
- 3,176,071 (*See Class 9 for this trademark*).
- 3,176,097. **CHRISMUKKAH AND DESIGN. CHRISMUKKAH.-COM**, (U.S. CLS. 2, 5, 22, 23, 29, 37, 38 AND 50). SN 78-546,659. PUB. 9-12-2006. FILED 1-12-2005.
- 3,176,112. **AMERIFACTS! (BLOCK FORM). AMERIFACTORS FINANCIAL GROUP, INC.**, (U.S. CLS. 2, 5, 22, 23, 29, 37, 38 AND 50). SN 78-558,996. PUB. 9-12-2006. FILED 2-2-2005.
- 3,176,114. **CODE BLUE PRODUCTIONS (BLOCK FORM). CODE BLUE PRODUCTIONS LLC**, (U.S. CLS. 2, 5, 22, 23, 29, 37, 38 AND 50). SN 78-560,313. PUB. 9-12-2006. FILED 2-3-2005.
- 3,176,143 (*See Class 9 for this trademark*).
- 3,176,144. **NORTHLIGHT ATELIER (BLOCK FORM). NORTHLIGHT ATELIER, LLC**, MULTIPLE CLASS, (INT. CLS. 16 AND 41), (U.S. CLS. 2, 5, 22, 23, 29, 37, 38, 50, 100, 101 AND 107). SN 78-585,823. PUB. 9-12-2006. FILED 3-11-2005.
- 3,176,198. **CORNBREAD (BLOCK FORM). TAYLOR, VINCENT C.**, (U.S. CLS. 2, 5, 22, 23, 29, 37, 38 AND 50). SN 78-610,509. PUB. 9-12-2006. FILED 4-17-2005.
- 3,176,203. **MONEYMINDING (BLOCK FORM). PIERCY, TRACY**, (U.S. CLS. 2, 5, 22, 23, 29, 37, 38 AND 50). SN 78-611,852. PUB. 9-12-2006. FILED 4-19-2005.
- 3,176,212. **YOUTHERAN (BLOCK FORM). STAFFORD, MICHELLE**, (U.S. CLS. 2, 5, 22, 23, 29, 37, 38 AND 50). SN 78-618,494. PUB. 9-12-2006. FILED 4-27-2005.
- 3,176,221. **THE ESSENTIAL INGREDIENT (BLOCK FORM). MW CUSTOM PAPERS, LLC**, (U.S. CLS. 2, 5, 22, 23, 29, 37, 38 AND 50). SN 78-621,628. PUB. 9-12-2006. FILED 5-3-2005.
- 3,176,235. **POSTASCORECARD.COM (BLOCK FORM). BRADLEY, AIDAN**, (U.S. CLS. 2, 5, 22, 23, 29, 37, 38 AND 50). SN 78-625,510. PUB. 9-12-2006. FILED 5-9-2005.
- 3,176,245. **PROFITBUILDER (BLOCK FORM). DURVET, INC.**, (U.S. CLS. 2, 5, 22, 23, 29, 37, 38 AND 50). SN 78-627,500. PUB. 9-12-2006. FILED 5-11-2005.
- 3,176,246. **DAILY WALK (BLOCK FORM). WALK THRU THE BIBLE MINISTRIES, INC.**, (U.S. CLS. 2, 5, 22, 23, 29, 37, 38 AND 50). SN 78-627,623. PUB. 9-12-2006. FILED 5-11-2005.
- 3,176,294. **POPULAR MECHANICS EN ESPAÑOL (BLOCK FORM). HEARST COMMUNICATIONS, INC.**, (U.S. CLS. 2, 5, 22, 23, 29, 37, 38 AND 50). SN 78-636,064. PUB. 9-12-2006. FILED 5-24-2005.
- 3,176,315. **JOURNAL OF CLINICAL OUTCOMES MANAGEMENT (BLOCK FORM). TURNER WHITE COMMUNICATIONS, INC.**, (U.S. CLS. 2, 5, 22, 23, 29, 37, 38 AND 50). SN 78-640,180. PUB. 9-12-2006. FILED 5-31-2005.
- 3,176,346. **COOL QUBE TISSUE AND DESIGN. TRINOVA DESIGN LLC**, (U.S. CLS. 2, 5, 22, 23, 29, 37, 38 AND 50). SN 78-648,653. PUB. 9-12-2006. FILED 6-10-2005.
- 3,176,355. **CONEXION SALVADORENA (BLOCK FORM). DIGITGLOBAL COMMUNICATIONS, INC.**, (U.S. CLS. 2, 5, 22, 23, 29, 37, 38 AND 50). SN 78-652,220. PUB. 9-12-2006. FILED 6-16-2005.
- 3,176,366. **HUHTAMAKI AND DESIGN. HUHTAMAKI FINANCE B.V.**, MULTIPLE CLASS, (INT. CLS. 16, 20 AND 21), (U.S. CLS. 2, 5, 13, 22, 23, 25, 29, 30, 32, 33, 37, 38, 40 AND 50). SN 78-654,420. PUB. 9-12-2006. FILED 6-20-2005.
- 3,176,379. **STUDENT LOAN XPRESS (BLOCK FORM). STUDENT LOAN XPRESS, INC.**, MULTIPLE CLASS, (INT. CLS. 16, 35 AND 36), (U.S. CLS. 2, 5, 22, 23, 29, 37, 38, 50, 100, 101 AND 102). SN 78-657,261. PUB. 9-12-2006. FILED 6-23-2005.
- 3,176,383. **SAVORY FLAVOR 201 (BLOCK FORM). FONA INTERNATIONAL INC.**, MULTIPLE CLASS, (INT. CLS. 16 AND 41), (U.S. CLS. 2, 5, 22, 23, 29, 37, 38, 50, 100, 101 AND 107). SN 78-658,216. PUB. 9-12-2006. FILED 6-24-2005.
- 3,176,384. **CHANTELLE PUBLISHING CO. AND DESIGN. UNIVERSITY PRODUCTS, INC.**, (U.S. CLS. 2, 5, 22, 23, 29, 37, 38 AND 50). SN 78-658,728. PUB. 9-12-2006. FILED 6-27-2005.
- 3,176,387 (*See Class 7 for this trademark*).
- 3,176,394. **CAR SOUND & PERFORMANCE (BLOCK FORM). CMP ENTERTAINMENT MEDIA, INC.**, (U.S. CLS. 2, 5, 22, 23, 29, 37, 38 AND 50). SN 78-660,290. PUB. 9-12-2006. FILED 6-28-2005.
- 3,176,395. **GLCC (BLOCK FORM). GREAT LAKES CRUISING CLUB**, (U.S. CLS. 2, 5, 22, 23, 29, 37, 38 AND 50). SN 78-660,337. PUB. 9-12-2006. FILED 6-28-2005.
- 3,176,412. **T-SYSTEMS BUSINESS (BLOCK FORM). DEUTSCHE TELEKOM AG**, (U.S. CLS. 2, 5, 22, 23, 29, 37, 38 AND 50). SN 78-667,420. PUB. 5-23-2006. FILED 7-11-2005.
- 3,176,434 (*See Class 9 for this trademark*).
- 3,176,453. **TOP STICKY WALL (BLOCK FORM). THE INSTITUTE OF CULTURAL AFFAIRS**, (U.S. CLS. 2, 5, 22, 23, 29, 37, 38 AND 50). SN 78-690,890. PUB. 9-12-2006. FILED 8-11-2005.
- 3,176,491 (*See Class 9 for this trademark*).
- 3,176,504. **LEADERSHIP HERWAY (STYLIZED). MICHELLE L. COLLINS, INC.**, MULTIPLE CLASS, (INT. CLS. 16 AND 35), (U.S. CLS. 2, 5, 22, 23, 29, 37, 38, 50, 100, 101 AND 102). SN 78-712,181. PUB. 9-12-2006. FILED 9-13-2005.
- 3,176,508 (*See Class 9 for this trademark*).
- 3,176,516. **HELLO GARCIE! (BLOCK FORM). QARMOUT, ELIAS**, (U.S. CLS. 2, 5, 22, 23, 29, 37, 38 AND 50). SN 78-715,011. PUB. 9-12-2006. FILED 9-16-2005.
- 3,176,535. **ARTSAKE (BLOCK FORM). GRAY, M**, (U.S. CLS. 2, 5, 22, 23, 29, 37, 38 AND 50). SN 78-721,381. PUB. 9-12-2006. FILED 9-27-2005.
- 3,176,604. **KIND EXPRESSIONS (BLOCK FORM). HARMONY BALL COMPANY**, MULTIPLE CLASS, (INT. CLS. 16 AND 20), (U.S. CLS. 2, 5, 13, 22, 23, 25, 29, 32, 37, 38 AND 50). SN 78-746,564. PUB. 9-12-2006. FILED 11-3-2005.
- 3,176,627. **FLEX AND DESIGN. PROCTER & GAMBLE COMPANY, THE**, (U.S. CLS. 2, 5, 22, 23, 29, 37, 38 AND 50). SN 78-749,315. PUB. 9-12-2006. FILED 11-8-2005.
- 3,176,630. **NATCO (BLOCK FORM). NORTH AMERICAN TEXTILE CO., LLC**, MULTIPLE CLASS, (INT. CLS. 16, 24 AND 26), (U.S. CLS. 2, 5, 22, 23, 29, 37, 38, 39, 40, 42 AND 50). SN 78-749,930. PUB. 9-12-2006. FILED 11-8-2005.
- 3,176,631. **GLOBAL TRIM MANAGEMENT (BLOCK FORM). NORTH AMERICAN TEXTILE CO., LLC**, MULTIPLE CLASS, (INT. CLS. 16, 24 AND 26), (U.S. CLS. 2, 5, 22, 23, 29, 37, 38, 39, 40, 42 AND 50). SN 78-749,936. PUB. 9-12-2006. FILED 11-8-2005.
- 3,176,638. **POST-IT AND DESIGN. 3M COMPANY**, (U.S. CLS. 2, 5, 22, 23, 29, 37, 38 AND 50). SN 78-751,988. PUB. 9-12-2006. FILED 11-11-2005.
- 3,176,710. **VEXED COMICS (BLOCK FORM). DIXON, CHARLES**, (U.S. CLS. 2, 5, 22, 23, 29, 37, 38 AND 50). SN 78-771,859. PUB. 9-12-2006. FILED 12-13-2005.
- 3,176,721. **TODAY'S LIVING (BLOCK FORM). THE PERSONAL MARKETING COMPANY, INC.**, (U.S. CLS. 2, 5, 22, 23, 29, 37, 38 AND 50). SN 78-773,457. PUB. 9-12-2006. FILED 12-14-2005.
- 3,176,737. **SPARK (BLOCK FORM). SPIRITED ACTION RELEASE AND KINDNESS, INC.**, MULTIPLE CLASS, (INT. CLS. 16, 41 AND 44), (U.S. CLS. 2, 5, 22, 23, 29, 37, 38, 50, 100, 101 AND 107). SN 78-774,774. PUB. 9-12-2006. FILED 12-16-2005.
- 3,176,778. **CLEMATIS BY NIGHT (BLOCK FORM). CITY OF WEST PALM BEACH**, MULTIPLE CLASS, (INT. CLS. 16, 24, 25 AND 41), (U.S. CLS. 2, 5, 22, 23, 29, 37, 38, 39, 42, 50, 100, 101 AND 107). SN 78-778,941. PUB. 9-12-2006. FILED 12-22-2005.
- 3,176,834. **ABA TOOLBOX (BLOCK FORM). AMERICAN**

BANKERS ASSOCIATION, (U.S. CLS. 2, 5, 22, 23, 29, 37, 38 AND 50). SN 78-782,497. PUB. 9-12-2006. FILED 12-29-2005.

3,176,852. **CHALK - ALONG (BLOCK FORM)**. ROSENTHAL, LEAH, (U.S. CLS. 2, 5, 22, 23, 29, 37, 38 AND 50). SN 78-783,589. PUB. 9-12-2006. FILED 1-2-2006.

3,176,865. **US WEEKLY AND DESIGN**. US WEEKLY LLC, (U.S. CLS. 2, 5, 22, 23, 29, 37, 38 AND 50). SN 78-784,600. PUB. 9-12-2006. FILED 1-4-2006.

3,176,869. **JACE THE REAL ESTATE COMPANY (BLOCK FORM)**. SCHMITZ, JOHN C., MULTIPLE CLASS, (INT. CLS. 16 AND 41), (U.S. CLS. 2, 5, 22, 23, 29, 37, 38, 50, 100, 101 AND 107). SN 78-784,850. PUB. 9-12-2006. FILED 1-4-2006.

3,176,890. **CONEXION AMIGA (STYLIZED)**. SANDAL ENTERPRISES, INC., (U.S. CLS. 2, 5, 22, 23, 29, 37, 38 AND 50). SN 78-785,921. PUB. 9-12-2006. FILED 1-5-2006.

3,176,894. **LOLA PRESS (BLOCK FORM)**. COLOMBY, DONNA, (U.S. CLS. 2, 5, 22, 23, 29, 37, 38 AND 50). SN 78-786,108. PUB. 9-12-2006. FILED 1-6-2006.

3,176,897. **TISSUEBOX DONATIONS (BLOCK FORM)**. ITOCHU INTERNATIONAL INC., (U.S. CLS. 2, 5, 22, 23, 29, 37, 38 AND 50). SN 78-786,242. PUB. 9-12-2006. FILED 1-6-2006.

3,176,904. **B&C (BLOCK FORM)**. REED PUBLISHING (NETHERLAND) BV, (U.S. CLS. 2, 5, 22, 23, 29, 37, 38 AND 50). SN 78-786,605. PUB. 9-12-2006. FILED 1-6-2006.

3,176,917. **PRAYER E. DOG (BLOCK FORM)**. JOHNSON, KAREN LEIGH, (U.S. CLS. 2, 5, 22, 23, 29, 37, 38 AND 50). SN 78-787,398. PUB. 9-12-2006. FILED 1-9-2006.

3,176,921. **YOUR PERSONAL WINE SERVICE (BLOCK FORM)**. GEERLINGS & WADE, INC., MULTIPLE CLASS, (INT. CLS. 16 AND 35), (U.S. CLS. 2, 5, 22, 23, 29, 37, 38, 50, 100, 101 AND 102). SN 78-787,634. PUB. 9-12-2006. FILED 1-9-2006.

3,176,966. **BOOK-OF-THE-MONTH NEWS (BLOCK FORM)**. BOOK-OF-THE-MONTH-CLUB, INC., (U.S. CLS. 2, 5, 22, 23, 29, 37, 38 AND 50). SN 78-791,060. PUB. 9-12-2006. FILED 1-13-2006.

3,177,007. **ASANA ALPHABET AND DESIGN**. ROBIDEAUX, ANN CATHERINE, MULTIPLE CLASS, (INT. CLS. 16, 25 AND 41), (U.S. CLS. 2, 5, 22, 23, 29, 37, 38, 39, 50, 100, 101 AND 107). SN 78-792,964. PUB. 9-12-2006. FILED 1-17-2006.

3,177,018. **SHE SHINES AND DESIGN**. YWCA NORTHERN RHODE ISLAND, (U.S. CLS. 2, 5, 22, 23, 29, 37, 38 AND 50). SN 78-793,406. PUB. 9-12-2006. FILED 1-17-2006.

3,177,056. **CRITTER ANGELS (BLOCK FORM)**. LIKEMINDS PRESS, INC., MULTIPLE CLASS, (INT. CLS. 16 AND 25), (U.S. CLS. 2, 5, 22, 23, 29, 37, 38, 39 AND 50). SN 78-794,285. PUB. 9-12-2006. FILED 1-18-2006.

3,177,069. **CUSTARD WALLY (BLOCK FORM)**. GIUNTA, CHRISTOPHER, (U.S. CLS. 2, 5, 22, 23, 29, 37, 38 AND 50). SN 78-794,652. PUB. 9-12-2006. FILED 1-19-2006.

3,177,078. **DREAMS OF NATURE (BLOCK FORM)**. WORTZ, MARJORIE A., (U.S. CLS. 2, 5, 22, 23, 29, 37, 38 AND 50). SN 78-794,846. PUB. 9-12-2006. FILED 1-19-2006.

3,177,090. **NEWSMAX (BLOCK FORM)**. NEWSMAX.COM, (U.S. CLS. 2, 5, 22, 23, 29, 37, 38 AND 50). SN 78-795,478. PUB. 9-12-2006. FILED 1-20-2006.

3,177,136. **FUNDAMENTAL LABOR STRATEGIES (BLOCK FORM)**. FUNDAMENTAL LABOR STRATEGIES, INC., MULTIPLE CLASS, (INT. CLS. 16, 35, 41 AND 42), (U.S. CLS. 2, 5, 22, 23, 29, 37, 38, 50, 100, 101, 102 AND 107). SN 78-800,301. PUB. 9-12-2006. FILED 1-26-2006.

3,177,160. **FOCUS ON THE FAMILY CLUBHOUSE (BLOCK FORM)**. FOCUS ON THE FAMILY, (U.S. CLS. 2, 5, 22, 23, 29, 37, 38 AND 50). SN 78-819,492. PUB. 9-12-2006. FILED 2-21-2006.

3,177,182. **HILLERY KEITH (STYLIZED)**. THE PORTER DUVAL GROUP, LLC, MULTIPLE CLASS, (INT. CLS. 16 AND 41), (U.S. CLS. 2, 5, 22, 23, 29, 37, 38, 50, 100, 101 AND 107). SN 78-841,855. PUB. 9-12-2006. FILED 3-20-2006.

3,177,199 (See Class 9 for this trademark).

3,177,215 (See Class 9 for this trademark).

3,177,218 (See Class 9 for this trademark).

3,177,266 (See Class 9 for this trademark).

3,177,284. **UNITED BUDDY BEARS (BLOCK FORM)**. HERLITZ, KLAUS, DR., MULTIPLE CLASS, (INT. CLS. 16, 25 AND 28), (U.S. CLS. 2, 5, 22, 23, 29, 37, 38, 39 AND 50). SN 79-016,400. PUB. 9-12-2006. FILED 3-25-2005.

3,177,285. **ZOCCAI (BLOCK FORM)**. LEGI INTERNA-

TIONAL S.R.L., MULTIPLE CLASS, (INT. CLS. 16 AND 21), (U.S. CLS. 2, 5, 13, 22, 23, 29, 30, 33, 37, 38, 40 AND 50). SN 79-016,457. PUB. 9-12-2006. FILED 11-18-2004.

3,177,296 (See Class 14 for this trademark).

3,177,299 (See Class 9 for this trademark).

3,177,302. **KING CROWN AND DESIGN**. SHANGHAI G-CROWN FOUNTAIN PEN CO., LTD., (U.S. CLS. 2, 5, 22, 23, 29, 37, 38 AND 50). SN 79-018,120. PUB. 9-12-2006. FILED 9-19-2005.

3,177,319 (See Class 9 for this trademark).

CLASS 17—RUBBER GOODS

3,175,787. **TEMP-SHIELD**. VISCOUNT RESEARCH AND MANUFACTURING LTD., (U.S. CLS. 1, 5, 12, 13, 35 AND 50). SN 76-542,002. PUB. 1-17-2006. FILED 9-3-2003.

3,175,794 (See Class 7 for this trademark).

3,175,940 (See Class 7 for this trademark).

3,175,958 (See Class 6 for this trademark).

3,176,064. **RAMXCEL (BLOCK FORM)**. PELICAN INTERNATIONAL INC., (U.S. CLS. 1, 5, 12, 13, 35 AND 50). SN 78-515,508. PUB. 9-12-2006. FILED 11-11-2004.

3,176,184. **ACTECH PANELS (BLOCK FORM)**. ALTERNATIVE CONSTRUCTION COMPANY, INC., (U.S. CLS. 1, 5, 12, 13, 35 AND 50). SN 78-604,578. PUB. 1-10-2006. FILED 4-8-2005.

3,176,286. **SURFZONE 850 (BLOCK FORM)**. KIDDE FIRE FIGHTING, INC., (U.S. CLS. 1, 5, 12, 13, 35 AND 50). SN 78-634,110. PUB. 9-12-2006. FILED 5-20-2005.

3,176,555. **EXECUTIVE (BLOCK FORM)**. JOHNSON WINDOW FILMS, INC., (U.S. CLS. 1, 5, 12, 13, 35 AND 50). SN 78-726,422. PUB. 9-12-2006. FILED 10-4-2005.

3,176,645. **DENSIFILM (BLOCK FORM)**. INNOVATIVE POLYMER SOLUTIONS, INC., (U.S. CLS. 1, 5, 12, 13, 35 AND 50). SN 78-753,079. PUB. 9-12-2006. FILED 11-14-2005.

3,176,708. **COASTRIP (BLOCK FORM)**. RUNNER-LESS KNITS, INC., (U.S. CLS. 1, 5, 12, 13, 35 AND 50). SN 78-769,852. PUB. 9-12-2006. FILED 12-8-2005.

3,177,133. **GEL-COR (BLOCK FORM)**. DEPARTMENT OF THE ARMY, (U.S. CLS. 1, 5, 12, 13, 35 AND 50). SN 78-799,303. PUB. 9-12-2006. FILED 1-25-2006.

3,177,146. **CIRCEXTENDER (BLOCK FORM)**. DEMCO, INC., (U.S. CLS. 1, 5, 12, 13, 35 AND 50). SN 78-807,727. PUB. 9-12-2006. FILED 2-6-2006.

3,177,199 (See Class 9 for this trademark).

3,177,255 (See Class 7 for this trademark).

3,177,305 (See Class 1 for this trademark).

CLASS 18—LEATHER GOODS

3,175,794 (See Class 7 for this trademark).

3,175,807. **LION BRAND YARN (BLOCK FORM)**. ORCHARD YARN AND THREAD COMPANY, INC., DBA LION BRAND YARN COMPANY, MULTIPLE CLASS, (INT. CLS. 18 AND 26), (U.S. CLS. 1, 2, 3, 22, 37, 39, 40, 41, 42 AND 50). SN 76-592,354. PUB. 9-12-2006. FILED 5-17-2004.

3,175,868. **MISCELLANEOUS DESIGN**. ALLEGRO MFG. INC., (U.S. CLS. 1, 2, 3, 22 AND 41). SN 76-644,808. PUB. 9-12-2006. FILED 8-11-2005.

3,175,869 (See Class 8 for this trademark).

3,175,879. **US ANGELS AND DESIGN**. DBD, INC., MULTIPLE CLASS, (INT. CLS. 18, 25, 26 AND 35), (U.S. CLS. 1, 2, 3, 22, 37, 39, 40, 41, 42, 50, 100, 101 AND 102). SN 76-647,555. PUB. 9-12-2006. FILED 9-28-2005.

3,175,883. **OFF THE WALL BRELLA (BLOCK FORM)**. JOHN A. RUSHING & ASSOCIATES INC., (U.S. CLS. 1, 2, 3, 22 AND 41). SN 76-648,499. PUB. 9-12-2006. FILED 10-14-2005.

3,175,957. **TINU SHOEBAG**. ELIBI INC., MULTIPLE CLASS, (INT. CLS. 18 AND 35), (U.S. CLS. 1, 2, 3, 22, 41, 100, 101 AND 102). SN 78-297,051. PUB. 9-12-2006. FILED 10-12-2003.

3,175,964 (See Class 3 for this trademark).

3,176,520. **MISCELLANEOUS DESIGN**. ANTLER LIMITED, (U.S. CLS. 1, 2, 3, 22 AND 41). SN 78-716,195. PUB. 9-12-2006.

- FILED 9-20-2005.
 3,176,599 (*See Class 8 for this trademark*).
 3,176,621. **HIGH END. HIGH MAINTENANCE. (BLOCK FORM)**. SURLY GIRL STUDIOS INC., (U.S. CLS. 1, 2, 3, 22 AND 41). SN 78-748,853. PUB. 9-12-2006. FILED 11-7-2005.
 3,176,650. **UNDER DAWG APPAREL UNDDA.COM AND DESIGN**. UNDER DAWG APPAREL, INC., (U.S. CLS. 1, 2, 3, 22 AND 41). SN 78-755,296. PUB. 9-12-2006. FILED 11-16-2005.
 3,176,678. **MANNACASE AND DESIGN**. NEW VISION, (U.S. CLS. 1, 2, 3, 22 AND 41). SN 78-763,070. PUB. 9-12-2006. FILED 11-29-2005.
 3,176,860. **FIREFISH DESIGNS (STYLIZED)**. FIREFISH DESIGNS, LTD. (U.S. CLS. 1, 2, 3, 22 AND 41). SN 78-784,418. PUB. 9-12-2006. FILED 1-3-2006.
 3,176,861. **DIAPER BAG SURVIVAL KIT (BLOCK FORM)**. BABYDISH, INC., (U.S. CLS. 1, 2, 3, 22 AND 41). SN 78-784,476. PUB. 9-12-2006. FILED 1-4-2006.
 3,176,862. **BABYBEREADY (BLOCK FORM)**. BABYDISH, INC., (U.S. CLS. 1, 2, 3, 22 AND 41). SN 78-784,479. PUB. 9-12-2006. FILED 1-4-2006.
 3,177,195. **JSXTREME (BLOCK FORM)**. JET SET AG, MULTIPLE CLASS, (INT. CLS. 18, 25 AND 28), (U.S. CLS. 1, 2, 3, 22, 23, 38, 39, 41 AND 50). SN 79-006,303. PUB. 9-12-2006. FILED 10-12-2004.
 3,177,223. **NOVITA (BLOCK FORM)**. SCORETT FOOT WEAR AKTIEBOLAG, MULTIPLE CLASS, (INT. CLS. 18 AND 25), (U.S. CLS. 1, 2, 3, 22, 39 AND 41). SN 79-011,858. PUB. 9-12-2006. FILED 3-15-2005.
 3,177,263. **LESCON AND DESIGN**. ERBAY MAGAZACILIK VE TICARET ANONIM SIRKETI, MULTIPLE CLASS, (INT. CLS. 18 AND 25), (U.S. CLS. 1, 2, 3, 22, 39 AND 41). SN 79-014,423. PUB. 9-12-2006. FILED 6-10-2005.
 3,177,292 (*See Class 9 for this trademark*).
 3,177,296 (*See Class 14 for this trademark*).
 3,177,301. **MIN.LI.ELL NEL.MILLI ELL.NEL.MI AND DESIGN**. MINELLI RENATO, (U.S. CLS. 1, 2, 3, 22 AND 41). SN 79-017,981. PUB. 9-12-2006. FILED 3-1-2005.
 3,177,304. **VICRI (BLOCK FORM)**. VICRI - SOCIEDADE TEXTIL, LDA., MULTIPLE CLASS, (INT. CLS. 18, 24 AND 25), (U.S. CLS. 1, 2, 3, 22, 39, 41, 42 AND 50). SN 79-018,374. PUB. 9-12-2006. FILED 10-11-2005.
 3,177,307. **BABY AND DESIGN**. KABUSHIKI KAISHA FAST RETAILING, MULTIPLE CLASS, (INT. CLS. 18 AND 25), (U.S. CLS. 1, 2, 3, 22, 39 AND 41). SN 79-018,863. PUB. 9-12-2006. FILED 10-8-2004.
 3,177,314. **SINELA GALLERY (STYLIZED)**. JIMENEZ PEREZ, JERONIMO, MULTIPLE CLASS, (INT. CLS. 18, 25 AND 39), (U.S. CLS. 1, 2, 3, 22, 39, 41, 100 AND 105). SN 79-020,319. PUB. 9-12-2006. FILED 6-30-2005.

CLASS 19—NON-METALLIC BUILDING MATERIALS

- 3,175,755. **INSTAWALL (STYLIZED)**. J P WALLS, INC., (U.S. CLS. 1, 12, 33 AND 50). SN 75-365,528. PUB. 9-12-2006. FILED 9-30-1997.
 3,175,794 (*See Class 7 for this trademark*).
 3,175,872. **WESTERN 1 KOTE AND DESIGN**. SACRAMENTO STUCCO COMPANY, (U.S. CLS. 1, 12, 33 AND 50). SN 76-646,456. PUB. 9-12-2006. FILED 9-9-2005.
 3,175,873. **WESTERN 1 KOTE (BLOCK FORM)**. SACRAMENTO STUCCO COMPANY, (U.S. CLS. 1, 12, 33 AND 50). SN 76-646,457. PUB. 9-12-2006. FILED 9-9-2005.
 3,175,958 (*See Class 6 for this trademark*).
 3,176,210 (*See Class 6 for this trademark*).
 3,176,265. **A LITTLE PIECE OF HAVEN (BLOCK FORM)**. BENGTON, BRADLEY P, (U.S. CLS. 1, 12, 33 AND 50). SN 78-630,193. PUB. 9-12-2006. FILED 5-15-2005.
 3,176,274. **ARRISCRAFT (BLOCK FORM)**. ARRISCRAFT INTERNATIONAL LIMITED PARTNERSHIP, MULTIPLE CLASS, (INT. CLS. 19 AND 40), (U.S. CLS. 1, 12, 33, 50, 100, 103 AND 106). SN 78-631,705. PUB. 9-12-2006. FILED 5-17-2005.
 3,176,393 (*See Class 9 for this trademark*).
 3,176,495. **FIBERBRACE (BLOCK FORM)**. TIN INC., (U.S.

- CLS. 1, 12, 33 AND 50). SN 78-708,752. PUB. 9-12-2006. FILED 9-8-2005.
 3,176,500. **FISHSCALES (BLOCK FORM)**. CONCRETE STONE & TILE CORP., (U.S. CLS. 1, 12, 33 AND 50). SN 78-711,593. PUB. 9-12-2006. FILED 9-13-2005.
 3,176,594. **LINK-A-BORD (BLOCK FORM)**. ARMILLATOX LIMITED, (U.S. CLS. 1, 12, 33 AND 50). SN 78-744,515. PUB. 9-12-2006. FILED 11-1-2005.
 3,177,100. **DUO THERMAL (BLOCK FORM)**. CONESTOGA LOG CABINS, INC., (U.S. CLS. 1, 12, 33 AND 50). SN 78-796,185. PUB. 9-12-2006. FILED 1-20-2006.
 3,177,175. **SMART POST (BLOCK FORM)**. CONESTOGA LOG CABINS, INC., (U.S. CLS. 1, 12, 33 AND 50). SN 78-831,262. PUB. 9-12-2006. FILED 3-7-2006.
 3,177,221. **MODULARCH (BLOCK FORM)**. MATIERE MARCEL, (U.S. CLS. 1, 12, 33 AND 50). SN 79-011,660. PUB. 9-12-2006. FILED 6-3-2005.
 3,177,249. **CERAMICA SANT'AGOSTINO AND DESIGN**. CERAMICA SANT'AGOSTINO - S.P.A., (U.S. CLS. 1, 12, 33 AND 50). SN 79-013,586. PUB. 9-12-2006. FILED 4-15-2005.
 3,177,283 (*See Class 9 for this trademark*).

CLASS 20—FURNITURE AND ARTICLES NOT OTHERWISE CLASSIFIED

- 3,175,762 (*See Class 3 for this trademark*).
 3,175,777. **DELLANNO AND DESIGN**. UNICA INDUSTRIA DE MOVEIS S.A., (U.S. CLS. 2, 13, 22, 25, 32 AND 50). SN 76-480,430. PUB. 9-12-2006. FILED 1-6-2003.
 3,175,794 (*See Class 7 for this trademark*).
 3,175,834 (*See Class 6 for this trademark*).
 3,175,855. **GEO-INCLINE (BLOCK FORM)**. SPAN-AMERICA MEDICAL SYSTEMS, INC., (U.S. CLS. 2, 13, 22, 25, 32 AND 50). SN 76-641,396. PUB. 9-12-2006. FILED 6-22-2005.
 3,175,878 (*See Class 6 for this trademark*).
 3,175,958 (*See Class 6 for this trademark*).
 3,175,964 (*See Class 3 for this trademark*).
 3,175,982. **HOOK-ON-BINS (BLOCK FORM)**. THE DURHAM MANUFACTURING COMPANY, (U.S. CLS. 2, 13, 22, 25, 32 AND 50). SN 78-385,899. PUB. 9-12-2006. FILED 3-17-2004.
 3,176,035 (*See Class 6 for this trademark*).
 3,176,052 (*See Class 11 for this trademark*).
 3,176,057. **CHECK-IT (BLOCK FORM)**. BECHRIS, INC., (U.S. CLS. 2, 13, 22, 25, 32 AND 50). SN 78-508,308. PUB. 9-12-2006. FILED 10-29-2004.
 3,176,065. **SMART JEWELRY CASE (BLOCK FORM)**. STORUS CORPORATION, (U.S. CLS. 2, 13, 22, 25, 32 AND 50). SN 78-516,665. PUB. 9-12-2006. FILED 11-15-2004.
 3,176,152. **PARMY (BLOCK FORM)**. PARMY INC, MULTIPLE CLASS, (INT. CLS. 20 AND 21), (U.S. CLS. 2, 13, 22, 23, 25, 29, 30, 32, 33, 40 AND 50). SN 78-589,599. PUB. 9-12-2006. FILED 3-17-2005.
 3,176,204 (*See Class 9 for this trademark*).
 3,176,366 (*See Class 16 for this trademark*).
 3,176,439. **BRIGHTHOME (BLOCK FORM)**. BRIGHTHOME FURNITURE MANUFACTURING, (U.S. CLS. 2, 13, 22, 25, 32 AND 50). SN 78-684,075. PUB. 9-12-2006. FILED 8-2-2005.
 3,176,529. **JJ JANSZEN FURNITURE AND DESIGN**. JANSSEN INTERNATIONAL LTD., MULTIPLE CLASS, (INT. CLS. 20 AND 35), (U.S. CLS. 2, 13, 22, 25, 32, 50, 100, 101 AND 102). SN 78-720,712. PUB. 9-12-2006. FILED 9-26-2005.
 3,176,545 (*See Class 11 for this trademark*).
 3,176,553. **PILL-PAC (BLOCK FORM)**. PILL-PAC, INC., (U.S. CLS. 2, 13, 22, 25, 32 AND 50). SN 78-725,713. PUB. 9-12-2006. FILED 10-3-2005.
 3,176,604 (*See Class 16 for this trademark*).
 3,176,651. **ENCHANTED ART (BLOCK FORM)**. ADD AN ACCENT, INC., AND GALBRETH-MASIKER, JESSICA, (U.S. CLS. 2, 13, 22, 25, 32 AND 50). SN 78-755,345. PUB. 9-12-2006. FILED 11-16-2005.
 3,176,686. **HOME REDESIGN (BLOCK FORM)**. DERMOPTICA INC., (U.S. CLS. 2, 13, 22, 25, 32 AND 50). SN 78-764,642. PUB. 9-12-2006. FILED 12-1-2005.
 3,176,687. **HOME REDESIGN EXPO (BLOCK FORM)**. DERMOPTICA INC., (U.S. CLS. 2, 13, 22, 25, 32 AND 50). SN 78-764,797. PUB. 9-12-2006. FILED 12-1-2005.

- 3,176,773. **THE HILARIOUS CELEBRATION OF WOMEN AND THE CHANGE (BLOCK FORM)**. J JARGON CO., (U.S. CLS. 2, 13, 22, 25, 32 AND 50). SN 78-778,552. PUB. 9-12-2006. FILED 12-21-2005.
- 3,176,989. **PLASTRON (BLOCK FORM)**. PLASTRON PRODUCTS, (U.S. CLS. 2, 13, 22, 25, 32 AND 50). SN 78-792,290. PUB. 9-12-2006. FILED 1-16-2006.
- 3,177,010. **ALIVAR (BLOCK FORM)**. A. STUDIO S.R.L., (U.S. CLS. 2, 13, 22, 25, 32 AND 50). SN 78-793,055. PUB. 9-12-2006. FILED 1-17-2006.
- 3,177,015. **ENDSTAR (BLOCK FORM)**. ENDSTAR, INC., (U.S. CLS. 2, 13, 22, 25, 32 AND 50). SN 78-793,296. PUB. 9-12-2006. FILED 1-17-2006.
- 3,177,017. **MISCELLANEOUS DESIGN**. ENDSTAR, INC., (U.S. CLS. 2, 13, 22, 25, 32 AND 50). SN 78-793,309. PUB. 9-12-2006. FILED 1-17-2006.
- 3,177,137. **PROTECTIT (STYLIZED)**. WESTON CONSUMER PRODUCTS, INC., (U.S. CLS. 2, 13, 22, 25, 32 AND 50). SN 78-800,653. PUB. 9-12-2006. FILED 1-27-2006.
- 3,177,234 (*See Class 6 for this trademark*).
- 3,177,239. **SIMBOLI (STYLIZED)**. INCANTO GROUP S.R.L., MULTIPLE CLASS, (INT. CLS. 20 AND 24), (U.S. CLS. 2, 13, 22, 25, 32, 42 AND 50). SN 79-013,159. PUB. 9-12-2006. FILED 5-26-2005.
- 3,177,240 (*See Class 3 for this trademark*).
- 3,177,280 (*See Class 1 for this trademark*).
- 3,177,290 (*See Class 6 for this trademark*).
- 13, 23, 29, 30, 33, 40 AND 50). SN 78-839,077. PUB. 9-12-2006. FILED 3-16-2006.
- 3,177,222 (*See Class 3 for this trademark*).
- 3,177,235. **ARICASA AND DESIGN**. ARISTON DI BIGNOTTI GIANLUCA & C. S.N.C., (U.S. CLS. 2, 13, 23, 29, 30, 33, 40 AND 50). SN 79-013,004. PUB. 9-12-2006. FILED 6-10-2005.
- 3,177,237. **TÈNERÈ (STYLIZED)**. ORFEVERIE CHRISTOFLE, (U.S. CLS. 2, 13, 23, 29, 30, 33, 40 AND 50). SN 79-013,102. PUB. 9-12-2006. FILED 6-21-2005.
- 3,177,240 (*See Class 3 for this trademark*).
- 3,177,243 (*See Class 3 for this trademark*).
- 3,177,251 (*See Class 3 for this trademark*).
- 3,177,252 (*See Class 3 for this trademark*).
- 3,177,268 (*See Class 8 for this trademark*).
- 3,177,280 (*See Class 1 for this trademark*).
- 3,177,285 (*See Class 16 for this trademark*).
- 3,177,296 (*See Class 14 for this trademark*).

CLASS 22—CORDAGE AND FIBERS

- 3,175,958 (*See Class 6 for this trademark*).
- 3,177,177. **GANIZER (BLOCK FORM)**. TAGALONG ENTERPRISES, (U.S. CLS. 1, 2, 7, 19, 22, 42 AND 50). SN 78-835,586. PUB. 9-12-2006. FILED 3-13-2006.
- 3,177,280 (*See Class 1 for this trademark*).

CLASS 21—HOUSEWARES AND GLASS

- 3,175,762 (*See Class 3 for this trademark*).
- 3,175,797 (*See Class 9 for this trademark*).
- 3,175,871. **A WISH IN A BOTTLE (BLOCK FORM)**. BARNES, RUTH, (U.S. CLS. 2, 13, 23, 29, 30, 33, 40 AND 50). SN 76-646,312. PUB. 9-12-2006. FILED 9-6-2005.
- 3,175,946 (*See Class 16 for this trademark*).
- 3,175,964 (*See Class 3 for this trademark*).
- 3,175,993. **HIGHGRIP (BLOCK FORM)**. CAPPEL NORROW LIMITED, AND DOVEMART LIMITED, (U.S. CLS. 2, 13, 23, 29, 30, 33, 40 AND 50). SN 78-413,314. PUB. 9-12-2006. FILED 5-5-2004.
- 3,176,052 (*See Class 11 for this trademark*).
- 3,176,115 (*See Class 8 for this trademark*).
- 3,176,120 (*See Class 3 for this trademark*).
- 3,176,152 (*See Class 20 for this trademark*).
- 3,176,171. **SAN ROCCO CERAMICS (BLOCK FORM)**. GUERRIERI GROUP, LLC, THE, (U.S. CLS. 2, 13, 23, 29, 30, 33, 40 AND 50). SN 78-599,792. PUB. 9-12-2006. FILED 4-1-2005.
- 3,176,172. **SAN ROCCO TERRA COTTA (BLOCK FORM)**. GUERRIERI GROUP, LLC, THE, (U.S. CLS. 2, 13, 23, 29, 30, 33, 40 AND 50). SN 78-599,793. PUB. 9-12-2006. FILED 4-1-2005.
- 3,176,210 (*See Class 6 for this trademark*).
- 3,176,237. **QUICK QUENCH (BLOCK FORM)**. THE HARTZ MOUNTAIN CORPORATION, (U.S. CLS. 2, 13, 23, 29, 30, 33, 40 AND 50). SN 78-625,856. PUB. 9-12-2006. FILED 5-9-2005.
- 3,176,279. **ICE CREAM ENGINEERS OF AMERICA AND DESIGN**. HONEYCUTT, RHODNEY, MULTIPLE CLASS, (INT. CLS. 21 AND 25), (U.S. CLS. 2, 13, 22, 23, 29, 30, 33, 39, 40 AND 50). SN 78-632,063. PUB. 9-12-2006. FILED 5-18-2005.
- 3,176,366 (*See Class 16 for this trademark*).
- 3,176,536. **OMAHA AK-SAR-BEN KNIGHTS AK AND DESIGN**. AK-SAR-BEN/CALGARY HOCKEY, INC., (U.S. CLS. 2, 13, 23, 29, 30, 33, 40 AND 50). SN 78-721,387. PUB. 9-12-2006. FILED 9-27-2005.
- 3,176,545 (*See Class 11 for this trademark*).
- 3,176,632. **EZ-CLONE GET ROOTED. GET GROWING. AND DESIGN**. EZ CLONE ENTERPRISES INC., (U.S. CLS. 2, 13, 23, 29, 30, 33, 40 AND 50). SN 78-750,223. PUB. 9-12-2006. FILED 11-9-2005.
- 3,176,923. **BRING BEAUTY TO THE WORLD (BLOCK FORM)**. IGLHAUT, CURT, (U.S. CLS. 2, 13, 23, 29, 30, 33, 40 AND 50). SN 78-787,791. PUB. 9-12-2006. FILED 1-9-2006.
- 3,177,016 (*See Class 8 for this trademark*).
- 3,177,180. **RANIR (BLOCK FORM)**. RANIR, LLC, (U.S. CLS. 2,

CLASS 23—YARNS AND THREADS

- 3,175,762 (*See Class 3 for this trademark*).
- 3,177,269. **PIUMA (BLOCK FORM)**. GÜTERMANN & CO. AG, (U.S. CL. 43). SN 79-014,809. PUB. 9-12-2006. FILED 8-22-2005.

CLASS 24—FABRICS

- 3,175,762 (*See Class 3 for this trademark*).
- 3,175,783 (*See Class 16 for this trademark*).
- 3,175,784 (*See Class 16 for this trademark*).
- 3,175,794 (*See Class 7 for this trademark*).
- 3,175,964 (*See Class 3 for this trademark*).
- 3,176,244. **PRAYER WRAP (BLOCK FORM)**. SCHILLING, CHERYL, (U.S. CLS. 42 AND 50). SN 78-627,195. PUB. 9-12-2006. FILED 5-10-2005.
- 3,176,318. **TITLE TOWEL (BLOCK FORM)**. KILEY SALES, INCORPORATED, (U.S. CLS. 42 AND 50). SN 78-640,626. PUB. 9-12-2006. FILED 5-31-2005.
- 3,176,356. **THERMAPLUS (BLOCK FORM)**. KATHMANDU LIMITED, (U.S. CLS. 42 AND 50). SN 78-652,271. PUB. 9-12-2006. FILED 6-16-2005.
- 3,176,443. **TABLE BIB (BLOCK FORM)**. CLASSY KID, INC., (U.S. CLS. 42 AND 50). SN 78-687,662. PUB. 9-12-2006. FILED 8-8-2005.
- 3,176,537. **OMAHA AK-SAR-BEN KNIGHTS AK AND DESIGN**. AK-SAR-BEN/CALGARY HOCKEY, INC., (U.S. CLS. 42 AND 50). SN 78-721,409. PUB. 9-12-2006. FILED 9-27-2005.
- 3,176,630 (*See Class 16 for this trademark*).
- 3,176,631 (*See Class 16 for this trademark*).
- 3,176,649. **HY HUAYIN AND DESIGN**. NANTONG HUAYIN WOOLEN BLANKET CO., LTD., (U.S. CLS. 42 AND 50). SN 78-754,578. PUB. 9-12-2006. FILED 11-15-2005.
- 3,176,672. **BELL KNITTING (BLOCK FORM)**. BELL KNITTING, (U.S. CLS. 42 AND 50). SN 78-761,424. PUB. 9-12-2006. FILED 11-28-2005.
- 3,176,778 (*See Class 16 for this trademark*).
- 3,176,992. **HOODY (BLOCK FORM)**. REVERE MILLS INTERNATIONAL GROUP, INC., (U.S. CLS. 42 AND 50). SN 78-792,306. PUB. 9-12-2006. FILED 1-16-2006.
- 3,177,239 (*See Class 20 for this trademark*).
- 3,177,240 (*See Class 3 for this trademark*).
- 3,177,296 (*See Class 14 for this trademark*).
- 3,177,304 (*See Class 18 for this trademark*).

3,177,313. **ÖZDILEK AND DESIGN**. ÖZDILEK ALISVERIS MERKEZLERI; VE TEKSTİL SANAYİ ANONİM ŞİRKETİ, MULTIPLE CLASS, (INT. CLS. 24 AND 25), (U.S. CLS. 22, 39, 42 AND 50). SN 79-020,179. PUB. 9-12-2006. FILED 5-31-2005.

CLASS 25—CLOTHING

3,175,752. **INDIANS**. CLEVELAND INDIANS BASEBALL COMPANY LIMITED PARTNERSHIP, (U.S. CL. 39). SN 74-290,827. PUB. 9-12-2006. FILED 7-6-1992.

3,175,753. **PORTLAND PIRATES AND DESIGN**. PORTLAND PIRATES, LLC, (U.S. CLS. 22 AND 39). SN 74-467,274. PUB. 6-6-1995. FILED 12-8-1993.

3,175,762 (*See Class 3 for this trademark*).

3,175,764. **DOLPHIN STYLE**. DOLPHIN, PATRICK, (U.S. CLS. 22 AND 39). SN 76-274,849. PUB. 9-12-2006. FILED 6-21-2001.

3,175,775. **TNA AND DESIGN**. ARITZIA, LP, (U.S. CLS. 22 AND 39). SN 76-462,531. PUB. 2-21-2006. FILED 10-22-2002.

3,175,776. **17 NORTH**. ICICLE INC., (U.S. CLS. 22 AND 39). SN 76-469,357. PUB. 9-12-2006. FILED 11-22-2002.

3,175,778. **FLOWER KITE AND DESIGN**. GALLO, MARC, MULTIPLE CLASS, (INT. CLS. 25 AND 35), (U.S. CLS. 22, 39, 100, 101 AND 102). SN 76-497,679. PUB. 6-21-2005. FILED 3-17-2003.

3,175,783 (*See Class 16 for this trademark*).

3,175,784 (*See Class 16 for this trademark*).

3,175,794 (*See Class 7 for this trademark*).

3,175,824 (*See Class 9 for this trademark*).

3,175,825 (*See Class 9 for this trademark*).

3,175,844. **P. (STYLIZED)**. DON PARRIS INC., (U.S. CLS. 22 AND 39). SN 76-638,766. PUB. 9-12-2006. FILED 5-17-2005.

3,175,869 (*See Class 8 for this trademark*).

3,175,874. **MISCELLANEOUS DESIGN**. JOYSTICK, INC., (U.S. CLS. 22 AND 39). SN 76-646,847. PUB. 9-12-2006. FILED 9-15-2005.

3,175,879 (*See Class 18 for this trademark*).

3,175,920. **GEL-STRIKE (BLOCK FORM)**. ASICS CORPORATION, (U.S. CLS. 22 AND 39). SN 76-653,011. PUB. 9-12-2006. FILED 1-6-2006.

3,175,921. **GEL-STREETHAWK (BLOCK FORM)**. ASICS CORPORATION, (U.S. CLS. 22 AND 39). SN 76-653,012. PUB. 9-12-2006. FILED 1-6-2006.

3,175,922. **GEL-SOLUTION (BLOCK FORM)**. ASICS CORPORATION, (U.S. CLS. 22 AND 39). SN 76-653,013. PUB. 9-12-2006. FILED 1-6-2006.

3,175,933. **THE OXYGEN NETWORK (BLOCK FORM)**. O2 HOLDINGS, LLC, (U.S. CLS. 22 AND 39). SN 76-654,595. PUB. 9-12-2006. FILED 2-2-2006.

3,175,937. **LOGGERHEAD CLUB & MARINA AND DESIGN**. LOGGERHEAD CLUB & MARINA, LTD., MULTIPLE CLASS, (INT. CLS. 25, 35, 39, 41 AND 43), (U.S. CLS. 22, 39, 100, 101, 102, 105 AND 107). SN 76-977,695. PUB. 9-12-2006. FILED 6-15-2004.

3,175,964 (*See Class 3 for this trademark*).

3,175,972. **DISCIPLE AND DESIGN**. FI-FABRY INDUSTRIES, INC., (U.S. CLS. 22 AND 39). SN 78-348,931. PUB. 9-12-2006. FILED 1-7-2004.

3,175,984. **DOMA (BLOCK FORM)**. ABITBOUL, LUCIANO, (U.S. CLS. 22 AND 39). SN 78-387,738. PUB. 9-12-2006. FILED 3-19-2004.

3,176,001. **CHILLAXIN JUS MARINATING (BLOCK FORM)**. PAREDES, KYLE T., (U.S. CLS. 22 AND 39). SN 78-433,340. PUB. 5-16-2006. FILED 6-10-2004.

3,176,021. **DIRT SKINS (BLOCK FORM)**. GARY ANDREW MYERS, (U.S. CLS. 22 AND 39). SN 78-467,172. PUB. 9-12-2006. FILED 8-13-2004.

3,176,037. **MAKERS USA (BLOCK FORM)**. MAKERS USA, INC., (U.S. CLS. 22 AND 39). SN 78-485,678. PUB. 9-12-2006. FILED 9-17-2004.

3,176,043. **CALAVERA (BLOCK FORM)**. MAVERICK CO PTY LTD, (U.S. CLS. 22 AND 39). SN 78-495,142. PUB. 9-12-2006. FILED 10-6-2004.

3,176,062 (*See Class 9 for this trademark*).

3,176,066. **JOIN THE TEAM (BLOCK FORM)**. NATIONAL

FOOTBALL LEAGUE, MULTIPLE CLASS, (INT. CLS. 25, 35, 36, 41 AND 44), (U.S. CLS. 22, 39, 100, 101, 102 AND 107). SN 78-517,139. PUB. 9-12-2006. FILED 11-15-2004.

3,176,081 (*See Class 9 for this trademark*).

3,176,123 (*See Class 9 for this trademark*).

3,176,130. **STREET WARRIORZ SERIES AND DESIGN**. SFX MOTOR SPORTS, INC., DBA CLEAR CHANNEL ENTERTAINMENT- MOTOR SPORTS, MULTIPLE CLASS, (INT. CLS. 25 AND 41), (U.S. CLS. 22, 39, 100, 101 AND 107). SN 78-574,095. PUB. 7-4-2006. FILED 2-24-2005.

3,176,153. **GEL-CURVE (BLOCK FORM)**. VICTORIA'S SECRET DIRECT, LLC, (U.S. CLS. 22 AND 39). SN 78-590,268. PUB. 1-17-2006. FILED 3-18-2005.

3,176,168. **MISCELLANEOUS DESIGN**. DORIS HOSIERY MILLS LTD., (U.S. CLS. 22 AND 39). SN 78-599,248. PUB. 9-12-2006. FILED 3-31-2005.

3,176,175. **MISCELLANEOUS DESIGN**. USA HOCKEY, INC., (U.S. CLS. 22 AND 39). SN 78-601,748. PUB. 9-12-2006. FILED 4-5-2005.

3,176,185. **PRIDE FC FIGHTING CHAMPIONSHIPS AND DESIGN**. DREAM STAGE ENTERTAINMENT, INC., (U.S. CLS. 22 AND 39). SN 78-605,532. PUB. 9-12-2006. FILED 4-9-2005.

3,176,195. **MONTREX AND DESIGN**. MONTREXPORT S.P.A., (U.S. CLS. 22 AND 39). SN 78-609,658. PUB. 9-12-2006. FILED 4-15-2005.

3,176,242. **SURF LINE HAWAII AND DESIGN**. SURF LINE HAWAII, LTD., (U.S. CLS. 22 AND 39). SN 78-627,005. PUB. 9-12-2006. FILED 5-10-2005.

3,176,251. **NINJAS OF THE BLACK DRAGON (BLOCK FORM)**. CALIFORNIA COSTUME COLLECTIONS, INC., (U.S. CLS. 22 AND 39). SN 78-628,190. PUB. 9-12-2006. FILED 5-11-2005.

3,176,260. **PIXXI (BLOCK FORM)**. BUNNELL, DANIELLE D, (U.S. CLS. 22 AND 39). SN 78-629,394. PUB. 9-12-2006. FILED 5-13-2005.

3,176,279 (*See Class 21 for this trademark*).

3,176,281. **GHOSTLY INTERNATIONAL AND DESIGN**. V4 HOLDINGS, LLC, (U.S. CLS. 22 AND 39). SN 78-632,420. PUB. 9-12-2006. FILED 5-18-2005.

3,176,285. **ORIGINAL BALLER (BLOCK FORM)**. PIFER, GARY L., (U.S. CLS. 22 AND 39). SN 78-634,090. PUB. 9-12-2006. FILED 5-20-2005.

3,176,305. **WOSH (STYLIZED)**. GRIMA, JUAN BERNAD, AND MARTINEZ, TOMAS AZNAR, (U.S. CLS. 22 AND 39). SN 78-638,367. PUB. 9-12-2006. FILED 5-26-2005.

3,176,307. **VENOVIA (BLOCK FORM)**. CHIU, CHUAN YAO, (U.S. CLS. 22 AND 39). SN 78-638,924. PUB. 9-12-2006. FILED 5-27-2005.

3,176,321. **ASTROBIRDZ (BLOCK FORM)**. BILL COBB PRODUCTIONS, INC., (U.S. CLS. 22 AND 39). SN 78-641,099. PUB. 9-12-2006. FILED 6-1-2005.

3,176,322. **ETERNITY SHAWL (BLOCK FORM)**. JUUL INC., (U.S. CLS. 22 AND 39). SN 78-641,382. PUB. 9-12-2006. FILED 6-1-2005.

3,176,327. **925NEVER (BLOCK FORM)**. 925 NEVER CORP, (U.S. CLS. 22 AND 39). SN 78-643,635. PUB. 9-12-2006. FILED 6-3-2005.

3,176,332. **FORTINI AND DESIGN**. VINCI ENTERPRISE CORP., (U.S. CLS. 22 AND 39). SN 78-644,215. PUB. 9-12-2006. FILED 6-6-2005.

3,176,334. **MOONBERRIES (BLOCK FORM)**. MOONBERRIES, INC., (U.S. CLS. 22 AND 39). SN 78-644,712. PUB. 9-12-2006. FILED 6-6-2005.

3,176,335. **NVRGVUP (BLOCK FORM)**. GIORGETTI, PHILIP, (U.S. CLS. 22 AND 39). SN 78-644,981. PUB. 9-12-2006. FILED 6-7-2005.

3,176,336. **BARKING IRONS AND DESIGN**. BARKING IRONS, LTD., (U.S. CLS. 22 AND 39). SN 78-645,026. PUB. 9-12-2006. FILED 6-7-2005.

3,176,339. **MALIBU SURFING MUSEUM (BLOCK FORM)**. MAZZA, JOHN G., (U.S. CLS. 22 AND 39). SN 78-645,682. PUB. 9-12-2006. FILED 6-7-2005.

3,176,347. **E AND DESIGN**. L.A. DANCEFORCE, INC., MULTIPLE CLASS, (INT. CLS. 25 AND 41), (U.S. CLS. 22, 39, 100, 101 AND 107). SN 78-649,322. PUB. 9-12-2006. FILED 6-13-2005.

3,176,353. **HIJABMAN (BLOCK FORM)**. MEMON, JAVED I.,

- (U.S. CLS. 22 AND 39). SN 78-651,748. PUB. 9-12-2006. FILED 6-16-2005.
- 3,176,357. **2ENV AND DESIGN**. ON OVERSEAS, LLC, (U.S. CLS. 22 AND 39). SN 78-652,493. PUB. 9-12-2006. FILED 6-16-2005.
- 3,176,365. **IRONCHAPS (BLOCK FORM)**. PROCHAPS EQUESTRIAN EQUIPMENT INC., (U.S. CLS. 22 AND 39). SN 78-654,233. PUB. 9-12-2006. FILED 6-20-2005.
- 3,176,403. **YFB - YOUNG, FABULOUS & BROKE (BLOCK FORM)**. CORNELL, HEIDI, AND ZIONS, BRADLEY, (U.S. CLS. 22 AND 39). SN 78-664,052. PUB. 9-12-2006. FILED 7-5-2005.
- 3,176,422. **FITNESS GEAR AND DESIGN**. AMERICAN SPORTS LICENSING, INC., MULTIPLE CLASS, (INT. CLS. 25 AND 28), (U.S. CLS. 22, 23, 38, 39 AND 50). SN 78-669,504. PUB. 9-12-2006. FILED 7-13-2005.
- 3,176,446. **COTTONNET SUPREME (BLOCK FORM)**. COTTON & ELSE, INC., (U.S. CLS. 22 AND 39). SN 78-689,021. PUB. 9-12-2006. FILED 8-9-2005.
- 3,176,507. **LESMORE (STYLIZED)**. KUMKANG SHOE CO., LTD., (U.S. CLS. 22 AND 39). SN 78-713,617. PUB. 9-12-2006. FILED 9-15-2005.
- 3,176,526. **3 AND DESIGN**. SOUTHERN TRADING IMPORT & EXPORT CO. LTD., (U.S. CLS. 22 AND 39). SN 78-718,989. PUB. 9-12-2006. FILED 9-22-2005.
- 3,176,538. **OMAHA AK-SAR-BEN KNIGHTS AK AND DESIGN**. AK-SAR-BEN/CALGARY HOCKEY, INC., (U.S. CLS. 22 AND 39). SN 78-721,454. PUB. 9-12-2006. FILED 9-27-2005.
- 3,176,616. **CHARLIES ARMY (BLOCK FORM)**. HESSERT, THOMAS, (U.S. CLS. 22 AND 39). SN 78-747,993. PUB. 7-25-2006. FILED 11-6-2005.
- 3,176,663. **GULLITINE CLOTHING AND DESIGN**. SEAN M WALDROP, (U.S. CLS. 22 AND 39). SN 78-757,605. PUB. 9-12-2006. FILED 11-18-2005.
- 3,176,666 (*See Class 14 for this trademark*).
- 3,176,675. **DBOTS (BLOCK FORM)**. DBOT5, LLC, MULTIPLE CLASS, (INT. CLS. 25 AND 28), (U.S. CLS. 22, 23, 38, 39 AND 50). SN 78-762,092. PUB. 9-12-2006. FILED 11-29-2005.
- 3,176,679. **TAMARA LONDON (BLOCK FORM)**. LAPINSKI, TAMARA LEIGH, (U.S. CLS. 22 AND 39). SN 78-763,106. PUB. 9-12-2006. FILED 11-30-2005.
- 3,176,690. **HYDROPROOF ULTRA (BLOCK FORM)**. AMERICAN SPORTS LICENSING, INC., (U.S. CLS. 22 AND 39). SN 78-765,370. PUB. 9-12-2006. FILED 12-2-2005.
- 3,176,747. **FORGED IN THE REPUBLIC OF LOS ANGELES (BLOCK FORM)**. CONSTRUCTIVE GROUP LLC, (U.S. CLS. 22 AND 39). SN 78-775,661. PUB. 9-12-2006. FILED 12-17-2005.
- 3,176,761. **SAFE DREAMS (BLOCK FORM)**. HALO INNOVATIONS, INC., (U.S. CLS. 22 AND 39). SN 78-777,242. PUB. 9-12-2006. FILED 12-20-2005.
- 3,176,778 (*See Class 16 for this trademark*).
- 3,176,803. **SAY LA VIE (BLOCK FORM)**. ZUCKERBERG, JANE, (U.S. CLS. 22 AND 39). SN 78-780,241. PUB. 9-12-2006. FILED 12-23-2005.
- 3,176,814. **MULTIPLES (BLOCK FORM)**. HAGGAR WOMEN'S WEAR, LTD., (U.S. CLS. 22 AND 39). SN 78-781,003. PUB. 9-12-2006. FILED 12-27-2005.
- 3,176,817. **DINA (BLOCK FORM)**. CAROLINA HOSIERY, INC., (U.S. CLS. 22 AND 39). SN 78-781,108. PUB. 9-12-2006. FILED 12-27-2005.
- 3,176,821. **FASHION EXPRESSIONS (BLOCK FORM)**. CHARLES J. DINATALE TOMDAN INC, (U.S. CLS. 22 AND 39). SN 78-781,511. PUB. 9-12-2006. FILED 12-28-2005.
- 3,176,825. **TITLEIST (BLOCK FORM)**. ACUSHNET COMPANY, (U.S. CLS. 22 AND 39). SN 78-781,730. PUB. 9-12-2006. FILED 12-28-2005.
- 3,176,844. **CONTEMPL8 T-SHIRTS (BLOCK FORM)**. CONTEMPL8 T-SHIRTS, MULTIPLE CLASS, (INT. CLS. 25 AND 40), (U.S. CLS. 22, 39, 100, 103 AND 106). SN 78-782,978. PUB. 9-12-2006. FILED 12-30-2005.
- 3,176,845. **MEZZA NEW YORK (STYLIZED)**. MEZZA GLOBAL INC., (U.S. CLS. 22 AND 39). SN 78-782,979. PUB. 9-12-2006. FILED 12-30-2005.
- 3,176,847. **ONE FEATHER RANCH CO. (BLOCK FORM)**. KOHLER, MARK, (U.S. CLS. 22 AND 39). SN 78-783,102. PUB. 9-12-2006. FILED 12-30-2005.
- 3,176,859. **BUDDHA BELLY MATERNITY (BLOCK FORM)**. STEARNS, ASHLEY, FALLON, (U.S. CLS. 22 AND 39). SN 78-784,403. PUB. 9-12-2006. FILED 1-3-2006.
- 3,176,867. **HIP-EDGE (BLOCK FORM)**. ZIEBS, INC., MULTIPLE CLASS, (INT. CLS. 25 AND 35), (U.S. CLS. 22, 39, 100, 101 AND 102). SN 78-784,824. PUB. 9-12-2006. FILED 1-4-2006.
- 3,176,899. **LAGACI SPORT (BLOCK FORM)**. LAGACI INC, (U.S. CLS. 22 AND 39). SN 78-786,294. PUB. 9-12-2006. FILED 1-6-2006.
- 3,176,902. **JUST BE GAUZE (BLOCK FORM)**. LAGACI INC, (U.S. CLS. 22 AND 39). SN 78-786,522. PUB. 9-12-2006. FILED 1-6-2006.
- 3,176,908. **SWEATLODGE AND DESIGN**. CHERPAS, JOHN, AND DELKESKAMP, KELLIE, (U.S. CLS. 22 AND 39). SN 78-786,874. PUB. 9-12-2006. FILED 1-6-2006.
- 3,176,911. **DAAB DELIVERED ANOINTED AND BLESSED (BLOCK FORM)**. HARDNETT, ADRIAN, F, (U.S. CLS. 22 AND 39). SN 78-786,940. PUB. 9-12-2006. FILED 1-6-2006.
- 3,176,914. **MB MONKEYBAR BUDDIES I SEE LONDON, I SEE FRANCE, I CAN'T SEE YOUR UNDERPANTS! AND DESIGN**. WISS., INC., (U.S. CLS. 22 AND 39). SN 78-787,155. PUB. 9-12-2006. FILED 1-8-2006.
- 3,176,981. **LOVEJOY (BLOCK FORM)**. 4 YOU APPAREL, INC., (U.S. CLS. 22 AND 39). SN 78-791,794. PUB. 9-12-2006. FILED 1-13-2006.
- 3,176,982. **WHAT TO WEAR WHEN YOU WANT TO LOOK BARE (BLOCK FORM)**. HANKY PANKY, LTD., (U.S. CLS. 22 AND 39). SN 78-791,868. PUB. 9-12-2006. FILED 1-13-2006.
- 3,176,984. **GREEN WHITE CHECKER WEAR (BLOCK FORM)**. GREEN WHITE CHECKER, LLC, (U.S. CLS. 22 AND 39). SN 78-791,881. PUB. 9-12-2006. FILED 1-13-2006.
- 3,176,995. **THE GOD EXPERIENCE (BLOCK FORM)**. VO-LICH, GREG, (U.S. CLS. 22 AND 39). SN 78-792,586. PUB. 9-12-2006. FILED 1-16-2006.
- 3,177,007 (*See Class 16 for this trademark*).
- 3,177,050. **DEKE AND DESIGN**. BRUCHER, JONATHAN, MULTIPLE CLASS, (INT. CLS. 25 AND 40), (U.S. CLS. 22, 39, 100, 103 AND 106). SN 78-794,152. PUB. 9-12-2006. FILED 1-18-2006.
- 3,177,056 (*See Class 16 for this trademark*).
- 3,177,070. **A (STYLIZED)**. PEAKE, INC., (U.S. CLS. 22 AND 39). SN 78-794,657. PUB. 9-12-2006. FILED 1-19-2006.
- 3,177,097. **MISCELLANEOUS DESIGN**. MISSION SIX DISTRIBUTION, LLC, (U.S. CLS. 22 AND 39). SN 78-796,147. PUB. 9-12-2006. FILED 1-20-2006.
- 3,177,103. **R (STYLIZED)**. THE TOPLINE CORPORATION, (U.S. CLS. 22 AND 39). SN 78-796,285. PUB. 9-12-2006. FILED 1-20-2006.
- 3,177,115. **AIRCOAST (BLOCK FORM)**. MENG, YAP TAT, (U.S. CLS. 22 AND 39). SN 78-797,395. PUB. 9-12-2006. FILED 1-23-2006.
- 3,177,156. **UNBELIEVABLE COMFORT (BLOCK FORM)**. CUPID FOUNDATIONS, INC., (U.S. CLS. 22 AND 39). SN 78-817,432. PUB. 9-12-2006. FILED 2-17-2006.
- 3,177,193 (*See Class 9 for this trademark*).
- 3,177,195 (*See Class 18 for this trademark*).
- 3,177,196 (*See Class 9 for this trademark*).
- 3,177,208. **MISCELLANEOUS DESIGN**. CHRISTIAN DIOR COUTURE, (U.S. CLS. 22 AND 39). SN 79-009,987. PUB. 9-12-2006. FILED 12-24-2004.
- 3,177,223 (*See Class 18 for this trademark*).
- 3,177,247. **RITAI AND DESIGN**. RITAI SHOES CO., LTD, (U.S. CLS. 22 AND 39). SN 79-013,568. PUB. 9-12-2006. FILED 5-30-2005.
- 3,177,260. **ZHENBEI AND DESIGN**. ZHEJIANG ZHENBEI CO., LTD., (U.S. CLS. 22 AND 39). SN 79-014,215. PUB. 9-12-2006. FILED 7-25-2005.
- 3,177,263 (*See Class 18 for this trademark*).
- 3,177,270. **BUSY WORK SHOP (STYLIZED)**. BAPE CO., LTD., (U.S. CLS. 22 AND 39). SN 79-014,838. PUB. 9-12-2006. FILED 7-22-2005.
- 3,177,272. **QUICK TIME AND DESIGN**. BILCE TEKSTIL SANAYI VE DIS TICARET ANONIM SIRKETI, (U.S. CLS. 22 AND 39). SN 79-015,139. PUB. 9-12-2006. FILED 2-18-2005.
- 3,177,274. **VIVE LE SPORT AND DESIGN**. FEDERICO MONTI, (U.S. CLS. 22 AND 39). SN 79-015,372. PUB. 9-12-2006. FILED 6-6-2005.

3,177,278 (*See Class 9 for this trademark.*)
 3,177,284 (*See Class 16 for this trademark.*)
 3,177,296 (*See Class 14 for this trademark.*)
 3,177,304 (*See Class 18 for this trademark.*)
 3,177,307 (*See Class 18 for this trademark.*)
 3,177,311. **GL (STYLIZED)**. SOCIETE GUY LAROCHE, (U.S. CLS. 22 AND 39). SN 79-019,825. PUB. 9-12-2006. FILED 8-3-2005.
 3,177,313 (*See Class 24 for this trademark.*)
 3,177,314 (*See Class 18 for this trademark.*)

CLASS 26—FANCY GOODS

3,175,762 (*See Class 3 for this trademark.*)
 3,175,807 (*See Class 18 for this trademark.*)
 3,175,879 (*See Class 18 for this trademark.*)
 3,176,280. **LOCKSAFE (BLOCK FORM)**. STRETCHLINE HOLDINGS LIMITED, (U.S. CLS. 37, 39, 40, 42 AND 50). SN 78-632,388. PUB. 9-12-2006. FILED 5-18-2005.
 3,176,630 (*See Class 16 for this trademark.*)
 3,176,631 (*See Class 16 for this trademark.*)
 3,176,641. **PLAYBOY (BLOCK FORM)**. PLAYBOY ENTERPRISES INTERNATIONAL, INC., (U.S. CLS. 37, 39, 40, 42 AND 50). SN 78-752,512. PUB. 9-12-2006. FILED 11-11-2005.
 3,176,730. **SUPRA HAIRPIECE COLLECTION (BLOCK FORM)**. BEAUTY ESSENCE, INC., (U.S. CLS. 37, 39, 40, 42 AND 50). SN 78-774,327. PUB. 9-12-2006. FILED 12-15-2005.
 3,176,846. **PRIVACY STRIPS (BLOCK FORM)**. PRIVACY STRIPS, LLC, (U.S. CLS. 37, 39, 40, 42 AND 50). SN 78-782,982. PUB. 9-12-2006. FILED 12-30-2005.
 3,176,960. **LET FASHION GO TO YOUR HEAD (BLOCK FORM)**. DEICHMANN + CO LTD, (U.S. CLS. 37, 39, 40, 42 AND 50). SN 78-790,633. PUB. 9-12-2006. FILED 1-12-2006.
 3,177,042. **TRY NOW (STYLIZED)**. TRY NOW, INC., (U.S. CLS. 37, 39, 40, 42 AND 50). SN 78-793,908. PUB. 9-12-2006. FILED 1-18-2006.

CLASS 27—FLOOR COVERINGS

3,175,762 (*See Class 3 for this trademark.*)
 3,175,794 (*See Class 7 for this trademark.*)
 3,175,958 (*See Class 6 for this trademark.*)
 3,176,073. **CAPEL KIDZ (BLOCK FORM)**. CAPEL, INCORPORATED, (U.S. CLS. 19, 20, 37, 42 AND 50). SN 78-523,933. PUB. 9-12-2006. FILED 11-29-2004.
 3,176,956. **LEGENDS OF THE WEST (BLOCK FORM)**. GERONIMO PRODUCTIONS, INC., (U.S. CLS. 19, 20, 37, 42 AND 50). SN 78-790,071. PUB. 9-12-2006. FILED 1-12-2006.
 3,177,296 (*See Class 14 for this trademark.*)

CLASS 28—TOYS AND SPORTING GOODS

3,175,758. **CHAMPION SPORTS AND DESIGN**. SARA LEE GLOBAL FINANCE L.L.C., (U.S. CLS. 22, 23, 38 AND 50). SN 75-896,424. PUB. 9-12-2006. FILED 1-8-2000.
 3,175,762 (*See Class 3 for this trademark.*)
 3,175,783 (*See Class 16 for this trademark.*)
 3,175,784 (*See Class 16 for this trademark.*)
 3,175,794 (*See Class 7 for this trademark.*)
 3,175,822. **MOOSESKIN (BLOCK FORM)**. MERRICK TACKLE CENTER, INC., (U.S. CLS. 22, 23, 38 AND 50). SN 76-615,431. PUB. 9-12-2006. FILED 10-12-2004.
 3,175,824 (*See Class 9 for this trademark.*)
 3,175,825 (*See Class 9 for this trademark.*)
 3,175,887. **DAVIS (BLOCK FORM)**. DAVIS, JOHN H., (U.S. CLS. 22, 23, 38 AND 50). SN 76-648,943. PUB. 9-12-2006. FILED 10-21-2005.
 3,175,893. **BOUNCE - O - GRAM AND DESIGN**. O'CANNA, M. BRIDGET, AND DEVERS, KATIE RENEE, (U.S. CLS. 22, 23, 38 AND 50). SN 76-649,921. PUB. 9-12-2006. FILED 11-7-

2005.
 3,175,964 (*See Class 3 for this trademark.*)
 3,175,968. **T STREET SURFBOARDS (BLOCK FORM)**. ERVIN, NORMAN DAYLE J.R., (U.S. CLS. 22, 23, 38 AND 50). SN 78-334,299. PUB. 9-12-2006. FILED 12-1-2003.
 3,175,971. **MISCELLANEOUS DESIGN**. KARSTEN MANUFACTURING CORPORATION, (U.S. CLS. 22, 23, 38 AND 50). SN 78-347,910. PUB. 9-12-2006. FILED 1-5-2004.
 3,175,974. **MISCELLANEOUS DESIGN**. KISS CATALOG, LTD., (U.S. CLS. 22, 23, 38 AND 50). SN 78-368,550. PUB. 9-12-2006. FILED 2-16-2004.
 3,176,004. **RH ROYAL HAWAIIAN CHESS SET (STYLIZED)**. WHITNEY, EVERETT, I / IPO, (U.S. CLS. 22, 23, 38 AND 50). SN 78-438,093. PUB. 9-12-2006. FILED 6-19-2004.
 3,176,031. **MAZE WIZARD "THE GAME YOU CAN GET LOST IN!" (STYLIZED)**. GRAPHICWORX DESIGN LLC, (U.S. CLS. 22, 23, 38 AND 50). SN 78-480,458. PUB. 9-12-2006. FILED 9-8-2004.
 3,176,059. **I-BRITE (BLOCK FORM)**. ITOYS INC., (U.S. CLS. 22, 23, 38 AND 50). SN 78-509,418. PUB. 9-12-2006. FILED 11-1-2004.
 3,176,074. **THE MAGIC SMOKEY BUBBLER (BLOCK FORM)**. SPIN MASTER LTD., (U.S. CLS. 22, 23, 38 AND 50). SN 78-524,431. PUB. 9-12-2006. FILED 11-30-2004.
 3,176,079 (*See Class 9 for this trademark.*)
 3,176,129 (*See Class 9 for this trademark.*)
 3,176,140. **BUDDY'S (BLOCK FORM)**. SERGEANT'S PET CARE PRODUCTS, INC., (U.S. CLS. 22, 23, 38 AND 50). SN 78-583,277. PUB. 9-12-2006. FILED 3-9-2005.
 3,176,223. **CRAIG HOLLINGSWORTH SURFBOARDS (BLOCK FORM)**. HOLLINGSWORTH, CRAIG, (U.S. CLS. 22, 23, 38 AND 50). SN 78-623,048. PUB. 9-12-2006. FILED 5-4-2005.
 3,176,225. **DRIVEWAY DEALS (BLOCK FORM)**. WEINER, CELIA ROSE, (U.S. CLS. 22, 23, 38 AND 50). SN 78-623,393. PUB. 9-12-2006. FILED 5-5-2005.
 3,176,229. **PAPERCHASE (BLOCK FORM)**. PAPERCHASE PRODUCTS LIMITED, (U.S. CLS. 22, 23, 38 AND 50). SN 78-624,548. PUB. 9-12-2006. FILED 5-6-2005.
 3,176,302. **PLAY PETS (BLOCK FORM)**. KELLYTOY(USA), INC., (U.S. CLS. 22, 23, 38 AND 50). SN 78-637,553. PUB. 9-12-2006. FILED 5-25-2005.
 3,176,310. **V SERIES AND DESIGN**. HOIST FITNESS SYSTEMS, INC., (U.S. CLS. 22, 23, 38 AND 50). SN 78-639,047. PUB. 9-12-2006. FILED 5-27-2005.
 3,176,331. **CUTTIN' CLAWS KURO (BLOCK FORM)**. MATTEL, INC., (U.S. CLS. 22, 23, 38 AND 50). SN 78-644,180. PUB. 9-12-2006. FILED 6-6-2005.
 3,176,344. **MICRO MADNETICS (BLOCK FORM)**. MATTEL, INC., (U.S. CLS. 22, 23, 38 AND 50). SN 78-647,686. PUB. 9-12-2006. FILED 6-9-2005.
 3,176,361. **FASTER THAN EVER! (BLOCK FORM)**. MATTEL, INC., (U.S. CLS. 22, 23, 38 AND 50). SN 78-653,249. PUB. 9-12-2006. FILED 6-17-2005.
 3,176,364. **EL BATE AND DESIGN**. ANDRE JACOBS, (U.S. CLS. 22, 23, 38 AND 50). SN 78-653,801. PUB. 9-12-2006. FILED 6-20-2005.
 3,176,405. **FESTIVALS OF THE WORLD (BLOCK FORM)**. MATTEL, INC., (U.S. CLS. 22, 23, 38 AND 50). SN 78-664,340. PUB. 9-12-2006. FILED 7-6-2005.
 3,176,406. **MODERN TRENDS COLLECTION (BLOCK FORM)**. MATTEL, INC., (U.S. CLS. 22, 23, 38 AND 50). SN 78-664,344. PUB. 9-12-2006. FILED 7-6-2005.
 3,176,407. **FIESTA TROPICAL (BLOCK FORM)**. MATTEL, INC., (U.S. CLS. 22, 23, 38 AND 50). SN 78-664,398. PUB. 9-12-2006. FILED 7-6-2005.
 3,176,420. **SHELLEVATOR (BLOCK FORM)**. MATTEL, INC., (U.S. CLS. 22, 23, 38 AND 50). SN 78-668,790. PUB. 9-12-2006. FILED 7-12-2005.
 3,176,422 (*See Class 25 for this trademark.*)
 3,176,435. **MEGA MICRO STUNT PACK (BLOCK FORM)**. MATTEL, INC., (U.S. CLS. 22, 23, 38 AND 50). SN 78-679,371. PUB. 9-12-2006. FILED 7-27-2005.
 3,176,441. **QOMBEE (BLOCK FORM)**. MATTEL, INC., (U.S. CLS. 22, 23, 38 AND 50). SN 78-685,203. PUB. 9-12-2006. FILED 8-3-2005.
 3,176,444. **DRAGON CASTLE (BLOCK FORM)**. MATTEL, INC., (U.S. CLS. 22, 23, 38 AND 50). SN 78-688,383. PUB. 9-

- 12-2006. FILED 8-9-2005.
- 3,176,539. **OMAHA AK-SAR-BEN KNIGHTS AK AND DESIGN. AK-SAR-BEN/CALGARY HOCKEY, INC.**, (U.S. CLS. 22, 23, 38 AND 50). SN 78-721,519. PUB. 9-12-2006. FILED 9-27-2005.
- 3,176,546. **BODY-POD (BLOCK FORM)**. BODY POD LIMITED, (U.S. CLS. 22, 23, 38 AND 50). SN 78-722,923. PUB. 7-4-2006. FILED 9-29-2005.
- 3,176,547. **LEGENDS OF THE WEST (BLOCK FORM)**. GERONIMO PRODUCTIONS, INC., (U.S. CLS. 22, 23, 38 AND 50). SN 78-723,930. PUB. 9-12-2006. FILED 9-30-2005.
- 3,176,566. **HYDRACISE (BLOCK FORM)**. MADDEN, MARSHALL, (U.S. CLS. 22, 23, 38 AND 50). SN 78-730,353. PUB. 9-12-2006. FILED 10-11-2005.
- 3,176,586. **WWW.ILLUMINATED IDEAS INC.COM WWW.IIUSA.NET AND DESIGN**. MALOUF, ROBERT, (U.S. CLS. 22, 23, 38 AND 50). SN 78-740,766. PUB. 9-12-2006. FILED 10-26-2005.
- 3,176,628. **WEST RIVER (BLOCK FORM)**. STAFFORD, JAMES E, DBA THE SUTTON COMPANY, (U.S. CLS. 22, 23, 38 AND 50). SN 78-749,389. PUB. 9-12-2006. FILED 11-8-2005.
- 3,176,675 (*See Class 25 for this trademark*).
- 3,176,700. **STOCKOPOLIS BY SCHAEFER DOUGLAS AND DESIGN**. GURULE, JACK, (U.S. CLS. 22, 23, 38 AND 50). SN 78-767,964. PUB. 9-12-2006. FILED 12-6-2005.
- 3,176,746. **D.F.S AND DESIGN**. HE ONE INDUSTRY CO., LTD., (U.S. CLS. 22, 23, 38 AND 50). SN 78-775,613. PUB. 9-12-2006. FILED 12-17-2005.
- 3,176,850. **SCRATCH-N-PLAY (BLOCK FORM)**. VEGAS GAMES, INC., (U.S. CLS. 22, 23, 38 AND 50). SN 78-783,228. PUB. 9-12-2006. FILED 12-30-2005.
- 3,176,851. **CITY BLOCKS (BLOCK FORM)**. SIMMONS, JOHN-NIE F. II, (U.S. CLS. 22, 23, 38 AND 50). SN 78-783,584. PUB. 9-12-2006. FILED 1-2-2006.
- 3,176,870. **PAPER MATCHES (BLOCK FORM)**. CARBONE, AMY, (U.S. CLS. 22, 23, 38 AND 50). SN 78-784,927. PUB. 9-12-2006. FILED 1-4-2006.
- 3,176,895. **EYE-B-NICEY (BLOCK FORM)**. BRAGG, JOAN, (U.S. CLS. 22, 23, 38 AND 50). SN 78-786,133. PUB. 9-12-2006. FILED 1-6-2006.
- 3,176,896. **EYE-B-NICEY AND DESIGN**. BRAGG, JOAN, (U.S. CLS. 22, 23, 38 AND 50). SN 78-786,144. PUB. 9-12-2006. FILED 1-6-2006.
- 3,176,969. **SEE IT, HIT IT (BLOCK FORM)**. PRO PERFORMANCE, LLC, (U.S. CLS. 22, 23, 38 AND 50). SN 78-791,109. PUB. 9-12-2006. FILED 1-13-2006.
- 3,177,076. **I PRO (BLOCK FORM)**. SPORT HELMETS, INC., (U.S. CLS. 22, 23, 38 AND 50). SN 78-794,830. PUB. 9-12-2006. FILED 1-19-2006.
- 3,177,121. **KEEP YOUR PET BUSY WITH GOOD THINGS TO CHEW! (BLOCK FORM)**. PREMIER PET PRODUCTS, LLC, (U.S. CLS. 22, 23, 38 AND 50). SN 78-797,565. PUB. 9-12-2006. FILED 1-23-2006.
- 3,177,145. **MY FAVORITE BABYSITTER (BLOCK FORM)**. MGA ENTERTAINMENT, INC., (U.S. CLS. 22, 23, 38 AND 50). SN 78-807,102. PUB. 9-12-2006. FILED 2-3-2006.
- 3,177,188. **MR. H JUNIOR (BLOCK FORM)**. THE JANE GOODALL INSTITUTE FOR WILDLIFE RESEARCH, EDUCATION AND CONSERVATION, (U.S. CLS. 22, 23, 38 AND 50). SN 78-861,452. PUB. 9-12-2006. FILED 4-13-2006.
- 3,177,195 (*See Class 18 for this trademark*).
- 3,177,255 (*See Class 7 for this trademark*).
- 3,177,284 (*See Class 16 for this trademark*).
- 3,175,840. **VALLECITO (BLOCK FORM)**. REYNOSO, ENRIQUETA GONZALEZ, MULTIPLE CLASS, (INT. CLS. 29 AND 30), (U.S. CL. 46). SN 76-637,266. PUB. 9-12-2006. FILED 4-27-2005.
- 3,175,863. **WE ANSWER TO A HIGHER AUTHORITY (BLOCK FORM)**. CONAGRA BRANDS, INC., MULTIPLE CLASS, (INT. CLS. 29 AND 30), (U.S. CL. 46). SN 76-643,307. PUB. 9-12-2006. FILED 7-21-2005.
- 3,175,932. **HONEST TO GRILLNESS (BLOCK FORM)**. KLEMENT SAUSAGE COMPANY, (U.S. CL. 46). SN 76-653,756. PUB. 9-12-2006. FILED 1-19-2006.
- 3,175,936. **PLYMOUTH FARMS (BLOCK FORM)**. SARGENTO FOODS, INC., (U.S. CL. 46). SN 76-657,022. PUB. 9-12-2006. FILED 3-21-2006.
- 3,176,033. **INSANITY (BLOCK FORM)**. HIRSCHKOP, JON DAVID, MULTIPLE CLASS, (INT. CLS. 29 AND 30), (U.S. CL. 46). SN 78-483,374. PUB. 9-12-2006. FILED 9-14-2004.
- 3,176,058. **ME VISTA GOURMET AND DESIGN**. OPAL EXPORT A.Y. 2002 LTD, MULTIPLE CLASS, (INT. CLS. 29 AND 30), (U.S. CL. 46). SN 78-508,964. PUB. 9-12-2006. FILED 11-1-2004.
- 3,176,219. **MATTIE BELLE'S AND DESIGN**. MANDF FOODS LLC, MULTIPLE CLASS, (INT. CLS. 29 AND 30), (U.S. CL. 46). SN 78-620,728. PUB. 9-12-2006. FILED 5-2-2005.
- 3,176,306. **BAOHE AND DESIGN**. ZHONGSHAN FOODSTUFFS & AQUATIC IMP. & EXP. GROUP CO. LTD. OF GUANGDONG, (U.S. CL. 46). SN 78-638,685. PUB. 9-12-2006. FILED 5-27-2005.
- 3,176,342. **LA CUSCATLECA (STYLIZED)**. SALVADOR CORPORATION IMPORT, (U.S. CL. 46). SN 78-647,367. PUB. 9-12-2006. FILED 6-9-2005.
- 3,176,367. **PETERSON'S (BLOCK FORM)**. KANAN ENTERPRISES, INC., DBA KING NUT COMPANY, MULTIPLE CLASS, (INT. CLS. 29, 30 AND 31), (U.S. CLS. 1 AND 46). SN 78-654,442. PUB. 9-12-2006. FILED 6-20-2005.
- 3,176,382. **GOURMET AMOR FOR THE LOVE OF COOKING (BLOCK FORM)**. LEONARD, MACALUSO, AND BARBARA, MACALUSO, MULTIPLE CLASS, (INT. CLS. 29 AND 30), (U.S. CL. 46). SN 78-657,926. PUB. 9-12-2006. FILED 6-24-2005.
- 3,176,411. **CAPTAIN LOUIE'S AND DESIGN**. W & T SEA-FOOD CORP., (U.S. CL. 46). SN 78-667,003. PUB. 9-12-2006. FILED 7-9-2005.
- 3,176,448. **TRONCHETTO ORIGINALE (BLOCK FORM)**. AUBURN UNIVERSITY, (U.S. CL. 46). SN 78-689,422. PUB. 9-12-2006. FILED 8-10-2005.
- 3,176,469. **QUALITY GUARANTEED OR MONEY BACK JIM PERDUE AND DESIGN**. PERDUE HOLDINGS, INC., (U.S. CL. 46). SN 78-697,433. PUB. 9-12-2006. FILED 8-22-2005.
- 3,176,618. **DOMATESSO (BLOCK FORM)**. BAPA FINE FOODS,LLC, (U.S. CL. 46). SN 78-748,306. PUB. 9-12-2006. FILED 11-7-2005.
- 3,176,653. **HERMOSA (BLOCK FORM)**. SEVEN SEAS SEA-FOODS, INC, (U.S. CL. 46). SN 78-755,549. PUB. 9-12-2006. FILED 11-16-2005.
- 3,176,808. **SINBALA AND DESIGN**. SINBALA CORPORATION, MULTIPLE CLASS, (INT. CLS. 29 AND 43), (U.S. CLS. 46, 100 AND 101). SN 78-780,679. PUB. 9-12-2006. FILED 12-25-2005.
- 3,176,843. **PASTOR CHUCK'S (BLOCK FORM)**. PASTOR CHUCK ORCHARDS, LLC, (U.S. CL. 46). SN 78-782,933. PUB. 9-12-2006. FILED 12-30-2005.
- 3,176,924. **WHEN GREAT TASTE AND WHOLESOME GOODNESS COME TOGETHER, YOU HAVE HARMONY (BLOCK FORM)**. HARMONY FOODS CORPORATION, MULTIPLE CLASS, (INT. CLS. 29 AND 30), (U.S. CL. 46). SN 78-787,853. PUB. 9-12-2006. FILED 1-9-2006.
- 3,176,925. **TRAILS WEST (BLOCK FORM)**. L-BAR-T BISON RANCH, LLC, (U.S. CL. 46). SN 78-787,879. PUB. 9-12-2006. FILED 1-9-2006.
- 3,177,088. **TOFETTES (BLOCK FORM)**. SOYA FOODS CO., INC., (U.S. CL. 46). SN 78-795,429. PUB. 9-12-2006. FILED 1-20-2006.
- 3,177,093. **WILD BILL'S (BLOCK FORM)**. WILD BILL'S FOODS, INC., (U.S. CL. 46). SN 78-795,617. PUB. 9-12-2006. FILED 1-20-2006.
- 3,177,102. **GREEN GARDEN (BLOCK FORM)**. GREEN GARDEN FOOD PRODUCTS, INC., MULTIPLE CLASS, (INT.

CLASS 29—MEATS AND PROCESSED FOODS

- CLS. 29 AND 30), (U.S. CL. 46). SN 78-796,210. PUB. 9-12-2006. FILED 1-20-2006.
- 3,177,109. **STAR AND DESIGN**. BORGES USA, INC., MULTIPLE CLASS, (INT. CLS. 29 AND 30), (U.S. CL. 46). SN 78-796,976. PUB. 9-12-2006. FILED 1-23-2006.
- 3,177,132. **MBT (BLOCK FORM)**. TRADEMARK MANAGEMENT COMPANY, (U.S. CL. 46). SN 78-799,223. PUB. 9-12-2006. FILED 1-25-2006.
- 3,177,158. **HERR'S SWEET ISLAND STYLE POTATO CHIPS THE CHIP WITH THE SWEET ISLAND FLAVOR AND DESIGN**. HERR HOLDINGS, INC., (U.S. CL. 46). SN 78-818,718. PUB. 9-12-2006. FILED 2-20-2006.
- 3,177,250. **KMK AND DESIGN**. JOINT-STOCK COMPANY (JSC) KUPYANSK MILK CANNING COMBINAT, (U.S. CL. 46). SN 79-013,601. PUB. 9-12-2006. FILED 6-21-2005.
- 3,177,276. **MISCELLANEOUS DESIGN**. URBANI TARTUFI S.N.C. DI P. E B. URBANI, MULTIPLE CLASS, (INT. CLS. 29, 30 AND 31), (U.S. CLS. 1 AND 46). SN 79-015,622. PUB. 9-12-2006. FILED 5-31-2005.
- 3,177,287 (*See Class 5 for this trademark*).
- 3,177,298. **MISTER COOK AND DESIGN**. "FLOAREA SOARELUI" S.A., (U.S. CL. 46). SN 79-017,917. PUB. 5-23-2006. FILED 8-16-2005.
- 3,177,317. **ANDALEÑA (BLOCK FORM)**. LESIEUR, (U.S. CL. 46). SN 79-021,136. PUB. 9-12-2006. FILED 1-17-2006.

CLASS 30—STAPLE FOODS

- 3,175,765. **WORLD CLASS GOURMET COFFEES AND DESIGN**. MARIGNY CORPORATION, THE, (U.S. CL. 46). SN 76-294,975. PUB. 9-12-2006. FILED 8-3-2001.
- 3,175,786 (*See Class 29 for this trademark*).
- 3,175,800. **SPICED MARINADE (BLOCK FORM)**. SOUTHEASTERN MILLS, INC., (U.S. CL. 46). SN 76-576,334. PUB. 9-12-2006. FILED 2-19-2004.
- 3,175,801. **CAPEULU THE COFFEE ENCOUNTERS AND DESIGN**. CAPEULEU, SOCIEDAD ANONIMA, (U.S. CL. 46). SN 76-577,792. PUB. 9-12-2006. FILED 2-26-2004.
- 3,175,838 (*See Class 2 for this trademark*).
- 3,175,840 (*See Class 29 for this trademark*).
- 3,175,863 (*See Class 29 for this trademark*).
- 3,175,882. **ORIGINAL BUNDT (BLOCK FORM)**. NORTHLAND ALUMINUM PRODUCTS, INC., (U.S. CL. 46). SN 76-648,110. PUB. 9-12-2006. FILED 10-7-2005.
- 3,175,901. **MISCELLANEOUS DESIGN**. KINETICO INCORPORATED, (U.S. CL. 46). SN 76-652,258. PUB. 9-12-2006. FILED 12-21-2005.
- 3,175,939. **RAGIN'**. LANCE MFG. LLC, (U.S. CL. 46). SN 78-135,832. PUB. 9-12-2006. FILED 6-14-2002.
- 3,175,941. **MISCELLANEOUS DESIGN**. STARBUCKS U.S. BRANDS, LLC, MULTIPLE CLASS, (INT. CLS. 30 AND 43), (U.S. CLS. 46, 100 AND 101). SN 78-175,839. PUB. 9-12-2006. FILED 10-18-2002.
- 3,175,949. **PRIMATE PIES**. MONKEY WORLD LIMITED, (U.S. CL. 46). SN 78-236,388. PUB. 1-24-2006. FILED 4-10-2003.
- 3,175,955 (*See Class 5 for this trademark*).
- 3,176,005. **CHOCOLATE RASPBERRY OBSESSION (BLOCK FORM)**. WELLS' DAIRY, INC., (U.S. CL. 46). SN 78-440,763. PUB. 9-12-2006. FILED 6-24-2004.
- 3,176,033 (*See Class 29 for this trademark*).
- 3,176,058 (*See Class 29 for this trademark*).
- 3,176,113. **DAYHOFF'S (BLOCK FORM)**. DAYHOFF, LLC, (U.S. CL. 46). SN 78-559,582. PUB. 9-12-2006. FILED 2-3-2005.
- 3,176,142. **MARACANÁ (BLOCK FORM)**. CAFE' DAMASCO S/A, (U.S. CL. 46). SN 78-583,910. PUB. 9-12-2006. FILED 3-9-2005.
- 3,176,219 (*See Class 29 for this trademark*).
- 3,176,269. **COOKIECHIX GOURMET COOKIE COMPANY, LLC AND DESIGN**. COOKIE CHIX GOURMET COOKIE COMPANY, LLC, (U.S. CL. 46). SN 78-630,493. PUB. 9-12-2006. FILED 5-16-2005.
- 3,176,270. **CRÈME FRANCAIS (BLOCK FORM)**. GUITTARD CHOCOLATE COMPANY, (U.S. CL. 46). SN 78-630,528. PUB. 9-12-2006. FILED 5-16-2005.
- 3,176,278. **CAFE SOLMAR (BLOCK FORM)**, CAFE SOLMAR, LLC, (U.S. CL. 46). SN 78-632,002. PUB. 9-12-2006. FILED 5-18-2005.
- 3,176,319. **CITY BREW (BLOCK FORM)**. J & B INC., (U.S. CL. 46). SN 78-640,718. PUB. 9-12-2006. FILED 5-31-2005.
- 3,176,343. **BABY BOTTLE POP (BLOCK FORM)**. THE TOPPS COMPANY, INC., (U.S. CL. 46). SN 78-647,397. PUB. 9-12-2006. FILED 6-9-2005.
- 3,176,367 (*See Class 29 for this trademark*).
- 3,176,375. **SOUTHERN BULL BBQ SAUCE AND DESIGN**. ONEIDA INDIAN NATION OF NEW YORK, AKA THE ONEIDA INDIAN NATION OF NEW YORK, AKA THE ONEIDA INDIAN NATION, AKA ONEIDA INDIAN NATION, AKA THE ONEIDA NATION, OR AKA ONEIDA NATION, (U.S. CL. 46). SN 78-656,274. PUB. 9-12-2006. FILED 6-22-2005.
- 3,176,382 (*See Class 29 for this trademark*).
- 3,176,436. **B.W. COOPER'S (BLOCK FORM)**. COOPER, BARRY P. W., (U.S. CL. 46). SN 78-680,339. PUB. 9-12-2006. FILED 7-28-2005.
- 3,176,503. **CAMPPI'S PIZZA (BLOCK FORM)**. CAMPPI'S PIZZA, INC., MULTIPLE CLASS, (INT. CLS. 30 AND 43), (U.S. CLS. 46, 100 AND 101). SN 78-711,776. PUB. 9-12-2006. FILED 9-13-2005.
- 3,176,512. **MISCELLANEOUS DESIGN**. BÉQUET CONFECTIIONS, (U.S. CL. 46). SN 78-714,597. PUB. 9-12-2006. FILED 9-16-2005.
- 3,176,562. **MALLOW MAGIC (BLOCK FORM)**. AMERICAN POP CORN COMPANY, (U.S. CL. 46). SN 78-729,152. PUB. 9-12-2006. FILED 10-7-2005.
- 3,176,617. **"YOU CAN PUT IT ON ANYTHING THAT AIN'T MOVIN'!" (BLOCK FORM)**. FI ENTERPRISES LLC, (U.S. CL. 46). SN 78-748,224. PUB. 9-12-2006. FILED 11-7-2005.
- 3,176,674. **FERNWOOD (BLOCK FORM)**. MAXFIELD CANDY COMPANY, (U.S. CL. 46). SN 78-761,927. PUB. 9-12-2006. FILED 11-28-2005.
- 3,176,782. **SHIZEN ALL NATURAL SUSHI (BLOCK FORM)**. SUSHI WITH GUSTO, INC., (U.S. CL. 46). SN 78-779,172. PUB. 9-12-2006. FILED 12-22-2005.
- 3,176,783. **SHIZEN ALL NATURAL SUSHI AND DESIGN**. SUSHI WITH GUSTO, INC., (U.S. CL. 46). SN 78-779,198. PUB. 9-12-2006. FILED 12-22-2005.
- 3,176,839. **NAJLA'S (BLOCK FORM)**. ASWAD, NAJLA R., (U.S. CL. 46). SN 78-782,677. PUB. 9-12-2006. FILED 12-29-2005.
- 3,176,924 (*See Class 29 for this trademark*).
- 3,176,986. **BELLARICO'S (BLOCK FORM)**. LIBERTY USA, INC., (U.S. CL. 46). SN 78-792,133. PUB. 9-12-2006. FILED 1-16-2006.
- 3,177,001. **VICTORIAN SWEET SHOPPE, INC. (STYLIZED)**. VICTORIAN SWEET SHOPPE, INC., (U.S. CL. 46). SN 78-792,851. PUB. 9-12-2006. FILED 1-17-2006.
- 3,177,002. **VSS AND DESIGN**. VICTORIAN SWEET SHOPPE, INC., (U.S. CL. 46). SN 78-792,855. PUB. 9-12-2006. FILED 1-17-2006.
- 3,177,013. **SERTINOS (BLOCK FORM)**. ALL AMERICAN SPECIALTY RESTAURANTS, INC., (U.S. CL. 46). SN 78-793,192. PUB. 9-12-2006. FILED 1-17-2006.
- 3,177,043. **PENNY CLUB (BLOCK FORM)**. MR. GOODCENTS FRANCHISE SYSTEMS, INC., (U.S. CL. 46). SN 78-793,948. PUB. 9-12-2006. FILED 1-18-2006.
- 3,177,051. **HELICONIA COFFEE (STYLIZED)**. ROY HARRISON YELTON, (U.S. CL. 46). SN 78-794,153. PUB. 9-12-2006. FILED 1-18-2006.
- 3,177,083. **MR. YUMMY AND DESIGN**. IMAGINE GLOBAL LLC, (U.S. CL. 46). SN 78-795,082. PUB. 9-12-2006. FILED 1-19-2006.
- 3,177,098. **ZZANG! (BLOCK FORM)**. DANCING SANDWICH ENTERPRISES, INC., (U.S. CL. 46). SN 78-796,179. PUB. 9-12-2006. FILED 1-20-2006.
- 3,177,099. **ZZANG! (STYLIZED)**. DANCING SANDWICH ENTERPRISES, INC., (U.S. CL. 46). SN 78-796,181. PUB. 9-12-2006. FILED 1-20-2006.
- 3,177,102 (*See Class 29 for this trademark*).
- 3,177,106. **HEARTLAND AND DESIGN**. AMERICAN ITALIAN PASTA COMPANY, (U.S. CL. 46). SN 78-796,780. PUB. 9-12-2006. FILED 1-23-2006.
- 3,177,109 (*See Class 29 for this trademark*).
- 3,177,126. **GOLDIE'S (BLOCK FORM)**. GOLDIE'S COFFEE

- HOUSE, INC., (U.S. CL. 46). SN 78-798,208. PUB. 9-12-2006. FILED 1-24-2006.
- 3,177,164. **SUAVA JAVA AND DESIGN**. CHEVRON INTELLECTUAL PROPERTY INC., (U.S. CL. 46). SN 78-825,458. PUB. 9-12-2006. FILED 2-28-2006.
- 3,177,190. **CELLINI AND DESIGN**. EKAF INDUSTRIA NAZIONALE DEL CAFFÈ SPA, (U.S. CL. 46). SN 79-002,869. PUB. 9-12-2006. FILED S.R. 12-23-2003; AM. P.R. 5-5-2006.
- 3,177,217 (*See Class 1 for this trademark*).
- 3,177,259. **MISCELLANEOUS DESIGN**. CHOCOLADEFABRIKEN LINDT & SPRÜNGLI AG, (U.S. CL. 46). SN 79-014,195. PUB. 9-12-2006. FILED 5-18-2005.
- 3,177,276 (*See Class 29 for this trademark*).
- 3,177,287 (*See Class 5 for this trademark*).
- 3,177,293. **FUWEI AND DESIGN**. SHANTOU FUWEI FRUITS & NUTS MANUFACTURING CO., LTD, (U.S. CL. 46). SN 79-017,141. PUB. 9-12-2006. FILED 4-29-2005.

CLASS 31—NATURAL AGRICULTURAL PRODUCTS

- 3,175,821. **LITTLE SKOOKUM (STYLIZED)**. LITTLE SKOOKUM SHELLFISH GROWERS, LLC, (U.S. CLS. 1 AND 46). SN 76-614,808. PUB. 9-12-2006. FILED 10-7-2004.
- 3,175,849. **KLEIN'S NATURALS (BLOCK FORM)**. KLEINS NATURALS, LTD., (U.S. CLS. 1 AND 46). SN 76-640,151. PUB. 9-12-2006. FILED 6-1-2005.
- 3,175,981. **ECOLIGHT AND DESIGN**. ADRIAN EDUARDO GARCIA, AND HECTOR OSCAR NUÑEZ, AND ERNESTO JULIO BALDASSARE, AND EDUARDO ENRIQUE ISOARDI, (U.S. CLS. 1 AND 46). SN 78-385,357. PUB. 9-12-2006. FILED 3-16-2004.
- 3,176,060. **SCOTTS TG AND DESIGN**. OMS INVESTMENTS, INC., (U.S. CLS. 1 AND 46). SN 78-510,877. PUB. 9-12-2006. FILED 11-3-2004.
- 3,176,367 (*See Class 29 for this trademark*).
- 3,176,511 (*See Class 5 for this trademark*).
- 3,176,590. **MISCELLANEOUS DESIGN**. UNITY AG DIRECT, INC., (U.S. CLS. 1 AND 46). SN 78-742,682. PUB. 9-12-2006. FILED 10-28-2005.
- 3,176,705. **GOLDRIVER ORCHARDS (BLOCK FORM)**. GOLDRIVER ORCHARDS, INC., (U.S. CLS. 1 AND 46). SN 78-769,570. PUB. 9-12-2006. FILED 12-8-2005.
- 3,176,849. **SWEET MEADOW (BLOCK FORM)**. MICHAUD, ALBERT O., (U.S. CLS. 1 AND 46). SN 78-783,184. PUB. 9-12-2006. FILED 12-30-2005.
- 3,177,157. **LITTLEONE (BLOCK FORM)**. MONROVIA NURSERY COMPANY, (U.S. CLS. 1 AND 46). SN 78-818,191. PUB. 9-12-2006. FILED 2-17-2006.
- 3,177,231. **RAFIN (STYLIZED)**. SNOW BRAND SEED CO., LTD., (U.S. CLS. 1 AND 46). SN 79-012,683. PUB. 9-12-2006. FILED 1-18-2005.
- 3,177,276 (*See Class 29 for this trademark*).

CLASS 32—LIGHT BEVERAGES

- 3,175,756. **IMPERIAL RUSSIAN STOUT BREWED IN THE U.K. COURAGE LTD. LONDON SWI AND DESIGN**. SCOTTISH & NEWCASTLE PLC, (U.S. CLS. 45, 46 AND 48). SN 75-577,361. PUB. 4-12-2005. FILED 10-27-1998.
- 3,175,802. **HEILEMAN'S OLD STYLE LAGER OLD STYLE LAGER OLD STYLE LAGER OLD STYLE LAGER BEER NONE GENUINE WITHOUT THIS SIGNATURE HEILEMAN'S BREWING CO. AND DESIGN**. PABST BREWING COMPANY, (U.S. CLS. 45, 46 AND 48). SN 76-582,206. PUB. 9-12-2006. FILED 3-18-2004.
- 3,175,859. **FRUIT OOZE (BLOCK FORM)**. LIQUID ASSETS, INC., (U.S. CLS. 45, 46 AND 48). SN 76-642,323. PUB. 9-12-2006. FILED 7-6-2005.
- 3,175,877. **ALPINE VALLEY (BLOCK FORM)**. ALPINE VALLEY WATER COMPANY, MULTIPLE CLASS, (INT. CLS. 32 AND 39), (U.S. CLS. 45, 46, 48, 100 AND 105). SN 76-647,252. PUB. 9-12-2006. FILED 9-22-2005.

- 3,175,910. **FRAOCH HEATHER ALE (BLOCK FORM)**. LEGEND LIMITED, (U.S. CLS. 45, 46 AND 48). SN 76-652,634. PUB. 9-12-2006. FILED 12-28-2005.
- 3,175,926. **TERMINAL GRAVITY BREWING (BLOCK FORM)**. TERMINAL GRAVITY BREWING INC., (U.S. CLS. 45, 46 AND 48). SN 76-653,308. PUB. 9-12-2006. FILED 1-10-2006.
- 3,176,330. **SAINT ANTHONY'S HEALTHY HEART DRINK (BLOCK FORM)**. RAFAEL'S FOODS, LLC, (U.S. CLS. 45, 46 AND 48). SN 78-644,123. PUB. 9-12-2006. FILED 6-6-2005.
- 3,176,447. **GUARANA RAIN (BLOCK FORM)**. AMPLEXO USA, INC., (U.S. CLS. 45, 46 AND 48). SN 78-689,182. PUB. 9-12-2006. FILED 8-9-2005.
- 3,176,518. **ROMANO'S ITALIAN SODA (BLOCK FORM)**. NONNO SODA WORKS, LLC, DBA ROMANO'S ITALIAN SODA COMPANY, (U.S. CLS. 45, 46 AND 48). SN 78-715,961. PUB. 9-12-2006. FILED 9-19-2005.
- 3,176,588. **50/50 (BLOCK FORM)**. ABC BEVERAGE CORP., (U.S. CLS. 45, 46 AND 48). SN 78-742,055. PUB. 9-12-2006. FILED 10-27-2005.
- 3,176,752. **SIBERIAN NIGHT (BLOCK FORM)**. THIRSTY DOG BREWING COMPANY, (U.S. CLS. 45, 46 AND 48). SN 78-776,130. PUB. 9-12-2006. FILED 12-19-2005.
- 3,176,767. **ARDMORE FARMS AND DESIGN**. ARDMORE FARMS, INC., (U.S. CLS. 45, 46 AND 48). SN 78-777,766. PUB. 9-12-2006. FILED 12-21-2005.
- 3,176,806. **CAPT'N ELI'S (BLOCK FORM)**. SHIPYARD BREWING COMPANY, LLC, (U.S. CLS. 45, 46 AND 48). SN 78-780,453. PUB. 9-12-2006. FILED 12-23-2005.
- 3,176,812. **TREMONT (BLOCK FORM)**. SHIPYARD BREWING COMPANY, LLC, (U.S. CLS. 45, 46 AND 48). SN 78-780,905. PUB. 9-12-2006. FILED 12-27-2005.
- 3,176,820. **NORTHERN MIST (BLOCK FORM)**. MAPLES & COMPANY, INC., (U.S. CLS. 45, 46 AND 48). SN 78-781,449. PUB. 9-12-2006. FILED 12-28-2005.
- 3,177,065. **SANEST (BLOCK FORM)**. KHANH HOA SALANGANES NEST COMPANY, (U.S. CLS. 45, 46 AND 48). SN 78-794,560. PUB. 9-12-2006. FILED 1-19-2006.
- 3,177,066. **REJUVE 5000+ (BLOCK FORM)**. CHOI, HOON S, (U.S. CLS. 45, 46 AND 48). SN 78-794,564. PUB. 9-12-2006. FILED 1-19-2006.
- 3,177,198. **TAPS BREWERY (STYLIZED)**. ISTANBUL GIDA TURIZM SANAYI VE TICARET ANONIM SIRKETI, MULTIPLE CLASS, (INT. CLS. 32 AND 33), (U.S. CLS. 45, 46, 47, 48 AND 49). SN 79-007,321. PUB. 9-12-2006. FILED 7-19-2004.
- 3,177,281. **MISCELLANEOUS DESIGN**. MAST-JÄGERMEISTER AG, MULTIPLE CLASS, (INT. CLS. 32 AND 33), (U.S. CLS. 45, 46, 47, 48 AND 49). SN 79-016,181. PUB. 9-12-2006. FILED 9-5-2005.
- 3,177,287 (*See Class 5 for this trademark*).
- 3,177,295 (*See Class 5 for this trademark*).

CLASS 33—WINES AND SPIRITS

- 3,176,002. **VINEAUX (BLOCK FORM)**. FROGTOWN CELLARS, LLLP, (U.S. CLS. 47 AND 49). SN 78-434,422. PUB. 9-12-2006. FILED 6-13-2004.
- 3,176,179. **KEDEM ESTATES (BLOCK FORM)**. ROYAL WINE CORPORATION, (U.S. CLS. 47 AND 49). SN 78-603,543. PUB. 9-12-2006. FILED 4-7-2005.
- 3,176,241. **CAMPEÓN (STYLIZED)**. ALLIED LOMAR, INC., (U.S. CLS. 47 AND 49). SN 78-626,015. PUB. 9-12-2006. FILED 5-9-2005.
- 3,176,317. **BELLS & WHISTLES (BLOCK FORM)**. TOPWAY DEVELOPMENTS PTY LTD, (U.S. CLS. 47 AND 49). SN 78-640,414. PUB. 9-12-2006. FILED 5-31-2005.
- 3,176,450. **ST-RÉMY NAPOLEON BRANDY FRENCH BRANDY N BRANDY FRANÇAIS AND DESIGN**. E. REMY MARTIN & CO, (U.S. CLS. 47 AND 49). SN 78-689,594. PUB. 9-12-2006. FILED 8-10-2005.
- 3,176,460. **T&W (BLOCK FORM)**. EMPIRE WINERIES, LLC, (U.S. CLS. 47 AND 49). SN 78-694,458. PUB. 9-12-2006. FILED 8-17-2005.
- 3,176,533. **M.COSENTINO (STYLIZED)**. COSENTINO SIGNATURE ENTERPRISES LTD LLC, (U.S. CLS. 47 AND 49). SN 78-721,225. PUB. 9-12-2006. FILED 9-27-2005.

- 3,176,534. **M.COSENTINO (BLOCK FORM)**. COSENTINO SIGNATURE ENTERPRISES LTD LLC, (U.S. CLS. 47 AND 49). SN 78-721,244. PUB. 9-12-2006. FILED 9-27-2005.
- 3,176,735. **CANA'S FEAST (BLOCK FORM)**. CUNEO CELLARS, LLC, (U.S. CLS. 47 AND 49). SN 78-774,692. PUB. 9-12-2006. FILED 12-15-2005.
- 3,176,785. **PRINCE HILL (BLOCK FORM)**. RICHARD C. ERATH, (U.S. CLS. 47 AND 49). SN 78-779,255. PUB. 9-12-2006. FILED 12-22-2005.
- 3,176,853. **MISCELLANEOUS DESIGN**. NORTH SHORE DISTILLERY, LLC, (U.S. CLS. 47 AND 49). SN 78-783,630. PUB. 9-12-2006. FILED 1-2-2006.
- 3,176,873. **DAVE & BUSTER'S (BLOCK FORM)**. DAVE & BUSTER'S I, L.P., (U.S. CLS. 47 AND 49). SN 78-785,124. PUB. 9-12-2006. FILED 1-4-2006.
- 3,177,011. **SYRACHE (BLOCK FORM)**. WORK, PETER, (U.S. CLS. 47 AND 49). SN 78-793,101. PUB. 9-12-2006. FILED 1-17-2006.
- 3,177,166. **MISCELLANEOUS DESIGN**. BARTON BRANDS, LTD., (U.S. CLS. 47 AND 49). SN 78-828,877. PUB. 9-12-2006. FILED 3-3-2006.
- 3,177,167. **MISCELLANEOUS DESIGN**. BARTON BRANDS, LTD., (U.S. CLS. 47 AND 49). SN 78-828,883. PUB. 9-12-2006. FILED 3-3-2006.
- 3,177,168. **MISCELLANEOUS DESIGN**. BARTON BRANDS, LTD., (U.S. CLS. 47 AND 49). SN 78-828,891. PUB. 9-12-2006. FILED 3-3-2006.
- 3,177,169. **MISCELLANEOUS DESIGN**. BARTON BRANDS, LTD., (U.S. CLS. 47 AND 49). SN 78-828,897. PUB. 9-12-2006. FILED 3-3-2006.
- 3,177,170. **MISCELLANEOUS DESIGN**. BARTON BRANDS, LTD., (U.S. CLS. 47 AND 49). SN 78-829,001. PUB. 9-12-2006. FILED 3-3-2006.
- 3,177,171. **MISCELLANEOUS DESIGN**. BARTON BRANDS, LTD., (U.S. CLS. 47 AND 49). SN 78-829,007. PUB. 9-12-2006. FILED 3-3-2006.
- 3,177,172. **MISCELLANEOUS DESIGN**. BARTON BRANDS, LTD., (U.S. CLS. 47 AND 49). SN 78-829,013. PUB. 9-12-2006. FILED 3-3-2006.
- 3,177,173. **MISCELLANEOUS DESIGN**. BARTON BRANDS, LTD., (U.S. CLS. 47 AND 49). SN 78-829,037. PUB. 9-12-2006. FILED 3-3-2006.
- 3,177,174. **MISCELLANEOUS DESIGN**. BARTON BRANDS, LTD., (U.S. CLS. 47 AND 49). SN 78-829,830. PUB. 9-12-2006. FILED 3-6-2006.
- 3,177,198 (*See Class 32 for this trademark*).
- 3,177,219. **ROQUA BLANCA (STYLIZED)**. MAS LA CHEVALIERE, (U.S. CLS. 47 AND 49). SN 79-011,626. PUB. 9-12-2006. FILED 5-13-2005.
- 3,177,224. **ALENTEX AND DESIGN**. ENOFORUM - COMÉRCIO E EXPORTAÇÃO DE VINHOS, S.A., (U.S. CLS. 47 AND 49). SN 79-012,034. PUB. 9-12-2006. FILED 5-12-2005.
- 3,177,281 (*See Class 32 for this trademark*).

CLASS 34—SMOKERS' ARTICLES

- 3,176,009. **HUNTING WORLD (BLOCK FORM)**. HUNTING WORLD LLC, (U.S. CLS. 2, 8, 9 AND 17). SN 78-452,930. PUB. 9-12-2006. FILED 7-19-2004.
- 3,176,569. **VAPORGENIE (BLOCK FORM)**. VAPORGENIE, LLC, (U.S. CLS. 2, 8, 9 AND 17). SN 78-731,254. PUB. 9-12-2006. FILED 10-12-2005.
- 3,176,633. **WORLD FAMOUS J&R CIGARS (BLOCK FORM)**. SANTA CLARA, INC., (U.S. CLS. 2, 8, 9 AND 17). SN 78-750,377. PUB. 9-12-2006. FILED 11-9-2005.
- 3,176,835. **ESTD 1844 (BLOCK FORM)**. CIGARS INTERNATIONAL INC., (U.S. CLS. 2, 8, 9 AND 17). SN 78-782,534. PUB. 9-12-2006. FILED 12-29-2005.
- 3,176,836. **FIGHTING COCK (BLOCK FORM)**. CIGARS INTERNATIONAL INC., (U.S. CLS. 2, 8, 9 AND 17). SN 78-782,535. PUB. 9-12-2006. FILED 12-29-2005.
- 3,176,841. **SLAINTE (BLOCK FORM)**. CIGARS INTERNATIONAL INC., (U.S. CLS. 2, 8, 9 AND 17). SN 78-782,759. PUB. 9-12-2006. FILED 12-29-2005.
- 3,177,246. **CATCHDRY AND DESIGN**. SWEDISH MATCH NORTH EUROPE AB, (U.S. CLS. 2, 8, 9 AND 17). SN 79-

013,532. PUB. 9-12-2006. FILED 6-23-2005.

SERVICE MARKS

CLASS 35—ADVERTISING AND BUSINESS

- 3,175,761. **NRX**. NRX GLOBAL CORP., MULTIPLE CLASS, (INT. CLS. 35, 37, 39 AND 42), (U.S. CLS. 100, 101, 102, 103, 105 AND 106). SN 76-139,174. PUB. 9-12-2006. FILED 10-2-2000.
- 3,175,762 (*See Class 3 for this trademark*).
- 3,175,769. **KNOTIA**. ERNST & YOUNG ELECTRONIC PUBLISHING SERVICES INC., MULTIPLE CLASS, (INT. CLS. 35, 36 AND 42), (U.S. CLS. 100, 101 AND 102). SN 76-414,743. PUB. 1-17-2006. FILED 5-17-2002.
- 3,175,772 (*See Class 12 for this trademark*).
- 3,175,778 (*See Class 25 for this trademark*).
- 3,175,779. **THE 2WENTY**. REGAL CINEMEDIA CORPORATION, MULTIPLE CLASS, (INT. CLS. 35 AND 41), (U.S. CLS. 100, 101, 102 AND 107). SN 76-520,031. PUB. 8-24-2004. FILED 6-6-2003.
- 3,175,780 (*See Class 4 for this trademark*).
- 3,175,789 (*See Class 16 for this trademark*).
- 3,175,791. **FIF'S FINE RESALE APPAREL AND DESIGN**. SUZY-Q ENTERPRISES, INC., (U.S. CLS. 100, 101 AND 102). SN 76-554,047. PUB. 9-12-2006. FILED 10-24-2003.
- 3,175,803. **KSI (BLOCK FORM)**. KSI SWISS, INC., (U.S. CLS. 100, 101 AND 102). SN 76-584,446. PUB. 9-12-2006. FILED 4-2-2004.
- 3,175,806. **BRS AND DESIGN**. BUILDING RESEARCH SYSTEMS, INC., (U.S. CLS. 100, 101 AND 102). SN 76-591,661. PUB. 9-12-2006. FILED 5-11-2004.
- 3,175,817. **MISCELLANEOUS DESIGN**. REAL ESTATE COLLABORATIVE, (U.S. CLS. 100, 101 AND 102). SN 76-612,557. PUB. 9-12-2006. FILED 9-23-2004.
- 3,175,836. **SHANDEX (BLOCK FORM)**. SHANDEX SALES GROUP, LIMITED, (U.S. CLS. 100, 101 AND 102). SN 76-636,063. PUB. 9-12-2006. FILED 4-14-2005.
- 3,175,845. **"BENE" AND DESIGN**. THE TRUSTEES OF THE PEF MEMBERSHIP PROGRAM, (U.S. CLS. 100, 101 AND 102). SN 76-638,775. PUB. 9-12-2006. FILED 5-17-2005.
- 3,175,848. **BLUE MARLIN (BLOCK FORM)**. BARRACUDA HOLDINGS LIMITED, MULTIPLE CLASS, (INT. CLS. 35 AND 42), (U.S. CLS. 100, 101 AND 102). SN 76-639,896. PUB. 9-12-2006. FILED 6-1-2005.
- 3,175,852. **SKIN RX (BLOCK FORM)**. PATEL, EVA, (U.S. CLS. 100, 101 AND 102). SN 76-640,628. PUB. 9-12-2006. FILED 6-7-2005.
- 3,175,858 (*See Class 9 for this trademark*).
- 3,175,875. **CITY OF SCOTTSDALE ARIZONA AND DESIGN**. CITY OF SCOTTSDALE, (U.S. CLS. 100, 101 AND 102). SN 76-646,939. PUB. 9-12-2006. FILED 9-16-2005.
- 3,175,879 (*See Class 18 for this trademark*).
- 3,175,888. **K KEEPITLOCAL.COM YOUR LOCAL SEARCH LEADER! AND DESIGN**. KEEPITLOCAL.COM, MULTIPLE CLASS, (INT. CLS. 35, 36 AND 42), (U.S. CLS. 100, 101 AND 102). SN 76-649,085. PUB. 9-12-2006. FILED 10-24-2005.
- 3,175,908. **RECOGNITION IN MOTION (BLOCK FORM)**. EIGHTH FLOOR PROMOTIONS, LLC, (U.S. CLS. 100, 101 AND 102). SN 76-652,539. PUB. 9-12-2006. FILED 12-27-2005.
- 3,175,917. **SIMPLYGIVEN (BLOCK FORM)**. GENERAL MOTIVATION COMPANY, INC., (U.S. CLS. 100, 101 AND 102). SN 76-652,859. PUB. 9-12-2006. FILED 1-4-2006.
- 3,175,918. **LIGHTNING FAST DINERO (BLOCK FORM)**. THE TAX STORE, INC., (U.S. CLS. 100, 101 AND 102). SN 76-652,903. PUB. 9-12-2006. FILED 1-4-2006.
- 3,175,927. **MILESTONES (BLOCK FORM)**. PATRIOT COMMUNICATIONS LLC, (U.S. CLS. 100, 101 AND 102). SN 76-653,367. PUB. 9-12-2006. FILED 1-12-2006.
- 3,175,937 (*See Class 25 for this trademark*).
- 3,175,947. **MISCELLANEOUS DESIGN**. EVENT ENGINEERING INC, (U.S. CLS. 100, 101 AND 102). SN 78-213,879. PUB. 9-12-2006. FILED 2-12-2003.
- 3,175,950 (*See Class 9 for this trademark*).

- 3,175,955 (*See Class 5 for this trademark*).
- 3,175,956. **MISCELLANEOUS DESIGN**. DEUTSCHE TELEKOM AG, (U.S. CLS. 100, 101 AND 102). SN 78-282,108. PUB. 9-12-2006. FILED 8-1-2003.
- 3,175,957 (*See Class 18 for this trademark*).
- 3,175,958 (*See Class 6 for this trademark*).
- 3,175,969. **MEDIAZONE (BLOCK FORM)**. XPATRINET, INC., MULTIPLE CLASS, (INT. CLS. 35, 38 AND 41), (U.S. CLS. 100, 101, 102, 104 AND 107). SN 78-334,925. PUB. 9-12-2006. FILED 12-2-2003.
- 3,175,973. **LYNDEN INTERNATIONAL (BLOCK FORM)**. LYNDEN INCORPORATED, MULTIPLE CLASS, (INT. CLS. 35, 36 AND 39), (U.S. CLS. 100, 101, 102 AND 105). SN 78-366,680. PUB. 9-12-2006. FILED 2-12-2004.
- 3,175,976. **MEMORY JUNCTION (BLOCK FORM)**. MEMORY JUNCTION ~ SCRAPBOOK HEADQUARTERS, LLC, (U.S. CLS. 100, 101 AND 102). SN 78-377,765. PUB. 9-12-2006. FILED 3-3-2004.
- 3,175,979. **CAREER ASSISTANCE REPAIR EFFORT AND DESIGN**. GENERAL MOTORS ACCEPTANCE CORPORATION, (U.S. CLS. 100, 101 AND 102). SN 78-382,359. PUB. 9-12-2006. FILED 3-11-2004.
- 3,175,985. **ONE POWERFUL SOURCE (BLOCK FORM)**. TRIZETTO GROUP, INC., THE, (U.S. CLS. 100, 101 AND 102). SN 78-388,294. PUB. 9-12-2006. FILED 3-22-2004.
- 3,175,990. **FATCOW AND DESIGN**. THE ENDURANCE INTERNATIONAL GROUP, INC., MULTIPLE CLASS, (INT. CLS. 35, 37 AND 42), (U.S. CLS. 100, 101, 102, 103 AND 106). SN 78-403,494. PUB. 9-12-2006. FILED 4-16-2004.
- 3,175,998. **KNOW WHAT IS COMING (BLOCK FORM)**. DECISIVE ENVIRONMENT, LLC, MULTIPLE CLASS, (INT. CLS. 35, 36, 41 AND 42), (U.S. CLS. 100, 101, 102 AND 107). SN 78-430,102. PUB. 9-12-2006. FILED 6-4-2004.
- 3,176,010. **ADVANCE AUTO PARTS AND DESIGN**. ADVANCE MERCHANDISING COMPANY, INC., (U.S. CLS. 100, 101 AND 102). SN 78-453,252. PUB. 10-11-2005. FILED 7-20-2004.
- 3,176,011. **ADVANCE AUTO PARTS AND DESIGN**. ADVANCE MERCHANDISING COMPANY, INC., (U.S. CLS. 100, 101 AND 102). SN 78-453,265. PUB. 10-18-2005. FILED 7-20-2004.
- 3,176,012. **ADVANCE AUTO PARTS AND DESIGN**. ADVANCE MERCHANDISING COMPANY, INC., (U.S. CLS. 100, 101 AND 102). SN 78-453,277. PUB. 10-18-2005. FILED 7-20-2004.
- 3,176,013. **ADVANCE AUTO PARTS AND DESIGN**. ADVANCE MERCHANDISING COMPANY, INC., (U.S. CLS. 100, 101 AND 102). SN 78-453,288. PUB. 10-11-2005. FILED 7-20-2004.
- 3,176,014. **ADVANCE AUTO PARTS AND DESIGN**. ADVANCE MERCHANDISING COMPANY, INC., (U.S. CLS. 100, 101 AND 102). SN 78-453,301. PUB. 10-11-2005. FILED 7-20-2004.
- 3,176,017. **MULTIFAMILY RELOCATION SERVICES AND DESIGN**. MOVEFORFREE.COM, (U.S. CLS. 100, 101 AND 102). SN 78-453,775. PUB. 9-12-2006. FILED 7-20-2004.
- 3,176,022. **WAG N' WASH HEALTHY PET CENTER AND DESIGN**. WAG-N-WASH, INC., MULTIPLE CLASS, (INT. CLS. 35 AND 44), (U.S. CLS. 100, 101 AND 102). SN 78-472,747. PUB. 9-12-2006. FILED 8-24-2004.
- 3,176,028. **ELITE GROUP AND DESIGN**. ELITE GROUP, INC., MULTIPLE CLASS, (INT. CLS. 35 AND 39), (U.S. CLS. 100, 101, 102 AND 105). SN 78-478,088. PUB. 10-25-2005. FILED 9-2-2004.
- 3,176,034. **CHANGING THE WAY THE WORLD LOOKS AT CHRISTIANS (BLOCK FORM)**. ARTISTRY MARKETING CONCEPTS, LLC, (U.S. CLS. 100, 101 AND 102). SN 78-483,587. PUB. 9-12-2006. FILED 9-14-2004.
- 3,176,041. **THE FUTURE OF IDEAS AND DESIGN**. THE FUTURE OF IDEAS, (U.S. CLS. 100, 101 AND 102). SN 78-493,175. PUB. 9-12-2006. FILED 10-1-2004.
- 3,176,049. **OUR EFFORT IS FOR YOU (BLOCK FORM)**. THE EFFORT TRUST COMPANY, MULTIPLE CLASS, (INT. CLS. 35 AND 36), (U.S. CLS. 100, 101 AND 102). SN 78-497,076. PUB. 9-12-2006. FILED 10-8-2004.
- 3,176,050. **OXLEY ENTERPRISES INC. AND DESIGN**. OXLEY ENTERPRISES, INC., (U.S. CLS. 100, 101 AND 102). SN 78-499,464. PUB. 9-12-2006. FILED 10-14-2004.
- 3,176,051. **MISCELLANEOUS DESIGN**. STRETCH THE SKIES INC., MULTIPLE CLASS, (INT. CLS. 35 AND 41), (U.S. CLS. 100, 101, 102 AND 107). SN 78-500,494. PUB. 9-12-2006. FILED 10-15-2004.
- 3,176,055. **OPTIMUM RESEARCH GRADE SELECTED PRODUCTS AND DESIGN**. LIFE SCIENCE PRODUCTS, INCORPORATED, (U.S. CLS. 100, 101 AND 102). SN 78-503,975. PUB. 9-12-2006. FILED 10-21-2004.
- 3,176,063 (*See Class 9 for this trademark*).
- 3,176,066 (*See Class 25 for this trademark*).
- 3,176,076. **SIMPLESOLD AND DESIGN**. SIMPLESOLD LLC, (U.S. CLS. 100, 101 AND 102). SN 78-525,723. PUB. 9-12-2006. FILED 12-2-2004.
- 3,176,080. **SIMPLESOLD (BLOCK FORM)**. SIMPLESOLD LLC, (U.S. CLS. 100, 101 AND 102). SN 78-527,378. PUB. 9-12-2006. FILED 12-6-2004.
- 3,176,085. **MISAKKO (BLOCK FORM)**. LU, XI, (U.S. CLS. 100, 101 AND 102). SN 78-531,898. PUB. 9-12-2006. FILED 12-13-2004.
- 3,176,093. **BRAINDROPS AND DESIGN**. MILLER, DAVID, MULTIPLE CLASS, (INT. CLS. 35 AND 44), (U.S. CLS. 100, 101 AND 102). SN 78-540,128. PUB. 9-12-2006. FILED 12-30-2004.
- 3,176,099. **CHRISMUKKAH AND DESIGN**. CHRISMUKKAH.-COM, (U.S. CLS. 100, 101 AND 102). SN 78-546,668. PUB. 9-12-2006. FILED 1-12-2005.
- 3,176,100. **SIMPLE STONE CARE.COM (BLOCK FORM)**. MAVERICK INTERNATIONAL IMPORT/EXPORT GROUP, INC., MULTIPLE CLASS, (INT. CLS. 35 AND 37), (U.S. CLS. 100, 101, 102, 103 AND 106). SN 78-547,350. PUB. 9-12-2006. FILED 1-13-2005.
- 3,176,102. **GFS GORDON FOOD SERVICE HENRY LEE DIVISION AND DESIGN**. GORDON FOOD SERVICE, INC., (U.S. CLS. 100, 101 AND 102). SN 78-549,848. PUB. 9-12-2006. FILED 1-19-2005.
- 3,176,103. **KING OF PRICE (BLOCK FORM)**. RANDY MARION CHEVROLET PONTIAC BUICK, (U.S. CLS. 100, 101 AND 102). SN 78-551,906. PUB. 9-12-2006. FILED 1-21-2005.
- 3,176,106. **THE BUILDING CENTER, INC. AND DESIGN**. BUILDING CENTER, INC., THE, (U.S. CLS. 100, 101 AND 102). SN 78-553,191. PUB. 9-12-2006. FILED 1-25-2005.
- 3,176,117. **AMERICAN 3B SCIENTIFIC (BLOCK FORM)**. 3B SCIENTIFIC GMBH, (U.S. CLS. 100, 101 AND 102). SN 78-560,916. PUB. 9-12-2006. FILED 2-4-2005.
- 3,176,118. **NOVUS AND DESIGN**. NOVUS, INC., (U.S. CLS. 100, 101 AND 102). SN 78-561,034. PUB. 9-12-2006. FILED 2-4-2005.
- 3,176,121. **DTS SPINAL DECOMPRESSION THERAPY (BLOCK FORM)**. EVERGREEN MARKETING GROUP, INC., (U.S. CLS. 100, 101 AND 102). SN 78-563,646. PUB. 9-12-2006. FILED 2-9-2005.
- 3,176,133. **CONNECTING PEOPLE, SUPPORTING LOCAL BUSINESSES AND GIVING BACK. (BLOCK FORM)**. SPUNKA, INC., (U.S. CLS. 100, 101 AND 102). SN 78-576,034. PUB. 9-12-2006. FILED 2-28-2005.
- 3,176,135. **TOP TIER CONSULTING AND DESIGN**. TOP TIER CONSULTING, (U.S. CLS. 100, 101 AND 102). SN 78-577,894. PUB. 9-12-2006. FILED 3-1-2005.
- 3,176,150. **ATLANTA APPAREL WWW.ATLANTAAPPAREL.-COM AND DESIGN**. ORABI, SAADI, (U.S. CLS. 100, 101 AND 102). SN 78-588,852. PUB. 9-12-2006. FILED 3-16-2005.
- 3,176,182. **KING FISH MEDIA (BLOCK FORM)**. KING FISH MEDIA, LLC, MULTIPLE CLASS, (INT. CLS. 35, 38 AND 42), (U.S. CLS. 100, 101, 102 AND 104). SN 78-603,980. PUB. 9-12-2006. FILED 4-7-2005.
- 3,176,183. **HARTMANN STUDIOS AND DESIGN**. HARTMANN STUDIOS INCORPORATED, MULTIPLE CLASS, (INT. CLS. 35, 40, 41, 42 AND 44), (U.S. CLS. 100, 101, 102, 103, 106 AND 107). SN 78-604,084. PUB. 9-12-2006. FILED 4-7-2005.
- 3,176,187. **EMAP (BLOCK FORM)**. TRIVITA, INC., (U.S. CLS. 100, 101 AND 102). SN 78-606,444. PUB. 9-12-2006. FILED 4-11-2005.
- 3,176,197. **4 TILE 4 U AND DESIGN**. TILES 4 U HOLDINGS, INC., (U.S. CLS. 100, 101 AND 102). SN 78-610,240. PUB. 9-12-2006. FILED 4-15-2005.
- 3,176,200. **PAPER PIECING BY OLIVIA (BLOCK FORM)**. OLIVIA'S PIECES, CORP., MULTIPLE CLASS, (INT. CLS.

- 35 AND 40), (U.S. CLS. 100, 101, 102, 103 AND 106). SN 78-610,906. PUB. 9-12-2006. FILED 4-18-2005.
- 3,176,206. **ESPERANZA AND DESIGN**. ESPERANZA CAPITAL PARTNERS LLC, MULTIPLE CLASS, (INT. CLS. 35 AND 36), (U.S. CLS. 100, 101 AND 102). SN 78-615,337. PUB. 9-12-2006. FILED 4-23-2005.
- 3,176,209. **ESPERANZA RESORT (BLOCK FORM)**. ESPERANZA CAPITAL PARTNERS LLC, MULTIPLE CLASS, (INT. CLS. 35 AND 36), (U.S. CLS. 100, 101 AND 102). SN 78-616,658. PUB. 9-12-2006. FILED 4-26-2005.
- 3,176,215. **SMS SUPPLY MANAGEMENT SERVICES, INC. AND DESIGN**. SUPPLY MANAGEMENT SERVICES, INC., (U.S. CLS. 100, 101 AND 102). SN 78-620,518. PUB. 9-12-2006. FILED 5-1-2005.
- 3,176,227. **MISCELLANEOUS DESIGN**. MARCH ISLAND COMPANY, (U.S. CLS. 100, 101 AND 102). SN 78-623,500. PUB. 9-12-2006. FILED 5-5-2005.
- 3,176,228. **REAL SOLUTIONS RELEVANT . EFFECTIVE . ASSET-BUILDING . LOYALTY-PRODUCING SERVICES AND DESIGN**. FILENE RESEARCH INSTITUTE, INC., (U.S. CLS. 100, 101 AND 102). SN 78-623,980. PUB. 9-12-2006. FILED 5-5-2005.
- 3,176,236. **FORTRESS STAFFING GROUP (BLOCK FORM)**. FORTRESS STAFFING GROUP, LLC, (U.S. CLS. 100, 101 AND 102). SN 78-625,544. PUB. 9-12-2006. FILED 5-9-2005.
- 3,176,239. **IDENTITYMONITOR FROM CITI (BLOCK FORM)**. CITIGROUP INC., MULTIPLE CLASS, (INT. CLS. 35 AND 36), (U.S. CLS. 100, 101 AND 102). SN 78-625,996. PUB. 9-12-2006. FILED 5-9-2005.
- 3,176,253. **LEISURE FITNESS (BLOCK FORM)**. LFI EXPRESS, INC., MULTIPLE CLASS, (INT. CLS. 35, 37, 39 AND 42), (U.S. CLS. 100, 101, 102, 103, 105 AND 106). SN 78-628,655. PUB. 9-12-2006. FILED 5-12-2005.
- 3,176,268. **KEY ARTIST GROUP AND DESIGN**. CORPORATE ENTERTAINMENT SPECIALISTS, INC., (U.S. CLS. 100, 101 AND 102). SN 78-630,491. PUB. 9-12-2006. FILED 5-16-2005.
- 3,176,272. **CLW (BLOCK FORM)**. UNDERSTANDING UN LTD., (U.S. CLS. 100, 101 AND 102). SN 78-630,922. PUB. 9-12-2006. FILED 5-16-2005.
- 3,176,295. **THE CONSORTIUM SINCE 1966 AND DESIGN**. CONSORTIUM FOR GRADUATE STUDY IN MANAGEMENT, MULTIPLE CLASS, (INT. CLS. 35, 36 AND 41), (U.S. CLS. 100, 101, 102 AND 107). SN 78-636,224. PUB. 9-12-2006. FILED 5-24-2005.
- 3,176,298. **CARRIAGE HOUSE VIOLINS (BLOCK FORM)**. CARRIAGE HOUSE VIOLINS, INC., (U.S. CLS. 100, 101 AND 102). SN 78-637,054. PUB. 9-12-2006. FILED 5-25-2005.
- 3,176,304. **JUST SO GIFTED AND DESIGN**. JUST SO GIFTED, (U.S. CLS. 100, 101 AND 102). SN 78-638,060. PUB. 9-12-2006. FILED 5-26-2005.
- 3,176,312. **CAR DADDYS WHO'S YOUR CAR DADDY? AND DESIGN**. ASSURED ACCEPTANCE CORPORATION, (U.S. CLS. 100, 101 AND 102). SN 78-639,696. PUB. 9-12-2006. FILED 5-30-2005.
- 3,176,313. **TOWNSEND PRODUCTS (BLOCK FORM)**. TOWNSEND PRODUCTS, INC., (U.S. CLS. 100, 101 AND 102). SN 78-639,720. PUB. 9-12-2006. FILED 5-30-2005.
- 3,176,324. **DANNY ZECK AND DESIGN**. DANNY ZECK FORD LINCOLN MERCURY CORP., (U.S. CLS. 100, 101 AND 102). SN 78-643,057. PUB. 9-12-2006. FILED 6-3-2005.
- 3,176,329. **PAPERTRAXS (BLOCK FORM)**. MEDIA RESOURCES, LTD., (U.S. CLS. 100, 101 AND 102). SN 78-644,070. PUB. 9-12-2006. FILED 6-6-2005.
- 3,176,337. **VALETSHOP (BLOCK FORM)**. I-BEHAVIOR, INC., (U.S. CLS. 100, 101 AND 102). SN 78-645,291. PUB. 9-12-2006. FILED 6-7-2005.
- 3,176,349. **ELEGANCE WITH AN EDGE (BLOCK FORM)**. ABDO DEVELOPMENT, LLC, MULTIPLE CLASS, (INT. CLS. 35, 36 AND 37), (U.S. CLS. 100, 101, 102, 103 AND 106). SN 78-649,618. PUB. 9-12-2006. FILED 6-13-2005.
- 3,176,351. **STOP CLIPPING AND START SAVING! (BLOCK FORM)**. SPROVIERI, JOSEPH J., (U.S. CLS. 100, 101 AND 102). SN 78-651,196. PUB. 9-12-2006. FILED 6-15-2005.
- 3,176,352. **DESERT ISLAND FOODS (BLOCK FORM)**. PINKERTON, SCOTT L., (U.S. CLS. 100, 101 AND 102). SN 78-651,250. PUB. 9-12-2006. FILED 6-15-2005.
- 3,176,362. **TEXAS PETROLEUM GALLERY LEGENDARY OILMEN. BRILLIANT OILS. AND DESIGN**. STANLEY, MARK ANTHONY, (U.S. CLS. 100, 101 AND 102). SN 78-653,313. PUB. 9-12-2006. FILED 6-17-2005.
- 3,176,368. **ADVANCE AUTO PARTS AND DESIGN**. ADVANCE MERCHANDISING COMPANY, INC., (U.S. CLS. 100, 101 AND 102). SN 78-654,501. PUB. 2-28-2006. FILED 6-20-2005.
- 3,176,379 (*See Class 16 for this trademark*).
- 3,176,399. **MOBILE MATCH (BLOCK FORM)**. MOBILE MATCH, LLC, MULTIPLE CLASS, (INT. CLS. 35 AND 45), (U.S. CLS. 100, 101 AND 102). SN 78-662,342. PUB. 9-12-2006. FILED 7-1-2005.
- 3,176,408. **MM AND DESIGN**. MASTERMARK COMPANIES, LLC, MULTIPLE CLASS, (INT. CLS. 35 AND 38), (U.S. CLS. 100, 101, 102 AND 104). SN 78-665,661. PUB. 9-12-2006. FILED 7-7-2005.
- 3,176,414. **USX FCU (BLOCK FORM)**. USX FEDERAL CREDIT UNION, MULTIPLE CLASS, (INT. CLS. 35, 36 AND 42), (U.S. CLS. 100, 101 AND 102). SN 78-667,633. PUB. 9-12-2006. FILED 7-11-2005.
- 3,176,419. **BLOGEAGLE (BLOCK FORM)**. COREX TECHNOLOGIES AND SOLUTIONS INC., MULTIPLE CLASS, (INT. CLS. 35 AND 42), (U.S. CLS. 100, 101 AND 102). SN 78-668,099. PUB. 9-12-2006. FILED 7-12-2005.
- 3,176,421. **WORKING INCHORD (BLOCK FORM)**. INCHORD COMMUNICATIONS, INC., MULTIPLE CLASS, (INT. CLS. 35, 41 AND 42), (U.S. CLS. 100, 101, 102 AND 107). SN 78-668,891. PUB. 9-12-2006. FILED 7-12-2005.
- 3,176,425. **VALUE ANALYZER (BLOCK FORM)**. JULIE A. MARELLA, LLC, DBA MARELLA PROMOTION MARKETING, (U.S. CLS. 100, 101 AND 102). SN 78-670,587. PUB. 9-12-2006. FILED 7-14-2005.
- 3,176,440. **PROJECT SEARCH AND DESIGN**. CHILDREN'S HOSPITAL MEDICAL CENTER, MULTIPLE CLASS, (INT. CLS. 35 AND 41), (U.S. CLS. 100, 101, 102 AND 107). SN 78-684,342. PUB. 9-12-2006. FILED 8-3-2005.
- 3,176,454 (*See Class 9 for this trademark*).
- 3,176,475. **KOKI CLUB (BLOCK FORM)**. MIKUNI GINKO, LTD., (U.S. CLS. 100, 101 AND 102). SN 78-700,900. PUB. 9-12-2006. FILED 8-25-2005.
- 3,176,482. **WATER FEATURES YOU CAN SWIM IN (BLOCK FORM)**. RTR GROUP, INC., (U.S. CLS. 100, 101 AND 102). SN 78-703,987. PUB. 9-12-2006. FILED 8-31-2005.
- 3,176,485. **RG AND E ALWAYS AT YOUR SERVICE (BLOCK FORM)**. ROCHESTER GAS & ELECTRIC CORPORATION, MULTIPLE CLASS, (INT. CLS. 35 AND 39), (U.S. CLS. 100, 101, 102 AND 105). SN 78-704,341. PUB. 9-12-2006. FILED 8-31-2005.
- 3,176,496. **MISCELLANEOUS DESIGN**. DEEP SOUTH HOLDING, L.P., MULTIPLE CLASS, (INT. CLS. 35 AND 36), (U.S. CLS. 100, 101 AND 102). SN 78-710,197. PUB. 9-12-2006. FILED 9-9-2005.
- 3,176,497. **DEEP SOUTH (BLOCK FORM)**. DEEP SOUTH HOLDING, L.P., MULTIPLE CLASS, (INT. CLS. 35 AND 36), (U.S. CLS. 100, 101 AND 102). SN 78-710,206. PUB. 9-12-2006. FILED 9-9-2005.
- 3,176,502. **DREAMWOOD (BLOCK FORM)**. DREAMWOOD DESIGNS, INC., (U.S. CLS. 100, 101 AND 102). SN 78-711,742. PUB. 9-12-2006. FILED 9-13-2005.
- 3,176,504 (*See Class 16 for this trademark*).
- 3,176,505 (*See Class 9 for this trademark*).
- 3,176,508 (*See Class 9 for this trademark*).
- 3,176,514. **PEOPLE. PLACES. PIXELS. (BLOCK FORM)**. THE BARNYCZ GROUP, INC., MULTIPLE CLASS, (INT. CLS. 35 AND 42), (U.S. CLS. 100, 101 AND 102). SN 78-714,894. PUB. 9-12-2006. FILED 9-16-2005.
- 3,176,521. **CAMANA BAY (BLOCK FORM)**. CAYMAN SHORES DEVELOPMENT LIMITED, (U.S. CLS. 100, 101 AND 102). SN 78-716,782. PUB. 6-6-2006. FILED 9-20-2005.
- 3,176,525. **B BRAINBENCH EMPLOYMENT TESTING AND DESIGN**. BRAINBENCH, INC., (U.S. CLS. 100, 101 AND 102). SN 78-718,793. PUB. 9-12-2006. FILED 9-22-2005.
- 3,176,528. **M/PF YIELDSTAR (BLOCK FORM)**. REALPAGE, INC., MULTIPLE CLASS, (INT. CLS. 35 AND 42), (U.S. CLS. 100, 101 AND 102). SN 78-719,694. PUB. 9-12-2006. FILED 9-23-2005.
- 3,176,529 (*See Class 20 for this trademark*).
- 3,176,530. **HELPMWORK (BLOCK FORM)**. EWORK EX-

- CHANGE, INC., MULTIPLE CLASS, (INT. CLS. 35 AND 36), (U.S. CLS. 100, 101 AND 102). SN 78-720,855. PUB. 9-12-2006. FILED 9-26-2005.
- 3,176,543. **ICPA INTERNATIONAL COMPLIANCE PROFESSIONALS ASSOCIATION (BLOCK FORM)**. INTERNATIONAL COMPLIANCE PROFESSIONALS ASSOCIATION, MULTIPLE CLASS, (INT. CLS. 35 AND 42), (U.S. CLS. 100, 101 AND 102). SN 78-722,537. PUB. 9-12-2006. FILED 9-28-2005.
- 3,176,567. **ASHEVILLE ANY WAY YOU LIKE IT (STYLIZED)**. BUNCOMBE COUNTY TOURISM DEVELOPMENT AUTHORITY, (U.S. CLS. 100, 101 AND 102). SN 78-730,419. PUB. 9-12-2006. FILED 10-11-2005.
- 3,176,570. **AWARDS AND RECOGNITION ASSOCIATION (BLOCK FORM)**. AWARDS AND RECOGNITION ASSOCIATION, INC., (U.S. CLS. 100, 101 AND 102). SN 78-731,543. PUB. 9-12-2006. FILED 10-12-2005.
- 3,176,571. **GOLDEN PLAINS SOFTWARE (BLOCK FORM)**. GOLDEN PLAINS SOFTWARE, LLC., (U.S. CLS. 100, 101 AND 102). SN 78-733,886. PUB. 9-12-2006. FILED 10-14-2005.
- 3,176,573. **IMPERATIVES (BLOCK FORM)**. IMPERATIVES, LLC, (U.S. CLS. 100, 101 AND 102). SN 78-734,818. PUB. 9-12-2006. FILED 10-17-2005.
- 3,176,576. **SCANNERLINK (BLOCK FORM)**. SCANNER APPLICATIONS, INC., (U.S. CLS. 100, 101 AND 102). SN 78-735,874. PUB. 9-12-2006. FILED 10-19-2005.
- 3,176,577. **OPPORTUNITY FLORIDA AND DESIGN**. NORTHWEST FLORIDA BUSINESS DEVELOPMENT COUNCIL, INC., DBA OPPORTUNITY FLORIDA, (U.S. CLS. 100, 101 AND 102). SN 78-735,931. PUB. 9-12-2006. FILED 10-19-2005.
- 3,176,582. **KNOW TURNOVER (BLOCK FORM)**. IFRACTAL LLC, (U.S. CLS. 100, 101 AND 102). SN 78-738,607. PUB. 9-12-2006. FILED 10-22-2005.
- 3,176,587. **RECONNECT (BLOCK FORM)**. PARADYSZ MATERA CO., INC., (U.S. CLS. 100, 101 AND 102). SN 78-740,964. PUB. 9-12-2006. FILED 10-26-2005.
- 3,176,597. **BLADDER CANCER ADVOCACY NETWORK BCAN LEADING THE WAY TO AWARENESS AND A CURE AND DESIGN**. BLADDER CANCER ADVOCACY NETWORK, (U.S. CLS. 100, 101 AND 102). SN 78-745,315. PUB. 9-12-2006. FILED 11-2-2005.
- 3,176,620. **DREAMSTIME AND DESIGN**. JONES, JEFF A., (U.S. CLS. 100, 101 AND 102). SN 78-748,459. PUB. 9-12-2006. FILED 11-7-2005.
- 3,176,624. **AELMINGS (BLOCK FORM)**. AELMINGS, LLC, MULTIPLE CLASS, (INT. CLS. 35 AND 41), (U.S. CLS. 100, 101, 102 AND 107). SN 78-749,152. PUB. 9-12-2006. FILED 11-8-2005.
- 3,176,639. **PHARMASSURE TREND TRACK (BLOCK FORM)**. MCKESSON CORPORATION, (U.S. CLS. 100, 101 AND 102). SN 78-752,174. PUB. 9-12-2006. FILED 11-11-2005.
- 3,176,640. **INILEX (BLOCK FORM)**. INILEX, INC., MULTIPLE CLASS, (INT. CLS. 35 AND 45), (U.S. CLS. 100, 101 AND 102). SN 78-752,263. PUB. 9-12-2006. FILED 11-11-2005.
- 3,176,646. **GPI AND DESIGN**. GAMING PARTNERS INTERNATIONAL CORPORATION, (U.S. CLS. 100, 101 AND 102). SN 78-753,494. PUB. 9-12-2006. FILED 11-14-2005.
- 3,176,647. **LEAVE NO TOWN BEHIND (BLOCK FORM)**. AMDIAN ENTERPRISES LLC, (U.S. CLS. 100, 101 AND 102). SN 78-754,247. PUB. 9-12-2006. FILED 11-15-2005.
- 3,176,660. **NIMBIT (BLOCK FORM)**. NIMBIT, INC., MULTIPLE CLASS, (INT. CLS. 35, 38 AND 42), (U.S. CLS. 100, 101, 102 AND 104). SN 78-757,244. PUB. 9-12-2006. FILED 11-18-2005.
- 3,176,667. **LIVE WATER (BLOCK FORM)**. MEADE, MILLICENT, (U.S. CLS. 100, 101 AND 102). SN 78-758,041. PUB. 9-12-2006. FILED 11-21-2005.
- 3,176,669. **RD RICH DEVELOPMENT LLC AND DESIGN**. RICH DEVELOPMENT, LLC, (U.S. CLS. 100, 101 AND 102). SN 78-759,453. PUB. 9-12-2006. FILED 11-22-2005.
- 3,176,676. **ST. JOHNS COUNTY CHAMBER OF COMMERCE AND DESIGN**. ST. JOHNS COUNTY CHAMBER OF COMMERCE, INC., (U.S. CLS. 100, 101 AND 102). SN 78-762,183. PUB. 9-12-2006. FILED 11-29-2005.
- 3,176,681. **VISAIDS (BLOCK FORM)**. MAXI-AIDS, INC., (U.S. CLS. 100, 101 AND 102). SN 78-763,643. PUB. 9-12-2006. FILED 11-30-2005.
- 3,176,688. **THE CORRAL AND DESIGN**. CORRAL AT BRECKENRIDGE HOMEOWNERS ASSOCIATION, THE, (U.S. CLS. 100, 101 AND 102). SN 78-765,024. PUB. 9-12-2006. FILED 12-1-2005.
- 3,176,693. **THE POWER OF INDEPENDENTS (BLOCK FORM)**. WIT & CO., LTD., (U.S. CLS. 100, 101 AND 102). SN 78-765,784. PUB. 9-12-2006. FILED 12-2-2005.
- 3,176,697. **SALES GENIE (BLOCK FORM)**. INFOUSA, INC., (U.S. CLS. 100, 101 AND 102). SN 78-767,335. PUB. 9-12-2006. FILED 12-6-2005.
- 3,176,704. **MAXIAIDS.COM (BLOCK FORM)**. MAXI-AIDS, INC., (U.S. CLS. 100, 101 AND 102). SN 78-769,444. PUB. 9-12-2006. FILED 12-8-2005.
- 3,176,724. **C3 COLORECTAL CANCER COALITION AND DESIGN**. COLORECTAL CANCER COALITION, INC., (U.S. CLS. 100, 101 AND 102). SN 78-773,963. PUB. 9-12-2006. FILED 12-15-2005.
- 3,176,727. **NJPS (BLOCK FORM)**. UNITED JEWISH COMMUNITIES, INC., (U.S. CLS. 100, 101 AND 102). SN 78-774,138. PUB. 9-12-2006. FILED 12-15-2005.
- 3,176,732. **THE DIVERSITY NETWORK (BLOCK FORM)**. NETWORK DIVERSITY, LLC, (U.S. CLS. 100, 101 AND 102). SN 78-774,501. PUB. 9-12-2006. FILED 12-15-2005.
- 3,176,738. **ASSEMBLE FASTER, WORK BETTER AND LAST LONGER (BLOCK FORM)**. PRODUCT RISK REDUCTION, INC., (U.S. CLS. 100, 101 AND 102). SN 78-774,880. PUB. 9-12-2006. FILED 12-16-2005.
- 3,176,739. **SOLUTIONS DRIVEN ECONOMIC DEVELOPMENT (BLOCK FORM)**. LIBERTY COUNTY DEVELOPMENT AUTHORITY, (U.S. CLS. 100, 101 AND 102). SN 78-774,948. PUB. 9-12-2006. FILED 12-16-2005.
- 3,176,740. **SOLUTIONS BASED ECONOMIC DEVELOPMENT (BLOCK FORM)**. LIBERTY COUNTY DEVELOPMENT AUTHORITY, (U.S. CLS. 100, 101 AND 102). SN 78-775,027. PUB. 9-12-2006. FILED 12-16-2005.
- 3,176,750. **GOLF FOR CAUSE (BLOCK FORM)**. GOLF FOR CAUSE, L.L.C., MULTIPLE CLASS, (INT. CLS. 35 AND 41), (U.S. CLS. 100, 101, 102 AND 107). SN 78-775,896. PUB. 9-12-2006. FILED 12-19-2005.
- 3,176,751. **GOCITYKIDS (BLOCK FORM)**. VIACOM INTERNATIONAL INC., (U.S. CLS. 100, 101 AND 102). SN 78-776,127. PUB. 9-12-2006. FILED 12-19-2005.
- 3,176,764. **RETIRE-IT (BLOCK FORM)**. RETIRE-IT, LLC, (U.S. CLS. 100, 101 AND 102). SN 78-777,473. PUB. 9-12-2006. FILED 12-20-2005.
- 3,176,769. **CHARLEY BIGGS' CHICKEN N' SAUCE! CB AND DESIGN**. EQUITYTHINK, LLC, MULTIPLE CLASS, (INT. CLS. 35 AND 43), (U.S. CLS. 100, 101 AND 102). SN 78-777,893. PUB. 9-12-2006. FILED 12-21-2005.
- 3,176,777. **POPULAR INTELLIGENCE (BLOCK FORM)**. PRECISION REPORTS, INC., AND HONICK, CRAIG A., (U.S. CLS. 100, 101 AND 102). SN 78-778,847. PUB. 9-12-2006. FILED 12-22-2005.
- 3,176,798. **THE PERFECT LETTER (BLOCK FORM)**. THE PERFECT LETTER, INC., (U.S. CLS. 100, 101 AND 102). SN 78-780,027. PUB. 9-12-2006. FILED 12-23-2005.
- 3,176,800. **FIRST SHOTS (BLOCK FORM)**. NATIONAL SHOOTING SPORTS FOUNDATION, INC., (U.S. CLS. 100, 101 AND 102). SN 78-780,077. PUB. 9-12-2006. FILED 12-23-2005.
- 3,176,811. **BIZNIK (BLOCK FORM)**. BIZNIK LLC, (U.S. CLS. 100, 101 AND 102). SN 78-780,767. PUB. 9-12-2006. FILED 12-26-2005.
- 3,176,818. **GREAT AMERICAN DAYS AND DESIGN**. GREAT AMERICAN DAYS, INC., (U.S. CLS. 100, 101 AND 102). SN 78-781,281. PUB. 9-12-2006. FILED 12-27-2005.
- 3,176,822. **PLATO'S CLOSET (BLOCK FORM)**. WINMARK CORPORATION, (U.S. CLS. 100, 101 AND 102). SN 78-781,590. PUB. 9-12-2006. FILED 12-28-2005.
- 3,176,829. **IN TICKETING AND DESIGN**. WEISZ, STEPHEN B., MULTIPLE CLASS, (INT. CLS. 35 AND 41), (U.S. CLS. 100, 101, 102 AND 107). SN 78-782,066. PUB. 9-12-2006. FILED 12-29-2005.
- 3,176,831. **TIME RESURRECTED (BLOCK FORM)**. TIMEPIECES DIRECT INC., (U.S. CLS. 100, 101 AND 102). SN 78-782,244. PUB. 9-12-2006. FILED 12-29-2005.
- 3,176,856. **ONESHOP EXPRESS (BLOCK FORM)**. CORPORATE EXPRESS, INC., (U.S. CLS. 100, 101 AND 102). SN 78-783,882. PUB. 9-12-2006. FILED 1-3-2006.

- 3,176,864. **BRANDING FOR RESULTS (BLOCK FORM)**. MARKET2CUSTOMER LLC, (U.S. CLS. 100, 101 AND 102). SN 78-784,566. PUB. 9-12-2006. FILED 1-4-2006.
- 3,176,867 (*See Class 25 for this trademark*).
- 3,176,868. **PLASTERRIFIC! (BLOCK FORM)**. YVONNE'S PLASTER CRAFTS, INC., (U.S. CLS. 100, 101 AND 102). SN 78-784,827. PUB. 9-12-2006. FILED 1-4-2006.
- 3,176,874. **SEDONAWOLF (BLOCK FORM)**. LEO, MATTHEW R., (U.S. CLS. 100, 101 AND 102). SN 78-785,155. PUB. 9-12-2006. FILED 1-4-2006.
- 3,176,880. **FLUENT (BLOCK FORM)**. FLUENT, (U.S. CLS. 100, 101 AND 102). SN 78-785,434. PUB. 9-12-2006. FILED 1-5-2006.
- 3,176,881. **LUXURY IN ANY LANGUAGE (BLOCK FORM)**. FLUENT, (U.S. CLS. 100, 101 AND 102). SN 78-785,448. PUB. 9-12-2006. FILED 1-5-2006.
- 3,176,905. **SPAGUTS (BLOCK FORM)**. SPAS2ORDER.COM, (U.S. CLS. 100, 101 AND 102). SN 78-786,793. PUB. 9-12-2006. FILED 1-6-2006.
- 3,176,906. **NEW GUTS FOR OLD SPAS (BLOCK FORM)**. SPAS2ORDER.COM, (U.S. CLS. 100, 101 AND 102). SN 78-786,802. PUB. 9-12-2006. FILED 1-6-2006.
- 3,176,912. **N NATERE.US AND DESIGN**. NATERE USA INC, (U.S. CLS. 100, 101 AND 102). SN 78-786,952. PUB. 9-12-2006. FILED 1-6-2006.
- 3,176,921 (*See Class 16 for this trademark*).
- 3,176,928. **YOUR COMPLETE RELAXATION DESTINATION (BLOCK FORM)**. CLOUD NINE, (U.S. CLS. 100, 101 AND 102). SN 78-788,018. PUB. 9-12-2006. FILED 1-9-2006.
- 3,176,931. **LONG SHADOWS (BLOCK FORM)**. LONG SHADOWS VINTNERS LLC, (U.S. CLS. 100, 101 AND 102). SN 78-788,318. PUB. 9-12-2006. FILED 1-10-2006.
- 3,176,939. **VENISSIMO CHEESE AND DESIGN**. VENISSIMO CHEESE, INC., (U.S. CLS. 100, 101 AND 102). SN 78-788,768. PUB. 9-12-2006. FILED 1-10-2006.
- 3,176,947. **THE GOODY BAG AND DESIGN**. THE GOODY BAG LLC, (U.S. CLS. 100, 101 AND 102). SN 78-789,265. PUB. 9-12-2006. FILED 1-11-2006.
- 3,176,948. **DFA (BLOCK FORM)**. DUTY FREE AMERICAS, INC., (U.S. CLS. 100, 101 AND 102). SN 78-789,281. PUB. 9-12-2006. FILED 1-11-2006.
- 3,176,953. **COLLEGE TUTORS AND DESIGN**. COLLEGE NANNIES & TUTORS DEVELOPMENT, INC., (U.S. CLS. 100, 101 AND 102). SN 78-790,028. PUB. 9-12-2006. FILED 1-12-2006.
- 3,176,955. **COLLEGE NANNIES AND DESIGN**. COLLEGE NANNIES & TUTORS DEVELOPMENT, INC., (U.S. CLS. 100, 101 AND 102). SN 78-790,036. PUB. 9-12-2006. FILED 1-12-2006.
- 3,176,957. **BRIGHTHE (BLOCK FORM)**. E.N.K. PRODUCTIONS, LTD., DBA ENK INTERNATIONAL, (U.S. CLS. 100, 101 AND 102). SN 78-790,291. PUB. 9-12-2006. FILED 1-12-2006.
- 3,176,962. **ADMATCH (BLOCK FORM)**. ONMETA, INC., (U.S. CLS. 100, 101 AND 102). SN 78-790,903. PUB. 9-12-2006. FILED 1-12-2006.
- 3,176,964 (*See Class 8 for this trademark*).
- 3,176,965. **CODEXACT (BLOCK FORM)**. PARSES, INC., (U.S. CLS. 100, 101 AND 102). SN 78-791,058. PUB. 9-12-2006. FILED 1-13-2006.
- 3,176,971. **AMERICAN BOATING CENTERS AND DESIGN**. AMERICAN MARINE INC., MULTIPLE CLASS, (INT. CLS. 35 AND 39), (U.S. CLS. 100, 101, 102 AND 105). SN 78-791,115. PUB. 9-12-2006. FILED 1-13-2006.
- 3,176,974. **AVATAR (BLOCK FORM)**. RDSP I, L.P., (U.S. CLS. 100, 101 AND 102). SN 78-791,463. PUB. 9-12-2006. FILED 1-13-2006.
- 3,176,980. **GIVE YOUR MESSAGE SOME MOTION (BLOCK FORM)**. HIGHER AIM, INC., (U.S. CLS. 100, 101 AND 102). SN 78-791,773. PUB. 9-12-2006. FILED 1-13-2006.
- 3,176,993. **WHEN COMPATIBILITY COUNTS (BLOCK FORM)**. GREATLAND CORPORATION, DBA NELCO SOLUTIONS, (U.S. CLS. 100, 101 AND 102). SN 78-792,311. PUB. 9-12-2006. FILED 1-16-2006.
- 3,176,994. **SAFETYLEDERS (BLOCK FORM)**. HEALTH CARE CONCEPTS, INC., (U.S. CLS. 100, 101 AND 102). SN 78-792,420. PUB. 9-12-2006. FILED 1-16-2006.
- 3,176,997. **GEORGIA ORIGINALS AND DESIGN**. GEORGIA ORIGINALS, INC., (U.S. CLS. 100, 101 AND 102). SN 78-792,760. PUB. 9-12-2006. FILED 1-17-2006.
- 3,176,999. **CHESADACHS (BLOCK FORM)**. REED, MINDY, (U.S. CLS. 100, 101 AND 102). SN 78-792,814. PUB. 9-12-2006. FILED 1-17-2006.
- 3,177,004. **EMPYREAN (BLOCK FORM)**. THE EMPYREAN GROUP, LLC, MULTIPLE CLASS, (INT. CLS. 35, 36, 41 AND 42), (U.S. CLS. 100, 101, 102 AND 107). SN 78-792,879. PUB. 9-12-2006. FILED 1-17-2006.
- 3,177,014. **MYPROSELLER AND DESIGN**. MYPROSELLER, LLC, (U.S. CLS. 100, 101 AND 102). SN 78-793,281. PUB. 9-12-2006. FILED 1-17-2006.
- 3,177,022. **REBUIL (BLOCK FORM)**. LIN, GERARD, (U.S. CLS. 100, 101 AND 102). SN 78-793,496. PUB. 9-12-2006. FILED 1-18-2006.
- 3,177,023. **PROMOSSAGE (BLOCK FORM)**. LIN, GERARD, (U.S. CLS. 100, 101 AND 102). SN 78-793,497. PUB. 9-12-2006. FILED 1-18-2006.
- 3,177,024. **THENICEBUY (BLOCK FORM)**. LIN, GERARD, (U.S. CLS. 100, 101 AND 102). SN 78-793,499. PUB. 9-12-2006. FILED 1-18-2006.
- 3,177,027. **NICEMONEY (BLOCK FORM)**. LIN, GERARD, (U.S. CLS. 100, 101 AND 102). SN 78-793,516. PUB. 9-12-2006. FILED 1-18-2006.
- 3,177,031. **MISCELLANEOUS DESIGN**. SCRAP THERAPY, LLC, (U.S. CLS. 100, 101 AND 102). SN 78-793,695. PUB. 9-12-2006. FILED 1-18-2006.
- 3,177,032. **AWARE (BLOCK FORM)**. ADVANCING WOMEN IN AUTOMOTIVE RETAIL ENTERPRISES, LTD., (U.S. CLS. 100, 101 AND 102). SN 78-793,704. PUB. 9-12-2006. FILED 1-18-2006.
- 3,177,044. **1-877-LUMINEERS (BLOCK FORM)**. DEN-MAT CORPORATION, (U.S. CLS. 100, 101 AND 102). SN 78-793,954. PUB. 9-12-2006. FILED 1-18-2006.
- 3,177,052. **MYSPIFF.COM THE FASTLANE TO SUCCESS AND DESIGN**. MYSPIFF.COM LLC, (U.S. CLS. 100, 101 AND 102). SN 78-794,156. PUB. 9-12-2006. FILED 1-18-2006.
- 3,177,054. **DUCKIES DELIGHTS AND DESIGN**. HARVILL, JANE, (U.S. CLS. 100, 101 AND 102). SN 78-794,242. PUB. 9-12-2006. FILED 1-18-2006.
- 3,177,055. **HERCULES (BLOCK FORM)**. HERCULES VAN LINES INC., MULTIPLE CLASS, (INT. CLS. 35 AND 39), (U.S. CLS. 100, 101, 102 AND 105). SN 78-794,247. PUB. 9-12-2006. FILED 1-18-2006.
- 3,177,058. **AUTOHR (BLOCK FORM)**. SILVERADO MANAGEMENT GROUP, L.P., (U.S. CLS. 100, 101 AND 102). SN 78-794,308. PUB. 9-12-2006. FILED 1-18-2006.
- 3,177,074. **INSIGHT YOU CAN RUN WITH (BLOCK FORM)**. HONICK, CRAIG A., AND PRECISION REPORTS, INC., (U.S. CLS. 100, 101 AND 102). SN 78-794,813. PUB. 9-12-2006. FILED 1-19-2006.
- 3,177,084. **INTERNATIONAL FUND SERVICES (BLOCK FORM)**. STATE STREET CORPORATION, (U.S. CLS. 100, 101 AND 102). SN 78-795,084. PUB. 9-12-2006. FILED 1-19-2006.
- 3,177,085. **IFS (BLOCK FORM)**. STATE STREET CORPORATION, (U.S. CLS. 100, 101 AND 102). SN 78-795,112. PUB. 9-12-2006. FILED 1-19-2006.
- 3,177,087. **IFS INTERNATIONAL FUND SERVICES A STATE STREET COMPANY AND DESIGN**. STATE STREET CORPORATION, (U.S. CLS. 100, 101 AND 102). SN 78-795,156. PUB. 9-12-2006. FILED 1-19-2006.
- 3,177,091. **YOURSTORE.COM (BLOCK FORM)**. YOURSTORE, LLC, (U.S. CLS. 100, 101 AND 102). SN 78-795,513. PUB. 9-12-2006. FILED 1-20-2006.
- 3,177,107. **SERVICES THAT WORK TOGETHER FOR YOU (BLOCK FORM)**. BOOKSPAN, MULTIPLE CLASS, (INT. CLS. 35, 39 AND 41), (U.S. CLS. 100, 101, 102, 105 AND 107). SN 78-796,809. PUB. 9-12-2006. FILED 1-23-2006.
- 3,177,110. **AREA 51 (BLOCK FORM)**. AREA 51 INC., (U.S. CLS. 100, 101 AND 102). SN 78-797,028. PUB. 9-12-2006. FILED 1-23-2006.
- 3,177,113. **WHITE RABBIT GROUP (BLOCK FORM)**. WHITE RABBIT GROUP, LLC, (U.S. CLS. 100, 101 AND 102). SN 78-797,185. PUB. 9-12-2006. FILED 1-23-2006.
- 3,177,136 (*See Class 16 for this trademark*).
- 3,177,140. **THE NEXT GENERATION IN MEDICAL RISK MANAGEMENT (BLOCK FORM)**. AMERICAN INTERNA-

- TIONAL GROUP, INC., MULTIPLE CLASS, (INT. CLS. 35 AND 36), (U.S. CLS. 100, 101 AND 102). SN 78-803,320. PUB. 9-12-2006. FILED 1-31-2006.
- 3,177,155. **GETTING IT RIGHT. MAKING IT WORK. GETTING IT DONE. (BLOCK FORM)**. IMPERATIVES, LLC, (U.S. CLS. 100, 101 AND 102). SN 78-816,118. PUB. 9-12-2006. FILED 2-16-2006.
- 3,177,162. **SUAVA JAVA AND DESIGN**. CHEVRON INTELLECTUAL PROPERTY INC., (U.S. CLS. 100, 101 AND 102). SN 78-822,463. PUB. 9-12-2006. FILED 2-24-2006.
- 3,177,191 (*See Class 9 for this trademark*).
- 3,177,201. **R+ REGULANET REGULATORY AFFAIRS NETWORK AND DESIGN**. DR. REGENOLD GMBH INTERNATIONAL REGULATORY AFFAIRS, MULTIPLE CLASS, (INT. CLS. 35, 38 AND 42), (U.S. CLS. 100, 101, 102 AND 104). SN 79-008,461. PUB. 9-12-2006. FILED 10-28-2004.
- 3,177,204. **MEDIENFORUM.NRW AND DESIGN**. LANDESANSTALT FÜR MEDIEN ANSTALT DES ÖFFENTLICHEN RECHTS, MULTIPLE CLASS, (INT. CLS. 35, 38 AND 41), (U.S. CLS. 100, 101, 102, 104 AND 107). SN 79-009,333. PUB. 9-12-2006. FILED 1-18-2005.
- 3,177,211. **DUFRY (BLOCK FORM)**. DUFRY INTERNATIONAL AG (DUFRY INTERNATIONAL SA), (DUFRY INTERNATIONAL LTD), (U.S. CLS. 100, 101 AND 102). SN 79-010,781. PUB. 9-12-2006. FILED 5-12-2005.
- 3,177,214 (*See Class 1 for this trademark*).
- 3,177,215 (*See Class 9 for this trademark*).
- 3,177,218 (*See Class 9 for this trademark*).
- 3,177,233. **D (STYLIZED)**. DUFRY INTERNATIONAL AG (DUFRY INTERNATIONAL SA), (DUFRY INTERNATIONAL LTD), (U.S. CLS. 100, 101 AND 102). SN 79-012,845. PUB. 9-12-2006. FILED 6-28-2005.
- 3,177,266 (*See Class 9 for this trademark*).
- 3,177,271. **MARIA DUVAL (BLOCK FORM)**. MARIA DUVAL, MULTIPLE CLASS, (INT. CLS. 35 AND 45), (U.S. CLS. 100, 101 AND 102). SN 79-015,066. PUB. 9-12-2006. FILED 7-29-2005.
- 3,177,299 (*See Class 9 for this trademark*).
-
- CLASS 36—INSURANCE AND FINANCIAL**
- 3,175,762 (*See Class 3 for this trademark*).
- 3,175,768. **MAX BROOCK REALTORS**. REAL ESTATE ONE, INC., (U.S. CLS. 100, 101 AND 102). SN 76-399,070. PUB. 9-12-2006. FILED 4-19-2002.
- 3,175,769 (*See Class 35 for this trademark*).
- 3,175,783 (*See Class 16 for this trademark*).
- 3,175,784 (*See Class 16 for this trademark*).
- 3,175,815 (*See Class 9 for this trademark*).
- 3,175,829 (*See Class 9 for this trademark*).
- 3,175,830. **MISCELLANEOUS DESIGN**. PROVIDENT BANCORP, INC., DBA PROVIDENT BANK, (U.S. CLS. 100, 101 AND 102). SN 76-620,108. PUB. 9-12-2006. FILED 11-12-2004.
- 3,175,851. **MERRILL LYNCH TRADING DESK INTELLIGENCE (BLOCK FORM)**. MERRILL LYNCH & CO., INC., (U.S. CLS. 100, 101 AND 102). SN 76-640,453. PUB. 9-12-2006. FILED 6-8-2005.
- 3,175,857. **VANDENBERG THE TOWNHOUSE EXPERTS (BLOCK FORM)**. VANDENBERG, INC., (U.S. CLS. 100, 101 AND 102). SN 76-641,750. PUB. 9-12-2006. FILED 6-27-2005.
- 3,175,860. **HELPING MORE OF YOUR HOMEBUYERS QUALIFY FOR A HOME LOAN (BLOCK FORM)**. AMERIQUEST MORTGAGE COMPANY, (U.S. CLS. 100, 101 AND 102). SN 76-642,392. PUB. 9-12-2006. FILED 7-8-2005.
- 3,175,888 (*See Class 35 for this trademark*).
- 3,175,904. **APL SELECT DENTAL (BLOCK FORM)**. AMERICAN PUBLIC LIFE INSURANCE COMPANY, (U.S. CLS. 100, 101 AND 102). SN 76-652,366. PUB. 9-12-2006. FILED 12-22-2005.
- 3,175,919. **HRISYNERGIES (BLOCK FORM)**. CORPORATE SYNERGIES GROUP, INC., (U.S. CLS. 100, 101 AND 102). SN 76-652,966. PUB. 9-12-2006. FILED 1-5-2006.
- 3,175,950 (*See Class 9 for this trademark*).
- 3,175,973 (*See Class 35 for this trademark*).
- 3,175,977. **CCCS AND DESIGN**. MONEY MANAGEMENT INTERNATIONAL, INC., MULTIPLE CLASS, (INT. CLS. 36 AND 41), (U.S. CLS. 100, 101, 102 AND 107). SN 78-379,670. PUB. 9-12-2006. FILED 3-5-2004.
- 3,175,983 (*See Class 9 for this trademark*).
- 3,175,992. **CREDITLOCK (BLOCK FORM)**. ABN AMRO MANAGEMENT SERVICES LIMITED, (U.S. CLS. 100, 101 AND 102). SN 78-411,173. PUB. 9-12-2006. FILED 4-30-2004.
- 3,175,998 (*See Class 35 for this trademark*).
- 3,176,000. **SEKURCAP (BLOCK FORM)**. SEKURCAP INTERNATIONAL INVESTMENTS INC., (U.S. CLS. 100, 101 AND 102). SN 78-432,457. PUB. 9-12-2006. FILED 6-9-2004.
- 3,176,016. **WE ARE ENGAGED 24.7.365 (BLOCK FORM)**. JMB INSURANCE AGENCY, INC., (U.S. CLS. 100, 101 AND 102). SN 78-453,638. PUB. 9-12-2006. FILED 7-20-2004.
- 3,176,018. **CREATE THE VISION (BLOCK FORM)**. ING NORTH AMERICA INSURANCE CORPORATION, (U.S. CLS. 100, 101 AND 102). SN 78-458,470. PUB. 9-12-2006. FILED 7-28-2004.
- 3,176,042. **M (STYLIZED)**. MEMORIAL CITY MALL, LP, (U.S. CLS. 100, 101 AND 102). SN 78-494,709. PUB. 9-12-2006. FILED 10-5-2004.
- 3,176,049 (*See Class 35 for this trademark*).
- 3,176,066 (*See Class 25 for this trademark*).
- 3,176,070. **THE APARTMENT DEPARTMENT (BLOCK FORM)**. BLAKE-CALVERT, COLLEEN, (U.S. CLS. 100, 101 AND 102). SN 78-522,210. PUB. 9-12-2006. FILED 11-23-2004.
- 3,176,072. **PERSONAL IQ (BLOCK FORM)**. LIBERTY MUTUAL INSURANCE COMPANY, (U.S. CLS. 100, 101 AND 102). SN 78-523,819. PUB. 9-12-2006. FILED 11-29-2004.
- 3,176,075. **ACUPOINT (BLOCK FORM)**. KPMG LLP, MULTIPLE CLASS, (INT. CLS. 36 AND 41), (U.S. CLS. 100, 101, 102 AND 107). SN 78-525,041. PUB. 9-12-2006. FILED 12-1-2004.
- 3,176,083. **MONDRIAN INVESTMENT PARTNERS (BLOCK FORM)**. MONDRIAN INVESTMENT PARTNERS LIMITED, (U.S. CLS. 100, 101 AND 102). SN 78-529,655. PUB. 9-12-2006. FILED 12-9-2004.
- 3,176,092 (*See Class 14 for this trademark*).
- 3,176,096. **ABACUS MERCHANT SERVICES AND DESIGN**. TEKNOR, INC., (U.S. CLS. 100, 101 AND 102). SN 78-543,806. PUB. 9-12-2006. FILED 1-7-2005.
- 3,176,104. **NEW YORK MERCANTILE EXCHANGE - EUROPE (BLOCK FORM)**. NEW YORK MERCANTILE EXCHANGE, INC., MULTIPLE CLASS, (INT. CLS. 36 AND 42), (U.S. CLS. 100, 101 AND 102). SN 78-552,613. PUB. 9-12-2006. FILED 1-24-2005.
- 3,176,107. **THE PRODUCERS CHOICE, INC. (BLOCK FORM)**. PRODUCERS CHOICE, INC., (U.S. CLS. 100, 101 AND 102). SN 78-553,434. PUB. 6-6-2006. FILED 1-25-2005.
- 3,176,122. **CHILDREN WITH HAIRLOSS AND DESIGN**. CHILDREN WITH HAIR LOSS, INC., (U.S. CLS. 100, 101 AND 102). SN 78-564,489. PUB. 9-12-2006. FILED 2-10-2005.
- 3,176,131. **UNCOVERING OPPORTUNITIES (BLOCK FORM)**. NEUMAN, BILL D., (U.S. CLS. 100, 101 AND 102). SN 78-574,426. PUB. 9-12-2006. FILED 2-24-2005.
- 3,176,178. **FARR FINANCIAL (BLOCK FORM)**. FARR FINANCIAL INC., (U.S. CLS. 100, 101 AND 102). SN 78-602,784. PUB. 9-12-2006. FILED 4-6-2005.
- 3,176,181. **E-VIEW ADVANCED STRATEGIES (BLOCK FORM)**. MESIROW ADVANCED STRATEGIES, INC., (U.S. CLS. 100, 101 AND 102). SN 78-603,824. PUB. 9-12-2006. FILED 4-7-2005.
- 3,176,201. **ED&F MAN (STYLIZED)**. ED & F MAN HOLDINGS LIMITED, (U.S. CLS. 100, 101 AND 102). SN 78-610,947. PUB. 9-12-2006. FILED 4-18-2005.
- 3,176,206 (*See Class 35 for this trademark*).
- 3,176,209 (*See Class 35 for this trademark*).
- 3,176,230. **KWIKBINDER.COM (BLOCK FORM)**. KWIKBINDER.COM, LLC, (U.S. CLS. 100, 101 AND 102). SN 78-624,988. PUB. 9-12-2006. FILED 5-6-2005.
- 3,176,239 (*See Class 35 for this trademark*).
- 3,176,264. **THE CONDO GUY (BLOCK FORM)**. KRUSE, ROBERT L., (U.S. CLS. 100, 101 AND 102). SN 78-630,133. PUB. 9-12-2006. FILED 5-15-2005.
- 3,176,266. **WHAT GETS MEASURED GETS MANAGED (BLOCK FORM)**. GLOBAL TRADING ANALYTICS LLC, (U.S. CLS. 100, 101 AND 102). SN 78-630,273. PUB. 9-12-2006. FILED 5-16-2005.

- 3,176,267. **RATINGS EXPLORER (BLOCK FORM)**. THE BEAR STEARNS COMPANIES INC., (U.S. CLS. 100, 101 AND 102). SN 78-630,365. PUB. 9-12-2006. FILED 5-16-2005.
- 3,176,292. **PCG (BLOCK FORM)**. PACIFIC CORPORATE GROUP HOLDINGS, LLC, (U.S. CLS. 100, 101 AND 102). SN 78-635,494. PUB. 9-12-2006. FILED 5-23-2005.
- 3,176,293. **MADISON FINANCIAL PARTNERS AND DESIGN**. MADISON FINANCIAL PARTNERS, LLC, (U.S. CLS. 100, 101 AND 102). SN 78-635,778. PUB. 9-12-2006. FILED 5-24-2005.
- 3,176,295 (*See Class 35 for this trademark*).
- 3,176,309. **THE CORNERSTONE GROUP (BLOCK FORM)**. THE CORNERSTONE GROUP, L.L.C., (U.S. CLS. 100, 101 AND 102). SN 78-638,959. PUB. 9-12-2006. FILED 5-27-2005.
- 3,176,341. **THE CENTER FOR INDUSTRY & COMMERCE AND DESIGN**. T. WALL PROPERTIES MANAGEMENT CORP., MULTIPLE CLASS, (INT. CLS. 36 AND 37), (U.S. CLS. 100, 101, 102, 103 AND 106). SN 78-646,307. PUB. 9-12-2006. FILED 6-8-2005.
- 3,176,349 (*See Class 35 for this trademark*).
- 3,176,376. **NORTH COUNTRY FUNDS (BLOCK FORM)**. NORTH COUNTRY INVESTMENT ADVISORS, INC., (U.S. CLS. 100, 101 AND 102). SN 78-656,920. PUB. 9-12-2006. FILED 6-23-2005.
- 3,176,379 (*See Class 16 for this trademark*).
- 3,176,388. **SUMMER BAY RESORTS AND DESIGN**. SUMMER BAY PARTNERSHIP, (U.S. CLS. 100, 101 AND 102). SN 78-659,576. PUB. 9-12-2006. FILED 6-28-2005.
- 3,176,389. **TSG CONSUMER PARTNERS (BLOCK FORM)**. TSG CONSUMER PARTNERS, LLC, (U.S. CLS. 100, 101 AND 102). SN 78-659,683. PUB. 9-12-2006. FILED 6-28-2005.
- 3,176,391. **THE KOOPER GROUP (BLOCK FORM)**. GALLAGHER BENEFIT SERVICES, INC., (U.S. CLS. 100, 101 AND 102). SN 78-659,870. PUB. 9-12-2006. FILED 6-28-2005.
- 3,176,414 (*See Class 35 for this trademark*).
- 3,176,458. **FIVE STAR REAL ESTATE AND DESIGN**. FIVE STAR REAL ESTATE, LLC, (U.S. CLS. 100, 101 AND 102). SN 78-692,661. PUB. 9-12-2006. FILED 8-15-2005.
- 3,176,461. **HARVE (BLOCK FORM)**. BENEFIT PLANS ADMINISTRATIVE SERVICES, INC., (U.S. CLS. 100, 101 AND 102). SN 78-694,729. PUB. 9-12-2006. FILED 8-17-2005.
- 3,176,464. **AMLLOC (BLOCK FORM)**. L'HEUREUX, LARRY, AND HARRISON, JOHN, (U.S. CLS. 100, 101 AND 102). SN 78-694,745. PUB. 9-12-2006. FILED 8-17-2005.
- 3,176,468. **CANYON COUNTRY PLAZA (BLOCK FORM)**. CANYON COUNTRY PLAZA, L.P., (U.S. CLS. 100, 101 AND 102). SN 78-696,873. PUB. 9-12-2006. FILED 8-19-2005.
- 3,176,479. **LEADERSHIP ST. LOUIS (BLOCK FORM)**. FOCUS ST. LOUIS, MULTIPLE CLASS, (INT. CLS. 36 AND 41), (U.S. CLS. 100, 101, 102 AND 107). SN 78-703,202. PUB. 9-12-2006. FILED 8-30-2005.
- 3,176,484. **CAMICO MUTUAL INSURANCE COMPANY (BLOCK FORM)**. CAMICO MUTUAL INSURANCE COMPANY, (U.S. CLS. 100, 101 AND 102). SN 78-704,321. PUB. 9-12-2006. FILED 8-31-2005.
- 3,176,486. **HOT REALTY (BLOCK FORM)**. WALLEN, JEFF, AND WALLEN, JENNIFER, (U.S. CLS. 100, 101 AND 102). SN 78-704,710. PUB. 9-12-2006. FILED 8-31-2005.
- 3,176,496 (*See Class 35 for this trademark*).
- 3,176,497 (*See Class 35 for this trademark*).
- 3,176,508 (*See Class 9 for this trademark*).
- 3,176,527. **R AIRCRAFTPOST.COM AND DESIGN**. THE ROUSSEAU COMPANY, INC., (U.S. CLS. 100, 101 AND 102). SN 78-719,619. PUB. 9-12-2006. FILED 9-23-2005.
- 3,176,530 (*See Class 35 for this trademark*).
- 3,176,554. **CAMPUS ASSIST (BLOCK FORM)**. SALLIE MAE, INC., (U.S. CLS. 100, 101 AND 102). SN 78-725,853. PUB. 9-12-2006. FILED 10-4-2005.
- 3,176,558. **OUR EXPERIENCE. YOUR ADVANTAGE. (BLOCK FORM)**. ADVANTAGE WORKERS COMPENSATION INSURANCE COMPANY, (U.S. CLS. 100, 101 AND 102). SN 78-727,813. PUB. 9-12-2006. FILED 10-6-2005.
- 3,176,564. **CASHCORP (BLOCK FORM)**. JACHIMEK, WILLIAM G, (U.S. CLS. 100, 101 AND 102). SN 78-729,559. PUB. 9-12-2006. FILED 10-9-2005.
- 3,176,589. **SMARTRANK SCORECARDS (BLOCK FORM)**. SABRIENT SYSTEMS LLC, (U.S. CLS. 100, 101 AND 102). SN 78-742,558. PUB. 9-12-2006. FILED 10-28-2005.
- 3,176,592. **CAPITALSOUTH AND DESIGN**. CAPITALSOUTH BANCORP, (U.S. CLS. 100, 101 AND 102). SN 78-744,207. PUB. 9-12-2006. FILED 11-1-2005.
- 3,176,605. **COMMONFUND ALLOCATION PLANNING MODEL (BLOCK FORM)**. THE COMMONFUND FOR NON-PROFIT ORGANIZATIONS, (U.S. CLS. 100, 101 AND 102). SN 78-746,578. PUB. 9-12-2006. FILED 11-3-2005.
- 3,176,609. **DEAN BANK (BLOCK FORM)**. DEAN COOPERATIVE BANK, (U.S. CLS. 100, 101 AND 102). SN 78-747,462. PUB. 9-12-2006. FILED 11-4-2005.
- 3,176,611. **AGCO FINANCE AND DESIGN**. AGCO CORPORATION, (U.S. CLS. 100, 101 AND 102). SN 78-747,749. PUB. 9-12-2006. FILED 11-4-2005.
- 3,176,623. **FINANCIAL LIABILITY EQUALIZER (BLOCK FORM)**. PROFESSIONAL LIABILITY MANAGEMENT OF AMERICA, INC., (U.S. CLS. 100, 101 AND 102). SN 78-749,129. PUB. 9-12-2006. FILED 11-8-2005.
- 3,176,625. **B-FREE (BLOCK FORM)**. FREMONT BANK, (U.S. CLS. 100, 101 AND 102). SN 78-749,161. PUB. 9-12-2006. FILED 11-8-2005.
- 3,176,626. **MISCELLANEOUS DESIGN**. FEDERAL RESERVE BANK OF KANSAS CITY, (U.S. CLS. 100, 101 AND 102). SN 78-749,225. PUB. 9-12-2006. FILED 11-8-2005.
- 3,176,644. **BLUEPOINTE PROPERTY GROUP (BLOCK FORM)**. BLUEPOINTE PROPERTY GROUP LLC, (U.S. CLS. 100, 101 AND 102). SN 78-752,815. PUB. 9-12-2006. FILED 11-13-2005.
- 3,176,668. **MÉRITÂGE PORTFOLIO MANAGEMENT (BLOCK FORM)**. MÉRITÂGE PORTFOLIO MANAGEMENT, INC., (U.S. CLS. 100, 101 AND 102). SN 78-758,911. PUB. 9-12-2006. FILED 11-22-2005.
- 3,176,692. **MINNESOTA BUILDING TRADES FEDERAL CREDIT UNION AND DESIGN**. MINNESOTA BUILDING TRADES FEDERAL CREDIT UNION, (U.S. CLS. 100, 101 AND 102). SN 78-765,711. PUB. 9-12-2006. FILED 12-2-2005.
- 3,176,706. **AEROSPACE PLANNING GROUP AND DESIGN**. MILLER, ANDREW, DAVID, (U.S. CLS. 100, 101 AND 102). SN 78-769,576. PUB. 9-12-2006. FILED 12-8-2005.
- 3,176,714. **FROM SEA TO TEE (BLOCK FORM)**. CANDITO, PATRICIA, MULTIPLE CLASS, (INT. CLS. 36 AND 45), (U.S. CLS. 100, 101 AND 102). SN 78-772,392. PUB. 9-12-2006. FILED 12-13-2005.
- 3,176,723. **MARKET LISTENER (BLOCK FORM)**. LISTENING PARTNERS, LLC, (U.S. CLS. 100, 101 AND 102). SN 78-773,914. PUB. 9-12-2006. FILED 12-15-2005.
- 3,176,725. **NOREO (BLOCK FORM)**. UGLYMORTGAGES, INC., (U.S. CLS. 100, 101 AND 102). SN 78-773,976. PUB. 9-12-2006. FILED 12-15-2005.
- 3,176,729. **HELPING PUBLIC EDUCATION THRIVE (BLOCK FORM)**. CHARTER FUND, INC., (U.S. CLS. 100, 101 AND 102). SN 78-774,320. PUB. 9-12-2006. FILED 12-15-2005.
- 3,176,742. **WE TAKE BANKING TO HEART. (BLOCK FORM)**. THE ADIRONDACK TRUST COMPANY, (U.S. CLS. 100, 101 AND 102). SN 78-775,226. PUB. 9-12-2006. FILED 12-16-2005.
- 3,176,743. **AT AND DESIGN**. THE ADIRONDACK TRUST COMPANY, (U.S. CLS. 100, 101 AND 102). SN 78-775,381. PUB. 9-12-2006. FILED 12-16-2005.
- 3,176,784. **J JOHN T. PETERS FOUNDATION AND DESIGN**. THE JOHN T. PETERS FOUNDATION, (U.S. CLS. 100, 101 AND 102). SN 78-779,234. PUB. 9-12-2006. FILED 12-22-2005.
- 3,176,794. **MICRO-SECURITIZATION (BLOCK FORM)**. BAYVIEW FINANCIAL, L.P., (U.S. CLS. 100, 101 AND 102). SN 78-779,620. PUB. 9-12-2006. FILED 12-22-2005.
- 3,176,819. **PROPHET (BLOCK FORM)**. PROPHET FINANCIAL SYSTEMS, INC., (U.S. CLS. 100, 101 AND 102). SN 78-781,290. PUB. 9-12-2006. FILED 12-27-2005.
- 3,176,848. **PUT A BAD BEAT ON CANCER (BLOCK FORM)**. CANCER RESEARCH AND PREVENTION FOUNDATION, (U.S. CLS. 100, 101 AND 102). SN 78-783,152. PUB. 9-12-2006. FILED 12-30-2005.
- 3,176,858. **POWERRATINGS (BLOCK FORM)**. THE CONNORS GROUP, INC., (U.S. CLS. 100, 101 AND 102). SN 78-784,401. PUB. 9-12-2006. FILED 1-3-2006.
- 3,176,892. **FOR THOSE WITH HIGHER EXPECTATIONS (BLOCK FORM)**. CAPITAL PACIFIC, LLC, (U.S. CLS. 100, 101 AND 102). SN 78-786,032. PUB. 9-12-2006. FILED 1-5-

- 2006.
- 3,176,901. **WE RESCUE INVESTORS FROM THEIR BROTHERS (BLOCK FORM)**. JJM FINANCIAL STRATEGIES, INC., (U.S. CLS. 100, 101 AND 102). SN 78-786,360. PUB. 9-12-2006. FILED 1-6-2006.
- 3,176,910. **NEW ENGLAND COMP ADVISORS AND DESIGN**. HOMETOWN ALLIANCE INSURANCE AGENCY, LLC, (U.S. CLS. 100, 101 AND 102). SN 78-786,935. PUB. 9-12-2006. FILED 1-6-2006.
- 3,176,937. **WAUCONDA COMMUNITY BANK (BLOCK FORM)**. LIBERTYVILLE BANK & TRUST COMPANY, (U.S. CLS. 100, 101 AND 102). SN 78-788,711. PUB. 9-12-2006. FILED 1-10-2006.
- 3,176,945. **M AND DESIGN**. THE MORTGAGE STORE FINANCIAL, INC., (U.S. CLS. 100, 101 AND 102). SN 78-789,256. PUB. 9-12-2006. FILED 1-11-2006.
- 3,176,952. **INTELLI-LEAD TECHNOLOGY (BLOCK FORM)**. IFMG-IP, LLC, MULTIPLE CLASS, (INT. CLS. 36 AND 42), (U.S. CLS. 100, 101 AND 102). SN 78-789,494. PUB. 9-12-2006. FILED 1-11-2006.
- 3,176,972. **POWERQUOTE (BLOCK FORM)**. QUOMATION INSURANCE SERVICES, INC., (U.S. CLS. 100, 101 AND 102). SN 78-791,156. PUB. 9-12-2006. FILED 1-13-2006.
- 3,177,004 (*See Class 35 for this trademark*).
- 3,177,008. **MONU-MATIC (BLOCK FORM)**. MONUMENTAL LIFE INSURANCE COMPANY, (U.S. CLS. 100, 101 AND 102). SN 78-793,023. PUB. 9-12-2006. FILED 1-17-2006.
- 3,177,063. **STEP WITH HOPE (BLOCK FORM)**. STEP WITH HOPE, (U.S. CLS. 100, 101 AND 102). SN 78-794,550. PUB. 9-12-2006. FILED 1-19-2006.
- 3,177,089. **MISCELLANEOUS DESIGN**. TUMTUM TREE FOUNDATION, (U.S. CLS. 100, 101 AND 102). SN 78-795,464. PUB. 9-12-2006. FILED 1-20-2006.
- 3,177,092. **A ACH ADVANTAGE AND DESIGN**. NATIONAL PAYMENT CORPORATION, (U.S. CLS. 100, 101 AND 102). SN 78-795,616. PUB. 9-12-2006. FILED 1-20-2006.
- 3,177,105. **WE'LL JUMP THROUGH HOOPS FOR YOU! (BLOCK FORM)**. EVRAIFF, GLORIA M. AND EVRAIFF, DAVID, (U.S. CLS. 100, 101 AND 102). SN 78-796,528. PUB. 9-12-2006. FILED 1-21-2006.
- 3,177,117. **RALLY-BASE-RALLY RBR (BLOCK FORM)**. THE SCIENTIFIC INVESTOR LLC, (U.S. CLS. 100, 101 AND 102). SN 78-797,404. PUB. 9-12-2006. FILED 1-23-2006.
- 3,177,119. **B-PIPE (BLOCK FORM)**. BLOOMBERG L.P., (U.S. CLS. 100, 101 AND 102). SN 78-797,484. PUB. 9-12-2006. FILED 1-23-2006.
- 3,177,131. **EZMONEYMOVER (STYLIZED)**. NATIONAL PAYMENT CORPORATION, (U.S. CLS. 100, 101 AND 102). SN 78-798,749. PUB. 9-12-2006. FILED 1-25-2006.
- 3,177,140 (*See Class 35 for this trademark*).
- 3,177,141. **THE STRENGTH TO BE THERE (BLOCK FORM)**. AMERICAN INTERNATIONAL GROUP, INC., (U.S. CLS. 100, 101 AND 102). SN 78-804,044. PUB. 9-12-2006. FILED 2-1-2006.
- 3,177,214 (*See Class 1 for this trademark*).
- 3,177,218 (*See Class 9 for this trademark*).
- CLS. 100, 103 AND 106). SN 76-649,818. PUB. 9-12-2006. FILED 11-4-2005.
- 3,175,895. **OAKLEAF WASTE OUTSOURCING DONE RIGHT AND DESIGN**. OAKLEAF WASTE MANAGEMENT, INC., MULTIPLE CLASS, (INT. CLS. 37 AND 39), (U.S. CLS. 100, 103, 105 AND 106). SN 76-651,004. PUB. 9-12-2006. FILED 11-28-2005.
- 3,175,925. **TYPE II SYSTEM (BLOCK FORM)**. DAVIS, ROBERT J, (U.S. CLS. 100, 103 AND 106). SN 76-653,235. PUB. 9-12-2006. FILED 1-11-2006.
- 3,175,952. **E & H RESTORATION, L.L.C. ENGINEERS - CONTRACTORS AND DESIGN**. E & H RESTORATION L.L.C., (U.S. CLS. 100, 103 AND 106). SN 78-254,399. PUB. 9-12-2006. FILED 5-27-2003.
- 3,175,990 (*See Class 35 for this trademark*).
- 3,176,047. **A AND DESIGN**. EXECUTIVE AIR SUPPORT, INC., MULTIPLE CLASS, (INT. CLS. 37 AND 39), (U.S. CLS. 100, 103, 105 AND 106). SN 78-496,783. PUB. 9-12-2006. FILED 10-8-2004.
- 3,176,100 (*See Class 35 for this trademark*).
- 3,176,101. **GEORGE P. MARIS WORLD CLASS INSTALLATIONS AND SERVICE AND DESIGN**. GPM & KLM, INC., (U.S. CLS. 100, 103 AND 106). SN 78-549,118. PUB. 9-12-2006. FILED 1-18-2005.
- 3,176,120 (*See Class 3 for this trademark*).
- 3,176,149. **KNEPP INCORPORATED AND DESIGN**. KNEPP INCORPORATED, MULTIPLE CLASS, (INT. CLS. 37 AND 40), (U.S. CLS. 100, 103 AND 106). SN 78-588,704. PUB. 9-12-2006. FILED 3-16-2005.
- 3,176,156. **NATIONAL HOME IMPROVEMENT, INC. AND DESIGN**. NATIONAL HOME IMPROVEMENT, INC., (U.S. CLS. 100, 103 AND 106). SN 78-594,839. PUB. 9-12-2006. FILED 3-24-2005.
- 3,176,165. **C CONTI AND DESIGN**. CONTI, KURT G., MULTIPLE CLASS, (INT. CLS. 37, 39, 40 AND 42), (U.S. CLS. 100, 101, 103, 105 AND 106). SN 78-598,599. PUB. 9-12-2006. FILED 3-30-2005.
- 3,176,174. **SERVICEMASTER (BLOCK FORM)**. SERVICE-MASTER BRANDS L.L.C., (U.S. CLS. 100, 103 AND 106). SN 78-600,872. PUB. 9-12-2006. FILED 4-4-2005.
- 3,176,189 (*See Class 6 for this trademark*).
- 3,176,253 (*See Class 35 for this trademark*).
- 3,176,263 (*See Class 7 for this trademark*).
- 3,176,297. **IRONED OUT & ABOUT (BLOCK FORM)**. I.O.A. HOLDINGS, LLC, (U.S. CLS. 100, 103 AND 106). SN 78-636,489. PUB. 9-12-2006. FILED 5-24-2005.
- 3,176,311. **DON'T SLIP ~ GET A GRIP! (BLOCK FORM)**. LONG FENCE COMPANY, INC., (U.S. CLS. 100, 103 AND 106). SN 78-639,048. PUB. 9-12-2006. FILED 5-27-2005.
- 3,176,341 (*See Class 36 for this trademark*).
- 3,176,349 (*See Class 35 for this trademark*).
- 3,176,454 (*See Class 9 for this trademark*).
- 3,176,559. **KING FENCES (BLOCK FORM)**. CIPS FENCE CO., INC., MULTIPLE CLASS, (INT. CLS. 37 AND 40), (U.S. CLS. 100, 103 AND 106). SN 78-728,185. PUB. 9-12-2006. FILED 10-6-2005.
- 3,176,578. **ROCK STARS AND MUSCLE CARS (BLOCK FORM)**. JONES, LANCE, (U.S. CLS. 100, 103 AND 106). SN 78-736,822. PUB. 9-12-2006. FILED 10-20-2005.
- 3,176,581. **RED CANYON COMPANY (BLOCK FORM)**. RED CANYON COMPANY, (U.S. CLS. 100, 103 AND 106). SN 78-737,259. PUB. 9-12-2006. FILED 10-20-2005.
- 3,176,584. **TH CONSTRUCTION OF ANOKA, INC. (STYLIZED)**. T. H. CONSTRUCTION OF ANOKA, INC., (U.S. CLS. 100, 103 AND 106). SN 78-740,102. PUB. 9-12-2006. FILED 10-25-2005.
- 3,176,613. **MISCELLANEOUS DESIGN**. CORNERSTONE BUILDING ANALYSIS, INC., (U.S. CLS. 100, 103 AND 106). SN 78-747,879. PUB. 9-12-2006. FILED 11-5-2005.
- 3,176,636. **V FINE HOMES (BLOCK FORM)**. V FINE HOMES LP, (U.S. CLS. 100, 103 AND 106). SN 78-751,509. PUB. 9-12-2006. FILED 11-10-2005.
- 3,176,643. **CUSTOM SEALCOATING INC. AND DESIGN**. GLICK, LAWRENCE S., (U.S. CLS. 100, 103 AND 106). SN 78-752,758. PUB. 9-12-2006. FILED 11-13-2005.
- 3,176,655. **HC HARCHUCK CONSTRUCTION (STYLIZED)**. HARCHUCK CONSTRUCTION INC., (U.S. CLS. 100, 103 AND 106). SN 78-755,877. PUB. 9-12-2006. FILED 11-17-2005.

CLASS 37—CONSTRUCTION AND REPAIR

- 3,175,761 (*See Class 35 for this trademark*).
- 3,175,792 (*See Class 6 for this trademark*).
- 3,175,794 (*See Class 7 for this trademark*).
- 3,175,814. **TONERTIGER AND DESIGN**. TONERTIGER, INC., (U.S. CLS. 100, 103 AND 106). SN 76-604,958. PUB. 11-8-2005. FILED 8-2-2004.
- 3,175,816 (*See Class 7 for this trademark*).
- 3,175,831 (*See Class 7 for this trademark*).
- 3,175,835. **LEMP ST. LOUIS. AND DESIGN**. HISTORIC LEMP BREWERY, LLC., (U.S. CLS. 100, 103 AND 106). SN 76-635,135. PUB. 9-12-2006. FILED 4-4-2005.
- 3,175,866. **GET THE DOOR! IT'S YOUR DOOR ONLY BETTER (STYLIZED)**. GET THE DOOR, (U.S. CLS. 100, 103 AND 106). SN 76-644,063. PUB. 9-12-2006. FILED 8-2-2005.
- 3,175,890. **SUPERIOR WASH THE TRUCK WASH PEOPLE (BLOCK FORM)**. SUPERIOR WASH, INC. OF U.S.A., (U.S.

- 3,176,695. **ARETÉ 3 LTD (BLOCK FORM)**. ARETE 3 LTD., MULTIPLE CLASS, (INT. CLS. 37 AND 42), (U.S. CLS. 100, 101, 103 AND 106). SN 78-766,888. PUB. 9-12-2006. FILED 12-5-2005.
- 3,176,696. **LL AND DESIGN**. ARETE 3 LTD., MULTIPLE CLASS, (INT. CLS. 37 AND 42), (U.S. CLS. 100, 101, 103 AND 106). SN 78-766,893. PUB. 9-12-2006. FILED 12-5-2005.
- 3,176,703. **TEMPROL HEATING & A/C, INC. AND DESIGN**. TEMPROL HEATING & COOLING INC., (U.S. CLS. 100, 103 AND 106). SN 78-768,911. PUB. 9-12-2006. FILED 12-7-2005.
- 3,176,760. **WE WORK ON SATISFACTION, NOT COMMITMENT (BLOCK FORM)**. ASHLAND LICENSING AND INTELLECTUAL PROPERTY LLC, (U.S. CLS. 100, 103 AND 106). SN 78-777,177. PUB. 9-12-2006. FILED 12-20-2005.
- 3,176,768. **76 (BLOCK FORM)**. CONOCOPHILLIPS COMPANY, (U.S. CLS. 100, 103 AND 106). SN 78-777,891. PUB. 9-12-2006. FILED 12-21-2005.
- 3,176,875. **EXPRESS PLUMBERS AND DESIGN**. EXPRESS PLUMBERS, (U.S. CLS. 100, 103 AND 106). SN 78-785,159. PUB. 9-12-2006. FILED 1-4-2006.
- 3,176,930. **MISCELLANEOUS DESIGN**. WACHTER MANAGEMENT COMPANY, (U.S. CLS. 100, 103 AND 106). SN 78-788,217. PUB. 9-12-2006. FILED 1-10-2006.
- 3,177,037. **DOGGONEHANDY (BLOCK FORM)**. HOME REBUILDERS, INC., THE, (U.S. CLS. 100, 103 AND 106). SN 78-793,799. PUB. 9-12-2006. FILED 1-18-2006.
- 3,177,038. **MISCELLANEOUS DESIGN**. HOME REBUILDERS, INC., THE, (U.S. CLS. 100, 103 AND 106). SN 78-793,817. PUB. 9-12-2006. FILED 1-18-2006.
- 3,177,039. **DOGGONEHANDY AND DESIGN**. HOME REBUILDERS, INC., THE, (U.S. CLS. 100, 103 AND 106). SN 78-793,826. PUB. 9-12-2006. FILED 1-18-2006.
- 3,177,040. **FW DISPOSAL L.L.C. A SUBSIDIARY OF FRED WEBER INC. AND DESIGN**. FW DISPOSAL, L.L.C., (U.S. CLS. 100, 103 AND 106). SN 78-793,866. PUB. 9-12-2006. FILED 1-18-2006.
- 3,177,151. **MISCELLANEOUS DESIGN**. CONOCOPHILLIPS COMPANY, (U.S. CLS. 100, 103 AND 106). SN 78-812,426. PUB. 9-12-2006. FILED 2-10-2006.
- 3,177,187. **MICHELIN (BLOCK FORM)**. MICHELIN NORTH AMERICA, INC., (U.S. CLS. 100, 103 AND 106). SN 78-857,775. PUB. 9-12-2006. FILED 4-10-2006.
- 3,177,191 (*See Class 9 for this trademark*).
- 3,177,200 (*See Class 7 for this trademark*).
- 3,177,209 (*See Class 7 for this trademark*).
- 3,177,228 (*See Class 14 for this trademark*).
- 3,177,242 (*See Class 6 for this trademark*).
- 3,177,280 (*See Class 1 for this trademark*).
- 3,177,295 (*See Class 5 for this trademark*).
- 3,177,318 (*See Class 9 for this trademark*).

CLASS 38—COMMUNICATION

- 3,175,771 (*See Class 9 for this trademark*).
- 3,175,813. **SATELLITE DIRECT (BLOCK FORM)**. TELENOR SATELLITE SERVICES, INC., (U.S. CLS. 100, 101 AND 104). SN 76-603,241. PUB. 9-12-2006. FILED 7-19-2004.
- 3,175,950 (*See Class 9 for this trademark*).
- 3,175,969 (*See Class 35 for this trademark*).
- 3,175,975 (*See Class 9 for this trademark*).
- 3,175,983 (*See Class 9 for this trademark*).
- 3,175,986 (*See Class 9 for this trademark*).
- 3,175,994. **INFOSPACE MOBILE (BLOCK FORM)**. INFOSPACE, INC., (U.S. CLS. 100, 101 AND 104). SN 78-421,154. PUB. 9-27-2005. FILED 5-18-2004.
- 3,176,019. **VOIP YOUR PERSONAL PHONE COMPANY AND DESIGN**. VOIP CORP, (U.S. CLS. 100, 101 AND 104). SN 78-463,462. PUB. 9-12-2006. FILED 8-6-2004.
- 3,176,045 (*See Class 9 for this trademark*).
- 3,176,109. **AZN TELEVISION (BLOCK FORM)**. INTERNATIONAL NETWORKS, LLC, MULTIPLE CLASS, (INT. CLS. 38 AND 41), (U.S. CLS. 100, 101, 104 AND 107). SN 78-554,184. PUB. 9-12-2006. FILED 1-26-2005.
- 3,176,182 (*See Class 35 for this trademark*).
- 3,176,275. **WESTNET SYSTEMS (BLOCK FORM)**.

- MATHENY, RICHARD K., (U.S. CLS. 100, 101 AND 104). SN 78-631,745. PUB. 9-12-2006. FILED 5-17-2005.
- 3,176,300. **WHERE THE GIRLS ARE (BLOCK FORM)**. UPN, (U.S. CLS. 100, 101 AND 104). SN 78-637,306. PUB. 9-12-2006. FILED 5-25-2005.
- 3,176,303. **FIBERLIGHT AND DESIGN**. FIBERLIGHT, LLC, (U.S. CLS. 100, 101 AND 104). SN 78-637,953. PUB. 9-12-2006. FILED 5-26-2005.
- 3,176,316. **VIRTUAL PHONE LINE (BLOCK FORM)**. SUPER TECHNOLOGIES, INC, (U.S. CLS. 100, 101 AND 104). SN 78-640,359. PUB. 9-12-2006. FILED 5-31-2005.
- 3,176,408 (*See Class 35 for this trademark*).
- 3,176,451 (*See Class 9 for this trademark*).
- 3,176,660 (*See Class 35 for this trademark*).
- 3,176,699. **BABY ON THE BRAIN AND DESIGN**. MEDIA SPEEDWAY, (U.S. CLS. 100, 101 AND 104). SN 78-767,730. PUB. 9-12-2006. FILED 12-6-2005.
- 3,176,772. **DARE TO HAVE AN OPINION! (BLOCK FORM)**. FRESENER, SCOTT MICHAEL, (U.S. CLS. 100, 101 AND 104). SN 78-778,448. PUB. 9-12-2006. FILED 12-21-2005.
- 3,176,898. **MEGAFLEX AND DESIGN**. MASHELL TELECOM, INC., (U.S. CLS. 100, 101 AND 104). SN 78-786,286. PUB. 9-12-2006. FILED 1-6-2006.
- 3,177,128. **RAINIER CONNECT AND DESIGN**. MASHELL TELECOM, INC., (U.S. CLS. 100, 101 AND 104). SN 78-798,409. PUB. 9-12-2006. FILED 1-24-2006.
- 3,177,138. **THE NTI GROUP (BLOCK FORM)**. NTI GROUP, INC., THE, (U.S. CLS. 100, 101 AND 104). SN 78-801,062. PUB. 9-12-2006. FILED 1-27-2006.
- 3,177,152. **NBCSEARCH (BLOCK FORM)**. MAINSTREAM ADVERTISING, INC., MULTIPLE CLASS, (INT. CLS. 38 AND 42), (U.S. CLS. 100, 101 AND 104). SN 78-813,265. PUB. 9-12-2006. FILED 2-13-2006.
- 3,177,184. **QWEST DIGITAL VOICE (BLOCK FORM)**. QWEST COMMUNICATIONS INTERNATIONAL INC., (U.S. CLS. 100, 101 AND 104). SN 78-845,094. PUB. 9-12-2006. FILED 3-24-2006.
- 3,177,191 (*See Class 9 for this trademark*).
- 3,177,201 (*See Class 35 for this trademark*).
- 3,177,204 (*See Class 35 for this trademark*).
- 3,177,215 (*See Class 9 for this trademark*).
- 3,177,242 (*See Class 6 for this trademark*).
- 3,177,266 (*See Class 9 for this trademark*).
- 3,177,312. **PICKPE (BLOCK FORM)**. ARPANET SRL, (U.S. CLS. 100, 101 AND 104). SN 79-020,093. PUB. 9-12-2006. FILED 11-3-2005.

CLASS 39—TRANSPORTATION AND STORAGE

- 3,175,761 (*See Class 35 for this trademark*).
- 3,175,788. **DOOLEY CAR RENTALS AND DESIGN**. DAN DOOLEY LIMITED, (U.S. CLS. 100 AND 105). SN 76-544,352. PUB. 9-12-2006. FILED 9-12-2003.
- 3,175,793. **SSIIFT (STYLIZED)**. PROSANOS CORPORATION, MULTIPLE CLASS, (INT. CLS. 39 AND 42), (U.S. CLS. 100, 101 AND 105). SN 76-557,326. PUB. 9-12-2006. FILED 11-6-2003.
- 3,175,877 (*See Class 32 for this trademark*).
- 3,175,895 (*See Class 37 for this trademark*).
- 3,175,902. **AVOID THE BIG AIRPORT HASSLES (BLOCK FORM)**. AIR GRECO, INC., DBA WINGS AIR, (U.S. CLS. 100 AND 105). SN 76-652,338. PUB. 9-12-2006. FILED 12-22-2005.
- 3,175,903. **YOU'RE ALREADY THERE (BLOCK FORM)**. AIR GRECO, INC., DBA WINGS AIR, (U.S. CLS. 100 AND 105). SN 76-652,340. PUB. 9-12-2006. FILED 12-22-2005.
- 3,175,937 (*See Class 25 for this trademark*).
- 3,175,973 (*See Class 35 for this trademark*).
- 3,176,028 (*See Class 35 for this trademark*).
- 3,176,047 (*See Class 37 for this trademark*).
- 3,176,148. **PARTYBUDDYS (BLOCK FORM)**. IMPULSE GLOBAL PARTNERS ENTERPRISES LLC, MULTIPLE CLASS, (INT. CLS. 39 AND 41), (U.S. CLS. 100, 101, 105 AND 107). SN 78-588,639. PUB. 9-12-2006. FILED 3-16-2005.
- 3,176,165 (*See Class 37 for this trademark*).

- 3,176,202. **KANSAS CITY POWER & LIGHT (BLOCK FORM)**. KANSAS CITY POWER & LIGHT COMPANY, (U.S. CLS. 100 AND 105). SN 78-611,823. PUB. 9-12-2006. FILED 4-19-2005.
- 3,176,253 (*See Class 35 for this trademark*).
- 3,176,255 (*See Class 6 for this trademark*).
- 3,176,485 (*See Class 35 for this trademark*).
- 3,176,662. **HERCULES LIFTBOAT (BLOCK FORM)**. HERCULES OFFSHORE, INC., (U.S. CLS. 100 AND 105). SN 78-757,540. PUB. 9-12-2006. FILED 11-18-2005.
- 3,176,749. **A AMERICA'S COURIER DELIVERED WITH PRIDE AND DESIGN**. CORONITI, SAM, (U.S. CLS. 100 AND 105). SN 78-775,790. PUB. 9-12-2006. FILED 12-18-2005.
- 3,176,757. **SHIPLUI (BLOCK FORM)**. LOGISTICS UNLIMITED, (U.S. CLS. 100 AND 105). SN 78-776,679. PUB. 9-12-2006. FILED 12-19-2005.
- 3,176,837. **FREEDOM ENERGY CENTER (BLOCK FORM)**. PHILADELPHIA GAS WORKS, (U.S. CLS. 100 AND 105). SN 78-782,541. PUB. 9-12-2006. FILED 12-29-2005.
- 3,176,971 (*See Class 35 for this trademark*).
- 3,177,055 (*See Class 35 for this trademark*).
- 3,177,107 (*See Class 35 for this trademark*).
- 3,177,108. **RELAX...WE DRIVE (BLOCK FORM)**. RELAX... WE DRIVE, LLC, (U.S. CLS. 100 AND 105). SN 78-796,910. PUB. 9-12-2006. FILED 1-23-2006.
- 3,177,179. **S3 (BLOCK FORM)**. ARSENAL DIGITAL SOLUTIONS USA, INC., MULTIPLE CLASS, (INT. CLS. 39 AND 42), (U.S. CLS. 100, 101 AND 105). SN 78-837,988. PUB. 9-12-2006. FILED 3-15-2006.
- 3,177,191 (*See Class 9 for this trademark*).
- 3,177,241. **DETUR AND DESIGN**. TATIL SEYAHAT TURIZM ANONIM SIRKETI, MULTIPLE CLASS, (INT. CLS. 39, 41 AND 43), (U.S. CLS. 100, 101, 105 AND 107). SN 79-013,275. PUB. 9-12-2006. FILED 11-3-2004.
- 3,177,244. **HPL (BLOCK FORM)**. HELLMANN WORLDWIDE LOGISTICS GMBH & CO. KG, (U.S. CLS. 100 AND 105). SN 79-013,440. PUB. 9-12-2006. FILED 5-23-2005.
- 3,177,314 (*See Class 18 for this trademark*).

CLASS 40—MATERIAL TREATMENT

- 3,175,774. **ABSOLUTE MEDIA, INC.**. ABSOLUTE MEDIA, INC., MULTIPLE CLASS, (INT. CLS. 40, 41 AND 42), (U.S. CLS. 100, 101, 103, 106 AND 107). SN 76-439,624. PUB. 9-28-2004. FILED 8-9-2002.
- 3,175,792 (*See Class 6 for this trademark*).
- 3,175,797 (*See Class 9 for this trademark*).
- 3,175,876 (*See Class 16 for this trademark*).
- 3,175,880. **ARCH DECO GLASS AND DESIGN**. ARCH ALUMINUM & GLASS CO., INC., (U.S. CLS. 100, 103 AND 106). SN 76-647,701. PUB. 9-12-2006. FILED 9-30-2005.
- 3,176,149 (*See Class 37 for this trademark*).
- 3,176,165 (*See Class 37 for this trademark*).
- 3,176,183 (*See Class 35 for this trademark*).
- 3,176,200 (*See Class 35 for this trademark*).
- 3,176,274 (*See Class 19 for this trademark*).
- 3,176,340. **PRSI (BLOCK FORM)**. PASADENA REFINING SYSTEM, INC., (U.S. CLS. 100, 103 AND 106). SN 78-646,002. PUB. 9-12-2006. FILED 6-8-2005.
- 3,176,454 (*See Class 9 for this trademark*).
- 3,176,559 (*See Class 37 for this trademark*).
- 3,176,756. **CUSTOM SOLUTIONS AND DESIGN**. RUSSELL & MILLER, INC., (U.S. CLS. 100, 103 AND 106). SN 78-776,399. PUB. 9-12-2006. FILED 12-19-2005.
- 3,176,844 (*See Class 25 for this trademark*).
- 3,176,884. **LUMINEERS (BLOCK FORM)**. DEN-MAT CORPORATION, (U.S. CLS. 100, 103 AND 106). SN 78-785,587. PUB. 9-12-2006. FILED 1-5-2006.
- 3,176,891. **PIXOGLE (BLOCK FORM)**. CHRIS H LEBOUTILLIER, (U.S. CLS. 100, 103 AND 106). SN 78-786,029. PUB. 9-12-2006. FILED 1-5-2006.
- 3,177,050 (*See Class 25 for this trademark*).
- 3,177,214 (*See Class 1 for this trademark*).
- 3,177,215 (*See Class 9 for this trademark*).
- 3,177,242 (*See Class 6 for this trademark*).

CLASS 41—EDUCATION AND ENTERTAINMENT

- 3,175,754. **PORTLAND PIRATES AND DESIGN**. POTLAND PIRATES, LLC, (U.S. CL. 107). SN 74-467,275. PUB. 6-13-1995. FILED 12-8-1993.
- 3,175,774 (*See Class 40 for this trademark*).
- 3,175,779 (*See Class 35 for this trademark*).
- 3,175,789 (*See Class 16 for this trademark*).
- 3,175,809. **CHAYANNE (BLOCK FORM)**. CHAF ENTERPRISES, INC., (U.S. CLS. 100, 101 AND 107). SN 76-597,604. PUB. 9-12-2006. FILED 6-16-2004.
- 3,175,810 (*See Class 16 for this trademark*).
- 3,175,832. **CANAL 52 (BLOCK FORM)**. MVS UHF, S.A. DE C.V., (U.S. CLS. 100, 101 AND 107). SN 76-625,374. PUB. 9-12-2006. FILED 12-21-2004.
- 3,175,833. **PROGRESSIVE BUSINESS PUBLICATIONS AND DESIGN**. AMERICAN FUTURE SYSTEMS, INC., (U.S. CLS. 100, 101 AND 107). SN 76-630,460. PUB. 9-12-2006. FILED 2-7-2005.
- 3,175,864. **AMERICA SWINGS AGAIN (BLOCK FORM)**. ALLEN, REX, (U.S. CLS. 100, 101 AND 107). SN 76-643,402. PUB. 9-12-2006. FILED 7-25-2005.
- 3,175,869 (*See Class 8 for this trademark*).
- 3,175,884. **THE HEART OF WORSHIP (BLOCK FORM)**. DONALD L. BUETTNER, INC., DBA MIGHTY RIVER PRODUCTIONS, (U.S. CLS. 100, 101 AND 107). SN 76-648,570. PUB. 9-12-2006. FILED 10-17-2005.
- 3,175,896. **KELZ (STYLIZED)**. ANTHONY, CRYSTAL, (U.S. CLS. 100, 101 AND 107). SN 76-652,000. PUB. 9-12-2006. FILED 12-19-2005.
- 3,175,899. **EVERMAY SOCIETY (BLOCK FORM)**. EVERMAY SOCIETY, (U.S. CLS. 100, 101 AND 107). SN 76-652,186. PUB. 9-12-2006. FILED 12-15-2005.
- 3,175,905. **SPEAKING ROCK (BLOCK FORM)**. YSLETA DEL SUR PUEBLO, (U.S. CLS. 100, 101 AND 107). SN 76-652,389. PUB. 9-12-2006. FILED 12-23-2005.
- 3,175,914. **HO-AM TAEKWONDO (BLOCK FORM)**. INTERNATIONAL TAEKWONDO ALLIANCE, INC., (U.S. CLS. 100, 101 AND 107). SN 76-652,784. PUB. 9-12-2006. FILED 1-3-2006.
- 3,175,935. **TIGER-ROCK TAEKWONDO (BLOCK FORM)**. INTERNATIONAL TAEKWONDO ALLIANCE, INC., (U.S. CLS. 100, 101 AND 107). SN 76-656,249. PUB. 9-12-2006. FILED 3-8-2006.
- 3,175,937 (*See Class 25 for this trademark*).
- 3,175,938. **PITCH BLACK AND DESIGN**. MOSLEY, BRENT, M., (U.S. CLS. 100, 101 AND 107). SN 78-107,839. PUB. 9-12-2006. FILED 2-9-2002.
- 3,175,948. **THE LOVE MOVEMENT AND DESIGN**. MITCHELL, DESHAWN, (U.S. CLS. 100, 101 AND 107). SN 78-235,319. PUB. 9-12-2006. FILED 4-8-2003.
- 3,175,963. **CHAMPION FOR EMPOWERMENT & OPPORTUNITY**. WESTFIELD, ELISA M., (U.S. CLS. 100, 101 AND 107). SN 78-318,176. PUB. 9-12-2006. FILED 10-24-2003.
- 3,175,964 (*See Class 3 for this trademark*).
- 3,175,969 (*See Class 35 for this trademark*).
- 3,175,970. **SMART BUSINESS COACHING "SIMPLIFYING THE BUSINESS OF ART" AND DESIGN**. GULRICH, KATHLEEN, (U.S. CLS. 100, 101 AND 107). SN 78-344,534. PUB. 9-12-2006. FILED 12-22-2003.
- 3,175,977 (*See Class 36 for this trademark*).
- 3,175,998 (*See Class 35 for this trademark*).
- 3,176,003. **INTRINSIC COACH (BLOCK FORM)**. TOTALLY COACHED, INC., (U.S. CLS. 100, 101 AND 107). SN 78-434,425. PUB. 9-20-2005. FILED 6-13-2004.
- 3,176,008. **RUNAWAY PLANET (BLOCK FORM)**. RUNAWAY PLANET, LLC, (U.S. CLS. 100, 101 AND 107). SN 78-447,496. PUB. 9-12-2006. FILED 7-8-2004.
- 3,176,015. **JESSTALK (BLOCK FORM)**. JESSTALK SPEAKING SERVICES LLC, (U.S. CLS. 100, 101 AND 107). SN 78-453,316. PUB. 9-12-2006. FILED 7-20-2004.
- 3,176,024. **RADICAL IMPACT ON TEENAGERS (BLOCK FORM)**. KING, DOUGLAS S., (U.S. CLS. 100, 101 AND 107). SN 78-474,415. PUB. 9-12-2006. FILED 8-26-2004.
- 3,176,025. **SAMECUMBA AND DESIGN**. MARTINEZ, DAVID, (U.S. CLS. 100, 101 AND 107). SN 78-475,534. PUB. 9-12-2006. FILED 8-30-2004.
- 3,176,032. **PREMIÈRE PHOTO (BLOCK FORM)**. HASCO I.A.

- LIMITED, (U.S. CLS. 100, 101 AND 107). SN 78-482,976. PUB. 9-12-2006. FILED 9-14-2004.
- 3,176,036. **HOME CASINO (BLOCK FORM)**. STANWORTH DEVELOPMENT LIMITED, (U.S. CLS. 100, 101 AND 107). SN 78-483,896. PUB. 9-12-2006. FILED 9-15-2004.
- 3,176,048. **BOAZ & RUTH (BLOCK FORM)**. BOAZ AND RUTH, INC., (U.S. CLS. 100, 101 AND 107). SN 78-497,044. PUB. 9-12-2006. FILED 10-8-2004.
- 3,176,051 (*See Class 35 for this trademark*).
- 3,176,053. **TECHNOLOGY STRATEGY MANAGEMENT MATURITY MODEL - TSM3 (BLOCK FORM)**. BIRKHEAD, MARK WILLIAM, (U.S. CLS. 100, 101 AND 107). SN 78-501,752. PUB. 9-12-2006. FILED 10-18-2004.
- 3,176,062 (*See Class 9 for this trademark*).
- 3,176,066 (*See Class 25 for this trademark*).
- 3,176,071 (*See Class 9 for this trademark*).
- 3,176,075 (*See Class 36 for this trademark*).
- 3,176,082. **SINGLE FILE (BLOCK FORM)**. DEITZ, SUSAN, MULTIPLE CLASS, (INT. CLS. 41 AND 45), (U.S. CLS. 100, 101 AND 107). SN 78-528,797. PUB. 9-12-2006. FILED 12-8-2004.
- 3,176,084. **CHILDSAFENET (BLOCK FORM)**. CHILDSAFENET, INC., MULTIPLE CLASS, (INT. CLS. 41 AND 45), (U.S. CLS. 100, 101 AND 107). SN 78-530,694. PUB. 9-12-2006. FILED 12-10-2004.
- 3,176,086. **GOOD BIRD (BLOCK FORM)**. HEIDENREICH, BARBARA, (U.S. CLS. 100, 101 AND 107). SN 78-532,699. PUB. 9-12-2006. FILED 12-15-2004.
- 3,176,094. **NATIONAL INSTITUTE FOR HEALTH CARE MANAGEMENT AND DESIGN**. NATIONAL INSTITUTE FOR HEALTH CARE MANAGEMENT RESEARCH AND EDUCATIONAL FOUNDATION, (U.S. CLS. 100, 101 AND 107). SN 78-540,319. PUB. 9-12-2006. FILED 12-30-2004.
- 3,176,109 (*See Class 38 for this trademark*).
- 3,176,111. **MINDFUL MIRRORING (BLOCK FORM)**. REEVES, PAULA M., (U.S. CLS. 100, 101 AND 107). SN 78-557,146. PUB. 9-12-2006. FILED 1-31-2005.
- 3,176,119. **NATIONAL OVERTURE OF EDUCATION AND THE ARTS (BLOCK FORM)**. INSTITUTE FOR EDUCATION AND THE ARTS, (U.S. CLS. 100, 101 AND 107). SN 78-561,052. PUB. 9-12-2006. FILED 2-4-2005.
- 3,176,130 (*See Class 25 for this trademark*).
- 3,176,143 (*See Class 9 for this trademark*).
- 3,176,144 (*See Class 16 for this trademark*).
- 3,176,145. **MÓSDEUX AND DESIGN**. MOSDEUX, (U.S. CLS. 100, 101 AND 107). SN 78-585,833. PUB. 9-12-2006. FILED 3-11-2005.
- 3,176,147. **HEALTHBUX (BLOCK FORM)**. ACE IDEAS, LLC, (U.S. CLS. 100, 101 AND 107). SN 78-588,557. PUB. 9-12-2006. FILED 3-16-2005.
- 3,176,148 (*See Class 39 for this trademark*).
- 3,176,151. **FAITHFULLY FIT (BLOCK FORM)**. WILKEN, DONNA, (U.S. CLS. 100, 101 AND 107). SN 78-589,384. PUB. 9-12-2006. FILED 3-17-2005.
- 3,176,161. **THE HUMAN EDGE FOR YOUR BUSINESS. FOR YOURSELF. AND DESIGN**. THE HUMAN EDGE, LLC, (U.S. CLS. 100, 101 AND 107). SN 78-598,007. PUB. 9-12-2006. FILED 3-30-2005.
- 3,176,173. **JOHN WEHNER'S VILLAGE DOOR (BLOCK FORM)**. WEMER, JOHN D., (U.S. CLS. 100, 101 AND 107). SN 78-600,264. PUB. 4-11-2006. FILED 4-1-2005.
- 3,176,183 (*See Class 35 for this trademark*).
- 3,176,190. **THE QUICK METHOD (BLOCK FORM)**. JRL ENTERPRISES, INC., (U.S. CLS. 100, 101 AND 107). SN 78-608,052. PUB. 9-12-2006. FILED 4-13-2005.
- 3,176,196. **MISCELLANEOUS DESIGN**. BURTON CORPORATION, THE, (U.S. CLS. 100, 101 AND 107). SN 78-610,202. PUB. 9-12-2006. FILED 4-15-2005.
- 3,176,208. **GLOBAL BUSINESS PEOPLE (BLOCK FORM)**. ENTERTAINMENT CONTENT, INC., (U.S. CLS. 100, 101 AND 107). SN 78-616,588. PUB. 9-12-2006. FILED 4-25-2005.
- 3,176,214. **DR. SEARS ZONEDIET.COM (STYLIZED)**. SEARS, BARRY D., (U.S. CLS. 100, 101 AND 107). SN 78-620,316. PUB. 6-20-2006. FILED 4-29-2005.
- 3,176,217. **INNER TEMPLE TRADITIONS INNERCONVOCA-TION (BLOCK FORM)**. STEWART, ROBERT JOHN, (U.S. CLS. 100, 101 AND 107). SN 78-620,579. PUB. 9-12-2006. FILED 5-2-2005.
- 3,176,220. **GIFT OF A LIFETIME (BLOCK FORM)**. ULTRA-SOUND DEEJAYS, INC., (U.S. CLS. 100, 101 AND 107). SN 78-620,944. PUB. 9-12-2006. FILED 5-2-2005.
- 3,176,222. **TSAP (BLOCK FORM)**. ECKERD COLLEGE, INC., (U.S. CLS. 100, 101 AND 107). SN 78-623,038. PUB. 9-12-2006. FILED 5-4-2005.
- 3,176,240. **SCULPT (BLOCK FORM)**. SCULPT, INC., (U.S. CLS. 100, 101 AND 107). SN 78-626,011. PUB. 9-12-2006. FILED 5-9-2005.
- 3,176,258. **LIZZIE MCGUIRE (BLOCK FORM)**. DISNEY ENTERPRISES, INC., (U.S. CLS. 100, 101 AND 107). SN 78-629,117. PUB. 9-12-2006. FILED 5-12-2005.
- 3,176,282. **ATREVETE! (BLOCK FORM)**. BELA BROADCAST-ING, LLC, (U.S. CLS. 100, 101 AND 107). SN 78-632,441. PUB. 9-12-2006. FILED 5-18-2005.
- 3,176,284. **MISCELLANEOUS DESIGN**. ALEXANDRA BAL-LET COMPANY, INC., (U.S. CLS. 100, 101 AND 107). SN 78-633,741. PUB. 9-12-2006. FILED 5-20-2005.
- 3,176,295 (*See Class 35 for this trademark*).
- 3,176,325. **MANZANITA SPEEDWAY (BLOCK FORM)**. ARRI-BA VISTA, INC., (U.S. CLS. 100, 101 AND 107). SN 78-643,418. PUB. 9-12-2006. FILED 6-3-2005.
- 3,176,338. **SPORTS UNPLUGGED (BLOCK FORM)**. ACTION CONSULTING GROUP, LLC, (U.S. CLS. 100, 101 AND 107). SN 78-645,642. PUB. 9-12-2006. FILED 6-7-2005.
- 3,176,347 (*See Class 25 for this trademark*).
- 3,176,350. **MISCELLANEOUS DESIGN**. UNITED NATIONS ASSOCIATION OF THE UNITED STATES OF AMERICA, INC., (U.S. CLS. 100, 101 AND 107). SN 78-650,026. PUB. 9-12-2006. FILED 6-14-2005.
- 3,176,358. **INTRASOURCE (BLOCK FORM)**. FRANCHISE ADVANTAGE LLC, (U.S. CLS. 100, 101 AND 107). SN 78-652,522. PUB. 9-12-2006. FILED 6-16-2005.
- 3,176,360. **BXN (BLOCK FORM)**. BREAKMANX.COM, INC., (U.S. CLS. 100, 101 AND 107). SN 78-653,121. PUB. 9-12-2006. FILED 6-17-2005.
- 3,176,373. **SONG GURU (BLOCK FORM)**. TAYLOR-GOOD, KAREN, (U.S. CLS. 100, 101 AND 107). SN 78-656,257. PUB. 9-12-2006. FILED 6-22-2005.
- 3,176,378. **THE VILLAGE VOICE SIREN MUSIC FESTIVAL (BLOCK FORM)**. VILLAGE VOICE MEDIA HOLDINGS, LLC, (U.S. CLS. 100, 101 AND 107). SN 78-657,244. PUB. 9-12-2006. FILED 6-23-2005.
- 3,176,383 (*See Class 16 for this trademark*).
- 3,176,390. **AMERICAN LIBERTY FEST AND DESIGN**. RO-BERT L. STARK ENTERPRISES, INC., (U.S. CLS. 100, 101 AND 107). SN 78-659,686. PUB. 9-12-2006. FILED 6-28-2005.
- 3,176,396. **INCREDIDAD A NEW GENERATION OF DEDICATED DADS (STYLIZED)**. INCREDIDAD MEDIA LLC, (U.S. CLS. 100, 101 AND 107). SN 78-660,653. PUB. 9-12-2006. FILED 6-29-2005.
- 3,176,400. **X RAP PHENOMENONS AND DESIGN**. MITCH-ELL, DONNELL L., (U.S. CLS. 100, 101 AND 107). SN 78-663,320. PUB. 7-4-2006. FILED 7-4-2005.
- 3,176,409. **MISCELLANEOUS DESIGN**. WEBSTAR MARKET-ING GROUP, INC., (U.S. CLS. 100, 101 AND 107). SN 78-665,949. PUB. 9-12-2006. FILED 7-7-2005.
- 3,176,410. **MISCELLANEOUS DESIGN**. THE FABULOUS MAMMALS, DBA THE MAMMALS, (U.S. CLS. 100, 101 AND 107). SN 78-666,744. PUB. 9-12-2006. FILED 7-8-2005.
- 3,176,421 (*See Class 35 for this trademark*).
- 3,176,430. **OSI UNIVERSITY (BLOCK FORM)**. OSI INDUS-TRIES, LLC, (U.S. CLS. 100, 101 AND 107). SN 78-677,835. PUB. 4-11-2006. FILED 7-25-2005.
- 3,176,440 (*See Class 35 for this trademark*).
- 3,176,449. **CHOOZI ENTERTAINMENT EXPECT THE UN-EXPECTED (BLOCK FORM)**. CHILDERS, SUZANNE M, (U.S. CLS. 100, 101 AND 107). SN 78-689,504. PUB. 9-12-2006. FILED 8-10-2005.
- 3,176,451 (*See Class 9 for this trademark*).
- 3,176,466. **BETTER. AND DESIGN**. TSI HOLDINGS (IP), LLC, (U.S. CLS. 100, 101 AND 107). SN 78-696,219. PUB. 9-12-2006. FILED 8-19-2005.
- 3,176,467. **TWIN CITIES UNCOVERED (BLOCK FORM)**. VILLAGE VOICE MEDIA HOLDINGS, LLC, (U.S. CLS. 100, 101 AND 107). SN 78-696,275. PUB. 9-12-2006. FILED 8-19-2005.
- 3,176,470. **CHAMPIONS ARE READERS (BLOCK FORM)**. PI

- BETA PHI FRATERNITY, (U.S. CLS. 100, 101 AND 107). SN 78-698,340. PUB. 9-12-2006. FILED 8-23-2005.
- 3,176,474. **DANCE USA PERFORMING ARTS CHAMPIONSHIPS (BLOCK FORM)**. DANCE USA, INC., (U.S. CLS. 100, 101 AND 107). SN 78-700,669. PUB. 9-12-2006. FILED 8-25-2005.
- 3,176,476. **JUMP START REAL LIFE SUCCESS AND DESIGN**. PAXEN GROUP, INC., THE, (U.S. CLS. 100, 101 AND 107). SN 78-701,391. PUB. 9-12-2006. FILED 8-26-2005.
- 3,176,477. **BLUE COAST PRODUCTIONS (BLOCK FORM)**. BLUE COAST PRODUCTIONS, LLC, (U.S. CLS. 100, 101 AND 107). SN 78-701,924. PUB. 9-12-2006. FILED 8-27-2005.
- 3,176,479 (*See Class 36 for this trademark*).
- 3,176,481. **BIOMET (BLOCK FORM)**. BIOMET MANUFACTURING CORP., (U.S. CLS. 100, 101 AND 107). SN 78-703,978. PUB. 9-12-2006. FILED 8-31-2005.
- 3,176,490. **MEADOWLANDS ALL ACCESS (STYLIZED)**. NEW JERSEY SPORTS & EXPOSITION AUTHORITY, (U.S. CLS. 100, 101 AND 107). SN 78-707,413. PUB. 9-12-2006. FILED 9-6-2005.
- 3,176,508 (*See Class 9 for this trademark*).
- 3,176,509. **STR8MUSCLE (BLOCK FORM)**. CAMPBELL, CHRIS F., (U.S. CLS. 100, 101 AND 107). SN 78-714,033. PUB. 9-12-2006. FILED 9-15-2005.
- 3,176,531. **OMAHA AK-SAR-BEN KNIGHTS AK AND DESIGN**. AK-SAR-BEN/CALGARY HOCKEY, INC., (U.S. CLS. 100, 101 AND 107). SN 78-721,054. PUB. 9-12-2006. FILED 9-27-2005.
- 3,176,550. **HIGH SCHOOL CELEBRITY SHOOT (BLOCK FORM)**. CHUCK, EMIL, (U.S. CLS. 100, 101 AND 107). SN 78-724,917. PUB. 9-12-2006. FILED 10-3-2005.
- 3,176,552. **CINEMATOGRAPHER (BLOCK FORM)**. CMP ENTERTAINMENT MEDIA, INC., (U.S. CLS. 100, 101 AND 107). SN 78-725,336. PUB. 9-12-2006. FILED 10-3-2005.
- 3,176,580. **DESIGNING WOMEN'S WEIGHT LOSS AND DESIGN**. DESIGNING WOMEN'S WEIGHT LOSS, INC., (U.S. CLS. 100, 101 AND 107). SN 78-737,185. PUB. 9-12-2006. FILED 10-20-2005.
- 3,176,595. **NOVUS SPIRITUS (BLOCK FORM)**. SOCIETY OF NOVUS SPIRITUS, (U.S. CLS. 100, 101 AND 107). SN 78-745,002. PUB. 9-12-2006. FILED 11-1-2005.
- 3,176,598. **DISTANCEPREP.COM (BLOCK FORM)**. BOOSALLIS, CHRIS NICHOLAS, (U.S. CLS. 100, 101 AND 107). SN 78-745,518. PUB. 9-12-2006. FILED 11-2-2005.
- 3,176,619. **LOCALVIEWFINDER.COM (BLOCK FORM)**. LOCALVIEWFINDER COM LLC, (U.S. CLS. 100, 101 AND 107). SN 78-748,428. PUB. 9-12-2006. FILED 11-7-2005.
- 3,176,624 (*See Class 35 for this trademark*).
- 3,176,654. **THE ROAD AHEAD (BLOCK FORM)**. INNOVATIVE EDGE, LLC, THE, (U.S. CLS. 100, 101 AND 107). SN 78-755,761. PUB. 9-12-2006. FILED 11-17-2005.
- 3,176,657. **RAPSAT (BLOCK FORM)**. JUXTOPIA, LLC, (U.S. CLS. 100, 101 AND 107). SN 78-756,881. PUB. 7-25-2006. FILED 11-18-2005.
- 3,176,665. **COHERENT BREATHING (BLOCK FORM)**. ELIOTT, STEPHEN B., (U.S. CLS. 100, 101 AND 107). SN 78-757,728. PUB. 9-12-2006. FILED 11-19-2005.
- 3,176,677. **DENNIS LEARY'S MERRY F#%SIN CHRISTMAS (BLOCK FORM)**. COMEDY PARTNERS, (U.S. CLS. 100, 101 AND 107). SN 78-762,514. PUB. 9-12-2006. FILED 11-29-2005.
- 3,176,689. **CEO HQ FELLOWS AND DESIGN**. PETERS, BRUCE W., (U.S. CLS. 100, 101 AND 107). SN 78-765,211. PUB. 9-12-2006. FILED 12-2-2005.
- 3,176,694. **LIGHTS OUT ENTERPRISES (BLOCK FORM)**. FOCUS MEDIA, INC., (U.S. CLS. 100, 101 AND 107). SN 78-765,994. PUB. 9-12-2006. FILED 12-2-2005.
- 3,176,702. **IT'S GREAT OUTDOORS! (BLOCK FORM)**. HAMILTON COUNTY PARK DISTRICT, (U.S. CLS. 100, 101 AND 107). SN 78-768,373. PUB. 9-12-2006. FILED 12-7-2005.
- 3,176,712. **PHILADELPHIA INTERNATIONAL GAY & LESBIAN FILM FESTIVAL (BLOCK FORM)**. PHILADELPHIA FILM SOCIETY, (U.S. CLS. 100, 101 AND 107). SN 78-772,095. PUB. 9-12-2006. FILED 12-13-2005.
- 3,176,713. **PHILADELPHIA FILM FESTIVAL (BLOCK FORM)**. PHILADELPHIA FILM SOCIETY, (U.S. CLS. 100, 101 AND 107). SN 78-772,164. PUB. 9-12-2006. FILED 12-13-2005.
- 3,176,719. **GOLDENPALACE.COM (BLOCK FORM)**. GOLD-EN PALACE LIMITED, (U.S. CLS. 100, 101 AND 107). SN 78-773,142. PUB. 9-12-2006. FILED 12-14-2005.
- 3,176,726. **THE MAFIA BOSS (BLOCK FORM)**. BELRHITI, LARBI, (U.S. CLS. 100, 101 AND 107). SN 78-774,094. PUB. 9-12-2006. FILED 12-15-2005.
- 3,176,737 (*See Class 16 for this trademark*).
- 3,176,744. **KAUSTIC (BLOCK FORM)**. BORDONE, RICHARD BRYCE, (U.S. CLS. 100, 101 AND 107). SN 78-775,457. PUB. 9-12-2006. FILED 12-16-2005.
- 3,176,745. **CALIFORNIA HEAVEN (STYLIZED)**. ST. JOHN, STEWART BLAKE, (U.S. CLS. 100, 101 AND 107). SN 78-775,563. PUB. 9-12-2006. FILED 12-17-2005.
- 3,176,750 (*See Class 35 for this trademark*).
- 3,176,753. **GOCITYKIDS (BLOCK FORM)**. VIACOM INTERNATIONAL INC., (U.S. CLS. 100, 101 AND 107). SN 78-776,133. PUB. 9-12-2006. FILED 12-19-2005.
- 3,176,755. **HANDS-ON HOW-TO (BLOCK FORM)**. NETSECURITY CORPORATION, (U.S. CLS. 100, 101 AND 107). SN 78-776,282. PUB. 9-12-2006. FILED 12-19-2005.
- 3,176,758. **MOHR ACCESS (BLOCK FORM)**. MOHR ACCESS LLC, (U.S. CLS. 100, 101 AND 107). SN 78-776,795. PUB. 9-12-2006. FILED 12-20-2005.
- 3,176,775. **WHAT WOULD YOUR MOTHER SAY? (BLOCK FORM)**. BIG HEN GROUP I, LLC, (U.S. CLS. 100, 101 AND 107). SN 78-778,734. PUB. 9-12-2006. FILED 12-21-2005.
- 3,176,778 (*See Class 16 for this trademark*).
- 3,176,779. **RINK RAT (BLOCK FORM)**. MEARTHANE PRODUCTS CORPORATION, (U.S. CLS. 100, 101 AND 107). SN 78-779,021. PUB. 9-12-2006. FILED 12-22-2005.
- 3,176,786. **ANGEL SPARKS (BLOCK FORM)**. ENTERTAINMENT PROPERTIES, LLC, (U.S. CLS. 100, 101 AND 107). SN 78-779,354. PUB. 9-12-2006. FILED 12-22-2005.
- 3,176,787. **GROOVY TUESDAY (BLOCK FORM)**. ENTERTAINMENT PROPERTIES, LLC, (U.S. CLS. 100, 101 AND 107). SN 78-779,365. PUB. 9-12-2006. FILED 12-22-2005.
- 3,176,788. **JOEY THUNDERS (BLOCK FORM)**. ENTERTAINMENT PROPERTIES, LLC, (U.S. CLS. 100, 101 AND 107). SN 78-779,375. PUB. 9-12-2006. FILED 12-22-2005.
- 3,176,789. **PJ BARDOT (BLOCK FORM)**. ENTERTAINMENT PROPERTIES, LLC, (U.S. CLS. 100, 101 AND 107). SN 78-779,379. PUB. 9-12-2006. FILED 12-22-2005.
- 3,176,790. **TWIGGY STARDOM (BLOCK FORM)**. ENTERTAINMENT PROPERTIES, LLC, (U.S. CLS. 100, 101 AND 107). SN 78-779,391. PUB. 9-12-2006. FILED 12-22-2005.
- 3,176,797. **DANCEBEAT (BLOCK FORM)**. DANCEKIDZ, LLC, (U.S. CLS. 100, 101 AND 107). SN 78-779,941. PUB. 9-12-2006. FILED 12-22-2005.
- 3,176,810. **BREAKING PLATEAUS (BLOCK FORM)**. BREAKING PLATEAUS, LLC, (U.S. CLS. 100, 101 AND 107). SN 78-780,760. PUB. 9-12-2006. FILED 12-26-2005.
- 3,176,826. **"PULSE OF THE MEADOWLANDS" (BLOCK FORM)**. LEADER NEWS GROUP, LLC, (U.S. CLS. 100, 101 AND 107). SN 78-781,733. PUB. 9-12-2006. FILED 12-28-2005.
- 3,176,829 (*See Class 35 for this trademark*).
- 3,176,842. **THE SELVA GROUP (BLOCK FORM)**. CREATIVE HEALTHCARE SOLUTIONS, LLC, (U.S. CLS. 100, 101 AND 107). SN 78-782,864. PUB. 9-12-2006. FILED 12-30-2005.
- 3,176,857. **M AND DESIGN**. MOHR ACCESS LLC, (U.S. CLS. 100, 101 AND 107). SN 78-784,150. PUB. 9-12-2006. FILED 1-3-2006.
- 3,176,869 (*See Class 16 for this trademark*).
- 3,176,877. **STAGE TRACK (BLOCK FORM)**. JAMES S BENNETT, (U.S. CLS. 100, 101 AND 107). SN 78-785,280. PUB. 9-12-2006. FILED 1-5-2006.
- 3,176,879. **WOLF (BLOCK FORM)**. BLUE SKY INSPIRATIONS, LLC, MULTIPLE CLASS, (INT. CLS. 41 AND 45), (U.S. CLS. 100, 101 AND 107). SN 78-785,351. PUB. 9-12-2006. FILED 1-5-2006.
- 3,176,883. **ROTONNEWS (BLOCK FORM)**. ROTOSTUD LLC, (U.S. CLS. 100, 101 AND 107). SN 78-785,562. PUB. 9-12-2006. FILED 1-5-2006.
- 3,176,888. **WOLF AND DESIGN**. BLUE SKY INSPIRATIONS, LLC, MULTIPLE CLASS, (INT. CLS. 41 AND 45), (U.S. CLS. 100, 101 AND 107). SN 78-785,852. PUB. 9-12-2006. FILED 1-5-2006.
- 3,176,916. **PHOTOGRAPHING KIDS AS KIDS (BLOCK FORM)**. LESNICK, STEVE, (U.S. CLS. 100, 101 AND 107).

- SN 78-787,260. PUB. 9-12-2006. FILED 1-9-2006.
- 3,176,927. **WHOA GA AND DESIGN**. REYNOLDS, CATHERINE M., (U.S. CLS. 100, 101 AND 107). SN 78-787,974. PUB. 9-12-2006. FILED 1-9-2006.
- 3,176,941. **ROGER MARSHALL & THE LAW (BLOCK FORM)**. MARSHALL, ROGER, (U.S. CLS. 100, 101 AND 107). SN 78-788,897. PUB. 9-12-2006. FILED 1-10-2006.
- 3,176,951. **THINKSAFETY (BLOCK FORM)**. FLIGHTSAFETY DEVELOPMENT CORP., (U.S. CLS. 100, 101 AND 107). SN 78-789,412. PUB. 9-12-2006. FILED 1-11-2006.
- 3,176,958. **SKILLWRITER (BLOCK FORM)**. BOOKETTE SOFTWARE COMPANY, (U.S. CLS. 100, 101 AND 107). SN 78-790,415. PUB. 9-12-2006. FILED 1-12-2006.
- 3,176,959. **BENCHMARKTRACKER (BLOCK FORM)**. BOOKETTE SOFTWARE COMPANY, (U.S. CLS. 100, 101 AND 107). SN 78-790,467. PUB. 9-12-2006. FILED 1-12-2006.
- 3,176,985. **PAN-AMERICAN JIU-JITSU CHAMPIONSHIP (BLOCK FORM)**. FERNANDES, ANDRE LUIZ MACHADO, (U.S. CLS. 100, 101 AND 107). SN 78-791,969. PUB. 9-12-2006. FILED 1-14-2006.
- 3,176,987. **EDUCATION TREATMENT SUCCESS FOR EVERY CHILD (BLOCK FORM)**. PENDLETON ACADEMIES, (U.S. CLS. 100, 101 AND 107). SN 78-792,179. PUB. 9-12-2006. FILED 1-16-2006.
- 3,176,996. **VARI SMART (BLOCK FORM)**. TRUE NORTH CUSTOM PUBLISHING, LLC, (U.S. CLS. 100, 101 AND 107). SN 78-792,720. PUB. 9-12-2006. FILED 1-17-2006.
- 3,177,003. **HEALTH NUT FITNESS & SPA FOR HER AND DESIGN**. PRESNAL, JENNIFER, (U.S. CLS. 100, 101 AND 107). SN 78-792,863. PUB. 9-12-2006. FILED 1-17-2006.
- 3,177,004 (*See Class 35 for this trademark*).
- 3,177,005. **AM AND DESIGN**. ALPINE MEADOWS SKI CORPORATION, (U.S. CLS. 100, 101 AND 107). SN 78-792,882. PUB. 9-12-2006. FILED 1-17-2006.
- 3,177,006. **ACE ARCADE AND DESIGN**. THE CARTOON NETWORK LP, LLLP, (U.S. CLS. 100, 101 AND 107). SN 78-792,916. PUB. 9-12-2006. FILED 1-17-2006.
- 3,177,007 (*See Class 16 for this trademark*).
- 3,177,041. **HEPWORKS (BLOCK FORM)**. HEPWORTH, JOHN, (U.S. CLS. 100, 101 AND 107). SN 78-793,899. PUB. 9-12-2006. FILED 1-18-2006.
- 3,177,046. **CORPORATE COMBINE (BLOCK FORM)**. ALUMNI SPORTS ENTERPRISES, LLC, (U.S. CLS. 100, 101 AND 107). SN 78-794,071. PUB. 9-12-2006. FILED 1-18-2006.
- 3,177,047. **STRETCH YOURSELF (BLOCK FORM)**. SAUCEDO, MARK A., (U.S. CLS. 100, 101 AND 107). SN 78-794,087. PUB. 9-12-2006. FILED 1-18-2006.
- 3,177,057. **HIRECOACH (BLOCK FORM)**. HOLLINGER, DARREL R., AND PICKETT, PATT H., (U.S. CLS. 100, 101 AND 107). SN 78-794,305. PUB. 9-12-2006. FILED 1-18-2006.
- 3,177,059. **PMA (BLOCK FORM)**. CORRIGAN, BRUCE, (U.S. CLS. 100, 101 AND 107). SN 78-794,379. PUB. 9-12-2006. FILED 1-18-2006.
- 3,177,080. **WE KNOW WHAT GAMBLERS WANT. (BLOCK FORM)**. HARRAH'S LICENSE COMPANY, LLC, (U.S. CLS. 100, 101 AND 107). SN 78-795,000. PUB. 9-12-2006. FILED 1-19-2006.
- 3,177,081. **CUSTARD WALLY (BLOCK FORM)**. GIUNTA, CHRISTOPHER, (U.S. CLS. 100, 101 AND 107). SN 78-795,015. PUB. 9-12-2006. FILED 1-19-2006.
- 3,177,082. **NOBODY BOOKS A BIGGER BET (BLOCK FORM)**. HARRAH'S LICENSE COMPANY, LLC, (U.S. CLS. 100, 101 AND 107). SN 78-795,020. PUB. 9-12-2006. FILED 1-19-2006.
- 3,177,086. **BARFLY (BLOCK FORM)**. BARFLY DEVELOPMENT TEAM, LLC, (U.S. CLS. 100, 101 AND 107). SN 78-795,130. PUB. 9-12-2006. FILED 1-19-2006.
- 3,177,094. **CODE OF AUDIO (BLOCK FORM)**. RICO, JOEY, (U.S. CLS. 100, 101 AND 107). SN 78-795,862. PUB. 9-12-2006. FILED 1-20-2006.
- 3,177,104. **FLAISTOCK (BLOCK FORM)**. AMERICAN POSTER INSTITUTE, (U.S. CLS. 100, 101 AND 107). SN 78-796,441. PUB. 9-12-2006. FILED 1-21-2006.
- 3,177,107 (*See Class 35 for this trademark*).
- 3,177,112. **AN EAR TO THE EARTH (BLOCK FORM)**. ELECTRONIC MUSIC FOUNDATION, LTD., (U.S. CLS. 100, 101 AND 107). SN 78-797,182. PUB. 9-12-2006. FILED 1-23-2006.
- 3,177,118. **BLACKTALON AND DESIGN**. BLACKTALON INDUSTRIES, INC., (U.S. CLS. 100, 101 AND 107). SN 78-797,467. PUB. 9-12-2006. FILED 1-23-2006.
- 3,177,122. **MARVA COLLINS (BLOCK FORM)**. COLLINS, MARVA N., (U.S. CLS. 100, 101 AND 107). SN 78-797,590. PUB. 9-12-2006. FILED 1-23-2006.
- 3,177,123. **WAR MACHINE (BLOCK FORM)**. TNA ENTERTAINMENT, LLC, (U.S. CLS. 100, 101 AND 107). SN 78-798,072. PUB. 9-12-2006. FILED 1-24-2006.
- 3,177,124. **CANADIAN ENFORCER (BLOCK FORM)**. TNA ENTERTAINMENT, LLC, (U.S. CLS. 100, 101 AND 107). SN 78-798,130. PUB. 9-12-2006. FILED 1-24-2006.
- 3,177,127. **"WE GIVE GAMBLERS WHAT THEY WANT." (BLOCK FORM)**. HARRAH'S LICENSE COMPANY, LLC, (U.S. CLS. 100, 101 AND 107). SN 78-798,397. PUB. 9-12-2006. FILED 1-24-2006.
- 3,177,129. **"NOBODY DOES MORE FOR THE GAMBLER." (BLOCK FORM)**. HARRAH'S LICENSE COMPANY, LLC, (U.S. CLS. 100, 101 AND 107). SN 78-798,458. PUB. 9-12-2006. FILED 1-24-2006.
- 3,177,134. **RIDING SOLO (BLOCK FORM)**. INNOVATIVE EDGE, LLC, THE, (U.S. CLS. 100, 101 AND 107). SN 78-799,552. PUB. 9-12-2006. FILED 1-25-2006.
- 3,177,136 (*See Class 16 for this trademark*).
- 3,177,144. **MUSIC WITHOUT BOUNDARIES (BLOCK FORM)**. FEARLESS ENTERTAINMENT, INC., (U.S. CLS. 100, 101 AND 107). SN 78-806,206. PUB. 9-12-2006. FILED 2-3-2006.
- 3,177,159. **SAMOAN SUBMISSION MACHINE (BLOCK FORM)**. TNA ENTERTAINMENT, LLC, (U.S. CLS. 100, 101 AND 107). SN 78-818,874. PUB. 9-12-2006. FILED 2-20-2006.
- 3,177,161. **ONE TRACK MIND (BLOCK FORM)**. SPEED CHANNEL, INC., (U.S. CLS. 100, 101 AND 107). SN 78-821,134. PUB. 9-12-2006. FILED 2-22-2006.
- 3,177,163. **THE PRINCE OF PUNK (BLOCK FORM)**. TNA ENTERTAINMENT, LLC, (U.S. CLS. 100, 101 AND 107). SN 78-824,598. PUB. 9-12-2006. FILED 2-27-2006.
- 3,177,176. **SPLOID (BLOCK FORM)**. BLOGWIRE HUNGARY SZELLEMI ALKOTÁST CORPORATION, (U.S. CLS. 100, 101 AND 107). SN 78-832,742. PUB. 9-12-2006. FILED 3-8-2006.
- 3,177,182 (*See Class 16 for this trademark*).
- 3,177,189. **EQUESTRIAN RETAILER (BLOCK FORM)**. MCC MAGAZINES, LLC, (U.S. CLS. 100, 101 AND 107). SN 78-977,225. PUB. 9-12-2006. FILED 7-6-2004.
- 3,177,204 (*See Class 35 for this trademark*).
- 3,177,215 (*See Class 9 for this trademark*).
- 3,177,218 (*See Class 9 for this trademark*).
- 3,177,241 (*See Class 39 for this trademark*).
- 3,177,266 (*See Class 9 for this trademark*).
- 3,177,297 (*See Class 9 for this trademark*).
- 3,177,299 (*See Class 9 for this trademark*).
- 3,177,318 (*See Class 9 for this trademark*).

CLASS 42—SCIENTIFIC, COMPUTER AND LEGAL SERVICES

- 3,175,761 (*See Class 35 for this trademark*).
- 3,175,762 (*See Class 3 for this trademark*).
- 3,175,766. **PST. XZILLION GMBH & CO. KG**, (U.S. CLS. 100 AND 101). SN 76-299,137. PUB. 1-27-2004. FILED 8-9-2001.
- 3,175,769 (*See Class 35 for this trademark*).
- 3,175,774 (*See Class 40 for this trademark*).
- 3,175,789 (*See Class 16 for this trademark*).
- 3,175,792 (*See Class 6 for this trademark*).
- 3,175,793 (*See Class 39 for this trademark*).
- 3,175,795 (*See Class 9 for this trademark*).
- 3,175,797 (*See Class 9 for this trademark*).
- 3,175,808. **RELIASTOR (STYLIZED)**. SECURED DIGITAL STORAGE, INC., (U.S. CLS. 100 AND 101). SN 76-594,871. PUB. 9-12-2006. FILED 6-1-2004.
- 3,175,847 (*See Class 9 for this trademark*).
- 3,175,848 (*See Class 35 for this trademark*).
- 3,175,861. **BECHT ENGINEERING AND DESIGN**. BECHT ENGINEERING CO., INC., (U.S. CLS. 100 AND 101). SN 76-642,514. PUB. 9-12-2006. FILED 7-8-2005.

- 3,175,881. **COURSEWALK (BLOCK FORM)**. VOICEWALK, INC., (U.S. CLS. 100 AND 101). SN 76-648,052. PUB. 9-12-2006. FILED 10-6-2005.
- 3,175,885. **ART SCA ANTIQUES AND DESIGN**. SOCIETY TO CERTIFY THE AUTHENTICITY OF ARTS & ANTIQUES CO., (U.S. CLS. 100 AND 101). SN 76-648,638. PUB. 9-12-2006. FILED 10-17-2005.
- 3,175,888 (*See Class 35 for this trademark*).
- 3,175,909. **JOBCLUES (BLOCK FORM)**. PSYCHOMETRICS INTERNATIONAL, LLC, (U.S. CLS. 100 AND 101). SN 76-652,545. PUB. 9-12-2006. FILED 12-27-2005.
- 3,175,912. **CANDIDCLUES (BLOCK FORM)**. PSYCHOMETRICS INTERNATIONAL, LLC, (U.S. CLS. 100 AND 101). SN 76-652,676. PUB. 9-12-2006. FILED 12-30-2005.
- 3,175,928. **A HIGHER STANDARD OF SERVICE (BLOCK FORM)**. AMERICAN INSTITUTE OF TOXICOLOGY, INC., (U.S. CLS. 100 AND 101). SN 76-653,423. PUB. 9-12-2006. FILED 1-17-2006.
- 3,175,950 (*See Class 9 for this trademark*).
- 3,175,955 (*See Class 5 for this trademark*).
- 3,175,975 (*See Class 9 for this trademark*).
- 3,175,983 (*See Class 9 for this trademark*).
- 3,175,987 (*See Class 5 for this trademark*).
- 3,175,990 (*See Class 35 for this trademark*).
- 3,175,998 (*See Class 35 for this trademark*).
- 3,176,020. **PRINTTRACKER (BLOCK FORM)**. FORMAT DYNAMICS LLC, (U.S. CLS. 100 AND 101). SN 78-466,692. PUB. 9-12-2006. FILED 8-12-2004.
- 3,176,038. **THINK > BUILD > DEPLOY AND DESIGN**. ENTERPRISE WEB SOLUTIONS, INC., (U.S. CLS. 100 AND 101). SN 78-485,700. PUB. 9-12-2006. FILED 9-17-2004.
- 3,176,045 (*See Class 9 for this trademark*).
- 3,176,078. **COLLECTORS UNIVERSE (BLOCK FORM)**. COLLECTORS UNIVERSE, INC., (U.S. CLS. 100 AND 101). SN 78-527,091. PUB. 9-12-2006. FILED 12-3-2004.
- 3,176,095. **EPROJECT AND DESIGN**. EPROJECT, INC., (U.S. CLS. 100 AND 101). SN 78-543,483. PUB. 9-12-2006. FILED 1-6-2005.
- 3,176,104 (*See Class 36 for this trademark*).
- 3,176,108. **EMPOWERING THE BUSINESS OF ADVICE (BLOCK FORM)**. SPG SOLUTIONS, LLC, (U.S. CLS. 100 AND 101). SN 78-554,044. PUB. 9-12-2006. FILED 1-26-2005.
- 3,176,127. **WEBVANTAGE (BLOCK FORM)**. ADVANTAGE SOFTWARE COMPANY, INC., THE, (U.S. CLS. 100 AND 101). SN 78-570,114. PUB. 9-12-2006. FILED 2-17-2005.
- 3,176,132. **NEXUS ENTERTAINMENT (BLOCK FORM)**. NEXUS ENTERTAINMENT, (U.S. CLS. 100 AND 101). SN 78-575,655. PUB. 9-12-2006. FILED 2-25-2005.
- 3,176,165 (*See Class 37 for this trademark*).
- 3,176,182 (*See Class 35 for this trademark*).
- 3,176,183 (*See Class 35 for this trademark*).
- 3,176,186. **VIGILANCE. (BLOCK FORM)**. YOKOGAWA ELECTRIC CORPORATION, (U.S. CLS. 100 AND 101). SN 78-605,948. PUB. 9-12-2006. FILED 4-11-2005.
- 3,176,211. **ELEANOR FINE DESIGN (BLOCK FORM)**. RAHIM, ELEANOR, (U.S. CLS. 100 AND 101). SN 78-617,822. PUB. 9-12-2006. FILED 4-27-2005.
- 3,176,250. **ALPHA CERTIFICATION (BLOCK FORM)**. MONTLICK, TERRY F., (U.S. CLS. 100 AND 101). SN 78-628,186. PUB. 9-12-2006. FILED 5-11-2005.
- 3,176,252. **WCO GLOBAL SERVICES AND DESIGN**. USA WEB SOLUTIONS, INC., (U.S. CLS. 100 AND 101). SN 78-628,409. PUB. 9-12-2006. FILED 5-12-2005.
- 3,176,253 (*See Class 35 for this trademark*).
- 3,176,290. **WESTLAW LITIGATOR (BLOCK FORM)**. WEST PUBLISHING CORPORATION, (U.S. CLS. 100 AND 101). SN 78-635,089. PUB. 9-12-2006. FILED 5-23-2005.
- 3,176,326. **WORKMATCH (BLOCK FORM)**. RIGGS, RANDALL S., (U.S. CLS. 100 AND 101). SN 78-643,479. PUB. 9-12-2006. FILED 6-3-2005.
- 3,176,333. **INDUSTRIAL CONTROL DESIGNLINE (BLOCK FORM)**. CMP MEDIA LLC, (U.S. CLS. 100 AND 101). SN 78-644,619. PUB. 9-12-2006. FILED 6-6-2005.
- 3,176,345. **TOP TO BOTTOM HOME INSPECTION, INC. AND DESIGN**. TOP TO BOTTOM HOME INSPECTION, INC., (U.S. CLS. 100 AND 101). SN 78-648,005. PUB. 9-12-2006. FILED 6-10-2005.
- 3,176,398 (*See Class 9 for this trademark*).
- 3,176,414 (*See Class 35 for this trademark*).
- 3,176,419 (*See Class 35 for this trademark*).
- 3,176,421 (*See Class 35 for this trademark*).
- 3,176,427. **DIRTT (BLOCK FORM)**. DIRTT ENVIRONMENTAL SOLUTIONS LTD., (U.S. CLS. 100 AND 101). SN 78-673,646. PUB. 9-12-2006. FILED 7-19-2005.
- 3,176,428. **OWEN BIOSCIENCES (BLOCK FORM)**. BIOSYN, INC., (U.S. CLS. 100 AND 101). SN 78-674,624. PUB. 9-12-2006. FILED 7-20-2005.
- 3,176,432 (*See Class 9 for this trademark*).
- 3,176,454 (*See Class 9 for this trademark*).
- 3,176,463. **XACTCONTENTS (BLOCK FORM)**. XACTWARE, INC., (U.S. CLS. 100 AND 101). SN 78-694,742. PUB. 9-12-2006. FILED 8-17-2005.
- 3,176,478. **VVV BRS AND DESIGN**. BULLTEK REGISTRATION SERVICES LTD, (U.S. CLS. 100 AND 101). SN 78-702,973. PUB. 9-12-2006. FILED 8-29-2005.
- 3,176,498 (*See Class 9 for this trademark*).
- 3,176,514 (*See Class 35 for this trademark*).
- 3,176,528 (*See Class 35 for this trademark*).
- 3,176,541. **DEACONS (BLOCK FORM)**. KEITH COLE AND LILIAN CHIANG, TA DEACONS, (U.S. CLS. 100 AND 101). SN 78-722,063. PUB. 9-12-2006. FILED 9-28-2005.
- 3,176,542. **GROWING IDEAS INTO SOLUTIONS (BLOCK FORM)**. SPIRICLE, INC., (U.S. CLS. 100 AND 101). SN 78-722,483. PUB. 9-12-2006. FILED 9-28-2005.
- 3,176,543 (*See Class 35 for this trademark*).
- 3,176,556. **ROCKY MOUNTAIN TECHNOLOGY GROUP (BLOCK FORM)**. ROCKY MOUNTAIN TECHNOLOGY GROUP, INC., (U.S. CLS. 100 AND 101). SN 78-726,580. PUB. 9-12-2006. FILED 10-4-2005.
- 3,176,593. **M MONTGOMERY MCCRACKEN AND DESIGN**. MONTGOMERY, MCCRACKEN, WALKER & RHOADS, LLP, (U.S. CLS. 100 AND 101). SN 78-744,226. PUB. 9-12-2006. FILED 11-1-2005.
- 3,176,610. **DEAN BANK (BLOCK FORM)**. DEAN COOPERATIVE BANK, (U.S. CLS. 100 AND 101). SN 78-747,477. PUB. 9-12-2006. FILED 11-4-2005.
- 3,176,614. **AUTONET (BLOCK FORM)**. AUTONET USA, INC, (U.S. CLS. 100 AND 101). SN 78-747,885. PUB. 9-12-2006. FILED 11-5-2005.
- 3,176,615. **DOINK (BLOCK FORM)**. DOINK, INC., (U.S. CLS. 100 AND 101). SN 78-747,971. PUB. 9-12-2006. FILED 11-5-2005.
- 3,176,622. **YES IT CAN (BLOCK FORM)**. CITYON SYSTEMS, INC., (U.S. CLS. 100 AND 101). SN 78-748,940. PUB. 9-12-2006. FILED 11-7-2005.
- 3,176,660 (*See Class 35 for this trademark*).
- 3,176,670. **911 NERDS (BLOCK FORM)**. 911 NERDS, LLC, (U.S. CLS. 100 AND 101). SN 78-760,765. PUB. 9-12-2006. FILED 11-24-2005.
- 3,176,683. **INSPIRED THINKING - ADVANCING CANCER RESEARCH (BLOCK FORM)**. AMPLIMED CORPORATION, (U.S. CLS. 100 AND 101). SN 78-764,369. PUB. 9-12-2006. FILED 12-1-2005.
- 3,176,685. **PRECIPIA SYSTEMS (BLOCK FORM)**. PRECIPIA SYSTEMS, INC., (U.S. CLS. 100 AND 101). SN 78-764,477. PUB. 9-12-2006. FILED 12-1-2005.
- 3,176,691. **RXAMINER (STYLIZED)**. MEDASSIS, INC, (U.S. CLS. 100 AND 101). SN 78-765,390. PUB. 9-12-2006. FILED 12-2-2005.
- 3,176,695 (*See Class 37 for this trademark*).
- 3,176,696 (*See Class 37 for this trademark*).
- 3,176,762. **NMD NATIONAL MOLD DETECTION AND DESIGN**. NATIONAL MOLD DETECTION, LLC, (U.S. CLS. 100 AND 101). SN 78-777,269. PUB. 9-12-2006. FILED 12-20-2005.
- 3,176,832. **MISCELLANEOUS DESIGN**. CHAD W. MOODY P.C., (U.S. CLS. 100 AND 101). SN 78-782,442. PUB. 9-12-2006. FILED 12-29-2005.
- 3,176,833. **HYPERVISTA TECHNOLOGIES (BLOCK FORM)**. HYPERVISTA TECHNOLOGIES, LLC, (U.S. CLS. 100 AND 101). SN 78-782,450. PUB. 9-12-2006. FILED 12-29-2005.
- 3,176,855. **JORDAN DESIGN STUDIO (BLOCK FORM)**. JORDAN, NATASHA, (U.S. CLS. 100 AND 101). SN 78-783,775. PUB. 9-12-2006. FILED 1-3-2006.
- 3,176,871. **THE WINNING WAY (BLOCK FORM)**. JORDAN, J. ALAN, (U.S. CLS. 100 AND 101). SN 78-785,022. PUB. 9-12-

2006. FILED 1-4-2006.
 3,176,876. **AE GLOBALAGENT AND DESIGN. AUTO EUROPE, LLC**, (U.S. CLS. 100 AND 101). SN 78-785,227. PUB. 9-12-2006. FILED 1-4-2006.
 3,176,885. **WE PROTECT YOUR CREATIVITY (BLOCK FORM)**. EDWARD M. LIVINGSTON, P.A., (U.S. CLS. 100 AND 101). SN 78-785,700. PUB. 9-12-2006. FILED 1-5-2006.
 3,176,903. **SF SHARTSIS FRIESE LLP AND DESIGN. SHARTSIS FRIESE LLP**, (U.S. CLS. 100 AND 101). SN 78-786,601. PUB. 9-12-2006. FILED 1-6-2006.
 3,176,909. **24/7 TECHNOLOGIES AND DESIGN. 24/7 TECHNOLOGIES**, (U.S. CLS. 100 AND 101). SN 78-786,893. PUB. 9-12-2006. FILED 1-6-2006.
 3,176,913. **NETFLYERS (BLOCK FORM)**. DAUKSZA, LEONARD, (U.S. CLS. 100 AND 101). SN 78-787,003. PUB. 9-12-2006. FILED 1-7-2006.
 3,176,946. **SEARCHABC (BLOCK FORM)**. MAINSTREAM ADVERTISING, INC., (U.S. CLS. 100 AND 101). SN 78-789,264. PUB. 9-12-2006. FILED 1-11-2006.
 3,176,949. **THAT COMPUTER CHICK (BLOCK FORM)**. THAT COMPUTER CHICK, LLC, (U.S. CLS. 100 AND 101). SN 78-789,285. PUB. 9-12-2006. FILED 1-11-2006.
 3,176,952 (See Class 36 for this trademark).
 3,176,973. **DRIVECRASH (BLOCK FORM)**. ARTIFICIAL INTELLIGENCE NETWORKS, INC., (U.S. CLS. 100 AND 101). SN 78-791,200. PUB. 9-12-2006. FILED 1-13-2006.
 3,177,004 (See Class 35 for this trademark).
 3,177,020. **SEARCHMARKET (BLOCK FORM)**. MATTHEWS, RAYMOND, G., (U.S. CLS. 100 AND 101). SN 78-793,480. PUB. 9-12-2006. FILED 1-18-2006.
 3,177,025. **DURSEM (BLOCK FORM)**. LIN, GERARD, (U.S. CLS. 100 AND 101). SN 78-793,501. PUB. 9-12-2006. FILED 1-18-2006.
 3,177,026. **DURMAIL (BLOCK FORM)**. LIN, GERARD, (U.S. CLS. 100 AND 101). SN 78-793,503. PUB. 9-12-2006. FILED 1-18-2006.
 3,177,029. **CUREMARK (BLOCK FORM)**. CUREMARK, LLC, (U.S. CLS. 100 AND 101). SN 78-793,664. PUB. 9-12-2006. FILED 1-18-2006.
 3,177,034. **FLASHTURN (BLOCK FORM)**. HORIZON BUSINESS CONCEPTS, INC., (U.S. CLS. 100 AND 101). SN 78-793,787. PUB. 9-12-2006. FILED 1-18-2006.
 3,177,045. **MAKE YOUR IDEAS UNTOUCHABLE (BLOCK FORM)**. WOODARD, EMHARDT, MORIARTY, MCNETT, & HENRY LLP, (U.S. CLS. 100 AND 101). SN 78-793,984. PUB. 9-12-2006. FILED 1-18-2006.
 3,177,077. **IMAGINEGRAFX (BLOCK FORM)**. GUY, STEPHEN L., (U.S. CLS. 100 AND 101). SN 78-794,837. PUB. 9-12-2006. FILED 1-19-2006.
 3,177,079. **FUNDAMENTAL DRIVER STUDY (BLOCK FORM)**. FUNDAMENTAL LABOR STRATEGIES, INC., (U.S. CLS. 100 AND 101). SN 78-794,897. PUB. 9-12-2006. FILED 1-19-2006.
 3,177,120. **UNIQUIFY (BLOCK FORM)**. UNIQUIFY, INC., (U.S. CLS. 100 AND 101). SN 78-797,501. PUB. 9-12-2006. FILED 1-23-2006.
 3,177,136 (See Class 16 for this trademark).
 3,177,139. **XSELERATE AND DESIGN**. SELECTIVE INSURANCE GROUP, INC., (U.S. CLS. 100 AND 101). SN 78-801,147. PUB. 9-12-2006. FILED 1-27-2006.
 3,177,148. **FLOOD ONLINE (BLOCK FORM)**. SELECTIVE INSURANCE GROUP, INC., (U.S. CLS. 100 AND 101). SN 78-808,722. PUB. 9-12-2006. FILED 2-7-2006.
 3,177,152 (See Class 38 for this trademark).
 3,177,179 (See Class 39 for this trademark).
 3,177,191 (See Class 9 for this trademark).
 3,177,200 (See Class 7 for this trademark).
 3,177,201 (See Class 35 for this trademark).
 3,177,205. **TECHMAIL (STYLIZED)**. NT TOOL KABUSHIKI-KAISHA, (U.S. CLS. 100 AND 101). SN 79-009,535. PUB. 9-12-2006. FILED 7-7-2004.
 3,177,206. **TECHCALL (STYLIZED)**. NT TOOL KABUSHIKI-KAISHA, (U.S. CLS. 100 AND 101). SN 79-009,536. PUB. 9-12-2006. FILED 7-7-2004.
 3,177,214 (See Class 1 for this trademark).
 3,177,215 (See Class 9 for this trademark).
 3,177,242 (See Class 6 for this trademark).
 3,177,266 (See Class 9 for this trademark).

3,177,280 (See Class 1 for this trademark).
 3,177,288 (See Class 9 for this trademark).
 3,177,297 (See Class 9 for this trademark).
 3,177,305 (See Class 1 for this trademark).
 3,177,308 (See Class 6 for this trademark).

CLASS 43—HOTEL AND RESTAURANT SERVICES

3,175,767. **FUEL**. WLADIS, JEREMY S, (U.S. CLS. 100 AND 101). SN 76-353,104. PUB. 9-12-2006. FILED 12-26-2001.
 3,175,937 (See Class 25 for this trademark).
 3,175,941 (See Class 30 for this trademark).
 3,176,027. **BELLO MACHRE (BLOCK FORM)**. BELLO MACHRE, INC., (U.S. CLS. 100 AND 101). SN 78-476,216. PUB. 9-12-2006. FILED 8-31-2004.
 3,176,044. **BAGEL BAGEL CAFÉ EST. 1991 AND DESIGN**. BAGEL BAGEL FRANCHISE SYSTEMS, INC., (U.S. CLS. 100 AND 101). SN 78-495,392. PUB. 9-12-2006. FILED 10-6-2004.
 3,176,087. **CROW'S BURGER SHOP AND DESIGN**. MARTINEZ, KAREN, (U.S. CLS. 100 AND 101). SN 78-534,461. PUB. 9-12-2006. FILED 12-17-2004.
 3,176,091. **CUSTOM ACCOMMODATIONS, INC. AND DESIGN**. CUSTOM ACCOMMODATIONS, INC., (U.S. CLS. 100 AND 101). SN 78-537,202. PUB. 9-12-2006. FILED 12-22-2004.
 3,176,141. **MISCELLANEOUS DESIGN**. TIANJIN GOUBULI STEAMED BUN AND FOOD AND DRINK (GROUP) CO., (U.S. CLS. 100 AND 101). SN 78-583,593. PUB. 5-23-2006. FILED 3-9-2005.
 3,176,155. **FOR DRINKING FANS WITH A SPORTS PROBLEM AND DESIGN**. BIG HEADS MANAGEMENT, INC., (U.S. CLS. 100 AND 101). SN 78-592,135. PUB. 9-12-2006. FILED 3-22-2005.
 3,176,216. **ESPOS MEXICAN FOOD (BLOCK FORM)**. ESPINOZA, DAVID C., (U.S. CLS. 100 AND 101). SN 78-620,557. PUB. 9-12-2006. FILED 5-1-2005.
 3,176,233. **OLD SCHOOL BURGERS BACK TO BASICS (BLOCK FORM)**. CLUBHOUSE SPORTS CORPORATION, (U.S. CLS. 100 AND 101). SN 78-625,396. PUB. 9-12-2006. FILED 5-9-2005.
 3,176,234. **OLD SCHOOL BURGERS BACK TO BASICS AND DESIGN**. CLUBHOUSE SPORTS CORPORATION, (U.S. CLS. 100 AND 101). SN 78-625,405. PUB. 9-12-2006. FILED 5-9-2005.
 3,176,254. **BIG SUR RIVER INN & RESTAURANT AND DESIGN**. THE RIVER INN, LP, (U.S. CLS. 100 AND 101). SN 78-628,815. PUB. 9-12-2006. FILED 5-12-2005.
 3,176,261. **HAMBURGUESAS MEMORABLES AND DESIGN**. GUILLERMO RAMIREZ ORDOÑEZ, (U.S. CLS. 100 AND 101). SN 78-629,584. PUB. 9-12-2006. FILED 5-13-2005.
 3,176,277. **CAFE SOLMAR AND DESIGN**. CAFE SOLMAR, LLC, (U.S. CLS. 100 AND 101). SN 78-631,995. PUB. 9-12-2006. FILED 5-18-2005.
 3,176,328. **HOTEL PLANNER YOUR HOTEL EVENT SPECIALIST AND DESIGN**. LEXYL TRAVEL TECHNOLOGIES, INC., (U.S. CLS. 100 AND 101). SN 78-643,771. PUB. 9-12-2006. FILED 6-4-2005.
 3,176,363. **LA SIBERIA MEXICANA (BLOCK FORM)**. RODRIGUEZ, MANUEL M., (U.S. CLS. 100 AND 101). SN 78-653,561. PUB. 9-12-2006. FILED 6-17-2005.
 3,176,429. **SANTALUZ (BLOCK FORM)**. SANTALUZ, LLC, (U.S. CLS. 100 AND 101). SN 78-676,293. PUB. 9-12-2006. FILED 7-22-2005.
 3,176,437. **SAM & HARRY'S (STYLIZED)**. S&H RESTAURANT COMPANY, (U.S. CLS. 100 AND 101). SN 78-681,456. PUB. 9-12-2006. FILED 7-29-2005.
 3,176,462. **LIGHTHOUSE RESTAURANT (BLOCK FORM)**. CHART HOUSE, INC., THE, (U.S. CLS. 100 AND 101). SN 78-694,741. PUB. 9-12-2006. FILED 8-17-2005.
 3,176,501. **WINGS ETC. (BLOCK FORM)**. WINGS ETC., INC., (U.S. CLS. 100 AND 101). SN 78-711,629. PUB. 9-12-2006. FILED 9-13-2005.
 3,176,503 (See Class 30 for this trademark).
 3,176,522. **KING'S FISHHOUSE K F H EST. 1945 AND**

- DESIGN.** UNIVERSITY RESTAURANT GROUP, INC., (U.S. CLS. 100 AND 101). SN 78-716,838. PUB. 9-12-2006. FILED 9-20-2005.
- 3,176,557. **THE CUP JOINT (BLOCK FORM).** MEIERS, JAMES F., (U.S. CLS. 100 AND 101). SN 78-727,027. PUB. 9-12-2006. FILED 10-5-2005.
- 3,176,591. **ELDERTREE LLC GERIATRIC CARE MANAGEMENT SERVICES AND DESIGN.** ELDERTREE, LLC, (U.S. CLS. 100 AND 101). SN 78-744,150. PUB. 9-12-2006. FILED 11-1-2005.
- 3,176,664. **DOS AMIGOS ~ BAJA CAFE (BLOCK FORM).** CANTINA DOS AMIGOS, INC., (U.S. CLS. 100 AND 101). SN 78-757,688. PUB. 9-12-2006. FILED 11-19-2005.
- 3,176,680. **.QUATORZE. AND DESIGN.** TATMAR RESTAURANT, INC., (U.S. CLS. 100 AND 101). SN 78-763,138. PUB. 9-12-2006. FILED 11-30-2005.
- 3,176,720. **WIRED PUPPY SPECIALTY COFFEE & TEA AND DESIGN.** BEANS & MACHINES INC., (U.S. CLS. 100 AND 101). SN 78-773,453. PUB. 9-12-2006. FILED 12-14-2005.
- 3,176,769 (*See Class 35 for this trademark.*)
- 3,176,774. **ALWAYSONVACATION (BLOCK FORM).** VACATION RENTER SOLUTIONS, LLC, (U.S. CLS. 100 AND 101). SN 78-778,687. PUB. 9-12-2006. FILED 12-21-2005.
- 3,176,792. **LEE'S DELI (BLOCK FORM).** STERLING M. ENTERPRISES, INC., (U.S. CLS. 100 AND 101). SN 78-779,474. PUB. 9-12-2006. FILED 12-22-2005.
- 3,176,808 (*See Class 29 for this trademark.*)
- 3,176,866. **CHICAGO STYLE PIZZERIA AND DESIGN.** CHICAGO STYLE PIZZERIA, (U.S. CLS. 100 AND 101). SN 78-784,746. PUB. 9-12-2006. FILED 1-4-2006.
- 3,176,872. **THE ACTIVE RETIREMENT LIFESTYLE YOU DESERVE, IN THE NEIGHBORHOOD YOU LOVE (BLOCK FORM).** STRATFORD COMPANIES, LLC, THE, (U.S. CLS. 100 AND 101). SN 78-785,025. PUB. 9-12-2006. FILED 1-4-2006.
- 3,176,886. **LA CASITA MEXICANA (BLOCK FORM).** LA CASITA MEXICANA, INC., (U.S. CLS. 100 AND 101). SN 78-785,709. PUB. 9-12-2006. FILED 1-5-2006.
- 3,176,943. **CURRY IN THE BOX ASIAN CUISINE AND DESIGN.** CURRY IN THE BOX LLC, (U.S. CLS. 100 AND 101). SN 78-789,170. PUB. 9-12-2006. FILED 1-11-2006.
- 3,176,983. **THE JERK PIT AND DESIGN.** THE JERK PIT LLC., (U.S. CLS. 100 AND 101). SN 78-791,880. PUB. 9-12-2006. FILED 1-13-2006.
- 3,176,998. **WORLDPASS (BLOCK FORM).** WORLDPASS TRAVEL GROUP, LLC, (U.S. CLS. 100 AND 101). SN 78-792,809. PUB. 9-12-2006. FILED 1-17-2006.
- 3,177,009. **IT'S NOT JUST ANY SUSHI, IT'S "HISSHO SUSHI". (BLOCK FORM).** LWIN FAMILY CO., DBA HISSHO SUSHI, (U.S. CLS. 100 AND 101). SN 78-793,043. PUB. 9-12-2006. FILED 1-17-2006.
- 3,177,012. **NATURE BOY AND DESIGN.** NATURE BOY, INC., (U.S. CLS. 100 AND 101). SN 78-793,160. PUB. 9-12-2006. FILED 1-17-2006.
- 3,177,071. **BEV'S ON THE RIVER AND DESIGN.** MIDWEST FRANCHISE-IOWA, LLC, (U.S. CLS. 100 AND 101). SN 78-794,658. PUB. 9-12-2006. FILED 1-19-2006.
- 3,177,135. **MISCELLANEOUS DESIGN.** TUMBLEWEED, INC., (U.S. CLS. 100 AND 101). SN 78-800,139. PUB. 9-12-2006. FILED 1-26-2006.
- 3,177,178. **BONE BOOTH (BLOCK FORM).** PETSMAST STORE SUPPORT GROUP, INC., (U.S. CLS. 100 AND 101). SN 78-837,705. PUB. 9-12-2006. FILED 3-15-2006.
- 3,177,183. **RED ROOF INN & SUITES (STYLIZED).** RRI FINANCIAL, INC., (U.S. CLS. 100 AND 101). SN 78-841,891. PUB. 9-12-2006. FILED 3-21-2006.
- 3,177,186. **CHILD'S AND DESIGN.** BRINKER INTERNATIONAL HOLDINGS, L.P., (U.S. CLS. 100 AND 101). SN 78-850,387. PUB. 9-12-2006. FILED 3-30-2006.
- 3,177,241 (*See Class 39 for this trademark.*)
- SITY HOSPITALS HEALTH SYSTEM, INC., (U.S. CLS. 100 AND 101). SN 76-552,453. PUB. 9-12-2006. FILED 9-26-2003.
- 3,175,867. **SONA MEDSPA EXPERIENCE (BLOCK FORM).** SONA MEDSPA INTERNATIONAL, INC., (U.S. CLS. 100 AND 101). SN 76-644,336. PUB. 9-12-2006. FILED 8-8-2005.
- 3,175,892. **THE CIRCULATORY CENTERS (BLOCK FORM).** CIRCULATORY CENTERS OF AMERICA, LLC, (U.S. CLS. 100 AND 101). SN 76-649,917. PUB. 9-12-2006. FILED 11-7-2005.
- 3,175,913. **GROTTO HUMANITARIAN FOUNDATION BRINGING SPECIAL SMILES TO SPECIAL KIDS! AND DESIGN.** SUPREME COUNCIL MYSTIC ORDER OF VEILED PROPHETS OF THE ENCHANTED REALM, (U.S. CLS. 100 AND 101). SN 76-652,708. PUB. 9-12-2006. FILED 1-3-2006.
- 3,175,929. **DETECTIMED (BLOCK FORM).** AMERICAN INSTITUTE OF TOXICOLOGY, INC., (U.S. CLS. 100 AND 101). SN 76-653,424. PUB. 9-12-2006. FILED 1-17-2006.
- 3,175,930. **MISCELLANEOUS DESIGN.** NEWMAN, LAWRENCE C., (U.S. CLS. 100 AND 101). SN 76-653,478. PUB. 9-12-2006. FILED 1-18-2006.
- 3,175,978. **HCS HEALTH CARE SOLUTIONS BECAUSE BEING HOME IS PART OF BEING WELL. AND DESIGN.** LINCARE LICENSING INC., (U.S. CLS. 100 AND 101). SN 78-381,662. PUB. 9-12-2006. FILED 3-10-2004.
- 3,175,987 (*See Class 5 for this trademark.*)
- 3,176,022 (*See Class 35 for this trademark.*)
- 3,176,066 (*See Class 25 for this trademark.*)
- 3,176,093 (*See Class 35 for this trademark.*)
- 3,176,128. **MEALS & MENU MAGIC, INC. MENU PLANNING...JUST LIKE MAGIC! AND DESIGN.** MEALS AND MENU MAGIC, INC., (U.S. CLS. 100 AND 101). SN 78-571,599. PUB. 9-12-2006. FILED 2-21-2005.
- 3,176,158. **VENICE BEACH TAN AND DESIGN.** BIRMINGHAM ATHLETIC CLUB LLC, (U.S. CLS. 100 AND 101). SN 78-595,300. PUB. 9-12-2006. FILED 3-25-2005.
- 3,176,163. **SPA PHOENIX (BLOCK FORM).** SPA PHOENIX HOLDINGS, LLC, (U.S. CLS. 100 AND 101). SN 78-598,332. PUB. 9-12-2006. FILED 3-30-2005.
- 3,176,169. **SPA ELEVEN (BLOCK FORM).** MEME DELRAY BEACH, LLC., (U.S. CLS. 100 AND 101). SN 78-599,346. PUB. 9-12-2006. FILED 3-31-2005.
- 3,176,183 (*See Class 35 for this trademark.*)
- 3,176,205. **BEYOND GOOD CARE (BLOCK FORM).** THE HEALTH NETWORK OF CHESTER COUNTY HOSPITAL, (U.S. CLS. 100 AND 101). SN 78-614,433. PUB. 9-12-2006. FILED 4-22-2005.
- 3,176,226. **QUIEROSABER (BLOCK FORM).** AMERICAN SOCIAL HEALTH ASSOCIATION, (U.S. CLS. 100 AND 101). SN 78-623,460. PUB. 9-12-2006. FILED 5-5-2005.
- 3,176,238. **TLC HEALTHCARE (BLOCK FORM).** TLC HEALTHCARE QUALITY IMPROVEMENT ORGANIZATION, INC., (U.S. CLS. 100 AND 101). SN 78-625,931. PUB. 9-12-2006. FILED 5-9-2005.
- 3,176,249. **SIMPLY MORE INTELLIGENT (BLOCK FORM).** ISNESIX, INC., (U.S. CLS. 100 AND 101). SN 78-628,092. PUB. 9-12-2006. FILED 5-11-2005.
- 3,176,256. **TUCSON MEDICAL CENTER (BLOCK FORM).** TUCSON MEDICAL CENTER, (U.S. CLS. 100 AND 101). SN 78-629,002. PUB. 9-12-2006. FILED 5-12-2005.
- 3,176,257. **EL DORADO HOSPITAL (BLOCK FORM).** EL DORADO HOSPITAL, (U.S. CLS. 100 AND 101). SN 78-629,004. PUB. 9-12-2006. FILED 5-12-2005.
- 3,176,271. **MAINEHEALTH (BLOCK FORM).** MAINEHEALTH, (U.S. CLS. 100 AND 101). SN 78-630,660. PUB. 9-12-2006. FILED 5-16-2005.
- 3,176,289. **FLOSSIN IN CLAWSON (BLOCK FORM).** ALAN R. GRODIN, D.D.S., P.L.C., (U.S. CLS. 100 AND 101). SN 78-634,627. PUB. 9-12-2006. FILED 5-23-2005.
- 3,176,381. **ECOSCAPE SOLUTIONS GROUP AND DESIGN.** ECOSCAPE SOLUTIONS GROUP, INC., (U.S. CLS. 100 AND 101). SN 78-657,853. PUB. 9-12-2006. FILED 6-24-2005.
- 3,176,423. **ROLF'S HAIR . MAKEUP . NAIL . FACE . BODY (STYLIZED).** ROLF'S LLC, (U.S. CLS. 100 AND 101). SN 78-669,988. PUB. 4-4-2006. FILED 7-13-2005.
- 3,176,510. **INSIGHT X ONSITE (BLOCK FORM).** EXAMINETICS, INC., (U.S. CLS. 100 AND 101). SN 78-714,081. PUB. 9-12-2006. FILED 9-15-2005.

CLASS 44—MEDICAL, BEAUTY AND AGRICULTURAL SERVICES

- 3,175,789 (*See Class 16 for this trademark.*)
- 3,175,790. **TO HEAL. TO TEACH. TO DISCOVER..** UNIVER-

- 3,176,572. **MISCELLANEOUS DESIGN**. FAIRMONT ORTHOPEDICS & SPORTS MEDICINE, P.A., DBA CENTER FOR SPECIALTY CARE, (U.S. CLS. 100 AND 101). SN 78-734,804. PUB. 9-12-2006. FILED 10-17-2005.
- 3,176,716. **SOAPY PUPPY DOG SPA AND DESIGN**. A SOAPY PUPPY INC., (U.S. CLS. 100 AND 101). SN 78-772,688. PUB. 9-12-2006. FILED 12-13-2005.
- 3,176,737 (*See Class 16 for this trademark*).
- 3,176,741. **SOUTHCOAST RECOVERY (BLOCK FORM)**. SOBRIETY SERVICES, (U.S. CLS. 100 AND 101). SN 78-775,214. PUB. 9-12-2006. FILED 12-16-2005.
- 3,176,754. **BOUNCE BACK (BLOCK FORM)**. UNLIMITED DEVELOPMENT, INC., (U.S. CLS. 100 AND 101). SN 78-776,213. PUB. 9-12-2006. FILED 12-19-2005.
- 3,176,765. **MISCELLANEOUS DESIGN**. GRANITE EQUINE MASSAGE, (U.S. CLS. 100 AND 101). SN 78-777,646. PUB. 9-12-2006. FILED 12-20-2005.
- 3,176,766. **MISCELLANEOUS DESIGN**. EMERGENCY DENTAL CARE, LLC, (U.S. CLS. 100 AND 101). SN 78-777,660. PUB. 9-12-2006. FILED 12-20-2005.
- 3,176,854. **TRIMP3 (BLOCK FORM)**. ENVOY GLOBAL, INC., (U.S. CLS. 100 AND 101). SN 78-783,742. PUB. 9-12-2006. FILED 1-3-2006.
- 3,176,878. **VIRGINIA BREAST CENTER AND DESIGN**. VIRGINIA BREAST CENTER, INC., (U.S. CLS. 100 AND 101). SN 78-785,303. PUB. 9-12-2006. FILED 1-5-2006.
- 3,176,919. **THE SIGN OF EXCELLENCE IN EMERGENCY MEDICINE (BLOCK FORM)**. EMERGENCY MEDICAL ASSOCIATES OF NEW JERSEY, (U.S. CLS. 100 AND 101). SN 78-787,429. PUB. 9-12-2006. FILED 1-9-2006.
- 3,176,944. **DRUGDIGEST (BLOCK FORM)**. EXPRESS SCRIPTS, INC., (U.S. CLS. 100 AND 101). SN 78-789,247. PUB. 9-12-2006. FILED 1-11-2006.
- 3,176,954. **SIR SPA (BLOCK FORM)**. HILLMAN THOMPSON, (U.S. CLS. 100 AND 101). SN 78-790,032. PUB. 9-12-2006. FILED 1-12-2006.
- 3,176,961. **I HATE CPAP! (BLOCK FORM)**. SHAPIRA DENTAL CARE, LTD., DBA DELANY DENTAL CARE, (U.S. CLS. 100 AND 101). SN 78-790,680. PUB. 9-12-2006. FILED 1-12-2006.
- 3,176,963. **SASSOON STUDIO (BLOCK FORM)**. THE PROCTER & GAMBLE COMPANY, (U.S. CLS. 100 AND 101). SN 78-791,001. PUB. 9-12-2006. FILED 1-13-2006.
- 3,176,988. **EDUCATION TREATMENT SUCCESS FOR EVERY CHILD (BLOCK FORM)**. PENDLETON ACADEMIES, (U.S. CLS. 100 AND 101). SN 78-792,183. PUB. 9-12-2006. FILED 1-16-2006.
- 3,177,000. **JUNG AND DESIGN**. MARK R. JUNG D. D. S., P. C., (U.S. CLS. 100 AND 101). SN 78-792,838. PUB. 9-12-2006. FILED 1-17-2006.
- 3,177,215 (*See Class 9 for this trademark*).
- 3,177,294 (*See Class 5 for this trademark*).
2006. FILED 9-19-2005.
- 3,176,640 (*See Class 35 for this trademark*).
- 3,176,682. **MISCELLANEOUS DESIGN**. ZHAO, WEI (EDDIE), (U.S. CLS. 100 AND 101). SN 78-764,099. PUB. 9-12-2006. FILED 11-30-2005.
- 3,176,714 (*See Class 36 for this trademark*).
- 3,176,718. **LOVE IS YOUR GREATEST GIFT AND DESIGN**. BATISTE, LIONEL, (U.S. CLS. 100 AND 101). SN 78-773,051. PUB. 9-12-2006. FILED 12-14-2005.
- 3,176,770. **RELATIONSHIP 911 (BLOCK FORM)**. BLAKLEY, MARK, (U.S. CLS. 100 AND 101). SN 78-777,993. PUB. 9-12-2006. FILED 12-21-2005.
- 3,176,828. **JUST FOR TONIGHT JUST4TONIGHT.COM AND DESIGN**. JUST FOR TONIGHT, INC., (U.S. CLS. 100 AND 101). SN 78-782,026. PUB. 9-12-2006. FILED 12-28-2005.
- 3,176,879 (*See Class 41 for this trademark*).
- 3,176,888 (*See Class 41 for this trademark*).
- 3,176,975. **WORKERCHECK (BLOCK FORM)**. HR FIRST CONTACT, L.L.C., (U.S. CLS. 100 AND 101). SN 78-791,474. PUB. 9-12-2006. FILED 1-13-2006.
- 3,177,072. **"IF KNOWLEDGE IS POWER...WHY BE WEAK?" (BLOCK FORM)**. SONNE, WARREN J, (U.S. CLS. 100 AND 101). SN 78-794,666. PUB. 9-12-2006. FILED 1-19-2006.
- 3,177,271 (*See Class 35 for this trademark*).
- 3,177,292 (*See Class 9 for this trademark*).

* * * * *

CLASS 45—PERSONAL SERVICES

- 3,175,762 (*See Class 3 for this trademark*).
- 3,175,967. **COMPATIBILITY MATCHING SYSTEM (BLOCK FORM)**. EHARMONY.COM, INC., (U.S. CLS. 100 AND 101). SN 78-333,922. PUB. 9-12-2006. FILED 11-26-2003.
- 3,175,991. **UNITED STATES BOMB DOGS, INC. AND DESIGN**. UNITED STATES BOMB DOGS, INC., (U.S. CLS. 100 AND 101). SN 78-409,649. PUB. 9-12-2006. FILED 4-28-2004.
- 3,176,082 (*See Class 41 for this trademark*).
- 3,176,084 (*See Class 41 for this trademark*).
- 3,176,098. **CHRISMUKKAH AND DESIGN**. CHRISMUKKAH.COM, (U.S. CLS. 100 AND 101). SN 78-546,664. PUB. 9-12-2006. FILED 1-12-2005.
- 3,176,369. **FUNERARIA DEL ANGEL AND DESIGN**. SCI MANAGEMENT L.P., (U.S. CLS. 100 AND 101). SN 78-654,612. PUB. 9-12-2006. FILED 6-20-2005.
- 3,176,399 (*See Class 35 for this trademark*).
- 3,176,473. **JUSTCARE (BLOCK FORM)**. JUSTICEWORKS YOUTHCARE, INC., (U.S. CLS. 100 AND 101). SN 78-700,589. PUB. 9-12-2006. FILED 8-25-2005.
- 3,176,519. **QUEPASA (BLOCK FORM)**. QUEPASA CORPORATION, (U.S. CLS. 100 AND 101). SN 78-716,062. PUB. 9-12-

SECTION 2.—PRIOR UNITED STATES CLASSIFICATION

COLLECTIVE MEMBERSHIP MARKS

CLASS 200—COLLECTIVE MEMBERSHIP

3,176,659. **MISCELLANEOUS DESIGN.** THE CHI PHI FRATERNITY, INC., SN 78-757,099. PUB. 9-12-2006. FILED 11-18-2005.

3,176,661. **CHI PHI 1824 AND DESIGN.** THE CHI PHI FRATERNITY, INC., SN 78-757,262. PUB. 9-12-2006. FILED 11-18-2005.

CERTIFICATION MARKS

CLASS B—SERVICES

3,175,870. **ANAB ACCREDITED AND DESIGN.** AMERICAN NATIONAL STANDARDS INSTITUTE, INCORPORATED, AND AMERICAN SOCIETY FOR QUALITY, SN 76-646,139. PUB. 9-12-2006. FILED 9-2-2005.

3,175,954. **EMPLOYER OF CHOICE.** EMPLOYER OF CHOICE, INC., SN 78-273,040. PUB. 9-12-2006. FILED 7-11-2003.

* * * * *

TRADEMARK REGISTRATIONS ISSUED UNDER SECTION 1(d)

The following marks have registered on the Principal Register pursuant to the intent-to-use provisions of Section 1(d) of the Trademark Act of 1946, as amended.

SECTION 1.— INTERNATIONAL CLASSIFICATION

The short titles associated below with the international class numbers are terms designed merely for quick identification and are not an official part of the international classification. The full names of international classes are given in section 6.1 of the trademark rules of practice.

The designation "U.S. Cl." appearing in this section refers to the U.S. class in effect prior to Sep. 1, 1973 rather than the international class which applies to applications filed on or after that date. For adoption of international classification see notice in the OFFICIAL GAZETTE of Jun. 26, 1973 (911 O.G. TM 210).

Application in more than one class

3,177,324. TROPICAL CHEESE INDUSTRIES, INC., PERTH AMBOY, NJ. SN 75-449,634. PUB. 6-1-1999, FILED 3-13-1998.

3,177,330. QIOSK.COM, INC., GRAND CAYMAN, CAYMAN ISLANDS. SN 76-097,100. PUB. 11-15-2005, FILED 7-25-2000.



OWNER OF U.S. REG. NOS. 1,601,142, 1,707,012, AND 1,893,464.

THE LINING SHOWN IN THE DRAWING IS A FEATURE OF THE MARK AND IS NOT INTENDED TO INDICATE COLOR.

CLASS 29—MEATS AND PROCESSED FOODS

FOR CHEESE; SOUR CREAM; HEAVY CREAM; YOGURT; BUTTER; MARGARINE; PROCESSED LUNCHEON MEATS; SOUP; PREPARED FOODS, NAMELY, CHICKEN AND RICE, SHREDDED BEEF, PORK AND RICE, FRIED BANANAS, AND SHRIMP AND RICE; DRINKABLE YOGURT; AND MILK-BASED FRUIT DRINK (U.S. CL. 46).

FIRST USE 4-29-1983; IN COMMERCE 4-29-1983.

CLASS 30—STAPLE FOODS

FOR SALSAS; DESSERTS, NAMELY FLAN, CHEESE-CAKES, AND BREAD PUDDING; TORTILLAS; AREPAS; EMPANDAS; TAMALES; BURITTOS; ENCHILADAS; AND RICE-BASED FOOD BEVERAGES (U.S. CL. 46).

FIRST USE 8-15-2006; IN COMMERCE 8-15-2006.

CLASS 32—LIGHT BEVERAGES

FOR JUICES, NAMELY, FRUIT JUICES, FRUIT NECTARS, AND VEGETABLE JUICES; AND NON-ALCOHOLIC BEVERAGES, NAMELY, FRUIT DRINKS (U.S. CLS. 45, 46 AND 48).

FIRST USE 8-15-2006; IN COMMERCE 8-15-2006.

QMAGS

CLASS 9—ELECTRICAL AND SCIENTIFIC APPARATUS

FOR DOWNLOADABLE ELECTRONIC PUBLICATIONS IN THE NATURE OF RE-PUBLISHED AND FORMATTED JOURNALS IN A WIDE RANGE OF FIELDS (U.S. CLS. 21, 23, 26, 36 AND 38).

FIRST USE 1-0-2001; IN COMMERCE 1-0-2001.

CLASS 41—EDUCATION AND ENTERTAINMENT

FOR ELECTRONIC PUBLISHING SERVICES, NAMELY, RE-PUBLICATION AND FORMATTING OF TEXT AND GRAPHIC WORKS OF OTHERS FEATURING A WIDE RANGE OF FIELDS ON A GLOBAL COMPUTER NETWORK (U.S. CLS. 100, 101 AND 107).

FIRST USE 1-0-2001; IN COMMERCE 1-0-2001.

3,177,334. IMAGE ONLINE DESIGN, INC., SAN LUIS OBISPO, CA. SN 76-188,422. PUB. 6-11-2002, FILED 1-2-2001.

.WEB

CLASS 9—ELECTRICAL AND SCIENTIFIC APPARATUS

FOR COMPUTER ACCESSORIES, NAMELY, MOUSE PADS, CD HOLDERS (U.S. CLS. 21, 23, 26, 36 AND 38).

FIRST USE 5-0-2006; IN COMMERCE 5-0-2006.

CLASS 18—LEATHER GOODS

FOR FANNY PACKS AND BACKPACKS (U.S. CLS. 1, 2, 3, 22 AND 41).

FIRST USE 5-0-2006; IN COMMERCE 5-0-2006.

CLASS 21—HOUSEWARES AND GLASS

FOR THERMAL INSULATOR CONTAINERS FOR FOOD OR BEVERAGES; CUPS; MUGS; BEVERAGES CAN INSULATING SLEEVES (U.S. CLS. 2, 13, 23, 29, 30, 33, 40 AND 50).

FIRST USE 5-0-2006; IN COMMERCE 5-0-2006.

CLASS 35—ADVERTISING AND BUSINESS

FOR ONLINE RETAIL STORE SERVICES FEATURING COMPUTER ACCESSORIES (U.S. CLS. 100, 101 AND 102).

FIRST USE 6-0-2006; IN COMMERCE 6-0-2006.

3,177,341. MISYS PLC, LONDON, UNITED KINGDOM. SN 76-284,003. PUB. 6-10-2003, FILED 7-12-2001.

MISYS**CLASS 9—ELECTRICAL AND SCIENTIFIC APPARATUS**

FOR COMPUTER SOFTWARE FOR DATABASE MANAGEMENT FOR USE IN THE FIELDS OF FINANCE, MEDICINE AND HEALTHCARE (U.S. CLS. 21, 23, 26, 36 AND 38).

FIRST USE 1-23-2002; IN COMMERCE 1-23-2002.

CLASS 35—ADVERTISING AND BUSINESS

FOR BUSINESS CONSULTATION; BUSINESS INFORMATION AND RESEARCH IN THE FIELDS OF TELECOMMUNICATIONS; GENERAL INFORMATION CLEARING HOUSES; MANAGEMENT OF TELECOMMUNICATIONS NETWORKS FOR OTHERS (U.S. CLS. 100, 101 AND 102).

FIRST USE 1-23-2002; IN COMMERCE 1-23-2002.

CLASS 36—INSURANCE AND FINANCIAL

FOR FINANCIAL INFORMATION IN THE NATURE OF RATES OF EXCHANGE; FINANCIAL MANAGEMENT; FINANCIAL PLANNING; FINANCIAL RESEARCH; PROVIDING INFORMATION IN THE FIELD OF BANKING AND FINANCIAL INFORMATION; COMPUTER SERVICES, NAMELY PROVIDING DATABASES IN THE FIELDS OF BANKING, TREASURY, RISK MANAGEMENT, TRADE FINANCE, DERIVATIVES, TRADING AND ACCOUNTING (U.S. CLS. 100, 101 AND 102).

FIRST USE 1-23-2002; IN COMMERCE 1-23-2002.

CLASS 38—COMMUNICATION

FOR TELECOMMUNICATIONS SERVICES, NAMELY TRANSMISSION OF DATA VIA COMPUTER NETWORKS (U.S. CLS. 100, 101 AND 104).

FIRST USE 1-23-2002; IN COMMERCE 1-23-2002.

CLASS 42—SCIENTIFIC, COMPUTER AND LEGAL SERVICES

FOR COMPUTER CONSULTATION; COMPUTER DIAGNOSTIC SERVICES; COMPUTER PROGRAMMING FOR OTHERS; COMPUTER SOFTWARE DESIGN FOR OTHERS; MAINTENANCE OF COMPUTER SOFTWARE; LEASING COMPUTER FACILITIES; TECHNICAL CONSULTATION AND RESEARCH IN THE FIELD OF TELECOMMUNICATIONS AND INFORMATION TECHNOLOGY (U.S. CLS. 100 AND 101).

FIRST USE 1-23-2002; IN COMMERCE 1-23-2002.

3,177,344. CONTINUUM INTERNATIONAL PUBLISHING GROUP LTD., THE, LONDON SE1 7NX, GREAT BRITAIN. SN 76-310,489. PUB. 5-27-2003, FILED 9-6-2001.

CONTINUUM**CLASS 9—ELECTRICAL AND SCIENTIFIC APPARATUS**

FOR PRE-RECORDED AUDIO TAPES, COMPACT DISCS, AUDIO CASSETTES AND CD ROMS FEATURING SPOKEN WORD PERFORMANCES OF LITERATURE AND PUBLISHED WORKS; CINEMATOGRAPHIC FILMS FEATURING RELIGIOUS, EDUCATIONAL, ACADEMIC, AND LITERARY SUBJECTS; ELECTRONIC PUBLICATIONS NAMELY, BOOKS, JOURNALS, ARTICLES AND NEWSLETTERS IN THE FIELD OF LITERARY WORKS RECORDED ON CD-ROMS, AUDIO CASSETTES, FLOPPY DISCS, OPTICAL DISCS AND COMPACT DISCS; ELECTRONIC DATABASES IN THE FIELD OF EDUCATIONAL, ACADEMIC, RELIGIOUS AND PROFESSIONAL LITERATURE RECORDED ON CD-ROMS, FLOPPY DISKS AND OPTICAL DISKS; COMPUTER SOFTWARE FOR CATALOGUING AND SEARCHING IN THE FIELD OF LITERATURE; DOWNLOADABLE PUBLICATIONS IN THE NATURE OF BOOKS, JOURNALS, ARTICLES AND NEWSLETTERS IN THE FIELD OF EDUCATIONAL, ACADEMIC, RELIGIOUS AND PROFESSIONAL LITERATURE (U.S. CLS. 21, 23, 26, 36 AND 38).

FIRST USE 5-0-2006; IN COMMERCE 5-0-2006.

CLASS 16—PAPER GOODS AND PRINTED MATTER

FOR NON-FICTION BOOKS ON A VARIETY OF TOPICS; NON-FICTION SCHOLARLY MONOGRAPHS IN THE FIELD OF LITERATURE; HISTORICAL, POLITICAL, SOCIAL, SPORT, CRITICISM, PERFORMING ARTS, RELIGION, SPIRITUALITY, PSYCHOLOGY, WOMEN'S STUDIES, BUSINESS AND PROFESSIONAL BOOKS; PRINTED PUBLICATIONS, NAMELY JOURNALS, CATALOGS AND NEWSLETTERS IN THE FIELD OF EDUCATION, RELIGION AND LITERATURE; PRINTED MATTER, NAMELY JOURNALS, CATALOGS AND NEWSLETTERS IN THE FIELD OF EDUCATION, RELIGION AND LITERATURE; PRINTED INSTRUCTIONAL AND TEACHING MATERIALS IN THE FIELD OF EDUCATION, RELIGION AND LITERATURE; ADDRESS BOOKS; CALENDARS; DIARIES; CATALOGUES AND DIRECTORIES OF LITERACY, EDUCATIONAL ACADEMIC, RELIGIOUS AND PROFESSIONAL LITERATURE (U.S. CLS. 2, 5, 22, 23, 29, 37, 38 AND 50).

FIRST USE 1-0-1974; IN COMMERCE 1-0-1974.

CLASS 41—EDUCATION AND ENTERTAINMENT

FOR BOOK PUBLISHING SERVICES; ELECTRONIC PUBLISHING SERVICES NAMELY, PUBLICATION OF TEXT AND GRAPHIC WORKS OF OTHERS ON CD-ROMS FEATURING LITERARY, EDUCATIONAL, ACADEMIC AND PROFESSIONAL LITERATURE; AUDIO RECORDING PRODUCTION; VIDEO TAPE PRODUCTION; ORGANIZATION OF CULTURAL EVENTS; ARRANGING AND CONDUCTING EDUCATIONAL SEMINARS, CONFERENCES AND EXHIBITIONS IN THE FIELD OF PUBLISHING; INFORMATION AND ADVISORY SERVICES RELATING TO PUBLISHING (U.S. CLS. 100, 101 AND 107).

FIRST USE 1-0-1974; IN COMMERCE 1-0-1974.

3,177,346. AL JAZEERA SATELLITE CHANNEL, DOHA, QATAR. SN 76-312,099. PUB. 6-17-2003, FILED 9-14-2001.

3,177,355. CODEXIS, INC., REDWOOD CITY, CA. SN 76-362,246. PUB. 8-19-2003, FILED 1-24-2002.



THE ENGLISH TRANSLATION OF THE MARK IS "THE ISLAND".

THE ARABIC CHARACTERS IN THE MARK TRANSLITERATE TO "AL JAZEERA" AND THIS MEANS "THE ISLAND" IN ENGLISH.

CLASS 35—ADVERTISING AND BUSINESS

FOR ADVERTISING AGENCY SERVICES; PROVIDING RADIO AND TELEVISION ADVERTISING FOR OTHERS (U.S. CLS. 100, 101 AND 102).
FIRST USE 11-1-1996; IN COMMERCE 2-10-1999.

CLASS 41—EDUCATION AND ENTERTAINMENT

FOR ENTERTAINMENT IN THE NATURE OF ONGOING TELEVISION PROGRAMS IN THE FIELDS OF NEWS, INTERVIEWS, COMEDY, VARIETY, MUSIC, THEATER, SPORTS, DRAMA AND ACTION; TELEVISION SHOW AND MOVIE PRODUCTION (U.S. CLS. 100, 101 AND 107).
FIRST USE 11-1-1996; IN COMMERCE 2-10-1999.

3,177,354. GROUP:LILI DESIGNS INC., COTATI, CA. SN 76-353,285. PUB. 8-26-2003, FILED 12-28-2001.

TIGER LILI

CLASS 3—COSMETICS AND CLEANING PREPARATIONS

FOR PERFUMES; FRAGRANCES FOR PERSONAL APPLICATION, POTPOURRI STYLE DECORATIVE FRAGRANCE EMITTING POUCHES, INCENSE (U.S. CLS. 1, 4, 6, 50, 51 AND 52).
FIRST USE 1-0-2004; IN COMMERCE 1-0-2004.

CLASS 4—LUBRICANTS AND FUELS

FOR FRAGRANCE EMITTING CANDLES (U.S. CLS. 1, 6 AND 15).
FIRST USE 3-0-2004; IN COMMERCE 12-0-2004.

CODEXIS

CLASS 1—CHEMICALS

FOR CHEMICALS FOR RESEARCH AND COMMERCIAL APPLICATIONS PERTAINING TO CHEMISTRY, PHARMACEUTICALS, AND MEDICINE; CHEMICALS AND BIOCHEMICALS FOR IN VITRO SCIENTIFIC, RESEARCH AND COMMERCIAL USE; ENZYMES USED TO PRODUCE CHEMICALS FOR RESEARCH AND COMMERCIAL APPLICATIONS PERTAINING TO CHEMISTRY, PHARMACEUTICALS, AND MEDICINE; CHEMICALS AND BIOCHEMICALS FOR USE IN THE SYNTHESIS OF PHARMACEUTICALS AND CHEMICALS; CHEMICAL AND BIOCHEMICAL CATALYSTS FOR USE IN PHARMACEUTICAL AND CHEMICAL PRODUCTION (U.S. CLS. 1, 5, 6, 10, 26 AND 46).
FIRST USE 3-30-2006; IN COMMERCE 3-30-2006.

CLASS 40—MATERIAL TREATMENT

FOR DIRECTED EVOLUTION SERVICES, NAMELY, THE RECOMBINATION OF GENES FOR THE BENEFIT OF OTHERS TO PRODUCE NOVEL GENE SEQUENCES FOR USE IN SCIENCE, RESEARCH, CHEMISTRY, AND MEDICINE; MANUFACTURE OF CHEMICALS FOR OTHERS (U.S. CLS. 100, 103 AND 106).
FIRST USE 3-30-2006; IN COMMERCE 3-30-2006.

CLASS 42—SCIENTIFIC, COMPUTER AND LEGAL SERVICES

FOR CHEMICAL RESEARCH SERVICES; SCIENTIFIC RESEARCH SERVICES; RESEARCH, PRODUCT DEVELOPMENT, AND PROCESS DEVELOPMENT SERVICES FOR OTHERS IN THE FIELDS OF CHEMISTRY, PHARMACEUTICALS, AND BIOCATALYSIS (U.S. CLS. 100 AND 101).
FIRST USE 3-30-2006; IN COMMERCE 3-30-2006.

3,177,357. 3681441 CANADA INC., MONTREAL, QUEBEC H3L 1Z8, CANADA. SN 76-379,988. PUB. 5-20-2003, FILED 3-7-2002.

I JEANS

NO CLAIM IS MADE TO THE EXCLUSIVE RIGHT TO USE "JEANS", APART FROM THE MARK AS SHOWN.

CLASS 3—COSMETICS AND CLEANING PREPARATIONS

FOR PERFUMES (U.S. CLS. 1, 4, 6, 50, 51 AND 52).
FIRST USE 7-17-2006; IN COMMERCE 7-17-2006.

CLASS 14—JEWELRY

FOR JEWELRY (U.S. CLS. 2, 27, 28 AND 50).
FIRST USE 7-17-2006; IN COMMERCE 7-17-2006.

CLASS 18—LEATHER GOODS

FOR HAND BAGS AND BACK PACKS (U.S. CLS. 1, 2, 3, 22 AND 41).
FIRST USE 7-17-2006; IN COMMERCE 7-17-2006.

3,177,358. PAPER MAGIC GROUP, INC., THE, WILMINGTON, DE. SN 76-381,641. PUB. 5-11-2004, FILED 3-12-2002.

13 TRANSYLVANIA AVENUE

CLASS 9—ELECTRICAL AND SCIENTIFIC APPARATUS

FOR ELECTRONIC SOUND EFFECTS PLAYERS FOR PLAYING SPOOKY SOUNDS (U.S. CLS. 21, 23, 26, 36 AND 38).

FIRST USE 9-0-2002; IN COMMERCE 9-0-2002.

CLASS 11—ENVIRONMENTAL CONTROL APPARATUS

FOR ELECTRONICALLY-ACTIVATED HALLOWEEN LIGHTING, LIGHTS FOR ILLUMINATING DECORATIVE HALLOWEEN IMAGES SUCH AS WITCHES, GHOSTS, BATS, SKELETONS, PUMPKINS, SKULLS, GHOULS, AND MONSTERS, UTILIZING AN ON/OFF SWITCH THAT IS NOT MOTION OR SOUND ACTIVATED OR THAT IS MOTION-ACTIVATED WITH SOUND, LIGHT AND MOTION OR THAT IS SOUND-ACTIVATED WITH LIGHT, SOUND AND MOTION (U.S. CLS. 13, 21, 23, 31 AND 34).

FIRST USE 9-0-2002; IN COMMERCE 9-0-2002.

3,177,359. WESTED, SAN FRANCISCO, CA. SN 76-392,298. PUB. 6-15-2004, FILED 4-5-2002.

READING APPRENTICESHIP

NO CLAIM IS MADE TO THE EXCLUSIVE RIGHT TO USE "READING", APART FROM THE MARK AS SHOWN.

CLASS 9—ELECTRICAL AND SCIENTIFIC APPARATUS

FOR ELECTRONIC MEDIA, NAMELY, COMPUTER SOFTWARE THAT FUNCTIONS TO DEVELOP READING COMPREHENSION, FOR USE IN THE FIELD OF EDUCATION; PRE-RECORDED VIDEO CASSETTE TAPES AND AUDIO RECORDINGS, NAMELY, AUDIO CASSETTES, COMPACT DISCS, AND CD-ROMS, ALL CONTAINING EDUCATIONAL CONTENT BASED ON AN INSTRUCTIONAL FRAMEWORK FOR DEVELOPING READING COMPREHENSION, FLUENCY AND MOTIVATION (U.S. CLS. 21, 23, 26, 36 AND 38).

FIRST USE 6-30-2000; IN COMMERCE 6-30-2000.

CLASS 38—COMMUNICATION

FOR STREAMING OF AUDIO-VISUAL MEDIA BASED ON AN INSTRUCTIONAL FRAMEWORK FOR DEVELOPING READING COMPREHENSION, FLUENCY, AND MOTIVATION OVER THE INTERNET (U.S. CLS. 100, 101 AND 104).

FIRST USE 6-15-2006; IN COMMERCE 6-15-2006.

3,177,372. CITY OF PASADENA, PASADENA, CA. SN 76-459,494. PUB. 7-26-2005, FILED 10-11-2002.



OWNER OF U.S. REG. NO. 2,482,717.
NO CLAIM IS MADE TO THE EXCLUSIVE RIGHT TO USE "BOWL" AND "STADIUM", APART FROM THE MARK AS SHOWN.

CLASS 25—CLOTHING

FOR HATS, SHIRTS (U.S. CLS. 22 AND 39).
FIRST USE 7-0-2001; IN COMMERCE 7-0-2001.

CLASS 35—ADVERTISING AND BUSINESS

FOR PROMOTING CONCERTS OF OTHERS; PROMOTING RECREATIONAL ACTIVITIES OF OTHERS; ALL EXCLUDING THE PROMOTING OF AN ANNUAL INTERSECTIONAL FOOTBALL GAME AND PARADE (U.S. CLS. 100, 101 AND 102).

FIRST USE 12-30-2002; IN COMMERCE 12-30-2002.

CLASS 41—EDUCATION AND ENTERTAINMENT

FOR PROVIDING STADIUM FACILITIES FOR SPORTING EVENTS, CONCERTS AND RECREATIONAL ACTIVITIES (U.S. CLS. 100, 101 AND 107).

FIRST USE 12-30-2002; IN COMMERCE 12-30-2002.

3,177,380. ARAMARK CORPORATION, PHILADELPHIA, PA. SN 76-499,667. PUB. 5-25-2004, FILED 3-24-2003.

PLANETEVEVERGREEN

CLASS 16—PAPER GOODS AND PRINTED MATTER

FOR NEWSLETTERS FEATURING ENVIRONMENTAL ISSUES (U.S. CLS. 2, 5, 22, 23, 29, 37, 38 AND 50).

FIRST USE 5-0-2003; IN COMMERCE 5-0-2003.

CLASS 25—CLOTHING

FOR CLOTHING, NAMELY, HATS, CAPS, T-SHIRTS, SHIRTS, SWEAT SHIRTS, FLEECE PULLOVERS; FLEECE VESTS, JACKETS, SHORTS (U.S. CLS. 22 AND 39).

FIRST USE 11-0-2002; IN COMMERCE 11-0-2002.

CLASS 43—HOTEL AND RESTAURANT SERVICES

FOR RESTAURANT SERVICES (U.S. CLS. 100 AND 101).

FIRST USE 5-0-2003; IN COMMERCE 5-0-2003.

3,177,381. CDOC, LLC, GORDONSVILLE, VA. SN 76-503,977.
PUB. 12-27-2005, FILED 4-4-2003.

3,177,390. SPACESAVER CORPORATION, FORT ATKIN-
SON, WI. SN 76-519,270. PUB. 5-31-2005, FILED 5-21-2003.

CDOC

CLASS 7—MACHINERY

FOR NON-STRUCTURAL AUTOMOTIVE RACING CAR PARTS, NAMELY, ENGINE PARTS IN THE NATURE OF AIR FILTERS, RODS, CYLINDERS AND CRANKSHAFTS, AFTER CATALYTIC EXHAUST COMPONENTS, PERFORMANCE RADIATORS (U.S. CLS. 13, 19, 21, 23, 31, 34 AND 35).
FIRST USE 6-19-2003; IN COMMERCE 6-19-2003.

CLASS 12—VEHICLES

FOR NON-STRUCTURAL AUTOMOTIVE RACING CAR PARTS, NAMELY, BRAKE PARTS IN THE NATURE OF BRAKE ROTORS, BRAKE CALIPERS, AND BRAKE ROTOR PARTS FOR LAND VEHICLES; DOT STAINLESS STEEL BRAIDED BRAKE HOSES; SUSPENSION SYSTEMS; TRAILER ACCESSORIES IN THE NATURE OF TRAILER HITCHES; AND CAR SEATS (U.S. CLS. 19, 21, 23, 31, 35 AND 44).
FIRST USE 6-19-2003; IN COMMERCE 6-19-2003.

3,177,389. I.S. STUDIO INC., EDIF. FUDO 3 A, MACAO. SN
76-519,088. PUB. 8-31-2004, FILED 5-12-2003.

I. S. studio

PRIORITY CLAIMED UNDER SEC. 44(D) ON HONG KONG APPLICATION NO. 300013319, FILED 5-2-2003, REG. NO. 300013319, DATED 5-2-2003, EXPIRES 5-1-2013.

NO CLAIM IS MADE TO THE EXCLUSIVE RIGHT TO USE "STUDIO", APART FROM THE MARK AS SHOWN.

CLASS 24—FABRICS

FOR BED QUILT COVERS; QUILTS; BLANKETS; BED COVERS; BED LINEN; BED SPREADS; DUVETS; PILLOW CASES; CUSHION COVERS; TOWELS; TABLE LINEN, NAMELY, TABLE CLOTHS, NAPKINS, TABLE COVERS AND PLACE MATS; HANDKERCHIEFS; CURTAINS; BLANKET THROWS; LAP RUGS (U.S. CLS. 42 AND 50).
FIRST USE 0-0-1994; IN COMMERCE 5-12-2005.

CLASS 27—FLOOR COVERINGS

FOR RUGS (U.S. CLS. 19, 20, 37, 42 AND 50).
FIRST USE 0-0-1994; IN COMMERCE 5-12-2005.

POWERLINK

CLASS 35—ADVERTISING AND BUSINESS

FOR ON-LINE CUSTOMER SERVICES IN THE FIELD OF OFFICE AND INSTITUTIONAL FURNITURE AND POWERED MOBILE FILE, STORAGE AND SHELVING SYSTEMS (U.S. CLS. 100, 101 AND 102).
FIRST USE 8-0-2003; IN COMMERCE 8-0-2003.

CLASS 37—CONSTRUCTION AND REPAIR

FOR PROVIDING LINKS TO THE WEBSITES OF OTHERS FOR TROUBLESHOOTING, SERVICING AND MAINTAINING OFFICE AND INSTITUTIONAL FURNITURE AND POWERED MOBILE FILE, STORAGE AND SHELVING SYSTEMS (U.S. CLS. 100, 103 AND 106).
FIRST USE 8-0-2003; IN COMMERCE 8-0-2003.

3,177,400. APPLE EXPRESS COURIER LTD., MISSISSAUGA,
ONTARIO, CANADA. SN 76-543,166. PUB. 6-14-2005,
FILED 9-5-2003.

INTELLIGENT COURIER

NO CLAIM IS MADE TO THE EXCLUSIVE RIGHT TO USE "COURIER", APART FROM THE MARK AS SHOWN.

CLASS 35—ADVERTISING AND BUSINESS

FOR LOGISTICAL SERVICES PERTAINING TO ELECTRONIC EQUIPMENT, NAMELY, MANAGING SUPPLY AND DEMAND FORECASTING AND PRODUCT DISTRIBUTION PROCESSES FOR ELECTRONIC EQUIPMENT FOR OTHERS (U.S. CLS. 100, 101 AND 102).
FIRST USE 1-1-2004; IN COMMERCE 1-1-2004.

CLASS 37—CONSTRUCTION AND REPAIR

FOR TECHNICAL SUPPORT SERVICES, NAMELY, INSTALLATION/DEINSTALLATION OF ELECTRONIC EQUIPMENT (U.S. CLS. 100, 103 AND 106).
FIRST USE 1-1-2004; IN COMMERCE 1-1-2004.

CLASS 39—TRANSPORTATION AND STORAGE

FOR WAREHOUSE STORAGE AND LOGISTICAL SERVICES FOR ELECTRONIC EQUIPMENT, NAMELY, STORAGE, TRANSPORTATION AND DELIVERY OF ELECTRONIC EQUIPMENT BY AIR, FREIGHT, SHIP OR RAIL (U.S. CLS. 100 AND 105).
FIRST USE 1-1-2004; IN COMMERCE 1-1-2004.

3,177,409. 420820 ONTARIO LIMITED, VAUGHAN, ONTARIO,
CANADA. SN 76-554,345. PUB. 1-11-2005, FILED 10-8-
2003.

THE SCREENLESS SCREEN

NO CLAIM IS MADE TO THE EXCLUSIVE RIGHT TO USE "SCREEN", APART FROM THE MARK AS SHOWN.

CLASS 6—METAL GOODS

FOR DOOR SCREENS, NAMELY, REPLACEMENT METAL SCREENS INCORPORATING METAL SCREEN FRAMES CARRYING A ROLL SCREEN HOUSING AND SCREEN CASSETTE THEREIN; WINDOW SCREENS, NAMELY, REPLACEMENT METAL SCREENS INCORPORATING METAL SCREEN FRAMES CARRYING ON A ROLL SCREEN HOUSING AND SCREEN CASSETTES THEREIN; PATIO DOOR SCREENS, NAMELY, REPLACEMENT METAL SCREENS INCORPORATING METAL SCREEN FRAMES CARRYING A ROLL SCREEN HOUSING AND SCREEN CASSETTES THEREIN; METAL HARDWARE FOR METAL SCREENS, NAMELY, BRACKETS, PIVOTS, INTERCONNECTING MEMBERS, ROLLERS, ASSEMBLIES, SCREEN CASSETTES, SCREEN HANDLES AND SCREEN TUBES (U.S. CLS. 2, 12, 13, 14, 23, 25 AND 50).

FIRST USE 9-28-2005; IN COMMERCE 9-28-2005.

CLASS 19—NON-METALLIC BUILDING MATERIALS

FOR DOOR SCREENS, NAMELY, REPLACEMENT NON-METAL SCREENS INCORPORATING NON-METAL SCREEN FRAMES CARRYING A ROLL SCREEN HOUSING AND SCREEN CASSETTES THEREIN; WINDOW SCREENS, NAMELY, REPLACEMENT NON-METAL SCREENS INCORPORATING NON-METAL SCREEN FRAMES CARRYING A ROLL SCREEN HOUSING AND SCREEN CASSETTES THEREIN; PATIO DOOR SCREENS, NAMELY, REPLACEMENT NON-METAL SCREENS INCORPORATING NON-METAL SCREEN FRAMES CARRYING A ROLL SCREEN HOUSING AND SCREEN HOUSING AND SCREEN CASSETTES THEREIN; NON-METAL HARDWARE FOR NON-METAL SCREENS, NAMELY, BRACKETS, PIVOTS INTERCONNECTING MEMBERS, ROLLERS ASSEMBLIES, SCREEN CASSETTES, SCREEN HANDLES AND SCREEN TUBES (U.S. CLS. 1, 12, 33 AND 50).

FIRST USE 9-28-2005; IN COMMERCE 9-28-2005.

3,177,417. HARMLESS JUNK, INC., DUNWOODY, GA. SN 76-566,454. PUB. 5-31-2005, FILED 12-22-2003.

**CLASS 9—ELECTRICAL AND SCIENTIFIC APPARATUS**

FOR PRE-RECORDED DVDS AND CDS FEATURING ANIMATION AND MUSIC (U.S. CLS. 21, 23, 26, 36 AND 38).

FIRST USE 11-9-2004; IN COMMERCE 11-9-2004.

CLASS 16—PAPER GOODS AND PRINTED MATTER

FOR POSTERS, BUMPER STICKERS AND STATIC CLING DECALS (U.S. CLS. 2, 5, 22, 23, 29, 37, 38 AND 50).

FIRST USE 6-14-2004; IN COMMERCE 6-14-2004.

CLASS 18—LEATHER GOODS

FOR MESSENGER BAGS (U.S. CLS. 1, 2, 3, 22 AND 41).

FIRST USE 11-24-2003; IN COMMERCE 11-24-2003.

CLASS 20—FURNITURE AND ARTICLES NOT OTHERWISE CLASSIFIED

FOR COLLECTIBLE MODELED PLASTIC FIGURINES (U.S. CLS. 2, 13, 22, 25, 32 AND 50).

FIRST USE 7-14-2003; IN COMMERCE 7-14-2003.

CLASS 41—EDUCATION AND ENTERTAINMENT

FOR ENTERTAINMENT SERVICES IN THE NATURE OF AN ANIMATED COMEDY SERIES PROVIDED VIA THE INTERNET (U.S. CLS. 100, 101 AND 107).

FIRST USE 1-0-2000; IN COMMERCE 1-0-2000.

3,177,413. PANOR CORPORATION, HAUPPAUGE, NY. SN 76-556,670. PUB. 8-3-2004, FILED 10-17-2003.

GORILLA

CLASS 9—ELECTRICAL AND SCIENTIFIC APPARATUS

FOR LIGHT EMITTING DIODES (U.S. CLS. 21, 23, 26, 36 AND 38).

FIRST USE 6-13-2003; IN COMMERCE 6-13-2003.

CLASS 11—ENVIRONMENTAL CONTROL APPARATUS

FOR LIGHTS FOR USE ON TRANSPORTATION VEHICLES (U.S. CLS. 13, 21, 23, 31 AND 34).

FIRST USE 7-8-2004; IN COMMERCE 7-8-2004.

3,177,428. LIGHTEDGE SOLUTIONS, INC., DES MOINES, IA. SN 76-578,923. PUB. 3-21-2006, FILED 3-3-2004.

LIGHTEDGE

THE MARK CONSISTS OF STANDARD CHARACTERS WITHOUT CLAIM TO ANY PARTICULAR FONT, STYLE, SIZE, OR COLOR.

CLASS 35—ADVERTISING AND BUSINESS

FOR MANAGING DATABASES OF OTHERS ON A COMPUTER SERVER FOR A GLOBAL COMPUTER NETWORK (U.S. CLS. 100, 101 AND 102).

FIRST USE 4-1-2004; IN COMMERCE 4-1-2004.

CLASS 38—COMMUNICATION

FOR TELECOMMUNICATIONS SERVICES, NAMELY, THE ELECTRONIC TRANSMISSION OF MESSAGES, DATA, AND INFORMATION VIA A GLOBAL COMPUTER NETWORK; PROVIDING TELECOMMUNICATIONS CONNECTIONS TO A GLOBAL COMPUTER NETWORK; ELECTRONIC MAIL SERVICES; PROVIDING THE TELECOMMUNICATIONS CONNECTIONS TO PRIVATE NETWORKS INTEGRATED WITH A GLOBAL COMPUTER NETWORK (U.S. CLS. 100, 101 AND 104).

FIRST USE 4-1-2004; IN COMMERCE 4-1-2004.

CLASS 39—TRANSPORTATION AND STORAGE

FOR ELECTRONIC STORAGE AND RETRIEVAL OF ELECTRONIC DATA FOR OTHERS (U.S. CLS. 100 AND 105).

FIRST USE 4-1-2004; IN COMMERCE 4-1-2004.

CLASS 42—SCIENTIFIC, COMPUTER AND LEGAL SERVICES

FOR COMPUTER VIRUS PROTECTION SERVICES, NAMELY, COMPUTER SECURITY SERVICES, NAMELY, RESTRICTING ACCESS TO AND BY COMPUTER NETWORKS TO AND OF UNDESIRED WEBSITES, MEDIA AND INDIVIDUALS (U.S. CLS. 100 AND 101).

FIRST USE 4-1-2004; IN COMMERCE 4-1-2004.

3,177,434. WEIMAN PRODUCTS, LLC, GURNEE, IL. SN 76-581,810. PUB. 3-15-2005, FILED 3-18-2004.

WEIMAN

THE MARK CONSISTS OF STANDARD CHARACTERS WITHOUT CLAIM TO ANY PARTICULAR FONT, STYLE, SIZE, OR COLOR.

OWNER OF U.S. REG. NO. 1,962,788.
SEC. 2(F).

CLASS 3—COSMETICS AND CLEANING PREPARATIONS

FOR CLEANING PREPARATIONS, NAMELY, FURNITURE CREAM, FURNITURE POLISH, WOOD FURNITURE SOAP, MARBLE POLISH, WAX REMOVER AND CLEANER, LEATHER CLEANER, OIL SOAP, RANGE AND COOK TOP CLEANER, CANDLE WAX REMOVER, PANELING CLEANER, SILVER POLISH, TARNISH REMOVERS FOR SILVER AND COPPER, STAINLESS STEEL CLEANER AND POLISH, JEWELRY CLEANER, NON-WAX DUSTING AGENT, PLASTIC LAMINATE CLEANER AND POLISH, LEMON OIL, LEMON OIL FURNITURE POLISH WITH SUNSCREEN, FIBERGLASS CLEANER WITH LEMON, BATHROOM CLEANER; DISPOSABLE CLEANING WIPES IMPREGNATED WITH CHEMICALS OR COMPOUNDS FOR HOUSEHOLD USE (U.S. CLS. 1, 4, 6, 50, 51 AND 52).

FIRST USE 6-3-1963; IN COMMERCE 6-3-1963.

CLASS 21—HOUSEWARES AND GLASS

FOR CLEANING AND SCRUBBING PADS FOR ALL SURFACE TYPES (U.S. CLS. 2, 13, 23, 29, 30, 33, 40 AND 50).

FIRST USE 2-1-2004; IN COMMERCE 2-1-2004.

3,177,438. DEGUSSA CORPORATION, PARSIPPANY, NJ. SN 76-585,495. PUB. 9-27-2005, FILED 4-5-2004.

DURA-CHEM

THE MARK CONSISTS OF STANDARD CHARACTERS WITHOUT CLAIM TO ANY PARTICULAR FONT, STYLE, SIZE, OR COLOR.

CLASS 2—PAINTS

FOR COLORANT DISPERSIONS FOR USE IN SURFACE COATING COMPOSITIONS (U.S. CLS. 6, 11 AND 16).

FIRST USE 4-15-2006; IN COMMERCE 4-15-2006.

CLASS 16—PAPER GOODS AND PRINTED MATTER

FOR PRINTED MERCHANDISING AIDS USED IN CONNECTION WITH THE SALE OF PROTECTIVE COATINGS, NAMELY, FAN DECKS, COLOR ALBUMS, COLOR CARD SETS, FORMULATION GUIDES, ARCHITECTS' BINDERS AND ARCHITECTS' COLOR FILES (U.S. CLS. 2, 5, 22, 23, 29, 37, 38 AND 50).

FIRST USE 4-15-2006; IN COMMERCE 4-15-2006.

3,177,445. REGAL LAGER, INC., KENNESAY, GA. SN 76-592,525. PUB. 11-1-2005, FILED 5-17-2004.

SECOND NATURE

THE MARK CONSISTS OF STANDARD CHARACTERS WITHOUT CLAIM TO ANY PARTICULAR FONT, STYLE, SIZE, OR COLOR.

CLASS 10—MEDICAL APPARATUS

FOR BREAST PUMPS, BREAST SHIELDS, BABY NURSERS, PACIFIERS, FEEDING BOTTLES AND TRAINING BOTTLES FOR BABIES, INFANTS AND CHILDREN, AND PARTS AND FITTINGS FOR THE AFORESAID GOODS (U.S. CLS. 26, 39 AND 44).

FIRST USE 8-1-2004; IN COMMERCE 8-1-2004.

CLASS 11—ENVIRONMENTAL CONTROL APPARATUS

FOR ELECTRIC HEATERS FOR BABY BOTTLES, AND ELECTRIC FOOD WARMERS (U.S. CLS. 13, 21, 23, 31 AND 34).

FIRST USE 10-1-2004; IN COMMERCE 10-1-2004.

CLASS 21—HOUSEWARES AND GLASS

FOR CHILDREN'S DRINKING AND TRAINING CUPS, AND SPILL-PROOF, SIPPING CUPS (U.S. CLS. 2, 13, 23, 29, 30, 33, 40 AND 50).

FIRST USE 8-1-2004; IN COMMERCE 8-1-2004.

CLASS 25—CLOTHING

FOR NURSING BRAS (U.S. CLS. 22 AND 39).

FIRST USE 6-1-2004; IN COMMERCE 6-1-2004.

3,177,455. CARDONE INDUSTRIES, INC., PHILADELPHIA, PA. SN 76-602,765. PUB. 12-20-2005, FILED 7-19-2004.

CARDONE SERVICE PLUS

THE MARK CONSISTS OF STANDARD CHARACTERS WITHOUT CLAIM TO ANY PARTICULAR FONT, STYLE, SIZE, OR COLOR.

OWNER OF U.S. REG. NOS. 2,076,817 AND 2,928,599.

CLASS 9—ELECTRICAL AND SCIENTIFIC APPARATUS

FOR COMPUTER SOFTWARE AND HARDWARE FOR FLASH REPROGRAMMING OF COMPUTER SOFTWARE FOR MOTOR VEHICLES (U.S. CLS. 21, 23, 26, 35 AND 38).

FIRST USE 6-0-2004; IN COMMERCE 8-0-2004.

CLASS 12—VEHICLES

FOR LAND VEHICLE PARTS AND ACCESSORIES, NAMELY, CALIPER BRACKETS, POWER STEERING FILTERS, AND RACK AND PINION INNER TIE ROD REPAIR KITS (U.S. CLS. 19, 21, 23, 31, 35 AND 44).

FIRST USE 6-0-2004; IN COMMERCE 8-0-2004.

3,177,456. IOSTUDIO, LLC, NASHVILLE, TN. SN 76-603,085. PUB. 11-22-2005, FILED 7-20-2004.

IOSTUDIO

THE MARK CONSISTS OF STANDARD CHARACTERS WITHOUT CLAIM TO ANY PARTICULAR FONT, STYLE, SIZE, OR COLOR.

CLASS 16—PAPER GOODS AND PRINTED MATTER

FOR PUBLICATIONS, NAMELY, GENERAL FEATURE MAGAZINES, COMIC STRIPS APPEARING IN MAGAZINES, NEWSPAPERS, AND BROCHURES, AND MAGAZINES FEATURING NEWS AND INFORMATION OF GENERAL OR SPECIFIC INTEREST TO MILITARY SERVICE MEMBERS AND FAMILY MEMBERS AS WELL AS LIFESTYLE AND CAREER GUIDANCE PUBLICATIONS FOR YOUNG ADULTS (U.S. CLS. 2, 5, 22, 23, 29, 37, 38 AND 50).

FIRST USE 0-0-2001; IN COMMERCE 0-0-2001.

CLASS 41—EDUCATION AND ENTERTAINMENT

FOR ELECTRONIC AND PRINT PUBLISHING SERVICES FOR OTHERS, NAMELY, MAGAZINE PUBLISHING, PUBLICATION OF TEXTS, BOOKS, MAGAZINES, JOURNALS, NEWSPAPERS, PERIODICALS, CATALOGS, BROCHURES, AND OTHER PRINTED MATTER, AND PUBLISHING OF WEB MAGAZINES (U.S. CLS. 100, 101 AND 107).

FIRST USE 0-0-2001; IN COMMERCE 0-0-2001.

CLASS 42—SCIENTIFIC, COMPUTER AND LEGAL SERVICES

FOR WEBSITE DESIGN SERVICES (U.S. CLS. 100 AND 101).

FIRST USE 0-0-1997; IN COMMERCE 0-0-1997.

3,177,457. VITA LICENSING, INC., WILMINGTON, DE. SN 76-603,594. PUB. 12-20-2005, FILED 7-22-2004.

VITAGEL

THE MARK CONSISTS OF STANDARD CHARACTERS WITHOUT CLAIM TO ANY PARTICULAR FONT, STYLE, SIZE, OR COLOR.

CLASS 5—PHARMACEUTICALS

FOR HEMOSTATS USED TO CONTROL BLEEDING, NAMELY BIO-MATERIAL PREPARATIONS IN THE NATURE OF TISSUE ADHESIVES, TISSUE SEALANTS, FILMS, BARRIERS, ADHESION PREVENTION MATERIALS, SPRAY ADHESIVE MATERIALS FOR MENDING, REPAIRING, AND HEALING TISSUE IN PROMOTING EFFECTIVE CLOSURE OF SURGICAL WOUNDS (U.S. CLS. 6, 18, 44, 46, 51 AND 52).

FIRST USE 1-31-2005; IN COMMERCE 1-31-2005.

CLASS 10—MEDICAL APPARATUS

FOR MEDICAL INSTRUMENTS, NAMELY, HEMOSTAT DEVICES AND INSTRUMENTATION, IN THE NATURE OF SPRAY AND SYRINGE-TYPE APPLICATORS, AND ASSOCIATED TUBING, FOR THE DELIVERY OF BIO-MATERIAL PREPARATIONS (U.S. CLS. 26, 39 AND 44).

FIRST USE 2-23-2006; IN COMMERCE 2-23-2006.

3,177,462. ORSINI CYCLE CENTER, WATERBURY, CT. SN 76-605,762. PUB. 12-20-2005, FILED 8-3-2004.

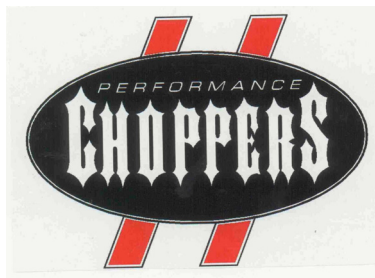

NO CLAIM IS MADE TO THE EXCLUSIVE RIGHT TO USE "PERFORMANCE CHOPPERS", APART FROM THE MARK AS SHOWN.

THE COLOR(S) RED, BLACK AND WHITE IS/ARE CLAIMED AS A FEATURE OF THE MARK.

THE COLOR RED APPEARS IN RED SLANTED VERTICAL STRIPES EXTENDING FROM THE TOP AND BOTTOM RESPECTIVELY OF AN OVAL. THE COLOR BLACK APPEARS IN THE BACKGROUND OF THE OVAL AND THE COLOR WHITE APPEARS IN THE LETTERING OF THE WORDING OF THE MARK PERFORMANCE CHOPPERS WITHIN THE BLACK OVAL.

CLASS 25—CLOTHING

FOR CLOTHING, NAMELY, T-SHIRTS, CAPS, HEADWEAR, JERSEYS AND VESTS (U.S. CLS. 22 AND 39).

FIRST USE 3-0-2004; IN COMMERCE 8-0-2004.

CLASS 40—MATERIAL TREATMENT

FOR CUSTOM MANUFACTURE OF MOTORCYCLES (U.S. CLS. 100, 103 AND 106).
FIRST USE 3-0-2004; IN COMMERCE 9-0-2004.

3,177,490. KOONICHI INCORPORATED, FRESH MEADOWS, NY. SN 76-612,418. PUB. 1-31-2006, FILED 9-14-2004.

3,177,466. JUSTCLICKIT.NET, LLC, HANOVER, NH. SN 76-608,317. PUB. 12-20-2005, FILED 8-24-2004.

**CLASS 9—ELECTRICAL AND SCIENTIFIC APPARATUS**

FOR DIGITAL IMAGING SOFTWARE FOR THE DISPLAY, MANAGEMENT, EDITING, PRINTING AND SHARING OF DIGITAL IMAGES (U.S. CLS. 21, 23, 26, 36 AND 38).
FIRST USE 2-24-2006; IN COMMERCE 2-24-2006.

CLASS 39—TRANSPORTATION AND STORAGE

FOR ONLINE PHOTOGRAPHIC STORAGE AND RETRIEVAL SERVICES; ONLINE VIDEO AND MUSIC STORAGE AND RETRIEVAL SERVICES (U.S. CLS. 100 AND 105).
FIRST USE 2-24-2006; IN COMMERCE 2-24-2006.

3,177,467. JUSTCLICKIT.NET, LLC, HANOVER, NH. SN 76-608,318. PUB. 12-20-2005, FILED 8-24-2004.

JUSTCLICKIT.NET

THE MARK CONSISTS OF STANDARD CHARACTERS WITHOUT CLAIM TO ANY PARTICULAR FONT, STYLE, SIZE, OR COLOR.

CLASS 9—ELECTRICAL AND SCIENTIFIC APPARATUS

FOR DIGITAL IMAGING SOFTWARE FOR THE DISPLAY, MANAGEMENT, EDITING, PRINTING AND SHARING OF DIGITAL IMAGES (U.S. CLS. 21, 23, 26, 36 AND 38).
FIRST USE 2-24-2006; IN COMMERCE 2-24-2006.

CLASS 39—TRANSPORTATION AND STORAGE

FOR ONLINE PHOTOGRAPHIC STORAGE AND RETRIEVAL SERVICES; ONLINE VIDEO AND MUSIC STORAGE AND RETRIEVAL SERVICES (U.S. CLS. 100 AND 105).
FIRST USE 2-24-2006; IN COMMERCE 2-24-2006.



THE COLOR(S) RED AND WHITE IS/ARE CLAIMED AS A FEATURE OF THE MARK.
THE MARK CONSISTS OF A WHITE K ON A RED BACKGROUND.

CLASS 5—PHARMACEUTICALS

FOR AIR FRESHENERS FOR USE IN AUTOMOBILES (U.S. CLS. 6, 18, 44, 46, 51 AND 52).
FIRST USE 9-0-2005; IN COMMERCE 9-0-2005.

CLASS 9—ELECTRICAL AND SCIENTIFIC APPARATUS

FOR PLUG ADAPTORS AND SPECIALTY HOLDERS FOR CELL PHONES, FOR USE IN AUTOMOBILES (U.S. CLS. 21, 23, 26, 36 AND 38).
FIRST USE 9-0-2005; IN COMMERCE 9-0-2005.

3,177,491. COLONIAL LIFE & ACCIDENT INSURANCE COMPANY, COLUMBIA, SC. SN 76-612,667. PUB. 1-17-2006, FILED 9-23-2004.

**CLASS 35—ADVERTISING AND BUSINESS**

FOR HUMAN RESOURCES MANAGEMENT OVER A GLOBAL COMPUTER NETWORK; DATABASE MANAGEMENT OF HUMAN RESOURCES DATA; MAINTAINING A REGISTRY OF EMPLOYEES ENROLLED IN EMPLOYEE BENEFIT PROGRAMS AND OF EMPLOYEE BENEFIT PLANS (U.S. CLS. 100, 101 AND 102).
FIRST USE 4-0-2004; IN COMMERCE 4-0-2004.

CLASS 36—INSURANCE AND FINANCIAL

FOR ADMINISTRATION OF EMPLOYEE BENEFIT PROGRAMS; INSURANCE ADMINISTRATION; INSURANCE AND FINANCIAL CONSULTATION SERVICES; PROVIDING ON-LINE INFORMATION IN THE FIELD OF EMPLOYEE BENEFIT PLANS; CONSULTATION IN THE FIELD OF DESIGN AND ADMINISTRATION OF EMPLOYEE BENEFITS PROGRAMS (U.S. CLS. 100, 101 AND 102).

FIRST USE 4-0-2004; IN COMMERCE 4-0-2004.

CLASS 42—SCIENTIFIC, COMPUTER AND LEGAL SERVICES

FOR APPLICATION SERVICE PROVIDER (ASP) SERVICES FEATURING SOFTWARE IN THE FIELD OF EMPLOYEE BENEFITS EDUCATION, COMMUNICATION AND ENROLLMENT; APPLICATION SERVICE PROVIDER (ASP) SERVICES FEATURING SOFTWARE IN THE FIELD OF EMPLOYEE BENEFITS ADMINISTRATION AND EMPLOYEE BENEFIT ADMINISTRATION SERVICES; COMPUTER SERVICES, NAMELY, ACTING AS AN APPLICATION SERVICE PROVIDER IN THE FIELD OF KNOWLEDGE MANAGEMENT TO HOST COMPUTER APPLICATION SOFTWARE FOR CREATING SEARCHABLE DATABASES OF INFORMATION AND DATA IN THE FIELD OF EMPLOYEE BENEFITS ADMINISTRATION AND IN THE FIELD OF EMPLOYEE BENEFIT ADMINISTRATION SERVICES; PROVIDING TEMPORARY USE OF ON-LINE NON-DOWNLOADABLE SOFTWARE FOR INDIVIDUALS TO PURCHASE INDIVIDUAL AND GROUP INSURANCE PRODUCTS (U.S. CLS. 100 AND 101).

FIRST USE 4-0-2004; IN COMMERCE 4-0-2004.

3,177,494. MI WINDOWS AND DOORS, INC., GRATZ, PA. SN 76-612,985. PUB. 2-28-2006, FILED 9-20-2004.



NO CLAIM IS MADE TO THE EXCLUSIVE RIGHT TO USE CUSTOMER CARE, APART FROM THE MARK AS SHOWN.

THE COLOR(S) BLACK, WHITE AND RED ARE CLAIMED AS FEATURES OF THE MARK.

THE COLOR BLACK APPEARS IN THE WORDS "CUSTOMER CARE" AND THE COLOR RED APPEARS AS A DESIGN FEATURING A STYLIZED HOUSE IN THE COLOR WHITE WITH A RED WINDOW SET AGAINST A RED BACKGROUND.

CLASS 35—ADVERTISING AND BUSINESS

FOR PROVIDING CUSTOMER SERVICE REGARDING THE USE OF WINDOWS AND DOORS AND ORDERING REPLACEMENT PARTS THEREFOR (U.S. CLS. 100, 101 AND 102).

FIRST USE 12-31-2004; IN COMMERCE 12-31-2004.

CLASS 36—INSURANCE AND FINANCIAL

FOR PROVIDING WARRANTY INFORMATION FOR OTHERS ABOUT WINDOWS AND DOORS (U.S. CLS. 100, 101 AND 102).

FIRST USE 12-31-2004; IN COMMERCE 12-31-2004.

CLASS 37—CONSTRUCTION AND REPAIR

FOR RENDITION OF FIELD AND JOB SITE SERVICES, NAMELY, CONSTRUCTION CONSULTATION; PROVIDING BUILDERS WITH THE SERVICE OF CHECKING NEWLY INSTALLED WINDOWS AND DOORS PRIOR TO CLOSING ON THE HOME AND INSTALLING SCREENS TO WINDOWS AND DOORS; FIELD SERVICE WITH HOMEOWNERS AFTER INSTALLATION OF WINDOWS AND DOORS, NAMELY, INSPECTION OF WINDOWS AND DOORS FOR HOMEOWNERS IN THE COURSE OF NEW HOME CONSTRUCTION (U.S. CLS. 100, 103 AND 106).

FIRST USE 12-31-2004; IN COMMERCE 12-31-2004.

3,177,498. MI WINDOWS AND DOORS, INC., GRATZ, PA. SN 76-614,372. PUB. 1-3-2006, FILED 10-1-2004.



THE COLOR(S) BLACK, WHITE AND RED IS/ARE CLAIMED AS A FEATURE OF THE MARK.

THE COLOR BLACK APPEARS IN THE RECTANGULAR CARRIER; THE LETTERS ARE IN THE COLOR WHITE; AND THE OUTLINE FOR THE LETTER "X" IS IN THE COLOR RED.

CLASS 6—METAL GOODS

FOR METAL WINDOWS (U.S. CLS. 2, 12, 13, 14, 23, AND 50).

FIRST USE 12-31-1998; IN COMMERCE 12-31-1998.

CLASS 19—NON-METALLIC BUILDING MATERIALS

FOR NON-METAL WINDOWS (U.S. CLS. 1, 12, 33 AND 50).

FIRST USE 12-31-1998; IN COMMERCE 12-31-1998.

3,177,501. RANDALL PRODUCTIONS COMPANY, CLEVELAND, OH. SN 76-615,279. PUB. 11-22-2005, FILED 10-12-2004.

BRANDED FOR LIFE

THE MARK CONSISTS OF STANDARD CHARACTERS WITHOUT CLAIM TO ANY PARTICULAR FONT, STYLE, SIZE, OR COLOR.

CLASS 34—SMOKERS' ARTICLES

FOR TOBACCO PRODUCTS, NAMELY, CIGARS, SNUFF AND CHEWING TOBACCO (U.S. CLS. 2, 8, AND 17).

FIRST USE 3-1-2006; IN COMMERCE 3-1-2006.

CLASS 35—ADVERTISING AND BUSINESS

FOR RETAIL STORE SERVICES AND MAIL ORDER CATALOG SERVICES, FEATURING GIFTS, GIFT BASKETS, FOODS, SAUCES, GOURMET FOODS, PRODUCE, CANDY, CHOCOLATE, BAKERY ITEMS, HOME DECORATING ITEMS AND ACCESSORIES, TOYS, PLUSH TOYS, PLASTIC NOVELTY LICENSE PLATES, PICTURE FRAMES, WOODEN SIGNS, PILLOWS, CUSHIONS, MIRRORS, FIGURINES, ENGRAVED AND CUT STONE PLAQUES, CHAIR PADS, DISPENSERS FOR PILLS OR CAPSULES SOLD EMPTY; JEWELRY BOXES, BAKER'S RACKS, PLASTIC KEY RINGS, PLASTIC BANNERS (U.S. CLS. 100, 101 AND 102).

FIRST USE 10-10-2006; IN COMMERCE 10-10-2006.

3,177,511. SUBURBAN PROPANE, L.P., WHIPPANY, NJ. SN 76-620,204. PUB. 6-28-2005, FILED 11-12-2004.



Choices. Comfort. Satisfaction.

NO CLAIM IS MADE TO THE EXCLUSIVE RIGHT TO USE "ENERGY SERVICES", APART FROM THE MARK AS SHOWN.

3,177,506. ASIA PACIFIC FUEL CELL TECHNOLOGIES, LTD., CHUNAN, MIAOLI, TAIWAN. SN 76-616,752. PUB. 1-3-2006, FILED 10-20-2004.

FCED

THE MARK CONSISTS OF STANDARD CHARACTERS WITHOUT CLAIM TO ANY PARTICULAR FONT, STYLE, SIZE, OR COLOR.

CLASS 7—MACHINERY

FOR INTEGRATED FUEL CELL POWERED ELECTRIC GENERATORS AND ENGINES NOT FOR LAND VEHICLES; ELECTRIC POWER GENERATORS; DC GENERATORS, AC GENERATORS AND ALTERNATORS; ELECTRIC POWER GENERATORS FOR USE IN EMERGENCIES (U.S. CLS. 13, 19, 21, 23, 31, 34 AND 35).

FIRST USE 5-4-2004; IN COMMERCE 11-1-2004.

CLASS 35—ADVERTISING AND BUSINESS

FOR RETAIL STORE SERVICES FEATURING HEATING, VENTILATION, AND AIR CONDITIONING EQUIPMENT AND APPLIANCES AND PROPANE GAS AND GAS APPLIANCES FOR RESIDENTIAL, COMMERCIAL, INDUSTRIAL, AND AGRICULTURAL USES (U.S. CLS. 100, 101 AND 102).

FIRST USE 12-31-2004; IN COMMERCE 12-31-2004.

CLASS 37—CONSTRUCTION AND REPAIR

FOR INSTALLATION, MAINTENANCE, AND REPAIR OF HEATING, VENTILATION, AND AIR CONDITIONING EQUIPMENT AND APPLIANCES AND PROPANE GAS AND GAS APPLIANCES; AND INSTALLATION OF STORAGE TANKS FOR FUELS AND OF PROPANE GAS DISTRIBUTION SYSTEMS COMPRISING GAS DISTRIBUTION PIPING, CONNECTORS, TUBING, REGULATORS, STORAGE TANKS, EQUIPMENT, AND APPLIANCES (U.S. CLS. 100, 103 AND 106).

FIRST USE 12-31-2004; IN COMMERCE 12-31-2004.

CLASS 39—TRANSPORTATION AND STORAGE

FOR TRANSMISSION AND DISTRIBUTION OF FUEL OIL, GASOLINE, DIESEL FUEL, HEATING OIL, PROPANE GAS, NATURAL GAS AND ELECTRICITY (U.S. CLS. 100 AND 105).

FIRST USE 12-31-2004; IN COMMERCE 12-31-2004.

CLASS 9—ELECTRICAL AND SCIENTIFIC APPARATUS

FOR FUEL CELLS, FUEL CELL STACKS; BATTERIES; ELECTROLYTIC BATTERIES; RECHARGEABLE BATTERIES; SOLAR CELLS; ALKALINE BATTERIES; STORAGE BATTERIES; CURRENT CONDENSERS; CELLULAR PHONE BATTERIES; BATTERY ELECTRODES; INDUSTRIAL GRADE FUEL CELL TEST STATIONS; TEST MODULES FOR THE PURPOSE OF MEASURING ELECTRICAL EFFICIENCY OF FUEL CELL SYSTEMS (U.S. CLS. 21, 23, 26, 36 AND 38).

FIRST USE 5-4-2004; IN COMMERCE 11-1-2004.

CLASS 42—SCIENTIFIC, COMPUTER AND LEGAL SERVICES

FOR SCIENTIFIC RESEARCH IN THE FIELD OF FUEL CELL PRODUCT RESEARCH, PRODUCT DEVELOPMENT; DEVELOPMENT OF TECHNOLOGIES FOR OTHERS IN THE FIELD OF FUEL CELL PRODUCTS; TECHNOLOGY CONSULTATION IN THE FIELD OF CELL PRODUCT DEVELOPMENT AND PRODUCT RESEARCH; DESIGN OF NEW PRODUCTS FOR OTHERS USING FUEL CELL TECHNOLOGY; CONSULTING SERVICES FOR OTHERS IN THE FIELD OF FUEL PRODUCT DEVELOPMENT; ENERGY USAGE FACILITY DESIGNING, NAMELY, ENGINEERING DESIGN SERVICES FOR EFFICIENT ENERGY USAGE; ENVIRONMENTAL PROTECTION TECHNICAL CONSULTING; TECHNICAL RESEARCH, NAMELY, MEASUREMENT OF ENVIRONMENTAL POLLUTION; MECHANICAL AND ELECTRICAL ENGINEERING TECHNICAL CONSULTING (U.S. CLS. 100 AND 101).

FIRST USE 5-4-2004; IN COMMERCE 11-1-2004.

3,177,513. CAREFIRST OF MARYLAND INC., DBA CAREFIRST BLUE CROSS BLUE SHIELD, OWINGS MILLS, MD. SN 76-620,818. PUB. 11-22-2005, FILED 11-16-2004.

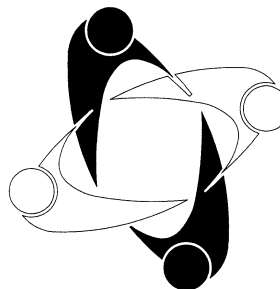
**CLASS 16—PAPER GOODS AND PRINTED MATTER**

FOR PUBLICATIONS, NAMELY, NEWSLETTERS IN THE FIELD OF HEALTH CARE AND INSURANCE (U.S. CLS. 2, 5, 22, 23, 29, 37, 38 AND 50).

FIRST USE 12-1-2004; IN COMMERCE 12-1-2004.

CLASS 35—ADVERTISING AND BUSINESS

FOR BUSINESS CONSULTING SERVICES FOR SELF-INSURED EMPLOYERS (U.S. CLS. 100, 101 AND 102).
FIRST USE 12-1-2004; IN COMMERCE 12-1-2004.

CLASS 36—INSURANCE AND FINANCIAL

FOR ADMINISTRATION OF EMPLOYEE HEALTH BENEFIT PLANS FOR SELF-FUNDED EMPLOYERS (U.S. CLS. 100, 101 AND 102).
FIRST USE 12-1-2004; IN COMMERCE 12-1-2004.

CLASS 41—EDUCATION AND ENTERTAINMENT

FOR EDUCATIONAL SERVICES, NAMELY, CONDUCTING CLASSES, SEMINARS, AND WORKSHOPS IN THE FIELD OF HEALTH INSURANCE FOR SELF-INSURED EMPLOYERS (U.S. CLS. 100, 101 AND 107).
FIRST USE 12-1-2004; IN COMMERCE 12-1-2004.

3,177,516. COSMEDIC R & D, INC., ROCKLIN, CA. SN 76-622,207. PUB. 12-27-2005, FILED 11-24-2004.

DERMASWEEP

THE MARK CONSISTS OF STANDARD CHARACTERS WITHOUT CLAIM TO ANY PARTICULAR FONT, STYLE, SIZE, OR COLOR.

CLASS 8—HAND TOOLS

FOR HAND OPERATED SKIN ABRADERS FOR COSMETIC PURPOSES (U.S. CLS. 23, 28 AND 44).
FIRST USE 12-14-2005; IN COMMERCE 12-14-2005.

CLASS 10—MEDICAL APPARATUS

FOR MEDICAL SKIN ABRADERS (U.S. CLS. 26, 39 AND 44).
FIRST USE 12-14-2005; IN COMMERCE 12-14-2005.

3,177,517. AP&G CO., INC., BROOKLYN, NY. SN 76-622,277. PUB. 4-11-2006, FILED 11-19-2004.



OWNER OF U.S. REG. NO. 2,052,818.

CLASS 5—PHARMACEUTICALS

FOR RODENTICIDES (U.S. CLS. 6, 18, 44, 46, 51 AND 52).
FIRST USE 1-0-2005; IN COMMERCE 1-0-2005.

CLASS 21—HOUSEWARES AND GLASS

FOR RODENTICIDE TRAPS, RODENT AND INSECT GLUE TRAPS, AND MECHANICAL RODENT TRAPS (U.S. CLS. 2, 13, 23, 29, 30, 33, 40 AND 50).
FIRST USE 1-0-2005; IN COMMERCE 1-0-2005.

3,177,521. KORG U.S.A., INC., MELVILLE, NY. SN 76-623,168. PUB. 12-20-2005, FILED 12-3-2004.

KORG

THE MARK CONSISTS OF STANDARD CHARACTERS WITHOUT CLAIM TO ANY PARTICULAR FONT, STYLE, SIZE, OR COLOR.

CLASS 18—LEATHER GOODS

FOR BACKPACKS, CARRY-ON BAGS AND BRIEF-CASES (U.S. CLS. 1, 2, 3, 22 AND 41).
FIRST USE 1-1-1987; IN COMMERCE 1-1-1987.

CLASS 25—CLOTHING

FOR MEN'S AND WOMEN'S CLOTHING, NAMELY, SHIRTS, T-SHIRTS, JACKETS, SWEATSHIRTS; HEADWEAR (U.S. CLS. 22 AND 39).
FIRST USE 1-1-1987; IN COMMERCE 1-1-1987.

3,177,526. TEXAS HEART INSTITUTE, HOUSTON, TX. SN 76-624,953. PUB. 12-6-2005, FILED 12-17-2004.

THE HEART OF DISCOVERY

THE MARK CONSISTS OF STANDARD CHARACTERS WITHOUT CLAIM TO ANY PARTICULAR FONT, STYLE, SIZE, OR COLOR.

CLASS 42—SCIENTIFIC, COMPUTER AND LEGAL SERVICES

FOR MEDICAL AND SCIENTIFIC RESEARCH AND LABORATORY MEDICINE IN THE FIELD OF CARDIOVASCULAR MEDICINE, DESIGN AND TESTING FOR NEW PRODUCT DEVELOPMENT/NEW PRODUCTS FOR OTHERS, MEDICAL LABORATORY SERVICES, PRODUCT DEVELOPMENT AND PRODUCT DEVELOPMENT CONSULTATION, PRODUCT SAFETY TESTING, RESEARCH AND DEVELOPMENT OF NEW PRODUCTS FOR OTHERS, TECHNICAL CONSULTATION AND RESEARCH IN THE FIELD OF CARDIOVASCULAR MEDICINE (U.S. CLS. 100 AND 101).
FIRST USE 11-0-2004; IN COMMERCE 11-0-2004.

CLASS 44—MEDICAL, BEAUTY AND AGRICULTURAL SERVICES

FOR HEALTH CARE SERVICES, NAMELY, MEDICAL CLINIC SERVICES, MEDICAL SERVICES, MEDICAL TESTING, PHYSICIAN SERVICES (U.S. CLS. 100 AND 101).
FIRST USE 11-0-2004; IN COMMERCE 11-0-2004.

3,177,587. C.S. LEWIS (PTE.) LTD., BEACH CENTRE, SINGAPORE. SN 76-978,265. PUB. 11-2-2004, FILED 6-23-2003.



OWNER OF U.S. REG. NOS. 2,274,838, 2,483,052, AND OTHERS.

CLASS 9—ELECTRICAL AND SCIENTIFIC APPARATUS

FOR COMPACT DISCS AND COMPUTER DISCS FEATURING FICTIONAL, EDUCATIONAL AND ENTERTAINMENT WORKS; COMPUTER SOFTWARE FOR EDUCATION AND ENTERTAINMENT, NAMELY, CHILDREN'S EDUCATIONAL COMPUTER SOFTWARE AND SOFTWARE PROGRAMS FEATURING GAMES, GRAPHICS AND INTERACTIVE PROGRAMS FOR THE ENTERTAINMENT AND EDUCATION OF CHILDREN; MOTION PICTURE FILMS AND CINEMATOGRAPHIC FILMS FEATURING FICTIONAL, EDUCATIONAL AND ENTERTAINMENT WORKS; PRE-RECORDED VIDEO TAPES, AUDIO TAPES, COMPACT DISCS, CD ROMS, DVDS, FEATURING FICTIONAL WORKS, EDUCATIONAL WORKS FOR CHILDREN AND ENTERTAINMENT WORKS; COMPUTER AND VIDEO GAME CARTRIDGES, CASSETTES, DISCS AND SOFTWARE; DOWNLOADABLE ELECTRONIC PUBLICATIONS IN THE NATURE OF BOOKS, AND MANUALS, FEATURING FICTIONAL WORKS, EDUCATIONAL WORKS FOR CHILDREN AND ENTERTAINMENT WORKS; DECORATIVE MAGNETS (U.S. CLS. 21, 23, 26, 36 AND 38).
FIRST USE 12-9-2005; IN COMMERCE 12-9-2005.

CLASS 16—PAPER GOODS AND PRINTED MATTER

FOR GREETING CARDS, CALENDARS; POSTERS; PRINTED MATTER, NAMELY, BOOKS, AND MANUALS, FEATURING FICTIONAL, EDUCATIONAL AND ENTERTAINMENT WORKS; DIARIES; ACTIVITY BOOKS; PENS; CHILDREN'S BOOKS; COLORING BOOKS (U.S. CLS. 2, 5, 22, 23, 29, 37, 38 AND 50).
FIRST USE 12-9-2005; IN COMMERCE 12-9-2005.

3,177,589. GRAND ELK, LLC, RADNOR, PA. SN 76-978,302. PUB. 5-11-2004, FILED 5-31-2001.



CLASS 18—LEATHER GOODS

FOR GOLF UMBRELLAS, LUGGAGE, LUGGAGE TAGS, TRUNKS, TRAVELING BAGS, WALKING STICKS (U.S. CLS. 1, 2, 3, 22 AND 41).
FIRST USE 8-24-2002; IN COMMERCE 8-24-2002.

CLASS 21—HOUSEWARES AND GLASS

FOR MUGS, BEVERAGE GLASSES (U.S. CLS. 2, 13, 23, 29, 30, 33, 40 AND 50).
FIRST USE 8-24-2002; IN COMMERCE 8-24-2002.

CLASS 35—ADVERTISING AND BUSINESS

FOR RETAIL STORE SERVICES IN THE FIELDS OF GOLF, CLOTHING, SPORTING GOODS, AND GOLF PRO SHOPS; MAIL-ORDER CATALOG SERVICES IN THE FIELDS OF GOLF, CLOTHING, AND SPORTING GOODS (U.S. CLS. 100, 101 AND 102).
FIRST USE 8-24-2002; IN COMMERCE 8-24-2002.

CLASS 39—TRANSPORTATION AND STORAGE

FOR TRAVEL AGENCY SERVICES, NAMELY, MAKING RESERVATIONS AND BOOKINGS FOR TRANSPORTATION; TRANSPORTATION OF PASSENGERS BY BUS, CAR, OR LIMOUSINE; ARRANGING AND CONDUCTING EXCURSIONS; SKI STORAGE; BOATING, NAMELY, BOAT RENTAL, BOAT TRANSPORT, BOAT MARINA, AND PLEASURE BOAT CRUISES; BICYCLE RENTALS (U.S. CLS. 100 AND 105).
FIRST USE 5-1-2002; IN COMMERCE 5-1-2002.

CLASS 41—EDUCATION AND ENTERTAINMENT

FOR GOLF CLUB SERVICES; GOLF COURSES; PROVIDING FACILITIES FOR RECREATIONAL ACTIVITIES; RECREATIONAL SERVICES IN THE NATURE OF SOCCER GAMES, SOCCER INSTRUCTIONS, SOCCER EXHIBITIONS, SOCCER TOURNAMENTS, SOCCER PRACTICE FACILITIES, BASEBALL GAMES, BASEBALL INSTRUCTIONS, BASEBALL EXHIBITIONS, BASEBALL TOURNAMENTS, BASEBALL PRACTICE FACILITIES, BASKETBALL GAMES, BASKETBALL INSTRUCTIONS, BASKETBALL EXHIBITIONS, BASKETBALL TOURNAMENTS, BASKETBALL PRACTICE FACILITIES, SWIMMING POOLS, GOLF INSTRUCTION, GOLF EXHIBITIONS, GOLF TOURNAMENTS, GOLF DRIVING AND PUTTING PRACTICE FACILITIES, GYMNASIUMS, TENNIS INSTRUCTION, TENNIS EXHIBITIONS, TENNIS TOURNAMENTS, TENNIS PRACTICE FACILITIES, FISHING GUIDE SERVICES, FISHING PONDS, HUNTING GUIDE SERVICES, SKIING, NAMELY, ALPINE, SNOWBOARDING, AND CROSS-COUNTRY SKI RESORTS, CROSS-COUNTRY SKIING GUIDE SERVICES, PROVIDING FACILITIES FOR SKIING AND SNOWBOARDING; ICE SKATING RINKS; RIDING, NAMELY, PROVIDING HORSE BACK RIDING FACILITIES AND GUIDED HORSE BACK TOURS; HIKING, NAMELY, PROVIDING HIKING TRAILS AND HIKING GUIDES; SKI RENTAL SERVICES; ICE SKATE RENTALS; ARRANGING FOR TICKET RESERVATIONS FOR ENTERTAINMENT EVENTS AND RECREATIONAL ACTIVITIES; HEALTH CLUB SERVICES, NAMELY, PROVIDING INSTRUCTION AND EQUIPMENT IN THE FIELD OF PHYSICAL EXERCISE (U.S. CLS. 100, 101 AND 107).
FIRST USE 8-24-2002; IN COMMERCE 8-24-2002.

CLASS 42—SCIENTIFIC, COMPUTER AND LEGAL SERVICES

FOR RESORT HOTEL AND LODGING SERVICES; RESTAURANT AND BAR SERVICES; TITLE SEARCHING AND TITLE SERVICES; HEALTH SPAS, AND HEALTH RESORT SERVICES (U.S. CLS. 100 AND 101).
FIRST USE 8-24-2002; IN COMMERCE 8-24-2002.

3,177,590. C.S. LEWIS (PTE.) LTD., BEACH CENTRE, SINGAPORE. SN 76-978,339. PUB. 6-8-2004, FILED 3-20-2002.

THE LION, THE WITCH AND THE WARDROBE

CLASS 9—ELECTRICAL AND SCIENTIFIC APPARATUS

FOR ENTERTAINMENT SOFTWARE, NAMELY, COMPUTER SOFTWARE FEATURING BOOKS, MOTION PICTURES AND GAMES IN THE FIELDS OF LITERATURE, RELIGION, COMEDY, DRAMA, SUSPENSE, FANTASY, ACTION, ADVENTURE AND/OR ANIMATION; PRE-RECORDED VIDEO TAPES, AUDIO TAPES, COMPACT DISCS, CD ROMS AND DVDS, FEATURING LITERATURE, RELIGION, COMEDY, DRAMA, SUSPENSE, FANTASY, ACTION, ADVENTURE AND/OR ANIMATION; COMPUTER AND VIDEO GAME CARTRIDGES, CASSETTES, DISCS AND SOFTWARE; ELECTRONIC PUBLICATIONS, NAMELY, BOOKS, FEATURING FICTIONAL, EDUCATIONAL AND ENTERTAINMENT WORKS RECORDED ON COMPUTER MEDIA; DOWNLOADABLE ELECTRONIC PUBLICATIONS IN THE NATURE OF BOOKS, AND MANUALS, FEATURING FICTIONAL, EDUCATIONAL AND ENTERTAINMENT WORKS; AND DECORATIVE MAGNETS (U.S. CLS. 21, 23, 26, 36 AND 38).

FIRST USE 12-9-2005; IN COMMERCE 12-9-2005.

CLASS 16—PAPER GOODS AND PRINTED MATTER

FOR GREETING CARDS; CALENDARS; POSTERS; PRINTED MATTER, NAMELY, BOOKS AND MANUALS FEATURING LITERATURE, RELIGION, COMEDY, DRAMA, SUSPENSE, FANTASY, ACTION, ADVENTURE AND/OR ANIMATION; DIARIES; ACTIVITY BOOKS; PENS; CHILDREN'S BOOKS AND COLORING BOOKS (U.S. CLS. 2, 5, 22, 23, 29, 37, 38 AND 50).

FIRST USE 12-9-2005; IN COMMERCE 12-9-2005.

3,177,591. FIRST AID ONLY, INC., VANCOUVER, WA. SN 76-978,361. PUB. 7-1-2003, FILED 4-11-2002.



OWNER OF U.S. REG. NO. 1,771,033.
NO CLAIM IS MADE TO THE EXCLUSIVE RIGHT TO USE "FIRST AID", APART FROM THE MARK AS SHOWN.

CLASS 5—PHARMACEUTICALS

FOR FIRST AID KITS; SAFETY KITS CONTAINING FIRST AID SUPPLIES AND WOUND CARE SUPPLIES IN THE NATURE OF ANTISEPTICS, PRE-MOISTENED ANTISEPTIC AND MEDICATED WIPES AND PADS, BURN RELIEF MEDICATIONS, BURN DRESSINGS, HYDROCORTISONE CREAM, ANTIBIOTIC OINTMENTS, ISOPROPYL ALCOHOL FOR MEDICAL USE, HYDROGEN PEROXIDE FOR MEDICAL USE, ADHESIVE BANDAGES, WOUND DRESSINGS, GAUZE, MEDICAL ADHESIVE TAPE, EYE DROPS, EYE WASHES, IRRIGATING SOLUTIONS FOR EYE AND SKIN USE, ANTACIDS, IBUPROFEN FOR USE AS AN ORAL ANALGESIC, ASPIRIN, ACETAMINOPHEN, MENSTRUAL SYMPTOM TREATMENT PREPARATIONS, PHARMACEUTICAL ANTITUSSIVE COLD PREPARATIONS, COUGH TREATMENT PREPARATIONS, COUGH DROPS, DECONGESTANT TABLETS, ELECTROLYTES, MOTION SICKNESS TREATMENT PREPARATIONS, THROAT LOZENGES, AND AMMONIA INHALANTS, AND SAFETY EYEGLASSES, GOGGLES, EAR PLUGS NOT FOR MEDICAL PURPOSES, EARMUFFS FOR NOISE REDUCTION, DUST MASKS AND OTHER SAFETY ITEMS; EMERGENCY PREPAREDNESS KITS CONTAINING FIRST AID SUPPLIES IN THE NATURE OF ANTISEPTICS, PRE-MOISTENED ANTISEPTIC AND MEDICATED WIPES AND PADS, BURN RELIEF MEDICATIONS, BURN DRESSINGS, HYDROCORTISONE CREAM, ANTIBIOTIC OINTMENTS, ISOPROPYL ALCOHOL FOR MEDICAL USE, HYDROGEN PEROXIDE FOR MEDICAL USE, ADHESIVE BANDAGES, WOUND DRESSINGS, GAUZE, MEDICAL ADHESIVE TAPE, EYE DROPS, EYE WASHES, IRRIGATING SOLUTIONS FOR EYE AND SKIN USE, ANTACIDS, IBUPROFEN FOR USE AS AN ORAL ANALGESIC, ASPIRIN, ACETAMINOPHEN, MENSTRUAL SYMPTOM TREATMENT PREPARATIONS, PHARMACEUTICAL ANTITUSSIVE COLD PREPARATIONS, COUGH TREATMENT PREPARATIONS, COUGH DROPS, DECONGESTANT TABLETS, ELECTROLYTES, MOTION SICKNESS TREATMENT PREPARATIONS, THROAT LOZENGES, AND AMMONIA INHALANTS, AND THERMOMETERS FOR MEDICAL PURPOSES, CPR MASKS, SUN BLOCK, RAIN PONCHOS, EMERGENCY BLANKETS, FLASHLIGHTS, BATTERIES, BOTTLED EMERGENCY DRINKING WATER, DEHYDRATED FOOD PACKETS, MATCHES, TWEEZERS, SCISSORS AND OTHER ITEMS FOR USE IN AN EMERGENCY SITUATION; FIRST AID SUPPLIES, NAMELY ANTISEPTICS, PRE-MOISTENED ANTISEPTIC AND MEDICATED WIPES AND PADS, BURN RELIEF MEDICATIONS, BURN DRESSINGS, HYDROCORTISONE CREAM, ANTIBIOTIC OINTMENTS, ISOPROPYL ALCOHOL FOR MEDICAL USE, HYDROGEN PEROXIDE FOR MEDICAL USE, ADHESIVE BANDAGES, WOUND DRESSINGS, GAUZE, MEDICAL ADHESIVE TAPE, EYE DROPS, EYE WASHES, IRRIGATING SOLUTIONS FOR EYE AND SKIN USE, ANTACIDS, IBUPROFEN FOR USE AS AN ORAL ANALGESIC, ASPIRIN, ACETAMINOPHEN, MENSTRUAL SYMPTOM TREATMENT PREPARATIONS, PHARMACEUTICAL ANTITUSSIVE COLD PREPARATIONS, COUGH TREATMENT PREPARATIONS, COUGH DROPS, DECONGESTANT TABLETS, ELECTROLYTES, MOTION SICKNESS TREATMENT PREPARATIONS, THROAT LOZENGES, AMMONIA INHALANTS (U.S. CLS. 6, 18, 44, 46, 51 AND 52).

FIRST USE 1-10-2005; IN COMMERCE 1-10-2005.

CLASS 10—MEDICAL APPARATUS

FOR PERSONAL PROTECTION KITS CONTAINING MEDICAL GOWNS, SURGICAL SHOE COVERS, SURGICAL CAPS, PLASTIC BIOHAZARD BAGS, GLOVES FOR MEDICAL USE, EYE SHIELDS, FLUID CONTROL SOLIDIFIERS, ANTISEPTIC AND MEDICATED PRE-MOISTENED WIPES, DISPOSABLE TOWELS, SCOOPS, GUIDES, AND CPR KITS CONTAINING CPR MASKS, GLOVES FOR MEDICAL USE, MOUTH GUARDS FOR MEDICAL PURPOSES, AND PRE-MOISTENED ANTI-SEPTIC WIPES FOR USE IN PROTECTING AGAINST BLOODBORNE PATHOGENS AND OTHER BIOLOGICAL HAZARDS; CPR KITS CONTAINING CPR MASKS, GLOVES FOR MEDICAL USE, MOUTH GUARDS FOR MEDICAL PURPOSES, AND PRE-MOISTENED ANTI-SEPTIC WIPES; FIRST AID SUPPLIES, NAMELY ELASTIC BANDAGES, SLINGS FOR MEDICAL USE, CHEMICALLY ACTIVATED HOT AND COLD COMPRESSES, ABDOMINAL PADS, MOUTH GUARDS FOR MEDICAL PURPOSES (U.S. CLS. 26, 39 AND 44).
FIRST USE 6-14-2005; IN COMMERCE 6-14-2005.

3,177,619. THE CULTURAL EDGE, LLC, TORRANCE, CA. SN 78-166,081. PUB. 12-16-2003, FILED 9-19-2002.

THE CULTURAL EDGE

CLASS 35—ADVERTISING AND BUSINESS

FOR BUSINESS CONSULTING SERVICES, INCLUDING MANAGEMENT AND LEADERSHIP CONSULTING, ORGANIZATIONAL DEVELOPMENT, STRATEGIC PLANNING AND EMPLOYEE COMPENSATION CONSULTING SERVICES AND BUSINESS COMMUNICATIONS CONSULTING SERVICES (U.S. CLS. 100, 101 AND 102).
FIRST USE 0-0-2003; IN COMMERCE 0-0-2003.

CLASS 36—INSURANCE AND FINANCIAL

FOR EMPLOYEE BENEFIT AND RETIREMENT PLAN CONSULTING, CONSULTATION AND ADMINISTRATION SERVICES (U.S. CLS. 100, 101 AND 102).
FIRST USE 0-0-2003; IN COMMERCE 0-0-2003.

3,177,639. S. C. JOHNSON & SON, INC., RACINE, WI. SN 78-215,691. PUB. 2-24-2004, FILED 2-17-2003.

RAID REACH & KILL

OWNER OF U.S. REG. NOS. 628,506, 2,373,630, AND OTHERS.

CLASS 5—PHARMACEUTICALS

FOR DOMESTIC INSECTICIDES (U.S. CLS. 6, 18, 44, 46, 51 AND 52).
FIRST USE 2-9-2006; IN COMMERCE 2-9-2006.

CLASS 8—HAND TOOLS

FOR HAND OPERATED TRIGGER SPRAYER FOR DISPENSING INSECTICIDES (U.S. CLS. 23, 28 AND 44).
FIRST USE 2-9-2006; IN COMMERCE 2-9-2006.

CLASS 21—HOUSEWARES AND GLASS

FOR AEROSOL DISPENSERS NOT FOR MEDICAL USE (U.S. CLS. 2, 13, 23, 29, 30, 33, 40 AND 50).
FIRST USE 2-9-2006; IN COMMERCE 2-9-2006.

3,177,642. WAUGH, WENDY ANN, NEW YORK, NY. SN 78-230,816. PUB. 6-22-2004, FILED 3-27-2003.

PURE TRAITS

CLASS 16—PAPER GOODS AND PRINTED MATTER

FOR ART PRINTS, PAINTINGS, DRAWINGS AND GRAPHIC ART REPRODUCTIONS (U.S. CLS. 2, 5, 22, 23, 29, 37, 38 AND 50).
FIRST USE 3-1-2006; IN COMMERCE 3-1-2006.

CLASS 35—ADVERTISING AND BUSINESS

FOR RETAIL ART AND PHOTOGRAPHY SUPPLY STORE SERVICES, AND ART GALLERIES (U.S. CLS. 100, 101 AND 102).
FIRST USE 3-1-2006; IN COMMERCE 3-1-2006.

3,177,604. OPA! SOUVLAKI FRANCHISE GROUP INC., CALGARY, ALBERTA. SN 78-129,139. PUB. 6-24-2003, FILED 5-16-2002.

OPA! SOUVLAKI

NO CLAIM IS MADE TO THE EXCLUSIVE RIGHT TO USE "SOUVLAKI", APART FROM THE MARK AS SHOWN. THE ENGLISH TRANSLATION OF THE WORD "OPA" IN THE MARK IS "AN EXPRESSION OF GLEE".

CLASS 25—CLOTHING

FOR CLOTHING, NAMELY, T-SHIRTS, SWEAT-SHIRTS, PANTS, JACKETS, APRONS, CAPS, HATS (U.S. CLS. 22 AND 39).
FIRST USE 11-0-1997; IN COMMERCE 8-5-2006.

CLASS 30—STAPLE FOODS

FOR FROZEN AND PACKAGED SOUVLAKI, PREPARED AND PACKAGED SOUVLAKI, FROZEN AND PACKAGED SPANAKOPITA, PREPARED AND PACKAGED SPANAKOPITA, FROZEN AND PACKAGED BAKLAVA, PREPARED AND PACKAGED BAKLAVA, FROZEN AND PACKAGED CALAMARI, PREPARED AND PACKAGED CALAMARI (U.S. CL. 46).
FIRST USE 11-0-1997; IN COMMERCE 8-5-2006.

CLASS 42—SCIENTIFIC, COMPUTER AND LEGAL SERVICES

FOR RESTAURANT AND TAKE-OUT SERVICES; CARRYING ON THE BUSINESS OF ESTABLISHING FRANCHISE OPERATIONS (U.S. CLS. 100 AND 101).
FIRST USE 11-0-1997; IN COMMERCE 8-5-2006.

CLASS 42—SCIENTIFIC, COMPUTER AND LEGAL SERVICES

FOR GRAPHIC ART DESIGN SERVICES (U.S. CLS. 100 AND 101).
FIRST USE 3-1-2006; IN COMMERCE 3-1-2006.

3,177,655. DMB LADERA LLC, SAN JUAN CAPISTRANO, CA. SN 78-251,774. PUB. 7-5-2005, FILED 5-19-2003.



3,177,646. SESAME WORKSHOP, NEW YORK, NY. SN 78-235,967. PUB. 4-6-2004, FILED 4-9-2003.

**CLASS 10—MEDICAL APPARATUS**

FOR BABY BOTTLES, PACIFIERS FOR BABIES (U.S. CLS. 26, 39 AND 44).
FIRST USE 6-0-2005; IN COMMERCE 6-0-2005.

CLASS 18—LEATHER GOODS

FOR DIAPER BAGS, BABY BACKPACKS, BABY CARRIERS WORN ON THE BODY (U.S. CLS. 1, 2, 3, 22 AND 41).
FIRST USE 6-0-2005; IN COMMERCE 6-0-2005.

CLASS 25—CLOTHING

FOR BABY BIBS NOT MADE OF PAPER, BODYSUITS, HEADWEAR, KNIT CAPS, BONNETS, HOSIERY, KNIT SOCKS, INFANT GOWNS, ROBES, SHOES, SLEEPERS, SLIPPERS, T-SHIRTS (U.S. CLS. 22 AND 39).
FIRST USE 6-0-2005; IN COMMERCE 6-0-2005.

CLASS 28—TOYS AND SPORTING GOODS

FOR INFANT TOYS, BABY MULTIPLE ACTIVITY TOYS, BABY RATTLES, BABY RATTLES INCORPORATING TEETHING RINGS, BALLS, DOLLS, ELECTRONIC LEARNING TOYS, PLUSH TOYS, BATH TOYS, BEACH TOYS, NAMELY SAND TOYS, TOY BUILDING BLOCKS, SWIMMING AIDS, NAMELY, POOL RINGS, ARM FLOATS FOR RECREATIONAL USE, AND SWIM FLOATS FOR RECREATIONAL USE; TOYS DESIGNED TO BE ATTACHED TO CAR SEATS, STROLLERS, CRIBS, AND HIGH CHAIRS, PARTY FAVORS IN THE NATURE OF SMALL TOYS, PARTY FAVORS IN THE NATURE OF CRACKERS AND NOISEMAKERS (U.S. CLS. 22, 23, 38 AND 50).
FIRST USE 6-0-2005; IN COMMERCE 6-0-2005.

OWNER OF U.S. REG. NOS. 2,582,016, 2,891,200, AND OTHERS.

THE COLOR(S) TEAL BLUE, TURQUOISE AND LIGHT GREEN IS/ARE CLAIMED AS A FEATURE OF THE MARK.

THE TWO LEFT SPHERES ARE TEAL BLUE, THE CENTER SPHERE IS TURQUOISE, AND THE RIGHT SPHERE IS LIGHT GREEN. THE COLORS TEAL BLUE, TURQUOISE AND LIGHT GREEN ARE CLAIMED AS A FEATURE OF THE MARK.

THE MARK CONSISTS OF A GLOBE DESIGN.

CLASS 36—INSURANCE AND FINANCIAL

FOR REAL ESTATE MANAGEMENT; REAL ESTATE AGENCY SERVICES (U.S. CLS. 100, 101 AND 102).
FIRST USE 5-0-2003; IN COMMERCE 5-0-2003.

CLASS 37—CONSTRUCTION AND REPAIR

FOR REAL ESTATE DEVELOPMENT SERVICES (U.S. CLS. 100, 103 AND 106).
FIRST USE 5-0-2003; IN COMMERCE 5-0-2003.

3,177,658. SWISS CORNER, INC., DBA SALTWATER CAFE, NOKOMIS, FL. SN 78-254,241. PUB. 6-29-2004, FILED 5-26-2003.

CHEF ROLF

NO CLAIM IS MADE TO THE EXCLUSIVE RIGHT TO USE CHEF, APART FROM THE MARK AS SHOWN.

THE NAME(S), PORTRAIT(S), AND/OR SIGNATURE(S) SHOWN IN THE MARK IDENTIFIES A LIVING INDIVIDUAL WHOSE CONSENT(S) TO REGISTER IS SUBMITTED.

CLASS 9—ELECTRICAL AND SCIENTIFIC APPARATUS

FOR PRE-RECORDED VIDEOTAPES FEATURING A TELEVISION PROGRAM IN THE FIELD OF COOKING (U.S. CLS. 21, 23, 26, 36 AND 38).
FIRST USE 12-4-2002; IN COMMERCE 10-15-2004.

CLASS 30—STAPLE FOODS

FOR SPICES AND SAUCES (U.S. CL. 46).
FIRST USE 11-15-2003; IN COMMERCE 10-15-2004.

CLASS 43—HOTEL AND RESTAURANT SERVICES

FOR RESTAURANT SERVICES (U.S. CLS. 100 AND 101).
FIRST USE 12-16-1996; IN COMMERCE 11-15-2001.

3,177,693. KOBAYASHI PHARMACEUTICAL CO., LTD., OSAKA, JAPAN. SN 78-316,576. PUB. 11-15-2005, FILED 10-21-2003.

3,177,661. SHEPHERD, JENNIFER L., STOCKTON, NJ. SN 78-265,233. PUB. 9-28-2004, FILED 6-20-2003.

LIPSTICK MYSTIC**CLASS 16—PAPER GOODS AND PRINTED MATTER**

FOR SYNDICATED NEWSPAPER COLUMN DEALING WITH ASTROLOGY, PSYCHIC PHENOMENA AND NEW AGE TOPICS; NEWSPAPER ADVICE COLUMNS; MAGAZINE ADVICE COLUMNS; NEWSLETTERS ON NEW AGE SUBJECTS (U.S. CLS. 2, 5, 22, 23, 29, 37, 38 AND 50).
FIRST USE 9-8-2004; IN COMMERCE 9-8-2004.

CLASS 41—EDUCATION AND ENTERTAINMENT

FOR PROVIDING ON-LINE PUBLICATIONS IN THE NATURE OF NEWSLETTERS IN THE FIELD OF NEW AGE SUBJECTS (U.S. CLS. 100, 101 AND 107).
FIRST USE 9-25-2004; IN COMMERCE 9-25-2004.

CLASS 45—PERSONAL SERVICES

FOR PROVIDING INFORMATION CONCERNING NEW AGE SUBJECTS, ASTROLOGY, AND PSYCHIC PHENOMENA VIA THE INTERNET; PROVIDING ASTROLOGICAL REPORTS AND PSYCHIC READINGS VIA THE INTERNET; PSYCHIC READING SERVICES; PROVIDING ONLINE CONTENT AND WEBLOG SERVICES, NAMELY, PROVIDING AN ON-LINE DIARY/JOURNAL WITH LINKS TO THE WEBSITES OF OTHERS ALL IN THE FIELD OF NEW AGE SUBJECTS, ASTROLOGY AND PSYCHIC PHENOMENA (U.S. CLS. 100 AND 101).
FIRST USE 10-28-2004; IN COMMERCE 10-28-2004.

3,177,670. AMINO UP CHEMICAL CO., LTD., HOKKAIDO, JAPAN. SN 78-286,863. PUB. 12-20-2005, FILED 8-13-2003.

OLIGONOL**CLASS 5—PHARMACEUTICALS**

FOR PHARMACEUTICAL PREPARATIONS FOR ANTILIPEMIC AND ANTIARTERIOSCLEROTIC EFFECTS; PHARMACEUTICAL PREPARATIONS FOR THE TREATMENT OF ALZHEIMER'S DISEASE AND CANCER; DIETARY SUPPLEMENTS FOR ANTI-AGING AND ANTIOXIDATION; DIETARY SUPPLEMENTS FOR HEALTHY BRAIN ACTIVITY; NUTRITIONAL AND DIETARY SUPPLEMENTS AND NUTRITIONAL ADDITIVES CONTAINING PLANT-DERIVED POLYPHENOLS IN THE FORM OF CAPSULE, TABLET, POWDER, GRANULE, LIQUID OR GEL (U.S. CLS. 6, 18, 44, 46, 51 AND 52).
FIRST USE 3-1-2006; IN COMMERCE 7-3-2006.

CLASS 32—LIGHT BEVERAGES

FOR PROCESSED VEGETABLE JUICES, FLAVORED WATERS, AND SOFT DRINKS CONTAINING PLANT-DERIVED POLYPHENOLS (U.S. CLS. 45, 46 AND 48).
FIRST USE 3-1-2006; IN COMMERCE 7-3-2006.

**CLASS 11—ENVIRONMENTAL CONTROL APPARATUS**

FOR AIR DEODORIZING APPARATUS, NAMELY, DEODORIZERS FOR REFRIGERATORS; AIR FILTRATION COMPONENTS, NAMELY, FILTERS FOR AIR CONDITIONERS, FILTERS FOR CIGARETTE SMOKE; BIDETS; HEATING ELEMENTS, NAMELY, CHEMICALLY ACTIVATED HEATING CUSHIONS NOT FOR MEDICAL USE, AND CHEMICALLY ACTIVATED HEATING PADS NOT FOR MEDICAL USE; DISINFECTANT DISPENSERS NOT FOR PERSONAL USE, NAMELY, DISINFECTANT DISPENSERS FOR TOILETS, AIR CONDITIONERS, MICROWAVE OVENS AND LUNCHBOXES; REFRIGERATORS; AIR PURIFIERS; SANITARY APPARATUS, NAMELY, DISPOSABLE BOX FOR SANITARY PADS; AIR STERILIZERS; DEODORIZING APPARATUS NOT FOR PERSONAL USE, NAMELY, DEODORIZER USED IN PACHINKO PARLORS, RESTAURANTS, HOTELS AND HOUSES (U.S. CLS. 13, 21, 23, 31 AND 34).
FIRST USE 4-5-1991; IN COMMERCE 6-30-2002.

CLASS 21—HOUSEWARES AND GLASS

FOR HAIR BRUSHES; BATH BRUSHES; TOILET BRUSHES; SPONGES FOR HOUSEHOLD CLEANING PURPOSES; BRUSHES FOR HOUSEHOLD CLEANING PURPOSES; ABRASIVE SPONGES FOR PERSONAL USE; TOOTHBRUSHES; POLISHING PAPERS IMPREGNATED WITH TEETH POLISHING AGENTS FOR POLISHING TEETH OR ARTIFICIAL TEETH, WITHOUT WATER; TOOTHPICKS; TOOTHPICK HOLDERS NOT OF PRECIOUS METAL; ELECTRIC TOOTHBRUSHES; DENTAL FLOSS; HAND-OPERATED CLEANING INSTRUMENTS, NAMELY, DENTAL FLOSS COMBINED WITH TOOTHPICKS AND INTERDENTAL BRUSHES; NON-ELECTRIC DUSTING APPARATUS, NAMELY, NON-WOVEN DUSTING CLOTH FOR FLOOR, FURNITURE, AND TOILET SEATS; ABRASIVE PADS FOR KITCHEN PURPOSES; CLEANING CLOTHS IMPREGNATED WITH DETERGENT; SCRUBBING BRUSHES; BRUSHES FOR CLEANING TANKS AND CONTAINERS; SCOURING PADS; NON-ELECTRIC POLISHING APPARATUS AND MACHINES FOR HOUSEHOLD PURPOSES, NAMELY, DETERGENT-IMPREGNATED NON-WOVEN CLOTH USED FOR MICROWAVE OVENS AND DETERGENT DISPENSERS FOR AIR CONDITIONERS; GLOVES FOR HOUSEHOLD PURPOSES; FURNITURE DUSTERS; CERAMICS FOR HOUSEHOLD PURPOSES, NAMELY CERAMIC POT USED FOR COOKING FISH AND CERAMIC POT CONTAINING DETERGENT FOR TOILETS AND ROOMS; GLASS POTS CONTAINING DETERGENT FOR TOILETS AND ROOMS; SPRAYERS FOR PERFUME SOLD EMPTY; AEROSOL DISPENSERS FOR NON-MEDICAL USE (U.S. CLS. 2, 13, 23, 29, 30, 33, 40 AND 50).
FIRST USE 9-2-1987; IN COMMERCE 4-25-2004.

3,177,694. FERRARI S.P.A., 41100 MODENA, ITALY. SN 78-317,680. PUB. 7-5-2005, FILED 10-23-2003.



OWNER OF U.S. REG. NO. 1,942,115.
THE MARK CONSISTS OF THE NUMERAL, 612, AND, THE WORDING SCAGLIETTI.

CLASS 12—VEHICLES

FOR LAND MOTOR VEHICLES, NAMELY, MOTOR CARS, AUTOMOBILES, SPORTS CARS AND STRUCTURAL PARTS THEREFOR (U.S. CLS. 19, 21, 23, 31, 35 AND 44).
FIRST USE 7-0-2004; IN COMMERCE 7-0-2004.

CLASS 28—TOYS AND SPORTING GOODS

FOR MODEL CARS IN AN ASSEMBLY KIT FORM, TOY MODEL VEHICLES, TOY COLLECTION MODELS REPRODUCING AUTOMOBILES (U.S. CLS. 22, 23, 38 AND 50).
FIRST USE 7-0-2004; IN COMMERCE 7-0-2004.

3,177,698. KOCKELMAN, STEVEN, J, HONOLULU, HI. SN 78-319,911. PUB. 10-18-2005, FILED 10-28-2003.



NO CLAIM IS MADE TO THE EXCLUSIVE RIGHT TO USE "FITNESS", APART FROM THE MARK AS SHOWN.

CLASS 25—CLOTHING

FOR CLOTHING NAMELY, SHORTS, PANTS, T-SHIRTS, HATS, WRISTBANDS, HEADBANDS, POLO SHIRTS, LONG SLEEVE SHIRTS, ATHLETIC PANTS, SWEAT PANTS, MESH-SHIRTS, GLOVES, SOCKS, SHOES, SANDALS, BELTS, TANK-TOPS, ATHLETIC SHIRTS, JERSEYS, JACKETS, COATS, SWIM-WEAR (U.S. CLS. 22 AND 39).
FIRST USE 6-1-2001; IN COMMERCE 6-1-2001.

CLASS 41—EDUCATION AND ENTERTAINMENT

FOR CONDUCTING, CLASSES, SEMINARS, AND WORKSHOPS IN THE FIELD OF PHYSICAL FITNESS, HEALTH AND WELLNESS AND NUTRITION; ALSO CONDUCTING ENTERTAINMENT IN THE NATURE OF PHYSICAL FITNESS COMPETITIONS, PHYSICAL FITNESS EXPOS, AND PHYSICAL FITNESS INSTRUCTION (U.S. CLS. 100, 101 AND 107).
FIRST USE 6-1-2001; IN COMMERCE 6-1-2001.

3,177,699. MCCUE CORPORATION, SALEM, MA. SN 78-320,012. PUB. 6-8-2004, FILED 10-29-2003.



CLASS 6—METAL GOODS

FOR METAL FLOOR MOUNTED PROTECTIVE RAILINGS, BOLLARDS, POSTS AND BUMPERS, FOR USE IN STORES, AND PRIMARILY METAL STRUCTURES FOR SHOPPING CART STORAGE (U.S. CLS. 2, 12, 13, 14, 23, 25 AND 50).
FIRST USE 2-1-2006; IN COMMERCE 2-1-2006.

CLASS 12—VEHICLES

FOR SHOPPING CARTS WITH INTEGRATED CHILD CARRIERS (U.S. CLS. 19, 21, 23, 31, 35 AND 44).
FIRST USE 8-1-2004; IN COMMERCE 8-1-2004.

CLASS 20—FURNITURE AND ARTICLES NOT OTHERWISE CLASSIFIED

FOR PRIMARILY NON-METAL FLOOR AND WALL MOUNTED PROTECTIVE RAILINGS AND BUMPERS, FOR USE IN STORES TO PROTECT WALLS; PRIMARILY NON-METAL STORAGE STRUCTURES FOR SHOPPING CART STORAGE (U.S. CLS. 2, 13, 22, 25, 32 AND 50).
FIRST USE 8-1-2004; IN COMMERCE 8-1-2004.

3,177,705. COTA, ANGELICA, SOUTH GATE, CA. SN 78-325,450. PUB. 2-1-2005, FILED 11-10-2003.

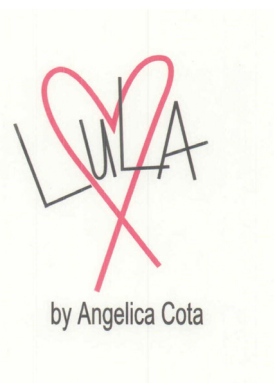

THE NAME ANGELICA COTA IDENTIFIES A LIVING INDIVIDUAL WHOSE CONSENT IS OF RECORD.
THE COLOR(S) MAGENTA HEART IS/ARE CLAIMED AS A FEATURE OF THE MARK.
THE COLOR MAGENTA IS CLAIMED AS A FEATURE OF THE MARK. THE COLOR MAGENTA APPEARS IN THE MIDDLE OF THE MARK TO FORM AN ASSYMETRICAL

HEART DESIGN HAVING LINES WHICH CROSS AND EXTEND AT THE BOTTOM TO FORM AN "X".

THE MARK CONSISTS OF A MAGENTA ASSYMETRICAL HEART WHOSE LINES CROSS AND EXTEND AT THE BOTTOM TO FORM AN X. "LULA" IS WRITTEN ACROSS THE HEART WITH THE "L" ON THE LEFT AND THE "A" ON THE RIGHT AND A LOWER CASE "U" AND UPPER-CASE L IN THE MIDDLE OF THE HEART. "BY ANGELICA COTA" IS CENTERED BELOW THE HEART.

CLASS 18—LEATHER GOODS

FOR CLOTHING ACCESSORIES NAMELY, HANDBAGS, WALLETS AND COIN PURSES (U.S. CLS. 1, 2, 3, 22 AND 41).

FIRST USE 1-19-2000; IN COMMERCE 6-2-2003.

CLASS 25—CLOTHING

FOR BELTS AND T-SHIRTS (U.S. CLS. 22 AND 39).

FIRST USE 3-31-2004; IN COMMERCE 12-12-2004.

3,177,706. HEALTH FITNESS CORPORATION, MINNEAPOLIS, MN. SN 78-326,055. PUB. 7-26-2005, FILED 11-11-2003.

HFC

THE MARK CONSISTS OF STANDARD CHARACTERS WITHOUT CLAIM TO ANY PARTICULAR FONT, STYLE, SIZE, OR COLOR.

OWNER OF U.S. REG. NOS. 2,246,485 AND 2,421,638.

CLASS 35—ADVERTISING AND BUSINESS

FOR PROVIDING BUSINESS MANAGEMENT AND STAFFING SERVICES IN THE FIELDS OF HEALTH ASSESSMENT, HEALTH SCREENING, HEALTH FITNESS, INJURY PREVENTION, RISK REDUCTION, HEALTH AND WELLNESS EDUCATION, WEIGHT MANAGEMENT AND WEIGHT LOSS, NUTRITION, PHYSICAL ACTIVITY, CHOLESTEROL, BLOOD PRESSURE, SMOKING CESSATION, MASSAGE, OCCUPATIONAL HEALTH AND REHABILITATION; PROVIDING BUSINESS MANAGEMENT CONSULTING IN THE FIELDS OF HEALTH ASSESSMENT, HEALTH SCREENING, HEALTH FITNESS, INJURY PREVENTION, RISK REDUCTION, HEALTH AND WELLNESS EDUCATION, WEIGHT MANAGEMENT AND WEIGHT LOSS, NUTRITION, PHYSICAL ACTIVITY, CHOLESTEROL, BLOOD PRESSURE, SMOKING CESSATION, OCCUPATIONAL HEALTH AND REHABILITATION (U.S. CLS. 100, 101 AND 102).

FIRST USE 8-31-2001; IN COMMERCE 10-15-2001.

CLASS 41—EDUCATION AND ENTERTAINMENT

FOR PROVIDING EDUCATIONAL AND PHYSICAL FITNESS PROGRAMS IN THE FIELDS OF HEALTH ASSESSMENT, HEALTH SCREENING, HEALTH FITNESS, INJURY PREVENTION, RISK REDUCTION, HEALTH AND WELLNESS EDUCATION, WEIGHT MANAGEMENT AND WEIGHT LOSS, NUTRITION, PHYSICAL ACTIVITY, CHOLESTEROL, BLOOD PRESSURE, SMOKING CESSATION, MASSAGE, OCCUPATIONAL HEALTH AND REHABILITATION; PROVIDING ON-LINE INFORMATION IN THE FIELDS OF HEALTH AND WELLNESS EDUCATION, PHYSICAL ACTIVITY; PROVIDING ADVICE IN THE FIELDS OF SPORTS INJURY PREVENTION, HEALTH AND WELLNESS EDUCATION, PHYSICAL ACTIVITY (U.S. CLS. 100, 101 AND 107).

FIRST USE 8-31-2001; IN COMMERCE 10-15-2001.

CLASS 44—MEDICAL, BEAUTY AND AGRICULTURAL SERVICES

FOR PROVIDING ON-LINE INFORMATION IN THE FIELDS OF HEALTH ASSESSMENT, HEALTH SCREENING, WORK-RELATED INJURY PREVENTION, RISK REDUCTION, WEIGHT MANAGEMENT AND WEIGHT LOSS, NUTRITION, CHOLESTEROL, BLOOD PRESSURE, SMOKING CESSATION, OCCUPATIONAL HEALTH AND REHABILITATION; PROVIDING HEALTH IMPROVEMENT AND FITNESS COUNSELING AND ADVICE IN THE FIELDS OF HEALTH ASSESSMENT, HEALTH SCREENING, WORK-RELATED INJURY PREVENTION, RISK REDUCTION, WEIGHT MANAGEMENT AND WEIGHT LOSS, NUTRITION, CHOLESTEROL, BLOOD PRESSURE, SMOKING CESSATION, OCCUPATIONAL HEALTH AND REHABILITATION; PROVIDING ON-LINE INFORMATION IN THE FIELDS OF HEALTH FITNESS, SPORTS INJURY PREVENTION; PROVIDING HEALTH IMPROVEMENT COUNSELING AND ADVICE IN THE FIELDS OF SPORTS INJURY (U.S. CLS. 100 AND 101).

FIRST USE 8-31-2001; IN COMMERCE 10-15-2001.

3,177,713. KATIN, JOE J., PARKER, TX. SN 78-332,444. PUB. 6-7-2005, FILED 11-24-2003.



THE NAME "DADDY JOE'S" IDENTIFIES A LIVING INDIVIDUAL WHOSE CONSENT IS OF RECORD.

THE COLOR(S) RED, BLACK, CREAM, BEIGE, AND BROWN IS/ARE CLAIMED AS A FEATURE OF THE MARK.

THE MARK CONSISTS OF A MASCULINE CARICATURE IN AN OVAL IN THE COLORS BROWN, BEIGE, CREAM, AND BLACK, ABOVE THE VERBIAGE "DADDY JOE'S" IN BLOCK CAPITAL- AND LOWER-CASE LETTERS IN RED, OUTLINED IN BLACK.

CLASS 29—MEATS AND PROCESSED FOODS

FOR MEATS AND PROCESSED FOODS, NAMELY, CORNED-BEEF HASH; CHICKEN-FRIED STEAK; BEEF CHILI; BEEF POT ROAST (U.S. CL. 46).

FIRST USE 1-1-2006; IN COMMERCE 1-1-2006.

CLASS 30—STAPLE FOODS

FOR STAPLE FOODS, NAMELY, COFFEE; TEA; FLOUR; AND HONEY (U.S. CL. 46).
FIRST USE 1-1-2006; IN COMMERCE 1-1-2006.

3,177,726. EAT WELL BE WELL FOODS, INC., HOOD RIVER, OR. SN 78-346,866. PUB. 6-6-2006, FILED 12-31-2003.

EAT WELL BE WELL

THE MARK CONSISTS OF STANDARD CHARACTERS WITHOUT CLAIM TO ANY PARTICULAR FONT, STYLE, SIZE, OR COLOR.

3,177,715. EVEREST EQUIPMENT INC., HALIFAX, NOVA SCOTIA, CANADA. SN 78-339,320. PUB. 6-14-2005, FILED 12-11-2003.

AMERICAN SNO-PLOWS

NO CLAIM IS MADE TO THE EXCLUSIVE RIGHT TO USE "AMERICAN SNO-PLOWS", APART FROM THE MARK AS SHOWN.

CLASS 29—MEATS AND PROCESSED FOODS

FOR FOODS FOR PEOPLE ON CARBOHYDRATE-CONTROLLED DIETS OR FOR PEOPLE WHO WISH TO LOWER THEIR OVERALL INTAKE OF CARBOHYDRATES, NAMELY, SOY-BASED SALTY AND SWEET SNACKS (U.S. CL. 46).
FIRST USE 8-23-2004; IN COMMERCE 8-23-2004.

CLASS 7—MACHINERY

FOR SNOW PLOWS; HARNESSSES FOR MOUNTING SNOW PLOWS AND BLOWERS ON VEHICLES; MECHANICAL MATERIAL SPREADERS FOR CONTROL OF SNOW AND ICE ON ROADS; CYLINDERS; PARTS FOR ALL THE AFORESAID GOODS (U.S. CLS. 13, 19, 21, 23, 31, 34 AND 35).
FIRST USE 12-18-2003; IN COMMERCE 12-18-2003.

CLASS 30—STAPLE FOODS

FOR FOODS FOR PEOPLE ON CARBOHYDRATE-CONTROLLED DIETS OR FOR PEOPLE WHO WISH TO LOWER THEIR OVERALL INTAKE OF CARBOHYDRATES, NAMELY, CEREAL-BASED SNACK FOODS, PROCESSED CEREALS AND READY-TO-EAT, PREPARED BREAKFAST CEREAL AND GRANOLA; INSTANT HOT BREAKFAST CEREALS; TORTILLA CHIPS; PREPARED ENTREES CONSISTING PRIMARILY OF PASTA OR RICE; READY-TO-EAT CEREAL-BASED FOOD BARS; DESSERTS, NAMELY, CHEESE-CAKES, ICE CREAM, AND CHOCOLATE-BASED CANDY; CONDIMENTS, NAMELY, SALAD DRESSINGS, MARINADES, AND SAUCES (U.S. CL. 46).
FIRST USE 8-23-2004; IN COMMERCE 8-23-2004.

CLASS 37—CONSTRUCTION AND REPAIR

FOR REPAIRING, SERVICING, REBUILDING AND RECONDITIONING SNOW PLOWS, HARNESSSES FOR MOUNTING SNOW PLOWS AND BLOWERS ON VEHICLES, MATERIAL SPREADERS FOR CONTROL OF SNOW AND ICE ON ROADS, CYLINDERS AND CIRCUITS, AND PARTS FOR ALL THE AFORESAID GOODS (U.S. CLS. 100, 103 AND 106).
FIRST USE 12-18-2003; IN COMMERCE 12-18-2003.

3,177,734. ITHRIVE HEALTH, LLC, BETHESDA, MD. SN 78-354,737. PUB. 12-7-2004, FILED 1-21-2004.

3,177,718. DREXEL HERITAGE FURNITURE INDUSTRIES, INC., HIGH POINT, NC. SN 78-342,090. PUB. 4-26-2005, FILED 12-17-2003.

DREXEL  HERITAGE

Village Green

CLASS 20—FURNITURE AND ARTICLES NOT OTHERWISE CLASSIFIED

FOR FURNITURE (U.S. CLS. 2, 13, 22, 25, 32 AND 50).
FIRST USE 4-30-2002; IN COMMERCE 4-30-2002.

THE MARK CONSISTS OF STANDARD CHARACTERS WITHOUT CLAIM TO ANY PARTICULAR FONT, STYLE, SIZE, OR COLOR.

CLASS 27—FLOOR COVERINGS

FOR RUGS (U.S. CLS. 19, 20, 37, 42 AND 50).
FIRST USE 4-30-2002; IN COMMERCE 4-30-2002.

CLASS 3—COSMETICS AND CLEANING PREPARATIONS**CLASS 35—ADVERTISING AND BUSINESS**

FOR FURNITURE RETAIL STORE SERVICES; ADVERTISING CONSULTING SERVICES FOR OTHERS FOR RETAIL FURNITURE STORES (U.S. CLS. 100, 101 AND 102).
FIRST USE 4-30-2002; IN COMMERCE 4-30-2002.

FOR MEN'S AND WOMEN'S SKIN AND BODY CARE PRODUCTS, NAMELY COSMETICS, HAND AND BODY LOTION, SOAP, SHAMPOO, HAIR CONDITIONER, CLEANSERS, DEODORANTS AND ANTIPERSPIRANTS AND ALL-PURPOSE CLEANING PREPARATION (U.S. CLS. 1, 4, 6, 50, 51 AND 52).
FIRST USE 4-0-2004; IN COMMERCE 4-0-2004.

CLASS 5—PHARMACEUTICALS

FOR VITAMINS, MINERALS, NAMELY, MINERAL SUPPLEMENTS, HOMEOPATHIC SUPPLEMENTS, DIET PILLS AND CAPSULES, DIETARY SUPPLEMENTS, MEAL SUPPLEMENTS, NAMELY, MEAL REPLACEMENT BARS, DIETARY DRINK MIXES USED AS A MEAL REPLACEMENT AND MEAL REPLACEMENT SUPPLEMENT DRINK MIXES (U.S. CLS. 6, 18, 44, 46, 51 AND 52).

FIRST USE 4-0-2004; IN COMMERCE 4-0-2004.

CLASS 35—ADVERTISING AND BUSINESS

FOR RETAIL AND ONLINE RETAIL PHARMACY AND HEALTH STORE SERVICES (U.S. CLS. 100, 101 AND 102).

FIRST USE 4-0-2004; IN COMMERCE 4-0-2004.

CLASS 44—MEDICAL, BEAUTY AND AGRICULTURAL SERVICES

FOR COUNSELING IN THE FIELD OF HEALTH CARE AND WEIGHT REDUCTION DIET PLANNING AND HEALTH SPA SERVICES, NAMELY, COSMETIC BODY CARE SERVICES (U.S. CLS. 100 AND 101).

FIRST USE 4-0-2004; IN COMMERCE 4-0-2004.

CLASS 9—ELECTRICAL AND SCIENTIFIC APPARATUS

FOR COMPUTER SOFTWARE, NAMELY, DATA ENCRYPTION SOFTWARE FOR SECURE DATA STORAGE AND RETRIEVAL AND TRANSMISSION OF CONFIDENTIAL CUSTOMER INFORMATION USED BY INDIVIDUALS, BANKING AND FINANCIAL INSTITUTIONS; BANKING SOFTWARE FOR USE IN INTER-BANK BANK CARD INFORMATION SWITCH AND INTERCHANGE SYSTEMS; BANKING SOFTWARE FOR USE IN ENABLING BANK CARDS OR SMART CARDS TO INTERACT WITH TERMINALS AND CARD READERS; ELECTRONIC DEVICES, NAMELY, COMPUTER HARDWARE IN THE NATURE OF ENCRYPTION KEYS FOR USE IN CREATING DIGITAL CERTIFICATES AND DIGITAL SIGNATURES; DEVICES, NAMELY, CARD READERS FOR READING CARDS AND READING INFORMATION STORED IN COMPUTER CHIPS; DOWNLOADABLE ELECTRONIC PUBLICATIONS IN THE NATURE OF PAMPHLETS, BROCHURES, NEWSLETTERS, JOURNALS AND MAGAZINES FEATURING INFORMATION ABOUT FINANCIAL AND BANKING SERVICES; MAGNETICALLY ENCODED CHARGE CARDS, BANK CARDS, CREDIT CARDS, DEBIT CARDS, PAYMENT CARDS, INTEGRATED CIRCUIT CARDS, NAMELY, BLANK SMART CARDS AND MAGNETIC IDENTITY CARDS AND CARD READERS AND OTHER ELECTRONIC APPARATUS, NAMELY, COMPUTER DIAL TERMINALS, FOR VERIFYING THE AUTHENTICITY OF SUCH CARDS FOR USE THEREWITH; CASH REGISTERS; AUTOMATIC VENDING MACHINES; AUTOMATIC TICKET DISPENSERS; AUTOMATED TELLER MACHINES; COMPUTERIZED POINT-OF-SALE MACHINES FOR USE AS STAND ALONE UNITS TO TALLY SALES; MONEY COUNTING AND AUTOMATED PAPER MONEY SORTING MACHINES; AND FALSE COIN DETECTORS (U.S. CLS. 21, 23, 26, 36 AND 38).

FIRST USE 12-5-2005; IN COMMERCE 12-5-2005.

3,177,758. CHINA UNIONPAY CO., LTD., SHANGHAI, CHINA. SN 78-369,778. PUB. 9-13-2005, FILED 2-18-2004.



THE MARK CONSISTS OF TWO (2) CHINESE CHARACTERS.

THE CHINESE CHARACTERS IN THE MARK TRANSLITERATE TO YIN LIAN; "YIN" MEANS "SILVER" AND "LIAN" MEANS "UNITE, JOIN."

CLASS 36—INSURANCE AND FINANCIAL

FOR INSURANCE UNDERWRITING SERVICES IN THE FIELD OF TRAVEL INSURANCE; BROAD BASED FINANCIAL SERVICES PROVIDED OVER THE TELEPHONE AND INTERNET OR OTHER ELECTRONIC MEANS, NAMELY, FINANCIAL BROKERAGE SERVICES IN THE FIELD OF SECURITIES, INSURANCE AND ART; FINANCIAL MANAGEMENT SERVICES INCLUDING MAINTENANCE OF FINANCIAL RECORDS; ELECTRONIC AND ON-LINE BANKING SERVICES; ELECTRONIC PAYMENT SERVICES IN THE NATURE OF BILL PAYMENT PROCESSING SERVICES PROVIDED THROUGH A WEB SITE, NAMELY, ELECTRONIC PROCESSING AND TRANSMISSION OF BILL PAYMENT DATA, INCLUDING PAYMENT AUTHORIZATION AND PAYMENT SETTLEMENT SERVICES; FINANCIAL EXCHANGE SERVICES; FINANCIAL INVESTMENT SERVICES IN THE FIELD OF REAL ESTATE AND SECURITIES; ELECTRONIC FUNDS TRANSFER AND CURRENCY EXCHANGE SERVICES; FINANCIAL SERVICES IN THE NATURE OF BANK CARD, CREDIT CARD, DEBIT CARD AND PRE-PAID CARD SERVICES, INCLUDING CREDIT CARD AND DEBIT CARD VERIFICATION; FINANCIAL SERVICES RELATING TO CASH DISBURSEMENT, CHECK VERIFICATION AND CHECK CASHING SERVICES; ELECTRONIC CASH TRANSACTIONS; POINT-OF-SALE AND POINT TRANSACTION SERVICES IN THE NATURE OF THE PROVISION OF FINANCIAL SERVICES FOR THE SUPPORT OF RETAIL SERVICES PROVIDED THROUGH ON-LINE, THROUGH NETWORKS OR OTHER ELECTRONIC MEANS USING ELECTRONICALLY DIGITIZED INFORMATION, NAMELY, PAYMENT TRANSACTION AUTHENTICATION AND VERIFICATION SERVICES; ISSUING AND REDEMPTION OF TRAVELER'S CHECKS AND TRAVEL VOUCHERS; HOME BANKING SERVICES; FINANCIAL INFORMATION PROVIDED BY ELECTRONIC MEANS; FINANCIAL CONSULTANCY; AUTOMATED TELLER MACHINE SERVICES; AND FINANCIAL CLEARING HOUSES (U.S. CLS. 100, 101 AND 102).

FIRST USE 12-5-2005; IN COMMERCE 12-5-2005.

3,177,759. JOSIE GROUP, LLC, COLTS NECK, NJ. SN 78-371,111. PUB. 4-26-2005, FILED 2-20-2004.



CLASS 16—PAPER GOODS AND PRINTED MATTER

FOR PRINTED MATERIALS, NAMELY STORY BOOKS, COLORING BOOKS, CHILDREN'S ACTIVITY BOOKS, ADDRESS BOOKS, APPOINTMENT BOOKS, COMPOSITION BOOKS, STATIONERY, MENUS, STICKERS, POSTERS, PAPER LABELS, CALENDARS, DIARIES, SPIRAL NOTEBOOKS, GREETING CARDS, POSTCARD AND EVENT PROGRAMS (U.S. CLS. 2, 5, 22, 23, 29, 37, 38 AND 50).
FIRST USE 5-23-2003; IN COMMERCE 5-23-2003.

CLASS 25—CLOTHING

FOR APPAREL, NAMELY, SHIRTS, PANTS, JACKETS, SHORTS, APRONS, UNDERWEAR AND HATS (U.S. CLS. 22 AND 39).
FIRST USE 5-23-2003; IN COMMERCE 5-23-2003.

CLASS 41—EDUCATION AND ENTERTAINMENT

FOR ENTERTAINMENT SERVICES, NAMELY, LIVE APPEARANCES AND PERFORMANCES BY A COSTUMED CHARACTER IN A RESTAURANT AND AT PRIVATE FUNCTIONS (U.S. CLS. 100, 101 AND 107).
FIRST USE 5-23-2003; IN COMMERCE 5-23-2003.

3,177,760. MASTERCHEM INDUSTRIES LLC, IMPERIAL, MO. SN 78-371,466. PUB. 3-22-2005, FILED 2-20-2004.

Expressions CureCoat

THE MARK CONSISTS OF STANDARD CHARACTERS WITHOUT CLAIM TO ANY PARTICULAR FONT, STYLE, SIZE, OR COLOR.

CLASS 1—CHEMICALS

FOR CHEMICAL WATERPROOFING PREPARATIONS FOR USE ON MASONRY, AND OTHER POROUS SURFACES (U.S. CLS. 1, 5, 6, 10, 26 AND 46).
FIRST USE 4-17-2005; IN COMMERCE 4-17-2005.

CLASS 2—PAINTS

FOR TINTING BASE IN THE NATURE OF PAINT, EPOXY COATINGS FOR USE ON VARIOUS SURFACES, MASONRY AND STUCCO PAINT (U.S. CLS. 6, 11 AND 16).
FIRST USE 4-17-2005; IN COMMERCE 4-17-2005.

CLASS 3—COSMETICS AND CLEANING PREPARATIONS

FOR DEGREASING PREPARATIONS FOR CONCRETE, AND OTHER POROUS SURFACES, AND ALL PURPOSE CLEANING PREPARATIONS (U.S. CLS. 1, 4, 6, 50, 51 AND 52).
FIRST USE 4-17-2005; IN COMMERCE 4-17-2005.

3,177,761. MASTERCHEM INDUSTRIES LLC, IMPERIAL, MO. SN 78-371,482. PUB. 3-22-2005, FILED 2-20-2004.

Expressions NatureGuard

THE MARK CONSISTS OF STANDARD CHARACTERS WITHOUT CLAIM TO ANY PARTICULAR FONT, STYLE, SIZE, OR COLOR.

CLASS 1—CHEMICALS

FOR CHEMICAL WATERPROOFING PREPARATIONS FOR USE ON WOOD (U.S. CLS. 1, 5, 6, 10, 26 AND 46).
FIRST USE 4-17-2005; IN COMMERCE 4-17-2005.

CLASS 2—PAINTS

FOR WOOD STAINS, COATINGS IN THE NATURE OF CLEAR FINISHES FOR FINISHING WOOD (U.S. CLS. 6, 11 AND 16).
FIRST USE 4-17-2005; IN COMMERCE 4-17-2005.

CLASS 3—COSMETICS AND CLEANING PREPARATIONS

FOR PAINT REMOVING PREPARATIONS, WOOD STRIPPING AND CLEANING PREPARATIONS (U.S. CLS. 1, 4, 6, 50, 51 AND 52).
FIRST USE 4-17-2005; IN COMMERCE 4-17-2005.

3,177,762. BREAKTHROUGH LEARNING, INC., MORGAN HILL, CA. SN 78-373,125. PUB. 11-15-2005, FILED 2-24-2004.

Six Decisions

THE MARK CONSISTS OF STANDARD CHARACTERS WITHOUT CLAIM TO ANY PARTICULAR FONT, STYLE, SIZE, OR COLOR.

CLASS 9—ELECTRICAL AND SCIENTIFIC APPARATUS

FOR EDUCATIONAL SOFTWARE FOR USE WITH CORPORATE TRAINING WORKSHOPS FEATURING INFORMATION ON MANAGEMENT DECISION-MAKING AND SYSTEMS THINKING (U.S. CLS. 21, 23, 26, 36 AND 38).

FIRST USE 2-24-2004; IN COMMERCE 4-9-2004.

CLASS 41—EDUCATION AND ENTERTAINMENT

FOR CORPORATE TRAINING IN THE NATURE OF WORKSHOPS THAT TEACH MANAGEMENT DECISION-MAKING AND SYSTEMS THINKING (U.S. CLS. 100, 101 AND 107).

FIRST USE 2-24-2004; IN COMMERCE 4-9-2004.

3,177,767. SPONGETECH, INC., LOS ANGELES, CA. SN 78-375,044. PUB. 1-10-2006, FILED 2-26-2004.

SPONGEABLES

THE MARK CONSISTS OF STANDARD CHARACTERS WITHOUT CLAIM TO ANY PARTICULAR FONT, STYLE, SIZE, OR COLOR.

CLASS 3—COSMETICS AND CLEANING PREPARATIONS

FOR SKIN MOISTURIZERS; SHAVING SOAPS; CLEANING PREPARATIONS, NAMELY SKIN CLEANING PREPARATION, BODY CLEANING PREPARATIONS, HAND CLEANING PREPARATIONS; SOAPS, NAMELY SKIN SOAPS, COSMETIC SOAPS, BODY SOAPS, HAND SOAPS, DETERGENT SOAPS; SKIN CLEANSERS; SKIN CLEANSING CREAMS; SKIN CLEANSING LOTIONS; SKIN CLEANING PREPARATIONS; PERSONAL CLEANING PREPARATIONS; BODY CARE PREPARATIONS (U.S. CLS. 1, 4, 6, 50, 51 AND 52).

FIRST USE 3-5-2004; IN COMMERCE 3-5-2004.

CLASS 21—HOUSEWARES AND GLASS

FOR IMPREGNATED CLEANING PADS; IMPREGNATED CLEANING SPONGES; IMPREGNATED CLEANING CLOTHS; ABRASIVE SPONGES FOR SCRUBBING THE SKIN; IMPREGNATED SKIN CLEANING SPONGES; IMPREGNATED BODY CLEANING SPONGES; SPONGES DIPPED IN NATURAL OILS AND SOAPS; SPONGES IMPREGNATED WITH SOAPS; SPONGES IMPREGNATED WITH NATURAL OILS; SPONGES IMPREGNATED WITH SKIN CLEANSING SUBSTANCES (U.S. CLS. 2, 13, 23, 29, 30, 33, 40 AND 50).

FIRST USE 3-5-2004; IN COMMERCE 3-5-2004.

3,177,770. ALBERTSON'S, INC., BOISE, ID. SN 78-379,410. PUB. 2-14-2006, FILED 3-5-2004.

EQUALINE

THE MARK CONSISTS OF STANDARD CHARACTERS WITHOUT CLAIM TO ANY PARTICULAR FONT, STYLE, SIZE, OR COLOR.

CLASS 3—COSMETICS AND CLEANING PREPARATIONS

FOR BEAUTY AND PERSONAL CARE PRODUCTS, NAMELY, AFTER SUN SKIN LOTION, AFTER SHAVE PREPARATIONS, NAMELY, CREAMS, GELS AND LOTIONS, ALL PURPOSE COTTON SWABS FOR PERSONAL USE, NON-MEDICATED ANTI-CAVITY MOUTH RINSES, BATH GELS AND SOAPS, BATH OILS, BEAUTY LOTIONS, BODY OILS, BODY POWDERS, BODY CLEANSERS, BRONZING SUNLESS TAN ACCELERATING FOAM, BUBBLE BATH, COARSE AND SMOOTH NAIL EMERY BOARDS, COSMETICS, COTTON BALLS FOR COSMETIC PURPOSES, COTTON PUFFS AND SQUARES FOR COSMETIC PURPOSES, CREAM SKIN CLEANERS, DAILY PORE FACIAL CLEANSERS, DENTAL TRAVEL KIT CONSISTING OF TOOTHPASTE, TOOTHBRUSH AND MOUTH WASH ALL SOLD AS A UNIT, DENTIFRICES, DENTURE CLEANERS, DENTURE CLEANING PREPARATIONS, EMERY BOARDS, FOOT CREAMS, GAUZE PADS FOR COSMETIC PURPOSES, SKIN LOTION CONTAINING GLYCERINE AND ROSEWATER, HAIR CARE PREPARATIONS, HAIR SHAMPOO AND CONDITIONERS, HAIR TONICS, MILK BATHS, NON-MEDICATED MOUTH RINSES, MOUTHWASH, NAIL POLISH REMOVER, NON-MEDICATED DIAPER RASH OINTMENT AND LOTIONS, NON-MEDICATED HAIR CARE PREPARATIONS, NON-MEDICATED LIP BALM, NON-MEDICATED SKIN CARE PREPARATIONS, NON-MEDICATED OATMEAL BODY BATHS, PETROLEUM JELLY FOR COSMETIC PURPOSES, PRE-MOISTENED COSMETIC WIPES, PRE-MOISTENED FACIAL CLEANING TOWELETES, PUMICE STONES FOR PERSONAL USE, SHAVING BALMS, GELS, CREAMS AND LOTIONS, SHAVING PREPARATIONS, SHOWER AND BATH POWDERS, SKIN CLEANSERS AND CREAMS, SKIN LOTIONS AND CREAMS, SKIN MOISTURIZERS, SOAPS, SUNSCREEN AND SUN-BLOCK PREPARA-

TIONS, SUN TANNING PREPARATIONS, TEETH WHITENING GELS AND FILMS, AND TOOTHPASTE (U.S. CLS. 1, 4, 6, 50, 51 AND 52).

FIRST USE 9-0-2004; IN COMMERCE 9-0-2004.

CLASS 5—PHARMACEUTICALS

FOR HEALTH CARE PRODUCTS, NAMELY, ACETAMINOPHEN, PHARMACEUTICAL PREPARATIONS FOR STOMACH ACID REDUCTION, ACNE TREATMENT PREPARATIONS, ADHESIVE BANDAGES, ADHESIVE TAPE FOR MEDICAL USE, ALLERGY RELIEF MEDICATIONS, MEDICATED ALOE VERA GELS FOR TREATMENT OF SUNBURN, ANALGESICS, ANTA-CIDS, ANTIBACTERIAL PHARMACEUTICALS, ANTI-BIOTIC CREAMS AND OINTMENTS, ANTI-DIARRHEA MEDICATIONS, ANTI-FUNGAL CREAMS FOR MEDICAL USE, ANTI-GAS MEDICATIONS, ANTIHISTAMINES, ANTI-ITCH CREAMS, NAUSEA TREATMENT PREPARATIONS, MEDICATED ANTI-PLAQUE MOUTH RINSE, ANTISEPTICS, ARTHRITIS PAIN RELIEF MEDICATION, ARTIFICIAL TEARS, ASPIRIN, BANDAGES FOR SKIN WOUNDS, BISMUTH PREPARATIONS FOR PHARMACEUTICAL PURPOSES, BRONCHIAL DILATORS, CALAMINE LOTIONS, CASTOR AND MINERAL OILS FOR MEDICAL PURPOSES, PHARMACEUTICAL PREPARATIONS FOR THE TREATMENT OF CHEST CONGESTION, PREPARATIONS FOR THE TREATMENT OF COLDS, CONTACT LENS CLEANING SOLUTIONS, CONTACT LENS WETTING SOLUTIONS, CONTACT LENS DISINFECTANTS, COTTON FOR MEDICAL PURPOSES, COUGH DROPS AND COUGH SYRUP, COUGH TREATMENT PREPARATIONS, DAIRY LACTOSE DIGESTIVE SUPPLEMENTS, PHARMACEUTICAL PREPARATIONS FOR THE TREATMENT OF DAIRY INTOLERANCE, DECONGESTANTS, DENTAL RINSE, DENTURE ADHESIVES, DIARRHEA MEDICATION, DOUCHES, MEDICATED DRAWING SALVES FOR TREATMENT OF MINOR SKIN IRRITATIONS, EAR DROPS, ENEMA PREPARATIONS, EPSOM SALTS, EXPECTORANTS, EYE DROPS, EYE WASHES, FEMININE HYGIENE PADS, FIBER FOOD SUPPLEMENTS, FLU COLD AND COUGH TREATMENT PREPARATIONS, PHARMACEUTICAL PREPARATIONS FOR GAS RELIEF, GLUCOSE TABLETS FOR USE AS A DIETARY SUPPLEMENT, HAND SANITIZERS, HEMORRHOIDAL TREATMENT, PREPARATIONS AND OINTMENTS, HYDROCORTISONE, HYDROGEN PEROXIDE FOR MEDICAL USE, IBUPROFEN FOR USE AS ORAL ANALGESIC, INCONTINENCE GARMENTS AND PADS, IODINE, IRRIGATING SOLUTIONS FOR EYE USE, ISOPROPYL ALCOHOL FOR MEDICAL USE, LAXATIVES, LICE TREATMENT SHAMPOOS, LICE TREATMENT PREPARATIONS, MEDICATED BODY POWDERS, MEDICATED DECONGESTANT CHEST RUBS, MEDICATED CHEWING GUM TO STOP SMOKING, MEDICATED SKIN CLEANSERS, MEDICATED DIAPER RASH OINTMENTS, MEDICATED HAIR CARE PREPARATIONS, MEDICATED LOZENGES, MEDICATED MOUTH WASH, MEDICATED PRE-MOISTENED HEMORRHOIDAL, MEDICATED PRE-MOISTENED WIPES, MEDICATED SUNBURN GELS, MEDICATED MENTHOL VAPOR PATCHES FOR THE TREATMENT OF CONGESTION, MICONAZOLENITRATE PREPARATIONS FOR THE TREATMENT OF ATHLETE'S FOOT, MIGRAINE TREATMENT PREPARATIONS, MILK OF MAGNESIA, ESSENTIAL MINERAL OILS FOR MEDICAL USE, MINOXIDIL, MOTION SICKNESS TREATMENT PREPARATIONS, MUSCLE RELAXANTS, NASAL SPRAY PREPARATIONS, NUTRITIONAL SUPPLEMENTS, HERBAL SUPPLEMENTS, OVULATION TEST KITS, PAIN RELIEF MEDICATIONS, PANTY LINERS, PANTY SHIELDS, GELS FOR USE AS A PERSONAL LUBRICANTS, PETROLEUM JELLY FOR MEDICAL PURPOSES, MEDICATED PETROLEUM LIP BALM, PREGNANCY TEST KITS FOR HOME USE, PREPARATIONS FOR TREATING COLDS, RUBBING ALCOHOL, RUBBING COMPOUNDS FOR MEDICAL AND/OR THERAPEUTIC USE, SALINE NASAL SPRAY PREPARATIONS, SALINE SOLUTIONS FOR CONTACT LENSES, SANITARY PADS, MEDICATED SHAMPOOS AND CONDITIONERS, PHARMACEUTICAL PREPARATIONS, NAMELY, SIMETHICONE DROPS FOR USE IN TREATING EXCESSIVE GAS IN THE DIGESTIVE TRACT AND COLIC, SLEEPING PILLS, SORE THROAT LOZENGES, PHARMACEUTICAL PREPARATIONS FOR USE AS STAY-AWAKE AIDS, STOOL SOFTENERS, MEDICATED STY OINTMENTS, SUPPOSITORIES, TAM-

PONS, TOPICAL ANESTHETICS, TRANSDERMAL PATCHES FOR USE IN THE TREATMENT OF SMOKERS TO STOP SMOKING, MEDICATED VAGINAL CREAMS, VAGINAL TOPICAL ANESTHETICS, VAPOR INHALERS FILLED WITH LEVOMETAMFETAMINE, VAPOR INHALERS FILLED WITH EPINEPHRINE, MEDICATED VITAMIN A AND E LOTIONS, VITAMIN AND MINERAL SUPPLEMENTS, MEDICATED VITAMIN E BODY OILS, WITCH HAZEL, OTHER HEALTH CARE PRODUCTS, NAMELY, WOUND DRESSINGS, GAUZE, MEDICATED ACNE TREATMENT PADS AND PORE STRIPS, ACNE TREATMENT PREPARATIONS, PHARMACEUTICAL PREPARATIONS, NAMELY, MICONAZOLE NITRATE PREPARATIONS FOR THE TREATMENT OF ATHLETE'S FOOT AND YEAST INFECTIONS, MEDICATED TIOCONAZOLE OINTMENT, WARMING GELS FOR USE AS A PERSONAL LUBRICANT, AND MEDICATED ZINC OINTMENT (U.S. CLS. 6, 18, 44, 46, 51 AND 52).

FIRST USE 9-0-2004; IN COMMERCE 9-0-2004.

CLASS 8—HAND TOOLS

FOR BEAUTY AND PERSONAL CARE PRODUCTS, NAMELY, CALLUS RASPS, CALLUS CUTTERS, CUTICLE SCISSORS AND PUSHERS, EYELASH CURLERS, NAIL SCISSORS, NAIL BUFFERS AND CLIPPERS, NAIL FILES, RAZOR BLADES, TOENAIL NIPPERS, TWEEZERS, AND MANICURE SETS (U.S. CLS. 23, 28 AND 44).

FIRST USE 9-0-2004; IN COMMERCE 9-0-2004.

CLASS 10—MEDICAL APPARATUS

FOR HEALTH CARE PRODUCTS, NAMELY, EXTERNAL NASAL DILATORS, ASPIRATORS FOR MEDICAL USE, BLOOD GLUCOSE METERS, CHEMICALLY ACTIVATED HOT AND COLD GEL PACKS FOR MEDICAL PURPOSES, THERMOMETERS FOR MEDICAL PURPOSES, COMPRESSION BANDAGES, DENTAL INSTRUMENTS, NAMELY, MIRRORS, PICKS AND INTERDENTAL STIMULATORS, EAR SYRINGES, LANCETS, MEDICAL ICE PACKS, MEDICAL SYRINGES, SILICONE GEL SHEETING FOR TREATMENT OF SCARS, AND VAGINAL DOUCHE SYRINGES; EAR PLUGS USED FOR MEDICAL PURPOSES (U.S. CLS. 26, 39 AND 44).

FIRST USE 3-0-2005; IN COMMERCE 3-0-2005.

CLASS 21—HOUSEWARES AND GLASS

FOR BEAUTY AND PERSONAL CARE PRODUCTS, NAMELY, BATH PRODUCTS, NAMELY, FACIAL CLEANING BUFFS, DAILY CLEANING CLOTHS, TOOTHBRUSHES, DENTAL FLOSS, FOOT BRUSHES (U.S. CLS. 2, 13, 23, 29, 30, 33, 40 AND 50).

FIRST USE 2-0-2005; IN COMMERCE 2-0-2005.

CLASS 25—CLOTHING

FOR BEAUTY AID PRODUCTS, NAMELY, GEL INSOLES, AND INSOLES (U.S. CLS. 22 AND 39).

FIRST USE 3-0-2005; IN COMMERCE 3-0-2005.

3,177,772. ORONTES B.V., AMSTERDAM AIRPORT, NETHERLANDS. SN 78-384,523. PUB. 6-21-2005, FILED 3-15-2004.

3,177,781. MORINAGA & CO., LTD., TOKYO, JAPAN. SN 78-386,916. PUB. 12-27-2005, FILED 3-18-2004.



TRAGNARION

THE MARK CONSISTS OF STANDARD CHARACTERS WITHOUT CLAIM TO ANY PARTICULAR FONT, STYLE, SIZE, OR COLOR.

CLASS 9—ELECTRICAL AND SCIENTIFIC APPARATUS

FOR RECORDABLE MAGNETIC DISCS, RECORDABLE COMPACT DISCS, RECORDABLE OPTICAL DISCS, AND MAGNETIC DISCS, COMPACT DISCS, AND OPTICAL DISCS CONTAINING COMPUTER SOFTWARE PROGRAMS NAMELY, COMPUTER GAMES, AND MANUALS SOLD IN CONNECTION THEREWITH (U.S. CLS. 21, 23, 26, 36 AND 38).

FIRST USE 7-17-2006; IN COMMERCE 7-17-2006.

CLASS 16—PAPER GOODS AND PRINTED MATTER

FOR NOTEBOOK PAPER, NOTEPAPER, PRINTING TYPE, PRINTING BLOCKS, PRINTING PAPER, AND MANUALS, PRINTED GUIDES, AND PRINTED INSTRUCTIONAL, EDUCATIONAL, AND TEACHING MATERIALS FOR USE IN OPERATING SOFTWARE PROGRAMS (U.S. CLS. 2, 5, 22, 23, 29, 37, 38 AND 50).

FIRST USE 7-17-2006; IN COMMERCE 7-17-2006.

CLASS 36—INSURANCE AND FINANCIAL

FOR INVESTMENT CONSULTATION; INVESTMENT ADVICE; INVESTMENT MANAGEMENT; AND INVESTMENT RESEARCH REGARDING PRODUCTION, MARKETING, AND SALES IN THE FIELD OF VIDEO GAMES, MOTION PICTURES, TELEVISION, AND PRINTED MEDIA (U.S. CLS. 100, 101 AND 102).

FIRST USE 7-17-2006; IN COMMERCE 7-17-2006.

CLASS 29—MEATS AND PROCESSED FOODS

FOR SNACKS, NAMELY, CANDIED FRUIT SNACKS, POTATO-BASED SNACK FOODS; BEVERAGES MADE FROM CHOCOLATE, NAMELY, DAIRY-BASED CHOCOLATE FOOD BEVERAGES; VEGETABLE-BASED CHOCOLATE FOOD BEVERAGES (U.S. CL. 46).

FIRST USE 11-0-2003; IN COMMERCE 4-0-2004.

CLASS 30—STAPLE FOODS

FOR BISCUITS, CHOCOLATE, CARAMEL, SNACKS, NAMELY, PUFFED CORN SNACKS, CEREAL BASED SNACK FOODS, RICE-BASED SNACK FOODS; CAKE, ICE CREAM, COCOA, HOTCAKE MIX, CANDY, CHEWING GUM, COFFEE, TEA, SUGAR, ARTIFICIAL COFFEE, PREPARED COCOA AND COCOA-BASED BEVERAGES, PREPARED COFFEE AND COFFEE-BASED BEVERAGES, CHOCOLATE FOOD BEVERAGES NOT BEING DAIRY-BASED OR VEGETABLE-BASED, FLOUR, BREAD, CONFECTIONERY, NAMELY, FUDGE CANDY, PRALINE CANDY, CONFECTIONERY CHIPS FOR BAKING, PEPPERMINT FOR CONFECTIONERY; ALMOND CONFECTIONERY, NAMELY, ALMOND FUDGE CANDY, ALMOND FLAVORED CONFECTIONERY CHIPS FOR BAKING; CAKE DOUGH AND PASTES FOR CAKES, NAMELY, CHOCOLATE PASTE, ALMOND PASTE, FRUIT PASTE FOR FLAVORING OF CAKES; CAKE MIXES AND POWDER FOR CAKES, NAMELY, BAKING POWDER, CHOCOLATE POWDER, CINNAMON POWDER; COOKIES, POPCORN, CORN FLAKES, PEANUT CONFECTIONERY, NAMELY, PEANUT BRITTLE, PEANUT BUTTER CONFECTIONERY CHIPS; SUGAR-COATED CONFECTIONERY, NAMELY, SUGAR-COATED HARD CARAMELS, PIES, RUSKS, SHERBET, WAFFLES (U.S. CL. 46).

FIRST USE 11-0-2003; IN COMMERCE 4-0-2004.

3,177,806. CHURCH & DWIGHT COMPANY, GREEN RIVER, WY. SN 78-401,418. PUB. 12-21-2004, FILED 4-14-2004.

ARMAKLEEN

THE MARK CONSISTS OF STANDARD CHARACTERS

WITHOUT CLAIM TO ANY PARTICULAR FONT, STYLE, SIZE, OR COLOR.
OWNER OF U.S. REG. NOS. 1,818,321 AND 2,539,962.

3,177,826. D & LYLA, LLC, NEW YORK, NY. SN 78-411,192.
PUB. 2-8-2005, FILED 4-30-2004.

CLASS 1—CHEMICALS

FOR CHEMICAL PREPARATIONS FOR INDUSTRIAL AND INSTITUTIONAL USE IN THE NATURE OF SOLVENTS, CLEANERS AND DEGREASERS FOR ALL TYPES OF SURFACES (U.S. CLS. 1, 5, 6, 10, 26 AND 46).
FIRST USE 1-1-1997; IN COMMERCE 1-1-1997.

CLASS 3—COSMETICS AND CLEANING PREPARATIONS

FOR ALL-PURPOSE CLEANING PREPARATIONS, HARD SURFACE CLEANING PREPARATIONS, DEGREASING PREPARATIONS AND STRIPPING PREPARATIONS FOR PAINTS AND PAINT-LIKE COATINGS; RUST-REMOVING PREPARATIONS (U.S. CLS. 1, 4, 6, 50, 51 AND 52).
FIRST USE 1-1-2004; IN COMMERCE 1-1-2004.

D & LYLA

THE MARK CONSISTS OF STANDARD CHARACTERS WITHOUT CLAIM TO ANY PARTICULAR FONT, STYLE, SIZE, OR COLOR.

3,177,815. AGEPTIONS, INC., OAK PARK, IL. SN 78-404,804. PUB. 12-13-2005, FILED 4-20-2004.

CLASS 18—LEATHER GOODS

FOR PET HALLOWEEN AND THEATRICAL COSTUMES; PET CLOTHING, NAMELY, JACKETS, PANTS, SHORTS, SHIRTS, VESTS, COATS, CAPES, DRESSES, SKIRTS, BLOUSES, SCARVES, OVERALLS, JUMPERS, ROMPERS, JOGGING SUITS, TIES, T-SHIRTS, BATHING SUITS, SWEAT SUITS, AND SLEEPWEAR; PET HEADGEAR, NAMELY CAPS, HATS, CROWNS, TIARAS AND BOWS; PET FOOT COVERINGS; PET ACCESSORIES, NAMELY, COLLARS, LEASHES, BLANKETS; BAGS; DUFFEL BAGS; PURSES; TOTE BAGS; BAGS FOR CARRYING AND HOLDING PETS; SATCHELS (U.S. CLS. 1, 2, 3, 22 AND 41).
FIRST USE 5-17-2006; IN COMMERCE 5-17-2006.

AGE OPTIONS

THE MARK CONSISTS OF STANDARD CHARACTERS WITHOUT CLAIM TO ANY PARTICULAR FONT, STYLE, SIZE, OR COLOR.

CLASS 20—FURNITURE AND ARTICLES NOT OTHERWISE CLASSIFIED

FOR PET BEDDING, NAMELY, MATTRESSES, PILLOWS AND COVERS; PET FURNITURE, NAMELY, PLAYHOUSES, PLATFORMS, PERCHES, CHAIRS FOR PETS, SOFAS FOR PETS, BUNK BEDS FOR PETS, SOCK DRAWERS FOR PETS; FURNITURE; PET FURNITURE, NAMELY A TABLE THAT INCORPORATES A PET CRATE AND A DECORATIVE CLOTH COVERING (U.S. CLS. 2, 13, 22, 25, 32 AND 50).
FIRST USE 5-17-2006; IN COMMERCE 5-17-2006.

CLASS 36—INSURANCE AND FINANCIAL

FOR SOCIAL SERVICES, IN THE NATURE OF PHILANTHROPIC SERVICES CONCERNING MONETARY DONATIONS, NAMELY PLANNING, COORDINATING AND FUNDING PROGRAMS AND SERVICES FOR THE ELDERLY; PROVIDING GRANTS TO COMMUNITY AGENCIES FOR SERVICES IN THE FIELD OF ELDER CARE (U.S. CLS. 100, 101 AND 102).
FIRST USE 10-1-2004; IN COMMERCE 10-1-2004.

3,177,830. AMERICAN SPINE CENTER, LTD., BELEVILLE, IL. SN 78-415,599. PUB. 5-3-2005, FILED 5-10-2004.

CLASS 43—HOTEL AND RESTAURANT SERVICES

FOR PROVIDING INFORMATION IN THE FIELD OF ELDER CARE (U.S. CLS. 100 AND 101).
FIRST USE 10-1-2004; IN COMMERCE 10-1-2004.

CLINI-LASE

CLASS 45—PERSONAL SERVICES

FOR PROVIDING INFORMATION IN THE FIELD OF PERSONAL CARE ASSISTANCE OF ACTIVITIES OF DAILY LIVING, SUCH AS BATHING, GROOMING, AND PERSONAL MOBILITY FOR THE ELDERLY (U.S. CLS. 100 AND 101).
FIRST USE 10-1-2004; IN COMMERCE 10-1-2004.

THE MARK CONSISTS OF STANDARD CHARACTERS WITHOUT CLAIM TO ANY PARTICULAR FONT, STYLE, SIZE, OR COLOR.

CLASS 10—MEDICAL APPARATUS

FOR LIGHT BASED THERAPY SYSTEMS FOR MEDICAL, DERMATOLOGICAL, DENTAL AND VETERINARY USE, NAMELY, LIGHT EMITTING DIODES AND OTHER LIGHT BASED SYSTEMS, NAMELY, LASERS (U.S. CLS. 26, 39 AND 44).

FIRST USE 1-3-2004; IN COMMERCE 1-3-2004.

3,177,840. VIPS, INC., BALTIMORE, MD. SN 78-423,584. PUB. 11-8-2005, FILED 5-24-2004.

CLASS 44—MEDICAL, BEAUTY AND AGRICULTURAL SERVICES

FOR MEDICAL SERVICES, NAMELY, MYOFASCIAL TRIGGER POINT THERAPY, PAIN RELIEF, BIOSTIMULATION, DENTAL THERAPY, SPORTS INJURY THERAPY, LASER HAIR REMOVAL, SKIN TREATMENTS, AND TATTOO REMOVAL USING LASERS AND OTHER LIGHT-BASED THERAPIES; DENTISTRY SERVICES USING LASERS AND OTHER LIGHT-BASED THERAPIES (U.S. CLS. 100 AND 101).

FIRST USE 1-3-2004; IN COMMERCE 1-3-2004.

PRISMMD

THE MARK CONSISTS OF STANDARD CHARACTERS WITHOUT CLAIM TO ANY PARTICULAR FONT, STYLE, SIZE, OR COLOR.

NO CLAIM IS MADE TO THE EXCLUSIVE RIGHT TO USE MD, APART FROM THE MARK AS SHOWN.

3,177,833. SIMON & SIMON, LLC, WASHINGTON, DC. SN 78-417,325. PUB. 11-8-2005, FILED 5-12-2004.



NO CLAIM IS MADE TO THE EXCLUSIVE RIGHT TO USE MUSIC, APART FROM THE MARK AS SHOWN.

THE COLOR(S) GRAY, BLACK, RED, YELLOW, BLUE, GREEN, PINK AND ORANGE IS/ARE CLAIMED AS A FEATURE OF THE MARK.

THE COLORS GRAY & BLACK APPEAR IN THE CONDUCTOR'S SUIT AND THE SILHOUETTE OF THE ORCHESTRA; THE COLOR RED APPEARS IN THE CONDUCTOR'S BOWTIE; THE COLOR YELLOW APPEARS IN THE BOTTOM BANNER BEHIND THE LITERAL PORTION OF THE MARK; THE COLOR BLUE APPEARS IN THE LEFT, RIGHT AND TOP BORDERS OF THE MARK AND THE WORDS MAGIC MAESTRO MUSIC; THE COLORS GREEN AND ORANGE APPEAR IN THE TOP BORDER AND IN THE STYLIZED LEAVES IN THE MARK; THE CONDUCTOR'S FACE AND HANDS ARE PINK.

CLASS 9—ELECTRICAL AND SCIENTIFIC APPARATUS

FOR MUSICAL SOUND RECORDINGS FOR ADULTS AND CHILDREN (U.S. CLS. 21, 23, 26, 36 AND 38).

FIRST USE 6-15-2004; IN COMMERCE 6-15-2004.

CLASS 41—EDUCATION AND ENTERTAINMENT

FOR ENTERTAINMENT, NAMELY, LIVE MUSIC CONCERTS FOR ADULTS AND CHILDREN (U.S. CLS. 100, 101 AND 107).

FIRST USE 6-15-2004; IN COMMERCE 6-15-2004.

CLASS 9—ELECTRICAL AND SCIENTIFIC APPARATUS

FOR DOWNLOADABLE SOFTWARE FOR USE BY HEALTHCARE INSURANCE PROVIDERS, NAMELY SOFTWARE THAT PROVIDES ON-LINE CARE ALERTS, REPORTS, REMINDERS AND PEER COMPARISONS TO EVALUATE PHYSICIAN PRACTICE PATTERNS AND TO MEASURE PHYSICIAN PERFORMANCE WITH REGARD TO QUALITY AND EFFICIENCY OF CARE MANAGEMENT, DISEASE MANAGEMENT, AND PHARMACY MANAGEMENT, AND USER MANUALS AND GUIDELINES AND ADMINISTRATOR MANUALS AND GUIDELINES DISTRIBUTED IN CONNECTION THEREWITH (U.S. CLS. 21, 23, 26, 36 AND 38).

FIRST USE 12-1-2004; IN COMMERCE 12-1-2004.

CLASS 42—SCIENTIFIC, COMPUTER AND LEGAL SERVICES

FOR PROVIDING TEMPORARY USE OF ON-LINE NON-DOWNLOADABLE SOFTWARE USED BY HEALTHCARE INSURANCE PROVIDERS TO EVALUATE PHYSICIAN PRACTICE PATTERNS AND TO MEASURE PHYSICIAN PERFORMANCE WITH REGARD TO QUALITY AND EFFICIENCY OF CARE MANAGEMENT, DISEASE MANAGEMENT, AND PHARMACY MANAGEMENT (U.S. CLS. 100 AND 101).

FIRST USE 12-1-2004; IN COMMERCE 12-1-2004.

3,177,845. UNIGROUP, INC., FENTON, MO. SN 78-426,279. PUB. 10-18-2005, FILED 5-27-2004.

CITYPOINTE

THE MARK CONSISTS OF STANDARD CHARACTERS

WITHOUT CLAIM TO ANY PARTICULAR FONT, STYLE, SIZE, OR COLOR.

3,177,862. RADIO FORMULA, S.A., MIGUEL HIDALGO D.F., MEXICO. SN 78-436,446. PUB. 11-1-2005, FILED 6-16-2004.

CLASS 35—ADVERTISING AND BUSINESS

FOR PERSONAL RELOCATION SERVICES, BUSINESS RELOCATION SERVICES, AND PROVIDING INFORMATION ON DESTINATION COMMUNITIES (U.S. CLS. 100, 101 AND 102).

FIRST USE 2-1-2004; IN COMMERCE 2-1-2004.

CLASS 36—INSURANCE AND FINANCIAL

FOR PROVIDING INFORMATION REGARDING REAL ESTATE AGENTS (U.S. CLS. 100, 101 AND 102).

FIRST USE 2-1-2004; IN COMMERCE 2-1-2004.

CLASS 39—TRANSPORTATION AND STORAGE

FOR TRANSPORTATION OF GOODS OF OTHERS BY TRUCK AND VAN, FURNITURE MOVING, MOVING VAN SERVICES, AND STORAGE OF GOODS OF OTHERS (U.S. CLS. 100 AND 105).

FIRST USE 2-1-2004; IN COMMERCE 2-1-2004.

3,177,851. NEW NICHE, LLC, STEAMBOAT SPRINGS, CO. SN 78-429,660. PUB. 6-7-2005, FILED 6-3-2004.

Art Studio Company

THE MARK CONSISTS OF STANDARD CHARACTERS WITHOUT CLAIM TO ANY PARTICULAR FONT, STYLE, SIZE, OR COLOR.

NO CLAIM IS MADE TO THE EXCLUSIVE RIGHT TO USE "ART" AND "COMPANY", APART FROM THE MARK AS SHOWN.

CLASS 21—HOUSEWARES AND GLASS

FOR SOUVENIRS, NAMELY, STAINED GLASS (U.S. CLS. 2, 13, 23, 29, 30, 33, 40 AND 50).

FIRST USE 8-1-2004; IN COMMERCE 8-1-2004.

CLASS 28—TOYS AND SPORTING GOODS

FOR SOUVENIRS, NAMELY, CHRISTMAS TREE ORNAMENTS (U.S. CLS. 22, 23, 38 AND 50).

FIRST USE 8-1-2004; IN COMMERCE 8-1-2004.

CLASS 35—ADVERTISING AND BUSINESS

FOR RETAIL STORES AND WHOLESALE DISTRIBUTORSHIPS FEATURING SOUVENIRS (U.S. CLS. 100, 101 AND 102).

FIRST USE 8-1-2004; IN COMMERCE 8-1-2004.

PANDA SHOW

THE MARK CONSISTS OF STANDARD CHARACTERS WITHOUT CLAIM TO ANY PARTICULAR FONT, STYLE, SIZE, OR COLOR.

NO CLAIM IS MADE TO THE EXCLUSIVE RIGHT TO USE "SHOW", APART FROM THE MARK AS SHOWN.

"PANDA" IDENTIFIES A LIVING INDIVIDUAL WHOSE CONSENT IS OF RECORD.

CLASS 38—COMMUNICATION

FOR RADIO TRANSMISSION AND RADIO BROADCASTING SERVICES (U.S. CLS. 100, 101 AND 104).

FIRST USE 10-11-1999; IN COMMERCE 11-20-2004.

CLASS 41—EDUCATION AND ENTERTAINMENT

FOR ENTERTAINMENT SERVICES, NAMELY, PRODUCTION OF RADIO AND TV PROGRAMS (U.S. CLS. 100, 101 AND 107).

FIRST USE 10-11-1999; IN COMMERCE 10-20-2004.

3,177,863. TRADEMARK INTERNATIONAL S.R.L., LUCCA, ITALY. SN 78-436,510. PUB. 11-15-2005, FILED 6-16-2004.



THE NAME SHOWN IN THE MARK DOES NOT IDENTIFY A LIVING INDIVIDUAL.

CLASS 9—ELECTRICAL AND SCIENTIFIC APPARATUS

FOR PROTECTIVE HELMETS FOR MOTORCYCLISTS, BICYCLISTS AND AUTOMOBILE DRIVERS, PROTECTIVE HELMETS FOR USE IN SPORTS, PROTECTIVE HELMET FACE SHIELDS; PROTECTIVE EYEWEAR, NAMELY, EYEGASSES, SUNGLASSES, GOGGLES, EYEGASS FRAMES; PROTECTIVE CLOTHING FOR MOTORCYCLISTS, NAMELY, PROTECTIVE SUITS, PROTECTIVE JACKETS, KNEE PADS, SHOULDER PADS, ELBOW PADS, AND PARTS THEREOF (U.S. CLS. 21, 23, 26, 36 AND 38).

FIRST USE 0-0-2004; IN COMMERCE 0-0-2004.

CLASS 25—CLOTHING

FOR CLOTHING FOR MOTORCYCLISTS, NAMELY, LEATHER SUITS, LEATHER JACKETS, LEATHER TROUSERS, LEATHER VESTS, WARM UP SUITS, SPORT SUITS, JACKETS, T-SHIRTS, SPORT SHIRTS, SWEATERS, TROUSERS, JEANS, PULLOVERS; WEATHER RESISTANT JACKETS, OVERALLS, ANORAKS, AND RAINCOATS; GLOVES; NECKERCHIEFS, NECK BANDS, HEAD BANDS, HATS, CAPS, AND NECK WARMERS; CLOTHING BELTS; SHOES, BOOTS, AND BOOT COVERS (U.S. CLS. 22 AND 39).

FIRST USE 0-0-2004; IN COMMERCE 0-0-2004.

3,177,875. THE LANDRAGINS & COMPANY, LLC, GAINESVILLE, VA. SN 78-441,237. PUB. 10-4-2005, FILED 6-25-2004.

CORK & FORK

THE MARK CONSISTS OF STANDARD CHARACTERS WITHOUT CLAIM TO ANY PARTICULAR FONT, STYLE, SIZE, OR COLOR.

3,177,864. DELLA LUXA, LLC, AUBURNDALE, MA. SN 78-436,885. PUB. 11-22-2005, FILED 6-17-2004.

CLASS 33—WINES AND SPIRITS

FOR WINES (U.S. CLS. 47 AND 49).
FIRST USE 10-4-2005; IN COMMERCE 10-4-2005.

CLASS 35—ADVERTISING AND BUSINESS

FOR RETAIL STORES FEATURING SPECIALTY FOOD AND WINES (U.S. CLS. 100, 101 AND 102).
FIRST USE 10-4-2005; IN COMMERCE 10-4-2005.

DELLA LUXA

3,177,877. UNITED PARCEL SERVICE OF AMERICA, INC., ATLANTA, GA. SN 78-441,693. PUB. 11-15-2005, FILED 6-25-2004.

**QUANTUM VIEW
MANAGE**

THE MARK CONSISTS OF STANDARD CHARACTERS WITHOUT CLAIM TO ANY PARTICULAR FONT, STYLE, SIZE, OR COLOR.

THE NAME(S), PORTRAIT(S), AND/OR SIGNATURE(S) SHOWN IN THE MARK DOES NOT IDENTIFY A PARTICULAR LIVING INDIVIDUAL.

THE ENGLISH TRANSLATION OF THE WORD DELLA IN THE MARK IS "OF THE".

THE MARK CONSISTS OF STANDARD CHARACTERS WITHOUT CLAIM TO ANY PARTICULAR FONT, STYLE, SIZE, OR COLOR.

NO CLAIM IS MADE TO THE EXCLUSIVE RIGHT TO USE "MANAGE", APART FROM THE MARK AS SHOWN.

CLASS 40—MATERIAL TREATMENT

FOR CUSTOM MANUFACTURE OF ORNAMENTAL ITEMS USED FOR DECORATING, NAMELY TASSELS, BRAIDS, FRINGES, TIE BACKS, AND ORNAMENTAL CORDS (U.S. CLS. 100, 103 AND 106).

FIRST USE 2-0-2005; IN COMMERCE 2-0-2006.

CLASS 9—ELECTRICAL AND SCIENTIFIC APPARATUS

FOR COMPUTER SOFTWARE PROVIDING ENHANCED TRACKING INFORMATION ON SINGLE OR MULTIPLE PIECE SHIPMENTS, PACKAGE DETAILS, CURRENT SHIPPING STATUS, E-MAIL STATUS UPDATES, INTERNET BILLING ACCESS, PACKAGE ARRIVAL DATES AND DELIVERY NOTIFICATION (U.S. CLS. 21, 23, 26, 36 AND 38).

FIRST USE 1-1-2004; IN COMMERCE 1-1-2004.

CLASS 42—SCIENTIFIC, COMPUTER AND LEGAL SERVICES

FOR CUSTOM DESIGN OF ORNAMENTAL ITEMS USED FOR DECORATING, NAMELY TASSELS, BRAIDS, FRINGES, TIE BACKS, AND ORNAMENTAL CORDS (U.S. CLS. 100 AND 101).

FIRST USE 2-0-2005; IN COMMERCE 2-0-2006.

CLASS 35—ADVERTISING AND BUSINESS

FOR COMPUTERIZED TRACKING AND TRACING OF PACKAGES IN TRANSIT, NAMELY, PROVIDING COMPUTERIZED INFORMATION ON DOMESTIC AND INTERNATIONAL TRANSPORTATION AND DELIVERY SERVICES (U.S. CLS. 100, 101 AND 102).

FIRST USE 1-1-2004; IN COMMERCE 1-1-2004.

CLASS 39—TRANSPORTATION AND STORAGE

FOR TRANSPORTATION AND DELIVERY OF PERSONAL PROPERTY BY AIR, RAIL, BOAT AND MOTOR VEHICLE (U.S. CLS. 100 AND 105).

FIRST USE 1-1-2004; IN COMMERCE 1-1-2004.

3,177,889. DU BOIS, WENDY, LIVERMORE, CA. SN 78-445,632. PUB. 6-7-2005, FILED 7-2-2004.

WORK IT IN

THE MARK CONSISTS OF STANDARD CHARACTERS WITHOUT CLAIM TO ANY PARTICULAR FONT, STYLE, SIZE, OR COLOR.

CLASS 9—ELECTRICAL AND SCIENTIFIC APPARATUS

FOR RECORDED MEDIA, NAMELY PRE-RECORDED AUDIO TAPES, COMPACT DISCS, VIDEO TAPES, DIGITAL AUDIO AND VIDEO DISCS, AND INTERACTIVE COMPACT DISCS AND SOFTWARE, IN THE FIELD OF FITNESS AND HEALTH, WEIGHT CONTROL, DIETING, NUTRITION, AND EXERCISE (U.S. CLS. 21, 23, 26, 36 AND 38).

FIRST USE 8-21-2006; IN COMMERCE 8-21-2006.

CLASS 16—PAPER GOODS AND PRINTED MATTER

FOR PRINTED MATERIALS, NAMELY BOOKS, PAMPHLETS, COURSE MATERIALS, INSTRUCTIONAL AND TRAINING MATERIALS, MAGAZINES, PERIODICALS, AND NEWSLETTERS, IN THE FIELD OF FITNESS AND HEALTH, WEIGHT CONTROL, DIETING, NUTRITION, AND EXERCISE (U.S. CLS. 2, 5, 22, 23, 29, 37, 38 AND 50).

FIRST USE 8-21-2006; IN COMMERCE 8-21-2006.

3,177,923. CRA INTERNATIONAL, INC., BOSTON, MA. SN 78-459,523. PUB. 12-13-2005, FILED 7-30-2004.

CRA International

THE MARK CONSISTS OF STANDARD CHARACTERS WITHOUT CLAIM TO ANY PARTICULAR FONT, STYLE, SIZE, OR COLOR.

OWNER OF U.S. REG. NOS. 874,860, 1,738,574, AND

OTHERS.

NO CLAIM IS MADE TO THE EXCLUSIVE RIGHT TO USE "INTERNATIONAL", APART FROM THE MARK AS SHOWN.

CLASS 35—ADVERTISING AND BUSINESS

FOR PROVIDING BUSINESS STRATEGY CONSULTING AND PLANNING, PUBLIC POLICY ANALYSIS AND PUBLIC POLICY CONSULTING, AND ECONOMIC AND MARKET ANALYSIS IN VARIOUS FIELDS, NAMELY, ENERGY, UTILITIES AND NATURAL RESOURCES, INDUSTRIAL DEVELOPMENT, AEROSPACE, DEFENSE, REGIONAL AND URBAN ECONOMICS, REGIONAL AND URBAN PLANNING AND DEVELOPMENT, QUANTITATIVE ECONOMICS AND STATISTICS, MANUFACTURING, CONSUMER PRODUCTS, TELECOMMUNICATIONS AND MEDIA, ELECTRONIC, MECHANICAL, MATERIALS, CHEMICAL AND PETROLEUM TECHNOLOGIES, TRANSPORTATION, HEALTHCARE, LEGAL AND ECONOMIC REGULATION BY GOVERNMENTS AND PRIVATE PARTIES, AND THE MARKETING OF GOODS AND SERVICES; BUSINESS MANAGEMENT CONSULTING; CONSULTING REGARDING THE MANAGEMENT OF HEALTHCARE ORGANIZATIONS; PROVIDING BUSINESS APPRAISALS (U.S. CLS. 100, 101 AND 102).

FIRST USE 5-6-2005; IN COMMERCE 5-6-2005.

CLASS 36—INSURANCE AND FINANCIAL

FOR PROVIDING FINANCIAL ANALYSIS AND FINANCIAL FORECASTING IN VARIOUS FIELDS, NAMELY, ENERGY, UTILITIES AND NATURAL RESOURCES, INDUSTRIAL DEVELOPMENT, AEROSPACE, DEFENSE, REGIONAL AND URBAN ECONOMICS, REGIONAL AND URBAN PLANNING AND DEVELOPMENT, QUANTITATIVE ECONOMICS AND STATISTICS, MANUFACTURING, CONSUMER PRODUCTS, TELECOMMUNICATIONS AND MEDIA, ELECTRONIC, MECHANICAL, MATERIALS, CHEMICAL AND PETROLEUM TECHNOLOGIES, TRANSPORTATION, HEALTHCARE, LEGAL AND ECONOMIC REGULATION BY GOVERNMENTS AND PRIVATE PARTIES, AND THE MARKETING OF GOODS AND SERVICES; FINANCIAL VALUATION OF PERSONAL PROPERTY AND REAL ESTATE; AND APPRAISAL OF REAL ESTATE; NONE OF THE FOREGOING SERVICES INCLUDING FINANCIAL INVESTMENT MANAGEMENT, CREDIT MANAGEMENT, CREDIT RISK ADVICE, LOAN SERVICES, ESTATE PLANNING, PERSONAL FINANCIAL PLANNING, OR CONSULTING AND ADVISORY SERVICES RELATED TO ANY OF THESE (U.S. CLS. 100, 101 AND 102).

FIRST USE 5-6-2005; IN COMMERCE 5-6-2005.

CLASS 42—SCIENTIFIC, COMPUTER AND LEGAL SERVICES

FOR PROVIDING LITIGATION SUPPORT, REGULATORY COMPLIANCE CONSULTING, ENGINEERING AND TECHNOLOGY CONSULTING, IN VARIOUS FIELDS, NAMELY, ENERGY, UTILITIES AND NATURAL RESOURCES, INDUSTRIAL DEVELOPMENT, AEROSPACE, DEFENSE, QUANTITATIVE ECONOMICS AND STATISTICS, REGIONAL AND URBAN ECONOMICS, REGIONAL AND URBAN PLANNING AND DEVELOPMENT, MANUFACTURING, CONSUMER PRODUCTS, TELECOMMUNICATIONS AND MEDIA, ELECTRONIC, MECHANICAL, MATERIALS, CHEMICAL AND PETROLEUM TECHNOLOGIES, TRANSPORTATION, HEALTHCARE, LEGAL AND ECONOMIC REGULATION BY GOVERNMENTS AND PRIVATE PARTIES, AND THE MARKETING OF GOODS AND SERVICES; NONE OF THE FOREGOING SERVICES INCLUDING RECYCLING SERVICES, NAMELY THE COLLECTING AND PROCESSING OF METAL AND GLASS CONTAINERS (U.S. CLS. 100 AND 101).

FIRST USE 5-6-2005; IN COMMERCE 5-6-2005.

3,177,935. DAN-DEE INTERNATIONAL, LTD., JERSEY CITY, NJ. SN 78-463,545. PUB. 11-29-2005, FILED 8-6-2004.

3,177,954. LIFE SCAPES INCORPORATED, CHESTER SPRINGS, PA. SN 78-469,221. PUB. 11-1-2005, FILED 8-18-2004.

**YOU GOTTA SQUEEZE
IT TO BELIEVE IT.**

THE MARK CONSISTS OF STANDARD CHARACTERS WITHOUT CLAIM TO ANY PARTICULAR FONT, STYLE, SIZE, OR COLOR.

CLASS 20—FURNITURE AND ARTICLES NOT OTHERWISE CLASSIFIED

FOR PILLOWS (U.S. CLS. 2, 13, 22, 25, 32 AND 50).
FIRST USE 1-21-2005; IN COMMERCE 1-21-2005.

CLASS 28—TOYS AND SPORTING GOODS

FOR TOY ANIMALS AND DOLLS (U.S. CLS. 22, 23, 38 AND 50).
FIRST USE 11-15-2004; IN COMMERCE 11-15-2004.

3,177,940. HNTB CORPORATION, KANSAS CITY, MO. SN 78-464,040. PUB. 12-13-2005, FILED 8-9-2004.



CLASS 38—COMMUNICATION

FOR ELECTRONIC TRANSMISSION OF MESSAGES FEATURING REAL-TIME TRAFFIC AND TRAVELER INFORMATION AND ALERTS (U.S. CLS. 100, 101 AND 104).
FIRST USE 6-21-2004; IN COMMERCE 9-28-2004.

CLASS 39—TRANSPORTATION AND STORAGE

FOR TRAFFIC AND TRAVELER INFORMATION SERVICES; PROVIDING REAL-TIME TRAFFIC AND TRAVELER INFORMATION; PROVIDING REAL-TIME TRAFFIC AND TRAVELER INFORMATION AND ALERTS VIA ELECTRONIC MESSAGES; PROVIDING REAL-TIME TRAFFIC AND TRAVELER INFORMATION, ALERTS AND ADVISORIES TO COMMUTERS AND TRAVELERS VIA WIRED AND WIRELESS TELECOMMUNICATIONS NETWORKS, INCLUDING THE INTERNET, CELL PHONES, PDAS, PAGERS, TEXT MESSAGING DEVICES AND HANDHELD AND IN-VEHICLE NAVIGATION SYSTEMS (U.S. CLS. 100 AND 105).
FIRST USE 6-21-2004; IN COMMERCE 9-28-2004.

INSPIRING VISTAS...INSPIRING HEALTH...

THE MARK CONSISTS OF STANDARD CHARACTERS WITHOUT CLAIM TO ANY PARTICULAR FONT, STYLE, SIZE, OR COLOR.

CLASS 16—PAPER GOODS AND PRINTED MATTER

FOR NEWSLETTERS IN THE FIELD OF HEALTH CARE AND HEALTHY LIFE STYLE INFORMATION FEATURING INFORMATION ON PRESCRIPTION AND OVER-THE-COUNTER DRUGS, TRADITIONAL AND HOMEOPATHIC TREATMENT OF HEALTH CONDITIONS, AND VETERINARY INFORMATION, PROVIDED TO PHYSICIANS, VETERINARIANS, HEALTH PROFESSIONALS, HOMEOPATHIC PRACTITIONERS AND CONSUMERS (U.S. CLS. 2, 5, 22, 23, 29, 37, 38 AND 50).
FIRST USE 12-31-2003; IN COMMERCE 12-31-2003.

CLASS 41—EDUCATION AND ENTERTAINMENT

FOR PROVIDING ON-LINE NEWSLETTERS IN THE FIELD OF HEALTHCARE AND HEALTHY LIFE STYLE FEATURING INFORMATION ON PRESCRIPTION AND OVER-THE-COUNTER DRUGS, TRADITIONAL AND HOMEOPATHIC TREATMENT OF HEALTH CONDITIONS, AND VETERINARY INFORMATION TO PHYSICIANS, VETERINARIANS, HEALTH PROFESSIONALS, HOMEOPATHIC PRACTITIONERS AND CONSUMERS VIA A GLOBAL COMPUTER NETWORK (U.S. CLS. 100, 101 AND 107).
FIRST USE 12-31-2003; IN COMMERCE 12-31-2003.

CLASS 44—MEDICAL, BEAUTY AND AGRICULTURAL SERVICES

FOR PROVIDING A WEBSITE IN THE FIELD OF HEALTH CARE AND HEALTHY LIFE STYLE FEATURING INFORMATION ON PRESCRIPTION AND OVER-THE-COUNTER DRUGS, TRADITIONAL AND HOMEOPATHIC TREATMENT OF HEALTH CONDITIONS, AND VETERINARY INFORMATION TO PHYSICIANS, VETERINARIANS, HEALTH PROFESSIONALS, HOMEOPATHIC PRACTITIONERS AND CONSUMERS VIA A GLOBAL COMPUTER NETWORK AND PROVIDING LINKS TO THE WEBSITES OF OTHERS CONTAINING SIMILAR SUBJECT MATTER (U.S. CLS. 100 AND 101).
FIRST USE 12-31-2003; IN COMMERCE 12-31-2003.

3,177,965. BELL SPORTS, INC., IRVING, TX. SN 78-470,477. PUB. 12-13-2005, FILED 8-19-2004.

3,177,979. HELLENIC INTERACTIVE, INC., ELMWOOD PARK, IL. SN 78-475,455. PUB. 12-13-2005, FILED 8-30-2004.



THE MARK CONSISTS OF A HEXAGON WITH HOLE IN CENTER AND ONE SIDE OPENED.

CLASS 12—VEHICLES

FOR BICYCLE ACCESSORIES, NAMELY FLOOR PUMPS, FRAME PUMPS, MINI-PUMPS, BICYCLE RACKS FOR VEHICLES, REARVIEW MIRRORS, WATER BOTTLE CAGES AND BICYCLE TOOL KITS (U.S. CLS. 19, 21, 23, 31, 35 AND 44).

FIRST USE 7-0-2004; IN COMMERCE 8-0-2004.

CLASS 28—TOYS AND SPORTING GOODS

FOR STATIONARY EXERCISE BICYCLE TRAINERS (U.S. CLS. 22, 23, 38 AND 50).

FIRST USE 7-0-2004; IN COMMERCE 8-0-2004.

3,177,976. G2 SWITCHWORKS CORP., CHICAGO, IL. SN 78-474,224. PUB. 12-13-2005, FILED 8-26-2004.

G2 SWITCHWORKS

THE MARK CONSISTS OF STANDARD CHARACTERS WITHOUT CLAIM TO ANY PARTICULAR FONT, STYLE, SIZE, OR COLOR.

CLASS 39—TRANSPORTATION AND STORAGE

FOR TRAVEL SERVICES, NAMELY, TRANSPORTATION RESERVATION AND TICKETING SERVICES AND THE PROVISION OF RELATED TRAVEL AND RESERVATION INFORMATION (U.S. CLS. 100 AND 105).

FIRST USE 8-0-2005; IN COMMERCE 8-0-2005.

CLASS 43—HOTEL AND RESTAURANT SERVICES

FOR TRAVEL SERVICES, NAMELY, LODGING RESERVATION AND TICKETING SERVICES AND THE PROVISION OF RELATED TRAVEL AND RESERVATION INFORMATION (U.S. CLS. 100 AND 101).

FIRST USE 8-0-2005; IN COMMERCE 8-0-2005.

BEAT BOX

THE MARK CONSISTS OF STANDARD CHARACTERS WITHOUT CLAIM TO ANY PARTICULAR FONT, STYLE, SIZE, OR COLOR.

CLASS 9—ELECTRICAL AND SCIENTIFIC APPARATUS

FOR COMPUTER SOFTWARE FOR SEARCHING AND RETRIEVING INFORMATION, SITES AND OTHER RESOURCES ON COMPUTER NETWORKS; COMPUTER SOFTWARE FOR SENDING STREAMING MEDIA OVER A COMPUTER NETWORK; DIGITAL JUKE BOX INCLUDING COMPUTER HARDWARE AND SOFTWARE FOR DISTRIBUTING, SELECTING AND PLAYING AUDIO AND VIDEO MUSICAL INFORMATION; PRE-RECORDED MUSICAL SOUND RECORDINGS (U.S. CLS. 21, 23, 26, 36 AND 38).

FIRST USE 9-1-2006; IN COMMERCE 9-1-2006.

CLASS 35—ADVERTISING AND BUSINESS

FOR PROVIDING ONLINE RETAIL STORE SERVICES FEATURING ELECTRONICS AND ENTERTAINMENT RELATED PRODUCTS, NAMELY COMPACT DISCS, FEATURING MUSIC AND DIGITALLY DOWNLOADABLE MUSIC (U.S. CLS. 100, 101 AND 102).

FIRST USE 9-1-2006; IN COMMERCE 9-1-2006.

CLASS 38—COMMUNICATION

FOR TELECOMMUNICATIONS SERVICES, NAMELY, PROVIDING TELEPHONE COMMUNICATION SERVICES VIA COMPUTER NETWORKS; ELECTRONIC TRANSMISSION OF DATA, IMAGES, AND DOCUMENTS VIA COMPUTER TERMINALS AND NETWORKS; BROADCASTING SERVICES, NAMELY RADIO BROADCASTING; ELECTRONIC MAIL SERVICES; PROVIDING MULTIPLE-USER ACCESS TO A COMPUTER INFORMATION NETWORK; PROVIDING ON-LINE ELECTRONIC BULLETIN BOARDS FOR TRANSMISSION OF MESSAGES AMONG COMPUTER USERS CONCERNING ENTERTAINMENT AND OTHER NEWS ITEMS; AND PROVIDING ON-LINE CHAT ROOMS FOR TRANSMISSION OF MESSAGES AMONG COMPUTER USERS CONCERNING PLAYING GAMES (U.S. CLS. 100, 101 AND 104).

FIRST USE 9-1-2006; IN COMMERCE 9-1-2006.

CLASS 41—EDUCATION AND ENTERTAINMENT

FOR ENTERTAINMENT SERVICES, NAMELY PROVIDING A RADIO PROGRAM IN THE FIELDS OF MUSIC, NEWS, WEATHER, SPORTS AND CURRENT EVENTS VIA A GLOBAL COMPUTER NETWORK; PROVIDING ENTERTAINMENT INFORMATION IN THE FIELD OF MUSIC, STREAMING MEDIA, AND AUDIO AND DIGITAL TECHNOLOGY AT OTHER WEBSITES BY MEANS OF HYPERLINKS (U.S. CLS. 100, 101 AND 107).

FIRST USE 9-1-2006; IN COMMERCE 9-1-2006.

CLASS 42—SCIENTIFIC, COMPUTER AND LEGAL SERVICES

FOR COMPUTER SERVICES, NAMELY, PROVIDING SEARCH ENGINES FOR OBTAINING DATA, NAMELY, VARIOUS NEWS, RADIO, VIDEO AND OTHER SOURCES AVAILABLE ON A GLOBAL COMPUTER NETWORK; COMPUTER SERVICES, NAMELY, DESIGNING, CREATING, AND MAINTAINING WEB SITES FOR OTHERS; HOSTING THE WEBSITES OF OTHERS ON A COMPUTER SERVER FOR A GLOBAL COMPUTER NETWORK; TECHNICAL CONSULTATION SERVICES IN THE FIELD OF DESIGNING, CREATING AND MAINTAINING THE WEB SITES OF OTHERS; TECHNICAL CONSULTATION SERVICES IN THE FIELD OF HOSTING THE WEB SITES OF OTHERS TO HELP OTHERS DEVELOP AND MAINTAIN A WEB SITE (U.S. CLS. 100 AND 101).

FIRST USE 9-1-2006; IN COMMERCE 9-1-2006.

3,177,996. INTERNATIONAL BUSINESS MACHINES CORPORATION, ARMONK, NY. SN 78-480,608. PUB. 12-20-2005, FILED 9-8-2004.

SEVEN KEYS TO SUCCESS

THE MARK CONSISTS OF STANDARD CHARACTERS WITHOUT CLAIM TO ANY PARTICULAR FONT, STYLE, SIZE, OR COLOR.

3,177,994. PADCO ADVISORS, INC., ROCKVILLE, MD. SN 78-480,162. PUB. 12-13-2005, FILED 9-8-2004.

ESSENTIAL FRONTIER

THE MARK CONSISTS OF STANDARD CHARACTERS WITHOUT CLAIM TO ANY PARTICULAR FONT, STYLE, SIZE, OR COLOR.

CLASS 16—PAPER GOODS AND PRINTED MATTER

FOR FINANCIAL EDUCATIONAL MATERIALS, NAMELY, BOOKS, BROCHURES, AND PAMPHLETS FOR FINANCIAL PROFESSIONALS (U.S. CLS. 2, 5, 22, 23, 29, 37, 38 AND 50).

FIRST USE 5-0-2006; IN COMMERCE 5-0-2006.

CLASS 36—INSURANCE AND FINANCIAL

FOR FINANCIAL MANAGEMENT SERVICES, NAMELY, ASSISTING OTHERS WITH BUILDING FINANCIAL PORTFOLIOS AND PROVIDING AN ONLINE FINANCIAL CALCULATOR ON A GLOBAL NETWORK FOR PORTFOLIO ANALYSIS AND RISK ASSESSMENT IN THE FIELD OF INVESTMENTS (U.S. CLS. 100, 101 AND 102).

FIRST USE 5-0-2006; IN COMMERCE 5-0-2006.

CLASS 16—PAPER GOODS AND PRINTED MATTER

FOR PRINTED NON-FICTION PUBLICATIONS, NAMELY, MANUALS, BROCHURES, AND TRAINING MATERIALS FEATURING INFORMATION ON THE IMPLEMENTATION OF A SPECIFIC METHODOLOGY OF PROBLEM SOLVING, MEASURING OF TARGETS AND GOALS, AND EVALUATION OF COMPLIANCE AND COMPLETION, FOR USE IN PROJECT MANAGEMENT, STRATEGIC CONSULTING, BUSINESS PROCESS IMPROVEMENT CONSULTING, AND INFORMATION TECHNOLOGY CONSULTING (U.S. CLS. 2, 5, 22, 23, 29, 37, 38 AND 50).

FIRST USE 5-22-2000; IN COMMERCE 5-22-2000.

CLASS 35—ADVERTISING AND BUSINESS

FOR BUSINESS CONSULTING AND INFORMATION SERVICES; BUSINESS MANAGEMENT CONSULTING SERVICES, NAMELY, THE IMPLEMENTATION OF A SPECIFIC METHODOLOGY OF PROBLEM SOLVING, MEASURING OF TARGETS AND GOALS, AND EVALUATION OF COMPLIANCE AND COMPLETION, FOR USE IN PROJECT MANAGEMENT, STRATEGIC CONSULTING, BUSINESS PROCESS IMPROVEMENT CONSULTING, AND INFORMATION TECHNOLOGY CONSULTING (U.S. CLS. 100, 101 AND 102).

FIRST USE 5-0-2000; IN COMMERCE 5-22-2000.

CLASS 41—EDUCATION AND ENTERTAINMENT

FOR EDUCATIONAL SERVICES, NAMELY PROVIDING CLASSES, SEMINARS AND WORKSHOPS IN THE FIELD OF IMPLEMENTING A SPECIFIC METHODOLOGY OF PROBLEM SOLVING, MEASURING OF TARGETS AND GOALS, AND EVALUATION OF COMPLIANCE AND COMPLETION, FOR USE IN PROJECT MANAGEMENT, STRATEGIC CONSULTING, BUSINESS PROCESS IMPROVEMENT CONSULTING, AND INFORMATION TECHNOLOGY CONSULTING (U.S. CLS. 100, 101 AND 107).

FIRST USE 5-22-2000; IN COMMERCE 5-22-2000.

3,178,002. BODEK & RHODES, PHILADELPHIA, PA. SN 78-485,846. PUB. 12-27-2005, FILED 9-18-2004.

CLASS 31—NATURAL AGRICULTURAL PRODUCTS

FOR ANIMAL FEED (U.S. CLS. 1 AND 46).
FIRST USE 4-1-2005; IN COMMERCE 4-1-2005.

ULTRACLUB

THE MARK CONSISTS OF STANDARD CHARACTERS WITHOUT CLAIM TO ANY PARTICULAR FONT, STYLE, SIZE, OR COLOR.

OWNER OF U.S. REG. NOS. 1,855,275, 2,021,043, AND OTHERS.

CLASS 24—FABRICS

FOR FLEECE BLANKETS (U.S. CLS. 42 AND 50).
FIRST USE 1-1-2005; IN COMMERCE 1-1-2005.

CLASS 25—CLOTHING

FOR CLOTHING NAMELY; SHIRTS; FLEECE SHIRTS, COLLARED SHIRTS, BUTTON DOWN SHIRTS, DRESS SHIRTS, DENIM SHIRTS, MESH MOISTURE ABSORBING SHIRTS, OXFORD SHIRTS, WIND SHIRTS, CREW NECK SHIRTS, STAIN RESISTANT SHIRTS, T-SHIRTS, CARDIGANS, JACKETS; WIND JACKETS, PULLOVER WIND JACKETS, PACKAWAY JACKETS, PACKAWAY PULLOVER JACKETS, GOLF JACKETS, ZIP-OUT LINING JACKETS, FLEECE JACKETS, FLEECE LINED JACKETS, ALL-WEATHER JACKETS, REVERSIBLE JACKETS, VESTS; WIND VESTS, FLEECE VESTS, CAPS, WINTER HATS, FLEECE SCARVES AND FLEECE HEADBANDS (U.S. CLS. 22 AND 39).

FIRST USE 1-1-2005; IN COMMERCE 1-1-2005.

3,178,009. THE FANFARE GROUP, INC., MOUNTAIN VIEW, CA. SN 78-489,112. PUB. 12-27-2005, FILED 9-24-2004.



THE MARK CONSISTS OF A STYLIZED LETTER F.

3,178,003. FARNAM COMPANIES, INC., PHOENIX, AZ. SN 78-486,096. PUB. 11-22-2005, FILED 9-20-2004.

Platform

THE MARK CONSISTS OF STANDARD CHARACTERS WITHOUT CLAIM TO ANY PARTICULAR FONT, STYLE, SIZE, OR COLOR.

CLASS 5—PHARMACEUTICALS

FOR DIETARY AND/OR NUTRITIONAL SUPPLEMENTS (U.S. CLS. 6, 18, 44, 46, 51 AND 52).
FIRST USE 4-1-2005; IN COMMERCE 4-1-2005.

CLASS 9—ELECTRICAL AND SCIENTIFIC APPARATUS

FOR COMPUTER SOFTWARE FOR SYSTEMS VERIFICATION TESTING; COMPUTER SOFTWARE FOR TESTING AND ANALYZING THE PERFORMANCE AND INTEGRITY OF PRODUCT FEATURES IN THE FIELD OF PRODUCT AND/OR SYSTEMS DESIGN, THE FIELD OF PRODUCT QUALITY ASSURANCE, AND THE FIELD OF PRODUCT AND/OR SYSTEMS TESTING; COMPUTER SOFTWARE FOR PRODUCT AND/OR SYSTEM DESIGN MODELING AND TESTING; COMPUTER SOFTWARE FOR USE IN PRODUCT AND/OR SYSTEM TEST PLANNING, TEST CASE DESIGN, TEST EXECUTION, TEST AUTOMATION, DEFECT ANALYSIS AND DOCUMENTATION, AND TEST RESULT TRACKING AND REPORTING (U.S. CLS. 21, 23, 26, 36 AND 38).
FIRST USE 7-31-2005; IN COMMERCE 2-16-2006.

CLASS 42—SCIENTIFIC, COMPUTER AND LEGAL SERVICES

FOR COMPUTER CONSULTATION SERVICES IN THE FIELD OF QUALITY ASSURANCE AND SYSTEMS VERIFICATION TESTING; COMPUTER SUPPORT SERVICES, NAMELY, PROVISION OF TECHNICAL ASSISTANCE AND TECHNICAL SUPPORT (U.S. CLS. 100 AND 101).
FIRST USE 7-31-2005; IN COMMERCE 8-28-2006.

3,178,011. THE FANFARE GROUP, INC., MOUNTAIN VIEW, CA. SN 78-489,127. PUB. 12-27-2005, FILED 9-24-2004.

THE FANFARE GROUP

THE MARK CONSISTS OF STANDARD CHARACTERS WITHOUT CLAIM TO ANY PARTICULAR FONT, STYLE, SIZE, OR COLOR.

NO CLAIM IS MADE TO THE EXCLUSIVE RIGHT TO USE "GROUP", APART FROM THE MARK AS SHOWN.

CLASS 9—ELECTRICAL AND SCIENTIFIC APPARATUS

FOR COMPUTER SOFTWARE FOR SYSTEMS VERIFICATION TESTING; COMPUTER SOFTWARE FOR TESTING AND ANALYZING THE PERFORMANCE AND INTEGRITY OF PRODUCT FEATURES IN THE FIELD OF PRODUCT AND/OR SYSTEMS DESIGN, THE FIELD OF PRODUCT QUALITY ASSURANCE, AND THE FIELD OF PRODUCT AND/OR SYSTEMS TESTING; COMPUTER SOFTWARE FOR PRODUCT AND/OR SYSTEM DESIGN MODELING AND TESTING; COMPUTER SOFTWARE FOR USE IN PRODUCT AND/OR SYSTEM TEST PLANNING, TEST CASE DESIGN, TEST EXECUTION, TEST AUTOMATION, DEFECT ANALYSIS AND DOCUMENTATION, AND TEST RESULT TRACKING AND REPORTING (U.S. CLS. 21, 23, 26, 36 AND 38).
FIRST USE 7-31-2005; IN COMMERCE 2-16-2006.

CLASS 42—SCIENTIFIC, COMPUTER AND LEGAL SERVICES

FOR COMPUTER CONSULTATION SERVICES IN THE FIELD OF QUALITY ASSURANCE AND SYSTEMS VERIFICATION TESTING; COMPUTER SUPPORT SERVICES, NAMELY, PROVISION OF TECHNICAL ASSISTANCE AND TECHNICAL SUPPORT (U.S. CLS. 100 AND 101).
FIRST USE 7-31-2005; IN COMMERCE 8-28-2006.

3,178,045. STEARNS, GLENN, SANTA ANA, CA. SN 78-505,316. PUB. 5-2-2006, FILED 10-25-2004.



CLASS 35—ADVERTISING AND BUSINESS

FOR BUSINESS MANAGEMENT CONSULTATION IN THE FIELD OF GOVERNMENT CONTRACTING; AND BUSINESS AUDITING (U.S. CLS. 100, 101 AND 102).
FIRST USE 12-1-2004; IN COMMERCE 12-1-2004.

CLASS 36—INSURANCE AND FINANCIAL

FOR MORTGAGE BROKERAGE AND MORTGAGE PROCUREMENT FOR OTHERS (U.S. CLS. 100, 101 AND 102).
FIRST USE 12-1-2004; IN COMMERCE 12-1-2004.

CLASS 42—SCIENTIFIC, COMPUTER AND LEGAL SERVICES

FOR REAL ESTATE SETTLEMENT SERVICES (U.S. CLS. 100 AND 101).
FIRST USE 12-1-2004; IN COMMERCE 12-1-2004.

3,178,058. THINKING TECHNOLOGY INC., NASSAU, BAHAMAS. SN 78-511,573. PUB. 1-24-2006, FILED 11-4-2004.

INTERACTIVE M.A.G. MOTION ACTIVATED GEAR

THE MARK CONSISTS OF STANDARD CHARACTERS WITHOUT CLAIM TO ANY PARTICULAR FONT, STYLE, SIZE, OR COLOR.

NO CLAIM IS MADE TO THE EXCLUSIVE RIGHT TO USE INTERACTIVE AND MOTION ACTIVATED GEAR, APART FROM THE MARK AS SHOWN.

CLASS 9—ELECTRICAL AND SCIENTIFIC APPARATUS

FOR VIDEO GAME CARTRIDGES, VIDEO GAME CD ROMS; GAMING GEAR AND ACCESSORIES, NAMELY, WIRELESS ACCESSORIES WORN ON THE BODY NAMELY, GLOVES, MITTS, WRIST PADS, CUFFS, BELTS, WATCHES, RINGS, NECKLACES, PADS, HATS, HELMETS, HEADBANDS, SHIELDS, CHEST PLATES, VESTS, EYEGLASSES, SHOES, COVERINGS FOR SHOES, PINS AND CLIP-ON PINS, USING INFRARED OR RADIO TECHNOLOGY FOR INTERACTION WITH VIDEO GAME MACHINES FOR USE WITH TELEVISIONS AND COMPUTERS; VIRTUAL REALITY SYSTEMS COMPRISING VIDEO GAME MACHINES, VIDEO GAME CARTRIDGES, VIDEO GAMES, CD ROMS, ALL FOR USE WITH TELEVISION SETS AND COMPUTERS (U.S. CLS. 21, 23, 26, 36 AND 38).
FIRST USE 6-14-2006; IN COMMERCE 6-14-2006.

CLASS 28—TOYS AND SPORTING GOODS

FOR TOYS, GAMES AND PLAYTHINGS, NAMELY PORTABLE STAND-ALONE VIDEO GAME MACHINES; GAMING SYSTEMS COMPRISING STAND-ALONE VIDEO OUTPUT GAME MACHINES; STAND-ALONE GAMING GEAR AND ACCESSORIES, NAMELY, WIRELESS ACCESSORIES WORN ON THE BODY NAMELY, GLOVES, MITTS, WRIST PADS, CUFFS, BELTS, WATCHES, RINGS, NECKLACES, PADS, HATS, HELMETS, HEADBANDS, SHIELDS, CHEST PLATES, VESTS, EYEGLASSES, SHOES, COVERINGS FOR SHOES, PINS AND CLIP-ON PINS, USING INFRARED OR RADIO TECHNOLOGY FOR INTERACTION WITH VIDEO GAME MACHINES; VIRTUAL REALITY SYSTEMS COMPRISING PORTABLE STAND-ALONE VIDEO GAME MACHINES, VIDEO GAME CARTRIDGES, VIDEO GAMES, CD ROMS, SOLD AS A UNIT (U.S. CLS. 22, 23, 38 AND 50).

FIRST USE 6-14-2006; IN COMMERCE 6-14-2006.

3,178,062. UNITED NATIONS ASSOCIATION OF THE UNITED STATES OF AMERICA, INC., NEW YORK, NY. SN 78-513,531. PUB. 12-27-2005, FILED 11-9-2004.



NO CLAIM IS MADE TO THE EXCLUSIVE RIGHT TO USE "CAMPAIGN", APART FROM THE MARK AS SHOWN.

THE COLOR(S) MAROON, GOLD, PURPLE, GREEN AND BLUE IS/ARE CLAIMED AS A FEATURE OF THE MARK.

THE MARK CONSISTS OF THE WORD "HERO", WITH THE LETTER "H" IN MAROON, THE LETTER "E" IN GOLD, THE LETTER "R" IN PURPLE, THE LETTER "O" IN GREEN, EACH LETTER INCLUDING A WHITE SILHOUETTE OF A CHILD'S HEAD, AND THE WORDS "A UNA-USA CAMPAIGN" IN BLUE.

CLASS 35—ADVERTISING AND BUSINESS

FOR PROMOTING PUBLIC AWARENESS OF AIDS ORPHANED AND VULNERABLE CHILDREN AND THEIR PLIGHT (U.S. CLS. 100, 101 AND 102).

FIRST USE 9-0-2004; IN COMMERCE 5-0-2006.

CLASS 36—INSURANCE AND FINANCIAL

FOR CHARITABLE FUND RAISING SERVICES FOR AIDS ORPHANED AND VULNERABLE CHILDREN (U.S. CLS. 100, 101 AND 102).

FIRST USE 9-0-2004; IN COMMERCE 5-0-2006.

3,178,066. ACCSYS, INC., TAMPA, FL. SN 78-514,305. PUB. 11-1-2005, FILED 11-10-2004.

DATA.CENTRAL

THE MARK CONSISTS OF STANDARD CHARACTERS

WITHOUT CLAIM TO ANY PARTICULAR FONT, STYLE, SIZE, OR COLOR.

CLASS 9—ELECTRICAL AND SCIENTIFIC APPARATUS

FOR COMPUTER SOFTWARE FOR MANAGING SINGLE AND MULTI-LOCATION BUSINESS ACTIVITY, NAMELY, THE MANAGEMENT AND CONTROL OF DOCUMENTS, INVENTORY, AND LABOR VIA A CENTRALIZED DATA MANAGEMENT MODEL (U.S. CLS. 21, 23, 26, 36 AND 38).

FIRST USE 10-24-2005; IN COMMERCE 10-24-2005.

CLASS 42—SCIENTIFIC, COMPUTER AND LEGAL SERVICES

FOR APPLICATION SERVICE PROVIDER (ASP) FEATURING COMPUTER SOFTWARE FOR MANAGING SINGLE AND MULTI-LOCATION BUSINESS ACTIVITY, NAMELY, THE MANAGEMENT AND CONTROL OF DOCUMENTS, INVENTORY, AND LABOR VIA A CENTRALIZED DATA MANAGEMENT MODEL (U.S. CLS. 100 AND 101).

FIRST USE 10-24-2005; IN COMMERCE 10-24-2005.

3,178,097. THE PROCTER & GAMBLE COMPANY, CINCINNATI, OH. SN 78-531,229. PUB. 6-28-2005, FILED 12-13-2004.

**FEBREZE
NOTICEABLES**

THE MARK CONSISTS OF STANDARD CHARACTERS WITHOUT CLAIM TO ANY PARTICULAR FONT, STYLE, SIZE, OR COLOR.

OWNER OF U.S. REG. NOS. 2,107,914, 2,924,317, AND OTHERS.

CLASS 3—COSMETICS AND CLEANING PREPARATIONS

FOR AROMATHERAPY PRODUCTS, NAMELY, AROMATHERAPY OILS USED IN ELECTRICAL SCENT DISPENSERS (U.S. CLS. 1, 4, 6, 50, 51 AND 52).

FIRST USE 1-23-2006; IN COMMERCE 1-23-2006.

CLASS 5—PHARMACEUTICALS

FOR ROOM DEODORIZERS AND AIR FRESHENERS (U.S. CLS. 6, 18, 44, 46, 51 AND 52).

FIRST USE 1-23-2006; IN COMMERCE 1-23-2006.

CLASS 11—ENVIRONMENTAL CONTROL APPARATUS

FOR ELECTRICAL SCENT DISPENSERS (U.S. CLS. 13, 21, 23, 31 AND 34).

FIRST USE 1-23-2006; IN COMMERCE 1-23-2006.

3,178,098. THE PROCTER & GAMBLE COMPANY, CINCINNATI, OH. SN 78-531,233. PUB. 6-28-2005, FILED 12-13-2004.

NOTICEABLES

THE MARK CONSISTS OF STANDARD CHARACTERS WITHOUT CLAIM TO ANY PARTICULAR FONT, STYLE, SIZE, OR COLOR.

CLASS 3—COSMETICS AND CLEANING PREPARATIONS

FOR AROMATHERAPY PRODUCTS, NAMELY, AROMATHERAPY OILS USED IN ELECTRICAL SCENT DISPENSERS (U.S. CLS. 1, 4, 6, 50, 51 AND 52).
FIRST USE 1-23-2006; IN COMMERCE 1-23-2006.

CLASS 5—PHARMACEUTICALS

FOR ROOM DEODORIZERS AND AIR FRESHENERS (U.S. CLS. 6, 18, 44, 46, 51 AND 52).
FIRST USE 1-23-2006; IN COMMERCE 1-23-2006.

CLASS 11—ENVIRONMENTAL CONTROL APPARATUS

FOR ELECTRICAL SCENT DISPENSERS (U.S. CLS. 13, 21, 23, 31 AND 34).
FIRST USE 1-23-2006; IN COMMERCE 1-23-2006.

3,178,104. CAREPLANET, INC., HONOLULU, HI. SN 78-534,146. PUB. 9-6-2005, FILED 12-16-2004.

CarePlanet

THE MARK CONSISTS OF STANDARD CHARACTERS WITHOUT CLAIM TO ANY PARTICULAR FONT, STYLE, SIZE, OR COLOR.

CLASS 9—ELECTRICAL AND SCIENTIFIC APPARATUS

FOR COMPUTER SOFTWARE FOR USE IN HOME HEALTH ORGANIZATION MANAGEMENT AND FOR RECORD AND TIME KEEPING MANAGEMENT SERVICES FOR HOME HEALTHCARE (U.S. CLS. 21, 23, 26, 36 AND 38).
FIRST USE 11-20-2005; IN COMMERCE 11-20-2005.

CLASS 35—ADVERTISING AND BUSINESS

FOR CONSULTING SERVICES IN THE FIELDS OF HEALTHCARE MANAGEMENT AND RECORD AND TIME KEEPING MANAGEMENT SERVICES FOR HOME HEALTHCARE (U.S. CLS. 100, 101 AND 102).
FIRST USE 11-20-2005; IN COMMERCE 11-20-2005.

3,178,111. SIGMA-ALDRICH BIOTECHNOLOGY L.P., ST. LOUIS, MO. SN 78-536,462. PUB. 3-14-2006, FILED 12-21-2004.

INSPIRING SCIENCE

THE MARK CONSISTS OF STANDARD CHARACTERS WITHOUT CLAIM TO ANY PARTICULAR FONT, STYLE, SIZE, OR COLOR.

NO CLAIM IS MADE TO THE EXCLUSIVE RIGHT TO USE SCIENCE, APART FROM THE MARK AS SHOWN.

CLASS 1—CHEMICALS

FOR FULL LINE OF CHEMICALS FOR MANUFACTURING, RESEARCH AND SCIENTIFIC USE; A FULL LINE OF CHEMICAL COMPOUNDS FOR USE IN PHARMACEUTICAL PREPARATIONS (U.S. CLS. 1, 5, 6, 10, 26 AND 46).
FIRST USE 9-28-2004; IN COMMERCE 9-28-2004.

CLASS 40—MATERIAL TREATMENT

FOR CUSTOM MANUFACTURING FOR OTHERS OF CHEMICALS FOR USE IN MANUFACTURE, RESEARCH AND SCIENCE; CUSTOM MANUFACTURE FOR OTHERS OF COMPOUNDS FOR USE IN PHARMACEUTICALS (U.S. CLS. 100, 103 AND 106).
FIRST USE 9-28-2004; IN COMMERCE 9-28-2004.

CLASS 42—SCIENTIFIC, COMPUTER AND LEGAL SERVICES

FOR CHEMICAL AND SCIENTIFIC RESEARCH FOR OTHERS; DEVELOPMENT FOR OTHERS OF CHEMICALS, COMPOUNDS AND INGREDIENTS FOR USE IN MANUFACTURE, PHARMACEUTICALS, RESEARCH AND FOR SCIENTIFIC PURPOSES (U.S. CLS. 100 AND 101).
FIRST USE 9-28-2004; IN COMMERCE 9-28-2004.

3,178,117. HAND HELD PRODUCTS, INC., SKANEATELES FALLS, NY. SN 78-539,431. PUB. 1-31-2006, FILED 12-29-2004.



CLASS 42—SCIENTIFIC, COMPUTER AND LEGAL SERVICES

FOR DESIGNING DATA COLLECTION DEVICES FOR OTHERS; COMPUTER SERVICES FOR OTHERS IN THE NATURE OF DEVELOPING APPLICATIONS FOR DATA COLLECTION DEVICES, OPTICAL READERS, IMAGE CAPTURE DEVICES, KIOSKS FOR ELECTRONICALLY PROVIDING DATA FOR PRICE CHECKING OR OTHER COMMUNICATIONS, TRANSACTION TERMINALS FOR USE IN AIDING RETAIL AND FINANCIAL TRANSACTIONS, RADIO-FREQUENCY IDENTIFICATION DEVICES, AND BAR CODE VERIFIERS; DESIGNING DATA COLLECTION SYSTEMS, DATA MANAGEMENT SYSTEMS, AND RETAIL TRANSACTION SYSTEMS FOR OTHERS; DESIGNING COMPUTER NETWORKS FOR OTHERS; DEVELOPING SOFTWARE FOR DATA COLLECTION DEVICES, OPTICAL READERS, IMAGE CAPTURE DEVICES, TRANSACTION TERMINALS FOR USE IN AIDING RETAIL TRANSACTIONS, RADIO-FREQUENCY IDENTIFICATION DEVICES, DATA COLLECTION SYSTEMS, DATA MANAGEMENT SYSTEMS, RETAIL TRANSACTION SYSTEMS FOR OTHERS, AND COMPUTER NETWORKS FOR OTHERS; PROVIDING ONLINE INFORMATION RELATING TO THE FOREGOING SERVICES (U.S. CLS. 100 AND 101).
FIRST USE 1-1-2005; IN COMMERCE 1-1-2005.

3,178,118. WKL, LLC, ARNOLD, MO. SN 78-539,561. PUB. 12-13-2005, FILED 12-29-2004.

OWNER OF U.S. REG. NO. 2,658,607.
SEC. 2(F) AS TO "HAND HELD".

CLEARFIELDS GROUP

CLASS 9—ELECTRICAL AND SCIENTIFIC APPARATUS

FOR DATA COLLECTION DEVICES, NAMELY, BAR CODE READERS, CHIP CARD READERS AND SMART CARD READERS; OPTICAL READERS; MOBILE COMPUTERS; KIOSKS FOR ELECTRONICALLY PROVIDING DATA FOR PRICE CHECKING OR OTHER COMMUNICATIONS; ELECTRONIC TRANSACTION TERMINALS FOR USE IN AIDING RETAIL AND FINANCIAL TRANSACTIONS; IMAGE CAPTURE DEVICES, NAMELY, DIGITAL CAMERAS; RADIO-FREQUENCY IDENTIFICATION DEVICES; BAR CODE VERIFIERS; COMPUTER DOCKING STATIONS; COMPUTER PRINTERS; SMART CARD READERS AND MAGNETIC STRIPE READERS FOR USE IN TRANSACTION TERMINALS; BATTERIES; BATTERY CHARGERS; CIRCUITS FOR USE IN THE FOREGOING GOODS; COMPUTER SOFTWARE FOR USE WITH THE FOREGOING GOODS; COMPONENT PARTS FOR THE FOREGOING GOODS; AND MANUALS SOLD AS A UNIT WITH THE FOREGOING GOODS (U.S. CLS. 21, 23, 26, 36 AND 38).
FIRST USE 1-1-2005; IN COMMERCE 1-1-2005.

CLASS 37—CONSTRUCTION AND REPAIR

FOR INSTALLATION, MAINTENANCE, AND REPAIR OF DATA COLLECTION DEVICES, OPTICAL READERS, MOBILE COMPUTERS, KIOSKS FOR ELECTRONICALLY PROVIDING DATA FOR PRICE CHECKING OR OTHER COMMUNICATIONS, TRANSACTION TERMINALS FOR USE IN AIDING RETAIL AND FINANCIAL TRANSACTIONS, IMAGE CAPTURE DEVICES, RADIO-FREQUENCY IDENTIFICATION DEVICES, AND BAR CODE VERIFIERS; INSTALLATION, MAINTENANCE, AND REPAIR OF DATA COLLECTION SYSTEMS AND DATA MANAGEMENT SYSTEMS; INSTALLATION, MAINTENANCE, AND REPAIR OF COMPUTER NETWORKS (U.S. CLS. 100, 103 AND 106).
FIRST USE 1-1-2005; IN COMMERCE 1-1-2005.

THE MARK CONSISTS OF STANDARD CHARACTERS WITHOUT CLAIM TO ANY PARTICULAR FONT, STYLE, SIZE, OR COLOR.

NO CLAIM IS MADE TO THE EXCLUSIVE RIGHT TO USE "GROUP", APART FROM THE MARK AS SHOWN.

CLASS 37—CONSTRUCTION AND REPAIR

FOR CONSTRUCTION AND RENOVATION OF BUILDINGS; ENVIRONMENTAL REMEDIATION SERVICES, NAMELY, WASTE DISPOSAL (U.S. CLS. 100, 103 AND 106).

FIRST USE 1-0-2005; IN COMMERCE 1-0-2005.

CLASS 40—MATERIAL TREATMENT

FOR ENVIRONMENTAL REMEDIATION SERVICES, NAMELY, SOIL, WASTE AND/OR WATER TREATMENT SERVICES; ASBESTOS AND MOLD REMEDIATION SERVICES; PROVIDING INFORMATION IN THE FIELD OF ENVIRONMENTAL MATTERS AND ENVIRONMENTAL REMEDIATION, NAMELY, ASBESTOS, MOLD, SOIL, WASTE AND/OR WATER TREATMENT SERVICES (U.S. CLS. 100, 103 AND 106).

FIRST USE 1-0-2005; IN COMMERCE 1-0-2005.

CLASS 42—SCIENTIFIC, COMPUTER AND LEGAL SERVICES

FOR PREPARING ENVIRONMENTAL COMPLIANCE REPORTS (U.S. CLS. 100 AND 101).
FIRST USE 1-0-2005; IN COMMERCE 1-0-2005.

3,178,122. SIDESTEP, INC, SANTA CLARA, CA. SN 78-542,118. PUB. 4-18-2006, FILED 1-4-2005.

CLASS 42—SCIENTIFIC, COMPUTER AND LEGAL SERVICES

FOR LEGAL SERVICES; PROVIDING INFORMATION IN THE FIELD OF INTELLECTUAL PROPERTY (U.S. CLS. 100 AND 101).

FIRST USE 4-29-2005; IN COMMERCE 4-29-2005.

SMARTSORT

3,178,160. PEDERSEN, LISA M., HERMOSA BEACH, CA. SN 78-558,282. PUB. 12-13-2005, FILED 2-1-2005.

THE MARK CONSISTS OF STANDARD CHARACTERS WITHOUT CLAIM TO ANY PARTICULAR FONT, STYLE, SIZE, OR COLOR.

MINDFUL BEGINNINGS

CLASS 39—TRANSPORTATION AND STORAGE

FOR PROVIDING INFORMATION AND LINKS REGARDING TRAVEL, TRANSPORTATION TICKETS AND TRANSPORTATION RESERVATIONS ON THE INTERNET (U.S. CLS. 100 AND 105).

FIRST USE 3-16-2005; IN COMMERCE 3-16-2005.

THE MARK CONSISTS OF STANDARD CHARACTERS WITHOUT CLAIM TO ANY PARTICULAR FONT, STYLE, SIZE, OR COLOR.

CLASS 43—HOTEL AND RESTAURANT SERVICES

FOR PROVIDING INFORMATION AND LINKS REGARDING TRAVEL AND RESERVATIONS AND BOOKINGS FOR TEMPORARY LODGING ON THE INTERNET (U.S. CLS. 100 AND 101).

FIRST USE 3-16-2005; IN COMMERCE 3-16-2005.

CLASS 41—EDUCATION AND ENTERTAINMENT

FOR EDUCATIONAL SERVICES, NAMELY, CONDUCTING CLASSES, TRAINING, SEMINARS AND WORKSHOPS ALL IN THE FIELDS OF CONCEPTION, CHILDBIRTH, YOGA, PARENTING AND PERSONAL DEVELOPMENT (U.S. CLS. 100, 101 AND 107).

FIRST USE 2-27-2005; IN COMMERCE 8-14-2006.

3,178,136. KNOBBE, MARTENS, OLSON & BEAR, LLP, IRVINE, CA. SN 78-549,063. PUB. 2-28-2006, FILED 1-18-2005.

CLASS 44—MEDICAL, BEAUTY AND AGRICULTURAL SERVICES

FOR PSYCHOTHERAPY SERVICES IN THE FIELDS OF CONCEPTION, CHILDBIRTH, PARENTING AND PERSONAL DEVELOPMENT (U.S. CLS. 100 AND 101).

FIRST USE 9-9-2005; IN COMMERCE 9-6-2006.

INTELLECTUAL PROPERTY LAW DOWN TO A SCIENCE

THE MARK CONSISTS OF STANDARD CHARACTERS WITHOUT CLAIM TO ANY PARTICULAR FONT, STYLE, SIZE, OR COLOR.

NO CLAIM IS MADE TO THE EXCLUSIVE RIGHT TO USE "INTELLECTUAL PROPERTY LAW", APART FROM THE MARK AS SHOWN.

CLASS 41—EDUCATION AND ENTERTAINMENT

FOR ARRANGING AND CONDUCTING EDUCATIONAL CONFERENCES; CONDUCTING SEMINARS, WORKSHOPS AND CONFERENCES IN THE LEGAL FIELD OF INTELLECTUAL PROPERTY; AND EDUCATIONAL SERVICES, NAMELY, PROVIDING EDUCATIONAL SPEAKERS IN THE FIELD OF INTELLECTUAL PROPERTY; TRAINING SERVICES IN THE FIELD OF INTELLECTUAL PROPERTY; AND DISTRIBUTING COURSE MATERIALS AND EDUCATION MATERIALS IN CONNECTION THEREWITH (U.S. CLS. 100, 101 AND 107).

FIRST USE 4-29-2005; IN COMMERCE 4-29-2005.

3,178,165. HOT STUFF FOODS, LLC, SIOUX FALLS, SD. SN 78-560,955. PUB. 12-27-2005, FILED 2-4-2005.

HOT STUFF FOODS

THE MARK CONSISTS OF STANDARD CHARACTERS WITHOUT CLAIM TO ANY PARTICULAR FONT, STYLE, SIZE, OR COLOR.

OWNER OF U.S. REG. NOS. 1,646,945, 2,449,152, AND OTHERS.

NO CLAIM IS MADE TO THE EXCLUSIVE RIGHT TO USE "FOODS", APART FROM THE MARK AS SHOWN.

CLASS 29—MEATS AND PROCESSED FOODS

FOR FOOD PRODUCTS NAMELY CHICKEN FAJITA MEAT; BEEF TOPPING; FRUIT-BASED FILLING FOR DONUTS, CINNAMON ROLLS, AND DESSERT PIZZA; CHEESE; BACON PIECES; PROCESSED NUT PIECES; CANADIAN BACON; SAUSAGE PATTIES; ITALIAN SAUSAGE; COOKING OIL; SOUPS; PORK; TOPPING PEPPERONI; BARBECUE BEEF; LUNCHEON MEAT; REFRIED BEANS; AND SCRAMBLED EGGS (U.S. CL. 46).

FIRST USE 7-0-2005; IN COMMERCE 7-0-2005.

CLASS 30—STAPLE FOODS

FOR FOOD PRODUCTS, NAMELY PIZZA CRUSTS; SWEET ROLL DOUGH; MUFFINS; COOKIE DOUGH; CONDIMENT SAUCES NAMELY KETCHUP, MUSTARD, HOT SAUCE, MAYONNAISE AND SALAD DRESSING; ICING; BROWNIE DOUGH; DOUGHNUTS DOUGH; BISCUIT DOUGH; EGG ROLLS; CORN TORTILLA CHIPS; CROISSANTS; BREAD ROLL DOUGH; PIZZA SAUCE; SPICE MIX; TORTILLAS; COFFEE; TACO SHELLS; COOKIES, PASTRY DOUGH; PASTRIES; AND SYRUP TOPPINGS (U.S. CL. 46).

FIRST USE 3-0-2005; IN COMMERCE 3-0-2005.

CLASS 35—ADVERTISING AND BUSINESS

FOR FOOD KIOSK SERVICES, RETAIL FOOD MARKETS (U.S. CLS. 100, 101 AND 102).

FIRST USE 3-0-2005; IN COMMERCE 3-0-2005.

CLASS 43—HOTEL AND RESTAURANT SERVICES

FOR RESTAURANT SERVICES, CARRY-OUT FOOD SHOP SERVICES (U.S. CLS. 100 AND 101).

FIRST USE 3-0-2005; IN COMMERCE 3-0-2005.

3,178,169. COSTCO WHOLESALE CORPORATION, ISSAQUAH, WA. SN 78-562,087. PUB. 6-21-2005, FILED 2-7-2005.

KIRKLAND SIGNATURE

THE MARK CONSISTS OF STANDARD CHARACTERS WITHOUT CLAIM TO ANY PARTICULAR FONT, STYLE, SIZE, OR COLOR.

OWNER OF U.S. REG. NOS. 2,560,144, 2,787,088, AND OTHERS.

CLASS 39—TRANSPORTATION AND STORAGE

FOR TRAVEL AGENCY SERVICES, NAMELY, MAKING RESERVATIONS AND BOOKINGS FOR TRANSPORTATION; ARRANGING TRAVEL PACKAGES AND CRUISES; ARRANGING EXCURSIONS AND TOURS (U.S. CLS. 100 AND 105).

FIRST USE 2-28-2006; IN COMMERCE 2-28-2006.

CLASS 43—HOTEL AND RESTAURANT SERVICES

FOR TRAVEL AGENCY SERVICES, NAMELY, MAKING RESERVATIONS AND BOOKINGS FOR TEMPORARY LODGING (U.S. CLS. 100 AND 101).

FIRST USE 2-28-2006; IN COMMERCE 2-28-2006.

3,178,172. HOT STUFF FOODS, LLC, SIOUX FALLS, SD. SN 78-563,403. PUB. 12-13-2005, FILED 2-9-2005.



OWNER OF U.S. REG. NOS. 1,646,945, 2,449,152, AND OTHERS.

NO CLAIM IS MADE TO THE EXCLUSIVE RIGHT TO USE "FOODS", APART FROM THE MARK AS SHOWN.

CLASS 29—MEATS AND PROCESSED FOODS

FOR FOOD PRODUCTS NAMELY CHICKEN FAJITA MEAT; BEEF TOPPING; FRUIT-BASED FILLING FOR DONUTS, CINNAMON ROLLS, AND DESSERT PIZZA; CHEESE; BACON PIECES; CANADIAN BACON; SAUSAGE PATTIES; ITALIAN SAUSAGE; COOKING OIL; SOUPS; PORK; TOPPING PEPPERONI; BARBECUE BEEF; LUNCHEON MEAT; REFRIED BEANS; AND SCRAMBLED EGGS (U.S. CL. 46).

FIRST USE 7-0-2005; IN COMMERCE 7-0-2005.

CLASS 30—STAPLE FOODS

FOR FOOD PRODUCTS, NAMELY PIZZA CRUSTS; SWEET ROLL DOUGH; MUFFINS; COOKIE DOUGH; CONDIMENT SAUCES NAMELY KETCHUP, MUSTARD, HOT SAUCE, MAYONNAISE AND SALAD DRESSING; ICING; BROWNIE DOUGH; DOUGHNUTS DOUGH; BISCUIT DOUGH; EGG ROLLS; CORN TORTILLA CHIPS; CROISSANTS; BREAD ROLL DOUGH; PIZZA SAUCE; SPICE MIX; TORTILLAS; COFFEE; TACO SHELLS; COOKIES, PASTRY DOUGH; PASTRIES; AND SYRUP TOPPINGS (U.S. CL. 46).

FIRST USE 3-0-2005; IN COMMERCE 3-0-2005.

CLASS 35—ADVERTISING AND BUSINESS

FOR FOOD KIOSK SERVICES, RETAIL FOOD MARKETS (U.S. CLS. 100, 101 AND 102).

FIRST USE 3-0-2005; IN COMMERCE 3-0-2005.

CLASS 43—HOTEL AND RESTAURANT SERVICES

FOR RESTAURANT SERVICES, CARRY-OUT FOOD SHOP SERVICES (U.S. CLS. 100 AND 101).

FIRST USE 3-0-2005; IN COMMERCE 3-0-2005.

3,178,188. CAESARS WORLD, INC., LAS VEGAS, NV. SN 78-567,836. PUB. 2-21-2006, FILED 2-15-2005.

The Pier at Caesars

THE MARK CONSISTS OF STANDARD CHARACTERS WITHOUT CLAIM TO ANY PARTICULAR FONT, STYLE, SIZE, OR COLOR.

OWNER OF U.S. REG. NOS. 954,637, 1,001,363, AND OTHERS.

CLASS 35—ADVERTISING AND BUSINESS

FOR RETAIL STORE SERVICES, FEATURING A VARIETY OF GOODS, NAMELY GENERAL MERCHANDISE, SOUVENIRS, NOVELTY ITEMS, GIFT ITEMS, CLOTHING, CLOTHING ACCESSORIES, JEWELRY, TOYS, SPORTING GOODS, STATIONARY PRODUCTS, BOOKS, VIDEOS, FRAGRANCES, PERSONAL CARE PRODUCTS, COSMETICS, HOUSE WARES, ART, FOODS, BEVERAGES, CIGARETTES AND SMOKING ACCESSORIES (U.S. CLS. 100, 101 AND 102).

FIRST USE 6-27-2006; IN COMMERCE 6-27-2006.

CLASS 36—INSURANCE AND FINANCIAL

FOR SHOPPING MALL SERVICES, NAMELY, LEASING OF SHOPPING MALL SPACE; LEASING OF SPACE IN SHOPPING MALLS (U.S. CLS. 100, 101 AND 102).

FIRST USE 6-27-2006; IN COMMERCE 6-27-2006.

CLASS 43—HOTEL AND RESTAURANT SERVICES

FOR RESTAURANT SERVICES, NAMELY, FAST FOOD, FAMILY AND FINE DINING, AND FAST FOOD RESTAURANT SERVICES IN WHICH VENDORS SELL FOOD AT STATIONS ABOUT A COMMON EATING SPACE (U.S. CLS. 100 AND 101).

FIRST USE 6-27-2006; IN COMMERCE 6-27-2006.

3,178,207. KOHL'S ILLINOIS, INC., AURORA, IL. SN 78-570,868. PUB. 12-13-2005, FILED 2-18-2005.

ST. NICHOLAS SQUARE

THE MARK CONSISTS OF STANDARD CHARACTERS WITHOUT CLAIM TO ANY PARTICULAR FONT, STYLE,

SIZE, OR COLOR.

OWNER OF U.S. REG. NOS. 1,690,921, 1,848,806, AND 1,870,206.

CLASS 4—LUBRICANTS AND FUELS

FOR CANDLES (U.S. CLS. 1, 6 AND 15).
FIRST USE 9-0-2005; IN COMMERCE 9-0-2005.

CLASS 20—FURNITURE AND ARTICLES NOT OTHERWISE CLASSIFIED

FOR DECORATIVE PILLOWS; PICTURE FRAMES NOT OF PRECIOUS METAL; SHOWER CURTAIN RINGS (U.S. CLS. 2, 13, 22, 25, 32 AND 50).
FIRST USE 10-0-2005; IN COMMERCE 10-0-2005.

CLASS 21—HOUSEWARES AND GLASS

FOR WASTEBASKETS; CANDLE HOLDERS NOT OF PRECIOUS METAL; BEVERAGE GLASSWARE (U.S. CLS. 2, 13, 23, 29, 30, 33, 40 AND 50).
FIRST USE 9-0-2005; IN COMMERCE 9-0-2005.

CLASS 24—FABRICS

FOR TABLE LINENS; QUILTED THROWS; SHOWER CURTAINS; TOWELS (U.S. CLS. 42 AND 50).
FIRST USE 9-0-2005; IN COMMERCE 9-0-2005.

CLASS 27—FLOOR COVERINGS

FOR RUGS (U.S. CLS. 19, 20, 37, 42 AND 50).
FIRST USE 10-0-2005; IN COMMERCE 10-0-2005.

3,178,217. THE PROCTER & GAMBLE COMPANY, CINCINNATI, OH. SN 78-573,236. PUB. 1-24-2006, FILED 2-23-2005.

GIFTS TO GROW

THE MARK CONSISTS OF STANDARD CHARACTERS WITHOUT CLAIM TO ANY PARTICULAR FONT, STYLE, SIZE, OR COLOR.

NO CLAIM IS MADE TO THE EXCLUSIVE RIGHT TO USE "GIFTS", APART FROM THE MARK AS SHOWN.

CLASS 35—ADVERTISING AND BUSINESS

FOR MARKETING SERVICES, NAMELY, CREATING, DESIGNING, AND EXECUTING PROMOTIONAL PROGRAMS IN THE FIELD OF BABY, INFANT, TODDLER AND CHILD PRODUCTS (U.S. CLS. 100, 101 AND 102).
FIRST USE 8-22-2005; IN COMMERCE 8-22-2005.

CLASS 41—EDUCATION AND ENTERTAINMENT

FOR EDUCATIONAL SERVICES, NAMELY PROVIDING ONLINE PROGRAMS RELATING TO THE PROMOTION OF BABY, INFANT, TODDLER AND CHILD PRODUCTS (U.S. CLS. 100, 101 AND 107).
FIRST USE 8-22-2005; IN COMMERCE 8-22-2005.

3,178,219. THE PROCTER & GAMBLE COMPANY, CINCINNATI, OH. SN 78-573,260. PUB. 1-24-2006, FILED 2-23-2005.



NO CLAIM IS MADE TO THE EXCLUSIVE RIGHT TO USE "GIFTS", APART FROM THE MARK AS SHOWN.

THE MARK CONSISTS OF STYLIZED WORDS GIFTS TO GROW AND AN OPEN GIFT BOX DEPICTED TO THE RIGHT OF GIFT WITH ABSTRACT HEART WITH THREE ACCENT STROKES APPEARING ABOVE THE HEART AND RISING OUT OF THE OPEN GIFT BOX.

CLASS 35—ADVERTISING AND BUSINESS

FOR MARKETING SERVICES, NAMELY, CREATING, DESIGNING, AND EXECUTING PROMOTIONAL PROGRAMS IN THE FIELD OF BABY, INFANT, TODDLER AND CHILD PRODUCTS (U.S. CLS. 100, 101 AND 102).
FIRST USE 8-22-2005; IN COMMERCE 8-22-2005.

CLASS 41—EDUCATION AND ENTERTAINMENT

FOR EDUCATIONAL SERVICES, NAMELY PROVIDING ONLINE PROGRAMS RELATING TO THE PROMOTION OF BABY, INFANT, TODDLER AND CHILD PRODUCTS (U.S. CLS. 100, 101 AND 107).
FIRST USE 8-22-2005; IN COMMERCE 8-22-2005.

3,178,222. SPORTS IMAGES, INC., WOBURN, MA. SN 78-574,265. PUB. 2-7-2006, FILED 2-24-2005.

Image Guard

THE MARK CONSISTS OF STANDARD CHARACTERS WITHOUT CLAIM TO ANY PARTICULAR FONT, STYLE, SIZE, OR COLOR.

NO CLAIM IS MADE TO THE EXCLUSIVE RIGHT TO USE "GUARD", APART FROM THE MARK AS SHOWN.

CLASS 16—PAPER GOODS AND PRINTED MATTER

FOR SOFT AND HARD FORMED PLASTIC PROTECTIVE HOLDERS, NAMELY, PLASTIC PAGES FOR COVERING TRADING CARDS, PENNANTS, COMIC BOOKS, COINS, MAGAZINES AND PHOTOGRAPHS (U.S. CLS. 2, 5, 22, 23, 29, 37, 38 AND 50).

FIRST USE 7-21-2004; IN COMMERCE 7-21-2004.

CLASS 20—FURNITURE AND ARTICLES NOT OTHERWISE CLASSIFIED

FOR PLASTIC BOXES FOR HOLDING SPORTS MEMORABILIA IN THE NATURE OF BASEBALLS, FOOTBALLS, FOOTBALL HELMETS, AND THE LIKE (U.S. CLS. 2, 13, 22, 25, 32 AND 50).

FIRST USE 5-30-2006; IN COMMERCE 5-30-2006.

3,178,236. RENTZ, KRISTEN C., SANTA MONICA, CA. SN 78-576,570. PUB. 12-6-2005, FILED 2-28-2005.

YogaNap

THE MARK CONSISTS OF STANDARD CHARACTERS WITHOUT CLAIM TO ANY PARTICULAR FONT, STYLE, SIZE, OR COLOR.

CLASS 16—PAPER GOODS AND PRINTED MATTER

FOR BOOKS ON YOGA (U.S. CLS. 2, 5, 22, 23, 29, 37, 38 AND 50).

FIRST USE 1-1-2002; IN COMMERCE 10-1-2005.

CLASS 41—EDUCATION AND ENTERTAINMENT

FOR EDUCATIONAL SERVICES, NAMELY PROVIDING TRAINING COURSES, LECTURES AND WORKSHOPS IN THE FIELD OF YOGA (U.S. CLS. 100, 101 AND 107).

FIRST USE 1-1-2002; IN COMMERCE 10-24-2002.

3,178,237. HEADROOM, BOZEMAN, MT. SN 78-576,831. PUB. 4-18-2006, FILED 2-28-2005.



THE COLOR(S) DARK GREY, WHITE, LIGHT BLUE ARE

CLAIMED AS A FEATURE OF THE MARK.

THE HEADPHONES ARE WHITE AND ARE OUTLINED IN DARK GRAY, THE OVAL IN THE CENTER OF THE HEADPHONES IS LIGHT BLUE; THE WORDING "HEAD" AND "RIGHT BETWEEN YOUR EARS" IS DARK GRAY; THE WORD "ROOM" IS LIGHT BLUE.

CLASS 9—ELECTRICAL AND SCIENTIFIC APPARATUS

FOR HEADPHONE AMPLIFIERS, DIGITAL TO ANALOG CONVERTERS, POWER SUPPLIES, SWITCHES, AND CABLES (U.S. CLS. 21, 23, 26, 36 AND 38).

FIRST USE 6-30-2005; IN COMMERCE 6-30-2005.

CLASS 18—LEATHER GOODS

FOR CARRYING CASES AND BAGS (U.S. CLS. 1, 2, 3, 22 AND 41).

FIRST USE 6-30-2005; IN COMMERCE 6-30-2005.

3,178,257. CORBIS CORPORATION, SEATTLE, WA. SN 78-581,927. PUB. 11-29-2005, FILED 3-7-2005.

ZEFA

THE MARK CONSISTS OF STANDARD CHARACTERS WITHOUT CLAIM TO ANY PARTICULAR FONT, STYLE, SIZE, OR COLOR.

CLASS 9—ELECTRICAL AND SCIENTIFIC APPARATUS

FOR PRE-RECORDED AUDIO TAPES, VIDEO TAPES, AUDIO RECORDINGS, VIDEO RECORDINGS, DOWNLOADABLE COMPUTER SOFTWARE, ROM, RAM, EEPROM (ELECTRICALLY ERASABLE PROGRAMMABLE READ ONLY MEMORY), FLASH MEMORY, CD-ROMS, DVDS, MAGNETIC TAPE CASSETTES, MAGNETIC HARD DISK STORAGE AND FLOPPY DISKS, FEATURING STILL IMAGES, MOVING IMAGES, PHOTOGRAPHY, PICTURES, CLIP ART, STOCK FOOTAGE, FILMS, ANIMATION, GRAPHICS, VIDEO, ILLUSTRATIONS, AUDIO, TEXT FILES, DOCUMENTS, DATABASES, TOOLS, AND OTHER ELECTRONIC DATA IN THE FIELDS OF NEWS, DOCUMENTARIES, HISTORY, SPORTS, TRAVEL, NATURE, LIFESTYLES, INDUSTRY, SCIENCE, ENTERTAINMENT, MUSIC, EDUCATION, ELECTRONIC AND PRINT PUBLISHING, GRAPHIC DESIGN, AND INTERACTIVE MULTIMEDIA (U.S. CLS. 21, 23, 26, 36 AND 38).

FIRST USE 5-6-2005; IN COMMERCE 5-6-2005.

CLASS 16—PAPER GOODS AND PRINTED MATTER

FOR PAPER GOODS AND PRINTED MATTER, NAMELY, BOOKS, CATALOGUES, PAMPHLETS, BROCHURES, MAGAZINES, NEWSPAPERS, AND DIRECTORIES, IN THE FIELDS OF NEWS, HISTORY, SPORTS, TRAVEL, NATURE, LIFESTYLES, INDUSTRY, ART, SCIENCE, ENTERTAINMENT, MUSIC AND EDUCATION; STATIONERY, POSTERS, CALENDARS; PAPER GOODS, PRINTED MATTER, DOCUMENTS AND STILL IMAGES, NAMELY, PHOTOGRAPHS, PICTURES, PRINTED VISUALS IN THE NATURE OF INFORMATION GRAPHICS, ILLUSTRATIONS AND CLIP ART BOOKS IN THE FIELDS OF NEWS, HISTORY, SPORTS, TRAVEL, NATURE, LIFESTYLES, INDUSTRY, SCIENCE, ENTERTAINMENT, MUSIC AND EDUCATION (U.S. CLS. 2, 5, 22, 23, 29, 37, 38 AND 50).

FIRST USE 5-6-2005; IN COMMERCE 5-14-2005.

CLASS 42—SCIENTIFIC, COMPUTER AND LEGAL SERVICES

FOR LICENSING OF INTELLECTUAL PROPERTY, NAMELY, PROVIDING ACCESS TO AND LICENSING TO OTHERS THE RIGHTS OF PRESENTATIONS AND PRODUCTION OF MEDIA PRODUCTS, NAMELY, STILL IMAGES, MOVING IMAGES, PHOTOGRAPHY, PICTURES, CLIP ART, STOCK FOOTAGE, DIGITAL DATA, FILMS, ANIMATIONS, GRAPHICS, VIDEO, ILLUSTRATIONS, AUDIO, TEXT, FILES, DOCUMENTS, AND DATABASES TO OTHERS IN WHOLE OR IN PART BY MEANS OF A GLOBAL COMPUTER NETWORK, WIDE AREA NETWORK, LOCAL AREA NETWORK, OR WIRELESS NETWORK (U.S. CLS. 100 AND 101).

FIRST USE 5-6-2005; IN COMMERCE 5-6-2005.

3,178,259. CORBIS CORPORATION, SEATTLE, WA. SN 78-581,939. PUB. 12-13-2005, FILED 3-7-2005.

ZEFA IMAGES

THE MARK CONSISTS OF STANDARD CHARACTERS WITHOUT CLAIM TO ANY PARTICULAR FONT, STYLE, SIZE, OR COLOR.

NO CLAIM IS MADE TO THE EXCLUSIVE RIGHT TO USE "IMAGES", APART FROM THE MARK AS SHOWN.

CLASS 9—ELECTRICAL AND SCIENTIFIC APPARATUS

FOR PRE-RECORDED AUDIO TAPES, VIDEO TAPES, AUDIO RECORDINGS, VIDEO RECORDINGS, DOWN-LOADABLE COMPUTER SOFTWARE, ROM, RAM, EEPROM (ELECTRICALLY ERASABLE PROGRAMMABLE READ ONLY MEMORY), FLASH MEMORY, CD-ROMS, DVDS, MAGNETIC TAPE CASSETTES, MAGNETIC HARD DISK STORAGE AND FLOPPY DISKS, FEATURING STILL IMAGES, MOVING IMAGES, PHOTOGRAPHY, PICTURES, CLIP ART, STOCK FOOTAGE, FILMS, ANIMATION, GRAPHICS, VIDEO, ILLUSTRATIONS, AUDIO, TEXT FILES, DOCUMENTS, DATABASES, TOOLS, AND OTHER ELECTRONIC DATA IN THE FIELDS OF NEWS, DOCUMENTARIES, HISTORY, SPORTS, TRAVEL, NATURE, LIFESTYLES, INDUSTRY, SCIENCE, ENTERTAINMENT, MUSIC, EDUCATION, ELECTRONIC AND PRINT PUBLISHING, GRAPHIC DESIGN, AND INTERACTIVE MULTIMEDIA (U.S. CLS. 21, 23, 26, 36 AND 38).

FIRST USE 5-6-2006; IN COMMERCE 5-6-2006.

CLASS 16—PAPER GOODS AND PRINTED MATTER

FOR PAPER GOODS AND PRINTED MATTER, NAMELY, BOOKS, CATALOGUES, PAMPHLETS, BROCHURES, MAGAZINES, NEWSPAPERS, AND DIRECTORIES, IN THE FIELDS OF NEWS, HISTORY, SPORTS, TRAVEL, NATURE, LIFESTYLES, INDUSTRY, ART, SCIENCE, ENTERTAINMENT, MUSIC AND EDUCATION; STATIONERY, POSTERS, CALENDARS; PAPER GOODS, PRINTED MATTER, DOCUMENTS AND STILL IMAGES, NAMELY, PHOTOGRAPHS, PICTURES, PRINTED VISUALS IN THE NATURE OF INFORMATION GRAPHICS, ILLUSTRATIONS AND CLIP ART BOOKS IN THE FIELDS OF NEWS, HISTORY, SPORTS, TRAVEL, NATURE, LIFESTYLES, INDUSTRY, SCIENCE, ENTERTAINMENT, MUSIC AND EDUCATION (U.S. CLS. 2, 5, 22, 23, 29, 37, 38 AND 50).

FIRST USE 5-6-2006; IN COMMERCE 5-14-2006.

CLASS 42—SCIENTIFIC, COMPUTER AND LEGAL SERVICES

FOR LICENSING OF INTELLECTUAL PROPERTY, NAMELY, PROVIDING ACCESS TO AND LICENSING TO OTHERS THE RIGHTS OF PRESENTATIONS AND PRODUCTION OF MEDIA PRODUCTS, NAMELY, STILL IMAGES, MOVING IMAGES, PHOTOGRAPHY, PICTURES, CLIP ART, STOCK FOOTAGE, DIGITAL DATA, FILMS, ANIMATIONS, GRAPHICS, VIDEO, ILLUSTRATIONS, AUDIO, TEXT, FILES, DOCUMENTS, AND DATABASES TO OTHERS IN WHOLE OR IN PART BY MEANS OF A GLOBAL COMPUTER NETWORK, WIDE AREA NETWORK, LOCAL AREA NETWORK, OR WIRELESS NETWORK (U.S. CLS. 100 AND 101).

FIRST USE 5-6-2005; IN COMMERCE 5-6-2005.

3,178,260. COURTROOM TELEVISION NETWORK LLC, NEW YORK, NY. SN 78-581,941. PUB. 11-29-2005, FILED 3-7-2005.

**SERIOUSLY
ENTERTAINING**

THE MARK CONSISTS OF STANDARD CHARACTERS WITHOUT CLAIM TO ANY PARTICULAR FONT, STYLE, SIZE, OR COLOR.

CLASS 9—ELECTRICAL AND SCIENTIFIC APPARATUS

FOR PRERECORDED VIDEOTAPES AND DVDS FEATURING JUDICIAL TRIALS, JUDICIAL NEWS AND ISSUES, LEGAL ISSUES, CRIMINAL INQUIRIES, CASE ANALYSES, CASE COMMENTARIES AND INTERVIEWS (U.S. CLS. 21, 23, 26, 36 AND 38).

FIRST USE 7-22-2005; IN COMMERCE 7-0-2005.

CLASS 38—COMMUNICATION

FOR TELEVISION BROADCASTING SERVICES, AND THE ELECTRONIC TRANSMISSION OF TEXT, DATA, AUDIO AND VIDEO VIA CABLE, WIRELESS COMMUNICATIONS NETWORK AND THE INTERNET (U.S. CLS. 100, 101 AND 104).

FIRST USE 7-0-2005; IN COMMERCE 7-0-2005.

CLASS 41—EDUCATION AND ENTERTAINMENT

FOR EDUCATIONAL AND ENTERTAINMENT SERVICES, NAMELY, CABLE TELEVISION PROGRAMMING SERVICES FEATURING JUDICIAL TRIALS, JUDICIAL NEWS AND ISSUES, LEGAL ISSUES, CRIMINAL INQUIRIES, CASE ANALYSES, CASE COMMENTARIES AND INTERVIEWS; PRODUCTION AND DISTRIBUTION OF TELEVISION PROGRAMMING (U.S. CLS. 100, 101 AND 107).

FIRST USE 7-0-2005; IN COMMERCE 7-0-2005.

CLASS 42—SCIENTIFIC, COMPUTER AND LEGAL SERVICES

FOR INTERACTIVE ONLINE SERVICES, NAMELY, PROVIDING INFORMATION RELATING TO JUDICIAL TRIALS, JUDICIAL NEWS AND ISSUES, LEGAL ISSUES, CRIMINAL INQUIRIES, CASE ANALYSES AND CASE COMMENTARIES VIA A GLOBAL COMPUTER NETWORK (U.S. CLS. 100 AND 101).

FIRST USE 7-0-2005; IN COMMERCE 7-0-2005.

3,178,265. INGENIATRICS TECNOLOGIAS, S.L., NEW YORK, NY. SN 78-582,934. PUB. 11-29-2005, FILED 3-8-2005.



INGENIATRICS

THE COLOR(S) BLUE AND WHITE IS/ARE CLAIMED AS A FEATURE OF THE MARK.

THE MARK CONSISTS OF THE STYLIZED TERM INGENIATRICS IN BLUE, BELOW A MISCELLANEOUS CIRCLE DESIGN THAT IS BLUE WITH WHITE STRIPES.

CLASS 9—ELECTRICAL AND SCIENTIFIC APPARATUS

FOR SCIENTIFIC APPARATUS AND INSTRUMENTS FOR THE MANIPULATION OF FLUIDS ON MICRO AND NANOMETRICAL SCALE, AND WHICH CONTROL THE GENERATION OF MICRO SPURTS, MICRO PARTICLES, MICRO FIBERS, AND MICRO BUBBLES (U.S. CLS. 21, 23, 26, 36 AND 38).

FIRST USE 9-1-2001; IN COMMERCE 3-12-2004.

CLASS 42—SCIENTIFIC, COMPUTER AND LEGAL SERVICES

FOR SCIENTIFIC AND TECHNOLOGICAL RESEARCH AND DEVELOPMENT IN THE FIELDS OF MEDICINE, PHARMACEUTICAL, AND HEALTH; ENGINEERING SERVICES; BIOLOGICAL ANALYSIS IN THE FIELD OF GENETICS, CHEMISTRY AND BACTERIOLOGY (U.S. CLS. 100 AND 101).

FIRST USE 9-1-2001; IN COMMERCE 3-14-2004.

3,178,278. MOTHERLODE ENTERPRISES, LLC, NORTHPORT, NY. SN 78-586,372. PUB. 12-6-2005, FILED 3-14-2005.

EVERYDAY SOBRIETY

THE MARK CONSISTS OF STANDARD CHARACTERS WITHOUT CLAIM TO ANY PARTICULAR FONT, STYLE, SIZE, OR COLOR.

NO CLAIM IS MADE TO THE EXCLUSIVE RIGHT TO USE "SOBRIETY", APART FROM THE MARK AS SHOWN.

CLASS 16—PAPER GOODS AND PRINTED MATTER

FOR PRINTED MATERIALS, NAMELY, PAMPHLETS, GUIDES, WORKBOOKS, BOOKLETS AND BOOKS FOR USE DURING DISCUSSIONS AND READING GROUPS IN THE FIELD OF SOBRIETY MAINTENANCE AND RECOVERY FROM SUBSTANCE ABUSE (U.S. CLS. 2, 5, 22, 23, 29, 37, 38 AND 50).

FIRST USE 5-5-2006; IN COMMERCE 5-5-2006.

CLASS 41—EDUCATION AND ENTERTAINMENT

FOR CONDUCTING DISCUSSION GROUPS IN THE FIELD OF SOBRIETY MAINTENANCE AND RECOVERY FROM SUBSTANCE ABUSE; CONDUCTING DISCUSSION GROUPS WITH AUTHORS AND READERS RELATING TO BOOKS, AUTHORS AND READING IN THE FIELD OF SOBRIETY MAINTENANCE AND RECOVERY FROM SUBSTANCE ABUSE (U.S. CLS. 100, 101 AND 107).

FIRST USE 5-5-2006; IN COMMERCE 5-5-2006.

3,178,285. MORRIS & DICKSON CO., LTD., SHREVEPORT, LA. SN 78-587,933. PUB. 11-29-2005, FILED 3-15-2005.

M & D CARES

THE MARK CONSISTS OF STANDARD CHARACTERS WITHOUT CLAIM TO ANY PARTICULAR FONT, STYLE, SIZE, OR COLOR.

CLASS 9—ELECTRICAL AND SCIENTIFIC APPARATUS

FOR COMPUTER SOFTWARE WHICH CATALOGS AND STREAMLINES INPUT DATA AND THEN TRANSFERS THE INFORMATION INTO VARIOUS APPLICATION FORMS IN ORDER TO ASSIST HOSPITALS IN CAPTURING ADDITIONAL REVENUE AND PROFITABILITY FROM DRUG MANUFACTURERS (U.S. CLS. 21, 23, 26, 36 AND 38).

FIRST USE 8-1-2006; IN COMMERCE 8-1-2006.

CLASS 42—SCIENTIFIC, COMPUTER AND LEGAL SERVICES

FOR PROVIDING TEMPORARY USE OF ONLINE NON-DOWNLOADABLE COMPUTER SOFTWARE WHICH CATALOGS AND STREAMLINES INPUT DATA AND THEN TRANSFERS THE INFORMATION INTO VARIOUS APPLICATION FORMS IN ORDER TO ASSIST HOSPITALS IN CAPTURING ADDITIONAL REVENUE AND PROFITABILITY FROM DRUG MANUFACTURERS (U.S. CLS. 100 AND 101).

FIRST USE 8-1-2006; IN COMMERCE 8-1-2006.

3,178,288. HAILEY B, INC., COLD SPRING HARBOR, NY. SN 78-588,483. PUB. 12-27-2005, FILED 3-16-2005.

ROOMS OF WONDER

THE MARK CONSISTS OF STANDARD CHARACTERS WITHOUT CLAIM TO ANY PARTICULAR FONT, STYLE, SIZE, OR COLOR.

CLASS 35—ADVERTISING AND BUSINESS

FOR RETAIL STORE SERVICES FEATURING EDUCATIONAL AND CREATIVE TOYS, CULTURAL ENRICHMENT MATERIALS, BOOKS, AUDIOVISUAL PRODUCTS, AND CREATIVE ARTS MATERIALS (U.S. CLS. 100, 101 AND 102).

FIRST USE 3-1-2005; IN COMMERCE 3-1-2005.

CLASS 41—EDUCATION AND ENTERTAINMENT

FOR EDUCATIONAL SERVICES, NAMELY, PROVIDING EDUCATIONAL PROGRAMS AND SPECIAL EVENTS PROGRAMS IN THE AREAS OF ART, MUSIC, SCIENCE, LANGUAGE, AND CULTURAL ENRICHMENT (U.S. CLS. 100, 101 AND 107).

FIRST USE 3-1-2005; IN COMMERCE 3-1-2005.

3,178,325. SATELLITE HEALTHCARE, MOUNTAIN VIEW, CA. SN 78-594,447. PUB. 5-30-2006, FILED 3-24-2005.

SPIN

THE MARK CONSISTS OF STANDARD CHARACTERS WITHOUT CLAIM TO ANY PARTICULAR FONT, STYLE, SIZE, OR COLOR.

CLASS 42—SCIENTIFIC, COMPUTER AND LEGAL SERVICES

FOR PROVIDING TEMPORARY USE OF ONLINE NON-DOWNLOADABLE SOFTWARE REGARDING CLINICAL INFORMATION DESIGNED TO ALLOW HEALTHCARE PROVIDERS TO TRACK CLINICAL RECORDS AND PATIENT OUTCOMES AND ADJUST TREATMENT REGIMENS AND QUALITY ASSURANCE ACTIONS ACCORDINGLY (U.S. CLS. 100 AND 101).

FIRST USE 3-28-2005; IN COMMERCE 3-28-2005.

CLASS 44—MEDICAL, BEAUTY AND AGRICULTURAL SERVICES

FOR PROVIDING ONLINE CLINICAL INFORMATION DESIGNED TO ALLOW HEALTHCARE PROVIDERS TO TRACK CLINICAL RECORDS AND PATIENT OUTCOMES AND ADJUST TREATMENT REGIMENS AND QUALITY ASSURANCE ACTIONS ACCORDINGLY (U.S. CLS. 100 AND 101).

FIRST USE 3-28-2005; IN COMMERCE 3-28-2005.

3,178,333. UR TECHNOLOGIES, INC., EAST SYRACUSE, NY. SN 78-595,796. PUB. 12-27-2005, FILED 3-27-2005.

SATELLITE RADIOS DIRECT



NO CLAIM IS MADE TO THE EXCLUSIVE RIGHT TO USE "SATELLITE RADIOS DIRECT", APART FROM THE MARK AS SHOWN.

THE MARK CONSISTS OF THE WORDS SATELLITE RADIOS DIRECT INTERCEPTING THE CENTER OF BROKEN CONCENTRIC CIRCLES.

CLASS 9—ELECTRICAL AND SCIENTIFIC APPARATUS

FOR RADIO RECEIVERS AND CONNECTING ELECTRIC CABLES (U.S. CLS. 21, 23, 26, 36 AND 38).

FIRST USE 10-14-2004; IN COMMERCE 10-14-2004.

CLASS 37—CONSTRUCTION AND REPAIR

FOR INSTALLATION AND REPAIR OF RADIO RECEIVERS (U.S. CLS. 100, 103 AND 106).

FIRST USE 10-14-2004; IN COMMERCE 10-14-2004.

3,178,336. EITELJORG MUSEUM OF AMERICAN INDIANS AND WESTERN ART, INC., INDIANAPOLIS, IN. SN 78-596,461. PUB. 12-20-2005, FILED 3-28-2005.

QUEST FOR THE WEST

THE MARK CONSISTS OF STANDARD CHARACTERS WITHOUT CLAIM TO ANY PARTICULAR FONT, STYLE, SIZE, OR COLOR.

CLASS 35—ADVERTISING AND BUSINESS

FOR ARRANGING AND CONDUCTING AUCTION SALES (U.S. CLS. 100, 101 AND 102).

FIRST USE 1-31-2006; IN COMMERCE 1-31-2006.

CLASS 36—INSURANCE AND FINANCIAL

FOR CHARITABLE FUNDRAISING FOR ART MUSEUMS (U.S. CLS. 100, 101 AND 102).

FIRST USE 1-31-2006; IN COMMERCE 1-31-2006.

CLASS 41—EDUCATION AND ENTERTAINMENT

FOR ART EXHIBITIONS (U.S. CLS. 100, 101 AND 107).

FIRST USE 1-31-2006; IN COMMERCE 1-31-2006.

3,178,364. CHEVRON CORPORATION, SAN RAMON, CA. SN 78-601,324. PUB. 12-27-2005, FILED 4-4-2005.

WILL YOU JOIN US?

THE MARK CONSISTS OF STANDARD CHARACTERS WITHOUT CLAIM TO ANY PARTICULAR FONT, STYLE, SIZE, OR COLOR.

CLASS 40—MATERIAL TREATMENT

FOR PROVIDING INFORMATION IN THE FIELDS OF OIL AND NATURAL GAS PRODUCTION AND REFINING (U.S. CLS. 100, 103 AND 106).

FIRST USE 7-12-2005; IN COMMERCE 7-12-2005.

CLASS 42—SCIENTIFIC, COMPUTER AND LEGAL SERVICES

FOR PROVIDING INFORMATION IN THE FIELD OF OIL AND NATURAL GAS EXPLORATION AND IN THE FIELD OF RESEARCH IN THE FIELD OF ALTERNATIVE ENERGY SOURCES (U.S. CLS. 100 AND 101).

FIRST USE 7-12-2005; IN COMMERCE 7-12-2005.

3,178,375. ASPECT SOFTWARE, INC., WESTFORD, MA. SN 78-603,846. PUB. 1-3-2006, FILED 4-7-2005.

**Transforming the
way companies
interact with their
customers**

THE MARK CONSISTS OF STANDARD CHARACTERS WITHOUT CLAIM TO ANY PARTICULAR FONT, STYLE, SIZE, OR COLOR.

CLASS 9—ELECTRICAL AND SCIENTIFIC APPARATUS

FOR COMPUTER SOFTWARE FOR MANAGING AND ROUTING CUSTOMER CONTACT VIA TELEPHONE, E-MAIL, INTERNET AND FAX; COMPUTER SOFTWARE FOR GENERATING CONTACT CENTER REPORTS, RESPONDING TO INBOUND AND OUTBOUND TELEPHONE CALLS AND CREATING DESKTOP AUTOMATION TOOLS (U.S. CLS. 21, 23, 26, 36 AND 38).

FIRST USE 5-1-2005; IN COMMERCE 5-1-2005.

CLASS 35—ADVERTISING AND BUSINESS

FOR BUSINESS CONSULTATION IN THE FIELD OF CUSTOMER CONTACT CENTERS VIA AUTOMATED CENTERS FOR SENDING AND RECEIVING MESSAGES THROUGH MULTIPLE CHANNELS (U.S. CLS. 100, 101 AND 102).

FIRST USE 5-1-2005; IN COMMERCE 5-1-2005.

3,178,382. ADVANCE MERCHANDISING COMPANY, INC., ROANOKE, VA. SN 78-606,834. PUB. 1-17-2006, FILED 4-12-2005.

MIRAGE

THE MARK CONSISTS OF STANDARD CHARACTERS WITHOUT CLAIM TO ANY PARTICULAR FONT, STYLE, SIZE, OR COLOR.

CLASS 21—HOUSEWARES AND GLASS

FOR WASH AND WAX ACCESSORIES, NAMELY CLEANING AND SCRUBBING SPONGES, CLEANING AND SCRUBBING BRUSHES, POLISHING AND WAXING BONNETS, HOSE NOZZLES, WAX AND POLISH APPLICATORS AND CHAMOIS (U.S. CLS. 2, 13, 23, 29, 30, 33, 40 AND 50).

FIRST USE 12-31-2005; IN COMMERCE 12-31-2005.

CLASS 24—FABRICS

FOR WASH AND WAX ACCESSORIES, NAMELY TOWELS AND WASH MITTS (U.S. CLS. 42 AND 50). FIRST USE 12-31-2005; IN COMMERCE 12-31-2005.

3,178,405. OCTOPUS NEW YORK, NEW YORK, NY. SN 78-617,486. PUB. 2-7-2006, FILED 4-26-2005.

OCTOPUS

THE MARK CONSISTS OF STANDARD CHARACTERS WITHOUT CLAIM TO ANY PARTICULAR FONT, STYLE, SIZE, OR COLOR.

CLASS 9—ELECTRICAL AND SCIENTIFIC APPARATUS

FOR COMPUTER CARRYING CASES (U.S. CLS. 21, 23, 26, 36 AND 38).

FIRST USE 11-24-2004; IN COMMERCE 10-27-2005.

CLASS 18—LEATHER GOODS

FOR CARRY ALL BAGS FOR CARRYING ITEMS, NAMELY, FILES, FILE FOLDERS, LEGAL FILE FOLDERS, NEWSPAPERS, MAGAZINES, JOURNALS, PORTFOLIOS, ART PORTFOLIOS, DOCUMENTS, NOTEBOOKS, SKETCH BOOKS, RECREATIONAL EQUIPMENT, AND SPORTS EQUIPMENT (U.S. CLS. 1, 2, 3, 22 AND 41).

FIRST USE 11-24-2004; IN COMMERCE 10-27-2005.

3,178,406. MEDTRONIC, INC., MINNEAPOLIS, MN. SN 78-618,686. PUB. 1-10-2006, FILED 4-28-2005.



Medtronic

Alleviating Pain · Restoring Health · Extending Life

OWNER OF U.S. REG. NOS. 989,169, 2,742,356, AND 2,753,382.

CLASS 42—SCIENTIFIC, COMPUTER AND LEGAL SERVICES

FOR TECHNICAL CONSULTATION IN THE FIELD OF MEDICAL AND SURGICAL EQUIPMENT, APPARATUS AND APPLIANCES AND INSTRUMENTS, MEDICAL CARE, MEDICAL THERAPY AND SURGERY; MEDICAL RESEARCH IN THE FIELD OF MEDICAL AND SURGICAL APPARATUS, APPLIANCES, INSTRUMENTS, THERAPIES AND DRUGS; COMPUTER SOFTWARE DESIGN FOR OTHERS, COMPUTER PROGRAMMING FOR OTHERS, AND UPDATING OF COMPUTER SOFTWARE; MAINTENANCE OF COMPUTER SOFTWARE (U.S. CLS. 100 AND 101).

FIRST USE 9-1-2005; IN COMMERCE 9-1-2005.

CLASS 44—MEDICAL, BEAUTY AND AGRICULTURAL SERVICES

FOR PROFESSIONAL CONSULTATION IN THE FIELD OF MEDICAL AND SURGICAL EQUIPMENT, APPARATUS, APPLICANCES AND INSTRUMENTS, MEDICAL CARE, MEDICAL THERAPY AND SURGERY (U.S. CLS. 100 AND 101).

FIRST USE 9-1-2005; IN COMMERCE 9-1-2005.

3,178,453. THE HEMINGFORD CO-OPERATIVE TELEPHONE COMPANY, HEMINGFORD, NE. SN 78-636,848. PUB. 5-2-2006, FILED 5-25-2005.



OWNER OF U.S. REG. NOS. 2,451,433 AND 2,470,097.
NO CLAIM IS MADE TO THE EXCLUSIVE RIGHT TO USE "BUSINESS SERVICES", APART FROM THE MARK AS SHOWN.

CLASS 37—CONSTRUCTION AND REPAIR

FOR INSTALLATION, MAINTENANCE AND REPAIR OF COMPUTER NETWORKS; TELECOMMUNICATION WIRING; INSTALLATION OF SECURITY SYSTEMS (U.S. CLS. 100, 103 AND 106).

FIRST USE 5-12-2005; IN COMMERCE 5-12-2005.

CLASS 38—COMMUNICATION

FOR PROVIDING TELECOMMUNICATIONS CONNECTIONS TO A GLOBAL COMPUTER NETWORK; PROVIDING ACCESS TO TELECOMMUNICATIONS NETWORKS (U.S. CLS. 100, 101 AND 104).

FIRST USE 5-12-2005; IN COMMERCE 5-12-2005.

CLASS 42—SCIENTIFIC, COMPUTER AND LEGAL SERVICES

FOR DESIGNING AND HOSTING THE WEB SITES OF OTHERS ON A COMPUTER SERVER FOR A GLOBAL COMPUTER NETWORK (U.S. CLS. 100 AND 101).

FIRST USE 5-12-2005; IN COMMERCE 5-12-2005.

CLASS 45—PERSONAL SERVICES

FOR MONITORING SECURITY SYSTEMS (U.S. CLS. 100 AND 101).

FIRST USE 3-1-2006; IN COMMERCE 3-1-2006.

3,178,471. SYCAMORE S.C.S. LLC, LOUISVILLE, KY. SN 78-643,979. PUB. 5-9-2006, FILED 6-6-2005.

SYCAMORE PROFESSIONAL

THE MARK CONSISTS OF STANDARD CHARACTERS WITHOUT CLAIM TO ANY PARTICULAR FONT, STYLE, SIZE, OR COLOR.

NO CLAIM IS MADE TO THE EXCLUSIVE RIGHT TO

USE "PROFESSIONAL", APART FROM THE MARK AS SHOWN.

CLASS 6—METAL GOODS

FOR TOOLBOXES OF METAL, WITH OR WITHOUT WHEELS (U.S. CLS. 2, 12, 13, 14, 23, 25 AND 50).

FIRST USE 9-30-2005; IN COMMERCE 5-22-2006.

CLASS 12—VEHICLES

FOR MOTOR VEHICLE REPAIR EQUIPMENT, NAMELY, MECHANICS' ROLLING CREEPERS AND MECHANICS' SHOP SEATS, NAMELY, ROLLING OR NON-ROLLING SUPPORTS FOR USE BY MECHANICS WHILE REPAIRING VEHICLES (U.S. CLS. 19, 21, 23, 31, 35 AND 44).

FIRST USE 7-29-2005; IN COMMERCE 2-15-2006.

3,178,479. VANCE PUBLISHING CORPORATION, LINCOLNSHIRE, IL. SN 78-648,349. PUB. 3-7-2006, FILED 6-10-2005.

FIRSTCHAIR

THE MARK CONSISTS OF STANDARD CHARACTERS WITHOUT CLAIM TO ANY PARTICULAR FONT, STYLE, SIZE, OR COLOR.

CLASS 16—PAPER GOODS AND PRINTED MATTER

FOR TRADE PUBLICATIONS IN THE NATURE OF PRINT MAGAZINES IN THE FIELD OF COSMETOLOGY (U.S. CLS. 2, 5, 22, 23, 29, 37, 38 AND 50).

FIRST USE 7-31-2006; IN COMMERCE 7-31-2006.

CLASS 44—MEDICAL, BEAUTY AND AGRICULTURAL SERVICES

FOR COMPUTER SERVICES, NAMELY, PROVIDING ONLINE INFORMATION IN THE FIELD OF COSMETOLOGY (U.S. CLS. 100 AND 101).

FIRST USE 7-31-2006; IN COMMERCE 7-31-2006.

3,178,493. ADVANCE MERCHANDISING COMPANY, INC., ROANOKE, VA. SN 78-654,432. PUB. 1-31-2006, FILED 6-20-2005.



THE COLOR(S) ORANGE AND BLUE IS/ARE CLAIMED AS A FEATURE OF THE MARK.

THE MARK CONSISTS OF STYLIZED WORD MIRAGE COLORED ORANGE, WITH REPRESENTATION OF A PALM TREE FORMING THE LETTER I (TOP OF TREE/DOT OF LETTER I COLORED BLUE), POSITIONED DIRECTLY ABOVE AND AGAINST THE UPSIDE-DOWN

AND REVERSED WORD MIRAGE, COLORED ORANGE, APPEARING WITH WAVY LINES THROUGH IT REPRESENTING A REFLECTION OF THE WORD.

CLASS 21—HOUSEWARES AND GLASS

FOR WASH AND WAX ACCESSORIES, NAMELY CLEANING AND SCRUBBING SPONGES, CLEANING AND SCRUBBING BRUSHES, POLISHING AND WAXING BONNETS, HOSE NOZZLES, WAX AND POLISH APPLICATORS AND CHAMOIS (U.S. CLS. 2, 13, 23, 29, 30, 33, 40 AND 50).

FIRST USE 12-31-2005; IN COMMERCE 12-31-2005.

CLASS 24—FABRICS

FOR WASH AND WAX ACCESSORIES, NAMELY TOWELS AND WASH MITTS (U.S. CLS. 42 AND 50).

FIRST USE 12-31-2005; IN COMMERCE 12-31-2005.

3,178,494. SPERON, SAM, PARK RIDGE, IL. SN 78-655,785. PUB. 3-28-2006, FILED 6-22-2005.

SCAR ADVANTAGE

THE MARK CONSISTS OF STANDARD CHARACTERS WITHOUT CLAIM TO ANY PARTICULAR FONT, STYLE, SIZE, OR COLOR.

NO CLAIM IS MADE TO THE EXCLUSIVE RIGHT TO USE "SCAR", APART FROM THE MARK AS SHOWN.

CLASS 3—COSMETICS AND CLEANING PREPARATIONS

FOR NON-MEDICATED SKIN CARE PREPARATIONS FOR THE TREATMENT OF SCARS (U.S. CLS. 1, 4, 6, 50, 51 AND 52).

FIRST USE 7-0-2006; IN COMMERCE 7-0-2006.

CLASS 5—PHARMACEUTICALS

FOR MEDICATED SKIN CARE PREPARATIONS FOR THE TREATMENT OF SCARS (U.S. CLS. 6, 18, 44, 46, 51 AND 52).

FIRST USE 7-0-2006; IN COMMERCE 7-0-2006.

3,178,506. NAVAHO NETWORKS INC., TORONTO, ONTARIO, CANADA. SN 78-659,112. PUB. 3-28-2006, FILED 6-27-2005.



CLASS 35—ADVERTISING AND BUSINESS

FOR PROMOTING THE SALE OF CASHLESS ELECTRONIC PAYMENT SOFTWARE AND CASHLESS ELECTRONIC PAYMENT SERVICES THROUGH THE ADMINISTRATION OF CONSUMER LOYALTY INCENTIVE AWARD PROGRAMS (U.S. CLS. 100, 101 AND 102).

FIRST USE 12-31-2000; IN COMMERCE 12-31-2000.

CLASS 36—INSURANCE AND FINANCIAL

FOR ELECTRONIC SERVICES FOR CONSUMERS AND MERCHANTS TO SEND AND RECEIVE PAYMENTS VIA THE INTERNET, VIA TELEPHONE AND/OR VIA TELEVISION CONNECTION; ELECTRONIC PAYMENT SERVICES, NAMELY, ENABLING CONSUMERS TO MAKE PAYMENTS FOR GOODS AND SERVICES PURCHASED FROM MERCHANTS; CASHLESS PURCHASING SERVICES FOR MERCHANTS AND CONSUMERS WHEREBY PURCHASE MONIES ARE HELD IN TRUST AND SENT TO MERCHANTS UPON SALES TO CONSUMERS; FINANCIAL PROCESSING SERVICES AND MONETARY CHECK PROCESSING SERVICES, NAMELY PROVIDING PAYMENT TO MERCHANTS WHO SELL TO CONSUMERS SERVICES AND GOODS ONLINE; CLEARING AND RECONCILING FINANCIAL TRANSACTIONS VIA A GLOBAL COMPUTER NETWORK; PROVIDING A WIDE VARIETY OF PAYMENT SERVICES, NAMELY, CREDIT CARD AND DEBIT CARD SERVICES, PROCESSING AND TRANSMISSION OF BILLS AND PAYMENTS THEREOF, CONDUCTED VIA A GLOBAL COMPUTER NETWORK (U.S. CLS. 100, 101 AND 102).

FIRST USE 1-10-2002; IN COMMERCE 1-10-2002.

3,178,514. BIG TIME PRODUCTS, L.L.C., ROME, GA. SN 78-660,768. PUB. 3-21-2006, FILED 6-29-2005.

GREEN HOUSE

THE MARK CONSISTS OF STANDARD CHARACTERS WITHOUT CLAIM TO ANY PARTICULAR FONT, STYLE, SIZE, OR COLOR.

CLASS 9—ELECTRICAL AND SCIENTIFIC APPARATUS

FOR PROTECTIVE GLOVES FOR INDUSTRIAL USE; PROTECTIVE WORK GLOVES (U.S. CLS. 21, 23, 26, 36 AND 38).

FIRST USE 3-17-2006; IN COMMERCE 3-17-2006.

CLASS 21—HOUSEWARES AND GLASS

FOR DISPOSABLE LATEX GLOVES FOR GENERAL USE; HOUSEHOLD GLOVES FOR GENERAL USE; GARDENING GLOVES (U.S. CLS. 2, 13, 23, 29, 30, 33, 40 AND 50).

FIRST USE 3-17-2006; IN COMMERCE 3-17-2006.

CLASS 25—CLOTHING

FOR WORK GLOVES (U.S. CLS. 22 AND 39).

FIRST USE 3-17-2006; IN COMMERCE 3-17-2006.

3,178,522. KARE DISTRIBUTION, INC., NEW YORK, NY. SN 78-662,832. PUB. 3-21-2006, FILED 7-1-2005.

TURBO

THE MARK CONSISTS OF STANDARD CHARACTERS

WITHOUT CLAIM TO ANY PARTICULAR FONT, STYLE, SIZE, OR COLOR.

CLASS 16—PAPER GOODS AND PRINTED MATTER

FOR PREPAID TELEPHONE CALLING CARDS, NOT MAGNETICALLY ENCODED (U.S. CLS. 2, 5, 22, 23, 29, 37, 38 AND 50).

FIRST USE 9-20-2005; IN COMMERCE 9-20-2005.

CLASS 38—COMMUNICATION

FOR TELECOMMUNICATIONS SERVICES PROVIDED VIA PREPAID TELEPHONE CALLING CARDS (U.S. CLS. 100, 101 AND 104).

FIRST USE 9-20-2005; IN COMMERCE 9-20-2005.

3,178,542. CUSTOM COMMERCIAL DRY CLEANERS, INC., HAYWARD, CA. SN 78-672,364. PUB. 3-28-2006, FILED 7-18-2005.

FRST

THE MARK CONSISTS OF STANDARD CHARACTERS WITHOUT CLAIM TO ANY PARTICULAR FONT, STYLE, SIZE, OR COLOR.

CLASS 35—ADVERTISING AND BUSINESS

FOR FRANCHISE SERVICES, NAMELY PROVIDING ASSISTANCE IN THE ESTABLISHMENT AND/OR OPERATION OF DRY CLEANING SERVICES AND RESTORATION SERVICES FOR CLOTHES, TEXTILE AND LEATHER (U.S. CLS. 100, 101 AND 102).

FIRST USE 1-2-2006; IN COMMERCE 3-1-2006.

CLASS 37—CONSTRUCTION AND REPAIR

FOR DRY CLEANING SERVICES; RESTORATION SERVICES FOR CLOTHES, TEXTILE AND LEATHER (U.S. CLS. 100, 103 AND 106).

FIRST USE 1-2-2006; IN COMMERCE 3-1-2006.

3,178,567. DIXON, BERNARD WAYNE JR., CHAPEL HILL, NC. SN 78-681,558. PUB. 5-30-2006, FILED 7-29-2005.

CHOICE IS GOOD

THE MARK CONSISTS OF STANDARD CHARACTERS WITHOUT CLAIM TO ANY PARTICULAR FONT, STYLE, SIZE, OR COLOR.

CLASS 16—PAPER GOODS AND PRINTED MATTER

FOR PAPER GOODS AND PRINTED MATTER, NAMELY, STICKERS, CALENDARS, GREETING CARDS, POSTCARDS, POSTERS, AND STATIONERY (U.S. CLS. 2, 5, 22, 23, 29, 37, 38 AND 50).

FIRST USE 7-29-2005; IN COMMERCE 11-18-2005.

CLASS 25—CLOTHING

FOR CLOTHING AND HEADGEAR, NAMELY, T-SHIRTS, GOLF SHIRTS, SWEATSHIRTS, COATS, JACKETS, PULLOVERS, SOCKS, HATS, VISORS, AND HEADBANDS (U.S. CLS. 22 AND 39).

FIRST USE 7-29-2005; IN COMMERCE 11-18-2005.

3,178,620. WEICHERT CO., MORRIS PLAINS, NJ. SN 78-713,901. PUB. 6-13-2006, FILED 9-15-2005.



OWNER OF U.S. REG. NOS. 1,454,583, 2,800,891, AND 2,994,522.

NO CLAIM IS MADE TO THE EXCLUSIVE RIGHT TO USE "RELOCATION" AND "TRAVEL MANAGEMENT", APART FROM THE MARK AS SHOWN.

THE COLOR(S) YELLOW AND BLACK IS/ARE CLAIMED AS A FEATURE OF THE MARK.

THE SQUARE APPEARS IN THE COLOR YELLOW, THE TWO INTERSECTING ARCHES AND THE STYLIZED W APPEAR IN BLACK, AND THE WORDING WEICHERT, RELOCATION RESOURCES, AND TRAVEL MANAGEMENT APPEAR IN BLACK ALSO.

THE MARK CONSISTS OF A SQUARE CONTAINING TWO INTERSECTING ARCHES AND A STYLIZED W SHOWN ABOVE THE WORDING WEICHERT RELOCATION RESOURCES AND TO THE RIGHT OF THE SQUARE IS THE WORDING TRAVEL MANAGEMENT.

CLASS 35—ADVERTISING AND BUSINESS

FOR TRAVEL MANAGEMENT (U.S. CLS. 100, 101 AND 102).

FIRST USE 9-13-2005; IN COMMERCE 9-13-2005.

CLASS 39—TRANSPORTATION AND STORAGE

FOR GLOBAL TRAVEL AGENCY SERVICES, NAMELY MAKING RESERVATIONS AND BOOKINGS FOR TRANSPORTATION (U.S. CLS. 100 AND 105).

FIRST USE 9-13-2005; IN COMMERCE 9-13-2005.

CLASS 43—HOTEL AND RESTAURANT SERVICES

FOR GLOBAL TRAVEL AGENCY SERVICES, NAMELY MAKING RESERVATIONS AND BOOKINGS FOR TEMPORARY LODGING (U.S. CLS. 100 AND 101).

FIRST USE 9-13-2005; IN COMMERCE 9-13-2005.

3,178,658. SHARPER IMAGE CORPORATION, SAN FRANCISCO, CA. SN 78-976,631. PUB. 8-31-2004, FILED 11-10-2003.



INVENTED HERE.

CLASS 7—MACHINERY

FOR VACUUM CLEANER, ELECTRIC CAN OPENER, AUTOMATIC EYEGLASS CLEANER (U.S. CLS. 13, 19, 21, 23, 31, 34 AND 35).

FIRST USE 8-0-1998; IN COMMERCE 8-0-1998.

CLASS 8—HAND TOOLS

FOR PERSONAL GROOMING DEVICES, NAMELY ELECTRIC HAIR NOSE TRIMMER, ELECTRIC ION PRODUCING HAIR BRUSH, ELECTRIC MANICURE SETS, ELECTRIC SHAVER, CUTICLE SCISSORS, RAZORS, HAND OPERATED TOOLS, NAMELY, LEAF BLOWERS, AIR COMPRESSORS, HAND HELD VACS, AND MULTI PURPOSE STEAM CLEANERS, NON-ELECTRIC CAN OPENER (U.S. CLS. 23, 28 AND 44).

FIRST USE 8-0-1998; IN COMMERCE 8-0-1998.

CLASS 9—ELECTRICAL AND SCIENTIFIC APPARATUS

FOR CONSUMER ELECTRONIC PRODUCTS, NAMELY COMBINED DVD AND CD RADIO WITH ALARM CLOCK AND SOUND GENERATOR, COMBINED DVD AND CD RADIO WITH ALARM CLOCK, TEMPERATURE INDICATOR AND SOUND GENERATOR, COMBINED SHOWER CD RADIO WITH ALARM CLOCK, RADIO WITH SOUND GENERATOR, RADIO WITH ALARM CLOCK, SOUND GENERATOR, VIDEO CAMERA, VIDEO PLAYER, CD STEREO, RADIO, TV, HAND-HELD TV, WIRELESS WEATHER CENTER WITH CLOCK, NAMELY, AN INDOOR AND OUTDOOR SENSOR AND DISPLAY FOR TRANSMITTING TEMPERATURE AND WEATHER FORECAST, COMPRISING A CLOCK, TWO-WAY RECHARGEABLE RADIO, ULTRASONIC JEWELRY CLEANER IN THE NATURE OF AN ULTRASONIC SOUND EMITTING ELECTRONIC MACHINE, WIRELESS ELECTRONIC LOCATER, NAMELY A PORTABLE TRANSMITTER BASE AND OBJECT ATTACHABLE RECEIVERS, AUTOMATIC EYEGLASS CLEANING MACHINE, MOTORIZED CD STORAGE RACK, MOTORIZED PILL DISPENSER, DIGITAL CAMERA, DIGITAL ALCOHOL BREATH ANALYZER, WIRELESS INDOOR AND OUTDOOR THERMOMETER NOT FOR MEDICAL USE, ELECTRIC HAIR STRAIGHTENER, KITCHEN SCALE, ELECTRONIC SCALE, WIRELESS SECURITY CAMERA AND MONITOR, ELECTRIC INSECT-TRAPPING DEVICE, ELECTRONIC DOG TRAINING DEVICE, NAMELY, A DEVICE THAT DISPENSES TREATS UPON COMPLETION OF BEHAVIORAL TECHNIQUES COMPRISING DISPENSER AND TARGET, A HANDS-FREE CAR SPEAKER PHONE ADAPTOR FOR A CELL PHONE, ROBOT FOR PERSONAL USE, NAMELY, ROBOT VACUUM CLEANER, SCALE, ELECTRIC TIE RACK (U.S. CLS. 21, 23, 26, 36 AND 38).

FIRST USE 8-0-1998; IN COMMERCE 8-0-1998.

CLASS 11—ENVIRONMENTAL CONTROL APPARATUS

FOR ION GENERATING AIR PURIFIER, ION-GENERATING AIR CLEANER WITH A UV LAMP, AUTOMOBILE AIR PURIFIER, PERSONAL AIR PURIFIER; ION-PRODUCING HAIR PRODUCTS FOR DOMESTIC USE, NAMELY ION PRODUCING HAND HELD HAIR DRYERS; PERSONAL COOLING SYSTEM, NAMELY A PORTABLE EVAPORATIVE-COOLING SYSTEM WORN AROUND A NECK; ELECTRIC HOME PLUG-IN NIGHT LIGHT; FLASHLIGHT, BOOKLIGHT; ELECTRIC FAN, MINI ELECTRIC FAN; ELECTRIC NAIL CARE MANICURE SYSTEM COMPRISING A DRYER, A BUFFER, FILES AND A MINI FAN; COMBINATION ELECTRIC MINI-REFRIGERATORS AND WARMERS FOR COOLING AND WARMING FOODS AND BEVERAGES; LAMP, COMBINATION LANTERN WITH TV AND RADIO; ELECTRIC TOASTER; ELECTRIC COFFEE MAKER (U.S. CLS. 13, 21, 23, 31 AND 34).

FIRST USE 8-0-1998; IN COMMERCE 8-0-1998.

CLASS 14—JEWELRY

FOR DIGITAL ALARM CLOCK, ALARM CLOCK, LCD SCREEN ALARM CLOCK, WATCH, TRAVEL CLOCK (U.S. CLS. 2, 27, 28 AND 50).

FIRST USE 8-0-1998; IN COMMERCE 8-0-1998.

CLASS 21—HOUSEWARES AND GLASS

FOR BOTTLE OPENER, CORKSCREW, WINE AGITATOR, COFFEE POT NOT OF PRECIOUS METAL, ELECTRIC TOOTHBRUSH, COMB. ION-GENERATING HAIR BRUSH, ION-GENERATING PET BRUSH, WARM/COLD CUP HOLDER, INSECT TRAPS (U.S. CLS. 2, 13, 23, 29, 30, 33, 40 AND 50).

FIRST USE 8-0-1998; IN COMMERCE 8-0-1998.

3,178,659. TAGGIES, INC., SPENCER, MA. SN 78-977,150. PUB. 9-9-2003, FILED 1-13-2003.



OWNER OF U.S. REG. NOS. 2,581,453, 2,587,828, AND 2,668,388.

CLASS 16—PAPER GOODS AND PRINTED MATTER

FOR BOOKS, NAMELY CHILDREN'S BOOKS (U.S. CLS. 2, 5, 22, 23, 29, 37, 38 AND 50).

FIRST USE 7-25-2003; IN COMMERCE 7-25-2003.

CLASS 25—CLOTHING

FOR CLOTHING FOR INFANTS AND CHILDREN, NAMELY BOOTIES (U.S. CLS. 22 AND 39).

FIRST USE 11-1-2004; IN COMMERCE 11-1-2004.

CLASS 28—TOYS AND SPORTING GOODS

FOR TOYS, NAMELY PLUSH TOYS, SOFT TOYS, RATTLES, BABY RATTLES INCORPORATING TEE-THING RINGS, PLAY GYMS, PLAY BALLS WITH RIBBON LOOPS FOR INFANTS AND TODDLERS AND MUSICAL TOYS (U.S. CLS. 22, 23, 38 AND 50).
FIRST USE 2-10-2006; IN COMMERCE 2-10-2006.

CLASS 44—MEDICAL, BEAUTY AND AGRICULTURAL SERVICES

FOR PROVISION OF NON-MEDICAL NUTRITION ADVICE (U.S. CLS. 100 AND 101).
FIRST USE 11-17-2005; IN COMMERCE 11-17-2005.

3,178,665. FITBUG, LTD., LONDON NW1 8LH, UNITED KINGDOM. SN 78-977,552. PUB. 12-13-2005, FILED 12-23-2004.

3,178,669. SOUTHERN METHODIST UNIVERSITY, DALLAS, TX. SN 78-977,631. PUB. 6-21-2005, FILED 1-2-2004.

FITBUG

**HART
eCENTER
SMU**

THE MARK CONSISTS OF STANDARD CHARACTERS WITHOUT CLAIM TO ANY PARTICULAR FONT, STYLE, SIZE, OR COLOR.

THE MARK CONSISTS OF STANDARD CHARACTERS WITHOUT CLAIM TO ANY PARTICULAR FONT, STYLE, SIZE, OR COLOR.

NO CLAIM IS MADE TO THE EXCLUSIVE RIGHT TO USE "ECENTER", APART FROM THE MARK AS SHOWN.

CLASS 9—ELECTRICAL AND SCIENTIFIC APPARATUS

FOR FITNESS EQUIPMENT, NAMELY, Pedometers; COMPUTER DOCKING STATIONS ADAPTED TO RECEIVE ANY OF THE AFORESAID GOODS AND ALLOW COMMUNICATION OF ANY OF THE AFORESAID GOODS WITH AN ELECTRONIC DATA TRANSMISSION MEANS AND PARTS AND FITTINGS FOR THE AFORESAID GOODS (U.S. CLS. 21, 23, 26, 36 AND 38).
FIRST USE 11-17-2005; IN COMMERCE 11-17-2005.

CLASS 21—HOUSEWARES AND GLASS

FOR MUGS (U.S. CLS. 2, 13, 23, 29, 30, 33, 40 AND 50).
FIRST USE 9-0-2001; IN COMMERCE 9-0-2001.

CLASS 25—CLOTHING

FOR CLOTHING, NAMELY, SHIRTS (U.S. CLS. 22 AND 39).
FIRST USE 1-0-2001; IN COMMERCE 1-0-2001.

CLASS 41—EDUCATION AND ENTERTAINMENT

FOR PROVISION OF PHYSICAL FITNESS TRAINING SERVICES, NAMELY, PROVISION OF FITNESS TRAINING SERVICES VIA THE INTERNET; PERSONAL TRAINING SERVICES, NAMELY, STRENGTH AND CONDITIONING TRAINING (U.S. CLS. 100, 101 AND 107).
FIRST USE 11-17-2005; IN COMMERCE 11-17-2005.

CLASS 41—EDUCATION AND ENTERTAINMENT

FOR EDUCATIONAL SERVICES, NAMELY, PROVIDING TRAINING IN THE DESIGN AND ENGINEERING OF DIGITAL GAMES AND DIGITAL PROGRAMS (U.S. CLS. 100, 101 AND 107).
FIRST USE 1-0-2001; IN COMMERCE 1-0-2001.

* * * * *

SECTION 2.— INTERNATIONAL CLASSIFICATION

The short titles associated below with the international class numbers are terms designed merely for quick identification and are not an official part of the international classification. The full names of international classes are given in section 6.1 of the trademark rules of practice.

The designation "U.S. Cl." appearing in this section refers to the U.S. class in effect prior to Sep. 1, 1973 rather than the international class which applies to applications filed on or after that date. For adoption of international classification see notice in the OFFICIAL GAZETTE of Jun. 26, 1973 (911 O.G. TM 210).

Application in one class

CLASS 1—CHEMICALS

3,177,395. LEGACY INTERNATIONAL, ALBUQUERQUE, NM. SN 76-535,818. PUB. 6-1-2004, FILED 7-29-2003.

CLASS 1—(Continued).

3,177,585. ROOFING SUPPLY LIMITED, HOUSTON, TX. SN 76-977,645. PUB. 10-18-2005, FILED 6-11-2004.

A MODO MIO

A MODO MIO IS ITALIAN FOR "MY WAY". FOR CHEESE MAKING KITS CONSISTING PRIMARILY OF BACTERIAL CHEESE-MAKING CULTURE WITH LABELS, A WHISK AND RECIPES (U.S. CLS. 1, 5, 6, 10, 26 AND 46).
FIRST USE 6-1-2006; IN COMMERCE 6-1-2006.

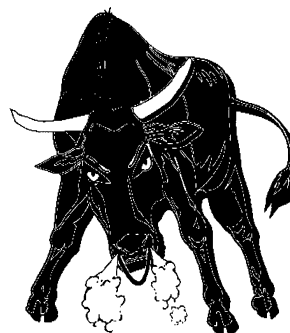

3,177,520. WORLD WIDE IMPORTS ENTERPRISES, INC., FT. LAUDERDALE, FL. SN 76-622,754. PUB. 11-15-2005, FILED 12-1-2004.

THE STIPPLING IS A FEATURE OF THE MARK. FOR ROOFING ADHESIVES (U.S. CLS. 1, 5, 6, 10, 26 AND 46).
FIRST USE 6-2-2004; IN COMMERCE 6-2-2004.

NATURAL LIVE CONCENTRATED OCEAN WATER

3,177,620. GLOBAL DEVELOPMENT CONSULTING CORPORATION, CHATSWORTH, CA. SN 78-170,075. PUB. 5-25-2004, FILED 10-2-2002.

THE MARK CONSISTS OF STANDARD CHARACTERS WITHOUT CLAIM TO ANY PARTICULAR FONT, STYLE, SIZE, OR COLOR.

NO CLAIM IS MADE TO THE EXCLUSIVE RIGHT TO USE "NATURAL" AND "CONCENTRATED OCEAN WATER", APART FROM THE MARK AS SHOWN.

FOR SALTWATER SOLUTIONS, NAMELY, SALTWATER AND CONCENTRATED SALTWATER FOR USE IN FILLING OR WATER CHANGES IN AQUARIUMS AND AQUATIC DISPLAYS (U.S. CLS. 1, 5, 6, 10, 26 AND 46).
FIRST USE 9-0-2003; IN COMMERCE 9-0-2003.

OK-11

FOR SOIL ADDITIVE, NAMELY, SULFONATED OIL FOR SOIL STABILIZATION (U.S. CLS. 1, 5, 6, 10, 26 AND 46).
FIRST USE 7-13-1996; IN COMMERCE 7-13-1996.

CLASS 1—(Continued).

3,177,630. GENERAL ELECTRIC COMPANY, SCHENECTADY, NY. SN 78-190,309. PUB. 10-21-2003, FILED 12-2-2002.

IMAGINATION AT WORK

FOR CHEMICALS FOR USE IN THE MANUFACTURE OF A WIDE VARIETY OF GOODS; UNPROCESSED ARTIFICIAL RESINS; SYNTHETIC RESINS; THERMOPLASTIC RESINS; ADHESIVES FOR GENERAL INDUSTRIAL USE; SILICONES FOR GENERAL INDUSTRIAL USE; EMULSIFIERS FOR USE IN THE MANUFACTURE OF FOOD, LEATHERS AND TEXTILES; NUCLEAR FISSIONABLE MATERIAL SUCH AS URANIUM, PLUTONIUM AND THORIUM COMPOUNDS (U.S. CLS. 1, 5, 6, 10, 26 AND 46).

FIRST USE 12-31-2004; IN COMMERCE 12-31-2004.

3,177,660. INNOVATIVE ADHESIVES COMPANY, KANSAS CITY, MO. SN 78-258,061. PUB. 5-17-2005, FILED 6-4-2003.

**INNOVATIVE ADHESIVES
COMPANY**

NO CLAIM IS MADE TO THE EXCLUSIVE RIGHT TO USE "ADHESIVES COMPANY", APART FROM THE MARK AS SHOWN.

FOR ADHESIVES FOR USE IN THE BUILDING CONSTRUCTION INDUSTRY (U.S. CLS. 1, 5, 6, 10, 26 AND 46).

FIRST USE 7-1-2003; IN COMMERCE 8-30-2004.

3,177,673. PREMA PRODUCTS, INC., NORTHVALE, NJ. SN 78-289,029. PUB. 6-7-2005, FILED 8-19-2003.

PREMA

FOR ADHESIVE, VULCANIZING AND HARDENING COMPOUNDS IN THE FORM OF LIQUIDS, PASTES, AND CEMENTS FOR THE REPAIR AND MAINTENANCE OF GOODS MADE OF UNVULCANIZED RUBBER, VULCANIZED RUBBER OR PLASTICS USED IN A VARIETY OF INDUSTRIES, AND FOR THE JOINING OF SUCH GOODS WITH OTHER PARTS MADE OF UNVULCANIZED RUBBER, VULCANIZED RUBBER, SYNTHETICS, METAL, CONCRETE, WOOD AND LEATHER; TIRE LUBRICANTS AND CHEMICALS, MOUNTING PASTES FOR VEHICLE TIRE RIMS; PRESSURIZED GAS CARTRIDGES FOR INFLATING VEHICLES TIRES AND INNER TUBES; REPAIR KITS FOR THE REPAIR AND MAINTENANCE OF GOODS MADE OF UNVULCANIZED RUBBER, VULCANIZED RUBBER OR PLASTICS COMPRISED OF ADHESIVE, VULCANIZING AND HARDENING COMPOUNDS IN THE FORM OF LIQUIDS, PASTES, AND CEMENTS, HAND OPERATED APPLICATOR TOOLS AND RUBBER PATCHES AND PLUGS (U.S. CLS. 1, 5, 6, 10, 26 AND 46).

FIRST USE 5-0-2004; IN COMMERCE 5-0-2004.

CLASS 1—(Continued).

3,177,744. II-VI INCORPORATED, SAXONBURG, PA. SN 78-363,151. PUB. 6-21-2005, FILED 2-5-2004.

Z-BOND

THE MARK CONSISTS OF STANDARD CHARACTERS WITHOUT CLAIM TO ANY PARTICULAR FONT, STYLE, SIZE, OR COLOR.

FOR EPOXY RESINS FOR RADIATION DETECTORS (U.S. CLS. 1, 5, 6, 10, 26 AND 46).

FIRST USE 7-31-2004; IN COMMERCE 7-31-2004.

3,177,794. HELENA HOLDING COMPANY, WILMINGTON, DE. SN 78-395,732. PUB. 1-18-2005, FILED 4-2-2004.

INJECTOR

THE MARK CONSISTS OF STANDARD CHARACTERS WITHOUT CLAIM TO ANY PARTICULAR FONT, STYLE, SIZE, OR COLOR.

FOR SOIL WETTING AGENT USED IN THE TURF MARKET (U.S. CLS. 1, 5, 6, 10, 26 AND 46).

FIRST USE 4-13-2005; IN COMMERCE 4-13-2005.

CLASS 1—(Continued).

3,177,798. BIO-ORGANIC CATALYST, INC., COSTA MESA, CA. SN 78-397,394. PUB. 9-13-2005, FILED 4-6-2004.



NO CLAIM IS MADE TO THE EXCLUSIVE RIGHT TO USE BIO-ORGANIC CATALYST, APART FROM THE MARK AS SHOWN.

FOR PATENTED BIO-ORGANIC CATALYTIC AGENTS, IN CONCENTRATED LIQUID FORMULATIONS, FOR CLEANING, WATER TREATMENT, HYDROCARBON REMEDIATION, AND ACCELERATION OF BIOLOGICAL AND CHEMICAL REACTION USES (U.S. CLS. 1, 5, 6, 10, 26 AND 46).
FIRST USE 10-6-2005; IN COMMERCE 10-6-2005.

CLASS 1—(Continued).

3,177,874. MILLIKEN & COMPANY, SPARTANBURG, SC. SN 78-440,850. PUB. 6-7-2005, FILED 6-24-2004.



FOR CHEMICAL ADDITIVE FOR USE IN THE MANUFACTURE OF PLASTIC CONTAINERS (U.S. CLS. 1, 5, 6, 10, 26 AND 46).

FIRST USE 1-20-2003; IN COMMERCE 1-20-2003.

3,177,852. GENETIC APPLICATIONS LLC, SAN DIEGO, CA. SN 78-430,657. PUB. 11-22-2005, FILED 6-6-2004.

Advantage

THE MARK CONSISTS OF STANDARD CHARACTERS WITHOUT CLAIM TO ANY PARTICULAR FONT, STYLE, SIZE, OR COLOR.

FOR REAGENTS FOR SCIENTIFIC OR MEDICAL RESEARCH USED FOR THE TRANSPORTATION OF BIOLOGICALLY ACTIVE AGENTS INTO CELLS, AND NOT FOR USE IN POLYMERASE CHAIN REACTION (PCR) OR IN PCR-RELATED PROCEDURES (U.S. CLS. 1, 5, 6, 10, 26 AND 46).
FIRST USE 6-1-2004; IN COMMERCE 9-24-2004.

3,178,108. CIBA SPECIALTY CHEMICALS CORPORATION, TARRYTOWN, NY. SN 78-535,497. PUB. 1-10-2006, FILED 12-20-2004.

NET-TECH

THE MARK CONSISTS OF STANDARD CHARACTERS WITHOUT CLAIM TO ANY PARTICULAR FONT, STYLE, SIZE, OR COLOR.

FOR CHEMICALS USED IN THE MANUFACTURE OF PAPER, NAMELY, WIRE AND FELT CLEANERS AND CONDITIONERS (U.S. CLS. 1, 5, 6, 10, 26 AND 46).
FIRST USE 7-31-2006; IN COMMERCE 7-31-2006.

CLASS 1—(Continued).

3,178,138. AURORA INNOVATIONS INC., EUGENE, OR. SN 78-549,855. PUB. 6-13-2006, FILED 1-19-2005.

ROOTS ORGANICS

THE MARK CONSISTS OF STANDARD CHARACTERS WITHOUT CLAIM TO ANY PARTICULAR FONT, STYLE, SIZE, OR COLOR.

NO CLAIM IS MADE TO THE EXCLUSIVE RIGHT TO USE "ORGANICS", APART FROM THE MARK AS SHOWN. FOR PLANT FOOD SUPPLEMENT FOR AGRICULTURE PRODUCTS AND OTHER PLANTS (U.S. CLS. 1, 5, 6, 10, 26 AND 46).

FIRST USE 6-1-2004; IN COMMERCE 12-15-2004.

3,178,198. RSA MICROTECH, LLC., MARYSVILLE, WA. SN 78-569,196. PUB. 1-24-2006, FILED 2-17-2005.

PENN WETTING

THE MARK CONSISTS OF STANDARD CHARACTERS WITHOUT CLAIM TO ANY PARTICULAR FONT, STYLE, SIZE, OR COLOR.

NO CLAIM IS MADE TO THE EXCLUSIVE RIGHT TO USE "WETTING", APART FROM THE MARK AS SHOWN. FOR SOIL CONDITIONER FOR USE IN AGRICULTURE (U.S. CLS. 1, 5, 6, 10, 26 AND 46).

FIRST USE 10-31-2005; IN COMMERCE 10-31-2005.

3,178,392. BAYER AKTIENGESELLSCHAFT, LEVERKUSEN-BAYERWERK, FED REP GERMANY. SN 78-611,700. PUB. 2-21-2006, FILED 4-19-2005.

PROXY

THE MARK CONSISTS OF STANDARD CHARACTERS WITHOUT CLAIM TO ANY PARTICULAR FONT, STYLE, SIZE, OR COLOR.

FOR PLANT GROWTH REGULATOR FOR USE IN THE TURF AND ORNAMENTAL MARKET (U.S. CLS. 1, 5, 6, 10, 26 AND 46).

FIRST USE 10-31-2004; IN COMMERCE 10-31-2004.

CLASS 1—(Continued).

3,178,395. IMERYS PIGMENTS, INC., ROSWELL, GA. SN 78-612,079. PUB. 1-17-2006, FILED 4-19-2005.

ARBORCARB

THE MARK CONSISTS OF STANDARD CHARACTERS WITHOUT CLAIM TO ANY PARTICULAR FONT, STYLE, SIZE, OR COLOR.

FOR CHEMICAL PREPARATIONS, NAMELY CALCIUM CARBONATES OR KAOLINS FOR USE AS FILLERS, EXTENDERS, PIGMENTS OR COATINGS IN THE PAPER, PAPERBOARD, PLASTICS, PAINT, AND VINYL INDUSTRIES (U.S. CLS. 1, 5, 6, 10, 26 AND 46).

FIRST USE 5-5-2005; IN COMMERCE 5-5-2005.

3,178,425. THE HARTZ MOUNTAIN CORPORATION, SECAUCUS, NJ. SN 78-625,829. PUB. 10-11-2005, FILED 5-9-2005.

WARDLEY WELLNESS FIN GUARD

THE MARK CONSISTS OF STANDARD CHARACTERS WITHOUT CLAIM TO ANY PARTICULAR FONT, STYLE, SIZE, OR COLOR.

OWNER OF U.S. REG. NOS. 579,502, 720,091, AND 2,236,068.

FOR WATER TREATMENT CHEMICALS AND CONDITIONERS FOR PONDS AND AQUARIUMS (U.S. CLS. 1, 5, 6, 10, 26 AND 46).

FIRST USE 9-1-2005; IN COMMERCE 9-1-2005.

3,178,543. FAIRWAY LAWNS, INC., LITTLE ROCK, AR. SN 78-672,444. PUB. 4-4-2006, FILED 7-18-2005.

FRONT NINE NUTRIENT BLEND

THE MARK CONSISTS OF STANDARD CHARACTERS WITHOUT CLAIM TO ANY PARTICULAR FONT, STYLE, SIZE, OR COLOR.

NO CLAIM IS MADE TO THE EXCLUSIVE RIGHT TO USE "NUTRIENT BLEND", APART FROM THE MARK AS SHOWN.

FOR PLANT FOOD (U.S. CLS. 1, 5, 6, 10, 26 AND 46).

FIRST USE 9-15-2006; IN COMMERCE 9-15-2006.

CLASS 1—(Continued).

3,178,574. HELENA HOLDING COMPANY, WILMINGTON, DE. SN 78-686,370. PUB. 1-10-2006, FILED 8-5-2005.

HYPERLINK

THE MARK CONSISTS OF STANDARD CHARACTERS WITHOUT CLAIM TO ANY PARTICULAR FONT, STYLE, SIZE, OR COLOR.

OWNER OF U.S. REG. NO. 2,084,332.
FOR FERTILIZERS FOR AGRICULTURAL USE (U.S. CLS. 1, 5, 6, 10, 26 AND 46).
FIRST USE 11-16-2005; IN COMMERCE 11-16-2005.

CLASS 2—(Continued).

3,178,267. SEDONA INVESTMENTS LTD., VANCOUVER, BRITISH COLUMBIA, CANADA. SN 78-584,556. PUB. 4-18-2006, FILED 3-10-2005.

PROTECT IT ALL

THE MARK CONSISTS OF STANDARD CHARACTERS WITHOUT CLAIM TO ANY PARTICULAR FONT, STYLE, SIZE, OR COLOR.

PRIORITY CLAIMED UNDER SEC. 44(D) ON CANADA APPLICATION NO. 1,249,695, FILED 3-7-2005, REG. NO. TMA656614, DATED 1-16-2006, EXPIRES 1-16-2021.
FOR EXTERIOR COATINGS, NAMELY, NATURAL OIL WOOD FINISH, DECK FINISH AND ROOF COATINGS IN THE NATURE OF PAINTS, EXTERIOR COATINGS NAMELY, ANTI-GRAFFITI INHIBITANTS, EXTERIOR COATINGS, NAMELY, CLEAR SEALERS FOR CONCRETE AND WOOD (U.S. CLS. 6, 11 AND 16).
FIRST USE 4-11-2005; IN COMMERCE 4-20-2005.

3,178,636. HALLIBURTON ENERGY SERVICES, INC., CARROLLTON, TX. SN 78-723,879. PUB. 6-6-2006, FILED 9-30-2005.

PHASERFRAC

THE MARK CONSISTS OF STANDARD CHARACTERS WITHOUT CLAIM TO ANY PARTICULAR FONT, STYLE, SIZE, OR COLOR.

FOR OIL AND GAS WELL FRACTURING FLUID (U.S. CLS. 1, 5, 6, 10, 26 AND 46).
FIRST USE 9-30-2005; IN COMMERCE 9-30-2005.

3,178,433. NOBLE GROUP LIMITED, HAMILTON, BERMUDA. SN 78-628,528. PUB. 1-31-2006, FILED 5-12-2005.

CLASS 2—PAINTS

3,178,046. NCP COATINGS, INC., NILES, MI. SN 78-505,763. PUB. 9-27-2005, FILED 10-26-2004.

DYNA SPEC**NOVANT**

THE MARK CONSISTS OF STANDARD CHARACTERS WITHOUT CLAIM TO ANY PARTICULAR FONT, STYLE, SIZE, OR COLOR.

FOR PAINT (U.S. CLS. 6, 11 AND 16).
FIRST USE 1-15-2004; IN COMMERCE 6-21-2004.

THE MARK CONSISTS OF STANDARD CHARACTERS WITHOUT CLAIM TO ANY PARTICULAR FONT, STYLE, SIZE, OR COLOR.

FOR ORGANIC AND INORGANIC COLORED PIGMENTS USED AS COLORANTS IN THE PRODUCTION OF INK, PAINTS AND PLASTICS (U.S. CLS. 6, 11 AND 16).
FIRST USE 3-18-2004; IN COMMERCE 3-18-2004.

CLASS 2—(Continued).

3,178,642. GAUGHEN HOLDINGS LLC, OXNARD, CA. SN 78-729,503. PUB. 6-6-2006, FILED 10-8-2005.

FRESH WALL

THE MARK CONSISTS OF STANDARD CHARACTERS WITHOUT CLAIM TO ANY PARTICULAR FONT, STYLE, SIZE, OR COLOR.

OWNER OF U.S. REG. NO. 3,054,599.

NO CLAIM IS MADE TO THE EXCLUSIVE RIGHT TO USE "WALL", APART FROM THE MARK AS SHOWN.

FOR PAINTS AND PROCESSED PAINT-LIKE RESIN PREPARATIONS, NAMELY, SINGLE COMPONENT OR TWO COMPONENT OR THREE COMPONENT COATINGS, WITH OR WITHOUT CONDUCTIVE FILLERS, STATIC DISSIPATIVE FILLERS, FLAKED GLASS, BACTERIOSTATS AND FUNGISTATS, FOR USE AS PRE-TREATMENT PRIMERS, PRIMERS, INTERMEDIATE COATINGS, BARRIER COATINGS, MASTICS, MARKINGS, TOPCOATS, AND FINISHES ON SURFACES CONSISTING OF METAL, PLASTIC, COMPOSITE, RUBBER, GLASS, CONCRETE, CEMENT, ASPHALT, AND WOOD, SUCH AS ON SHIPS, AIRCRAFT, VEHICLES, ENGINEERED STRUCTURES, STORAGE TANKS, BUILDINGS AND HOUSING (U.S. CLS. 6, 11 AND 16).

FIRST USE 6-16-2006; IN COMMERCE 6-19-2006.

CLASS 3—COSMETICS AND CLEANING PREPARATIONS

3,177,394. ROSENHAUS, STEVEN S., NEW YORK, NY. SN 76-534,991. PUB. 6-8-2004, FILED 7-24-2003.

EAU ZONE

THE ENGLISH TRANSLATION OF "EAU" IS "WATER". FOR WOMEN'S PERFUME; MEN'S AND WOMEN'S COLOGNE; AFTERSHAVE; NONE OF WHICH CONTAINS A SUNSCREEN OR TANNING INGREDIENT OR IS A SUNCARE PRODUCT (U.S. CLS. 1, 4, 6, 50, 51 AND 52).

FIRST USE 7-14-2006; IN COMMERCE 7-14-2006.

3,177,406. AMOREPACIFIC CORPORATION, SEOUL, REPUBLIC OF KOREA. SN 76-552,541. PUB. 12-13-2005, FILED 9-29-2003.

AMOREPACIFIC CONTOUR LIFT CREME FACE & NECK

OWNER OF U.S. REG. NO. 2,813,604.

NO CLAIM IS MADE TO THE EXCLUSIVE RIGHT TO USE "CONTOUR LIFT CREME FACE & NECK", APART FROM THE MARK AS SHOWN.

FOR NON-MEDICATED SKIN NOURISHING CREAMS WITH FIRING AND LIFTING EFFECT (U.S. CLS. 1, 4, 6, 50, 51 AND 52).

FIRST USE 7-26-2002; IN COMMERCE 9-9-2003.

CLASS 3—(Continued).

3,177,616. SARAMAR, L.L.C., CHICAGO, IL. SN 78-158,780. PUB. 12-16-2003, FILED 8-28-2002.



THE STIPPLING IS A FEATURE OF THE MARK.

FOR BLEACHING PREPARATIONS, HOUSEHOLD DETERGENTS, SOAPS AND SOFTENERS FOR LAUNDRY USE; CLEANING, POLISHING, SCOURING, DEGREASING AND ABRASIVE PREPARATIONS FOR HOUSEHOLD USE (U.S. CLS. 1, 4, 6, 50, 51 AND 52).

FIRST USE 1-10-2005; IN COMMERCE 1-10-2005.

3,177,627. DERMADOCTOR.COM, INC., KANSAS CITY, MO. SN 78-183,171. PUB. 2-3-2004, FILED 11-8-2002.

BORN TO BE MILD

FOR SKIN CARE PRODUCTS, NAMELY, A MEDICATED SOAP FOR FACE AND BODY (U.S. CLS. 1, 4, 6, 50, 51 AND 52).

FIRST USE 3-1-2005; IN COMMERCE 3-1-2005.

3,177,638. ORATECH, LC, SOUTH JORDAN, UT. SN 78-206,113. PUB. 7-6-2004, FILED 1-22-2003.

WHITE STICK

NO CLAIM IS MADE TO THE EXCLUSIVE RIGHT TO USE STICK, APART FROM THE MARK AS SHOWN.

FOR APPLICATOR PREFILLED WITH TOOTH WHITENING COMPOUND FOR HOUSEHOLD USE (U.S. CLS. 1, 4, 6, 50, 51 AND 52).

FIRST USE 6-13-2006; IN COMMERCE 6-13-2006.

CLASS 3—(Continued).

3,177,652. RIVER WEST BRANDS LLC, CHICAGO, IL. SN 78-248,671. PUB. 1-13-2004, FILED 5-12-2003.

BRUSHA, BRUSHA!

THE MARK CONSISTS OF STANDARD CHARACTERS WITHOUT CLAIM TO ANY PARTICULAR FONT, STYLE, SIZE, OR COLOR.

FOR TOOTHPASTE; TOOTH GEL; TOOTH POLISH; NON-MEDICATED MOUTHWASH AND GARGLE (U.S. CLS. 1, 4, 6, 50, 51 AND 52).

FIRST USE 10-10-2005; IN COMMERCE 10-10-2005.

3,177,669. COLGATE-PALMOLIVE COMPANY, NEW YORK, NY. SN 78-281,464. PUB. 7-13-2004, FILED 7-31-2003.

LATHER UP FOR GOOD HEALTH

OWNER OF U.S. REG. NO. 2,396,565.
FOR PERSONAL CARE PRODUCTS, NAMELY, SKIN CLEANSERS (U.S. CLS. 1, 4, 6, 50, 51 AND 52).
FIRST USE 3-31-2005; IN COMMERCE 3-31-2005.

3,177,679. LY, HUNG QUANG, PALMDALE, CA. SN 78-297,320. PUB. 9-27-2005, FILED 9-8-2003.

SHERI MARABOU

THE MARK DOES NOT IDENTIFY A PARTICULAR LIVING INDIVIDUAL.

FOR PERSONAL CARE PRODUCTS, NAMELY, AFTERSHAVE GELS AND LOTIONS, ANTIPERSPIRANT, ARTIFICIAL FINGERNAILS, ASTRINGENT FOR THE FACE AND ASTRINGENT FOR THE SKIN FOR COSMETIC PURPOSES, BATH OIL, BATH BEADS, NON-MEDICATED BATH SALTS, BLUSH, BODY GLITTER, BODY OIL, BODY SCRUB, BUBBLE BATH, COLOGNE, CREAM FOR THE BODY, CREAM FOR THE CUTICLES, CREAM FOR THE EYES, CREAM FOR THE FACE, CREAM FOR THE HANDS, DEODORANT, ESSENTIAL OILS FOR PERSONAL USE, EXFOLIATORS FOR THE SKIN, EYE GELS, EYE MAKEUP PENCILS, EYE SHADOW, FACE HIGHLIGHTER, FACIAL MASKS, FACE MIST, FACE SCRUB, NON-MEDICATED FOOT SOAK, FOUNDATION, FRAGRANT BODY SPLASH, FRAGRANT BODY MIST, HAIR CONDITIONER, HAIR DYES, HAIR GLITTER, HAIR HIGHLIGHTER, HAIR MASCARA, HAIR POMADE, HAIR RINSES, HAIR REMOVING CREAMS, HAIR SHAMPOO, HAIR SPRAY, HAIR STRAIGHTENER, HAIR STYLING GEL, HAIR STYLING MOUSSE, LOTION FOR THE BODY, LOTION FOR THE HANDS, LOTION FOR THE FACE, NON-MEDICATED LIP BALM, LIP GLOSS, LIP LINER, LIP MAKEUP PENCILS, LIPSTICK, MAKEUP FOR THE BODY, MAKEUP FOR THE FACE, MAKEUP REMOVER, MASCARA, NAIL CORRECTOR PENS, NAIL POLISH, NAIL POLISH REMOVER, NAIL STENCILS, NON-MEDICATED BLEMISH STICK, NON-MEDICATED CLEANSER FOR THE FACE, NON-MEDICATED FOOT SPRAY,

CLASS 3—(Continued).

NON-MEDICATED BLEMISH STICK, NON-MEDICATED CLEANSER FOR THE FACE, NON-MEDICATED FOOT SPRAY, NON-MEDICATED MOOD ENHANCING MASSAGE OINTMENT, NON-MEDICATED MOOD ENHANCING SKIN CREAM, OIL BLOTTING SHEETS FOR THE SKIN, PERFUME, POWDER FOR THE BODY, POWDER FOR THE FACE, POWDER FOR THE FEET, PUMICE STONES FOR PERSONAL USE, NON-MEDICATED SALT SCRUBS FOR THE SKIN, SHAVING CREAM, SHOWER GEL, SKIN BRONZING CREAM, SOAP FOR THE BODY, SOAP FOR THE FACE, SOAP FOR THE HANDS, SUN BLOCK FOR THE BODY, SUN BLOCK FOR THE FACE, SUNTAN LOTION FOR THE BODY, SUNTAN LOTION FOR THE FACE; SUNLESS TANNING LOTION FOR THE BODY, SUNLESS TANNING LOTION FOR THE FACE, PRE-SUN TANNING LOCATION FOR THE BODY, PRE-SUN TANNING LOTION FOR THE FACE, POST-SUN TANNING LOTION FOR THE FACE AND TALCUM POWER (U.S. CLS. 1, 4, 6, 50, 51 AND 52).

FIRST USE 9-8-2003; IN COMMERCE 1-1-2004.

3,177,691. FRUIT OF THE EARTH, INC., IRVING, TX. SN 78-310,524. PUB. 7-27-2004, FILED 10-7-2003.

BLOCK UP! FULL SPECTRUM

OWNER OF U.S. REG. NO. 2,177,139.
FOR SKIN CARE PRODUCTS, NAMELY CREAMS AND LOTIONS, SKIN MOISTURIZERS, SUNTAN LOTIONS, SUNSCREENS (U.S. CLS. 1, 4, 6, 50, 51 AND 52).
FIRST USE 1-0-2004; IN COMMERCE 1-0-2004.

3,177,716. THE PROCTER & GAMBLE COMPANY, CINCINNATI, OH. SN 78-340,198. PUB. 6-21-2005, FILED 12-12-2003.

HYDRA-DRENCH

THE MARK CONSISTS OF STANDARD CHARACTERS WITHOUT CLAIM TO ANY PARTICULAR FONT, STYLE, SIZE, OR COLOR.

FOR HAIR COLORING PREPARATIONS (U.S. CLS. 1, 4, 6, 50, 51 AND 52).

FIRST USE 5-1-2004; IN COMMERCE 5-1-2004.

CLASS 3—(Continued).

3,177,793. RECKITT BENCKISER INC., PARSIPPANY, NJ.
SN 78-394,570. PUB. 8-23-2005, FILED 4-1-2004.

STAINGUARD

THE MARK CONSISTS OF STANDARD CHARACTERS
WITHOUT CLAIM TO ANY PARTICULAR FONT, STYLE,
SIZE, OR COLOR.

FOR LAUNDRY BLEACH; LAUNDRY PREPARA-
TIONS, NAMELY LAUNDRY DETERGENT, CARPET
CLEANERS; DETERGENT SOAP; FABRIC SOFTENERS
FOR LAUNDRY USE, STAIN REMOVERS (U.S. CLS. 1, 4,
6, 50, 51 AND 52).

FIRST USE 1-3-2002; IN COMMERCE 1-3-2002.

3,177,837. ORLY INTERNATIONAL, INC., VAN NUYS, CA.
SN 78-422,466. PUB. 12-6-2005, FILED 5-20-2004.

Plum Cap

THE MARK CONSISTS OF STANDARD CHARACTERS
WITHOUT CLAIM TO ANY PARTICULAR FONT, STYLE,
SIZE, OR COLOR.

NO CLAIM IS MADE TO THE EXCLUSIVE RIGHT TO
USE "PLUM", APART FROM THE MARK AS SHOWN.

FOR NAIL CARE PREPARATIONS (U.S. CLS. 1, 4, 6,
50, 51 AND 52).

FIRST USE 6-1-2004; IN COMMERCE 7-15-2004.

CLASS 3—(Continued).

3,177,848. PHOENIX BRANDS LLC, STAMFORD, CT. SN 78-
428,462. PUB. 11-30-2004, FILED 6-2-2004.

SUNRISE FRESH

THE MARK CONSISTS OF STANDARD CHARACTERS
WITHOUT CLAIM TO ANY PARTICULAR FONT, STYLE,
SIZE, OR COLOR.

FOR LAUNDRY DETERGENT (U.S. CLS. 1, 4, 6, 50, 51
AND 52).

FIRST USE 8-1-2006; IN COMMERCE 8-1-2006.

3,177,907. DIAL BRANDS, INC., SCOTTSDALE, AZ. SN 78-
451,513. PUB. 6-21-2005, FILED 7-15-2004.

BRISA DEL PARAISO

THE MARK CONSISTS OF STANDARD CHARACTERS
WITHOUT CLAIM TO ANY PARTICULAR FONT, STYLE,
SIZE, OR COLOR.

OWNER OF U.S. REG. NO. 2,726,029.

THE ENGLISH TRANSLATION OF THE SPANISH
WORDING "BRISA DEL PARAISO" IS "PARADISE
BREEZE".

FOR LAUNDRY CARE PREPARATIONS, NAMELY,
LAUNDRY DETERGENTS, FABRIC SOFTENERS,
WRINKLE REDUCERS (U.S. CLS. 1, 4, 6, 50, 51 AND 52).

FIRST USE 8-1-2005; IN COMMERCE 8-1-2005.

3,177,973. CONOPCO, INC., GREENWICH, CT. SN 78-473,036.
PUB. 7-5-2005, FILED 8-25-2004.

**LOOK ON THE BRIGHT
SIDE**

THE MARK CONSISTS OF STANDARD CHARACTERS
WITHOUT CLAIM TO ANY PARTICULAR FONT, STYLE,
SIZE, OR COLOR.

FOR LAUNDRY DETERGENT, FABRIC SOFTENER
(U.S. CLS. 1, 4, 6, 50, 51 AND 52).

FIRST USE 9-1-2004; IN COMMERCE 9-1-2004.

CLASS 3—(Continued).

3,177,980. YANKEE CANDLE COMPANY, INC., THE, SOUTH DEERFIELD, MA. SN 78-475,631. PUB. 12-13-2005, FILED 8-30-2004.

CLASS 3—(Continued).

3,178,057. THE SHERWIN-WILLIAMS COMPANY, CLEVELAND, OH. SN 78-509,674. PUB. 3-14-2006, FILED 11-2-2004.

CLEAN COTTON

THE MARK CONSISTS OF STANDARD CHARACTERS WITHOUT CLAIM TO ANY PARTICULAR FONT, STYLE, SIZE, OR COLOR.

FOR FABRIC REFRESHENER, LAUNDRY DETERGENT, DISH WASHING DETERGENT AND HAND SOAP, BODY, AND HAND LOTION, CLEANSING SKIN GEL, ROOM FRAGRANCES; POTPOURRI; POTPOURRI REFRESHER OIL, ELECTRIC FRAGRANCE DISPENSER REFILLS, SACHETS; LINEN SPRAY; ALL PURPOSE CLEANING PREPARATIONS; SCENTED DISPOSABLE WIPES FOR HOUSEHOLD USE (U.S. CLS. 1, 4, 6, 50, 51 AND 52).

FIRST USE 7-2-2002; IN COMMERCE 7-23-2002.

MULTI-SPOT

THE MARK CONSISTS OF STANDARD CHARACTERS WITHOUT CLAIM TO ANY PARTICULAR FONT, STYLE, SIZE, OR COLOR.

FOR CLEANING PREPARATIONS IN THE NATURE OF CARPET CLEANERS AND SPOT AND STAIN REMOVERS (U.S. CLS. 1, 4, 6, 50, 51 AND 52).

FIRST USE 12-30-2005; IN COMMERCE 12-30-2005.

3,178,006. GA MODEFINE S.A., MENDRISIO, SWITZERLAND. SN 78-488,273. PUB. 2-21-2006, FILED 9-23-2004.

3,178,065. MARKWINS BEAUTY PRODUCTS, INC., CITY OF INDUSTRY, CA. SN 78-514,168. PUB. 9-6-2005, FILED 11-9-2004.

ARMANI / PRIVE

PRIORITY CLAIMED UNDER SEC. 44(D) ON SWITZERLAND APPLICATION NO. 56272/2004, FILED 9-16-2004, REG. NO. 528577, DATED 12-10-2004, EXPIRES 9-16-2014.

OWNER OF U.S. REG. NOS. 2,009,673, 2,922,864, AND OTHERS.

THE MARK CONSISTS OF THE TERMS ARMANI AND PRIVE SEPARATED BY A SLASH MARK. A BAR (OR STYLIZED ACCENT MARK) IS OVER THE LETTER E IN PRIVE.

THE ENGLISH TRANSLATION OF THE WORDING PRIVE IN THE MARK IS "PRIVATE".

FOR PERFUME, TOILET WATER; GELS, SALTS FOR THE BATH AND THE SHOWER NOT FOR MEDICAL PURPOSES; TOILET SOAPS, BODY DEODORANTS; COSMETICS NAMELY CREAMS, MILKS, LOTIONS, GELS AND POWDERS FOR THE FACE, THE BODY AND THE HANDS; SUN CARE COSMETIC PREPARATIONS; FOUNDATION MAKE-UP, COSMETIC PENCILS, ROUGES, LIPSTICKS, MASCARAS; ESSENTIAL OILS FOR PERSONAL USE (U.S. CLS. 1, 4, 6, 50, 51 AND 52).

FIRST USE 12-31-2004; IN COMMERCE 12-31-2004.

IDOL EYES

THE MARK CONSISTS OF STANDARD CHARACTERS WITHOUT CLAIM TO ANY PARTICULAR FONT, STYLE, SIZE, OR COLOR.

FOR COSMETICS, NAMELY, EYESHADOW PENCILS, EYEBROW PENCILS (U.S. CLS. 1, 4, 6, 50, 51 AND 52).

FIRST USE 1-15-2005; IN COMMERCE 1-15-2005.

CLASS 3—(Continued).

3,178,087. TARA'S DREAM LTD., GRAND CAYMAN, CAYMAN ISLANDS. SN 78-527,334. PUB. 12-6-2005, FILED 12-6-2004.

TARA WALKER'S DREAM

THE MARK CONSISTS OF STANDARD CHARACTERS WITHOUT CLAIM TO ANY PARTICULAR FONT, STYLE, SIZE, OR COLOR.

FOR SKIN CARE PRODUCTS, NAMELY NON-MEDICATED SKIN CREAMS, SKIN SERUMS, SKIN LOTIONS, AND SKIN CARE PREPARATIONS; AND PERFUME (U.S. CLS. 1, 4, 6, 50, 51 AND 52).

FIRST USE 7-31-2005; IN COMMERCE 7-31-2005.

3,178,119. DELICIOUS BRANDS, LLC, DALLAS, TX. SN 78-541,078. PUB. 9-27-2005, FILED 1-3-2005.

MOD SPA

THE MARK CONSISTS OF STANDARD CHARACTERS WITHOUT CLAIM TO ANY PARTICULAR FONT, STYLE, SIZE, OR COLOR.

NO CLAIM IS MADE TO THE EXCLUSIVE RIGHT TO USE "SPA", APART FROM THE MARK AS SHOWN.

FOR COSMETICS, TOILET PREPARATIONS AND FRAGRANCES, NAMELY— SKIN AND BODY LOTIONS, OILS AND CREAMS; HAND LOTIONS AND CREAMS; NON-MEDICATED FOOT LOTIONS AND CREAMS; MASSAGE OILS AND CREAMS; SKIN MASKS; SKIN EXFOLIANT LOTIONS AND CREAMS; HAIR SHAMPOOS AND CONDITIONERS; SHOWER GELS AND SCRUBS; BODY WASHES; BUBBLE BATHS; BATH OILS AND LOTIONS; BATH BEADS; SKIN AND TOILET SOAPS; BATH SALTS; BODY AND FACE MUDS; FACIAL CLEANSERS AND CREAMS; SHAVING CREAMS AND GELS (U.S. CLS. 1, 4, 6, 50, 51 AND 52).

FIRST USE 3-18-2005; IN COMMERCE 3-18-2005.

CLASS 3—(Continued).

3,178,162. MEMPHIS CONTRACT PACKAGING, INC., SOMERVILLE, TN. SN 78-559,665. PUB. 12-13-2005, FILED 2-3-2005.

DOUBLE PROTEIN

THE MARK CONSISTS OF STANDARD CHARACTERS WITHOUT CLAIM TO ANY PARTICULAR FONT, STYLE, SIZE, OR COLOR.

NO CLAIM IS MADE TO THE EXCLUSIVE RIGHT TO USE "PROTEIN", APART FROM THE MARK AS SHOWN.

FOR SKIN SOAPS, BODY SOAPS, FACE SOAPS, BATH SOAPS, ANTIBACTERIAL SOAPS, FACE, BODY AND SKIN SCRUBS AND CLEANSERS, ESSENTIAL OILS FOR PERSONAL USE, BATH OILS, MASSAGE OILS, SKIN, FACIAL, HAND AND BODY LOTIONS, CREAMS, AND MOISTURIZERS, NON-MEDICATED SKIN CARE PREPARATIONS, NON-MEDICATED SUN SCREEN PREPARATIONS, NON-MEDICATED SUN TANNING AND SUN ENHANCING PREPARATIONS; BATH PRODUCTS, NAMELY, BATH AND SHOWER GELS AND LIQUIDS, MILK BATHS, FOAM BATHS, BATH BODY WASHES, BUBBLE BATHS, BODY SPLASHES, BODY SPRAYS, AND BATH SALTS; AND NON-MEDICATED HAIR CARE PREPARATIONS (U.S. CLS. 1, 4, 6, 50, 51 AND 52).

FIRST USE 8-31-2005; IN COMMERCE 8-31-2005.

3,178,166. BLISS WORLD LLC, NEW YORK, NY. SN 78-561,081. PUB. 3-28-2006, FILED 2-4-2005.

wrinkle twinkle

THE MARK CONSISTS OF STANDARD CHARACTERS WITHOUT CLAIM TO ANY PARTICULAR FONT, STYLE, SIZE, OR COLOR.

NO CLAIM IS MADE TO THE EXCLUSIVE RIGHT TO USE "THE TERM WRINKLE", APART FROM THE MARK AS SHOWN.

FOR NON-MEDICATED LINE-REDUCING SERUM GEL FOR THE EYES, NON-MEDICATED WRINKLE-REDUCING SERUM, GEL FOR THE EYES (U.S. CLS. 1, 4, 6, 50, 51 AND 52).

FIRST USE 3-0-2006; IN COMMERCE 3-0-2006.

CLASS 3—(Continued).

3,178,187. THE PROCTER & GAMBLE COMPANY, CINCINNATI, OH. SN 78-566,924. PUB. 12-13-2005, FILED 2-14-2005.

LOTION RIBBONS

THE MARK CONSISTS OF STANDARD CHARACTERS WITHOUT CLAIM TO ANY PARTICULAR FONT, STYLE, SIZE, OR COLOR.

NO CLAIM IS MADE TO THE EXCLUSIVE RIGHT TO USE "LOTION", APART FROM THE MARK AS SHOWN. FOR BODY WASH (U.S. CLS. 1, 4, 6, 50, 51 AND 52). FIRST USE 1-23-2006; IN COMMERCE 1-23-2006.

3,178,216. AIRMAKEUP, INC., MARGATE, NJ. SN 78-572,886. PUB. 12-13-2005, FILED 2-23-2005.

SHOWER N' TAN

THE MARK CONSISTS OF STANDARD CHARACTERS WITHOUT CLAIM TO ANY PARTICULAR FONT, STYLE, SIZE, OR COLOR.

NO CLAIM IS MADE TO THE EXCLUSIVE RIGHT TO USE "TAN", APART FROM THE MARK AS SHOWN. FOR TANNING LOTION (U.S. CLS. 1, 4, 6, 50, 51 AND 52). FIRST USE 12-1-2005; IN COMMERCE 12-1-2005.

CLASS 3—(Continued).

3,178,280. HENKEL KGAA, DUESSELDORF, FED REP GERMANY. SN 78-586,743. PUB. 12-20-2005, FILED 3-14-2005.



FOR NON-MEDICATED SKIN CARE PREPARATIONS (U.S. CLS. 1, 4, 6, 50, 51 AND 52). FIRST USE 3-10-2004; IN COMMERCE 3-10-2004.

3,178,317. BORYUNG MEDIENCE CO., LTD., CHONGRO-KU, SEOUL, REPUBLIC OF KOREA. SN 78-592,671. PUB. 12-20-2005, FILED 3-22-2005.

Dr. atomild

THE MARK CONSISTS OF STANDARD CHARACTERS WITHOUT CLAIM TO ANY PARTICULAR FONT, STYLE, SIZE, OR COLOR.

THE NAME IN THE MARK DOES NOT IDENTIFY A PARTICULAR LIVING INDIVIDUAL.

FOR FABRIC SOFTENERS FOR LAUNDRY; BABY OILS; BABY POWDERS; CLEANSERS FOR DETERGENT PURPOSES, NAMELY, DETERGENT SOAPS, DISH DETERGENT AND LAUNDRY DETERGENT; BABY LOTIONS; SKIN CLEANSING CREAM; BATH SOAPS; SHAMPOOS; LAUNDRY SOAPS; COTTON STICKS FOR COSMETIC PURPOSES; HAND CREAMS; SUNSCREEN CREAMS; DENTIFRICES; BATH OIL; FOUNDATION CREAMS; HAIR LOTIONS (U.S. CLS. 1, 4, 6, 50, 51 AND 52).

FIRST USE 5-16-2003; IN COMMERCE 9-10-2004.

CLASS 3—(Continued).

3,178,342. KAO KABUSHIKI KAISHA, TA KAO CORPORATION, CHUO-KU, TOKYO, JAPAN. SN 78-597,164. PUB. 12-27-2005, FILED 3-29-2005.

CLASS 3—(Continued).

3,178,344. KAO KABUSHIKI KAISHA, TA KAO CORPORATION, CHUO-KU, TOKYO, JAPAN. SN 78-597,177. PUB. 12-20-2005, FILED 3-29-2005.

BIG FINISH

THE MARK CONSISTS OF STANDARD CHARACTERS WITHOUT CLAIM TO ANY PARTICULAR FONT, STYLE, SIZE, OR COLOR.
FOR HAIR CARE PREPARATIONS (U.S. CLS. 1, 4, 6, 50, 51 AND 52).
FIRST USE 7-1-2006; IN COMMERCE 7-1-2006.

HARDLINER

THE MARK CONSISTS OF STANDARD CHARACTERS WITHOUT CLAIM TO ANY PARTICULAR FONT, STYLE, SIZE, OR COLOR.
FOR HAIR CARE PREPARATIONS (U.S. CLS. 1, 4, 6, 50, 51 AND 52).
FIRST USE 7-1-2006; IN COMMERCE 7-1-2006.

3,178,343. KAO KABUSHIKI KAISHA, TA KAO CORPORATION, CHUO-KU, TOKYO, JAPAN. SN 78-597,168. PUB. 12-27-2005, FILED 3-29-2005.

3,178,345. KAO KABUSHIKI KAISHA, TA KAO CORPORATION, CHUO-KU, TOKYO, JAPAN. SN 78-597,179. PUB. 12-20-2005, FILED 3-29-2005.

COMPOSER

THE MARK CONSISTS OF STANDARD CHARACTERS WITHOUT CLAIM TO ANY PARTICULAR FONT, STYLE, SIZE, OR COLOR.
FOR HAIR CARE PREPARATIONS (U.S. CLS. 1, 4, 6, 50, 51 AND 52).
FIRST USE 7-1-2006; IN COMMERCE 7-1-2006.

HOT DARLING

THE MARK CONSISTS OF STANDARD CHARACTERS WITHOUT CLAIM TO ANY PARTICULAR FONT, STYLE, SIZE, OR COLOR.
FOR HAIR CARE PREPARATIONS (U.S. CLS. 1, 4, 6, 50, 51 AND 52).
FIRST USE 7-1-2006; IN COMMERCE 7-1-2006.

CLASS 3—(Continued).

3,178,346. KAO KABUSHIKI KAISHA, TA KAO CORPORATION, CHUO-KU, TOKYO, JAPAN. SN 78-597,180. PUB. 12-20-2005, FILED 3-29-2005.

FLAT MARVEL

THE MARK CONSISTS OF STANDARD CHARACTERS WITHOUT CLAIM TO ANY PARTICULAR FONT, STYLE, SIZE, OR COLOR.

NO CLAIM IS MADE TO THE EXCLUSIVE RIGHT TO USE "FLAT", APART FROM THE MARK AS SHOWN.

FOR HAIR CARE PREPARATIONS (U.S. CLS. 1, 4, 6, 50, 51 AND 52).

FIRST USE 7-1-2006; IN COMMERCE 7-1-2006.

CLASS 3—(Continued).

3,178,424. THE PROCTER & GAMBLE COMPANY, CINCINNATI, OH. SN 78-625,276. PUB. 1-31-2006, FILED 5-9-2005.

FRESAS DIVERTIDAS

THE MARK CONSISTS OF STANDARD CHARACTERS WITHOUT CLAIM TO ANY PARTICULAR FONT, STYLE, SIZE, OR COLOR.

NO CLAIM IS MADE TO THE EXCLUSIVE RIGHT TO USE FRESAS, APART FROM THE MARK AS SHOWN.

THE FOREIGN WORDING IN THE MARK TRANSLATES INTO ENGLISH AS AMUSED STRAWBERRIES.

FOR STRAWBERRY SCENTED PRODUCTS, NAMELY, DISPOSABLE IMPREGNATED WIPES FOR PERSONAL CLEANSING PURPOSES, LIQUID HAND SOAP, SHAMPOO (U.S. CLS. 1, 4, 6, 50, 51 AND 52).

FIRST USE 1-9-2006; IN COMMERCE 1-9-2006.

3,178,348. SHISEIDO COMPANY, LTD., TOKYO, JAPAN. SN 78-598,245. PUB. 12-27-2005, FILED 3-30-2005.

**CONCEALER
PERFECTION**

THE MARK CONSISTS OF STANDARD CHARACTERS WITHOUT CLAIM TO ANY PARTICULAR FONT, STYLE, SIZE, OR COLOR.

OWNER OF U.S. REG. NO. 2,931,111.

NO CLAIM IS MADE TO THE EXCLUSIVE RIGHT TO USE "CONCEALER", APART FROM THE MARK AS SHOWN.

FOR NON-MEDICATED SKIN CARE PREPARATIONS; HAIR CARE PREPARATIONS; BODY CARE PRODUCTS, NAMELY, BODY SOAPS, BODY CREAMS, BODY LOTIONS, BODY POWDERS, NON-MEDICATED DEODORANTS AND ANTI-PERSPIRANTS; NON-MEDICATED SUNCARE PRODUCTS, NAMELY, SUNSCREEN, SUN BLOCK AND SUN TANNING PREPARATIONS; PREPARATIONS TO PROTECT THE SKIN FROM THE SUN; NAMELY, NON-MEDICATED SUN CREAMS AND NON-MEDICATED AFTER-SUN LOTIONS; BATH PRODUCTS, NAMELY, BATH BEADS, BATH FOAM, BATH GELS, BATH LOTION, BATH OIL, BATH POWDER, AND NON-MEDICATED BATH SALTS; PERFUME, COLOGNE, COSMETICS AND MAKEUP (U.S. CLS. 1, 4, 6, 50, 51 AND 52).

FIRST USE 11-1-2005; IN COMMERCE 11-1-2005.

3,178,442. MARKWINS BEAUTY PRODUCTS, INC., CITY OF INDUSTRY, CA. SN 78-631,757. PUB. 2-21-2006, FILED 5-17-2005.

WHAT ARE YOU WILD ABOUT?

THE MARK CONSISTS OF STANDARD CHARACTERS WITHOUT CLAIM TO ANY PARTICULAR FONT, STYLE, SIZE, OR COLOR.

FOR COSMETICS, NAMELY, EYE SHADOW, EYE SHADOW CREAMS, EYELINERS, MASCARA, EYE PENCILS, EYEBROW PENCILS, BLUSH, LIQUID BLUSH, ROUGE, BODY POWDER, FACE POWDER, LIPSTICKS, LIP COLORS, LIP GLOSS, LIP LINERS, NON-MEDICATED LIP BALMS, LIP PENCILS, NAIL POLISH AND ENAMEL, COSMETIC COMPACTS CONTAINING EYE SHADOW, EYE SHADOW CREAMS, EYELINERS, MASCARA, EYE PENCILS, EYEBROW PENCILS, BLUSH, LIQUID BLUSH, ROUGE, BODY POWDER, FACE POWDER, LIPSTICKS, LIP COLORS, LIP GLOSS, LIP LINERS, NON-MEDICATED LIP BALMS, AND LIP PENCILS; MAKEUP BASES AND FOUNDATIONS; MAKEUP REMOVERS; LIQUID BODY GLITTER; BODY GLITTER POWDER; BODY SHIMMER; BODY CRAYON; SKIN MOISTURIZERS; NAIL CARE PREPARATIONS, NAMELY, NAIL VARNISH, NAIL VARNISH REMOVER; NAIL CONDITIONER; COSMETIC GIFT SETS COMPRISED OF COSMETIC BAGS AND COSMETIC CASES CONTAINING COSMETICS; EMERY BOARDS (U.S. CLS. 1, 4, 6, 50, 51 AND 52).

FIRST USE 7-1-2005; IN COMMERCE 7-1-2005.

CLASS 3—(Continued).

3,178,446. REVLON CONSUMER PRODUCTS CORPORATION, NEW YORK, NY. SN 78-632,466. PUB. 1-31-2006, FILED 5-18-2005.

CLASS 3—(Continued).

3,178,540. LEVLAD, INCORPORATED, CHATSWORTH, CA. SN 78-670,860. PUB. 4-4-2006, FILED 7-14-2005.

SOFTFLEX

THE MARK CONSISTS OF STANDARD CHARACTERS WITHOUT CLAIM TO ANY PARTICULAR FONT, STYLE, SIZE, OR COLOR.

OWNER OF U.S. REG. NOS. 787,922, 2,629,577, AND OTHERS.

FOR COSMETICS AND MAKEUP (U.S. CLS. 1, 4, 6, 50, 51 AND 52).

FIRST USE 11-14-2005; IN COMMERCE 11-14-2005.

REPLENIPLEX

THE MARK CONSISTS OF STANDARD CHARACTERS WITHOUT CLAIM TO ANY PARTICULAR FONT, STYLE, SIZE, OR COLOR.

FOR COSMETICS (U.S. CLS. 1, 4, 6, 50, 51 AND 52).

FIRST USE 9-0-2005; IN COMMERCE 9-0-2005.

3,178,448. AVON PRODUCTS, INC., NEW YORK, NY. SN 78-633,805. PUB. 2-7-2006, FILED 5-20-2005.

3,178,551. RECKITT BENCKISER INC., PARSIPPANY, NJ. SN 78-675,273. PUB. 5-16-2006, FILED 7-21-2005.

DARING DEFINITION

THE MARK CONSISTS OF STANDARD CHARACTERS WITHOUT CLAIM TO ANY PARTICULAR FONT, STYLE, SIZE, OR COLOR.

FOR COSMETICS, NAMELY, MASCARA (U.S. CLS. 1, 4, 6, 50, 51 AND 52).

FIRST USE 1-26-2006; IN COMMERCE 1-26-2006.

YES

3,178,477. M.D. INTENSIVE, COSTA MESA, CA. SN 78-647,724. PUB. 3-7-2006, FILED 6-9-2005.

THE MARK CONSISTS OF STANDARD CHARACTERS WITHOUT CLAIM TO ANY PARTICULAR FONT, STYLE, SIZE, OR COLOR.

OWNER OF U.S. REG. NOS. 1,084,450, 1,106,439, AND 1,181,761.

FOR BLEACHING PREPARATIONS FOR LAUNDRY USE IN LIQUID OR POWDER FORM; LAUNDRY DETERGENTS; LAUNDRY SOLVENTS AND FLUIDS FOR DRY CLEANING; CLEANING PREPARATIONS FOR LAUNDRY USE; CARPET CLEANERS; CARPET SHAMPOOS, DETERGENTS SOAPS; FABRIC SOFTENERS IN LIQUID OR POWDER FORM FOR USE IN CLOTHES WASHING MACHINES; ANTI-STATIC DRYER SHEETS AND FABRIC SOFTENER FOR USE IN CLOTHES DRYERS; FABRIC FINISH FOR USE DURING IRONING TO RESTORE BODY WITHOUT STIFFNESS; IRONING STARCH; LAUNDRY ADDITIVES, NAMELY, STAIN REMOVING PREPARATIONS (U.S. CLS. 1, 4, 6, 50, 51 AND 52).

FIRST USE 8-1-2005; IN COMMERCE 8-1-2005.

Nano REMAKE

THE MARK CONSISTS OF STANDARD CHARACTERS WITHOUT CLAIM TO ANY PARTICULAR FONT, STYLE, SIZE, OR COLOR.

FOR COSMETIC CREAMS FOR SKIN CARE (U.S. CLS. 1, 4, 6, 50, 51 AND 52).

FIRST USE 9-1-2005; IN COMMERCE 1-1-2006.

CLASS 3—(Continued).

3,178,557. DIAL BRANDS, INC., SCOTTSDALE, AZ. SN 78-676,352. PUB. 5-2-2006, FILED 7-22-2005.

FULL FORCE

THE MARK CONSISTS OF STANDARD CHARACTERS WITHOUT CLAIM TO ANY PARTICULAR FONT, STYLE, SIZE, OR COLOR.

FOR LAUNDRY CARE PREPARATIONS, NAMELY, LAUNDRY DETERGENT, FABRIC SOFTENER, STAIN REMOVERS, FABRIC BLEACH; PERSONAL CARE PRODUCTS, NAMELY, BAR SOAP, LIQUID HAND SOAP, BODY WASH, HAND AND BODY LOTION, ANTIPERSPIRANTS AND DEODORANTS, SHAMPOO AND CONDITIONER, BODY BUTTER, FACIAL LOTION, BODY SPRAY, BODY EXFOLIATORS, PRE-MOISTENED BODY AND FACIAL CLEANSING WIPES, SHAVING GEL, SHAVING LOTION; ALL-PURPOSE HOUSEHOLD CLEANERS, TOILET BOWL CLEANERS, GLASS CLEANERS, HARD SURFACE CLEANERS (U.S. CLS. 1, 4, 6, 50, 51 AND 52).

FIRST USE 1-15-2006; IN COMMERCE 1-15-2006.

3,178,561. PUREOLOGY RESEARCH, LLC, IRVINE, CA. SN 78-678,402. PUB. 4-25-2006, FILED 7-26-2005.

REALCURL

THE MARK CONSISTS OF STANDARD CHARACTERS WITHOUT CLAIM TO ANY PARTICULAR FONT, STYLE, SIZE, OR COLOR.

FOR HAIR CARE AND HAIR STYLING PRODUCTS, NAMELY, HAIR STYLING GEL (U.S. CLS. 1, 4, 6, 50, 51 AND 52).

FIRST USE 9-22-2005; IN COMMERCE 9-22-2005.

3,178,562. ECOLAB INC., ST. PAUL, MN. SN 78-678,819. PUB. 4-11-2006, FILED 7-26-2005.

BAR CHOICE

THE MARK CONSISTS OF STANDARD CHARACTERS WITHOUT CLAIM TO ANY PARTICULAR FONT, STYLE, SIZE, OR COLOR.

NO CLAIM IS MADE TO THE EXCLUSIVE RIGHT TO USE "BAR", APART FROM THE MARK AS SHOWN.

FOR DISHWASHING DETERGENTS (U.S. CLS. 1, 4, 6, 50, 51 AND 52).

FIRST USE 1-31-2006; IN COMMERCE 1-31-2006.

CLASS 3—(Continued).

3,178,577. FISCHER PHARMACEUTICALS LTD., TEL-AVIV, ISRAEL. SN 78-689,841. PUB. 4-25-2006, FILED 8-10-2005.

ULTRALACTIN

THE MARK CONSISTS OF STANDARD CHARACTERS WITHOUT CLAIM TO ANY PARTICULAR FONT, STYLE, SIZE, OR COLOR.

FOR SKIN MOISTURIZER (U.S. CLS. 1, 4, 6, 50, 51 AND 52).

FIRST USE 8-10-2005; IN COMMERCE 8-10-2005.

3,178,579. AVEDA CORPORATION, MINNEAPOLIS, MN. SN 78-690,693. PUB. 5-16-2006, FILED 8-11-2005.

PHINISH

THE MARK CONSISTS OF STANDARD CHARACTERS WITHOUT CLAIM TO ANY PARTICULAR FONT, STYLE, SIZE, OR COLOR.

FOR HAIR CARE CREAMS; HAIR CARE LOTIONS; HAIR CARE PREPARATIONS; HAIR CLEANING PREPARATIONS; HAIR CONDITIONER; HAIR CONDITIONERS; HAIR CREAMS; HAIR LOTIONS; HAIR SHAMPOO (U.S. CLS. 1, 4, 6, 50, 51 AND 52).

FIRST USE 3-31-2006; IN COMMERCE 3-31-2006.

3,178,639. L'OREAL USA CREATIVE, INC., NEW YORK, NY. SN 78-725,906. PUB. 5-30-2006, FILED 10-4-2005.

SHADOW STYLIST

THE MARK CONSISTS OF STANDARD CHARACTERS WITHOUT CLAIM TO ANY PARTICULAR FONT, STYLE, SIZE, OR COLOR.

NO CLAIM IS MADE TO THE EXCLUSIVE RIGHT TO USE "SHADOW", APART FROM THE MARK AS SHOWN.

FOR EYE SHADOW (U.S. CLS. 1, 4, 6, 50, 51 AND 52).

FIRST USE 6-1-2006; IN COMMERCE 6-1-2006.

CLASS 3—(Continued).

3,178,661. ROLCO BIANIL S.A., ATHENS, GREECE. SN 78-977,437. PUB. 10-11-2005, FILED 10-11-2002.

TACT

FOR SHOWER GEL, NON-MEDICATED BATH SALTS, HAIR SHAMPOO AND HAIR CONDITIONER (U.S. CLS. 1, 4, 6, 50, 51 AND 52).
FIRST USE 12-2-2004; IN COMMERCE 12-2-2004.

CLASS 4—LUBRICANTS AND FUELS

3,177,917. CALIFORNIA FRAGRANCE COMPANY, INC., HUNTINGTON STATION, NY. SN 78-456,236. PUB. 6-21-2005, FILED 7-25-2004.

REAL SPA

THE MARK CONSISTS OF STANDARD CHARACTERS WITHOUT CLAIM TO ANY PARTICULAR FONT, STYLE, SIZE, OR COLOR.
FOR CANDLES (U.S. CLS. 1, 6 AND 15).
FIRST USE 7-15-2004; IN COMMERCE 7-15-2004.

CLASS 5—PHARMACEUTICALS

3,177,385. BIO SAN LABORATORIES, INC., DERRY, NH. SN 76-515,278. PUB. 10-4-2005, FILED 5-19-2003.

MAXIMUM FOOD

FOR NUTRITIONAL DIETARY SUPPLEMENTS CONTAINING NATURAL ENZYMES (U.S. CLS. 6, 18, 44, 46, 51 AND 52).
FIRST USE 8-18-2003; IN COMMERCE 9-29-2003.

3,177,386. BIO SAN LABORATORIES, INC., DERRY, NH. SN 76-515,279. PUB. 12-27-2005, FILED 5-19-2003.

**MAXIMUM FOOD
FORMULAS****CLASS 5—(Continued).**

NO CLAIM IS MADE TO THE EXCLUSIVE RIGHT TO USE FORMULA, APART FROM THE MARK AS SHOWN.
FOR NUTRITIONAL DIETARY SUPPLEMENTS CONTAINING NATURAL ENZYMES (U.S. CLS. 6, 18, 44, 46, 51 AND 52).
FIRST USE 8-18-2003; IN COMMERCE 9-29-2003.

3,177,387. BIO SAN LABORATORIES, INC., DERRY, NH. SN 76-515,289. PUB. 10-4-2005, FILED 5-19-2003.

THYROID STRENGTH

NO CLAIM IS MADE TO THE EXCLUSIVE RIGHT TO USE THYROID, APART FROM THE MARK AS SHOWN.
FOR NUTRITIONAL DIETARY SUPPLEMENTS NAMELY NUTRICEUTICALS WHICH CONTAIN NATURAL ENZYMES (U.S. CLS. 6, 18, 44, 46, 51 AND 52).
FIRST USE 3-21-2005; IN COMMERCE 3-21-2005.

3,177,388. BIOMIMETIC THERAPEUTICS, INC., FRANKLIN, TN. SN 76-515,878. PUB. 6-22-2004, FILED 5-21-2003.

GEM OS

NO CLAIM IS MADE TO THE EXCLUSIVE RIGHT TO USE "OS", APART FROM THE MARK AS SHOWN.
FOR GROWTH FACTOR ENHANCED PHARMACEUTICAL PREPARATIONS FOR THE TREATMENT OF ORTHOPEDIC RELATED BONE AND SOFT TISSUE DEFECTS OR INJURIES SUCH AS OSTEOPOROTIC FRACTURES, SPORTS RELATED INJURIES, AND OTHER ORTHOPEDIC INDICATIONS (U.S. CLS. 6, 18, 44, 46, 51 AND 52).
FIRST USE 8-22-2006; IN COMMERCE 8-22-2006.

3,177,451. VEDALIFE, INC., LANCASTER, NY. SN 76-600,346. PUB. 6-14-2005, FILED 7-1-2004.

VEDALYTE

THE MARK CONSISTS OF STANDARD CHARACTERS WITHOUT CLAIM TO ANY PARTICULAR FONT, STYLE, SIZE, OR COLOR.
FOR NATURAL ENERGY POTASSIUM DRINK (U.S. CLS. 6, 18, 44, 46, 51 AND 52).
FIRST USE 10-20-2004; IN COMMERCE 10-20-2004.

3,177,481. KURARAY CO., LTD., OKAYAMA PREFECTURE, JAPAN. SN 76-610,058. PUB. 1-3-2006, FILED 9-3-2004.

CLEARFIL S³ BOND

CLASS 5—(Continued).

NO CLAIM IS MADE TO THE EXCLUSIVE RIGHT TO USE BOND, APART FROM THE MARK AS SHOWN.

FOR DENTAL MATERIALS, NAMELY, DENTAL ABRASIVES, DENTAL ADHESION PRIMER, DENTAL ADHESIVES, DENTAL AMALGAMS, DENTAL BONDING AGENTS, DENTAL CEMENTS, DENTAL IMPRESSION MATERIALS, DENTAL LACQUERS, DENTAL MASTICS, DENTAL PIT AND FISSURE SEALANT, DENTAL RESTORATIVE COMPOUNDS, DENTAL WAX, TEETH FILLING MATERIALS, POLYMER AND RESIN FOR DENTAL PURPOSES, MATERIALS FOR STOPPING TEETH (U.S. CLS. 6, 18, 44, 46, 51 AND 52).
FIRST USE 3-1-2005; IN COMMERCE 3-1-2005.

3,177,482. KURARAY CO., LTD., OKAYAMA PREFECTURE, JAPAN. SN 76-610,059. PUB. 1-3-2006, FILED 9-3-2004.

CLEARFIL TRI-S BOND

THE MARK CONSISTS OF STANDARD CHARACTERS WITHOUT CLAIM TO ANY PARTICULAR FONT, STYLE, SIZE, OR COLOR.

NO CLAIM IS MADE TO THE EXCLUSIVE RIGHT TO USE BOND, APART FROM THE MARK AS SHOWN.

FOR DENTAL MATERIALS, NAMELY, DENTAL ABRASIVES, DENTAL ADHESION PRIMER, DENTAL ADHESIVES, DENTAL AMALGAMS, DENTAL BONDING AGENTS, DENTAL CEMENTS, DENTAL IMPRESSION MATERIALS, DENTAL LACQUERS, DENTAL MASTICS, DENTAL PIT AND FISSURE SEALANT, DENTAL RESTORATIVE COMPOUNDS, DENTAL WAX, TEETH FILLING MATERIALS, POLYMER AND RESIN FOR DENTAL PURPOSES, MATERIALS FOR STOPPING TEETH (U.S. CLS. 6, 18, 44, 46, 51 AND 52).
FIRST USE 3-1-2005; IN COMMERCE 3-1-2005.

3,177,523. SULTAN CHEMISTS, INC., ENGLEWOOD, NJ. SN 76-624,763. PUB. 3-28-2006, FILED 12-17-2004.

GENIE MAGIC MIX

THE MARK CONSISTS OF STANDARD CHARACTERS WITHOUT CLAIM TO ANY PARTICULAR FONT, STYLE, SIZE, OR COLOR.

NO CLAIM IS MADE TO THE EXCLUSIVE RIGHT TO USE "MIX", APART FROM THE MARK AS SHOWN.

FOR VINYL POLYSILOXANE DENTAL IMPRESSION MATERIAL (U.S. CLS. 6, 18, 44, 46, 51 AND 52).
FIRST USE 11-30-2004; IN COMMERCE 11-30-2004.

CLASS 5—(Continued).

3,177,552. FISCHER PHARMACEUTICALS LTD., TEL AVIV, ISRAEL. SN 76-634,955. PUB. 12-27-2005, FILED 4-4-2005.

SOYA-COOL

THE MARK CONSISTS OF STANDARD CHARACTERS WITHOUT CLAIM TO ANY PARTICULAR FONT, STYLE, SIZE, OR COLOR.

FOR FOOD SUPPLEMENTS FOR MENOPAUSAL WOMEN (U.S. CLS. 6, 18, 44, 46, 51 AND 52).
FIRST USE 6-15-2005; IN COMMERCE 6-15-2005.

3,177,553. FISCHER PHARMACEUTICALS LTD., TEL AVIV, ISRAEL. SN 76-634,956. PUB. 12-27-2005, FILED 4-4-2005.

HYPER-SAFE

THE MARK CONSISTS OF STANDARD CHARACTERS WITHOUT CLAIM TO ANY PARTICULAR FONT, STYLE, SIZE, OR COLOR.

FOR FOOD SUPPLEMENTS TO REDUCE BLOOD PRESSURE (U.S. CLS. 6, 18, 44, 46, 51 AND 52).
FIRST USE 6-15-2005; IN COMMERCE 6-15-2005.

3,177,568. GREAT AMERICAN PRODUCTS, DESTIN, FL. SN 76-639,407. PUB. 2-7-2006, FILED 5-24-2005.

PROVIZAN

THE MARK CONSISTS OF STANDARD CHARACTERS WITHOUT CLAIM TO ANY PARTICULAR FONT, STYLE, SIZE, OR COLOR.

FOR NUTRITIONAL SUPPLEMENT TO SUPPORT PROSTATE HEALTH (U.S. CLS. 6, 18, 44, 46, 51 AND 52).
FIRST USE 5-8-2005; IN COMMERCE 5-8-2005.

CLASS 5—(Continued).

3,177,582. ALBAUGH, INC., ANKENY, IA. SN 76-648,440.
PUB. 6-20-2006, FILED 10-13-2005.

TEBUSTAR

THE MARK CONSISTS OF STANDARD CHARACTERS WITHOUT CLAIM TO ANY PARTICULAR FONT, STYLE, SIZE, OR COLOR.
FOR FUNGICIDES (U.S. CLS. 6, 18, 44, 46, 51 AND 52).
FIRST USE 4-8-2006; IN COMMERCE 4-8-2006.

CLASS 5—(Continued).

3,177,738. ESRUBAR, L.P., SAN ANTONIO, TX. SN 78-357,196.
PUB. 7-5-2005, FILED 1-25-2004.

**DR. SMITH'S RASH
'n ALL OINTMENT**

THE MARK CONSISTS OF STANDARD CHARACTERS WITHOUT CLAIM TO ANY PARTICULAR FONT, STYLE, SIZE, OR COLOR.

OWNER OF U.S. REG. NOS. 1,990,055 AND 2,001,200.

NO CLAIM IS MADE TO THE EXCLUSIVE RIGHT TO USE "RASH" AND "OINTMENT", APART FROM THE MARK AS SHOWN.

THE NAME DR. SMITH'S DOES NOT IDENTIFY A LIVING INDIVIDUAL

FOR PHARMACEUTICAL OINTMENT USED FOR THE PREVENTION AND TREATMENT OF RASH (U.S. CLS. 6, 18, 44, 46, 51 AND 52).

FIRST USE 4-15-2004; IN COMMERCE 4-15-2004.

3,177,597. SINCLAIR PHARMACEUTICALS LTD., SURREY, UNITED KINGDOM. SN 78-105,222. PUB. 4-29-2003, FILED 1-28-2002.

SINCLAIR

FOR PHARMACEUTICAL PREPARATIONS FOR THE TREATMENT OF COMPLICATIONS OF ANTI-CANCER TREATMENTS, DISEASES OF THE MOUTH, OROPHARYNX, AND SKIN (U.S. CLS. 6, 18, 44, 46, 51 AND 52).
FIRST USE 4-0-2005; IN COMMERCE 4-0-2005.

3,177,756. VALEANT PHARMACEUTICALS INTERNATIONAL, COSTA MESA, CA. SN 78-368,968. PUB. 11-16-2004, FILED 2-17-2004.

3,177,689. SEGAL, BERNARD I., LOS ANGELES, CA. SN 78-304,349. PUB. 6-15-2004, FILED 9-23-2003.

DEAD-FAST

FOR INSECTICIDES FOR THE CONTROL OF ANTS, ROACHES AND OTHER CRAWLING INSECTS FOR CONSUMER, PROFESSIONAL PEST CONTROL, INDUSTRIAL AND INSTITUTIONAL USE (U.S. CLS. 6, 18, 44, 46, 51 AND 52).

FIRST USE 8-1-2006; IN COMMERCE 8-1-2006.

CESAMET

3,177,703. SRZ PROPERTIES, INC., MEQUON, WI. SN 78-321,476. PUB. 3-29-2005, FILED 10-31-2003.

NIRAVAM

FOR PHARMACEUTICAL PREPARATION UTILIZED IN THE TREATMENT AND MANAGEMENT OF ANXIETY AND ANXIETY DISORDERS (U.S. CLS. 6, 18, 44, 46, 51 AND 52).

FIRST USE 5-0-2005; IN COMMERCE 5-0-2005.

THE MARK CONSISTS OF STANDARD CHARACTERS WITHOUT CLAIM TO ANY PARTICULAR FONT, STYLE, SIZE, OR COLOR.

FOR PHARMACEUTICAL PREPARATIONS NAMELY, ANTIEMETICS (U.S. CLS. 6, 18, 44, 46, 51 AND 52).

FIRST USE 8-0-2006; IN COMMERCE 8-0-2006.

CLASS 5—(Continued).

3,177,785. BURZYNSKI, STANISLAW R., HOUSTON, TX. SN 78-388,979. PUB. 12-21-2004, FILED 3-23-2004.

ASTUGENAL

THE MARK CONSISTS OF STANDARD CHARACTERS WITHOUT CLAIM TO ANY PARTICULAR FONT, STYLE, SIZE, OR COLOR.
FOR ANTICANCER PHARMACEUTICAL COMPOUNDS (U.S. CLS. 6, 18, 44, 46, 51 AND 52).
FIRST USE 8-26-2006; IN COMMERCE 8-26-2006.

3,177,847. VITAMARK INTERNATIONAL, INC., HOUSTON, TX. SN 78-428,072. PUB. 4-26-2005, FILED 6-1-2004.

REVITALGEN

THE MARK CONSISTS OF STANDARD CHARACTERS WITHOUT CLAIM TO ANY PARTICULAR FONT, STYLE, SIZE, OR COLOR.
FOR DIETARY SUPPLEMENTS (U.S. CLS. 6, 18, 44, 46, 51 AND 52).
FIRST USE 9-3-2005; IN COMMERCE 9-3-2005.

3,177,895. HEB GROCERY COMPANY, L.P., SAN ANTONIO, TX. SN 78-447,858. PUB. 6-14-2005, FILED 7-8-2004.

H•E•BUDDY

OWNER OF U.S. REG. NOS. 2,728,909, 2,854,572, AND OTHERS.
FOR ANTICAVITY MOUTH RINSE (U.S. CLS. 6, 18, 44, 46, 51 AND 52).
FIRST USE 4-30-2005; IN COMMERCE 4-30-2005.

CLASS 5—(Continued).

3,177,930. VDF FUTURECEUTICALS, INC., MOMENCE, IL. SN 78-461,611. PUB. 6-28-2005, FILED 8-4-2004.

SPROUTGARDEN

THE MARK CONSISTS OF STANDARD CHARACTERS WITHOUT CLAIM TO ANY PARTICULAR FONT, STYLE, SIZE, OR COLOR.
FOR DIETARY SUPPLEMENTS (U.S. CLS. 6, 18, 44, 46, 51 AND 52).
FIRST USE 5-22-2006; IN COMMERCE 5-22-2006.

3,178,028. VITAL PHARMACEUTICALS, INC., DAVIE, FL. SN 78-496,299. PUB. 12-27-2005, FILED 10-7-2004.

CRAVING CONTROL

THE MARK CONSISTS OF STANDARD CHARACTERS WITHOUT CLAIM TO ANY PARTICULAR FONT, STYLE, SIZE, OR COLOR.
FOR READY-TO-DRINK NUTRITIONALLY FORTIFIED BEVERAGES, NUTRITIONAL SUPPLEMENTS AND DIETARY SUPPLEMENTS (U.S. CLS. 6, 18, 44, 46, 51 AND 52).
FIRST USE 2-24-2005; IN COMMERCE 2-24-2005.

3,178,029. ARYSTA LIFESCIENCE NORTH AMERICA CORPORATION, CARY, NC. SN 78-496,461. PUB. 9-27-2005, FILED 10-7-2004.

CELERO

CLASS 5—(Continued).

THE MARK CONSISTS OF STANDARD CHARACTERS WITHOUT CLAIM TO ANY PARTICULAR FONT, STYLE, SIZE, OR COLOR.

FOR PESTICIDES, INSECTICIDES, FUNGICIDES AND HERBICIDES; ALL FOR USE IN AGRICULTURE, HORTICULTURE, SILVICULTURE AND HOME AND GARDEN USE (U.S. CLS. 6, 18, 44, 46, 51 AND 52).

FIRST USE 5-13-2005; IN COMMERCE 5-13-2005.

CLASS 5—(Continued).

3,178,153. WESTFALIASURGE, INC., NAPERVILLE, IL. SN 78-555,573. PUB. 1-10-2006, FILED 1-28-2005.

3,178,040. FLORAN TECHNOLOGIES, INC., OKLAHOMA CITY, OK. SN 78-503,212. PUB. 11-22-2005, FILED 10-20-2004.

FLORAN CATALYST

THE MARK CONSISTS OF STANDARD CHARACTERS WITHOUT CLAIM TO ANY PARTICULAR FONT, STYLE, SIZE, OR COLOR.

NO CLAIM IS MADE TO THE EXCLUSIVE RIGHT TO USE "CATALYST", APART FROM THE MARK AS SHOWN.

FOR CHEMICAL COMPOSITION FOR CLEANING AND DISINFECTING WATER TANKS AND RELATED APPARATUS (U.S. CLS. 6, 18, 44, 46, 51 AND 52).

FIRST USE 1-0-2000; IN COMMERCE 1-0-2000.

THE MARK CONSISTS OF STANDARD CHARACTERS WITHOUT CLAIM TO ANY PARTICULAR FONT, STYLE, SIZE, OR COLOR.

OWNER OF U.S. REG. NO. 2,046,641.

FOR GERMICIDAL SANITIZERS FOR USE ON DAIRY EQUIPMENT; SANITIZERS FOR MILKERS, MILK-HANDLING EQUIPMENT AND SYSTEMS FOR DAIRY FARMS; GERMICIDAL TEAT DIPS; SANITIZING UDDER WASHES; SANITIZING TEAT DIPS; TOPICAL TEAT DIPS FOR TISSUE TONING; MEDICATED SKIN CONDITIONERS FOR DAIRY ANIMALS (U.S. CLS. 6, 18, 44, 46, 51 AND 52).

FIRST USE 12-0-1995; IN COMMERCE 12-0-1995.

3,178,113. WYETH, MADISON, NJ. SN 78-537,014. PUB. 12-6-2005, FILED 12-22-2004.

**THERE'S A
ROBITUSSIN WITH
YOUR NAME ON IT**

THE MARK CONSISTS OF STANDARD CHARACTERS WITHOUT CLAIM TO ANY PARTICULAR FONT, STYLE, SIZE, OR COLOR.

OWNER OF U.S. REG. NOS. 837,010, 2,466,244, AND OTHERS.

FOR PHARMACEUTICAL PREPARATIONS, NAMELY COUGH AND COLD PREPARATIONS (U.S. CLS. 6, 18, 44, 46, 51 AND 52).

FIRST USE 8-1-2005; IN COMMERCE 8-1-2005.

3,178,201. INTEGRIS GLOBAL, L.P., IRVING, TX. SN 78-569,524. PUB. 11-8-2005, FILED 2-17-2005.

IntegriTrim

THE MARK CONSISTS OF STANDARD CHARACTERS WITHOUT CLAIM TO ANY PARTICULAR FONT, STYLE, SIZE, OR COLOR.

FOR NUTRITIONAL SUPPLEMENTS (U.S. CLS. 6, 18, 44, 46, 51 AND 52).

FIRST USE 4-1-2005; IN COMMERCE 4-1-2005.

CLASS 5—(Continued).

3,178,214. SOJAR S.A., ROSARIO, SANTA FE, ARGENTINA.
SN 78-572,730. PUB. 12-20-2005, FILED 2-22-2005.

CLASS 5—(Continued).

3,178,329. SC HOLDINGS, INC., BREA, CA. SN 78-595,462.
PUB. 1-17-2006, FILED 3-25-2005.



FOR MOLECULAR COMPOUND TO BE USED AS AN ACTIVE INGREDIENT IN DIETARY SUPPLEMENTS AND PHARMACEUTICAL PREPARATIONS FOR CHRONIC DISEASES SUCH AS OSTEOPOROSIS AND CARDIOVASCULAR-RELATED DISEASES (U.S. CLS. 6, 18, 44, 46, 51 AND 52).
FIRST USE 12-31-2004; IN COMMERCE 12-31-2005.

FOR DIETARY SUPPLEMENTS (U.S. CLS. 6, 18, 44, 46, 51 AND 52).
FIRST USE 9-1-2006; IN COMMERCE 9-1-2006.

3,178,321. DR. NIKOS M. LINARDAKIS, M.D., P.C., SALT LAKE CITY, UT. SN 78-594,336. PUB. 12-20-2005, FILED 3-24-2005.

3,178,331. MEDICIS PHARMACEUTICAL CORPORATION, SCOTTSDALE, AZ. SN 78-595,583. PUB. 12-20-2005, FILED 3-25-2005.

DR. NIKOS

SOLODYN

THE MARK CONSISTS OF STANDARD CHARACTERS WITHOUT CLAIM TO ANY PARTICULAR FONT, STYLE, SIZE, OR COLOR.
FOR DIETARY SUPPLEMENTS (U.S. CLS. 6, 18, 44, 46, 51 AND 52).
FIRST USE 3-5-2005; IN COMMERCE 3-5-2005.

THE MARK CONSISTS OF STANDARD CHARACTERS WITHOUT CLAIM TO ANY PARTICULAR FONT, STYLE, SIZE, OR COLOR.
FOR PHARMACEUTICAL PREPARATIONS FOR DERMATOLOGICAL USE (U.S. CLS. 6, 18, 44, 46, 51 AND 52).
FIRST USE 6-14-2006; IN COMMERCE 6-14-2006.

CLASS 5—(Continued).

3,178,335. UPSHER-SMITH LABORATORIES, INC., MAPLE GROVE, MN. SN 78-596,193. PUB. 12-27-2005, FILED 3-28-2005.

VANDAZOLE

THE MARK CONSISTS OF STANDARD CHARACTERS WITHOUT CLAIM TO ANY PARTICULAR FONT, STYLE, SIZE, OR COLOR.

FOR PHARMACEUTICAL PREPARATIONS FOR THE TREATMENT OF BACTERIAL VAGINOSIS (U.S. CLS. 6, 18, 44, 46, 51 AND 52).

FIRST USE 10-17-2005; IN COMMERCE 10-17-2005.

3,178,358. NOVARTIS AG, BASEL, SWITZERLAND. SN 78-599,800. PUB. 1-24-2006, FILED 4-1-2005.

FOCALIN XR

THE MARK CONSISTS OF STANDARD CHARACTERS WITHOUT CLAIM TO ANY PARTICULAR FONT, STYLE, SIZE, OR COLOR.

OWNER OF U.S. REG. NO. 2,978,115.

NO CLAIM IS MADE TO THE EXCLUSIVE RIGHT TO USE "XR", APART FROM THE MARK AS SHOWN.

FOR PHARMACEUTICAL PREPARATIONS FOR THE TREATMENT OF CENTRAL NERVOUS SYSTEM DISEASES AND DISORDERS (U.S. CLS. 6, 18, 44, 46, 51 AND 52).

FIRST USE 6-30-2005; IN COMMERCE 6-30-2005.

CLASS 5—(Continued).

3,178,376. CONFLUENT SURGICAL, INC., WALTHAM, MA. SN 78-603,947. PUB. 1-24-2006, FILED 4-7-2005.

DURASEAL XACT

THE MARK CONSISTS OF STANDARD CHARACTERS WITHOUT CLAIM TO ANY PARTICULAR FONT, STYLE, SIZE, OR COLOR.

OWNER OF U.S. REG. NO. 2,950,052.

FOR IN SITU POLYMERIZING HYDROGEL-BASED MEDICAL DEVICES, NAMELY, SEALANT PREPARATIONS FOR TISSUE SEALING AND SPACE FILLING EXCLUDING FOR USE ON TEETH OR IN THE MOUTH; PREFORMED PATCHES AND SHEETS SOLD WITH MEDICATION FOR MEDICAL USE EXCLUDING FOR USE ON TEETH OR IN THE MOUTH (U.S. CLS. 6, 18, 44, 46, 51 AND 52).

FIRST USE 8-10-2006; IN COMMERCE 8-10-2006.

3,178,390. SALOMON, SALLY M., DEL MAR, CA. SN 78-611,421. PUB. 1-17-2006, FILED 4-18-2005.

FORGET ME NOT

THE MARK CONSISTS OF STANDARD CHARACTERS WITHOUT CLAIM TO ANY PARTICULAR FONT, STYLE, SIZE, OR COLOR.

FOR FITTED CONTAINERS FOR CARRYING DISPOSABLE SANITARY PRODUCTS, NAMELY, FEMININE HYGIENE PRODUCTS (U.S. CLS. 6, 18, 44, 46, 51 AND 52).

FIRST USE 7-1-2005; IN COMMERCE 9-7-2005.

3,178,408. JARROW FORMULAS, INC., LOS ANGELES, CA. SN 78-619,453. PUB. 11-29-2005, FILED 4-28-2005.

FEM-DOPHILUS

THE MARK CONSISTS OF STANDARD CHARACTERS WITHOUT CLAIM TO ANY PARTICULAR FONT, STYLE, SIZE, OR COLOR.

OWNER OF U.S. REG. NO. 2,681,488.

FOR DIETARY AND NUTRITIONAL SUPPLEMENTS (U.S. CLS. 6, 18, 44, 46, 51 AND 52).

FIRST USE 2-0-1991; IN COMMERCE 2-0-1991.

CLASS 5—(Continued).

3,178,413. JARROW FORMULAS, INC., LOS ANGELES, CA.
SN 78-620,374. PUB. 12-13-2005, FILED 4-29-2005.

FEM-DOPHILUS

THE MARK CONSISTS OF STANDARD CHARACTERS
WITHOUT CLAIM TO ANY PARTICULAR FONT, STYLE,
SIZE, OR COLOR.

FOR DIETARY AND NUTRITIONAL SUPPLEMENTS,
AND PROBIOTIC SUPPLEMENTS (U.S. CLS. 6, 18, 44, 46,
51 AND 52).

FIRST USE 2-0-1991; IN COMMERCE 2-0-1991.

CLASS 5—(Continued).

3,178,537. HEALTHY DIRECTIONS LLC, POTOMAC, MD.
SN 78-667,777. PUB. 4-4-2006, FILED 7-11-2005.

PROSTACOMPLETE

THE MARK CONSISTS OF STANDARD CHARACTERS
WITHOUT CLAIM TO ANY PARTICULAR FONT, STYLE,
SIZE, OR COLOR.

FOR VITAMINS AND NUTRITIONAL SUPPLEMENTS
(U.S. CLS. 6, 18, 44, 46, 51 AND 52).

FIRST USE 8-8-2005; IN COMMERCE 8-8-2005.

3,178,421. BETA PHARMACEUTICAL INC, WESTON, FL. SN
78-623,849. PUB. 2-21-2006, FILED 5-5-2005.

Liquid Rejuvenation 3

THE MARK CONSISTS OF STANDARD CHARACTERS
WITHOUT CLAIM TO ANY PARTICULAR FONT, STYLE,
SIZE, OR COLOR.

NO CLAIM IS MADE TO THE EXCLUSIVE RIGHT TO
USE "LIQUID", APART FROM THE MARK AS SHOWN.

FOR DIETARY NUTRITIONAL SUPPLEMENTS (U.S.
CLS. 6, 18, 44, 46, 51 AND 52).

FIRST USE 1-1-2006; IN COMMERCE 1-1-2006.

3,178,575. NATIONAL PET SUPPLY, INC., ATLANTA, GA.
SN 78-687,439. PUB. 4-25-2006, FILED 8-8-2005.

RENURSE

THE MARK CONSISTS OF STANDARD CHARACTERS
WITHOUT CLAIM TO ANY PARTICULAR FONT, STYLE,
SIZE, OR COLOR.

FOR NUTRITIONAL LIQUID SOLUTIONS FOR DOGS
(U.S. CLS. 6, 18, 44, 46, 51 AND 52).

FIRST USE 11-9-2005; IN COMMERCE 11-9-2005.

3,178,462. SHIPPERT ENTERPRISES, LTD., CENTENNIAL,
CO. SN 78-640,484. PUB. 2-7-2006, FILED 5-31-2005.

M.V.P.LUG

THE MARK CONSISTS OF STANDARD CHARACTERS
WITHOUT CLAIM TO ANY PARTICULAR FONT, STYLE,
SIZE, OR COLOR.

FOR MEDICAL DRESSINGS, NAMELY, NASAL
PACKS AND KITS CONTAINING NASAL PACKS FOR
CONTROLLING NASAL BLOOD FLOW IN THE NATURE
OF MEDICAL DRESSINGS, APPLICATORS FOR
INSERTING NASAL PACKS INTO THE NOSE AND
GAUZE (U.S. CLS. 6, 18, 44, 46, 51 AND 52).

FIRST USE 9-0-2005; IN COMMERCE 9-0-2005.

3,178,611. WHEAT, JARED R., NORCROSS, GA. SN 78-
711,599. PUB. 5-16-2006, FILED 9-13-2005.

PAIN-RX

THE MARK CONSISTS OF STANDARD CHARACTERS
WITHOUT CLAIM TO ANY PARTICULAR FONT, STYLE,
SIZE, OR COLOR.

FOR DIETARY SUPPLEMENTS (U.S. CLS. 6, 18, 44, 46,
51 AND 52).

FIRST USE 9-13-2005; IN COMMERCE 10-1-2005.

CLASS 5—(Continued).

3,178,648. FITNESS LABS NUTRITION CORPORATION, TORRANCE, CA. SN 78-733,863. PUB. 6-13-2006, FILED 10-14-2005.

BCAAFit

THE MARK CONSISTS OF STANDARD CHARACTERS WITHOUT CLAIM TO ANY PARTICULAR FONT, STYLE, SIZE, OR COLOR.

FOR DIETARY SUPPLEMENTS (U.S. CLS. 6, 18, 44, 46, 51 AND 52).

FIRST USE 1-2-2006; IN COMMERCE 1-2-2006.

CLASS 5—(Continued).

3,178,654. BLISTEX INC., OAK BROOK, IL. SN 78-759,071. PUB. 6-6-2006, FILED 11-22-2005.

MOISTURE SPLASH

THE MARK CONSISTS OF STANDARD CHARACTERS WITHOUT CLAIM TO ANY PARTICULAR FONT, STYLE, SIZE, OR COLOR.

NO CLAIM IS MADE TO THE EXCLUSIVE RIGHT TO USE "MOISTURE", APART FROM THE MARK AS SHOWN.

FOR MEDICATED TOPICAL CREAMS, LOTIONS, GELS, BALMS, AND/OR OINTMENTS FOR HUMAN USE FOR LIP AND SKIN DRYNESS, COLD SORES, BURNS, ITCHING, FOR LIP AND SKIN CARE, TOPICAL ANALGESIC PREPARATIONS, TOPICAL ANTIBIOTIC CREAMS, LOTIONS, GELS, BALMS, AND/OR OINTMENTS AND MEDICATED TOPICAL SUN SCREEN CREAMS, LOTIONS, GELS, BALMS, AND/OR OINTMENTS FOR USE ON THE LIPS AND SKIN (U.S. CLS. 6, 18, 44, 46, 51 AND 52).

FIRST USE 5-15-2006; IN COMMERCE 6-0-2006.

3,178,666. TARO PHARMACEUTICALS U.S.A., INC., HAWTHORNE, NY. SN 78-977,577. PUB. 6-15-2004, FILED 9-11-2003.

QUALITY & INTEGRITY INSIDE & OUT

FOR FULL LINE OF PHARMACEUTICAL PRODUCTS (U.S. CLS. 6, 18, 44, 46, 51 AND 52).

FIRST USE 0-0-2002; IN COMMERCE 0-0-2002.

3,178,653. BLISTEX INC., OAK BROOK, IL. SN 78-759,061. PUB. 6-6-2006, FILED 11-22-2005.

CHERRY SPLASH

THE MARK CONSISTS OF STANDARD CHARACTERS WITHOUT CLAIM TO ANY PARTICULAR FONT, STYLE, SIZE, OR COLOR.

NO CLAIM IS MADE TO THE EXCLUSIVE RIGHT TO USE "CHERRY", APART FROM THE MARK AS SHOWN.

FOR MEDICATED TOPICAL CREAMS, LOTIONS, GELS, BALMS, AND/OR OINTMENTS FOR HUMAN USE FOR LIP AND SKIN DRYNESS, COLD SORES, BURNS, ITCHING, FOR LIP AND SKIN CARE, TOPICAL ANALGESIC PREPARATIONS, TOPICAL ANTIBIOTIC CREAMS, LOTIONS, GELS, BALMS, AND/OR OINTMENTS AND MEDICATED TOPICAL SUN SCREEN CREAMS, LOTIONS, GELS, BALMS, AND/OR OINTMENTS FOR USE ON THE LIPS AND SKIN (U.S. CLS. 6, 18, 44, 46, 51 AND 52).

FIRST USE 5-15-2006; IN COMMERCE 6-0-2006.

CLASS 6—METAL GOODS

3,177,440. C & N DEVELOPMENT CO., WEST LINN, OR. SN 76-588,699. PUB. 9-27-2005, FILED 4-26-2004.

RACK-IT-BRACKIT

THE MARK CONSISTS OF STANDARD CHARACTERS WITHOUT CLAIM TO ANY PARTICULAR FONT, STYLE, SIZE, OR COLOR.

FOR METAL COUPLER DEVICE FOR ATTACHMENT TO A WALL OR OTHER SURFACE WHICH CAN ALSO BE ATTACHED TO A HITCH OR CARRIER RACK (U.S. CLS. 2, 12, 13, 14, 23, 25 AND 50).

FIRST USE 2-1-2005; IN COMMERCE 2-1-2005.

CLASS 6—(Continued).

3,177,722. U.S. ALUMINUM, INC., BROOKFIELD, WI. SN 78-344,822. PUB. 6-14-2005, FILED 12-23-2003.

CLASS 6—(Continued).

3,178,080. GOODYEAR TIRE & RUBBER COMPANY, THE, AKRON, OH. SN 78-522,780. PUB. 10-11-2005, FILED 11-24-2004.

GUTTER SHELTER

FIELD-GRIP

THE MARK CONSISTS OF STANDARD CHARACTERS WITHOUT CLAIM TO ANY PARTICULAR FONT, STYLE, SIZE, OR COLOR.

NO CLAIM IS MADE TO THE EXCLUSIVE RIGHT TO USE "GUTTER", APART FROM THE MARK AS SHOWN.

FOR METAL GUTTER AND DOWN SPOUT COVERS (U.S. CLS. 2, 12, 13, 14, 23, 25 AND 50).

FIRST USE 1-13-2005; IN COMMERCE 1-13-2005.

THE MARK CONSISTS OF STANDARD CHARACTERS WITHOUT CLAIM TO ANY PARTICULAR FONT, STYLE, SIZE, OR COLOR.

FOR METAL FITTINGS FOR HYDRAULIC HOSE (U.S. CLS. 2, 12, 13, 14, 23, 25 AND 50).

FIRST USE 7-7-2004; IN COMMERCE 7-7-2004.

3,177,750. FWU KUANG ENTERPRISES CO., LTD., TAINAN HSIEN, TAIWAN. SN 78-364,911. PUB. 8-2-2005, FILED 2-9-2004.

3,178,192. VERISTEEL, INC., NORTH LAS VEGAS, NV. SN 78-568,137. PUB. 11-15-2005, FILED 2-15-2005.

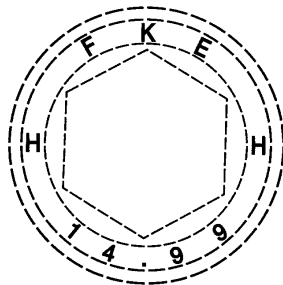

VERICLAD

NO CLAIM IS MADE TO THE EXCLUSIVE RIGHT TO USE THE SHAPE OF THE FASTENERS OR THE HEXAGONAL DESIGN, APART FROM THE MARK AS SHOWN.

FOR METAL FASTENERS, NAMELY BOLTS, NUTS AND SCREWS (U.S. CLS. 2, 12, 13, 14, 23, 25 AND 50).

FIRST USE 1-27-2004; IN COMMERCE 8-3-2006.

THE MARK CONSISTS OF STANDARD CHARACTERS WITHOUT CLAIM TO ANY PARTICULAR FONT, STYLE, SIZE, OR COLOR.

FOR HONEYCOMB PAPER AND STEEL COMPOSITE BUILDING PANELS (U.S. CLS. 2, 12, 13, 14, 23, 25 AND 50).

FIRST USE 4-3-2006; IN COMMERCE 4-3-2006.

CLASS 6—(Continued).

3,178,228. COLD SPRING GRANITE COMPANY, COLD SPRING, MN. SN 78-575,213. PUB. 1-3-2006, FILED 2-25-2005.

CANYON ROAD

THE MARK CONSISTS OF STANDARD CHARACTERS WITHOUT CLAIM TO ANY PARTICULAR FONT, STYLE, SIZE, OR COLOR.

FOR BRONZE GRAVE MARKER WITH A SPECIAL BORDER (U.S. CLS. 2, 12, 13, 14, 23, 25 AND 50).
FIRST USE 3-1-2005; IN COMMERCE 3-1-2005.

3,178,283. BAND-IT-IDEX, INC., DENVER, CO. SN 78-587,240. PUB. 12-13-2005, FILED 3-15-2005.

 The logo for SIGNFIX features a stylized, bold letter 'S' on the left, followed by the word 'SIGNFIX' in a bold, sans-serif font.

OWNER OF U.S. REG. NOS. 1,289,809 AND 1,356,233.
FOR METAL BRACKETS, SIGNS, CLIPS, CLAMPS, BUCKLES, STRAPS, BANDING, NON-MECHANICAL BAND DISPENSERS, NUTS AND BOLTS; ALL FOR USE IN SIGN MOUNTING (U.S. CLS. 2, 12, 13, 14, 23, 25 AND 50).
FIRST USE 1-30-1996; IN COMMERCE 1-30-1996.

CLASS 6—(Continued).

3,178,357. KAISER ALUMINUM FABRICATED PRODUCTS, LLC, FOOTHILL RANCH, CA. SN 78-599,669. PUB. 12-27-2005, FILED 3-31-2005.

KAISER HOLOBAR

THE MARK CONSISTS OF STANDARD CHARACTERS WITHOUT CLAIM TO ANY PARTICULAR FONT, STYLE, SIZE, OR COLOR.

FOR EXTRUDED SEAMLESS ALUMINUM TUBING (U.S. CLS. 2, 12, 13, 14, 23, 25 AND 50).
FIRST USE 4-13-2006; IN COMMERCE 4-13-2006.

3,178,439. AB&I, OAKLAND, CA. SN 78-630,971. PUB. 2-7-2006, FILED 5-16-2005.

 The logo for ARN consists of the letters 'A', 'R', and 'N' in a bold, serif font, spaced out horizontally.

THE MARK CONSISTS OF STANDARD CHARACTERS WITHOUT CLAIM TO ANY PARTICULAR FONT, STYLE, SIZE, OR COLOR.

FOR METAL PIPES, NAMELY CAST IRON SOIL PIPE (U.S. CLS. 2, 12, 13, 14, 23, 25 AND 50).
FIRST USE 12-31-2005; IN COMMERCE 12-31-2005.

3,178,504. GENERAL ELECTRIC COMPANY, SCHENECTADY, NY. SN 78-657,696. PUB. 4-25-2006, FILED 6-24-2005.

 The logo for GE consists of the letters 'G' and 'E' in a bold, serif font, spaced out horizontally.

THE MARK CONSISTS OF STANDARD CHARACTERS WITHOUT CLAIM TO ANY PARTICULAR FONT, STYLE, SIZE, OR COLOR.

OWNER OF U.S. REG. NOS. 995,765, 2,631,838, AND OTHERS.

FOR METAL LOCKS; METAL SECURITY ENCLOSURES, NAMELY, KEY CABINETS, STORAGE TUBES AND STORAGE BOXES FOR SECURING KEYS; METAL LOCKBOXES FOR RESIDENTIAL, VEHICULAR, INDUSTRIAL AND REAL ESTATE SALES USE; METAL KEY CABINETS FOR LOCKING, TRACKING AND STORING KEYS; METAL KEY SAFES (U.S. CLS. 2, 12, 13, 14, 23, 25 AND 50).

FIRST USE 1-31-2004; IN COMMERCE 1-31-2004.

CLASS 6—(Continued).

3,178,513. GENERAL ELECTRIC COMPANY, SCHENECTADY, NY. SN 78-660,461. PUB. 4-25-2006, FILED 6-29-2005.



OWNER OF U.S. REG. NOS. 995,765, 2,631,838, AND OTHERS.

FOR METAL LOCKS; METAL SECURITY ENCLOSURES, NAMELY, KEY CABINETS, STORAGE TUBES AND STORAGE BOXES FOR SECURING KEYS; METAL LOCKBOXES FOR RESIDENTIAL, VEHICULAR, INDUSTRIAL AND REAL ESTATE SALES USE; METAL KEY CABINETS FOR LOCKING, TRACKING AND STORING KEYS; METAL KEY SAFES (U.S. CLS. 2, 12, 13, 14, 23, 25 AND 50).

FIRST USE 1-31-2004; IN COMMERCE 1-31-2004.

CLASS 7—MACHINERY

3,177,384. KVP FALCON PLASTIC BELTING, INC., RANCHO CORDOVA, CA. SN 76-514,872. PUB. 2-17-2004, FILED 4-23-2003.

SPIRAIL

FOR SUPPORT STRUCTURE, NAMELY, RAILS USED TO SUPPORT A CONVEYOR BELT FOR SLIDING MOVEMENT IN A SPIRAL CONVEYOR BELT SYSTEM (U.S. CLS. 13, 19, 21, 23, 31, 34 AND 35).

FIRST USE 6-0-2004; IN COMMERCE 6-0-2004.

3,177,458. SONIC INNOVATIONS, INC., CULVER CITY, CA. SN 76-604,365. PUB. 12-13-2005, FILED 7-26-2004.

SONIC BLADE

THE MARK CONSISTS OF STANDARD CHARACTERS WITHOUT CLAIM TO ANY PARTICULAR FONT, STYLE, SIZE, OR COLOR.

NO CLAIM IS MADE TO THE EXCLUSIVE RIGHT TO USE "BLADE", APART FROM THE MARK AS SHOWN.

FOR ELECTRIC POWERED HOME APPLIANCES, NAMELY, ELECTRIC AND BATTERY POWERED KNIVES (U.S. CLS. 13, 19, 21, 23, 31, 34 AND 35).

FIRST USE 12-1-2005; IN COMMERCE 12-1-2005.

CLASS 7—(Continued).

3,177,564. I.P. HOLDINGS, INC., GRAND PRAIRIE, TX. SN 76-638,134. PUB. 3-14-2006, FILED 5-9-2005.

WILDVIEW

THE MARK CONSISTS OF STANDARD CHARACTERS WITHOUT CLAIM TO ANY PARTICULAR FONT, STYLE, SIZE, OR COLOR.

FOR MECHANIZED ANIMAL FEEDERS (U.S. CLS. 13, 19, 21, 23, 31, 34 AND 35).

FIRST USE 4-20-2006; IN COMMERCE 4-20-2006.

3,177,621. UNIVERSAL SEWING SUPPLY, INC., ST. LOUIS, MO. SN 78-173,738. PUB. 10-28-2003, FILED 10-11-2002.

MY-T-FINE CUTTER

NO CLAIM IS MADE TO THE EXCLUSIVE RIGHT TO USE "CUTTER", APART FROM THE MARK AS SHOWN.

FOR ELECTRIC SCISSORS (U.S. CLS. 13, 19, 21, 23, 31, 34 AND 35).

FIRST USE 5-1-2006; IN COMMERCE 5-1-2006.

3,177,631. GENERAL ELECTRIC COMPANY, SCHENECTADY, NY. SN 78-190,316. PUB. 2-17-2004, FILED 12-2-2002.

IMAGINATION AT WORK

FOR ELECTRIC AND WIND-POWERED ELECTRIC GENERATORS; AERONAUTICAL AND AEROPLANE ENGINES; CONTROL MECHANISMS FOR MACHINES, ENGINES OR MOTORS; CRANES; JET ENGINES OTHER THAN FOR LAND VEHICLES; MOTORS AND ENGINES FOR BOATS; DISHWASHERS; GARBAGE AND WASTE DISPOSALS; MOTORS; ENGINES; STARTERS FOR MOTORS AND ENGINES; LAUNDRY WASHING MACHINES; LAUNDRY DRYING MACHINES; COMPRESSORS, TURBO COMPRESSORS, FUEL INJECTORS AND TURBOCHARGERS FOR MACHINES, MOTORS AND ENGINES; WIND, STEAM, GAS AND HYDRAULIC TURBINES; ELECTRIC PUMPS; VALVES FOR PUMPS; INDUSTRIAL ROBOTS, AND COMPONENT PARTS OF ALL THE FOREGOING (U.S. CLS. 13, 19, 21, 23, 31, 34 AND 35).

FIRST USE 12-31-1995; IN COMMERCE 12-31-1995.

CLASS 7—(Continued).

3,177,662. MCGUIRE BEARING COMPANY, PORTLAND,
OR. SN 78-270,129. PUB. 1-27-2004, FILED 7-3-2003.

CLASS 7—(Continued).

3,177,828. GEA LYOPHIL GMBH, COLOGNE, FED REP
GERMANY. SN 78-414,189. PUB. 6-28-2005, FILED 5-6-2004.

JEM

FOR MACHINE PARTS, NAMELY, BEARINGS, BUSHINGS AND POWER TRANSMISSION COMPONENTS, NAMELY BELTS, SHEAVES, PULLEYS, CHAINS, SPROCKETS, SHAFT COLLARS, HUBS, COUPLINGS, TIGHTENERS, IDLERS, GEARS, GEAR BOXES, SPEED REDUCERS, KEYSTOCK, ROLLER CHAINS, AND CONVEYOR BELTS (U.S. CLS. 13, 19, 21, 23, 31, 34 AND 35).
FIRST USE 4-1-2006; IN COMMERCE 4-1-2006.

ALUS

3,177,802. MIBRO PARTNERS, SCARBOROUGH, ONTARIO,
CANADA. SN 78-399,274. PUB. 5-17-2005, FILED 4-9-2004.

THE MARK CONSISTS OF STANDARD CHARACTERS WITHOUT CLAIM TO ANY PARTICULAR FONT, STYLE, SIZE, OR COLOR.

OWNER OF FED REP GERMANY REG. NO. 39507481, DATED 2-21-1996, RENEWED AS REG. NO. 39507481, DATED 2-18-2005, EXPIRES 2-18-2015.

FOR INDUSTRIAL ROBOT, NAMELY MACHINE-OPERATED HANDLING APPARATUS FOR LOADING AND UNLOADING FREEZE-DRYERS (U.S. CLS. 13, 19, 21, 23, 31, 34 AND 35).

FIRST USE 0-0-1989; IN COMMERCE 0-0-1991.

STINGRAY

3,177,939. SOLAR SAILOR PTY LTD, SYDNEY, N.S.W., AUSTRALIA. SN 78-463,978. PUB. 12-13-2005, FILED 8-9-2004.

SOLARSAILOR

THE MARK CONSISTS OF STANDARD CHARACTERS WITHOUT CLAIM TO ANY PARTICULAR FONT, STYLE, SIZE, OR COLOR.

FOR POWER TOOL ACCESSORIES, NAMELY, EXTENSIONS FOR POWER TOOLS, ABRASIVE BELTS FOR POWER-OPERATED SANDERS, ABRASIVE DISKS FOR POWER-OPERATED SANDERS AND POWER-OPERATED GRINDERS, ABRASIVE WHEELS FOR POWER-OPERATED GRINDERS, BITS FOR POWER DRILLS, BLADES FOR POWER SAWS, CHUCKS FOR POWER DRILLS AND DRILL CHUCKS FOR POWER DRILLS (U.S. CLS. 13, 19, 21, 23, 31, 34 AND 35).
FIRST USE 2-18-2005; IN COMMERCE 3-8-2005.

THE MARK CONSISTS OF STANDARD CHARACTERS WITHOUT CLAIM TO ANY PARTICULAR FONT, STYLE, SIZE, OR COLOR.

OWNER OF AUSTRALIA REG. NO. 855411, DATED 10-30-2000, EXPIRES 10-30-2010.

FOR HYBRID MARINE POWER SYSTEMS, NAMELY DRIVE MECHANISMS THAT INCORPORATE RENEWABLE ENERGY, AND PARTS THEREFORE, INCLUDING SOLAR AND WIND HARVESTING DEVICES, ASSOCIATED SOFTWARE AND ELECTRONIC CONTROLS (U.S. CLS. 13, 19, 21, 23, 31, 34 AND 35).

FIRST USE 9-1-2000; IN COMMERCE 9-1-2000.

CLASS 7—(Continued).

3,177,987. JUSUNG ENGINEERING CO., LTD., GYEONGGIDO, REPUBLIC OF KOREA. SN 78-477,914. PUB. 1-17-2006, FILED 9-2-2004.

CLASS 7—(Continued).

3,177,989. WILDEN PUMP AND ENGINEERING LLC, GRAND TERRACE, CA. SN 78-478,100. PUB. 12-13-2005, FILED 9-2-2004.



JUSUNG Engineering Co., Ltd.

TYPHOON

THE MARK CONSISTS OF STANDARD CHARACTERS WITHOUT CLAIM TO ANY PARTICULAR FONT, STYLE, SIZE, OR COLOR.

FOR PNEUMATICALLY DRIVEN INDUSTRIAL MIXING UNIT (U.S. CLS. 13, 19, 21, 23, 31, 34 AND 35).

FIRST USE 3-31-2005; IN COMMERCE 3-31-2005.

3,177,997. VOONER FLOGARD CORPORATION, CHARLOTTE, NC. SN 78-480,703. PUB. 9-20-2005, FILED 9-9-2004.

SHENANDOAH

OWNER OF REPUBLIC OF KOREA REG. NO. 0420279, DATED 9-8-1998, EXPIRES 9-8-2008.

NO CLAIM IS MADE TO THE EXCLUSIVE RIGHT TO USE "ENGINEERING CO., LTD", APART FROM THE MARK AS SHOWN.

THE MARK CONSISTS OF STYLIZED LETTERS JEL, WITH STANDARD LETTERS JUSUNG ENGINEERING CO., LTD.

FOR SEMICONDUCTOR MANUFACTURING DEVICES, NAMELY, MULTI CHAMBERS FOR CHEMICAL DEPOSITIONS, VACUUM CHAMBERS FOR CHEMICAL DEPOSITIONS, SEMICONDUCTOR MANUFACTURING MACHINES, DEPOSITION UNITS FOR MANUFACTURING SEMICONDUCTORS, CHEMICAL VAPOR DEPOSITION UNITS FOR MANUFACTURING SEMICONDUCTORS, PLASMA ENHANCED CHEMICAL VAPOR DEPOSITION UNITS FOR MANUFACTURING SEMICONDUCTORS, ETCHING UNITS FOR MANUFACTURING SEMICONDUCTORS, GAS INJECTORS FOR MANUFACTURING SEMICONDUCTORS, DEPOSITION UNITS FOR MANUFACTURING LIQUID CRYSTAL DISPLAYS, CHEMICAL VAPOR DEPOSITION UNITS FOR MANUFACTURING LIQUID CRYSTAL DISPLAYS, PLASMA ENHANCED CHEMICAL VAPOR DEPOSITION UNITS FOR MANUFACTURING LIQUID CRYSTAL DISPLAYS, ETCHING UNITS FOR MANUFACTURING LIQUID CRYSTAL DISPLAY, GAS INJECTORS FOR MANUFACTURING LIQUID CRYSTAL DISPLAYS (U.S. CLS. 13, 19, 21, 23, 31, 34 AND 35).

FIRST USE 9-5-2004; IN COMMERCE 9-5-2004.

THE MARK CONSISTS OF STANDARD CHARACTERS WITHOUT CLAIM TO ANY PARTICULAR FONT, STYLE, SIZE, OR COLOR.

FOR POWER OPERATED SPRAYERS FOR DISTRIBUTING AND SPRAYING LIQUIDS FOR INDUSTRIAL PURPOSES; PAPER MAKING MACHINE PARTS, NAMELY, SPRAYERS (U.S. CLS. 13, 19, 21, 23, 31, 34 AND 35).

FIRST USE 5-31-2005; IN COMMERCE 5-31-2005.

3,178,013. POWER WELL SERVICES, INC., HOUSTON, TX. SN 78-489,401. PUB. 12-13-2005, FILED 9-24-2004.

CLASS 7—(Continued).

NO CLAIM IS MADE TO THE EXCLUSIVE RIGHT TO USE "SERVICES", APART FROM THE MARK AS SHOWN.

FOR OIL WELL OR GAS WELL DRILLING AND OPERATING TOOLS AND EQUIPMENT, NAMELY, HYDRAULICALLY ACTUATED DRILLING AND SNUBBING CHOKES, SEALS, LINERS, WEAR SLEEVES AND HYDRAULIC ACTUATORS (U.S. CLS. 13, 19, 21, 23, 31, 34 AND 35).

FIRST USE 7-0-2004; IN COMMERCE 7-0-2004.

3,178,137. HONEYWELL INTERNATIONAL INC., MORRISTOWN, NJ. SN 78-549,188. PUB. 5-23-2006, FILED 1-18-2005.



OWNER OF U.S. REG. NOS. 110,818 AND 637,085.

NO CLAIM IS MADE TO THE EXCLUSIVE RIGHT TO USE "SPARK PLUGS", APART FROM THE MARK AS SHOWN.

FOR SPARK PLUGS (U.S. CLS. 13, 19, 21, 23, 31, 34 AND 35).

FIRST USE 10-31-2004; IN COMMERCE 3-31-2005.

3,178,197. CHAMPION POWER EQUIPMENT, INC., SANTA FE SPRINGS, CA. SN 78-568,812. PUB. 12-13-2005, FILED 2-16-2005.

CPE

THE MARK CONSISTS OF STANDARD CHARACTERS WITHOUT CLAIM TO ANY PARTICULAR FONT, STYLE, SIZE, OR COLOR.

FOR PORTABLE GASOLINE POWERED ELECTRIC GENERATORS; WINCHES; GASOLINE ENGINES NOT FOR LAND VEHICLE USE; SAND BLAST CABINETS; HYDRAULIC LIFT TABLES; HYDRAULIC JACKS; PORTABLE GASOLINE POWERED WATER PUMPS FOR FLOOD WATER TRANSFER, SWIMMING POOL, AND AGRICULTURAL RUNOFF WATER USE; SHOP CRANES AND HOISTS (U.S. CLS. 13, 19, 21, 23, 31, 34 AND 35).

FIRST USE 3-15-2005; IN COMMERCE 3-15-2005.

CLASS 7—(Continued).

3,178,224. ATTACHMENT TECHNOLOGIES, INC., CEDAR RAPIDS, IA. SN 78-574,555. PUB. 12-13-2005, FILED 2-24-2005.



FOR CONSTRUCTION AND AGRICULTURAL EQUIPMENT, NAMELY, HAY AND MANURE HANDLERS, DOZER BLADES, LOADER BUCKERS, MATERIAL HANDLERS, FORESTRY HANDLERS, FORKS, AND TRUSS BOOMS AND LIFTING ARMS AND SWEEPERS FOR ATTACHMENT TO SKID STEER LOADERS, TRACTORS AND BACKHOES (U.S. CLS. 13, 19, 21, 23, 31, 34 AND 35).

FIRST USE 3-0-2005; IN COMMERCE 3-0-2005.

3,178,245. USFILTER CORPORATION, WARRENDALE, PA. SN 78-578,588. PUB. 12-6-2005, FILED 3-2-2005.

MEMSAP

THE MARK CONSISTS OF STANDARD CHARACTERS WITHOUT CLAIM TO ANY PARTICULAR FONT, STYLE, SIZE, OR COLOR.

OWNER OF U.S. REG. NO. 2,780,445.
FOR MOTOR-DRIVEN PLATFORMS THAT CAN BE RAISED AND LOWERED THAT PROVIDE ACCESS TO WATER TREATMENT EQUIPMENT (U.S. CLS. 13, 19, 21, 23, 31, 34 AND 35).

FIRST USE 8-7-2002; IN COMMERCE 8-7-2002.

CLASS 7—(Continued).

3,178,261. RAYCO MANUFACTURING, INC., WOOSTER, OH. SN 78-582,353. PUB. 12-13-2005, FILED 3-8-2005.

THE STUMP CUTTER PEOPLE

THE MARK CONSISTS OF STANDARD CHARACTERS WITHOUT CLAIM TO ANY PARTICULAR FONT, STYLE, SIZE, OR COLOR.

NO CLAIM IS MADE TO THE EXCLUSIVE RIGHT TO USE "STUMP CUTTER", APART FROM THE MARK AS SHOWN.

FOR STUMP CUTTING MACHINES AND METAL CUTTING TEETH FOR USE WITH STUMP CUTTING MACHINES (U.S. CLS. 13, 19, 21, 23, 31, 34 AND 35).

FIRST USE 12-1-1988; IN COMMERCE 12-1-1988.

3,178,296. SAINT-GOBAIN ABRASIVES, INC., WORCESTER, MA. SN 78-589,513. PUB. 12-13-2005, FILED 3-17-2005.

NORGRIP

THE MARK CONSISTS OF STANDARD CHARACTERS WITHOUT CLAIM TO ANY PARTICULAR FONT, STYLE, SIZE, OR COLOR.

FOR PORTABLE HAND-HELD GRINDERS FOR USE WITH AIR AND ELECTRIC POWERED TOOLS (U.S. CLS. 13, 19, 21, 23, 31, 34 AND 35).

FIRST USE 10-1-2004; IN COMMERCE 10-1-2004.

CLASS 7—(Continued).

3,178,316. COMPACT POWER, INC., FORT MILL, SC. SN 78-592,661. PUB. 12-27-2005, FILED 3-22-2005.

BRUTE

THE MARK CONSISTS OF STANDARD CHARACTERS WITHOUT CLAIM TO ANY PARTICULAR FONT, STYLE, SIZE, OR COLOR.

FOR MOTORIZED EQUIPMENT, NAMELY, SKID-STEER LOADERS AND COMPACT UTILITY LOADERS WITH CAPABILITY FOR MULTIPLE ATTACHMENTS, AND COMPONENT PARTS THEREFOR (U.S. CLS. 13, 19, 21, 23, 31, 34 AND 35).

FIRST USE 7-1-2005; IN COMMERCE 7-1-2005.

3,178,603. THE GLEASON WORKS, ROCHESTER, NY. SN 78-707,314. PUB. 5-23-2006, FILED 9-6-2005.

Genesis

THE MARK CONSISTS OF STANDARD CHARACTERS WITHOUT CLAIM TO ANY PARTICULAR FONT, STYLE, SIZE, OR COLOR.

FOR GEAR MANUFACTURING MACHINES; GEAR MANUFACTURING GRINDING AND CUTTING TOOLS AND COMPONENTS THEREOF; AND REPLACEMENT PARTS FOR GEAR MANUFACTURING MACHINES (U.S. CLS. 13, 19, 21, 23, 31, 34 AND 35).

FIRST USE 9-0-2005; IN COMMERCE 8-18-2006.

3,178,622. WORLD FACTORY, INC., COPPELL, TX. SN 78-715,428. PUB. 5-30-2006, FILED 9-19-2005.

POWER GLIDE

THE MARK CONSISTS OF STANDARD CHARACTERS WITHOUT CLAIM TO ANY PARTICULAR FONT, STYLE,

CLASS 7—(Continued).

SIZE, OR COLOR.

OWNER OF U.S. REG. NOS. 2,605,562 AND 2,971,151.
 NO CLAIM IS MADE TO THE EXCLUSIVE RIGHT TO USE "POWER", APART FROM THE MARK AS SHOWN.
 FOR POWERED YARD TOOLS, NAMELY, CORDED AND BATTERY OPERATED STRING LINE TRIMMERS, HEDGE TRIMMERS, AND LEAF BLOWERS AND VACUUMS (U.S. CLS. 13, 19, 21, 23, 31, 34 AND 35).
 FIRST USE 2-15-2005; IN COMMERCE 2-15-2005.

3,178,626. GLEASON WORKS, THE, ROCHESTER, NY. SN 78-717,508. PUB. 6-13-2006, FILED 9-21-2005.



THE STIPPLING IN THE DRAWING IS FOR SHADING PURPOSES.

FOR GEAR MANUFACTURING MACHINES; GEAR MANUFACTURING GRINDING AND CUTTING TOOLS AND COMPONENTS THEREOF; AND REPLACEMENT PARTS FOR GEAR MANUFACTURING MACHINES (U.S. CLS. 13, 19, 21, 23, 31, 34 AND 35).
 FIRST USE 9-0-2005; IN COMMERCE 8-18-2006.

CLASS 8—HAND TOOLS

3,177,369. FIRST YEARS INC., THE, STOUGHTON, MA. SN 76-453,981. PUB. 6-10-2003, FILED 9-30-2002.

SMART SERVE

FOR SPOONS (U.S. CLS. 23, 28 AND 44).
 FIRST USE 12-31-2001; IN COMMERCE 12-31-2001.

3,177,883. THE ONTARIO KNIFE COMPANY, FRANKLINVILLE, NY. SN 78-443,821. PUB. 11-8-2005, FILED 6-30-2004.

EXTREME MILITARY

THE MARK CONSISTS OF STANDARD CHARACTERS WITHOUT CLAIM TO ANY PARTICULAR FONT, STYLE, SIZE, OR COLOR.

NO CLAIM IS MADE TO THE EXCLUSIVE RIGHT TO USE "MILITARY", APART FROM THE MARK AS SHOWN.
 FOR KNIVES, NAMELY HUNTING KNIVES, FISHING KNIVES AND MILITARY KNIVES, BAYONETS, FOLDING POCKET KNIVES (U.S. CLS. 23, 28 AND 44).
 FIRST USE 8-2-2005; IN COMMERCE 8-2-2005.

CLASS 8—(Continued).

3,178,194. FAIR HILL PRECISION, LLC, HARRISONBURG, VA. SN 78-568,345. PUB. 11-29-2005, FILED 2-16-2005.

S & H JIGS

THE MARK CONSISTS OF STANDARD CHARACTERS WITHOUT CLAIM TO ANY PARTICULAR FONT, STYLE, SIZE, OR COLOR.

NO CLAIM IS MADE TO THE EXCLUSIVE RIGHT TO USE "JIGS", APART FROM THE MARK AS SHOWN.
 FOR HAND TOOLS AND IMPLEMENTS, NAMELY JIGS TO POSITION A DRILL FOR DRILLING HOLES FOR PULL HARDWARE ON CABINETS AND FURNITURE (U.S. CLS. 23, 28 AND 44).
 FIRST USE 2-27-2006; IN COMMERCE 2-27-2006.

3,178,355. KWEE, KWANG MING, MONTEREY PARK, CA. SN 78-599,487. PUB. 12-27-2005, FILED 3-31-2005.



THE MARK CONSISTS OF A CIRCLE CONTAINING A STYLIZED REPRESENTATION OF THE CHINESE CHARACTER FOR THE WORD "TOMORU".

THE NON-LATIN CHARACTER(S) IN THE MARK TRANSLITERATES INTO TOMORU, AND THIS MEANS TO "BURN" OR TO "BE LIGHTED" IN ENGLISH.
 FOR HAND TOOLS AND IMPLEMENTS, NAMELY HAND-OPERATED SCISSORS, SHEARS, NAIL CUTTERS AND NIPPERS (U.S. CLS. 23, 28 AND 44).
 FIRST USE 3-23-2006; IN COMMERCE 3-23-2006.

CLASS 8—(Continued).

3,178,592. APPLIED CONCEPTS, INC., COLORADO SPRINGS, CO. SN 78-701,981. PUB. 5-9-2006, FILED 8-27-2005.

ROBO ACP9

THE MARK CONSISTS OF STANDARD CHARACTERS WITHOUT CLAIM TO ANY PARTICULAR FONT, STYLE, SIZE, OR COLOR.

OWNER OF U.S. REG. NOS. 2,255,048 AND 2,258,856. FOR PLIERS (U.S. CLS. 23, 28 AND 44). FIRST USE 4-30-2000; IN COMMERCE 4-30-2000.

3,178,649. DEXTER-RUSSELL, INC., SOUTHBRIDGE, MA. SN 78-734,632. PUB. 1-31-2006, FILED 10-17-2005.

DEXTERGUARD

THE MARK CONSISTS OF STANDARD CHARACTERS WITHOUT CLAIM TO ANY PARTICULAR FONT, STYLE, SIZE, OR COLOR.

FOR ANTIBACTERIAL CHEMICAL ADDITIVES SOLD AS AN INTEGRAL COMPONENT OF KNIFE HANDLES (U.S. CLS. 23, 28 AND 44). FIRST USE 1-1-2006; IN COMMERCE 1-1-2006.

CLASS 9—ELECTRICAL AND SCIENTIFIC APPARATUS

3,177,332. MICROSEMI CORPORATION, SANTA ANA, CA. SN 76-110,512. PUB. 4-2-2002, FILED 8-17-2000.

MMSM

FOR MICROELECTRONIC SEMICONDUCTORS (U.S. CLS. 21, 23, 26, 36 AND 38). FIRST USE 8-0-2000; IN COMMERCE 8-0-2000.

3,177,367. SERVICIOS CONDUMEX S.A. DE C.V., QUERETARO, QRO., MEXICO. SN 76-452,869. PUB. 6-24-2003, FILED 9-20-2002.

SOLDALITZANEL

FOR MAGNET WIRE FOR ELECTRONIC EQUIPMENT OF HIGH FREQUENCY, NAMELY, RADIOS, TELEVISIONS, SOUND AND COMMUNICATION EQUIPMENT (U.S. CLS. 21, 23, 26, 36 AND 38). FIRST USE 8-20-2006; IN COMMERCE 8-20-2006.

CLASS 9—(Continued).

3,177,368. SERVICIOS CONDUMEX S.A. DE C.V., QUERETARO, QRO, MEXICO. SN 76-452,964. PUB. 6-24-2003, FILED 9-20-2002.

TERMALITZANEL

FOR MAGNET WIRE FOR ELECTRONIC EQUIPMENT OF HIGH FREQUENCY, NAMELY, RADIOS, TELEVISIONS, SOUND AND COMMUNICATION EQUIPMENT (U.S. CLS. 21, 23, 26, 36 AND 38). FIRST USE 8-20-2006; IN COMMERCE 8-20-2006.

3,177,378. SERVICE STATION PRODUCTS COMPANY, CHRISTIANA, DE. SN 76-498,656. PUB. 7-27-2004, FILED 3-19-2003.

STATIC-ON-SCREEN

FOR VIDEO DISPLAY MONITOR SOLD AS AN INTEGRAL COMPONENT OF VEHICLE TIRE BALANCING MACHINES (U.S. CLS. 21, 23, 26, 36 AND 38). FIRST USE 1-31-2005; IN COMMERCE 1-31-2005.

3,177,391. SEE IT SO L.L.C., AUSTIN, TX. SN 76-525,171. PUB. 6-15-2004, FILED 6-24-2003.

SEE IT SO

FOR COMPUTER GAME PROGRAMS; COMPACT DISCS AND DVDS FEATURING ADULT AND CHILDREN PROGRAMMING ON CORE EDUCATIONAL SUBJECTS SUCH AS MATHEMATICS, GEOGRAPHY, HISTORY, NATURAL AND ECOLOGICAL SCIENCES, ASTROLOGY, PHYSICAL EDUCATION, PHYSICS AND METAPHYSICS, SOCIAL STUDIES, ARTS, LANGUAGE ARTS, MUSIC, ANTHROPOLOGY, AND MYTHOLOGY, AND ON ALTERNATIVE CORE EDUCATIONAL SUBJECTS SUCH AS HOLISTIC PEDAGOGY AND HEALTH STUDIES, INTERGENERATIONAL STUDIES AND PROGRAMS, SCHOOL REFORM, PARENTING, CHILD DEVELOPMENT AND CHILD PSYCHOLOGY STUDIES AND PROGRAMS, INTUITIVE AND CREATIVITY DEVELOPMENT STUDIES AND PROGRAMS, SPIRITUALITY STUDIES, FANTASY AND FAIRYTALES, TRAVEL STUDIES AND PROGRAMS, EMOTIONAL INTELLIGENCE STUDIES, KINETICS, HUMANITARIAN AND BEHAVIORAL STUDIES AND PROGRAMS, PERSONAL EMPOWERMENT, PERSONAL COMMUNICATION AND INTRA-PERSONAL SKILLS STUDIES AND PROGRAMS (U.S. CLS. 21, 23, 26, 36 AND 38). FIRST USE 6-0-2006; IN COMMERCE 6-6-2006.

CLASS 9—(Continued).

3,177,392. SEE IT SO L.L.C., AUSTIN, TX. SN 76-525,172. PUB. 6-15-2004, FILED 6-24-2003.

CARING WINDS

FOR COMPUTER GAME PROGRAMS; COMPACT DISCS AND DVDS FEATURING ADULT AND CHILDREN PROGRAMMING ON CORE EDUCATIONAL SUBJECTS SUCH AS MATHEMATICS, GEOGRAPHY, HISTORY, NATURAL AND ECOLOGICAL SCIENCES, ASTROLOGY, PHYSICAL EDUCATION, PHYSICS AND METAPHYSICS, SOCIAL STUDIES, ARTS, LANGUAGE ARTS, MUSIC, ANTHROPOLOGY, AND MYTHOLOGY, AND ON ALTERNATIVE CORE EDUCATIONAL SUBJECTS SUCH AS HOLISTIC PEDAGOGY AND HEALTH STUDIES, INTERGENERATIONAL STUDIES AND PROGRAMS, SCHOOL REFORM, PARENTING, CHILD DEVELOPMENT AND CHILD PSYCHOLOGY STUDIES AND PROGRAMS, INTUITIVE AND CREATIVITY DEVELOPMENT STUDIES AND PROGRAMS, SPIRITUALITY STUDIES, FANTASY AND FAIRYTALES, TRAVEL STUDIES AND PROGRAMS, EMOTIONAL INTELLIGENCE STUDIES, KINETICS, HUMANITARIAN AND BEHAVIORAL STUDIES AND PROGRAMS, PERSONAL EMPOWERMENT, PERSONAL COMMUNICATION AND INTRA-PERSONAL SKILLS STUDIES AND PROGRAMS (U.S. CLS. 21, 23, 26, 36 AND 38).

FIRST USE 6-6-2006; IN COMMERCE 6-6-2006.

3,177,402. MC PERSON S.P.A., 33084 CORDENONS, PN, ITALY. SN 76-544,907. PUB. 8-23-2005, FILED 9-10-2003.



McPerson

FOR APPARATUS FOR RECORDING, TRANSMISSION OR REPRODUCTION OF SOUND OR IMAGES, NAMELY, LIQUID CRYSTAL TELEVISIONS; ELECTRONIC CALCULATING MACHINES; ELECTRONIC COMPUTERS; TEACHING APPARATUS, NAMELY, TELEVISIONS; TELEVISIONS FOR MANAGING HOUSEHOLD APPLIANCES AND FOR SAFETY USE (U.S. CLS. 21, 23, 26, 36 AND 38).

FIRST USE 9-13-1993; IN COMMERCE 7-17-1998.

CLASS 9—(Continued).

3,177,403. AMX LLC, ELMHURST, IL. SN 76-547,089. PUB. 12-13-2005, FILED 9-10-2003.



OWNER OF U.S. REG. NOS. 1,789,191 AND 2,858,726.
FOR COMPUTER HARDWARE, NAMELY COMMUNICATIONS SERVER DESIGNED TO STORE, MANAGE, DISTRIBUTE AND PROTECT DIGITAL AUDIO AND VIDEO DATA (U.S. CLS. 21, 23, 26, 36 AND 38).
FIRST USE 9-0-2003; IN COMMERCE 9-0-2003.

3,177,410. QORTEK, INC., WILLIAMSPORT, PA. SN 76-554,503. PUB. 5-17-2005, FILED 10-27-2003.

INTELLIFUNCTIONAL

FOR THIN-FILM ELECTRONICS HAVING THEREIN A MATRIX-LIKE ARRAY OF DEVICES, NAMELY, ACTUATORS, SENSORS, MONITORS, MEMS, ANTENNA PIXELS, BOUNDARY LAYER CONTROLLERS, SHAPE CONTROLLERS, DISTURBANCE COMPENSATORS, POWER DISTRIBUTION, POWER CONTROLLERS, OPTICS, SWITCHES, RELAYS, AND PROCESSORS; ADAPTIVE OPTICS, NAMELY, MIRRORS AND LIGHT RECEPTORS HAVING THEREON THIN-FILM ELECTRONICS WITH MATRIX-LIKE ARRAY OF DEVICES TO CONTROL THE SHAPE THEREOF (U.S. CLS. 21, 23, 26, 36 AND 38).

FIRST USE 7-22-2006; IN COMMERCE 7-22-2006.

3,177,418. DYNAMIC SYSTEM ELECTRONICS CORP., SAN CHUNG CITY, TAIPEI HSIEN, TAIWAN. SN 76-566,550. PUB. 11-29-2005, FILED 12-23-2003.



Zynet

FOR FLASH CARD READERS, COMPUTER CABLES, COMPUTER HARDWARE, COMPUTER PERIPHERALS; DISCS FOR COMPUTERS, NAMELY, MOBILE DISCS IN THE NATURE OF EXTERNAL HARD DISCS AND FLASH DISCS; MUSICAL JUKE BOXES (U.S. CLS. 21, 23, 26, 36 AND 38).

FIRST USE 2-0-2003; IN COMMERCE 8-0-2003.

CLASS 9—(Continued).

3,177,424. SONY KABUSHIKI KAISHA, TA SONY CORPORATION, SHINAGAWA-KU, TOKYO, JAPAN. SN 76-575,436. PUB. 10-25-2005, FILED 2-12-2004.



OWNER OF U.S. REG. NOS. 2,411,141 AND 2,411,142.
NO CLAIM IS MADE TO THE EXCLUSIVE RIGHT TO USE "ENGINE", APART FROM THE MARK AS SHOWN.
THE LINING SHOWN IN THE DRAWING IS A FEATURE OF THE MARK FOR SHADING PURPOSES AND IS NOT INTENDED TO INDICATE COLOR.
FOR VIDEO PROJECTORS (U.S. CLS. 21, 23, 26, 36 AND 38).
FIRST USE 6-30-2003; IN COMMERCE 6-30-2003.

3,177,425. INTERSTATE BATTERY SYSTEM INTERNATIONAL, INC., DALLAS, TX. SN 76-576,183. PUB. 11-15-2005, FILED 2-13-2004.

POWERFAST

THE MARK CONSISTS OF STANDARD CHARACTERS WITHOUT CLAIM TO ANY PARTICULAR FONT, STYLE, SIZE, OR COLOR.
OWNER OF U.S. REG. NO. 2,188,372.
FOR ELECTRICAL STORAGE BATTERIES; ELECTRICAL STORAGE BATTERIES, NAMELY ELECTRICAL STORAGE BATTERIES FOR USE IN TRANSPORTATION EQUIPMENT, NAMELY AUTOMOBILES, AIRCRAFTS, TRUCKS, CAMPERS, MARINE/BOATS, MOTORCYCLES, ALL TERRAIN VEHICLES, PERSONAL WATERCRAFTS (U.S. CLS. 21, 23, 26, 36 AND 38).
FIRST USE 7-1-2004; IN COMMERCE 7-1-2004.

CLASS 9—(Continued).

3,177,436. FIBEST, LTD., HACHIOJI CITY, TOKYO 192-0046, JAPAN. SN 76-583,362. PUB. 8-30-2005, FILED 3-25-2004.



THE COLOR(S) BLUE, LIGHT BLUE AND BLACK IS/ARE CLAIMED AS A FEATURE OF THE MARK.

THE MARK CONTAINS THE COLORS BLUE, LIGHT BLUE, BLACK AND WHITE. THE COLOR BLUE APPEARS ON THE LETTER "F", THE INTERIOR CIRCLE OF THE DOT ON THE LETTER "I", AND THE LINE UNDERSCORING THE DOT AND THE COMPONENT "BEST". THE COLOR LIGHT BLUE APPEARS ON THE OUTER RIM OF THE DOT OVER THE LETTER "I" THE COMPONENT "BEST" APPEARS IN BLACK. THE MARK IN ITS ENTIRETY IS ON A WHITE BACKGROUND.

THE MARK CONSISTS OF THE WORDING "FIBEST" IN STYLIZED FORM AND IN COLOR.

FOR FIBER OPTIC COMPONENTS, NAMELY, MODULATORS, TRANSMITTERS UNIT AND RECEIVERS UNIT (U.S. CLS. 21, 23, 26, 36 AND 38).

FIRST USE 7-12-2003; IN COMMERCE 11-5-2003.

3,177,447. ECI TELECOM LTD., PETACH TIKVA 49517, ISRAEL. SN 76-596,299. PUB. 10-25-2005, FILED 6-8-2004.

ALL PLAY

THE MARK CONSISTS OF STANDARD CHARACTERS WITHOUT CLAIM TO ANY PARTICULAR FONT, STYLE, SIZE, OR COLOR.

FOR TELECOMMUNICATION EQUIPMENT, NAMELY RADIO FREQUENCY AND OPTICAL SPLITTERS, RADIO FREQUENCY AND OPTICAL COMBINERS, RADIO FREQUENCY AND OPTICAL FILTERS, OPTICAL AND ELECTRICAL MULTIPLEXERS, OPTICAL AND ELECTRICAL TRANSMITTERS, OPTICAL AND ELECTRICAL TRANSCEIVERS, OPTICAL AND ELECTRICAL RECEIVERS, TRANSPONDERS, REPEATERS, OPTICAL AMPLIFIERS, CONTROLLERS FOR TELECOMMUNICATION NETWORKS, MODEMS, DIGITAL PROCESSORS FOR TELECOMMUNICATION NETWORKS, ROUTERS, BRIDGES, HUBS, STARS, SWITCHES FOR TELECOMMUNICATION NETWORKS, CROSS-CONNECTS, DIGITAL LOOP CONCENTRATORS, SERVERS, INTEGRATED CIRCUITS AND INTERFACES FOR TRANSMISSION OF SIGNALS OVER NETWORK INFRASTRUCTURE; TRANSMISSION EQUIPMENT, NAMELY OPTICAL AND ELECTRICAL MULTIPLEXERS, CROSS-CONNECTS, FIBERS, DISPERSION FIBERS, COMPENSATION FIBERS RADIO FREQUENCY AND OPTICAL TRANSMITTERS, TRANSCEIVERS, RADIO FREQUENCY AND OPTICAL RECEIVERS, TRANSPONDERS, SIGNAL REPEATERS; POWER SUPPLIERS FOR TELECOMMUNICATION NETWORKS; OPTICAL AND ELECTRICAL CONNECTORS FOR TELECOMMUNICATION NETWORKS; AUTOMATIC POWER EQUALIZERS; VOICE, VIDEO AND DATA TRANSMISSION SYSTEMS, NAMELY SIGNAL HANDLING HARDWARE AND SOFTWARE FOR TRANSMITTING, RECEIVING AND DELIVERING VOICE, VIDEO AND DATA COMMUNICATIONS OVER

CLASS 9—(Continued).

TRANSMISSION MEDIA, NAMELY FIBER OPTIC, COPPER TRANSMISSION LINES, COAX TRANSMISSION LINES, WIRELESS, POWER TRANSMISSION LINES OR SATELLITES; VOICE CODERS FOR SYNTHESIZING SPEECH; VIDEO COMPRESSOR UNITS FOR REDUCING THE REPRESENTATION OF INFORMATION BUT NOT THE INFORMATION ITSELF; VIDEO AND AUDIO EDITORS, NAMELY COMPUTER SOFTWARE, CIRCUITRY AND MODULES FOR EDITING VIDEO AND AUDIO SIGNALS; NETWORK MANAGEMENT SYSTEMS, NAMELY COMPUTER HARDWARE AND SOFTWARE FOR PLANNING, MANAGING AND CONTROLLING VOICE, VIDEO AND DATA COMMUNICATION OVER TRANSMISSION MEDIA, NAMELY FIBER OPTIC, COPPER TRANSMISSION LINES, COAX TRANSMISSION LINES, WIRELESS, POWER TRANSMISSION LINES OR SATELLITES; NETWORK ANALYSIS HARDWARE AND SOFTWARE FOR MONITORING COMMUNICATIONS BETWEEN NETWORK ELEMENTS; NETWORK PLANNING SOFTWARE TO DESIGN OR REDESIGN COMMUNICATIONS NETWORKS; HARDWARE AND SOFTWARE FOR MANAGING AND DESIGNING INTELLIGENT OPTICAL NETWORKS; AND FIBER OPTIC TRANSPORT EQUIPMENT FOR BROAD BAND CONNECTIVITY USING WAVE DIVISION MULTIPLEXING, NAMELY OPTICAL NETWORK INTERFACES, PROGRAMMABLE TRANSPORT TERMINALS, CROSS-CONNECTS AND FIBER OPTIC DATA LINKS; COMPUTER HARDWARE AND SOFTWARE FOR USE IN TRANSMITTING, FACILITATING, RECORDING, DISPLAYING, AND STORING VOICE, DATA, FACSIMILE AND VIDEO COMMUNICATIONS AND FOR USE IN ENHANCING, VERIFYING AND MAINTAINING THE PERFORMANCE AND ACCURACY OF TELECOMMUNICATIONS SYSTEMS ALL FOR GENERAL USE WITH TELECOMMUNICATIONS SYSTEMS, AND INSTRUCTION MANUALS SOLD AS A UNIT THEREWITH (U.S. CLS. 21, 23, 26, 36 AND 38).

FIRST USE 6-0-2004; IN COMMERCE 6-0-2004.

3,177,472. LONG HUEI HELMET CO., YUNG KANG CITY, TAINAN, TAIWAN. SN 76-609,129. PUB. 12-13-2005, FILED 8-30-2004.

SUNDA

THE MARK CONSISTS OF STANDARD CHARACTERS WITHOUT CLAIM TO ANY PARTICULAR FONT, STYLE, SIZE, OR COLOR.

FOR SAFETY HELMETS, PROTECTIVE HELMETS (U.S. CLS. 21, 23, 26, 36 AND 38).

FIRST USE 8-1-2001; IN COMMERCE 8-1-2001.

CLASS 9—(Continued).

3,177,484. RITEK CORPORATION, HSIN CHU INDUSTRIAL PARK, TAIWAN. SN 76-610,336. PUB. 12-27-2005, FILED 9-7-2004.

Alisan

FOR BLANK OPTICAL DISCS, NAMELY CD-R, CD-RW, DVD-R, DVD-RW, DVD+R, DVD+RW, DVD-RAM, MINI DISC AND MAGNETO-OPTICAL DISC; COMPACT FLASH MEMORY CARDS; SMART MEDIA MEMORY CARDS; SECURE DIGITAL MEMORY CARDS; MULTIMEDIA MEMORY CARDS; MEMORY CARDS; USB DRIVES; MEMORY CARD READER; MEMORY CARD ADAPTOR; CD WRITERS; DVD WRITERS; CD DUPLICATORS; DVD DUPLICATORS; MP3 PLAYERS; PORTABLE MEDIA PLAYER (U.S. CLS. 21, 23, 26, 36 AND 38).

FIRST USE 7-7-2006; IN COMMERCE 7-14-2006.

3,177,495. LMT ENTERPRISES, LLC, KANSAS CITY, MO. SN 76-613,268. PUB. 12-13-2005, FILED 9-22-2004.



NO CLAIM IS MADE TO THE EXCLUSIVE RIGHT TO USE JAZZ, APART FROM THE MARK AS SHOWN.

FOR PRERECORDED COMPACT DISCS, CASSETTES, RECORDS, AND TAPES FEATURING MUSIC (U.S. CLS. 21, 23, 26, 36 AND 38).

FIRST USE 10-10-2004; IN COMMERCE 10-10-2004.

3,177,504. LOWRANCE ELECTRONICS, INC., TULSA, OK. SN 76-616,005. PUB. 10-4-2005, FILED 10-15-2004.



THE COLOR(S) RED, BLACK AND WHITE AS A FEATURE OF THE MARK.

CLASS 9—(Continued).

THE COLOR RED APPEARS AS THE SHADING IN THE CIRCLE. THE COLOR BLACK APPEARS IN THE TERM WAY AND HIGHWAY DESIGN AND THE COLOR WHITE APPEARS IN THE LETTER I AND IN THE HIGHWAY DESIGN.

THE MARK CONSISTS IN PART OF A STYLIZED CURVED PORTION OF A HIGHWAY.

FOR VEHICLE NAVIGATION SYSTEM CONSISTING OF A VISUAL DISPLAY UNIT AND/OR AUDIO OUTPUT, UTILIZING A DATABASE OF MAP COORDINATES AND OTHER LOCATIONS, GLOBAL POSITIONING SATELLITE RECEIVER, AND ELECTRICAL CABLE (U.S. CLS. 21, 23, 26, 36 AND 38).

FIRST USE 10-31-2004; IN COMMERCE 10-31-2004.

3,177,518. TUBE CITY, LLC, GLASSPORT, PA. SN 76-622,364. PUB. 3-7-2006, FILED 11-26-2004.

GENBLEND

THE MARK CONSISTS OF STANDARD CHARACTERS WITHOUT CLAIM TO ANY PARTICULAR FONT, STYLE, SIZE, OR COLOR.

FOR COMPUTER SOFTWARE FOR USE IN PURCHASING, AND FORMULATING FURNACE CHARGES OF, RAW MATERIALS IN THE FIELDS OF STEELMAKING AND METALS PRODUCTION (U.S. CLS. 21, 23, 26, 36 AND 38).

FIRST USE 8-15-2006; IN COMMERCE 8-15-2006.

3,177,519. ASCEND MEDIA, LLC, OVERLAND PARK, KS. SN 76-622,498. PUB. 11-22-2005, FILED 11-26-2004.

BREATHE WORK PLAY

THE MARK CONSISTS OF STANDARD CHARACTERS WITHOUT CLAIM TO ANY PARTICULAR FONT, STYLE, SIZE, OR COLOR.

FOR DOWNLOADABLE PERIODICAL ELECTRONIC PUBLICATIONS IN THE MEDICAL FIELD (U.S. CLS. 21, 23, 26, 36 AND 38).

FIRST USE 1-0-2005; IN COMMERCE 1-0-2005.

CLASS 9—(Continued).

3,177,528. PENTON OVERSEAS, INC., CARLSBAD, CA. SN 76-625,311. PUB. 11-29-2005, FILED 12-21-2004.

ACCENT AMERICA!

THE MARK CONSISTS OF STANDARD CHARACTERS WITHOUT CLAIM TO ANY PARTICULAR FONT, STYLE, SIZE, OR COLOR.

FOR PRE-RECORDED AUDIO COMPACT DISCS; AND PRE-RECORDED AUDIO COMPACT DISCS, BOOKS AND PAMPHLETS SOLD AS A UNIT, ALL OF WHICH FEATURING ENGLISH LANGUAGE SPEAKING AND PRONUNCIATION (U.S. CLS. 21, 23, 26, 36 AND 38).

FIRST USE 3-18-2006; IN COMMERCE 3-18-2006.

3,177,541. SKC INC., EIGHTY FOUR, PA. SN 76-632,137. PUB. 11-29-2005, FILED 2-25-2005.

FIBERCHEK

THE MARK CONSISTS OF STANDARD CHARACTERS WITHOUT CLAIM TO ANY PARTICULAR FONT, STYLE, SIZE, OR COLOR.

FOR SERIES OF PRODUCTS FOR THE ANALYSIS OF FIBERS INCLUDING ASBESTOS AND FIBERGLASS; NAMELY, GLASS SLIDES CONTAINING FIBERS AND COVER GLASSES ETCHED WITH A RELOCATABLE GRID TO AID IN LABORATORY TRAINING, COUNT STANDARDIZATION, ANALYSIS, AND VERIFICATION (U.S. CLS. 21, 23, 26, 36 AND 38).

FIRST USE 1-0-2006; IN COMMERCE 1-0-2006.

3,177,547. PORTICUS TECHNOLOGY, INC., NEEDHAM, MA. SN 76-633,686. PUB. 12-20-2005, FILED 3-17-2005.

PORTICUS

THE MARK CONSISTS OF STANDARD CHARACTERS WITHOUT CLAIM TO ANY PARTICULAR FONT, STYLE, SIZE, OR COLOR.

FOR COMPUTER SOFTWARE FOR PROCESSING, MANAGING, AND AUTHENTICATING USER BIOMETRIC DATA AND LOCATION AWARE DATA IN THE FIELD OF ONLINE AND WIRELESS SECURITY (U.S. CLS. 21, 23, 26, 36 AND 38).

FIRST USE 3-0-2005; IN COMMERCE 6-14-2006.

CLASS 9—(Continued).

3,177,574. J.A. WOOLLAM CO. INC., LINCOLN, NE. SN 76-642,718. PUB. 4-4-2006, FILED 7-13-2005.

MASE

THE MARK CONSISTS OF STANDARD CHARACTERS WITHOUT CLAIM TO ANY PARTICULAR FONT, STYLE, SIZE, OR COLOR.

FOR EQUIPMENT, NAMELY ELLIPSOMETER BASED APPARATUS FOR MEASURING THICKNESS AND OPTICAL PROPERTIES OF SEMICONDUCTOR, DISK DRIVE, MAGNETIC DATA STORAGE MEDIA, OPTICAL DATA STORAGE MEDIA, THIN FILMS AND MULTIPLE LAYER FILMS ON SUBSTRATES AND COATINGS, INCLUDING TEMPERATURE CAUSED EFFECTS, AND COMPUTER PROGRAMS NECESSARY FOR CONTROLLING THE ELLIPSOMETER BASED APPARATUS AND FOR ANALYZING ACQUIRED ELLIPSO-METRIC DATA (U.S. CLS. 21, 23, 26, 36 AND 38).

FIRST USE 5-20-2005; IN COMMERCE 5-20-2005.

3,177,580. KAPLAN, ELI H., BROOKLYN, NY. SN 76-645,387. PUB. 5-9-2006, FILED 8-22-2005.

SHADOWHEAD RECORDS

THE MARK CONSISTS OF STANDARD CHARACTERS WITHOUT CLAIM TO ANY PARTICULAR FONT, STYLE, SIZE, OR COLOR.

NO CLAIM IS MADE TO THE EXCLUSIVE RIGHT TO USE "RECORDS", APART FROM THE MARK AS SHOWN.

FOR PHONOGRAPH RECORDS FEATURING MUSIC; AUDIO CASSETTE TAPES FEATURING MUSIC; COMPACT DISCS FEATURING MUSIC; DOWNLOADABLE DIGITAL AUDIO FILES THROUGH THE INTERNET FEATURING MUSIC; DVDS FEATURING MUSIC; ENHANCED CDS FEATURING MUSIC; PRERECORDED VIDEO TAPES FEATURING MUSIC; VIDEO GAME DISC; VIDEO DISCS FEATURING MUSIC (U.S. CLS. 21, 23, 26, 36 AND 38).

FIRST USE 5-15-2006; IN COMMERCE 5-15-2006.

CLASS 9—(Continued).

3,177,592. SEIKO INSTRUMENTS KABUSHIKI KAISHA, TA SEIKO INSTRUMENTS INC., CHIBA 261-8507, JAPAN. SN 76-978,365. PUB. 2-1-2005, FILED 10-3-2003.

Color Painter

NO CLAIM IS MADE TO THE EXCLUSIVE RIGHT TO USE COLOR, APART FROM THE MARK AS SHOWN.

FOR PRINTERS; COMPUTER PERIPHERALS; AND THEIR PARTS AND ACCESSORIES, NAMELY, PRINTER HEADS, PAPER FEED ROLLERS, PLATEN ROLLERS AND PRINTER CLEANING KITS PRIMARILY COMPRISED OF UNFILLED INK PRINTER CARTRIDGES FOR CLEANING PURPOSES, PRINTER CLEANING CLOTHS AND PRINTER CLEANING STICKS (U.S. CLS. 21, 23, 26, 36 AND 38).

FIRST USE 11-14-2003; IN COMMERCE 11-14-2003.

3,177,602. TENDERLOIN TECHNOLOGIES, INC., TRESURE ISLAND, CA. SN 78-128,111. PUB. 6-24-2003, FILED 5-13-2002.

BROWN BOTTLE RECORDS

NO CLAIM IS MADE TO THE EXCLUSIVE RIGHT TO USE "RECORDS", APART FROM THE MARK AS SHOWN.

FOR MUSICAL SOUND RECORDINGS; DIGITAL MUSIC DOWNLOADABLE FROM THE INTERNET; COMPACT DISCS AND DVD'S FEATURING PRE-RECORDED MUSICAL PERFORMANCES (U.S. CLS. 21, 23, 26, 36 AND 38).

FIRST USE 2-28-2006; IN COMMERCE 2-28-2006.

3,177,605. PRIVITY VENTURES, INC., CARSON CITY, NV. SN 78-134,381. PUB. 5-13-2003, FILED 6-10-2002.

BESTWORKFLOW

FOR DOWNLOADABLE COMPUTER PROGRAMMING LANGUAGE SOFTWARE THAT ENABLES USERS TO CREATE PROGRAMS THAT MODEL, MEASURE AND IMPROVE COORDINATION WITHIN AND AMONG ORGANIZATIONS AND COMPUTER SYSTEMS, AND TO CREATE PROGRAMS THAT MODEL, MEASURE AND IMPROVE COMMUNICATION AMONG PEOPLE (U.S. CLS. 21, 23, 26, 36 AND 38).

FIRST USE 12-1-2002; IN COMMERCE 12-1-2002.

3,177,607. RADO UHREN AG (RADO WATCH CO. LTD.) (MONTRES RADO S.A.), LENGNAU, SWITZERLAND. SN 78-137,816. PUB. 6-24-2003, FILED 6-21-2002.

RADO

PRIORITY CLAIMED UNDER SEC. 44(D) ON SWITZERLAND APPLICATION NO. 05125/2002, FILED 6-7-2002, REG.

CLASS 9—(Continued).

NO. 500677, DATED 6-7-2002, EXPIRES 6-7-2012.
OWNER OF U.S. REG. NOS. 788,733, 1,729,207, AND OTHERS.

FOR EYEGLASSES, SUNGLASSES, MAGNIFYING GLASSES; CASES, FRAMES, AND CHAINS FOR EYEGLASSES AND SUNGLASSES (U.S. CLS. 21, 23, 26, 36 AND 38).

FIRST USE 8-11-2006; IN COMMERCE 8-11-2006.

3,177,611. INNERCOOL THERAPIES, INC., SAN DIEGO, CA.
SN 78-149,394. PUB. 4-22-2003, FILED 7-31-2002.

ACCUTROL

FOR SOFTWARE AND ACCOMPANYING SENSOR USED FOR DETERMINATION OF A TARGET TEMPERATURE FOR USE IN MEDICAL PROCEDURES EMPLOYING HYPOTHERMIA (U.S. CLS. 21, 23, 26, 36 AND 38).

FIRST USE 4-1-2003; IN COMMERCE 4-1-2003.

3,177,613. AB INITIO SOFTWARE CORPORATION, LEXINGTON, MA. SN 78-153,394. PUB. 10-21-2003, FILED 8-12-2002.

**ENTERPRISE
METAENVIRONMENT**

NO CLAIM IS MADE TO THE EXCLUSIVE RIGHT TO USE "ENTERPRISE", APART FROM THE MARK AS SHOWN.

FOR COMPUTER PROGRAMS FOR THE MANAGEMENT AND MAINTENANCE OF A DATA PROCESSING REPOSITORY FOR METADATA, APPLICATION PROGRAMS, AND APPLICATION PROGRAM EXECUTION RESULTS; COMPUTER PROGRAMS FOR COMMUNICATING AND PROCESSING DATA AMONG MULTIPLE COMPUTER SYSTEMS AND OPERATING SYSTEMS; DATA PROCESSING COMPUTER PROGRAMS FOR PROCESSING LARGE VOLUMES OF DATA (U.S. CLS. 21, 23, 26, 36 AND 38).

FIRST USE 4-24-2006; IN COMMERCE 4-24-2006.

3,177,618. OWENS-CORNING FIBERGLAS TECHNOLOGY INC., SUMMIT, IL. SN 78-159,176. PUB. 12-16-2003, FILED 8-29-2002.

**GEM GLOBAL ENERGY
MASTER**

NO CLAIM IS MADE TO THE EXCLUSIVE RIGHT TO USE "ENERGY", APART FROM THE MARK AS SHOWN.

FOR COMPUTER PROGRAM TO EVALUATE THE COST EFFECTIVENESS OF INSULATION, WINDOWS, AND OTHER ENERGY EFFICIENCY MEASURES IN RESIDENTIAL AND COMMERCIAL BUILDINGS (U.S. CLS. 21, 23, 26, 36 AND 38).

FIRST USE 6-28-2006; IN COMMERCE 6-28-2006.

CLASS 9—(Continued).

3,177,622. WEIHING, EWALD, KUSTERDINGEN, FED REP GERMANY. AND WEIHING, JORG, TUBINGEN, FED REP GERMANY. AND WEIHING, ROBERT, TUBINGEN, FED REP GERMANY. SN 78-176,393. PUB. 12-23-2003, FILED 10-21-2002.

DOTPROOF

FOR SOFTWARE PROGRAMS FOR PROCESSING ON ELECTRONIC DATA PROCESSING MACHINES; SOFTWARE PROGRAMS RECORDED ON MACHINE-READABLE DATA CARRIERS FOR COLOR MANAGEMENT FOR PRINTERS AND OTHER OUTPUT DEVICES, NAMELY, CALIBRATION, PROFILE CREATION AND PROOFING; SOFTWARE PROGRAMS FOR CONTROLLING PRINTERS, IN PARTICULAR FOR CONTROLLING INK AND LASER PRINTERS; SOFTWARE PROGRAMS FOR THE COLOR-SPECIFIC CONTROL OF COLOR PRINTERS, IN PARTICULAR COLOR INK AND COLOR LASER PRINTERS; COLOR MANAGEMENT SOFTWARE, NAMELY, SOFTWARE PROGRAMS FOR CREATING COLOR PROFILES; SOFTWARE PROGRAMS FOR THE CONVERSION AND TRANSFORMATION OF DIGITAL DATA, IN PARTICULAR COLOR TRANSFORMATION OF DIGITAL DATA; SOFTWARE PROGRAMS FOR PROFILING AND OPTIMIZING RGB AND CMYK DATA, IN PARTICULAR FOR USE IN PRINTING, IN THE PRE-PRESS INDUSTRY AND IN DIGITAL PHOTOGRAPHY; SOFTWARE PROGRAMS FOR THE CONVERSION OF POSTSCRIPT AND PDF FILES INTO TIF FILES (U.S. CLS. 21, 23, 26, 36 AND 38).

FIRST USE 2-0-2002; IN COMMERCE 8-9-2002.

3,177,647. DIPIPPPO, PHILIP, A., OAKLAND, CA. AND PAOLINO, KEITH, J., OAKLAND, CA. SN 78-237,609. PUB. 2-1-2005, FILED 4-14-2003.

THE GROOVE MONSTER

FOR MUSICAL SOUND RECORDINGS (U.S. CLS. 21, 23, 26, 36 AND 38).

FIRST USE 12-5-1994; IN COMMERCE 5-10-1995.

3,177,666. ROKU, L.L.C., PALO ALTO, CA. SN 78-279,128. PUB. 6-6-2006, FILED 7-25-2003.

ROKU

THE WORD "ROKU" MEANS "SIX" IN JAPANESE.
FOR COMPUTER HARDWARE; COMPUTER PERIPHERALS; COMPUTER SOFTWARE FOR PERSONALIZED, INTERACTIVE TELEVISION PROGRAMMING AND ACCOMPANYING MANUALS DISTRIBUTED THEREWITH; COMPUTER SOFTWARE FOR USE IN GENERATING, DISPLAYING AND MANIPULATING VISUAL MEDIA, GRAPHIC IMAGES, PHOTOGRAPHS, ILLUSTRATIONS, DIGITAL ANIMATION, VIDEO CLIPS, FILM FOOTAGE AND AUDIO DATA (U.S. CLS. 21, 23, 26, 36 AND 38).

FIRST USE 10-0-2003; IN COMMERCE 10-0-2003.

CLASS 9—(Continued).

3,177,687. ECLECTIC INVESTMENTS, INC., NEWPORT BEACH, CA. SN 78-302,303. PUB. 7-12-2005, FILED 9-18-2003.



NO CLAIM IS MADE TO THE EXCLUSIVE RIGHT TO USE "FINGERPRINT BIOMETRIC IDENTITY DRIVE", APART FROM THE MARK AS SHOWN.
FOR COMPUTER HARDWARE AND SOFTWARE FOR STORING DATA AND PERMITTING ACCESS THERETO ON SECURE BASIS (U.S. CLS. 21, 23, 26, 36 AND 38).
FIRST USE 5-5-2005; IN COMMERCE 5-5-2005.

3,177,696. IGT, RENO, NV. SN 78-317,904. PUB. 11-15-2005, FILED 10-23-2003.

ALL OR NUT'N KENO

NO CLAIM IS MADE TO THE EXCLUSIVE RIGHT TO USE "KENO", APART FROM THE MARK AS SHOWN.
FOR GAMING MACHINES, NAMELY, SLOT MACHINES OR LOTTERY TERMINALS WITH OR WITHOUT VIDEO OUTPUT (U.S. CLS. 21, 23, 26, 36 AND 38).
FIRST USE 3-15-2004; IN COMMERCE 3-15-2004.

3,177,700. PARASOFT CORPORATION, MONROVIA, CA. SN 78-320,491. PUB. 8-23-2005, FILED 10-29-2003.

BPEL MAESTRO

NO CLAIM IS MADE TO THE EXCLUSIVE RIGHT TO USE BPEL, APART FROM THE MARK AS SHOWN.
FOR COMPUTER SOFTWARE DEVELOPMENT TOOLS FOR BPEL PROCESS MANAGEMENT, EXCLUDING PRODUCTS FOR USE IN CONNECTION WITH PAYMENT CARD, BANKING AND AUTOMATED TELLER MACHINE (ATM) PRODUCTS AND SERVICES (U.S. CLS. 21, 23, 26, 36 AND 38).
FIRST USE 7-1-2005; IN COMMERCE 7-1-2005.

CLASS 9—(Continued).

3,177,708. REAL-E STUDIOS, LLC, ARVADA, CO. SN 78-328,633. PUB. 6-21-2005, FILED 11-16-2003.

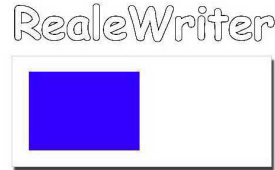

THE STIPPLING SHOWN IN THE DRAWING IS A FEATURE OF THE MARK.
THE COLOR(S) BLUE, WHITE, AND GRAY IS/ARE CLAIMED AS A FEATURE OF THE MARK.
THE MARK CONSISTS OF REALEWRITER IN THE COLOR WHITE AND A LARGE THREE DIMENSIONAL RECTANGLE IN WHICH A SMALLER, ROYAL BLUE COLORED RECTANGLE APPEARS WITHIN THE LEFT HALF. THE LARGE RECTANGLE IS OUTLINED BY THE COLOR GRAY WITH THE LOWER AND RIGHT HAND EDGES BEING STIPPLING TO PRODUCE A THREE DIMENSIONAL EFFECT.
FOR COMPUTER SOFTWARE THAT IS USED FOR WRITING AND PUBLISHING ELECTRONIC PICTURE BOOKS (U.S. CLS. 21, 23, 26, 36 AND 38).
FIRST USE 9-1-2006; IN COMMERCE 9-1-2006.

3,177,709. CERES, INC., THOUSAND OAKS, CA. SN 78-330,913. PUB. 6-7-2005, FILED 11-20-2003.



THE MARK CONSISTS OF A STYLIZED LETTER "C" IN THE FORM OF A SPIRAL ABOVE THE WORD "CERES".
FOR COMPUTER SOFTWARE FOR GENE ANALYSIS IN THE FIELD OF BIOTECHNOLOGY AND GENOMICS (U.S. CLS. 21, 23, 26, 36 AND 38).
FIRST USE 12-28-2005; IN COMMERCE 12-28-2005.

CLASS 9—(Continued).

3,177,711. DIGITALL SRL, MILAN, ITALY. SN 78-331,294. PUB. 4-26-2005, FILED 11-21-2003.

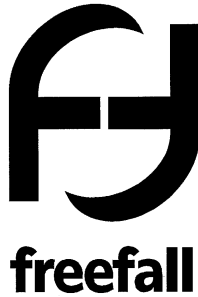

PRIORITY CLAIMED UNDER SEC. 44(D) ON UNITED KINGDOM APPLICATION NO. 2332815, FILED 5-21-2003.

THE MARK CONSISTS OF TWO STYLIZED LETTERS "F", THE SECOND ONE IN AN INVERTED POSITION FACING THE FIRST; UNDERNEATH THESE LETTERS THERE APPEARS THE WORD "FREEFALL" ALSO IN STYLIZED LETTERS.

FOR ELECTRICAL AND ELECTRONIC DEVICES FOR COIN DETECTION, COIN COUNTING AND COIN VERIFICATION; LASER BASED COIN DETECTION EQUIPMENT; PARTS AND FITTINGS FOR THE AFORESAID GOODS (U.S. CLS. 21, 23, 26, 36 AND 38).

FIRST USE 1-1-2003; IN COMMERCE 3-1-2004.

3,177,725. HIGHPOINT SOFTWARE SYSTEMS, LLC, WAUKESHA, WI. SN 78-345,342. PUB. 6-21-2005, FILED 12-24-2003.

Sage

THE MARK CONSISTS OF STANDARD CHARACTERS WITHOUT CLAIM TO ANY PARTICULAR FONT, STYLE, SIZE, OR COLOR.

FOR COMPUTER SOFTWARE FOR DISCRETE EVENT SIMULATION, NAMELY SOFTWARE THAT ALLOWS ONGOING DISCRETE EVENT SIMULATIONS IN REAL TIME AND MANAGED TIME TO PERMIT OPTIMIZATION, VISUALIZATION AND EVALUATION OF INTER-RELATED ACTIVITIES (U.S. CLS. 21, 23, 26, 36 AND 38). FIRST USE 3-31-2006; IN COMMERCE 3-31-2006.

CLASS 9—(Continued).

3,177,733. MAGIQ TECHNOLOGIES, INC., NEW YORK, NY. SN 78-353,581. PUB. 5-30-2006, FILED 1-19-2004.

QPN

THE MARK CONSISTS OF STANDARD CHARACTERS WITHOUT CLAIM TO ANY PARTICULAR FONT, STYLE, SIZE, OR COLOR.

FOR OPTO-ELECTRONIC ENCRYPTION UNIT THAT EMPLOYS PRINCIPALS OF QUANTUM KEY DISTRIBUTION (QKD) AND ENCRYPTION NETWORK FORMED FROM SUCH QKD OPTO-ELECTRONIC ENCRYPTION UNITS (U.S. CLS. 21, 23, 26, 36 AND 38).

FIRST USE 3-1-2004; IN COMMERCE 3-1-2004.

3,177,735. IGT, RENO, NV. SN 78-356,017. PUB. 7-6-2004, FILED 1-22-2004.

WIN A LATTE

THE MARK CONSISTS OF STANDARD CHARACTERS WITHOUT CLAIM TO ANY PARTICULAR FONT, STYLE, SIZE, OR COLOR.

FOR GAMING MACHINES, NAMELY, SLOT MACHINES WITH OR WITHOUT VIDEO OUTPUT, VIDEO LOTTERY TERMINALS, GAMING MACHINES FOR PLAY OF AN INTERACTIVE, ELECTRONIC CLASS II BINGO GAME (U.S. CLS. 21, 23, 26, 36 AND 38). FIRST USE 3-31-2006; IN COMMERCE 5-16-2006.

CLASS 9—(Continued).

3,177,736. IGT, RENO, NV. SN 78-356,832. PUB. 7-6-2004, FILED 1-23-2004.

ALL-STAR POKER

THE MARK CONSISTS OF STANDARD CHARACTERS WITHOUT CLAIM TO ANY PARTICULAR FONT, STYLE, SIZE, OR COLOR.

OWNER OF U.S. REG. NOS. 2,145,783, 2,519,800, AND OTHERS.

NO CLAIM IS MADE TO THE EXCLUSIVE RIGHT TO USE "POKER", APART FROM THE MARK AS SHOWN.

FOR GAMING MACHINES, NAMELY, SLOT MACHINES WITH OR WITHOUT VIDEO OUTPUT, VIDEO LOTTERY TERMINALS, GAMING MACHINES FOR PLAY OF AN INTERACTIVE, ELECTRONIC BINGO GAME (U.S. CLS. 21, 23, 26, 36 AND 38).

FIRST USE 4-24-2006; IN COMMERCE 8-9-2006.

3,177,739. PACIFIC LINK TRADE USA, INC., DALTON, GA. SN 78-358,128. PUB. 2-8-2005, FILED 1-27-2004.

PACIFIC BLUE

THE MARK CONSISTS OF STANDARD CHARACTERS WITHOUT CLAIM TO ANY PARTICULAR FONT, STYLE, SIZE, OR COLOR.

FOR EYEGLASSES, SUNGLASSES, EYEGLASS FRAMES, EYEGLASS CASES (U.S. CLS. 21, 23, 26, 36 AND 38).

FIRST USE 1-0-2004; IN COMMERCE 1-0-2004.

CLASS 9—(Continued).

3,177,748. FUJI PHOTO FILM U.S.A., INC., VALHALLA, NY. SN 78-364,896. PUB. 12-28-2004, FILED 2-9-2004.

LAB\$ENSE

THE MARK CONSISTS OF STANDARD CHARACTERS WITHOUT CLAIM TO ANY PARTICULAR FONT, STYLE, SIZE, OR COLOR.

FOR SUITE OF MANAGEMENT SOFTWARE TOOLS USED TO COLLECT, CENTRALIZE AND REPORT ACTUAL PRODUCTION DATA; TO EXAMINE COLLECTED DATA AND ISSUE KEY COMPARISONS; TO TRACK AND MONITOR ORDERS SENT TO REMOTE LOCATIONS; AND TO COLLECT DIAGNOSTIC AND OPERATIONAL DATA FROM REMOTE LOCATIONS, FOR PHOTOGRAPHIC PROCESSING LABORATORIES (U.S. CLS. 21, 23, 26, 36 AND 38).

FIRST USE 5-24-2006; IN COMMERCE 5-24-2006.

3,177,749. FUJI PHOTO FILM U.S.A., INC., VALHALLA, NY. SN 78-364,908. PUB. 12-28-2004, FILED 2-9-2004.

LABSENSE

THE MARK CONSISTS OF STANDARD CHARACTERS WITHOUT CLAIM TO ANY PARTICULAR FONT, STYLE, SIZE, OR COLOR.

FOR SUITE OF MANAGEMENT SOFTWARE TOOLS USED TO COLLECT, CENTRALIZE AND REPORT ACTUAL PRODUCTION DATA; TO EXAMINE COLLECTED DATA AND ISSUE KEY COMPARISONS; TO TRACK AND MONITOR ORDERS SENT TO REMOTE LOCATIONS; AND TO COLLECT DIAGNOSTIC AND OPERATIONAL DATA FROM REMOTE LOCATIONS, FOR PHOTOGRAPHIC PROCESSING LABORATORIES (U.S. CLS. 21, 23, 26, 36 AND 38).

FIRST USE 5-24-2006; IN COMMERCE 5-24-2006.

CLASS 9—(Continued).

3,177,757. MAYVILLE PRODUCTS CORPORATION, MAYVILLE, WI. SN 78-369,613. PUB. 12-21-2004, FILED 2-18-2004.

STANTRON

THE MARK CONSISTS OF STANDARD CHARACTERS WITHOUT CLAIM TO ANY PARTICULAR FONT, STYLE, SIZE, OR COLOR.

FOR ENCLOSURES, CABINETS, AND RACKS FOR HOUSING AND PROTECTING ELECTRONIC EQUIPMENT, COMPUTER HARDWARE, AND TELECOMMUNICATION EQUIPMENT (U.S. CLS. 21, 23, 26, 36 AND 38).

FIRST USE 1-1-2002; IN COMMERCE 1-1-2002.

3,177,763. RED CHIP COMPANY LTD., CAY ROAD TOWN, TORTOLA, BR. VIRGIN ISLANDS. SN 78-373,591. PUB. 11-30-2004, FILED 2-25-2004.

HARD ATTACK

THE MARK CONSISTS OF STANDARD CHARACTERS WITHOUT CLAIM TO ANY PARTICULAR FONT, STYLE, SIZE, OR COLOR.

FOR AUDIO EQUIPMENT, NAMELY, LOUDSPEAKERS (U.S. CLS. 21, 23, 26, 36 AND 38).

FIRST USE 1-12-2006; IN COMMERCE 2-17-2006.

CLASS 9—(Continued).

3,177,771. UNIVERSAL INTERACTIVE, INC., LOS ANGELES, CA. SN 78-382,654. PUB. 6-28-2005, FILED 3-11-2004.

TWINSANITY

THE MARK CONSISTS OF STANDARD CHARACTERS WITHOUT CLAIM TO ANY PARTICULAR FONT, STYLE, SIZE, OR COLOR.

FOR COMPUTER GAME SOFTWARE; AUDIO CASSETTES, PRE-RECORDED VIDEO CASSETTES, DVD'S, CD'S AND CD-ROM'S ALL FEATURING MUSICAL SCORES AND DIALOG IN THE FIELD OF VIDEO GAME ENTERTAINMENT; ENTERTAINMENT COMPUTER GAME SOFTWARE IN THE NATURE OF A GAME CAPABLE OF BEING PLAYED ON A PERSONAL COMPUTER, TELEVISION GAMING SYSTEM, PORTABLE GAMING SYSTEM, GLOBAL COMPUTER NETWORK, CELLULAR TELEPHONE, PERSONAL DIGITAL ASSISTANT AND WIRELESS COMMUNICATION DEVICE; DOWNLOADABLE ELECTRONIC PUBLICATIONS, NAMELY NEWSLETTERS, MAGAZINES AND CATALOGUES IN THE FIELD OF VIDEO GAME ENTERTAINMENT; PHOTOGRAPHIC CAMERAS; RADIOS; SUNGLASSES; DECORATIVE MAGNETS; VIDEO GAMES CARTRIDGES, VIDEO GAME TAPE CASSETTES; MOUSE PADS (U.S. CLS. 21, 23, 26, 36 AND 38).

FIRST USE 10-5-2004; IN COMMERCE 10-5-2004.

3,177,778. VTECH ELECTRONICS NORTH AMERICA, LLC, ARLINGTON HEIGHTS, IL. SN 78-386,245. PUB. 12-27-2005, FILED 3-17-2004.

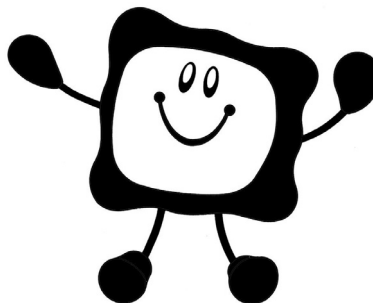

THE MARK CONSISTS OF A CARICATURE OF A VIDEO SCREEN HAVING A FACE, ARMS AND LEGS.

FOR ELECTRONIC AUDIO-VIDEO ENTERTAINMENT MACHINES FOR USE WITH TELEVISIONS, COMPUTER MONITORS AND OTHER VIDEO DISPLAYS; INPUT DEVICES, NAMELY VIDEO CONTROL JOYSTICKS; COMPUTER ENTERTAINMENT SOFTWARE FEATURING GAMES, MUSIC AND GRAPHIC IMAGES; COMPUTER ENTERTAINMENT SOFTWARE CARTRIDGES, NAMELY, COMPUTER GAME CARTRIDGES (U.S. CLS. 21, 23, 26, 36 AND 38).

FIRST USE 6-1-2004; IN COMMERCE 6-1-2004.

CLASS 9—(Continued).

3,177,780. ATMEL CORPORATION, SAN JOSE, CA. SN 78-386,739. PUB. 12-7-2004, FILED 3-18-2004.

CLASS 9—(Continued).

3,177,796. SOLIDUS NETWORKS, INC, SAN FRANCISCO, CA. SN 78-396,338. PUB. 9-6-2005, FILED 4-5-2004.



ANTARIS

THE MARK CONSISTS OF STANDARD CHARACTERS WITHOUT CLAIM TO ANY PARTICULAR FONT, STYLE, SIZE, OR COLOR.

FOR SEMICONDUCTOR INTEGRATED CIRCUITS, NAMELY GLOBAL POSITIONING SYSTEMS CHIPS AND CHIP SETS (U.S. CLS. 21, 23, 26, 36 AND 38).

FIRST USE 3-8-2006; IN COMMERCE 3-8-2006.

FOR COMPUTER SOFTWARE FOR ELECTRONIC PAYMENT SERVICES; AUTHENTICATION, IDENTIFICATION AND TRANSACTION SERVICES FOR MERCHANTS BY MEANS OF ON-LINE DATABASES; COMPUTER SOFTWARE FOR ELECTRONIC PROCESSING AND TRANSMISSION OF PAYMENTS TO MERCHANTS; COMPUTER SOFTWARE FOR ELECTRONIC PROCESSING AND TRANSMISSION OF PAYMENTS BY MERCHANTS; COMPUTER SOFTWARE FOR ELECTRONIC PROCESSING AND TRANSMISSION OF PAYMENT TO MERCHANTS VIA ON-LINE DEBIT, CHECKING, CREDIT CARD, AND LOYALTY/REWARD ACCOUNT PAYMENTS; COMPUTER SOFTWARE FOR ELECTRONIC PROCESSING AND TRANSMISSION OF PAYMENTS BY MERCHANTS VIA ON-LINE DEBIT, CHECKING, CREDIT CARD, AND LOYALTY/REWARD ACCOUNT PAYMENTS; AND COMPUTER SOFTWARE PROVIDING A BIOMETRIC AUTHENTICATION AND PAYMENT SYSTEM (U.S. CLS. 21, 23, 26, 36 AND 38).

FIRST USE 7-20-2004; IN COMMERCE 7-20-2004.

3,177,795. TAKE-TWO INTERACTIVE SOFTWARE, INC., NEW YORK, NY. SN 78-396,080. PUB. 12-27-2005, FILED 4-5-2004.

3,177,797. MPOWER AUTO, INC., SOUTH ELGIN, IL. SN 78-397,243. PUB. 6-14-2005, FILED 4-6-2004.

WINGS OF WAR

MPOWER

THE MARK CONSISTS OF STANDARD CHARACTERS WITHOUT CLAIM TO ANY PARTICULAR FONT, STYLE, SIZE, OR COLOR.

FOR COMPUTER GAME SOFTWARE; ELECTRONIC GAME PROGRAMS; VIDEO GAME DISKS AND CARTRIDGES (U.S. CLS. 21, 23, 26, 36 AND 38).

FIRST USE 8-30-2004; IN COMMERCE 8-30-2004.

THE MARK CONSISTS OF STANDARD CHARACTERS WITHOUT CLAIM TO ANY PARTICULAR FONT, STYLE, SIZE, OR COLOR.

FOR OPTIMIZATION SOFTWARE THAT ENHANCES PROFITABILITY BY MAKING CALCULATIONS BASED ON VEHICLE ACQUISITION COSTS AND CURRENT MARKET VALUE (U.S. CLS. 21, 23, 26, 36 AND 38).

FIRST USE 3-2-2005; IN COMMERCE 3-2-2005.

CLASS 9—(Continued).

3,177,808. AERIELLE, INC., MOUNTAIN VIEW, CA. SN 78-402,044. PUB. 12-20-2005, FILED 4-14-2004.

CLASS 9—(Continued).

3,177,818. BERRY, DONALD J., DBA YRLIC, FLOWER MOUND, TX. SN 78-407,515. PUB. 5-17-2005, FILED 4-24-2004.

AUTOBUG

YrLic

THE MARK CONSISTS OF STANDARD CHARACTERS WITHOUT CLAIM TO ANY PARTICULAR FONT, STYLE, SIZE, OR COLOR.

FOR ELECTRONIC DEVICES, NAMELY, RADIO FREQUENCY ELECTRONIC TRANSMITTERS, RADIO FREQUENCY ELECTRONIC TRANSCEIVERS, POWER SUPPLIES FOR BOTH TRANSMITTERS AND TRANSCEIVERS, PRINTED CIRCUIT BOARD ASSEMBLIES, APPLICATION-SPECIFIC INTEGRATED CIRCUITS, AND MP3 PLAYERS, COMPACT DISC PLAYERS, MINI-DISK PLAYERS, AND CASSETTE TAPE PLAYERS NOT FOR USE WITH MUSICAL INSTRUMENTS, AND NOT FOR USE WITH TRANSMITTERS FOR WIRELESS CONNECTION TO MUSICAL INSTRUMENTS OR ELECTRONIC DEVICES FOR REAL-TIME ELECTRONIC COMMUNICATION WITH ONE OR MORE MUSICAL INSTRUMENTS (U.S. CLS. 21, 23, 26, 36 AND 38).
FIRST USE 5-0-2005; IN COMMERCE 5-0-2005.

THE MARK CONSISTS OF STANDARD CHARACTERS WITHOUT CLAIM TO ANY PARTICULAR FONT, STYLE, SIZE, OR COLOR.

FOR SOUND RECORDINGS FEATURING MUSIC (U.S. CLS. 21, 23, 26, 36 AND 38).
FIRST USE 6-1-2004; IN COMMERCE 2-26-2006.

3,177,822. ANTON/BAUER, INC., SHELTON, CT. SN 78-409,677. PUB. 1-25-2005, FILED 4-28-2004.

3,177,817. MASKED MARVEL GOALIE HELMETS, LLC, NOVI, MI. SN 78-406,254. PUB. 6-21-2005, FILED 4-22-2004.

MASKED MARVEL

TANDEM

THE MARK CONSISTS OF STANDARD CHARACTERS WITHOUT CLAIM TO ANY PARTICULAR FONT, STYLE, SIZE, OR COLOR.

FOR PROTECTIVE HEADGEAR, NAMELY HELMETS, AND FACE GUARDS, VISORS, CAGES AND MASKS FOR SUCH HELMETS (U.S. CLS. 21, 23, 26, 36 AND 38).
FIRST USE 8-12-2006; IN COMMERCE 8-14-2006.

THE MARK CONSISTS OF STANDARD CHARACTERS WITHOUT CLAIM TO ANY PARTICULAR FONT, STYLE, SIZE, OR COLOR.

FOR POWER SUPPLY, NAMELY, FUEL CELL AND BATTERY COMBINED POWER SUPPLIES (U.S. CLS. 21, 23, 26, 36 AND 38).
FIRST USE 4-24-2006; IN COMMERCE 9-11-2006.

CLASS 9—(Continued).

3,177,824. SYMON COMMUNICATIONS, INC., PLANO, TX. SN 78-410,401. PUB. 10-11-2005, FILED 4-29-2004.

FROM THE BREAK
ROOM TO THE BOARD
ROOM

THE MARK CONSISTS OF STANDARD CHARACTERS WITHOUT CLAIM TO ANY PARTICULAR FONT, STYLE, SIZE, OR COLOR.

FOR COMPUTER SOFTWARE, NAMELY, COMMUNICATION SOLUTIONS SOFTWARE FOR VISUAL DISPLAY DELIVERY OF REAL-TIME BUSINESS INFORMATION (U.S. CLS. 21, 23, 26, 36 AND 38).
FIRST USE 9-3-2003; IN COMMERCE 9-3-2003.

3,177,825. BIG TIME PRODUCTS, L.L.C., ROME, GA. SN 78-410,922. PUB. 4-18-2006, FILED 4-30-2004.

Blizzard

THE MARK CONSISTS OF STANDARD CHARACTERS WITHOUT CLAIM TO ANY PARTICULAR FONT, STYLE, SIZE, OR COLOR.

FOR PROTECTIVE WORK GLOVES (U.S. CLS. 21, 23, 26, 36 AND 38).
FIRST USE 11-19-2004; IN COMMERCE 11-19-2004.

CLASS 9—(Continued).

3,177,832. IGT, RENO, NV. SN 78-416,528. PUB. 11-15-2005, FILED 5-11-2004.



OWNER OF U.S. REG. NOS. 2,145,783, 2,519,800, AND OTHERS.

NO CLAIM IS MADE TO THE EXCLUSIVE RIGHT TO USE "4-5 BONUS POKER", APART FROM THE MARK AS SHOWN.

FOR GAMING MACHINES, NAMELY, DEVICES ON WHICH A WAGER IS PLACED AND COMPONENTS THEREFOR (U.S. CLS. 21, 23, 26, 36 AND 38).

FIRST USE 12-21-2005; IN COMMERCE 12-21-2005.

3,177,835. M2 WORLDWIDE CORPORATION, ROCKVILLE, MD. SN 78-421,780. PUB. 5-24-2005, FILED 5-19-2004.

WEBHEART

THE MARK CONSISTS OF STANDARD CHARACTERS WITHOUT CLAIM TO ANY PARTICULAR FONT, STYLE, SIZE, OR COLOR.

FOR COMPUTER SOFTWARE FOR THE COLLECTION, EDITING, ORGANIZING, MODIFYING, BOOK MARKING, TRANSMISSION, STORAGE AND SHARING OF DATA AND INFORMATION (U.S. CLS. 21, 23, 26, 36 AND 38).

FIRST USE 6-1-2004; IN COMMERCE 6-1-2004.

CLASS 9—(Continued).

3,177,839. NEWSOFT TECHNOLOGY CORP., TAIPEI, TAIWAN. SN 78-422,677. PUB. 7-12-2005, FILED 5-21-2004.

CLASS 9—(Continued).

3,177,853. OKUMA AMERICA CORPORATION, CHARLOTTE, NC. SN 78-430,677. PUB. 5-10-2005, FILED 6-7-2004.

Presto! PVR

THINC

THE MARK CONSISTS OF STANDARD CHARACTERS WITHOUT CLAIM TO ANY PARTICULAR FONT, STYLE, SIZE, OR COLOR.

OWNER OF U.S. REG. NOS. 2,040,637, 2,594,308, AND OTHERS.

NO CLAIM IS MADE TO THE EXCLUSIVE RIGHT TO USE "PVR", APART FROM THE MARK AS SHOWN.

FOR MULTIMEDIA SOFTWARE FOR USE IN RECEIVING, RETRIEVING, RECORDING, CAPTURING, AUTHORIZING, CREATING, PROCESSING, PLAYING, PRODUCING, UPLOADING, DOWNLOADING, ENCODING, AND DECODING OF DIGITAL INFORMATION, NAMELY, AUDIO, VIDEO, PHOTOS, GRAPHICS, STILL IMAGES, MOVING PICTURES, TEXT DATA, ONLINE MUSIC, ONLINE MOVIES, ONLINE BROADCASTING, AND USER MANUALS SOLD AS A UNIT THEREWITH (U.S. CLS. 21, 23, 26, 36 AND 38).

FIRST USE 6-1-2005; IN COMMERCE 6-1-2005.

THE MARK CONSISTS OF STANDARD CHARACTERS WITHOUT CLAIM TO ANY PARTICULAR FONT, STYLE, SIZE, OR COLOR.

FOR MACHINE TOOL COMPUTER HARDWARE AND SOFTWARE FOR SCHEDULING, CONTROLLING, MONITORING AND ANALYZING ONE OR MORE MACHINE TOOLS (U.S. CLS. 21, 23, 26, 36 AND 38).

FIRST USE 6-5-2006; IN COMMERCE 6-5-2006.

3,177,858. LIMACORP LLC, CINCINNATI, OH. SN 78-434,796. PUB. 6-7-2005, FILED 6-14-2004.

3,177,846. WMS GAMING INC., WAUKEGAN, IL. SN 78-428,016. PUB. 3-28-2006, FILED 6-1-2004.

EFORM CONNECT

DEJA VU DIAMONDS

THE MARK CONSISTS OF STANDARD CHARACTERS WITHOUT CLAIM TO ANY PARTICULAR FONT, STYLE, SIZE, OR COLOR.

NO CLAIM IS MADE TO THE EXCLUSIVE RIGHT TO USE "EFORM", APART FROM THE MARK AS SHOWN.

FOR COMPUTER SOFTWARE FOR THE CREATION, PROCESSING, SHARING, FILING AND VIEWING OF DOCUMENTS OVER THE INTERNET (U.S. CLS. 21, 23, 26, 36 AND 38).

FIRST USE 7-31-2006; IN COMMERCE 7-31-2006.

THE MARK CONSISTS OF STANDARD CHARACTERS WITHOUT CLAIM TO ANY PARTICULAR FONT, STYLE, SIZE, OR COLOR.

FOR GAMING MACHINES (U.S. CLS. 21, 23, 26, 36 AND 38).

FIRST USE 3-31-2006; IN COMMERCE 3-31-2006.

CLASS 9—(Continued).

3,177,865. SKYPILOT NETWORKS, INC., SANTA CLARA, CA. SN 78-437,033. PUB. 10-18-2005, FILED 6-17-2004.

CLASS 9—(Continued).

3,177,871. GOOD, RICHARD W., NEW HOLLAND, PA. SN 78-439,511. PUB. 6-14-2005, FILED 6-22-2004.

SKYEXTENDER

THE MARK CONSISTS OF STANDARD CHARACTERS WITHOUT CLAIM TO ANY PARTICULAR FONT, STYLE, SIZE, OR COLOR.

FOR COMPUTER HARDWARE FOR USE IN TELECOMMUNICATIONS; COMPUTER SOFTWARE FOR USE IN TELECOMMUNICATIONS, NAMELY SOFTWARE FOR ACCESSING EXPANDING, ROUTING, MANAGING AND IMPROVING CONNECTIONS FOR COMMUNICATION NETWORK SERVICES TO REMOTE SUBSCRIBERS (U.S. CLS. 21, 23, 26, 36 AND 38).
FIRST USE 10-0-2004; IN COMMERCE 10-0-2004.

FACS

THE MARK CONSISTS OF STANDARD CHARACTERS WITHOUT CLAIM TO ANY PARTICULAR FONT, STYLE, SIZE, OR COLOR.

FOR BUSINESS MANAGEMENT SOFTWARE FOR THE FURNITURE AND FLOORING INDUSTRY (U.S. CLS. 21, 23, 26, 36 AND 38).
FIRST USE 2-1-2000; IN COMMERCE 10-31-2000.

3,177,885. SOFTMED SYSTEMS, INC., SILVER SPRING, MD. SN 78-444,791. PUB. 6-7-2005, FILED 7-1-2004.

3,177,867. SYNECTICS TECHNOLOGY LLC, CAMBRIDGE, MA. SN 78-437,195. PUB. 11-22-2005, FILED 6-17-2004.

FLYING TABLE

THE MARK CONSISTS OF STANDARD CHARACTERS WITHOUT CLAIM TO ANY PARTICULAR FONT, STYLE, SIZE, OR COLOR.

FOR SOFTWARE, NAMELY, SOFTWARE FOR GROUP PROBLEM SOLVING USING A COMPUTERIZED GROUP MEETING (U.S. CLS. 21, 23, 26, 36 AND 38).
FIRST USE 8-1-2004; IN COMMERCE 8-1-2004.

SCRIPTPT

THE MARK CONSISTS OF STANDARD CHARACTERS WITHOUT CLAIM TO ANY PARTICULAR FONT, STYLE, SIZE, OR COLOR.

FOR COMPUTER SOFTWARE FOR MEDICAL RECORDS MANAGEMENT (U.S. CLS. 21, 23, 26, 36 AND 38).
FIRST USE 9-0-2004; IN COMMERCE 9-0-2004.

CLASS 9—(Continued).

3,177,888. EMERSON RADIO CORP., PARSIPPANY, NJ. SN 78-445,573. PUB. 6-14-2005, FILED 7-2-2004.



FOR TELEPHONE ANSWERING MACHINES (U.S. CLS. 21, 23, 26, 36 AND 38).
FIRST USE 7-31-2006; IN COMMERCE 7-31-2006.

3,177,941. QLOGIC CORPORATION, ALISO VIEJO, CA. SN 78-464,519. PUB. 7-5-2005, FILED 8-9-2004.

READYPATH

THE MARK CONSISTS OF STANDARD CHARACTERS WITHOUT CLAIM TO ANY PARTICULAR FONT, STYLE, SIZE, OR COLOR.

FOR COMPUTER HARDWARE; COMPUTER PERIPHERALS; NETWORK EQUIPMENT; NAMELY, SWITCHES AND APPLICATION HOSTING PLATFORMS FOR USE IN NETWORK COMMUNICATION AND STORAGE AREA NETWORKS; COMPUTER SOFTWARE FOR USE IN PROVIDING APPLICATION FUNCTIONALITY, OPERATING SYSTEM FUNCTIONALITY AND CONFIGURATION FOR STORAGE MANAGEMENT APPLICATIONS (U.S. CLS. 21, 23, 26, 36 AND 38).
FIRST USE 12-31-2004; IN COMMERCE 12-31-2004.

CLASS 9—(Continued).

3,177,955. PHNS INC., DALLAS, TX. SN 78-469,294. PUB. 11-15-2005, FILED 8-18-2004.



OWNER OF U.S. REG. NO. 2,703,884.
NO CLAIM IS MADE TO THE EXCLUSIVE RIGHT TO USE "FINANCIAL INFORMATION EXCHANGE", APART FROM THE MARK AS SHOWN.

THE MARK CONSISTS OF WORDS/LETTERS AND DESIGN OF A PARTIAL DOLLAR SIGN WITHIN A SQUARE.
FOR COMPUTER SOFTWARE FOR STORAGE AND RETRIEVAL OF INFORMATION IN THE HEALTH CARE INDUSTRY (U.S. CLS. 21, 23, 26, 36 AND 38).
FIRST USE 12-27-2004; IN COMMERCE 12-27-2004.

3,177,956. PLAYSOUPI, LLC, PARKER, CO. SN 78-469,339. PUB. 7-5-2005, FILED 8-18-2004.

MEDIANISTRY

THE MARK CONSISTS OF STANDARD CHARACTERS WITHOUT CLAIM TO ANY PARTICULAR FONT, STYLE, SIZE, OR COLOR.

FOR VIDEO RECORDINGS, AUDIO RECORDINGS, VIDEODISCS, CD-ROMS AND EDUCATIONAL SOFTWARE, ALL FEATURING INFORMATION AND ENTERTAINMENT OF GENERAL INTEREST TO CHILDREN, PARENTS AND FAMILIES (U.S. CLS. 21, 23, 26, 36 AND 38).
FIRST USE 2-1-2000; IN COMMERCE 2-1-2000.

CLASS 9—(Continued).

3,177,957. PHNS INC., DALLAS, TX. SN 78-469,458. PUB. 11-22-2005, FILED 8-18-2004.

PHNS FINANCIAL
INFORMATION
EXCHANGE

THE MARK CONSISTS OF STANDARD CHARACTERS WITHOUT CLAIM TO ANY PARTICULAR FONT, STYLE, SIZE, OR COLOR.

OWNER OF U.S. REG. NO. 2,703,884.

NO CLAIM IS MADE TO THE EXCLUSIVE RIGHT TO USE "FINANCIAL INFORMATION EXCHANGE", APART FROM THE MARK AS SHOWN.

FOR COMPUTER SOFTWARE FOR STORAGE AND RETRIEVAL OF INFORMATION IN THE HEALTH CARE INDUSTRY (U.S. CLS. 21, 23, 26, 36 AND 38).

FIRST USE 12-27-2004; IN COMMERCE 12-27-2004.

3,177,967. ACCURAY, INC., SUNNYVALE, CA. SN 78-471,678. PUB. 1-3-2006, FILED 8-23-2004.

INVIEW

THE MARK CONSISTS OF STANDARD CHARACTERS WITHOUT CLAIM TO ANY PARTICULAR FONT, STYLE, SIZE, OR COLOR.

FOR SOFTWARE FOR CONTOURING TUMORS AND BODY STRUCTURES FOR RADIOSURGERY AND RADIOTHERAPY SYSTEMS (U.S. CLS. 21, 23, 26, 36 AND 38).

FIRST USE 9-1-2004; IN COMMERCE 9-1-2004.

CLASS 9—(Continued).

3,177,970. BUSINESS SIGNATURES CORPORATION, REDWOOD CITY, CA. SN 78-472,413. PUB. 9-6-2005, FILED 8-24-2004.

BUSINESS SIGNATURES

THE MARK CONSISTS OF STANDARD CHARACTERS WITHOUT CLAIM TO ANY PARTICULAR FONT, STYLE, SIZE, OR COLOR.

NO CLAIM IS MADE TO THE EXCLUSIVE RIGHT TO USE BUSINESS, APART FROM THE MARK AS SHOWN.

FOR COMPUTER SOFTWARE IN THE FIELD OF REAL-TIME MONITORING OF WEB-BASED TRAFFIC AND TRANSACTIONS TO ENABLE A VARIETY OF SOLUTIONS INCLUDING SYSTEM ADMINISTRATION, CUSTOMER CARE AND BUSINESS MANAGEMENT (U.S. CLS. 21, 23, 26, 36 AND 38).

FIRST USE 5-27-2005; IN COMMERCE 5-27-2005.

3,177,978. AFFINEGY LLC, AUSTIN, TX. SN 78-475,365. PUB. 7-12-2005, FILED 8-29-2004.

Airkit

THE MARK CONSISTS OF STANDARD CHARACTERS WITHOUT CLAIM TO ANY PARTICULAR FONT, STYLE, SIZE, OR COLOR.

FOR COMPUTER SOFTWARE FOR CONNECTING USERS TO WIRELESS NETWORKS AND INTERNET SERVICES (U.S. CLS. 21, 23, 26, 36 AND 38).

FIRST USE 6-1-2004; IN COMMERCE 6-1-2004.

CLASS 9—(Continued).

3,177,983. INTERCEPT, INC., JACKSONVILLE, FL. SN 78-476,491. PUB. 12-13-2005, FILED 8-31-2004.

BRANCH CAPTURE XPRESS

THE MARK CONSISTS OF STANDARD CHARACTERS WITHOUT CLAIM TO ANY PARTICULAR FONT, STYLE, SIZE, OR COLOR.

NO CLAIM IS MADE TO THE EXCLUSIVE RIGHT TO USE "BRANCH CAPTURE", APART FROM THE MARK AS SHOWN.

FOR COMPUTER SOFTWARE FOR IMAGE CAPTURE, STORAGE AND TRANSMISSION OF REMOTELY CAPTURED ITEMS, INCLUDING, BUT NOT LIMITED TO, CHECKS, CASH LETTERS, RETURN ITEMS, AND ALL TELLER WORK, INCLUDING, BUT NOT LIMITED TO, CUSTOMER DEPOSITS, TRANSMITTED DIRECTLY FROM A FINANCIAL INSTITUTION LOCATION, BRANCH, AUTOMATED TELLER MACHINE, OR FINANCIAL INSTITUTION CUSTOMER LOCATION OR PROCESSING FACILITY WHERE AN IMAGE CAPTURE DEVICE RESIDES TO A CENTRAL PROCESSING FACILITY DESIGNATED BY THE FINANCIAL INSTITUTION OR THE FINANCIAL INSTITUTION'S PROCESSING FACILITY (U.S. CLS. 21, 23, 26, 36 AND 38).

FIRST USE 4-8-2004; IN COMMERCE 4-8-2004.

3,178,008. GARMIN LTD., 103 SOUTH CHURCH STREET, GEORGE TOWN, CAYMAN ISLANDS. SN 78-489,024. PUB. 9-13-2005, FILED 9-24-2004.

GARMIN TRAINING CENTER

THE MARK CONSISTS OF STANDARD CHARACTERS WITHOUT CLAIM TO ANY PARTICULAR FONT, STYLE, SIZE, OR COLOR.

FOR COMPUTER SOFTWARE FOR INPUTTING, STORING, PROCESSING OR OUTPUTTING PERSONAL EXERCISE OR FITNESS INFORMATION (U.S. CLS. 21, 23, 26, 36 AND 38).

FIRST USE 1-0-2005; IN COMMERCE 1-0-2005.

CLASS 9—(Continued).

3,178,010. THE FANFARE GROUP, INC., MOUNTAIN VIEW, CA. SN 78-489,117. PUB. 12-27-2005, FILED 9-24-2004.

FANFARESVT

THE MARK CONSISTS OF STANDARD CHARACTERS WITHOUT CLAIM TO ANY PARTICULAR FONT, STYLE, SIZE, OR COLOR.

FOR COMPUTER SOFTWARE FOR SYSTEMS VERIFICATION TESTING; COMPUTER SOFTWARE FOR TESTING AND ANALYZING THE PERFORMANCE AND INTEGRITY OF PRODUCT FEATURES IN THE FIELD OF PRODUCT AND/OR SYSTEMS DESIGN, THE FIELD OF PRODUCT QUALITY ASSURANCE, AND THE FIELD OF PRODUCT AND/OR SYSTEMS TESTING; COMPUTER SOFTWARE FOR PRODUCT AND/OR SYSTEM DESIGN MODELING AND TESTING; COMPUTER SOFTWARE FOR USE IN PRODUCT AND/OR SYSTEM TEST PLANNING, TEST CASE DESIGN, TEST EXECUTION, TEST AUTOMATION, DEFECT ANALYSIS AND DOCUMENTATION, AND TEST RESULT TRACKING AND REPORTING (U.S. CLS. 21, 23, 26, 36 AND 38).

FIRST USE 7-31-2005; IN COMMERCE 2-16-2006.

3,178,018. CERNER CORPORATION, KANSAS CITY, MO. SN 78-491,363. PUB. 9-13-2005, FILED 9-29-2004.

POWERWORKS

THE MARK CONSISTS OF STANDARD CHARACTERS WITHOUT CLAIM TO ANY PARTICULAR FONT, STYLE, SIZE, OR COLOR.

FOR COMPUTER SOFTWARE FOR USE IN THE HEALTHCARE FIELD, NAMELY SOFTWARE FOR MANAGING, STORING, ANALYZING, MAINTAINING, PROCESSING, REVIEWING, EDITING, DISTRIBUTING, COMMUNICATING, ORGANIZING, SHARING, REFERENCING, MONITORING AND INTEGRATING HEALTHCARE INFORMATION; COMPUTER SOFTWARE FOR AUTOMATING CLINICAL AND ADMINISTRATIVE HEALTHCARE PROCESSES (U.S. CLS. 21, 23, 26, 36 AND 38).

FIRST USE 6-1-2006; IN COMMERCE 6-1-2006.

CLASS 9—(Continued).

3,178,082. LIFESPRING RESOURCES, INC., LAFAYETTE, CO. SN 78-523,636. PUB. 9-6-2005, FILED 11-29-2004.



NO CLAIM IS MADE TO THE EXCLUSIVE RIGHT TO USE ENERGY MANAGER SOLUTIONS, APART FROM THE MARK AS SHOWN.

FOR ENERGY MANAGEMENT SOFTWARE FOR MONITORING UTILITY USAGE (U.S. CLS. 21, 23, 26, 36 AND 38).

FIRST USE 4-0-2005; IN COMMERCE 5-0-2005.

CLASS 9—(Continued).

3,178,089. MOTION RESEARCH CORPORATION, SEATTLE, WA. SN 78-527,865. PUB. 12-20-2005, FILED 12-6-2004.

HEADS UP FOR THE ROAD AHEAD

THE MARK CONSISTS OF STANDARD CHARACTERS WITHOUT CLAIM TO ANY PARTICULAR FONT, STYLE, SIZE, OR COLOR.

FOR WIRELESS HEAD MOUNTED RECEIVER CONSISTING OF A TRANSMITTER AND A DISPLAY UNIT FOR DISPLAY OF REAL-TIME DATA FOR MOTORIZED AND NON-MOTORIZED SPORTS APPLICATIONS (U.S. CLS. 21, 23, 26, 36 AND 38).

FIRST USE 12-9-2004; IN COMMERCE 12-9-2004.

3,178,090. FLO-OINCS, TARZANA, CA. SN 78-527,989. PUB. 10-4-2005, FILED 12-6-2004.

3,178,084. DROPPING DAYLIGHT, LLC, NASHVILLE, TN. SN 78-526,158. PUB. 11-22-2005, FILED 12-2-2004.

DROPPING DAYLIGHT

THE MARK CONSISTS OF STANDARD CHARACTERS WITHOUT CLAIM TO ANY PARTICULAR FONT, STYLE, SIZE, OR COLOR.

FOR A SERIES OF MUSICAL SOUND RECORDINGS, NAMELY, AUDIO AND VIDEO CASSETTES, COMPACT DISCS, DVDS AND VIDEOTAPES FEATURING INSTRUMENTAL AND VOCAL MUSIC BY A MUSICAL GROUP (U.S. CLS. 21, 23, 26, 36 AND 38).

FIRST USE 2-12-2005; IN COMMERCE 2-12-2005.

FLO-ONICS

THE MARK CONSISTS OF STANDARD CHARACTERS WITHOUT CLAIM TO ANY PARTICULAR FONT, STYLE, SIZE, OR COLOR.

FOR LIQUID LEVEL CONTROL DEVICES AND FLOWMETERS (U.S. CLS. 21, 23, 26, 36 AND 38).

FIRST USE 4-1-2005; IN COMMERCE 4-1-2005.

CLASS 9—(Continued).

3,178,093. OPTELLENT INCORPORATED, SAN JOSE, CA. SN 78-529,288. PUB. 12-27-2005, FILED 12-8-2004.

CLASS 9—(Continued).

3,178,105. SANDISK CORPORATION, MILPITAS, CA. SN 78-534,234. PUB. 10-25-2005, FILED 12-17-2004.

Optobert

SANSA

THE MARK CONSISTS OF STANDARD CHARACTERS WITHOUT CLAIM TO ANY PARTICULAR FONT, STYLE, SIZE, OR COLOR.

FOR TEST AND MEASUREMENT EQUIPMENT FOR USE IN THE FIELDS OF NETWORKS, TELECOMMUNICATIONS, AND DEVICE CHARACTERIZATION, NAMELY, ELECTRONIC AND OPTICAL MEASURING INSTRUMENT USED FOR TESTING BIT ERROR RATE AND DATA INTEGRITY OF TELECOMMUNICATIONS AND COMPUTER NETWORK EQUIPMENT, SIGNAL INTEGRITY AND OPERATING CHARACTERISTICS OF OPTICAL AND ELECTRONIC DEVICES AND COMPONENTS (U.S. CLS. 21, 23, 26, 36 AND 38).

FIRST USE 8-17-2004; IN COMMERCE 8-24-2004.

THE MARK CONSISTS OF STANDARD CHARACTERS WITHOUT CLAIM TO ANY PARTICULAR FONT, STYLE, SIZE, OR COLOR.

FOR DIGITAL AUDIO PLAYERS (U.S. CLS. 21, 23, 26, 36 AND 38).

FIRST USE 4-30-2005; IN COMMERCE 4-30-2005.

3,178,116. NGK SPARK PLUG CO., LTD., NAGOYA CITY, JAPAN. SN 78-538,595. PUB. 12-27-2005, FILED 12-27-2004.

3,178,096. CHUNKY MONKEY PRODUCTIONS, LLC, PORT ST. LUCIE, FL. SN 78-531,054. PUB. 11-22-2005, FILED 12-11-2004.

CTAS

Stripology

THE MARK CONSISTS OF STANDARD CHARACTERS WITHOUT CLAIM TO ANY PARTICULAR FONT, STYLE, SIZE, OR COLOR.

FOR APPARATUS FOR MEASURING CONCENTRATION OF FUEL VAPOR, OXYGEN, NITROGEN OXIDE, HYDROCARBON, METHANE, ALCOHOL AND HYDROGEN IN AIR OR GAS; APPARATUS FOR MEASURING CONCENTRATION OF FUEL VAPOR, OXYGEN, NITROGEN OXIDE, HYDROCARBON, METHANE, ALCOHOL AND HYDROGEN, AND CONTROLLING AIR/FUEL RATIO IN THE EXHAUST GAS FROM INTERNAL COMBUSTION ENGINES, BOILERS, INCINERATORS, GAS TURBINES, GENERATORS AND FUEL CELLS; KNOCK SENSORS; PRESSURE SENSORS; TEMPERATURE SENSORS; OUTDOOR AIR SENSORS FOR MEASURING AIR QUALITY; LOAD SENSORS (U.S. CLS. 21, 23, 26, 36 AND 38).

FIRST USE 8-1-2005; IN COMMERCE 8-1-2005.

THE MARK CONSISTS OF STANDARD CHARACTERS WITHOUT CLAIM TO ANY PARTICULAR FONT, STYLE, SIZE, OR COLOR.

FOR PRE-RECORDED INSTRUCTIONAL VIDEO TAPES AND DVDS IN THE FIELD OF EXOTIC DANCE; PRE-RECORDED VIDEO TAPES AND DVDS FEATURING ADULT ENTERTAINMENT (U.S. CLS. 21, 23, 26, 36 AND 38).

FIRST USE 7-3-2006; IN COMMERCE 7-3-2006.

CLASS 9—(Continued).

3,178,123. RETALIGENT SOLUTIONS, INC., ATLANTA, GA.
SN 78-542,767. PUB. 2-14-2006, FILED 1-5-2005.

CLASS 9—(Continued).

3,178,134. EATON CORPORATION, CLEVELAND, OH. SN
78-547,793. PUB. 1-17-2006, FILED 1-14-2005.

CLARIENCE

X-SLOT

THE MARK CONSISTS OF STANDARD CHARACTERS WITHOUT CLAIM TO ANY PARTICULAR FONT, STYLE, SIZE, OR COLOR.

FOR COMPUTER SOFTWARE FOR USE IN RETAIL SALES, NAMELY COMPUTER SOFTWARE FOR REAL-TIME ACCESS TO INDIVIDUAL CUSTOMER DATA, MERCHANDISE DATA, AND SELLING TOOLS FOR THE PROMOTION OF CUSTOMER SERVICE AND SALES ASSOCIATES' PRODUCTIVITY; COMPUTER SOFTWARE FOR WIRELESS MOBILE DEVICES, PERSONAL COMPUTERS, POINT-OF-SALE DEVICES AND KIOSKS USED IN RETAILING; COMPUTER SOFTWARE FOR RETAILERS THAT ENABLES IMPROVED REVENUES, SALES ASSOCIATE PRODUCTIVITY AND MARGINS THROUGH PERSONALIZED MARKETING AND SELLING TOOLS; COMPUTER SOFTWARE FOR CAPTURING AND ACCESSING INDIVIDUAL CUSTOMER DATA, PREFERENCES AND PURCHASE HISTORY; COMPUTER SOFTWARE ENABLING IMPROVED CUSTOMER SERVICE BY COLLECTING AND ANALYZING CUSTOMER DATA; COMPUTER SOFTWARE ENABLING PERSONALIZED UP-SELL AND CROSS-SELL OPPORTUNITIES; COMPUTER SOFTWARE ENABLING DELIVERY OF SPECIAL RETAIL OFFERS, CUSTOMER DATA, AND CUSTOMIZED MESSAGES THROUGH HAND-HELD DEVICES, PERSONAL COMPUTERS, POINT-OF-SALE DEVICES AND IN-STORE KIOSKS (U.S. CLS. 21, 23, 26, 36 AND 38).

FIRST USE 5-25-2006; IN COMMERCE 5-25-2006.

THE MARK CONSISTS OF STANDARD CHARACTERS WITHOUT CLAIM TO ANY PARTICULAR FONT, STYLE, SIZE, OR COLOR.

FOR EXPANSION MODULE WITH MULTIPLE POWER PLUGS FOR ALLOWING MULTIPLE ELECTRICAL ATTACHMENTS TO A SYSTEM FOR SUPPLYING AND CONTROLLING ELECTRICAL POWER IN THE NATURE OF AN UNINTERRUPTIBLE POWER SUPPLY UNIT (U.S. CLS. 21, 23, 26, 36 AND 38).

FIRST USE 7-21-2001; IN COMMERCE 7-21-2001.

CLASS 9—(Continued).

3,178,140. CONVERGENT MEDIA NETWORK LTD., VICTORIA, CANADA. SN 78-550,381. PUB. 10-11-2005, FILED 1-19-2005.



NO CLAIM IS MADE TO THE EXCLUSIVE RIGHT TO USE "CRM", APART FROM THE MARK AS SHOWN.

FOR COMPUTER SOFTWARE FOR ANALYZING OF PRODUCTIVITY, CUSTOMER CONTACT AND COMMUNICATION MANAGEMENT, INTERNAL COMPANY MANAGEMENT, INCLUDING PROJECT MANAGEMENT; SCHEDULING, ASSIGNING AND TRACKING TASKS AND MEETINGS, SENDING, RECEIVING, ORGANIZING EMAIL DOCUMENTS, FAXES, INSTANT MESSAGES, PHONE CALLS AND ALL COMMUNICATION AND TRACKING BY TOPIC, TRACKS THE MOVEMENT OF CUSTOMERS THROUGH A PREDETERMINED SALES CYCLE AT THE CORPORATE, DEPARTMENTAL AND INDIVIDUAL USER LEVEL FOR TRACKING COMPANY PROJECTS THROUGH PROJECT CYCLES FOR TRACKING ALL COMMUNICATION AND DOCUMENTS, CONTACTS AND USERS IN THE SALES, MARKETING AND BUSINESS PROCESS AND COMMUNICATION FLOW, FOR PLANNING, DESIGNING, AND TRACKING, PERSONALIZED MARKETING CAMPAIGNS COMPRISED OF PROJECTS, DELIVERED BY POSTAL MAIL, EMAIL, ONLINE AND WEBSITE MARKETING, FOR ORGANIZING AND SCHEDULING DELIVERY DATES AND TRACKS THE RESULTS AND EFFECTIVENESS OF MARKETING EFFORTS FOR TRACKING (U.S. CLS. 21, 23, 26, 36 AND 38).

FIRST USE 1-15-2006; IN COMMERCE 1-15-2006.

3,178,175. PROTEK DEVICES, LP, TEMPE, AZ. SN 78-564,414. PUB. 11-29-2005, FILED 2-10-2005.

PROTEK ANALOG

THE MARK CONSISTS OF STANDARD CHARACTERS WITHOUT CLAIM TO ANY PARTICULAR FONT, STYLE, SIZE, OR COLOR.

OWNER OF U.S. REG. NOS. 1,797,659 AND 2,913,390. NO CLAIM IS MADE TO THE EXCLUSIVE RIGHT TO USE "ANALOG", APART FROM THE MARK AS SHOWN.

FOR ANALOG TO DIGITAL CONVERTERS; DIGITAL TO ANALOG CONVERTERS; CURRENT REGULATING DIODES, THYRISTORS (U.S. CLS. 21, 23, 26, 36 AND 38). FIRST USE 11-1-2005; IN COMMERCE 11-1-2005.

CLASS 9—(Continued).

3,178,178. PROTEK DEVICES, LP, TEMPE, AZ. SN 78-564,860. PUB. 12-13-2005, FILED 2-10-2005.

**INNOVATIVE ANALOG
SOLUTIONS FOR THE
21ST CENTURY**

THE MARK CONSISTS OF STANDARD CHARACTERS WITHOUT CLAIM TO ANY PARTICULAR FONT, STYLE, SIZE, OR COLOR.

OWNER OF U.S. REG. NOS. 1,797,659 AND 2,913,390. NO CLAIM IS MADE TO THE EXCLUSIVE RIGHT TO USE "ANALOG", APART FROM THE MARK AS SHOWN.

FOR ANALOG TO DIGITAL CONVERTERS; DIGITAL TO ANALOG CONVERTERS; CURRENT REGULATING DIODES, THYRISTORS (U.S. CLS. 21, 23, 26, 36 AND 38). FIRST USE 11-1-2005; IN COMMERCE 11-1-2005.

3,178,185. TAYLOR BRANDS, LLC, KINGSPORT, TN. SN 78-565,883. PUB. 11-8-2005, FILED 2-11-2005.

OLD TIMER

THE MARK CONSISTS OF STANDARD CHARACTERS WITHOUT CLAIM TO ANY PARTICULAR FONT, STYLE, SIZE, OR COLOR.

FOR SAFETY GLASSES AND SHOOTING GLASSES WITH EAR SAFETY PROTECTORS (U.S. CLS. 21, 23, 26, 36 AND 38).

FIRST USE 12-31-1958; IN COMMERCE 3-14-2006.

CLASS 9—(Continued).

3,178,189. STRONG, CLINTON R., DALLAS, TX. SN 78-567,883. PUB. 11-15-2005, FILED 2-15-2005.

CONNECTRAC

THE MARK CONSISTS OF STANDARD CHARACTERS WITHOUT CLAIM TO ANY PARTICULAR FONT, STYLE, SIZE, OR COLOR.

FOR RACEWAYS FOR PROVIDING POWER AND/OR COMMUNICATION CONNECTIVITY (U.S. CLS. 21, 23, 26, 36 AND 38).

FIRST USE 1-25-2005; IN COMMERCE 9-0-2005.

3,178,191. CHECK POINT SOFTWARE TECHNOLOGIES LTD., RAMAT GAN, ISRAEL. SN 78-568,071. PUB. 1-24-2006, FILED 2-15-2005.

EVENTIA ANALYZER

THE MARK CONSISTS OF STANDARD CHARACTERS WITHOUT CLAIM TO ANY PARTICULAR FONT, STYLE, SIZE, OR COLOR.

NO CLAIM IS MADE TO THE EXCLUSIVE RIGHT TO USE "ANALYZER", APART FROM THE MARK AS SHOWN.

FOR COMPUTER SOFTWARE FOR SECURITY EVENT MANAGEMENT AND SECURITY INFORMATION MANAGEMENT (U.S. CLS. 21, 23, 26, 36 AND 38).

FIRST USE 4-26-2005; IN COMMERCE 4-26-2005.

CLASS 9—(Continued).

3,178,204. GENESEARCH, INC., BOZEMAN, MT. SN 78-570,065. PUB. 12-20-2005, FILED 2-17-2005.

DRACULA PIPETTE

THE MARK CONSISTS OF STANDARD CHARACTERS WITHOUT CLAIM TO ANY PARTICULAR FONT, STYLE, SIZE, OR COLOR.

NO CLAIM IS MADE TO THE EXCLUSIVE RIGHT TO USE "PIPETTE", APART FROM THE MARK AS SHOWN.

FOR CO-AXIAL MICROINJECTION SYSTEM, COMPRISING A HOLDING PIPETTE AND AN INJECTION PIPETTE, THAT ACTS AS A MICROTOOL FOR INJECTION INTO AND ASPIRATION FROM EMBRYOS AT THE HATCHED BLASTOCYST STAGE OF DEVELOPMENT (U.S. CLS. 21, 23, 26, 36 AND 38).

FIRST USE 5-2-2006; IN COMMERCE 5-2-2006.

3,178,211. CAPITAL SAFETY GROUP EMEA, CARROS, FRANCE. SN 78-571,579. PUB. 12-27-2005, FILED 2-21-2005.

EVOLUTION

THE MARK CONSISTS OF STANDARD CHARACTERS WITHOUT CLAIM TO ANY PARTICULAR FONT, STYLE, SIZE, OR COLOR.

FOR FALL PROTECTION AND FALL ARREST EQUIPMENT, NAMELY, HORIZONTAL LIFELINE SYSTEMS COMPRISED OF POSTS FOR SUPPORTING SAFETY CABLES, CABLES AND BRACKETS FOR CONNECTING CABLES TO POSTS (U.S. CLS. 21, 23, 26, 36 AND 38).

FIRST USE 5-0-2005; IN COMMERCE 5-0-2005.

CLASS 9—(Continued).

3,178,218. DAYSTAR TECHNOLOGIES, HALFMOON, NY. SN 78-573,256. PUB. 1-17-2006, FILED 2-23-2005.

CLASS 9—(Continued).

3,178,235. KONAMI GAMING, INC., LAS VEGAS, NV. SN 78-576,522. PUB. 11-15-2005, FILED 2-28-2005.

Integrate

WILD TROPIC

THE MARK CONSISTS OF STANDARD CHARACTERS WITHOUT CLAIM TO ANY PARTICULAR FONT, STYLE, SIZE, OR COLOR.
FOR SOLAR CELLS AND PHOTOVOLTAIC SOLAR MODULES (U.S. CLS. 21, 23, 26, 36 AND 38).
FIRST USE 7-6-2006; IN COMMERCE 7-6-2006.

THE MARK CONSISTS OF STANDARD CHARACTERS WITHOUT CLAIM TO ANY PARTICULAR FONT, STYLE, SIZE, OR COLOR.
FOR GAMING EQUIPMENT, NAMELY, SLOT MACHINES, GAMING MACHINES AND GAME SOFTWARE USED THEREWITH (U.S. CLS. 21, 23, 26, 36 AND 38).
FIRST USE 6-28-2006; IN COMMERCE 6-28-2006.

3,178,240. AVID TECHNOLOGY, INC., TEWKSBURY, MA. SN 78-577,410. PUB. 6-20-2006, FILED 3-1-2005.

3,178,229. CBS BROADCASTING INC., NEW YORK, NY. SN 78-575,235. PUB. 12-13-2005, FILED 2-25-2005.

DO MORE

I LOVE LUCY

THE MARK CONSISTS OF STANDARD CHARACTERS WITHOUT CLAIM TO ANY PARTICULAR FONT, STYLE, SIZE, OR COLOR.
OWNER OF U.S. REG. NOS. 1,715,262, 2,793,932, AND OTHERS.
FOR MOUSE PADS; DECORATIVE MAGNETS, REFRIGERATOR MAGNETS; SLOT MACHINES (U.S. CLS. 21, 23, 26, 36 AND 38).
FIRST USE 11-30-2002; IN COMMERCE 11-30-2002.

THE MARK CONSISTS OF STANDARD CHARACTERS WITHOUT CLAIM TO ANY PARTICULAR FONT, STYLE, SIZE, OR COLOR.
FOR COMPUTER HARDWARE AND SOFTWARE FOR USE IN THE CAPTURE, STORAGE, PREVIEW, EDITING, COMPOSITING, MANIPULATION AND PLAYBACK OF AUDIOVISUAL MEDIA FOR USE IN THE FIELDS OF MOTION PICTURES, BROADCAST TELEVISION, SPECIAL EFFECTS, GAMING, VIDEO PRODUCTION AND FORENSIC ANALYSIS (U.S. CLS. 21, 23, 26, 36 AND 38).
FIRST USE 12-0-2004; IN COMMERCE 4-18-2005.

CLASS 9—(Continued).

3,178,241. GENERAL ELECTRIC COMPANY, SCHENECTADY, NY. SN 78-577,681. PUB. 11-22-2005, FILED 3-1-2005.

CLASS 9—(Continued).

3,178,249. LO, WAYNE C., CAMPBELL, CA. SN 78-579,706. PUB. 11-22-2005, FILED 3-3-2005.

AdvantageSim

THE MARK CONSISTS OF STANDARD CHARACTERS WITHOUT CLAIM TO ANY PARTICULAR FONT, STYLE, SIZE, OR COLOR.

FOR MEDICAL APPLICATION SOFTWARE PRODUCT FOR USE IN CONNECTION WITH MEDICAL IMAGING EQUIPMENT (U.S. CLS. 21, 23, 26, 36 AND 38).

FIRST USE 10-31-1995; IN COMMERCE 10-31-1995.

3,178,248. SWEARINGEN SOFTWARE, INC., HOUSTON, TX. SN 78-579,565. PUB. 5-9-2006, FILED 3-3-2005.

THERE'S NO PLACE LIKE SWEARINGEN

THE MARK CONSISTS OF STANDARD CHARACTERS WITHOUT CLAIM TO ANY PARTICULAR FONT, STYLE, SIZE, OR COLOR.

OWNER OF U.S. REG. NOS. 2,264,176, 2,398,896, AND 2,484,104.

FOR COMPUTER SYSTEMS, NAMELY COMPUTER PROGRAMS AND IMPLICATED HARDWARE INCLUDING NETWORKED DESKTOP COMPUTERS AND PERIPHERALS, FOR RADIOLOGY INFORMATION SYSTEMS, NAMELY, SOFTWARE FOR PATIENT MANAGEMENT, FILM TRACKING, SCHEDULING, TRANSCRIPTION, INVENTORY, QUALITY CONTROL, STANDARD PROCEDURES, EQUIPMENT MAINTENANCE, AND PERSONNEL MANAGEMENT OF X-RAY DEPARTMENTS OF SMALL-TO-MEDIUM SIZED HEALTHCARE FACILITIES INCLUDING CLINICS AND HOSPITALS (U.S. CLS. 21, 23, 26, 36 AND 38).

FIRST USE 2-3-2005; IN COMMERCE 2-7-2005.

Piece together your information puzzles

THE MARK CONSISTS OF STANDARD CHARACTERS WITHOUT CLAIM TO ANY PARTICULAR FONT, STYLE, SIZE, OR COLOR.

FOR COMPUTER SOFTWARE FOR USE AS A DATABASE APPLICATION PLATFORM IN MANAGING FILES AND CONTENT ON AN INDIVIDUAL COMPUTER OR A NETWORK OF COMPUTERS, SUCH AS INTERNET, TO BE USED IN THE FIELDS OF INTERNET COMMERCE, DIGITAL DOCUMENTATION AND ELECTRONIC PUBLISHING (U.S. CLS. 21, 23, 26, 36 AND 38).

FIRST USE 4-15-2005; IN COMMERCE 6-1-2005.

3,178,251. WRC, LLC, LOS ANGELES, CA. SN 78-579,912. PUB. 11-29-2005, FILED 3-3-2005.

WHEAT RECORDING COMPANY

THE MARK CONSISTS OF STANDARD CHARACTERS WITHOUT CLAIM TO ANY PARTICULAR FONT, STYLE, SIZE, OR COLOR.

NO CLAIM IS MADE TO THE EXCLUSIVE RIGHT TO USE "RECORDING COMPANY", APART FROM THE MARK AS SHOWN.

FOR PRE-RECORDED COMPACT DISKS AND CASSETTES FEATURING MUSIC (U.S. CLS. 21, 23, 26, 36 AND 38).

FIRST USE 4-0-2005; IN COMMERCE 4-0-2005.

CLASS 9—(Continued).

3,178,263. MIDWAY HOME ENTERTAINMENT INC., CHICAGO, IL. SN 78-582,427. PUB. 11-29-2005, FILED 3-8-2005.

CLASS 9—(Continued).

3,178,270. THERMO ELECTRON CORPORATION, COON RAPIDS, MN. SN 78-585,206. PUB. 12-27-2005, FILED 3-11-2005.

OFF ROAD THUNDER

THE MARK CONSISTS OF STANDARD CHARACTERS WITHOUT CLAIM TO ANY PARTICULAR FONT, STYLE, SIZE, OR COLOR.

FOR COMPUTER AND VIDEO GAME PROGRAMS RECORDED ON CARTRIDGES, DISCS, CD-ROMS, CASSETTES, TAPES AND MINI DISCS; VIDEO AND COMPUTER GAME SOFTWARE (U.S. CLS. 21, 23, 26, 36 AND 38).

FIRST USE 11-1-2005; IN COMMERCE 11-1-2005.



3,178,266. NATIONAL HOT ROD ASSOCIATION, GLEN-DORA, CA. SN 78-584,298. PUB. 1-3-2006, FILED 3-10-2005.

EZx

THE MARK CONSISTS OF STANDARD CHARACTERS WITHOUT CLAIM TO ANY PARTICULAR FONT, STYLE, SIZE, OR COLOR.

FOR CONTAMINANT DETECTOR FOR FOOD INSPECTION (U.S. CLS. 21, 23, 26, 36 AND 38).

FIRST USE 10-13-2005; IN COMMERCE 10-13-2005.



3,178,271. PRINTABLE TECHNOLOGIES INC., SOLANA BEACH, CA. SN 78-585,336. PUB. 12-6-2005, FILED 3-11-2005.

NHRA

THE MARK CONSISTS OF STANDARD CHARACTERS WITHOUT CLAIM TO ANY PARTICULAR FONT, STYLE, SIZE, OR COLOR.

OWNER OF U.S. REG. NOS. 1,293,428, 2,220,219, AND 2,221,363.

FOR COMPUTER GAME SOFTWARE AND PROGRAMS, COMPUTER GAME CARTRIDGES AND DISCS, VIDEO GAME CARTRIDGES, DISCS AND VIDEO RECORDINGS IN THE FIELD OF AUTO RACING (U.S. CLS. 21, 23, 26, 36 AND 38).

FIRST USE 12-31-2003; IN COMMERCE 8-17-2005.

FUSIONPRO

THE MARK CONSISTS OF STANDARD CHARACTERS WITHOUT CLAIM TO ANY PARTICULAR FONT, STYLE, SIZE, OR COLOR.

FOR COMPUTER SOFTWARE FOR VARIABLE DATA PRINTING APPLICATIONS; COMPUTER SOFTWARE FOR USE IN CREATING AND EDITING TEXTUAL DATABASES, AND FOR USE IN TYPOGRAPHIC COMPOSITION (U.S. CLS. 21, 23, 26, 36 AND 38).

FIRST USE 11-15-2001; IN COMMERCE 11-15-2001.

CLASS 9—(Continued).

3,178,272. PRINTABLE TECHNOLOGIES INC., SOLANA BEACH, CA. SN 78-585,338. PUB. 12-6-2005, FILED 3-11-2005.

PRINTFUSION

THE MARK CONSISTS OF STANDARD CHARACTERS WITHOUT CLAIM TO ANY PARTICULAR FONT, STYLE, SIZE, OR COLOR.

FOR COMPUTER SOFTWARE FOR USE IN VARIABLE DATA PRINTING, ORDERING, AND PRINT MANAGEMENT; COMPUTER SOFTWARE FOR USE IN CREATING, PROOFING, PLACING AND PROCESSING WORK ORDERS; COMPUTER SOFTWARE FOR USING PRESS-READY TEMPLATES AND FOR ACCOMPLISHING WORK ORDER PRODUCTION AND FULFILLMENT (U.S. CLS. 21, 23, 26, 36 AND 38).

FIRST USE 11-15-2001; IN COMMERCE 11-15-2001.

CLASS 9—(Continued).

3,178,276. PANACEA SOLUTIONS, INC., BERNARDSVILLE, NJ. SN 78-586,047. PUB. 2-28-2006, FILED 3-12-2005.

FLEXREACTOR

THE MARK CONSISTS OF STANDARD CHARACTERS WITHOUT CLAIM TO ANY PARTICULAR FONT, STYLE, SIZE, OR COLOR.

FOR LABORATORY MIXERS FOR USE IN MIXING LIQUIDS AND POWDERS FOR LABORATORY AND INDUSTRIAL USE; LABORATORY MIXERS FOR MIXING LIQUIDS AND POWDERS FOR USE IN THE PHARMACEUTICAL AND CHEMICAL INDUSTRIES; DISPOSABLE PLASTIC BIOREACTORS CONTAINING INTERNAL PARTITIONS USED FOR RESEARCH AND LABORATORY PURPOSES (U.S. CLS. 21, 23, 26, 36 AND 38).

FIRST USE 2-15-2006; IN COMMERCE 7-11-2006.

3,178,275. PANACEA SOLUTIONS, INC., BERNARDSVILLE, NJ. SN 78-586,045. PUB. 2-28-2006, FILED 3-12-2005.

FLEXBAG

THE MARK CONSISTS OF STANDARD CHARACTERS WITHOUT CLAIM TO ANY PARTICULAR FONT, STYLE, SIZE, OR COLOR.

FOR DISPOSABLE PLASTIC MIXING AND REACTION FLEXIBLE CONTAINER CONTAINING INTERNAL PARTITIONS USED FOR RESEARCH AND LABORATORY PURPOSES (U.S. CLS. 21, 23, 26, 36 AND 38).

FIRST USE 4-26-2005; IN COMMERCE 12-5-2005.

3,178,282. ORTRONICS, INC., NEW LONDON, CT. SN 78-587,009. PUB. 12-20-2005, FILED 3-14-2005.

TECHCHOICE

THE MARK CONSISTS OF STANDARD CHARACTERS WITHOUT CLAIM TO ANY PARTICULAR FONT, STYLE, SIZE, OR COLOR.

FOR EQUIPMENT FOR VOICE AND DATA COMMUNICATIONS SYSTEMS, NAMELY, JACKS, CONNECTOR MODULES, CABLES, CONNECTORS, TERMINATIONS, FIBER OPTIC JUMPERS, CONNECTING BLOCKS, MODULAR COUPLER CORDS, PATCH CORDS AND PATCH PANELS FOR ENHANCING THE TRANSMISSION OF VOICE AND DATA COMMUNICATIONS AND FOR COMPLYING WITH TELECOMMUNICATION STANDARDS (U.S. CLS. 21, 23, 26, 36 AND 38).

FIRST USE 4-0-2005; IN COMMERCE 4-0-2005.

CLASS 9—(Continued).

3,178,301. ALPHA RETAIL TECHNOLOGY, INC., CALABASAS, CA. SN 78-590,891. PUB. 12-27-2005, FILED 3-18-2005.

CLASS 9—(Continued).

3,178,304. NEW BRUNSWICK SCIENTIFIC COMPANY, INC., EDISON, NJ. SN 78-591,329. PUB. 1-3-2006, FILED 3-21-2005.

AlphaSell

EXCELLA

THE MARK CONSISTS OF STANDARD CHARACTERS WITHOUT CLAIM TO ANY PARTICULAR FONT, STYLE, SIZE, OR COLOR.

FOR COMPUTER SOFTWARE FOR USE IN THE RETAIL INDUSTRY, NAMELY, FOR POINT OF SALE TRANSACTION PROCESSING AND STORE OPERATIONS SUCH AS INVENTORY CONTROL, ORDERING AND DATA PROCESSING (U.S. CLS. 21, 23, 26, 36 AND 38).

FIRST USE 2-6-2005; IN COMMERCE 2-6-2005.

THE MARK CONSISTS OF STANDARD CHARACTERS WITHOUT CLAIM TO ANY PARTICULAR FONT, STYLE, SIZE, OR COLOR.

FOR LABORATORY EQUIPMENT, NAMELY, ORBITAL BIOLOGICAL SHAKERS AND CO2 INCUBATORS; ULTRA-LOW TEMPERATURE FREEZERS USED IN SCIENTIFIC LABORATORIES (U.S. CLS. 21, 23, 26, 36 AND 38).

FIRST USE 3-15-2006; IN COMMERCE 3-15-2006.

3,178,302. COIN DATA, LLC, NORCROSS, GA. SN 78-591,020. PUB. 12-27-2005, FILED 3-19-2005.

3,178,306. ASTERES INC., SAN DIEGO, CA. SN 78-591,542. PUB. 12-13-2005, FILED 3-21-2005.

DOCUPAD

DELIVERED BY
ASTERES

THE MARK CONSISTS OF STANDARD CHARACTERS WITHOUT CLAIM TO ANY PARTICULAR FONT, STYLE, SIZE, OR COLOR.

FOR COMPUTER HARDWARE INCORPORATING FINGERPRINT SCANNERS, A CAMERA, AND AUDIO SPEAKERS FOR USE IN RETAIL AUTO SALES INDUSTRY (U.S. CLS. 21, 23, 26, 36 AND 38).

FIRST USE 2-11-2006; IN COMMERCE 4-15-2006.

THE MARK CONSISTS OF STANDARD CHARACTERS WITHOUT CLAIM TO ANY PARTICULAR FONT, STYLE, SIZE, OR COLOR.

OWNER OF U.S. REG. NO. 2,958,619.
FOR AUTOMATED MACHINES FOR CUSTOMIZED, SECURED AND CONTROLLED STORAGE, MANAGEMENT, PURCHASING AND DISPENSING OF CONSUMER PRODUCTS, HEALTHCARE MEDICATIONS, FINISHED PRESCRIPTIONS, AND INDUSTRIAL INVENTORY (U.S. CLS. 21, 23, 26, 36 AND 38).

FIRST USE 8-8-2006; IN COMMERCE 8-8-2006.

CLASS 9—(Continued).

3,178,307. HENGESTONE HOLDINGS, INC., GEORGETOWN, ONTARIO, CANADA. SN 78-591,590. PUB. 1-10-2006, FILED 3-21-2005.

REAL LANDSCAPE PRO

THE MARK CONSISTS OF STANDARD CHARACTERS WITHOUT CLAIM TO ANY PARTICULAR FONT, STYLE, SIZE, OR COLOR.

NO CLAIM IS MADE TO THE EXCLUSIVE RIGHT TO USE "LANDSCAPE PRO", APART FROM THE MARK AS SHOWN.

FOR LANDSCAPE VISUALIZATION SOFTWARE (U.S. CLS. 21, 23, 26, 36 AND 38).

FIRST USE 3-31-2004; IN COMMERCE 3-31-2004.

3,178,310. ARCOM DIGITAL, LLC, SYRACUSE, NY. SN 78-592,089. PUB. 4-11-2006, FILED 3-22-2005.

CPD HUNTER

THE MARK CONSISTS OF STANDARD CHARACTERS WITHOUT CLAIM TO ANY PARTICULAR FONT, STYLE, SIZE, OR COLOR.

NO CLAIM IS MADE TO THE EXCLUSIVE RIGHT TO USE "CPD", APART FROM THE MARK AS SHOWN.

FOR ELECTRONIC APPARATUS COMPRISING A HEADEND CPD RADAR UNIT, A RETURN PATH SWITCH, A COMPUTER FOR CONTROLLING THE OPERATION OF THE HEADEND CPD RADAR UNIT AND RETURN PATH SWITCH AND FOR CALCULATING INPUTS FOR AND PROCESSING OUTPUTS FROM THE HEADEND CPD RADAR UNIT AND RETURN PATH SWITCH, AND A PORTABLE FIELD RADAR-CALIBRATOR UNIT THAT COMMUNICATES WITH THE HEADEND CPD RADAR UNIT, THE APPARATUS BEING USED FOR IDENTIFYING AND LOCATING SOURCES OF COMMON PATH DISTORTION IN A BI-DIRECTIONAL CABLE TELEVISION NETWORK; AND COMPUTER SOFTWARE FOR THE OPERATION OF APPARATUS THAT IDENTIFY AND LOCATE SOURCES OF COMMON PATH DISTORTION IN BI-DIRECTIONAL CABLE NETWORKS AND MANUALS SUPPLIED THEREWITH (U.S. CLS. 21, 23, 26, 36 AND 38).

FIRST USE 10-20-2005; IN COMMERCE 10-20-2005.

CLASS 9—(Continued).

3,178,350. COOL SPRINGS MUSIC GROUP, LLC, FRANKLIN, TN. SN 78-598,528. PUB. 12-27-2005, FILED 3-30-2005.

COOL SPRINGS

THE MARK CONSISTS OF STANDARD CHARACTERS WITHOUT CLAIM TO ANY PARTICULAR FONT, STYLE, SIZE, OR COLOR.

FOR PRERECORDED PHONOGRAPH RECORDS, AUDIO CASSETTES, AUDIO TAPES, VIDEO TAPES, SOUND RECORDING DISCS, COMPACT DISCS AND DVDS FEATURING MUSIC (U.S. CLS. 21, 23, 26, 36 AND 38).

FIRST USE 5-14-2006; IN COMMERCE 5-14-2006.

3,178,368. SMA TECHNOLOGIE AG, NIESTETAL, FED REP GERMANY. SN 78-602,949. PUB. 12-27-2005, FILED 4-6-2005.

SUNNY MATRIX

THE MARK CONSISTS OF STANDARD CHARACTERS WITHOUT CLAIM TO ANY PARTICULAR FONT, STYLE, SIZE, OR COLOR.

FOR ELECTRICAL DISPLAY PANEL FOR MONITORING THE DATA OF A SOLAR PLANT OR AN INVERTER, IN CONNECTION WITH GENERAL DATA AND ADVERTISING INFORMATION (U.S. CLS. 21, 23, 26, 36 AND 38).

FIRST USE 8-1-2005; IN COMMERCE 12-6-2005.

CLASS 9—(Continued).

3,178,371. ZILKER LABS, INC., AUSTIN, TX. SN 78-603,177. PUB. 1-10-2006, FILED 4-6-2005.

POWERING YOUR IDEAS

THE MARK CONSISTS OF STANDARD CHARACTERS WITHOUT CLAIM TO ANY PARTICULAR FONT, STYLE, SIZE, OR COLOR.

FOR ELECTRONIC HARDWARE, NAMELY, A POWER DELIVERY SYSTEM TO CONTROL, CONFIGURE, MONITOR AND MANAGE POWER DISTRIBUTION TO AND REMOVE WASTE HEAT FROM INTEGRATED CIRCUITS, CIRCUIT BOARDS, ELECTRONIC COMPONENTS AND ELECTRONIC SYSTEMS; ELECTRONIC HARDWARE, NAMELY, POWER DISTRIBUTION CIRCUITS FOR POWER CONVERSION AND DELIVERY; ELECTRONIC HARDWARE, NAMELY, SEMICONDUCTOR AND CIRCUIT BOARD ARCHITECTURE TO DISTRIBUTE POWER AMONG INTEGRATED CIRCUITS, CIRCUIT BOARDS, ELECTRONIC COMPONENTS AND ELECTRONIC SYSTEMS; INTEGRATED CIRCUITS; AND ELECTRONIC HARDWARE, NAMELY, CIRCUIT BOARDS AND SEMICONDUCTORS (U.S. CLS. 21, 23, 26, 36 AND 38).

FIRST USE 3-0-2005; IN COMMERCE 6-0-2005.

CLASS 9—(Continued).

3,178,386. KING OF KINGS, INC., MIAMI, FL. SN 78-609,557. PUB. 1-17-2006, FILED 4-15-2005.



NO CLAIM IS MADE TO THE EXCLUSIVE RIGHT TO USE RECORDS, APART FROM THE MARK AS SHOWN.

THE COLORS GOLD, RED, BLUE, GREEN, SILVER, BLACK AND WHITE ARE CLAIMED AS A FEATURE OF THE MARK.

THE COLOR RED APPEARS ON THE VELVET EXTERIOR OF THE CROWN, THE COLOR GOLD APPEARS IN BOTH CROWNS, THE COLORS BLUE, GREEN AND RED APPEAR IN THE JEWELS ON THE CROWN, THE COLORS BLACK AND WHITE APPEAR ON THE FUR LINING OF THE CROWN, THE COLOR BLACK APPEARS IN THE RECTANGULAR BOX, THE COLOR SILVER APPEARS IN THE BANNERS, THE COLORS GOLD AND WHITE APPEAR IN THE WORDING K.O.K.E. RECORDS.

FOR MUSICAL SOUND RECORDINGS (U.S. CLS. 21, 23, 26, 36 AND 38).

FIRST USE 8-1-2006; IN COMMERCE 8-1-2006.

3,178,393. JAMBA JUICE COMPANY, SAN FRANCISCO, CA. SN 78-611,930. PUB. 9-27-2005, FILED 4-19-2005.

3,178,385. INFO PLUS ACCOUNTING, P.C., YPSILANTI, MI. SN 78-608,588. PUB. 1-10-2006, FILED 4-14-2005.

QLEAN\$TART



OWNER OF U.S. REG. NO. 2,759,626. FOR COMPUTER SOFTWARE FOR USE IN MANAGING FINANCIAL INFORMATION AND TRANSACTIONS; COMPUTER SOFTWARE FOR ACCOUNTING AND RECORDKEEPING APPLICATIONS; AND INSTRUCTION MANUALS PROVIDED TOGETHER THEREWITH (U.S. CLS. 21, 23, 26, 36 AND 38). FIRST USE 9-30-2005; IN COMMERCE 9-30-2005.

OWNER OF U.S. REG. NOS. 2,097,875, 2,110,410, AND OTHERS. FOR PORTABLE LISTENING DEVICES, NAMELY, MP3 PLAYERS; HEADSETS FOR MP3 PLAYERS; SPECIALTY HOLSTERS FOR CARRYING MP3 PLAYERS (U.S. CLS. 21, 23, 26, 36 AND 38). FIRST USE 6-29-2005; IN COMMERCE 6-29-2005.

CLASS 9—(Continued).

3,178,394. JAMBA JUICE COMPANY, SAN FRANCISCO, CA. SN 78-611,939. PUB. 9-27-2005, FILED 4-19-2005.



OWNER OF U.S. REG. NOS. 2,097,875, 2,110,410, AND OTHERS.

FOR COMPUTER SOFTWARE, NAMELY, DOWNLOADABLE COMPUTER GAME SOFTWARE, DOWNLOADABLE ELECTRONIC GAME SOFTWARE AND DOWNLOADABLE VIDEO GAME SOFTWARE (U.S. CLS. 21, 23, 26, 36 AND 38).

FIRST USE 3-25-2005; IN COMMERCE 3-25-2005.

3,178,399. CULLIMORE AND RING TECHNOLOGIES, INC., LITTLETON, CO. SN 78-614,741. PUB. 1-17-2006, FILED 4-22-2005.

SINDAWORKS

THE MARK CONSISTS OF STANDARD CHARACTERS WITHOUT CLAIM TO ANY PARTICULAR FONT, STYLE, SIZE, OR COLOR.

FOR COMPUTER SOFTWARE FOR FLUID FLOW AND THERMAL ANALYSIS (U.S. CLS. 21, 23, 26, 36 AND 38).

FIRST USE 6-8-2006; IN COMMERCE 6-8-2006.

3,178,401. S&C ELECTRIC CO., CHICAGO, IL. SN 78-616,155. PUB. 6-6-2006, FILED 4-25-2005.

OMNI-MATE

THE MARK CONSISTS OF STANDARD CHARACTERS WITHOUT CLAIM TO ANY PARTICULAR FONT, STYLE, SIZE, OR COLOR.

FOR ELECTRICAL SWITCHES, ELECTRIC SWITCH OPERATING MECHANISMS AND PARTS THEREOF (U.S. CLS. 21, 23, 26, 36 AND 38).

FIRST USE 6-28-2005; IN COMMERCE 6-28-2005.

CLASS 9—(Continued).

3,178,415. LIGHTTECH ELECTRONIC INDUSTRIES LTD., LOD, ISRAEL. SN 78-621,690. PUB. 1-24-2006, FILED 5-3-2005.



THE COLOR(S) RED, GREY WHITE AND BLACK IS/ARE CLAIMED AS A FEATURE OF THE MARK.

THE MARK CONSISTS OF THE WORDS LIGHT YEARS AHEAD IN LIGHT GREY ON A BLACK BACKGROUND ABOVE THE CENTERED TERM LIGHTTECH, WITH THE LETTERS LIGH IN WHITE AND THE LETTERS TECH IN BLACK WITH A RECTANGULAR BACKGROUND IN RED BEHIND THE LETTERS TECH.

FOR ELECTRONIC POWER SUPPLIES FOR LIGHTING NAMELY, ELECTRONIC TRANSFORMERS, ELECTRONIC CONVERTERS, ELECTRONIC LIGHTING BALLASTS, AND ELECTRONIC POWER SUPPLIES FOR LEDS (U.S. CLS. 21, 23, 26, 36 AND 38).

FIRST USE 12-31-2004; IN COMMERCE 12-31-2004.

3,178,423. SEACHANGE INTERNATIONAL, INC., ACTON, MA. SN 78-624,158. PUB. 12-13-2005, FILED 5-5-2005.

SEACHANGE QUICKSILVER

THE MARK CONSISTS OF STANDARD CHARACTERS WITHOUT CLAIM TO ANY PARTICULAR FONT, STYLE, SIZE, OR COLOR.

OWNER OF U.S. REG. NOS. 2,158,634 AND 2,222,978. FOR COMPUTER HARDWARE; COMPUTER SOFTWARE USED FOR THE PRODUCTION OF ON-DEMAND AUDIO, VISUAL AND DIGITAL CONTENT (U.S. CLS. 21, 23, 26, 36 AND 38).

FIRST USE 4-28-2005; IN COMMERCE 4-28-2005.

3,178,430. NEWBOLD CORPORATION, ROCKY MOUNT, VA. SN 78-627,536. PUB. 1-31-2006, FILED 5-11-2005.

GIFTCARDSWORK

THE MARK CONSISTS OF STANDARD CHARACTERS WITHOUT CLAIM TO ANY PARTICULAR FONT, STYLE, SIZE, OR COLOR.

FOR COMPUTER PROGRAMS FOR CREATING GIFT CARDS AND GIFT CERTIFICATES (U.S. CLS. 21, 23, 26, 36 AND 38).

FIRST USE 8-5-2004; IN COMMERCE 8-5-2004.

CLASS 9—(Continued).

3,178,434. WEBRAISER TECHNOLOGIES, INC., SACRAMENTO, CA. SN 78-628,551. PUB. 3-28-2006, FILED 5-12-2005.

CLASS 9—(Continued).

3,178,435. HARCO LABORATORIES, INC., BRANFORD, CT. SN 78-628,803. PUB. 5-2-2006, FILED 5-12-2005.



VendiStore

OWNER OF U.S. REG. NO. 839,551.

THE COLOR(S) BLACK, ORANGE, GRAY AND BLUE IS/ ARE CLAIMED AS A FEATURE OF THE MARK.

THE MARK CONSISTS OF THE WORDING HARCO IN BLACK ABOVE THE WORDING INNOVATIVE SOLUTIONS. PROVEN PERFORMANCE. IN BLACK AND NEXT TO AND PARTIALLY IN FRONT OF A DESIGN FEATURING TWO BLUE AND TWO GREY INTERSECTING CURVED LINES AND AN ORANGE CIRCLE.

THE MARK CONSISTS OF FOUR INTERSECTING CURVED LINES AND A CIRCLE IN CONJUNCTION WITH WORDING. THE WORDING HARCO APPEARS IN BLACK ABOVE THE WORDING INNOVATIVE SOLUTIONS. PROVEN PERFORMANCE, WHICH ARE ALSO IN BLACK. TWO OF THE CURVED LINES ARE BLUE. TWO OF THE CURVED LINES ARE GRAY. THE CIRCLE AT THE TIP OF ONE OF THE BLUE CURVED LINES IS ORANGE.

FOR ELECTRICAL AND ELECTRONIC TEMPERATURE AND PRESSURE SENSING APPARATUS, INSTRUMENTS, COMPONENTS AND FITTINGS THEREFOR, NAMELY— THERMOCOUPLES; THERMOCOUPLE HARNESSES; THERMOCOUPLE LEADS; THERMOCOUPLE CONNECTORS; TOTAL PRESSURE PROBES; TOTAL AND STATIC PRESSURE PROBES; AVERAGE PRESSURE PROBES; MAGNETIC SPEED SENSORS; OPTIC SENSORS; AIR TEMPERATURE SENSORS; RESISTANCE TEMPERATURE SENSORS; DATA SENSING INSTRUMENTS FOR AIRCRAFT—NAMELY, TOTAL TEMPERATURE SENSORS, PITOT AND PITOT STATIC TUBES, AND ANGLE OF ATTACK SENSORS; RESISTANCE BRIDGES; ICE DETECTORS; AND TRANSMITTERS FOR RECEIVING SIGNALS FROM SENSORS SENSING PHYSICAL DATA AND TRANSMITTING THE SIGNALS TO READOUT EQUIPMENT; ELECTRICAL CABLES FOR USE IN CONNECTIONS (U.S. CLS. 21, 23, 26, 36 AND 38).

FIRST USE 6-30-2005; IN COMMERCE 6-30-2005.

THE MARK CONSISTS OF STANDARD CHARACTERS WITHOUT CLAIM TO ANY PARTICULAR FONT, STYLE, SIZE, OR COLOR.

FOR COMPUTER SOFTWARE FOR SELF-SERVICE KIOSKS AND VENDING MACHINES (U.S. CLS. 21, 23, 26, 36 AND 38).

FIRST USE 2-1-2005; IN COMMERCE 3-1-2005.

CLASS 9—(Continued).

3,178,441. MIKROS SYSTEMS CORPORATION, PRINCETON, NJ. SN 78-631,587. PUB. 2-21-2006, FILED 5-17-2005.

ADEPT

THE MARK CONSISTS OF STANDARD CHARACTERS WITHOUT CLAIM TO ANY PARTICULAR FONT, STYLE, SIZE, OR COLOR.

FOR PORTABLE, ADAPTIVE ELECTRONIC DIAGNOSTIC TEST SET, NAMELY, A PERSONAL COMPUTER INTERACTIVE WITH DEVICES, NAMELY, DIGITIZER CARD, SWITCH CARD, MULTIMETER CARD, SPECTRUM ANALYZER, RF SENSOR OR MULTIPLE RF SENSORS FOR COMPUTER-AIDED TESTING, MAINTAINING, AND MONITORING THE PERFORMANCE OF ELECTRONIC SYSTEMS, NAMELY, RADAR, COMMUNICATIONS, SONAR AND DISPLAY SYSTEMS (U.S. CLS. 21, 23, 26, 36 AND 38).

FIRST USE 9-1-2004; IN COMMERCE 9-1-2004.

3,178,445. WATERS INVESTMENTS LIMITED, NEW CASTLE, DE. SN 78-632,187. PUB. 3-28-2006, FILED 5-18-2005.

SERIES-4EX

THE MARK CONSISTS OF STANDARD CHARACTERS WITHOUT CLAIM TO ANY PARTICULAR FONT, STYLE, SIZE, OR COLOR.

FOR FLUOROMETERS (U.S. CLS. 21, 23, 26, 36 AND 38).

FIRST USE 7-30-2006; IN COMMERCE 7-30-2006.

3,178,455. GPSHOPPER, LLC, NEW YORK, NY. SN 78-637,898. PUB. 11-22-2005, FILED 5-26-2005.

MOBILIZING MAIN STREET

THE MARK CONSISTS OF STANDARD CHARACTERS WITHOUT CLAIM TO ANY PARTICULAR FONT, STYLE, SIZE, OR COLOR.

FOR INTERACTIVE MARKETING SOFTWARE ENABLING USERS, MERCHANTS, MANUFACTURERS AND RETAILERS TO SHARE THE LOCATION AND DETAILED INFORMATION OF PRODUCTS AND SERVICES THROUGH THE USE OF WIRELESS COMMUNICATIONS (U.S. CLS. 21, 23, 26, 36 AND 38).

FIRST USE 9-0-2005; IN COMMERCE 9-0-2005.

CLASS 9—(Continued).

3,178,469. DELAWARE CAPITAL FORMATION, INC., WILMINGTON, DE. SN 78-642,003. PUB. 5-23-2006, FILED 6-2-2005.

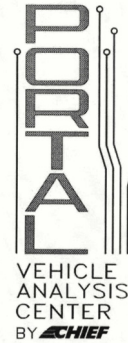

OWNER OF U.S. REG. NOS. 2,015,109, 2,895,652, AND OTHERS.

NO CLAIM IS MADE TO THE EXCLUSIVE RIGHT TO USE "VEHICLE ANALYSIS CENTER", APART FROM THE MARK AS SHOWN.

THE COLOR GRAY IS INTENDED TO INDICATE SHADING.

FOR DIAGNOSTIC APPARATUS, NOT FOR MEDICAL PURPOSES, FOR MEASURING, ANALYZING, ESTIMATING THE COST TO REPAIR AND REPAIRING DAMAGE TO VEHICLES; PRE-RECORDED CD-ROMS AND DOWNLOADABLE COMPUTER SOFTWARE FOR MEASURING, ANALYZING, ESTIMATING THE COST TO REPAIR AND REPAIRING DAMAGE TO VEHICLES (U.S. CLS. 21, 23, 26, 36 AND 38).

FIRST USE 11-0-2005; IN COMMERCE 11-0-2005.

3,178,474. ACTIFY, INC., SAN FRANCISCO, CA. SN 78-646,609. PUB. 3-21-2006, FILED 6-8-2005.

ACTIFY PUBLISHER

THE MARK CONSISTS OF STANDARD CHARACTERS WITHOUT CLAIM TO ANY PARTICULAR FONT, STYLE, SIZE, OR COLOR.

NO CLAIM IS MADE TO THE EXCLUSIVE RIGHT TO USE "PUBLISHER", APART FROM THE MARK AS SHOWN.

FOR COMPUTER SOFTWARE FOR CONVERTING, CENTRALIZING AND AUTOMATING BATCH PUBLISHING OF 2D AND 3D CAD FILES INTO 3D FILE FORMAT (U.S. CLS. 21, 23, 26, 36 AND 38).

FIRST USE 3-15-2005; IN COMMERCE 3-15-2005.

CLASS 9—(Continued).

3,178,485. ACTIVIDENTITY (AUSTRALIA) PTY LTD., FREMONT, CA. SN 78-649,780. PUB. 2-21-2006, FILED 6-13-2005.

ActivIdentity

THE MARK CONSISTS OF STANDARD CHARACTERS WITHOUT CLAIM TO ANY PARTICULAR FONT, STYLE, SIZE, OR COLOR.

FOR COMPUTER SOFTWARE AND HARDWARE IN THE FIELD OF CONTROLLING NETWORK FUNCTIONS AND ACCESS IN THE FIELD OF NETWORK SECURITY AND SERVER SECURITY (U.S. CLS. 21, 23, 26, 36 AND 38).

FIRST USE 2-0-2006; IN COMMERCE 2-0-2006.

CLASS 9—(Continued).

3,178,502. CANNED INTERACTIVE, INC., DBA THE CANNERY, BURBANK, CA. SN 78-657,438. PUB. 3-7-2006, FILED 6-23-2005.

WHO RULES THE REMOTE

THE MARK CONSISTS OF STANDARD CHARACTERS WITHOUT CLAIM TO ANY PARTICULAR FONT, STYLE, SIZE, OR COLOR.

FOR INTERACTIVE QUESTION AND ANSWER VIDEO AND COMPUTER GAMES (U.S. CLS. 21, 23, 26, 36 AND 38).

FIRST USE 11-0-2005; IN COMMERCE 11-0-2005.

3,178,488. PLANTRONICS, INC., SANTA CRUZ, CA. SN 78-650,619. PUB. 6-6-2006, FILED 6-14-2005.

PULSAR

THE MARK CONSISTS OF STANDARD CHARACTERS WITHOUT CLAIM TO ANY PARTICULAR FONT, STYLE, SIZE, OR COLOR.

FOR HEADSETS FOR USE WITH COMMUNICATIONS DEVICES, NAMELY TELEPHONES, MOBILE PHONES, COMPUTERS, MUSIC AND CONTENT DELIVERY DEVICES, NAMELY TELEVISIONS, DVD PLAYERS, MP3 PLAYERS, PDA'S, COMPUTERS, STEREO ENTERTAINMENT SYSTEMS, CD PLAYERS AND PARTS THEREFOR (U.S. CLS. 21, 23, 26, 36 AND 38).

FIRST USE 9-30-2005; IN COMMERCE 9-30-2005.

3,178,507. RALEY'S TM, INC., WEST SACRAMENTO, CA. SN 78-659,184. PUB. 3-14-2006, FILED 6-27-2005.

RALEY'S BEL AIR FINE LIVING

THE MARK CONSISTS OF STANDARD CHARACTERS WITHOUT CLAIM TO ANY PARTICULAR FONT, STYLE, SIZE, OR COLOR.

FOR BATTERIES AND DISPOSABLE CAMERAS (U.S. CLS. 21, 23, 26, 36 AND 38).

FIRST USE 10-2-2005; IN COMMERCE 10-2-2005.

3,178,501. CANNED INTERACTIVE, INC., DBA THE CANNERY, BURBANK, CA. SN 78-657,434. PUB. 3-7-2006, FILED 6-23-2005.

WHO RULES

THE MARK CONSISTS OF STANDARD CHARACTERS WITHOUT CLAIM TO ANY PARTICULAR FONT, STYLE, SIZE, OR COLOR.

FOR INTERACTIVE QUESTION AND ANSWER VIDEO AND COMPUTER GAMES (U.S. CLS. 21, 23, 26, 36 AND 38).

FIRST USE 8-0-2005; IN COMMERCE 8-0-2005.

3,178,515. BIG TIME PRODUCTS, L.L.C., ROME, GA. SN 78-660,783. PUB. 3-21-2006, FILED 6-29-2005.

BOXMASTER

THE MARK CONSISTS OF STANDARD CHARACTERS WITHOUT CLAIM TO ANY PARTICULAR FONT, STYLE, SIZE, OR COLOR.

FOR PROTECTIVE WORK GLOVES (U.S. CLS. 21, 23, 26, 36 AND 38).

FIRST USE 10-20-2005; IN COMMERCE 10-20-2005.

CLASS 9—(Continued).

3,178,524. DAYSTAR TECHNOLOGIES INC., HALFMOON, NY. SN 78-664,559. PUB. 11-15-2005, FILED 7-6-2005.

LIGHTIR

THE MARK CONSISTS OF STANDARD CHARACTERS WITHOUT CLAIM TO ANY PARTICULAR FONT, STYLE, SIZE, OR COLOR.

FOR SOLAR CELLS AND PHOTOVOLTAIC SOLAR MODULES (U.S. CLS. 21, 23, 26, 36 AND 38).

FIRST USE 7-6-2006; IN COMMERCE 7-6-2006.

CLASS 9—(Continued).

3,178,553. FONEGEAR, LLC, TROY, MI. SN 78-675,995. PUB. 4-18-2006, FILED 7-22-2005.

TUNE GEAR

THE MARK CONSISTS OF STANDARD CHARACTERS WITHOUT CLAIM TO ANY PARTICULAR FONT, STYLE, SIZE, OR COLOR.

NO CLAIM IS MADE TO THE EXCLUSIVE RIGHT TO USE "GEAR", APART FROM THE MARK AS SHOWN.

FOR CASES FOR ELECTRONIC DEVICES, NAMELY, CD PLAYERS, MP3 PLAYERS (U.S. CLS. 21, 23, 26, 36 AND 38).

FIRST USE 10-1-2005; IN COMMERCE 10-1-2005.

3,178,534. COMPUTER SCIENCES CORPORATION, EL SEGUNDO, CA. SN 78-666,323. PUB. 5-23-2006, FILED 7-8-2005.

LEGAL SOLUTIONS SUITE

THE MARK CONSISTS OF STANDARD CHARACTERS WITHOUT CLAIM TO ANY PARTICULAR FONT, STYLE, SIZE, OR COLOR.

NO CLAIM IS MADE TO THE EXCLUSIVE RIGHT TO USE "LEGAL" OR "SUITE", APART FROM THE MARK AS SHOWN.

FOR COMPUTER PROGRAMS FOR LAW OFFICE ADMINISTRATION AND OFFICE MANAGEMENT (U.S. CLS. 21, 23, 26, 36 AND 38).

FIRST USE 1-1-2004; IN COMMERCE 1-1-2004.

3,178,599. ONDA, HIDEKI FRANCIS, TOKYO, JAPAN. SN 78-704,947. PUB. 5-16-2006, FILED 9-1-2005.

TUNECUP

FOR ADAPTERS FOR MOUNTING, CHARGING, AND POWERING PORTABLE AND HANDHELD DIGITAL VIDEO OR AUDIO PLAYERS (U.S. CLS. 21, 23, 26, 36 AND 38).

FIRST USE 11-7-2005; IN COMMERCE 11-7-2005.

3,178,550. COMPUTER SCIENCES CORPORATION, EL SEGUNDO, CA. SN 78-674,501. PUB. 4-18-2006, FILED 7-20-2005.

FRAUDVISION

THE MARK CONSISTS OF STANDARD CHARACTERS WITHOUT CLAIM TO ANY PARTICULAR FONT, STYLE, SIZE, OR COLOR.

FOR COMPUTER PROGRAM FOR DETECTION OF FRAUDULENT CHECKS, DRAFTS AND OTHER INSTRUMENTS (U.S. CLS. 21, 23, 26, 36 AND 38).

FIRST USE 9-1-2005; IN COMMERCE 9-1-2005.

3,178,601. STYLEMARK, INC., ORMOND BEACH, FL. SN 78-706,384. PUB. 5-30-2006, FILED 9-2-2005.

STYLE EQUIPMENT

THE MARK CONSISTS OF STANDARD CHARACTERS WITHOUT CLAIM TO ANY PARTICULAR FONT, STYLE, SIZE, OR COLOR.

NO CLAIM IS MADE TO THE EXCLUSIVE RIGHT TO USE "EQUIPMENT", APART FROM THE MARK AS SHOWN.

FOR SUNGLASSES, EYEGLASSES, EYEGLASS FRAMES, EYEGLASS CASES AND EYEGLASS ACCESSORIES, NAMELY EYEGLASS CORDS, EYEGLASS CHAINS, NOSEPIECES AND EAR PIECES (U.S. CLS. 21, 23, 26, 36 AND 38).

FIRST USE 10-0-2005; IN COMMERCE 10-0-2005.

CLASS 9—(Continued).

3,178,605. OPTOMA TECHNOLOGY, INC., MILPITAS, CA.
SN 78-708,221. PUB. 5-23-2006, FILED 9-7-2005.



NO CLAIM IS MADE TO THE EXCLUSIVE RIGHT TO USE "1080P HIGH DEFINITION DISPLAY", APART FROM THE MARK AS SHOWN.

FOR PROJECTION SCREENS (U.S. CLS. 21, 23, 26, 36 AND 38).

FIRST USE 9-30-2005; IN COMMERCE 9-30-2005.

3,178,619. SCHOLASTIC INC., NEW YORK, NY. SN 78-713,547. PUB. 5-30-2006, FILED 9-15-2005.

RAPID MATH

THE MARK CONSISTS OF STANDARD CHARACTERS WITHOUT CLAIM TO ANY PARTICULAR FONT, STYLE, SIZE, OR COLOR.

NO CLAIM IS MADE TO THE EXCLUSIVE RIGHT TO USE "MATH", APART FROM THE MARK AS SHOWN.

FOR HANDHELD ELECTRONIC DEVICE FOR PLAYING MATH GAMES (U.S. CLS. 21, 23, 26, 36 AND 38).

FIRST USE 2-1-2006; IN COMMERCE 2-1-2006.

3,178,635. MUL-TI ENTERPRISES, INC., GAINESVILLE, GA.
SN 78-723,406. PUB. 5-30-2006, FILED 9-29-2005.

THE MANLY

THE MARK CONSISTS OF STANDARD CHARACTERS WITHOUT CLAIM TO ANY PARTICULAR FONT, STYLE, SIZE, OR COLOR.

FOR COVERS FOR PROTECTING GENITALS FROM EXPOSURE TO ULTRAVIOLET LIGHT, NOT FOR MEDICAL USE (U.S. CLS. 21, 23, 26, 36 AND 38).

FIRST USE 2-0-2006; IN COMMERCE 2-0-2006.

CLASS 9—(Continued).

3,178,655. DIOPTICS MEDICAL PRODUCTS, INC., SAN LUIS OBISPO, CA. SN 78-767,049. PUB. 5-23-2006, FILED 12-5-2005.

VISTANA

THE MARK CONSISTS OF STANDARD CHARACTERS WITHOUT CLAIM TO ANY PARTICULAR FONT, STYLE, SIZE, OR COLOR.

FOR SUNGLASSES, CLIP-ON SUNGLASSES, PROTECTIVE EYEWEAR, AND EYEGLOSS CASES (U.S. CLS. 21, 23, 26, 36 AND 38).

FIRST USE 3-1-2006; IN COMMERCE 3-1-2006.

3,178,671. DALY, CARSON, NEW YORK, NY. AND RIFKIND, JONATHAN, NEW YORK, NY. SN 78-977,640. PUB. 6-15-2004, FILED 3-27-2003.

456 ENTERTAINMENT

NO CLAIM IS MADE TO THE EXCLUSIVE RIGHT TO USE "ENTERTAINMENT", APART FROM THE MARK AS SHOWN.

FOR PRE-RECORDED COMPACT DISCS, CASSETTE TAPES, DIGITAL AUDIO TAPES, DIGITAL VIDEO DISCS, VIDEO CASSETTES FEATURING PERFORMANCES BY BANDS AND SINGERS (U.S. CLS. 21, 23, 26, 36 AND 38).

FIRST USE 9-21-2004; IN COMMERCE 9-21-2004.

CLASS 10—MEDICAL APPARATUS

3,177,340. MACKAY, DALE V., VICTORIA, AUSTRALIA. SN 76-279,624. PUB. 12-17-2002, FILED 7-3-2001.

EXPLORAR

FOR ELECTROSURGERY DISSECTING INSTRUMENTS, NAMELY ARGON PLASMA CUTTING ELECTRODES (U.S. CLS. 26, 39 AND 44).

FIRST USE 7-10-2006; IN COMMERCE 7-10-2006.

3,177,376. VITALFLOR, INC., SATELLITE BEACH, FL. SN 76-484,221. PUB. 6-24-2003, FILED 1-14-2003.

EZ-DX

OWNER OF U.S. REG. NO. 2,579,475.
FOR MEDICAL DIAGNOSTIC DEVICES, NAMELY SELF-STAINING MICROSCOPE SLIDES AND CASSETTES (U.S. CLS. 26, 39 AND 44).

FIRST USE 8-1-2006; IN COMMERCE 8-1-2006.

CLASS 10—(Continued).

3,177,488. XOFT MICROTUBE, INC., FREMONT, CA. SN 76-611,747. PUB. 9-6-2005, FILED 9-16-2004.

XOFT

THE MARK CONSISTS OF STANDARD CHARACTERS WITHOUT CLAIM TO ANY PARTICULAR FONT, STYLE, SIZE, OR COLOR.

FOR X-RAY EMISSION DEVICES AND X-RAY TUBE ASSEMBLY FOR MEDICAL USE (U.S. CLS. 26, 39 AND 44).

FIRST USE 12-0-2005; IN COMMERCE 12-0-2005.

3,177,505. INTEGRATED RECOVERY PRODUCTS, INC., COSTA MESA, CA. SN 76-616,392. PUB. 1-10-2006, FILED 10-18-2004.

KRD L 2000

THE MARK CONSISTS OF STANDARD CHARACTERS WITHOUT CLAIM TO ANY PARTICULAR FONT, STYLE, SIZE, OR COLOR.

NO CLAIM IS MADE TO THE EXCLUSIVE RIGHT TO USE 2000, APART FROM THE MARK AS SHOWN.

FOR MEDICAL APPARATUS, NAMELY, AN ORTHOPEDIC DEVICE TO EVALUATE, REHABILITATE OR TREAT SOFT TISSUE INJURIES (U.S. CLS. 26, 39 AND 44).

FIRST USE 5-31-1995; IN COMMERCE 5-31-1995.

3,177,527. STING FREE COMPANY, BERWYN, PA. SN 76-625,292. PUB. 3-28-2006, FILED 12-20-2004.

ZERO STING

THE MARK CONSISTS OF STANDARD CHARACTERS WITHOUT CLAIM TO ANY PARTICULAR FONT, STYLE, SIZE, OR COLOR.

FOR SHOE, BOOT AND ATHLETIC SHOE ORTHOTIC PADS AND INSERTS (U.S. CLS. 26, 39 AND 44).

FIRST USE 12-20-2004; IN COMMERCE 12-20-2004.

CLASS 10—(Continued).

3,177,533. ST. GEORGE TECHNOLOGY, INC., WILMINGTON, NC. SN 76-627,287. PUB. 2-28-2006, FILED 1-7-2005.

EXCEL ULTRA-HI FORMULA

THE MARK CONSISTS OF STANDARD CHARACTERS WITHOUT CLAIM TO ANY PARTICULAR FONT, STYLE, SIZE, OR COLOR.

NO CLAIM IS MADE TO THE EXCLUSIVE RIGHT TO USE FORMULA, APART FROM THE MARK AS SHOWN.

FOR DENTURE BASE MATERIALS FOR USE IN THE MANUFACTURE OF DENTURES (U.S. CLS. 26, 39 AND 44).

FIRST USE 3-14-2005; IN COMMERCE 3-14-2005.

3,177,554. VIDENT, BREA, CA. SN 76-636,059. PUB. 1-10-2006, FILED 4-14-2005.

ARCON

THE MARK CONSISTS OF STANDARD CHARACTERS WITHOUT CLAIM TO ANY PARTICULAR FONT, STYLE, SIZE, OR COLOR.

FOR DENTAL ARTICULATORS (U.S. CLS. 26, 39 AND 44).

FIRST USE 12-29-2005; IN COMMERCE 12-29-2005.

3,177,628. SHERWOOD SERVICES AG, SCHAFFHAUSEN, SWITZERLAND. SN 78-184,926. PUB. 6-24-2003, FILED 11-14-2002.

RENEWABLES

FOR CONTAINER FOR USED NEEDLES AND SYRINGES (U.S. CLS. 26, 39 AND 44).

FIRST USE 9-30-2002; IN COMMERCE 9-30-2002.

3,177,671. EPIMED INTERNATIONAL, JOHNSTOWN, NY. SN 78-287,020. PUB. 5-25-2004, FILED 8-13-2003.

FINCH

FOR MEDICAL DEVICES, NAMELY, CATHETERS, INSERTION NEEDLES, STYLETS AND CATHETER ACCESSORIES (U.S. CLS. 26, 39 AND 44).

FIRST USE 5-30-2006; IN COMMERCE 5-30-2006.

CLASS 10—(Continued).

3,177,676. C. R. BARD, INC., MURRAY HILL, NJ. SN 78-293,039. PUB. 8-10-2004, FILED 8-27-2003.

CLASS 10—(Continued).

3,177,741. GRUBER, JACK, GREAT NECK, NY. SN 78-360,003. PUB. 6-7-2005, FILED 1-30-2004.

POWERPORT

FOR MEDICAL APPARATUS, NAMELY, CATHETERS, SUBCUTANEOUS SURGICAL IMPLANTS COMPRISING ARTIFICIAL MATERIALS, AND PARTS AND FITTINGS FOR THE AFORESAID GOODS (U.S. CLS. 26, 39 AND 44).

FIRST USE 8-1-2006; IN COMMERCE 8-1-2006.

**THE BRUSHLESS
ALTERNATIVE**

3,177,695. CONOR MEDSYSTEMS, INC., MENLO PARK, CA. SN 78-317,682. PUB. 7-20-2004, FILED 10-23-2003.

CONOR

FOR MEDICAL DEVICES, NAMELY STENTS AND CATHETERS (U.S. CLS. 26, 39 AND 44).

FIRST USE 5-18-2005; IN COMMERCE 6-1-2005.

THE MARK CONSISTS OF STANDARD CHARACTERS WITHOUT CLAIM TO ANY PARTICULAR FONT, STYLE, SIZE, OR COLOR.

NO CLAIM IS MADE TO THE EXCLUSIVE RIGHT TO USE "BRUSHLESS", APART FROM THE MARK AS SHOWN.

FOR DENTAL INSTRUMENT USED TO CLEAN THE TEETH AND GUMS (U.S. CLS. 26, 39 AND 44).

FIRST USE 7-7-2006; IN COMMERCE 7-7-2006.

3,177,728. FMS FUTURE MEDICAL SYSTEM, MEYRIN-GENEVA, SWITZERLAND. SN 78-348,574. PUB. 11-30-2004, FILED 1-7-2004.

BLOOD STOP

THE MARK CONSISTS OF STANDARD CHARACTERS WITHOUT CLAIM TO ANY PARTICULAR FONT, STYLE, SIZE, OR COLOR.

FOR FEATURE OF A FLUID MANAGEMENT SYSTEM USED FOR ENDOSCOPIC SURGERY CONSISTING OF PUMP, FOOT PEDAL AND REMOTE CONTROL (U.S. CLS. 26, 39 AND 44).

FIRST USE 11-16-2004; IN COMMERCE 5-15-2005.

3,177,751. E.R. SQUIBB & SONS, L.L.C., PRINCETON, NJ. SN 78-366,014. PUB. 11-16-2004, FILED 2-11-2004.

FlexiSeal
FMS

OWNER OF U.S. REG. NO. 2,775,587.

FOR MEDICAL DEVICE, NAMELY, A FECAL MANAGEMENT SYSTEM COMPRISED OF A CATHETER, AN ANNULAR BALLOON, A POUCH, AND PARTS AND FITTINGS THEREFOR; AND FECAL INCONTINENCE MANAGEMENT SYSTEM COMPRISED OF A CATHETER, AN ANNULAR BALLOON, A POUCH, AND PARTS AND FITTINGS THEREFOR (U.S. CLS. 26, 39 AND 44).

FIRST USE 8-1-2004; IN COMMERCE 8-1-2004.

CLASS 10—(Continued).

3,177,788. ISOTIS ORTHOBIOLOGICS, INC., IRVINE, CA. SN 78-389,395. PUB. 1-24-2006, FILED 3-23-2004.

OSSATURA BCP

THE MARK CONSISTS OF STANDARD CHARACTERS WITHOUT CLAIM TO ANY PARTICULAR FONT, STYLE, SIZE, OR COLOR.

NO CLAIM IS MADE TO THE EXCLUSIVE RIGHT TO USE BCP, APART FROM THE MARK AS SHOWN.

FOR SURGICAL IMPLANTS COMPRISING ARTIFICIAL MATERIALS TO PROMOTE BONE REGENERATION; BONE IMPLANTS COMPRISING OF ARTIFICIAL MATERIALS; SYNTHETIC BONE SUBSTITUTES; ARTIFICIAL BONE AND CARTILAGE FOR IMPLANTATION AND RESEARCH (U.S. CLS. 26, 39 AND 44).

FIRST USE 8-31-2004; IN COMMERCE 8-31-2004.

3,177,789. ISOTIS ORTHOBIOLOGICS, INC., IRVINE, CA. SN 78-389,398. PUB. 1-24-2006, FILED 3-23-2004.

OSSATURA TCP

THE MARK CONSISTS OF STANDARD CHARACTERS WITHOUT CLAIM TO ANY PARTICULAR FONT, STYLE, SIZE, OR COLOR.

NO CLAIM IS MADE TO THE EXCLUSIVE RIGHT TO USE "TCP", APART FROM THE MARK AS SHOWN.

FOR SURGICAL IMPLANTS COMPRISING ARTIFICIAL MATERIALS TO PROMOTE BONE REGENERATION; BONE IMPLANTS COMPRISING OF ARTIFICIAL MATERIALS; SYNTHETIC BONE SUBSTITUTES; ARTIFICIAL BONE AND CARTILAGE FOR IMPLANTATION AND RESEARCH (U.S. CLS. 26, 39 AND 44).

FIRST USE 8-31-2004; IN COMMERCE 8-31-2004.

CLASS 10—(Continued).

3,177,801. MEDTRONIC, INC., MINNEAPOLIS, MN. SN 78-398,840. PUB. 10-11-2005, FILED 4-8-2004.

INTERSTIM ICON

THE MARK CONSISTS OF STANDARD CHARACTERS WITHOUT CLAIM TO ANY PARTICULAR FONT, STYLE, SIZE, OR COLOR.

OWNER OF U.S. REG. NOS. 2,072,076 AND 2,811,731. FOR MEDICAL DEVICES, NAMELY, PROGRAMMERS FOR IMPLANTABLE STIMULATOR FOR PELVIC FUNCTIONAL DISORDERS (U.S. CLS. 26, 39 AND 44).

FIRST USE 8-1-2006; IN COMMERCE 8-1-2006.

3,177,831. BLACKSTONE MEDICAL, INC., SPRINGFIELD, MA. SN 78-415,732. PUB. 5-31-2005, FILED 5-10-2004.

CONSTRUX

THE MARK CONSISTS OF STANDARD CHARACTERS WITHOUT CLAIM TO ANY PARTICULAR FONT, STYLE, SIZE, OR COLOR.

FOR MEDICAL DEVICES, NAMELY INTERIOR CERVICAL PLATING SYSTEMS CONTAINING AN ASSORTMENT OF PROSTHETIC PLATES, RODS AND FIXATION HARDWARE, NAMELY SCREWS, CABLE AND HOOKS, WRITTEN INSTRUCTIONS SOLD AS A UNIT (U.S. CLS. 26, 39 AND 44).

FIRST USE 7-7-2004; IN COMMERCE 7-7-2004.

CLASS 10—(Continued).

3,177,838. CRYOCOR, INC., SAN DIEGO, CA. SN 78-422,573.
PUB. 5-10-2005, FILED 5-20-2004.

CryoBlator

THE MARK CONSISTS OF STANDARD CHARACTERS WITHOUT CLAIM TO ANY PARTICULAR FONT, STYLE, SIZE, OR COLOR.

FOR MEDICAL DEVICES FOR USE IN SURGICAL APPLICATIONS, NAMELY AN INTRAVASCULAR CATHETER FOR CRYOGENIC TREATMENT OF ABNORMAL OR DISEASED TISSUE (U.S. CLS. 26, 39 AND 44).
FIRST USE 5-6-2005; IN COMMERCE 5-6-2005.

3,177,842. DEPUY, INC., WARSAW, IN. SN 78-424,617. PUB. 10-11-2005, FILED 5-25-2004.

ATN

THE MARK CONSISTS OF STANDARD CHARACTERS WITHOUT CLAIM TO ANY PARTICULAR FONT, STYLE, SIZE, OR COLOR.

FOR ORTHOPAEDIC NAILS AND SCREWS (U.S. CLS. 26, 39 AND 44).
FIRST USE 6-22-2002; IN COMMERCE 6-22-2002.

CLASS 10—(Continued).

3,177,866. ATRIUM MEDICAL CORPORATION, HUDSON, NH. SN 78-437,053. PUB. 5-3-2005, FILED 6-17-2004.

C-QUR

THE MARK CONSISTS OF STANDARD CHARACTERS WITHOUT CLAIM TO ANY PARTICULAR FONT, STYLE, SIZE, OR COLOR.

FOR MEDICAL DEVICES, NAMELY, SURGICAL MESH AND ADHESION BARRIER IMPLANTS FOR SOFT TISSUE REPAIR (U.S. CLS. 26, 39 AND 44).
FIRST USE 5-15-2006; IN COMMERCE 5-15-2006.

3,177,906. SMITHS MEDICAL ASD, INC., KEENE, NH. SN 78-450,815. PUB. 9-13-2005, FILED 7-14-2004.

THE POINT OF SPINAL ANESTHESIA

THE MARK CONSISTS OF STANDARD CHARACTERS WITHOUT CLAIM TO ANY PARTICULAR FONT, STYLE, SIZE, OR COLOR.

NO CLAIM IS MADE TO THE EXCLUSIVE RIGHT TO USE "SPINAL ANESTHESIA", APART FROM THE MARK AS SHOWN.

FOR NEEDLES FOR MEDICAL USE, NAMELY SPINAL NEEDLES AND NEEDLES FOR USE IN DELIVERING ANESTHESIA (U.S. CLS. 26, 39 AND 44).
FIRST USE 4-12-2006; IN COMMERCE 4-12-2006.

3,177,936. SANTÉ FÉMININE LIMITED, SMYRNA, GA. SN 78-463,622. PUB. 11-29-2005, FILED 8-6-2004.

SENSATOUC

THE MARK CONSISTS OF STANDARD CHARACTERS WITHOUT CLAIM TO ANY PARTICULAR FONT, STYLE, SIZE, OR COLOR.

FOR GLOVES FOR BREAST SELF-EXAMINATION (U.S. CLS. 26, 39 AND 44).
FIRST USE 8-20-2004; IN COMMERCE 8-20-2004.

CLASS 10—(Continued).

3,177,969. TYCO HEALTHCARE GROUP LP, NORWALK, CT. SN 78-471,765. PUB. 1-3-2006, FILED 8-23-2004.

autosuture[®]

FOR SURGICAL DEVICES NAMELY, WOUND CLOSURE DEVICES IN THE NATURE OF STAPLERS, SUTURES, SURGICAL NEEDLES, TROCARS, CLIP APPLIERS; ENDOSCOPIC INSTRUMENTS IN THE NATURE OF STAPLERS, LIGATING LOOPS AND LIGATURES; BIOPSY NEEDLES; LAPAROSCOPIC SUCTION AND IRRIGATION DEVICES IN THE NATURE OF WANDS, TUBING, PUMPS AND POWER SUPPLIES; ELECTRODES, GRASPERS, CUTTERS, RETRACTORS, SEAL CONVERTERS; ANCHORING DEVICES NAMELY FIXATORS, MESH AND HELICAL TACKS; LAPAROSCOPES, AND ACCESSORIES IN THE NATURE OF SIZERS, COUPLERS, FOOT PEDALS, CABLES, POWER CORDS, AND ADAPTORS FOR USE IN ALL SURGICAL APPLICATIONS (U.S. CLS. 26, 39 AND 44).

FIRST USE 11-30-2004; IN COMMERCE 11-30-2004.

3,177,984. GENESEE BIOMEDICAL, INC., DENVER, CO. SN 78-476,500. PUB. 7-12-2005, FILED 8-31-2004.

Tender-Foot

THE MARK CONSISTS OF STANDARD CHARACTERS WITHOUT CLAIM TO ANY PARTICULAR FONT, STYLE, SIZE, OR COLOR.

FOR SURGICAL INSTRUMENT FOR USE AS A HEART STABILIZER IN BEATING HEART CORONARY ARTERY BYPASS SURGERY (U.S. CLS. 26, 39 AND 44).
FIRST USE 7-31-2006; IN COMMERCE 7-31-2006.

CLASS 10—(Continued).

3,178,004. CARDIOCOMMAND, INC., TAMPA, FL. SN 78-486,883. PUB. 9-6-2005, FILED 9-21-2004.

TOURNICATH

THE MARK CONSISTS OF STANDARD CHARACTERS WITHOUT CLAIM TO ANY PARTICULAR FONT, STYLE, SIZE, OR COLOR.

FOR CATHETER DESIGNED TO CONTROL BLEEDING INSIDE WOUNDS (U.S. CLS. 26, 39 AND 44).
FIRST USE 8-6-2004; IN COMMERCE 8-14-2006.

3,178,005. MEDTRONIC, INC., MINNEAPOLIS, MN. SN 78-486,957. PUB. 7-12-2005, FILED 9-21-2004.

MEDTRONIC
CAREALERT

THE MARK CONSISTS OF STANDARD CHARACTERS WITHOUT CLAIM TO ANY PARTICULAR FONT, STYLE, SIZE, OR COLOR.

OWNER OF U.S. REG. NOS. 989,169, 1,014,415, AND OTHERS.

FOR FEATURE OF IMPLANTED MEDICAL DEVICES USED IN CARDIAC RE-SYNCHRONIZATION AND THE TREATMENT OF HEART FAILURE TO PROVIDE WIRELESS ALERT TO PHYSICIAN OF AN IMPENDING CHANGE IN THE PATIENT'S CARDIAC DISEASE (U.S. CLS. 26, 39 AND 44).

FIRST USE 7-18-2006; IN COMMERCE 7-18-2006.

CLASS 10—(Continued).

3,178,016. ARTHROCARE CORPORATION, SUNNYVALE, CA. SN 78-491,062. PUB. 9-6-2005, FILED 9-28-2004.

CLASS 10—(Continued).

3,178,069. LDR MEDICAL, S.A.S., 10430 ROSIERES PRES TROYES, FRANCE. SN 78-514,803. PUB. 10-11-2005, FILED 11-10-2004.

COVATOR

LAMINOTOME

THE MARK CONSISTS OF STANDARD CHARACTERS WITHOUT CLAIM TO ANY PARTICULAR FONT, STYLE, SIZE, OR COLOR.

FOR MEDICAL DEVICES FOR ELECTROSURGERY AND ELECTRON PLASMA ASSISTED SURGERY IN ORTHOPEDIC SURGICAL PROCEDURES; NAMELY, ELECTROSURGICAL PROBES, CATHETERS, ELECTRODES, AND POWER SUPPLIES FOR THE ELECTRODES (U.S. CLS. 26, 39 AND 44).

FIRST USE 9-29-2004; IN COMMERCE 9-29-2004.

THE MARK CONSISTS OF STANDARD CHARACTERS WITHOUT CLAIM TO ANY PARTICULAR FONT, STYLE, SIZE, OR COLOR.

FOR SURGICAL INSTRUMENTS USED IN LUMBAR LAMINECTOMY (U.S. CLS. 26, 39 AND 44).

FIRST USE 8-15-2005; IN COMMERCE 8-15-2005.

3,178,068. LDR MEDICAL USA, INC., AUSTIN, TX. SN 78-514,787. PUB. 12-20-2005, FILED 11-10-2004.

3,178,071. CHECKSITE MEDICAL, INC, EUREKA, MO. SN 78-517,134. PUB. 2-28-2006, FILED 11-15-2004.

ROI

CHECKSITE

THE MARK CONSISTS OF STANDARD CHARACTERS WITHOUT CLAIM TO ANY PARTICULAR FONT, STYLE, SIZE, OR COLOR.

FOR FUSION SPINAL IMPLANT SYSTEMS CONSISTING OF ARTIFICIAL MATERIALS, NAMELY CAGE DEVICES FOR USE IN SURGICAL LUMBAR IMPLANT PROCEDURES (U.S. CLS. 26, 39 AND 44).

FIRST USE 7-19-2005; IN COMMERCE 7-19-2005.

THE MARK CONSISTS OF STANDARD CHARACTERS WITHOUT CLAIM TO ANY PARTICULAR FONT, STYLE, SIZE, OR COLOR.

FOR ELECTRONIC SYSTEM CONSISTING OF A TAG, TAG DE-ACTIVATOR, AND TAG SENSOR FOR USE IN MONITORING THE MARKING OF PATIENTS FOR MEDICAL AND SURGICAL OPERATIONS (U.S. CLS. 26, 39 AND 44).

FIRST USE 8-9-2005; IN COMMERCE 8-9-2005.

CLASS 10—(Continued).

3,178,100. TYCO HEALTHCARE GROUP LP, NORWALK, CT. SN 78-532,090. PUB. 10-11-2005, FILED 12-14-2004.

CARDIOCURVE

THE MARK CONSISTS OF STANDARD CHARACTERS WITHOUT CLAIM TO ANY PARTICULAR FONT, STYLE, SIZE, OR COLOR.

FOR MEDICAL APPARATUS, NAMELY, WOUND CLOSURE DEVICES IN THE NATURE OF SUTURES AND SURGICAL NEEDLES (U.S. CLS. 26, 39 AND 44).

FIRST USE 8-0-2005; IN COMMERCE 8-0-2005.

3,178,114. SHERWOOD SERVICES AG, SCHAFFHAUSEN, SWITZERLAND. SN 78-537,576. PUB. 12-27-2005, FILED 12-23-2004.

MONOJECT SmarTip

THE MARK CONSISTS OF STANDARD CHARACTERS WITHOUT CLAIM TO ANY PARTICULAR FONT, STYLE, SIZE, OR COLOR.

OWNER OF U.S. REG. NOS. 1,403,008, 2,774,118, AND OTHERS.

FOR MEDICAL CANNULA FOR DRUG VIAL ACCESS (U.S. CLS. 26, 39 AND 44).

FIRST USE 4-12-2005; IN COMMERCE 4-12-2005.

3,178,151. GOLDIE, ROY L., JR., LITTLETON, CO. SN 78-553,819. PUB. 11-15-2005, FILED 1-25-2005.

*Auricu***LIGHT**

"4000 years of medicine...at the speed of light"

THE COLORS BLACK AND GOLD ARE CLAIMED AS A FEATURE OF THE MARK.

A STYLIZED WORD "AURICULIGHT" APPEARING IN BLACK COLORED LETTERING WITH A GOLD COLORED "SWOOSH" BEHIND THIS STYLIZED GRAPHIC. ALL REMAINING WORDING AND LETTERING IS BLACK IN COLOR.

CLASS 10—(Continued).

THE MARK CONSISTS OF A STYLIZED WORD "AURICULIGHT" APPEARING IN BLACK COLORED LETTERING WITH A GOLD COLORED "SWOOSH" BEHIND THIS STYLIZED GRAPHIC. ALL REMAINING WORDING AND LETTERING IS BLACK IN COLOR.

FOR MEDICAL APPARATUS FOR USE IN AURICULAR THERAPY (U.S. CLS. 26, 39 AND 44).

FIRST USE 1-25-2005; IN COMMERCE 1-25-2005.

3,178,158. MEGADYNE MEDICAL PRODUCTS, INC., DRAPER, UT. SN 78-557,060. PUB. 12-20-2005, FILED 1-31-2005.

MEGA SOFT

THE MARK CONSISTS OF STANDARD CHARACTERS WITHOUT CLAIM TO ANY PARTICULAR FONT, STYLE, SIZE, OR COLOR.

NO CLAIM IS MADE TO THE EXCLUSIVE RIGHT TO USE "SOFT", APART FROM THE MARK AS SHOWN.

FOR ELECTROSURGICAL RETURN ELECTRODES (U.S. CLS. 26, 39 AND 44).

FIRST USE 3-31-2006; IN COMMERCE 3-31-2006.

3,178,173. CONFLUENT SURGICAL, INC., WALTHAM, MA. SN 78-563,900. PUB. 2-28-2006, FILED 2-9-2005.

MICROMYST

THE MARK CONSISTS OF STANDARD CHARACTERS WITHOUT CLAIM TO ANY PARTICULAR FONT, STYLE, SIZE, OR COLOR.

FOR MEDICAL SEALANT DELIVERY SYSTEM, NAMELY, SYRINGE AND AIR PUMP USED BY PHYSICIANS TO ADMINISTER A DURAL SEALANT WHEN PERFORMING SURGERY ON CRANIAL OPENINGS (U.S. CLS. 26, 39 AND 44).

FIRST USE 8-10-2006; IN COMMERCE 8-10-2006.

CLASS 10—(Continued).

3,178,203. MEDTRONIC, INC., MINNEAPOLIS, MN. SN 78-569,678. PUB. 11-22-2005, FILED 2-17-2005.

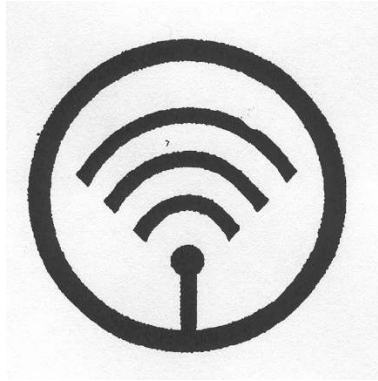

THE MARK CONSISTS OF AN ANTENNA UNDER THREE SEMI-CIRCLES BEING WITHIN A CIRCLE. FOR MEDICAL EQUIPMENT AND APPARATUS, NAMELY, COMPUTER INTERFACE SOFTWARE AND ELECTRONIC PROGRAMMING DEVICES THAT CONTAIN TELEMETRIC RECEIVERS TO COMMUNICATE WITH IMPLANTED CARDIAC DEVICES (U.S. CLS. 26, 39 AND 44).
FIRST USE 1-31-2005; IN COMMERCE 1-31-2005.

CLASS 10—(Continued).

3,178,281. ADVANCED MONITORS CORP., SAN DIEGO, CA. SN 78-586,961. PUB. 1-3-2006, FILED 3-14-2005.

TELE-VIEW WIRELESS OTOSCOPE

THE MARK CONSISTS OF STANDARD CHARACTERS WITHOUT CLAIM TO ANY PARTICULAR FONT, STYLE, SIZE, OR COLOR.
NO CLAIM IS MADE TO THE EXCLUSIVE RIGHT TO USE "WIRELESS OTOSCOPE", APART FROM THE MARK AS SHOWN.
FOR OTOSCOPES FOR VETERINARY AND HUMAN USE (U.S. CLS. 26, 39 AND 44).
FIRST USE 2-21-2005; IN COMMERCE 2-21-2005.

3,178,291. RAIN TREE ESSIX INC., WILMINGTON, DE. SN 78-588,849. PUB. 4-18-2006, FILED 3-16-2005.

3,178,262. ALLEGIANCE CORPORATION, MCGAW PARK, IL. SN 78-582,414. PUB. 5-9-2006, FILED 3-8-2005.



THE MARK CONSISTS OF A SINGLE BANDAGE SHOWN WITH ARMS AND LEGS. FOR FACE MASKS FOR MEDICAL USE (U.S. CLS. 26, 39 AND 44).
FIRST USE 9-1-2005; IN COMMERCE 9-1-2005.

F.I.T.

THE MARK CONSISTS OF STANDARD CHARACTERS WITHOUT CLAIM TO ANY PARTICULAR FONT, STYLE, SIZE, OR COLOR.
FOR HAND OPERATED PLIERS FOR ORTHODONTIC USE, THERMOPLASTIC ELEMENTS FORMED FOR MOUNTING TO ORTHODONTIC APPLIANCES TO PROVIDE PRECISE TOOTH MOVEMENT (U.S. CLS. 26, 39 AND 44).
FIRST USE 3-20-2006; IN COMMERCE 3-20-2006.

CLASS 10—(Continued).

3,178,292. ANSELL LIMITED, RICHMOND, AUSTRALIA. SN 78-589,080. PUB. 1-17-2006, FILED 3-17-2005.

CLASS 10—(Continued).

3,178,327. ORTHO DEVELOPMENT CORPORATION, DRAPER, UT. SN 78-594,843. PUB. 12-20-2005, FILED 3-24-2005.

VIBE 4U

SOLITUDE

THE MARK CONSISTS OF STANDARD CHARACTERS WITHOUT CLAIM TO ANY PARTICULAR FONT, STYLE, SIZE, OR COLOR.

PRIORITY CLAIMED UNDER SEC. 44(D) ON AUSTRALIA APPLICATION NO. 1023751, FILED 10-7-2004, REG. NO. 1023751, DATED 10-7-2004, EXPIRES 10-7-2014.

FOR CONTRACEPTIVES (U.S. CLS. 26, 39 AND 44).
FIRST USE 11-15-2005; IN COMMERCE 6-25-2006.

THE MARK CONSISTS OF STANDARD CHARACTERS WITHOUT CLAIM TO ANY PARTICULAR FONT, STYLE, SIZE, OR COLOR.

FOR ORTHOPEDIC JOINT IMPLANTS AND JOINT PROSTHESES (U.S. CLS. 26, 39 AND 44).

FIRST USE 2-23-2005; IN COMMERCE 2-23-2005.

3,178,293. ANSELL HEALTHCARE PRODUCTS LLC, RED BANK, NJ. SN 78-589,090. PUB. 1-17-2006, FILED 3-17-2005.

3,178,377. HILL-ROM SERVICES, INC., BATESVILLE, IN. SN 78-604,363. PUB. 1-10-2006, FILED 4-7-2005.

VIBRATIONS

TELEGLIDE

THE MARK CONSISTS OF STANDARD CHARACTERS WITHOUT CLAIM TO ANY PARTICULAR FONT, STYLE, SIZE, OR COLOR.

FOR CONTRACEPTIVES (U.S. CLS. 26, 39 AND 44).
FIRST USE 5-20-2005; IN COMMERCE 5-20-2005.

THE MARK CONSISTS OF STANDARD CHARACTERS WITHOUT CLAIM TO ANY PARTICULAR FONT, STYLE, SIZE, OR COLOR.

FOR FIXED, ARTICULATED AND TELESCOPING ARMS USED TO SUPPORT MEDICAL EQUIPMENT, AND SUPPLY MEDICAL GASES, ELECTRICITY AND COMMUNICATION HOOK UPS IN HEALTH CARE FACILITIES (U.S. CLS. 26, 39 AND 44).
FIRST USE 4-0-2006; IN COMMERCE 4-0-2006.

CLASS 10—(Continued).

3,178,402. EMERGENCY ID SYSTEMS, LLC, POWELL, OH. SN 78-616,893. PUB. 3-28-2006, FILED 4-26-2005.

VIC-PAK

THE MARK CONSISTS OF STANDARD CHARACTERS WITHOUT CLAIM TO ANY PARTICULAR FONT, STYLE, SIZE, OR COLOR.

FOR EMERGENCY IDENTIFICATION SYSTEM FOR ALLOWING ACCURATE FIELD IDENTIFICATION AND PROCESSING OF DISASTER VICTIMS DURING EMERGENCIES AND CATASTROPHIC EVENTS COMPRISED OF PLASTIC BAGS FOR TRANSMITTING MEDICAL SPECIMENS, BAR CODE SCANNERS, DISPOSABLE PLASTIC GLOVES, SWABS FOR DNA TESTING, NON-METAL IDENTIFICATION BANDS FOR PATIENTS, SURGICAL MASKS (U.S. CLS. 26, 39 AND 44).

FIRST USE 5-26-2005; IN COMMERCE 8-8-2006.

3,178,621. ZEAVISION, LLC, ST. LOUIS, MO. SN 78-714,717. PUB. 5-30-2006, FILED 9-16-2005.

QuantifEYE

THE MARK CONSISTS OF STANDARD CHARACTERS WITHOUT CLAIM TO ANY PARTICULAR FONT, STYLE, SIZE, OR COLOR.

FOR EYE TESTING MACHINES AND APPARATUS (U.S. CLS. 26, 39 AND 44).

FIRST USE 12-1-2005; IN COMMERCE 12-1-2005.

CLASS 11—ENVIRONMENTAL CONTROL APPARATUS

3,177,353. WATKINS MANUFACTURING CORPORATION, VISTA, CA. SN 76-352,184. PUB. 1-3-2006, FILED 12-21-2001.

IQ 2020

OWNER OF U.S. REG. NOS. 2,246,428, 2,246,429, AND 2,246,433.

FOR ELECTRONIC CONTROL SOLD AS A COMPONENT AND FEATURE OF SPAS IN THE NATURE OF HEATED WHIRLPOOLS (U.S. CLS. 13, 21, 23, 31 AND 34). FIRST USE 2-1-2001; IN COMMERCE 2-1-2001.

CLASS 11—(Continued).

3,177,485. FANIMATION, INC., ZIONSVILLE, IN. SN 76-611,553. PUB. 8-30-2005, FILED 9-10-2004.

THE VETRICCO

THE MARK CONSISTS OF STANDARD CHARACTERS WITHOUT CLAIM TO ANY PARTICULAR FONT, STYLE, SIZE, OR COLOR.

FOR ELECTRIC CEILING FANS FOR NON-INDUSTRIAL USE (U.S. CLS. 13, 21, 23, 31 AND 34).

FIRST USE 1-0-2005; IN COMMERCE 1-0-2005.

3,177,486. FANIMATION, INC., ZIONSVILLE, IN. SN 76-611,554. PUB. 8-30-2005, FILED 9-10-2004.

THE BELLERIA

THE MARK CONSISTS OF STANDARD CHARACTERS WITHOUT CLAIM TO ANY PARTICULAR FONT, STYLE, SIZE, OR COLOR.

FOR ELECTRIC CEILING FANS FOR NON-INDUSTRIAL USE (U.S. CLS. 13, 21, 23, 31 AND 34).

FIRST USE 1-0-2005; IN COMMERCE 1-0-2005.

3,177,487. FANIMATION, INC., ZIONSVILLE, IN. SN 76-611,555. PUB. 8-23-2005, FILED 9-10-2004.

THE VOLARE

THE MARK CONSISTS OF STANDARD CHARACTERS WITHOUT CLAIM TO ANY PARTICULAR FONT, STYLE, SIZE, OR COLOR.

THE ENGLISH TRANSLATION OF THE WORD VOLARE IN THE MARK IS TO FLY.

FOR ELECTRIC CEILING FANS FOR NON-INDUSTRIAL USE (U.S. CLS. 13, 21, 23, 31 AND 34).

FIRST USE 1-0-2005; IN COMMERCE 1-0-2005.

CLASS 11—(Continued).

3,177,510. MECO CORPORATION, GREENEVILLE, TN. SN 76-620,008. PUB. 6-13-2006, FILED 11-10-2004.

AUSSIE ADVENTURER

THE MARK CONSISTS OF STANDARD CHARACTERS WITHOUT CLAIM TO ANY PARTICULAR FONT, STYLE, SIZE, OR COLOR.

OWNER OF U.S. REG. NOS. 2,947,046 AND 2,947,086. FOR BARBECUE GRILLS (U.S. CLS. 13, 21, 23, 31 AND 34).

FIRST USE 1-7-2006; IN COMMERCE 1-7-2006.

CLASS 11—(Continued).

3,177,548. ROCKY MOUNTAIN SPAS, INC., FAIRFIELD, IA. SN 76-634,056. PUB. 12-20-2005, FILED 3-22-2005.

ROCKY MOUNTAIN SPAS

THE MARK CONSISTS OF STANDARD CHARACTERS WITHOUT CLAIM TO ANY PARTICULAR FONT, STYLE, SIZE, OR COLOR.

NO CLAIM IS MADE TO THE EXCLUSIVE RIGHT TO USE "SPAS", APART FROM THE MARK AS SHOWN. FOR SPAS IN THE NATURE OF HEATED POOLS AND HOT TUBS (U.S. CLS. 13, 21, 23, 31 AND 34).

FIRST USE 4-30-2005; IN COMMERCE 4-30-2005.

3,177,515. MINKA LIGHTING, INC., CORONA, CA. SN 76-622,151. PUB. 9-20-2005, FILED 11-24-2004.

BALBOA BEACH

THE MARK CONSISTS OF STANDARD CHARACTERS WITHOUT CLAIM TO ANY PARTICULAR FONT, STYLE, SIZE, OR COLOR.

FOR CEILING FANS (U.S. CLS. 13, 21, 23, 31 AND 34). FIRST USE 10-0-2004; IN COMMERCE 10-0-2004.

3,177,530. MECO CORPORATION, GREENEVILLE, TN. SN 76-625,689. PUB. 12-20-2005, FILED 12-21-2004.

PROPANE TAKE OFF

THE MARK CONSISTS OF STANDARD CHARACTERS WITHOUT CLAIM TO ANY PARTICULAR FONT, STYLE, SIZE, OR COLOR.

NO CLAIM IS MADE TO THE EXCLUSIVE RIGHT TO USE "PROPANE", APART FROM THE MARK AS SHOWN.

FOR PROPANE FUELED BARBECUE GRILLS, LANTERNS, LIGHTS, STOVES AND HEATERS (U.S. CLS. 13, 21, 23, 31 AND 34).

FIRST USE 2-18-2006; IN COMMERCE 2-18-2006.

3,177,593. PAPP, NICHOLAS GEORGE, JASPER, GA. SN 78-002,442. PUB. 3-19-2002, FILED 4-4-2000.

AQUA SOLUTIONS

NO CLAIM IS MADE TO THE EXCLUSIVE RIGHT TO USE "AQUA", APART FROM THE MARK AS SHOWN.

FOR WATER PURIFICATION UNITS AND COMPONENTS THEREOF FOR USE IN LABORATORY AND COMMERCIAL APPLICATIONS (U.S. CLS. 13, 21, 23, 31 AND 34).

FIRST USE 2-10-2000; IN COMMERCE 5-1-2000.

3,177,746. WILTON INDUSTRIES, INC., WOODRIDGE, IL. SN 78-364,169. PUB. 12-21-2004, FILED 2-6-2004.

**THE INCREDIBLE ICE
CREAM MACHINE**

THE MARK CONSISTS OF STANDARD CHARACTERS WITHOUT CLAIM TO ANY PARTICULAR FONT, STYLE, SIZE, OR COLOR.

NO CLAIM IS MADE TO THE EXCLUSIVE RIGHT TO USE ICE CREAM MACHINE, APART FROM THE MARK AS SHOWN.

FOR ICE CREAM MAKER (U.S. CLS. 13, 21, 23, 31 AND 34).

FIRST USE 10-1-2004; IN COMMERCE 10-1-2004.

CLASS 11—(Continued).

3,177,769. FLEXIBLE SOLUTIONS INTERNATIONAL INC., VICTORIA, BC, CANADA. SN 78-377,999. PUB. 6-7-2005, FILED 3-3-2004.

Ecosavr

THE MARK CONSISTS OF STANDARD CHARACTERS WITHOUT CLAIM TO ANY PARTICULAR FONT, STYLE, SIZE, OR COLOR.

FOR PLASTIC DISPENSING UNIT THAT DISTRIBUTE A CHEMICAL SOLUTION THAT REDUCES EVAPORATION AND HEAT LOSS BY FORMING A MONOMOLECULAR LAYER OVER THE SURFACE AREA OF A SWIMMING POOL (U.S. CLS. 13, 21, 23, 31 AND 34).

FIRST USE 3-1-2004; IN COMMERCE 3-1-2004.

3,177,951. DIGISETTE, LLC, NEW VERNON, NJ. SN 78-468,504. PUB. 12-13-2005, FILED 8-17-2004.

DIGILIGHT

THE MARK CONSISTS OF STANDARD CHARACTERS WITHOUT CLAIM TO ANY PARTICULAR FONT, STYLE, SIZE, OR COLOR.

FOR BATTERY-OPERATED MINIATURE AND POCKET-SIZED PORTABLE FLASHLIGHTS (U.S. CLS. 13, 21, 23, 31 AND 34).

FIRST USE 8-9-2005; IN COMMERCE 8-9-2005.

CLASS 11—(Continued).

3,177,964. BELL SPORTS, INC., IRVING, TX. SN 78-470,434. PUB. 12-13-2005, FILED 8-19-2004.

BLACKBURN

THE MARK CONSISTS OF STANDARD CHARACTERS WITHOUT CLAIM TO ANY PARTICULAR FONT, STYLE, SIZE, OR COLOR.

OWNER OF U.S. REG. NO. 1,859,627.

SEC. 2(F).

FOR LIGHTS USED FOR BICYCLES, NAMELY HEADLIGHTS, REAR FLASHERS AND TAIL LIGHTS (U.S. CLS. 13, 21, 23, 31 AND 34).

FIRST USE 7-0-2004; IN COMMERCE 8-0-2004.

3,178,039. HOMER TLC, INC., CLAYMONT, DE. SN 78-503,086. PUB. 1-31-2006, FILED 10-20-2004.

Ansley

THE MARK CONSISTS OF STANDARD CHARACTERS WITHOUT CLAIM TO ANY PARTICULAR FONT, STYLE, SIZE, OR COLOR.

FOR CEILING FANS AND ELECTRIC LIGHTING FIXTURES (U.S. CLS. 13, 21, 23, 31 AND 34).

FIRST USE 12-0-2004; IN COMMERCE 12-0-2004.

CLASS 11—(Continued).

3,178,050. FISKARS BRANDS, INC., MADISON, WI. SN 78-507,743. PUB. 5-2-2006, FILED 10-28-2004.

CLASS 11—(Continued).

3,178,067. SARTORIUS AG, GÖTTINGEN, FED REP GERMANY. SN 78-514,622. PUB. 12-27-2005, FILED 11-10-2004.

VIROSART

TRIODE

THE MARK CONSISTS OF STANDARD CHARACTERS WITHOUT CLAIM TO ANY PARTICULAR FONT, STYLE, SIZE, OR COLOR.

PRIORITY CLAIMED UNDER SEC. 44(D) ON FED REP GERMANY APPLICATION NO. 30443764.6, FILED 7-28-2004, REG. NO. 30443764, DATED 11-23-2004, EXPIRES 11-23-2014.

FOR FILTER MATERIALS, NAMELY, DEEP BED FILTERS AND FILTER MEMBRANES ALL FOR THE FILTRATION OF FLUIDS, IN PARTICULAR IN THE FIELD OF THE PHARMACEUTICAL INDUSTRY, FOOD INDUSTRY, DRINKS INDUSTRY AND CHEMICAL INDUSTRY AND IN THE FIELDS OF MEDICINE AND ENVIRONMENTAL PROTECTION; FILTERS AND FILTRATION APPARATUS IN THE NATURE OF FILTERS MADE OF FIBER FOR FILTRATION OF FLUIDS, NAMELY, WATER, IN THE FIELD OF THE PHARMACEUTICAL INDUSTRY, FOOD INDUSTRY, DRINKS INDUSTRY AND CHEMICAL INDUSTRY AND IN THE FIELDS OF MEDICINE AND ENVIRONMENTAL PROTECTION; FILTER MODULES, NAMELY, FILTER CAPSULES, FILTER CANDLES, FILTER CARTRIDGES, WOUND MODULES AND HOLLOW FIBER MODULES ALL FOR THE FILTRATION OF FLUIDS, IN PARTICULAR IN THE FIELD OF THE PHARMACEUTICAL INDUSTRY, FOOD INDUSTRY, DRINKS INDUSTRY AND CHEMICAL INDUSTRY AND IN THE FIELDS OF MEDICINE AND ENVIRONMENTAL PROTECTION (U.S. CLS. 13, 21, 23, 31 AND 34).

FIRST USE 3-1-2005; IN COMMERCE 3-1-2005.

THE MARK CONSISTS OF STANDARD CHARACTERS WITHOUT CLAIM TO ANY PARTICULAR FONT, STYLE, SIZE, OR COLOR.

FOR OUTDOOR PORTABLE LIGHTING PRODUCTS, NAMELY FLASHLIGHTS AND HEADLAMPS (U.S. CLS. 13, 21, 23, 31 AND 34).

FIRST USE 2-28-2005; IN COMMERCE 2-28-2005.

CLASS 11—(Continued).

3,178,077. LUCESCO LIGHTING, INC., PALO ALTO, CA. SN 78-520,481. PUB. 4-4-2006, FILED 11-19-2004.

CLASS 11—(Continued).

3,178,171. MASCO CORPORATION OF INDIANA, INDIANAPOLIS, IN. SN 78-563,323. PUB. 4-4-2006, FILED 2-9-2005.

HALLEY

THE MARK CONSISTS OF STANDARD CHARACTERS WITHOUT CLAIM TO ANY PARTICULAR FONT, STYLE, SIZE, OR COLOR.

FOR LIGHTING FIXTURES, LAMPS, DECORATIVE AND ARCHITECTURAL LIGHTING FIXTURES, AND ACCESSORIES THEREFOR, NAMELY LIGHT BULBS (U.S. CLS. 13, 21, 23, 31 AND 34).
FIRST USE 6-30-2005; IN COMMERCE 6-30-2005.

3,178,091. ALSONS CORPORATION, HILLSDALE, MI. SN 78-528,139. PUB. 3-7-2006, FILED 12-7-2004.

DELUGE

THE MARK CONSISTS OF STANDARD CHARACTERS WITHOUT CLAIM TO ANY PARTICULAR FONT, STYLE, SIZE, OR COLOR.

FOR PLUMBING PRODUCTS, NAMELY SHOWERHEADS (U.S. CLS. 13, 21, 23, 31 AND 34).
FIRST USE 1-23-2004; IN COMMERCE 1-23-2004.

GRAIL

THE MARK CONSISTS OF STANDARD CHARACTERS WITHOUT CLAIM TO ANY PARTICULAR FONT, STYLE, SIZE, OR COLOR.

FOR PLUMBING PRODUCTS, NAMELY FAUCETS (U.S. CLS. 13, 21, 23, 31 AND 34).
FIRST USE 5-1-2006; IN COMMERCE 5-1-2006.

3,178,183. TAYLOR BRANDS, LLC, KINGSPORT, TN. SN 78-565,811. PUB. 11-8-2005, FILED 2-11-2005.

OLD TIMER

THE MARK CONSISTS OF STANDARD CHARACTERS WITHOUT CLAIM TO ANY PARTICULAR FONT, STYLE, SIZE, OR COLOR.

FOR FLASHLIGHTS (U.S. CLS. 13, 21, 23, 31 AND 34).
FIRST USE 12-31-1958; IN COMMERCE 4-13-2006.

3,178,234. LASKO HOLDINGS, INC., WILMINGTON, DE. SN 78-576,519. PUB. 11-29-2005, FILED 2-28-2005.

AIR STIK

THE MARK CONSISTS OF STANDARD CHARACTERS WITHOUT CLAIM TO ANY PARTICULAR FONT, STYLE, SIZE, OR COLOR.

CLASS 11—(Continued).

NO CLAIM IS MADE TO THE EXCLUSIVE RIGHT TO USE "AIR", APART FROM THE MARK AS SHOWN.
FOR PORTABLE ELECTRIC FANS (U.S. CLS. 13, 21, 23, 31 AND 34).
FIRST USE 12-27-2005; IN COMMERCE 12-27-2005.

3,178,244. FLUIDART TECHNOLOGY, LLC, OKLAHOMA CITY, OK. SN 78-578,381. PUB. 11-29-2005, FILED 3-2-2005.

Fluidart

THE MARK CONSISTS OF STANDARD CHARACTERS WITHOUT CLAIM TO ANY PARTICULAR FONT, STYLE, SIZE, OR COLOR.
FOR WATER FILTERS FOR PONDS AND WATER FEATURES (U.S. CLS. 13, 21, 23, 31 AND 34).
FIRST USE 6-1-2003; IN COMMERCE 6-1-2003.

3,178,427. STREAMLIGHT, INC., EAGLEVILLE, PA. SN 78-626,617. PUB. 2-14-2006, FILED 5-10-2005.

FIREBOX

THE MARK CONSISTS OF STANDARD CHARACTERS WITHOUT CLAIM TO ANY PARTICULAR FONT, STYLE, SIZE, OR COLOR.
OWNER OF U.S. REG. NOS. 1,238,190 AND 2,907,820.
FOR FLASHLIGHTS AND PARTS THEREFOR (U.S. CLS. 13, 21, 23, 31 AND 34).
FIRST USE 8-3-2005; IN COMMERCE 8-3-2005.

CLASS 11—(Continued).

3,178,566. CONAIR CORPORATION, STAMFORD, CT. SN 78-681,358. PUB. 12-6-2005, FILED 7-29-2005.

CUISINART

THE MARK CONSISTS OF STANDARD CHARACTERS WITHOUT CLAIM TO ANY PARTICULAR FONT, STYLE, SIZE, OR COLOR.
OWNER OF U.S. REG. NOS. 1,048,883, 2,313,580, AND OTHERS.
FOR ELECTRIC PRESSURE COOKERS (U.S. CLS. 13, 21, 23, 31 AND 34).
FIRST USE 8-1-2006; IN COMMERCE 8-1-2006.

3,178,667. MARS, INCORPORATED, NEW YORK, NY. SN 78-977,583. PUB. 11-29-2005, FILED 3-17-2005.

FLAVIA FUSION

THE MARK CONSISTS OF STANDARD CHARACTERS WITHOUT CLAIM TO ANY PARTICULAR FONT, STYLE, SIZE, OR COLOR.
OWNER OF U.S. REG. NOS. 1,846,869 AND 2,168,427.
FOR ELECTRIC COFFEE, TEA, AND HOT CHOCOLATE MAKERS (U.S. CLS. 13, 21, 23, 31 AND 34).
FIRST USE 9-0-2005; IN COMMERCE 9-0-2005.

CLASS 12—VEHICLES

3,177,335. ULTRASHIELD, LLC, FORT MYERS, FL. SN 76-195,052. PUB. 2-7-2006, FILED 1-17-2001.

ULTRASHIELD

FOR VEHICLE BUG SHIELD AND HEADLAMP PROTECTION KITS COMPRISED OF SOLID VINYL OR PLASTIC PIECES (U.S. CLS. 19, 21, 23, 31, 35 AND 44).
FIRST USE 9-1-2000; IN COMMERCE 9-1-2000.

CLASS 12—(Continued).

3,177,401. INDEXICA LTD., TORONTO, ONTARIO, CANADA. SN 76-544,312. PUB. 9-27-2005, FILED 9-11-2003.

GENEVA

FOR INTERNAL COMBUSTION ENGINES FOR LAND VEHICLES (U.S. CLS. 19, 21, 23, 31, 35 AND 44).
FIRST USE 1-1-2006; IN COMMERCE 1-1-2006.

3,177,599. NORTON AMERICA, LLC, WESTON, MA. SN 78-112,809. PUB. 7-8-2003, FILED 3-5-2002.

ATLAS

FOR MOTORCYCLES (U.S. CLS. 19, 21, 23, 31, 35 AND 44).
FIRST USE 6-0-2006; IN COMMERCE 6-0-2006.

3,177,654. ALEXANDER DENNIS LIMITED, EDINBURGH, UNITED KINGDOM. SN 78-251,136. PUB. 5-31-2005, FILED 5-16-2003.

ENVIRO 500

FOR VEHICLES, NAMELY BUSES; APPARATUS FOR LOCOMOTION BY LAND, NAMELY, AUTOMOBILES; BUSES IN THE NATURE OF MOTORBUSES (U.S. CLS. 19, 21, 23, 31, 35 AND 44).
FIRST USE 1-28-2005; IN COMMERCE 1-28-2005.

3,177,659. LUND INTERNATIONAL, INC., ANOKA, MN. SN 78-256,093. PUB. 6-22-2004, FILED 5-30-2003.

AUTO VENTSHADE

OWNER OF U.S. REG. NOS. 569,872, 1,555,696, AND OTHERS.

NO CLAIM IS MADE TO THE EXCLUSIVE RIGHT TO USE "AUTO", APART FROM THE MARK AS SHOWN. SEC. 2(F) AS TO "VENTSHADE".

FOR LAND VEHICLE ACCESSORIES, NAMELY, SPOILERS, REAR WINDOW SUN DEFLECTORS, WIND DEFLECTORS, SUNROOF WIND DEFLECTORS, HOOD SHIELDS, STONE AND BUG DEFLECTORS AND SHIELDS, DOOR SILL PROTECTORS, RAIN DEFLECTORS FOR USE ON DOORS AND WINDOWS OF AUTOMOTIVE VEHICLES, WINDOW VENTS, NON-FUNCTIONAL AIR INTAKE EFFECTS, COVERS FOR REAR LIGHTS, LOUVERED WINDOW COVERS, SHADES AND VISORS FOR DOORS AND WINDOWS OF AUTOMOTIVE VEHICLES, HEADLIGHT COVERS AND ACCENT TRIM PIECES THEREFORE; FITTED LINERS FOR THE CARGO AREA OF VEHICLES; TAILLIGHT COVERS AND ACCENT TRIM PIECES THEREFORE (U.S. CLS. 19, 21, 23, 31, 35 AND 44).
FIRST USE 1-1-1940; IN COMMERCE 1-1-1940.

CLASS 12—(Continued).

3,177,682. HANGZHOU SUS AUTOMOBILE PARTS MANUFACTURE CO., LTD., ZHEJIANG, CHINA. SN 78-298,752. PUB. 6-15-2004, FILED 9-10-2003.

SUS

FOR VEHICLE PARTS, NAMELY, UNIVERSAL JOINTS (U.S. CLS. 19, 21, 23, 31, 35 AND 44).
FIRST USE 4-11-2006; IN COMMERCE 4-11-2006.

3,177,684. BOMBARDIER RECREATIONAL PRODUCTS INC., VALCOURT, QUEBEC, CANADA. SN 78-300,991. PUB. 11-9-2004, FILED 9-16-2003.

RENEGADE

FOR MARINE PROPELLERS; RECREATIONAL VEHICLES, NAMELY, SNOWMOBILES AND STRUCTURAL PARTS THEREFOR (U.S. CLS. 19, 21, 23, 31, 35 AND 44).
FIRST USE 3-3-1993; IN COMMERCE 3-3-1993.

3,177,805. WILLIAMS, DAN, C., MARATHON, FL. SN 78-401,148. PUB. 3-15-2005, FILED 4-13-2004.

PropMate

THE MARK CONSISTS OF STANDARD CHARACTERS WITHOUT CLAIM TO ANY PARTICULAR FONT, STYLE, SIZE, OR COLOR.

FOR PROTECTIVE CASE FOR BOAT PROPELLERS, THAT ALSO SERVES AS AN ANTI-THEFT DEVICE FOR THE PROPELLERS (U.S. CLS. 19, 21, 23, 31, 35 AND 44).
FIRST USE 5-8-2005; IN COMMERCE 1-3-2006.

CLASS 12—(Continued).

3,177,908. SNOWBEAR LIMITED, GUELPH, ONTARIO, CANADA. SN 78-451,824. PUB. 6-21-2005, FILED 7-16-2004.

CLASS 12—(Continued).

3,177,960. GLOBAL POLYMER INDUSTRIES, INC., AR-LINGTON, SD. SN 78-469,579. PUB. 12-20-2005, FILED 8-18-2004.

STRONGBOX

THE MARK CONSISTS OF STANDARD CHARACTERS WITHOUT CLAIM TO ANY PARTICULAR FONT, STYLE, SIZE, OR COLOR.

FOR TRAILERS, UTILITY TRAILERS (U.S. CLS. 19, 21, 23, 31, 35 AND 44).

FIRST USE 11-0-2005; IN COMMERCE 2-28-2006.

SLY DOG

THE MARK CONSISTS OF STANDARD CHARACTERS WITHOUT CLAIM TO ANY PARTICULAR FONT, STYLE, SIZE, OR COLOR.

FOR SNOWMOBILE ACCESSORIES, NAMELY, SNOWMOBILE COMPONENT PARTS CONSISTING OF SNOWMOBILE SKIS, BOGEY WHEELS AND WHEEL SPROCKETS (U.S. CLS. 19, 21, 23, 31, 35 AND 44).

FIRST USE 9-30-2004; IN COMMERCE 9-30-2004.

3,177,938. CHENG SHIN RUBBER USA, INC., SUWANEE, GA. SN 78-463,662. PUB. 6-28-2005, FILED 8-6-2004.

3,178,055. TOYOTA JIDOSHA KABUSHIKI KAISHA, TA TOYOTA MOTOR CORPORATION, TOYOTA-SHI, AI-CHI-KEN, JAPAN. SN 78-509,065. PUB. 5-9-2006, FILED 11-1-2004.

TREPADOR

THE MARK CONSISTS OF STANDARD CHARACTERS WITHOUT CLAIM TO ANY PARTICULAR FONT, STYLE, SIZE, OR COLOR.

FOR TIRES (U.S. CLS. 19, 21, 23, 31, 35 AND 44).

FIRST USE 5-0-2006; IN COMMERCE 5-0-2006.

FJ CRUISER

THE MARK CONSISTS OF STANDARD CHARACTERS WITHOUT CLAIM TO ANY PARTICULAR FONT, STYLE, SIZE, OR COLOR.

OWNER OF U.S. REG. NO. 2,630,716.

FOR MOTOR CARS AND SPORT UTILITY VEHICLES AND STRUCTURAL PARTS THEREOF (U.S. CLS. 19, 21, 23, 31, 35 AND 44).

FIRST USE 3-27-2006; IN COMMERCE 3-27-2006.

CLASS 12—(Continued).

3,178,107. NIRVE SPORTS, LTD., FOUNTAIN VALLEY, CA.
SN 78-534,882. PUB. 10-25-2005, FILED 12-17-2004.

CLASS 12—(Continued).

3,178,129. 1A AUTO, INC., PEPPERELL, MA. SN 78-546,123.
PUB. 5-9-2006, FILED 1-12-2005.

SKULLS

THE MARK CONSISTS OF STANDARD CHARACTERS WITHOUT CLAIM TO ANY PARTICULAR FONT, STYLE, SIZE, OR COLOR.

FOR BICYCLES AND BICYCLE STRUCTURAL PARTS (U.S. CLS. 19, 21, 23, 31, 35 AND 44).

FIRST USE 8-0-2004; IN COMMERCE 8-0-2004.

1A AUTO

THE MARK CONSISTS OF STANDARD CHARACTERS WITHOUT CLAIM TO ANY PARTICULAR FONT, STYLE, SIZE, OR COLOR.

NO CLAIM IS MADE TO THE EXCLUSIVE RIGHT TO USE "AUTO", APART FROM THE MARK AS SHOWN.

FOR AUTOMOBILE PARTS, NAMELY BODIES, BUMPERS, CHASSIS PARTS, DOOR HANDLES, HOODS, SEAT CUSHIONS, SUNROOFS, WINDSHIELD WIPERS, REARVIEW AND SIDE MIRRORS, FITTED COVERS, DASHBOARD COVERS, SEAT COVERS, CONVERTIBLE TOPS, GAS TANKS, PLASTIC PARTS, NAMELY AUTOMOTIVE INTERIOR AND EXTERIOR PLASTIC TRIM, SHOCK ABSORBERS, AND STRUCTURAL PARTS FOR AUTOMOBILES (U.S. CLS. 19, 21, 23, 31, 35 AND 44).

FIRST USE 1-20-1999; IN COMMERCE 1-20-1999.

3,178,109. VELOCITY MAGNETICS, INC., NEW CASTLE, PA.
SN 78-535,538. PUB. 11-15-2005, FILED 12-20-2004.

3,178,164. HYUNDAI MOTOR AMERICA, FOUNTAIN VALLEY, CA. SN 78-560,937. PUB. 11-1-2005, FILED 2-4-2005.

SLIDE-MATIC

THE MARK CONSISTS OF STANDARD CHARACTERS WITHOUT CLAIM TO ANY PARTICULAR FONT, STYLE, SIZE, OR COLOR.

FOR INCREMENTALLY ADJUSTABLE EDDY CURRENT AND ELECTRODYNAMIC BRAKES FOR LAND VEHICLES (U.S. CLS. 19, 21, 23, 31, 35 AND 44).

FIRST USE 5-6-2005; IN COMMERCE 5-6-2005.

DRIVE YOUR WAY

THE MARK CONSISTS OF STANDARD CHARACTERS WITHOUT CLAIM TO ANY PARTICULAR FONT, STYLE, SIZE, OR COLOR.

FOR MOTOR VEHICLES AND STRUCTURAL PARTS THEREFOR (U.S. CLS. 19, 21, 23, 31, 35 AND 44).

FIRST USE 2-11-2005; IN COMMERCE 2-11-2005.

CLASS 12—(Continued).

3,178,255. ASIAN VENTURES, INC., AUGUSTA, GA. SN 78-581,638. PUB. 11-29-2005, FILED 3-7-2005.

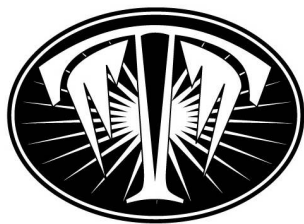

THE MARK CONSISTS OF A STYLIZED LETTER "T" WITH WINGS.

FOR VEHICLES, NAMELY, ALL-TERRAIN VEHICLES, UTILITY ALL-TERRAIN VEHICLES, GO-CARTS, MOTORCYCLES, TRICYCLES, BICYCLES, WAGONS, PULL-BEHIND WAGONS, PEDDLED CARS, FOOT-TO-FLOOR CARS, MOTORIZED GOLF CARTS, NON-MOTORIZED SCOOTERS, AND DUMP TRUCKS; CHILDREN'S STROLLERS AND CAR SEATS (U.S. CLS. 19, 21, 23, 31, 35 AND 44).

FIRST USE 3-30-2005; IN COMMERCE 6-0-2005.

3,178,407. MJB DISTRIBUTING COMPANY, LLC, VAN NUYS, CA. SN 78-619,222. PUB. 1-24-2006, FILED 4-28-2005.

Lucid
WHEELS

NO CLAIM IS MADE TO THE EXCLUSIVE RIGHT TO USE "WHEELS", APART FROM THE MARK AS SHOWN. FOR WHEELS AND TIRES FOR AUTOMOBILES (U.S. CLS. 19, 21, 23, 31, 35 AND 44).

FIRST USE 10-1-2005; IN COMMERCE 1-1-2006.

CLASS 12—(Continued).

3,178,414. DOUGLAS AUTOTECH CORPORATION, BRONSON, MI. SN 78-621,470. PUB. 1-24-2006, FILED 5-2-2005.

QUANTUM

THE MARK CONSISTS OF STANDARD CHARACTERS WITHOUT CLAIM TO ANY PARTICULAR FONT, STYLE, SIZE, OR COLOR.

FOR COCKPIT CONTROLS, NAMELY STEERING UNITS FOR LAND VEHICLES AND PARTS THEREOF (U.S. CLS. 19, 21, 23, 31, 35 AND 44).

FIRST USE 1-31-2006; IN COMMERCE 3-31-2006.

3,178,429. SRAM CORPORATION, CHICAGO, IL. SN 78-627,343. PUB. 2-21-2006, FILED 5-11-2005.

i-MOTION

THE MARK CONSISTS OF STANDARD CHARACTERS WITHOUT CLAIM TO ANY PARTICULAR FONT, STYLE, SIZE, OR COLOR.

FOR BICYCLES AND BICYCLE PARTS, NAMELY MULTI-SPEED HUBS AND GEAR SHIFTERS (U.S. CLS. 19, 21, 23, 31, 35 AND 44).

FIRST USE 2-15-2006; IN COMMERCE 2-15-2006.

3,178,629. STRETCHAIR PATIENT TRANSFER SYSTEMS, INC., LARGO, FL. SN 78-718,307. PUB. 5-23-2006, FILED 9-22-2005.

CROSSTOWN

THE MARK CONSISTS OF STANDARD CHARACTERS WITHOUT CLAIM TO ANY PARTICULAR FONT, STYLE, SIZE, OR COLOR.

FOR COMBINATION WHEELCHAIR CONVERTIBLE INTO A STRETCHER FOR USE IN PATIENT TRANSFER (U.S. CLS. 19, 21, 23, 31, 35 AND 44).

FIRST USE 12-15-2005; IN COMMERCE 12-15-2005.

CLASS 13—FIREARMS

CLASS 13—(Continued).

3,177,496. KIMBER IP, LLC, YONKERS, NY. SN 76-613,551.
PUB. 11-29-2005, FILED 9-24-2004.

VALIER

THE MARK CONSISTS OF STANDARD CHARACTERS WITHOUT CLAIM TO ANY PARTICULAR FONT, STYLE, SIZE, OR COLOR.

FOR FIREARMS, NAMELY, SHOTGUNS (U.S. CLS. 2 AND 9).

FIRST USE 10-5-2004; IN COMMERCE 10-5-2004.

CLASS 13—(Continued).

3,178,179. BLACKPOWDER PRODUCTS, INC., NORCROSS, GA. SN 78-564,863. PUB. 5-9-2006, FILED 2-10-2005.

Z-2 ALLOY

THE MARK CONSISTS OF STANDARD CHARACTERS WITHOUT CLAIM TO ANY PARTICULAR FONT, STYLE, SIZE, OR COLOR.

NO CLAIM IS MADE TO THE EXCLUSIVE RIGHT TO USE "ALLOY", APART FROM THE MARK AS SHOWN.

FOR SCOPE MOUNTING BASES AND SCOPE RINGS FOR MOUNTING TELESCOPIC SIGHTS TO FIREARMS (U.S. CLS. 2 AND 9).

FIRST USE 11-15-2004; IN COMMERCE 3-15-2005.

3,177,783. UNITED STATES FIRE ARMS MANUFACTURING COMPANY, INC., HARTFORD, CT. SN 78-387,911.
PUB. 3-8-2005, FILED 3-19-2004.

THE MAGIC RIFLE

THE MARK CONSISTS OF STANDARD CHARACTERS WITHOUT CLAIM TO ANY PARTICULAR FONT, STYLE, SIZE, OR COLOR.

NO CLAIM IS MADE TO THE EXCLUSIVE RIGHT TO USE "RIFLE", APART FROM THE MARK AS SHOWN.

FOR RIFLES (U.S. CLS. 2 AND 9).

FIRST USE 2-9-2006; IN COMMERCE 2-9-2006.

3,178,200. INGRAM ENTERPRISES, INC., SPRINGFIELD, MO. SN 78-569,333. PUB. 11-15-2005, FILED 2-17-2005.

G-FORCE ROCKETS

3,177,807. SALISH TRUST, ANACORTES, WA. SN 78-401,681.
PUB. 9-27-2005, FILED 4-14-2004.



THE COLOR(S) COLORS YELLOW AND BLACK IS/ARE CLAIMED AS A FEATURE OF THE MARK.

THE COLOR YELLOW APPEARS IN THE DESIGN PORTION OF THE MARK WITH BLACK STRIPES.

FOR FIREWORKS (U.S. CLS. 2 AND 9).

FIRST USE 3-5-2004; IN COMMERCE 3-5-2004.

THE MARK CONSISTS OF STANDARD CHARACTERS WITHOUT CLAIM TO ANY PARTICULAR FONT, STYLE, SIZE, OR COLOR.

NO CLAIM IS MADE TO THE EXCLUSIVE RIGHT TO USE "ROCKETS", APART FROM THE MARK AS SHOWN.

FOR FIREWORKS (U.S. CLS. 2 AND 9).

FIRST USE 5-5-2005; IN COMMERCE 5-5-2005.

CLASS 13—(Continued).

3,178,380. CZ-USA, KANSAS CITY, KS. SN 78-604,636. PUB. 1-17-2006, FILED 4-8-2005.

DAN WESSON

THE MARK CONSISTS OF STANDARD CHARACTERS WITHOUT CLAIM TO ANY PARTICULAR FONT, STYLE, SIZE, OR COLOR.

OWNER OF U.S. REG. NO. 1,105,099.
THE NAME DAN WESSON DOES NOT IDENTIFY A LIVING INDIVIDUAL.

FOR FIREARMS (U.S. CLS. 2 AND 9).
FIRST USE 6-13-1977; IN COMMERCE 6-13-1977.

3,178,490. SECURITY EQUIPMENT CORPORATION, FENTON, MO. SN 78-652,435. PUB. 4-11-2006, FILED 6-16-2005.

CELL BUSTER

THE MARK CONSISTS OF STANDARD CHARACTERS WITHOUT CLAIM TO ANY PARTICULAR FONT, STYLE, SIZE, OR COLOR.

FOR TEAR GAS WEAPONS AND PEPPER SPRAY WEAPONS, NAMELY, APPARATUS FOR DISPENSING NEUTRALIZING AND INCAPACITATING AGENTS, FOR RIOT CONTROL, LAW ENFORCEMENT AND CORRECTIONAL FACILITIES (U.S. CLS. 2 AND 9).
FIRST USE 8-17-2005; IN COMMERCE 8-17-2005.

3,178,643. HALLIBURTON ENERGY SERVICES, INC., CARROLLTON, TX. SN 78-729,672. PUB. 6-13-2006, FILED 10-10-2005.

KLEENZONE

THE MARK CONSISTS OF STANDARD CHARACTERS WITHOUT CLAIM TO ANY PARTICULAR FONT, STYLE, SIZE, OR COLOR.

FOR DETONATORS AND SHAPED EXPLOSIVE CHARGES FOR PERFORATING OIL AND GAS WELLS (U.S. CLS. 2 AND 9).
FIRST USE 12-5-2005; IN COMMERCE 12-5-2005.

CLASS 14—JEWELRY

3,177,339. SCHURHAMMER MANUFACTURING, INC., WABASHA, MN. SN 76-255,418. PUB. 6-14-2005, FILED 5-11-2001.

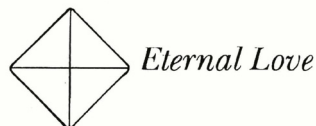

FOR DIAMONDS (U.S. CLS. 2, 27, 28 AND 50).
FIRST USE 7-1-2001; IN COMMERCE 7-1-2001.

3,177,419. SAMANTHA DESIGNS, LTD., NEW YORK, NY. SN 76-570,207. PUB. 8-2-2005, FILED 1-16-2004.

SAMANTHA DESIGNS

THE MARK CONSISTS OF STANDARD CHARACTERS WITHOUT CLAIM TO ANY PARTICULAR FONT, STYLE, SIZE, OR COLOR.

NO CLAIM IS MADE TO THE EXCLUSIVE RIGHT TO USE DESIGNS, APART FROM THE MARK AS SHOWN.
SAMANTHA DOES NOT IDENTIFY A PARTICULAR LIVING INDIVIDUAL.

FOR JEWELRY (U.S. CLS. 2, 27, 28 AND 50).
FIRST USE 12-0-2002; IN COMMERCE 1-0-2003.

3,177,562. SPENCER DIAMONDS CO., LTD., HUNGHOM, KOWLOON, HONG KONG. SN 76-638,035. PUB. 1-31-2006, FILED 4-29-2005.

SPD

THE MARK CONSISTS OF STANDARD CHARACTERS WITHOUT CLAIM TO ANY PARTICULAR FONT, STYLE, SIZE, OR COLOR.

FOR JEWELRY (U.S. CLS. 2, 27, 28 AND 50).
FIRST USE 7-1-2005; IN COMMERCE 7-1-2005.

CLASS 14—(Continued).

3,177,565. BEIT T'SHUVAH, HCKENSACK, NJ. SN 76-638,184.
PUB. 1-31-2006, FILED 5-9-2005.

SPHEROT

THE MARK CONSISTS OF STANDARD CHARACTERS
WITHOUT CLAIM TO ANY PARTICULAR FONT, STYLE,
SIZE, OR COLOR.

FOR JEWELRY, NAMELY NECKLACES (U.S. CLS. 2,
27, 28 AND 50).
FIRST USE 10-15-2005; IN COMMERCE 10-15-2005.

3,177,566. STULLER, INC., LAFAYETTE, LA. SN 76-638,949.
PUB. 1-31-2006, FILED 5-19-2005.

SEA SPRITE

THE MARK CONSISTS OF STANDARD CHARACTERS
WITHOUT CLAIM TO ANY PARTICULAR FONT, STYLE,
SIZE, OR COLOR.

FOR JEWELRY NAMELY EARRINGS, NECKLACES
AND PENDANTS (U.S. CLS. 2, 27, 28 AND 50).
FIRST USE 11-0-2005; IN COMMERCE 11-0-2005.

3,177,615. QT, INC., ELK GROVE VILLAGE, IL. SN 78-
157,646. PUB. 6-17-2003, FILED 8-26-2002.

POLARIZATION

FOR JEWELRY, NAMELY, BRACELETS (U.S. CLS. 2,
27, 28 AND 50).
FIRST USE 1-1-2004; IN COMMERCE 1-1-2004.

3,177,625. LEATHERMAN TOOL GROUP, INC., PORTLAND,
OR. SN 78-179,515. PUB. 6-3-2003, FILED 10-29-2002.

LEATHERMAN

OWNER OF U.S. REG. NOS. 1,325,473, 2,474,800, AND
2,596,689.
FOR WATCHES (U.S. CLS. 2, 27, 28 AND 50).
FIRST USE 8-12-2006; IN COMMERCE 8-12-2006.

CLASS 14—(Continued).

3,177,645. ER MARKS, INC., WEST CHESTER, PA. SN 78-
232,845. PUB. 11-18-2003, FILED 4-2-2003.

QVC

FOR JEWELRY (U.S. CLS. 2, 27, 28 AND 50).
FIRST USE 12-31-2003; IN COMMERCE 12-31-2003.

3,177,648. FOCUS ON THE FAMILY, COLORADO SPRINGS,
CO. SN 78-242,388. PUB. 9-28-2004, FILED 4-25-2003.

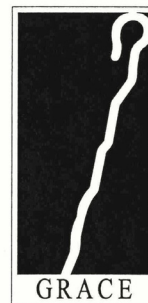

FOR LAPEL PINS FOR USE BY PASTORS AND NOT
AS FASHION OR FINE JEWELRY (U.S. CLS. 2, 27, 28
AND 50).
FIRST USE 2-10-2003; IN COMMERCE 2-10-2003.

3,177,672. DISNEY ENTERPRISES, INC., BURBANK, CA. SN
78-287,531. PUB. 5-25-2004, FILED 8-14-2003.

KIM POSSIBLE

OWNER OF U.S. REG. NO. 2,652,590.
FOR JEWELRY AND WATCHES (U.S. CLS. 2, 27, 28
AND 50).
FIRST USE 11-0-2002; IN COMMERCE 11-0-2002.

CLASS 14—(Continued).

3,177,918. ANDIN INTERNATIONAL INC., NEW YORK, NY.
SN 78-456,472. PUB. 6-21-2005, FILED 7-26-2004.

NOT ALL GEMS ARE CREATED EQUAL

THE MARK CONSISTS OF STANDARD CHARACTERS WITHOUT CLAIM TO ANY PARTICULAR FONT, STYLE, SIZE, OR COLOR.

FOR JEWELRY; PRECIOUS AND SEMI-PRECIOUS GEMSTONES; AND WATCHES (U.S. CLS. 2, 27, 28 AND 50).

FIRST USE 3-1-2004; IN COMMERCE 3-1-2004.

3,178,305. GALICKI & RISSIN, LLC, FORT LEE, NJ. SN 78-591,462. PUB. 12-20-2005, FILED 3-21-2005.

TEXAS STUD BACK

THE MARK CONSISTS OF STANDARD CHARACTERS WITHOUT CLAIM TO ANY PARTICULAR FONT, STYLE, SIZE, OR COLOR.

NO CLAIM IS MADE TO THE EXCLUSIVE RIGHT TO USE STUD BACK, APART FROM THE MARK AS SHOWN.

FOR SAFETY BACKS FOR EARRINGS AND PINS BEING JEWELRY (U.S. CLS. 2, 27, 28 AND 50).

FIRST USE 7-0-2005; IN COMMERCE 7-0-2005.

3,178,326. LOVE & PRIDE, LLC, PHILADELPHIA, PA. SN 78-594,716. PUB. 12-27-2005, FILED 3-24-2005.



THE MARK CONSISTS OF A STYLIZED IMAGE OF A HEART SLIGHTLY TILTED TO THE LEFT AND INCOMPLETE ON THE LOWER RIGHT SIDE WHERE THERE IS A STYLIZED PLUS SIGN.

FOR JEWELRY (U.S. CLS. 2, 27, 28 AND 50).
FIRST USE 1-26-2005; IN COMMERCE 3-13-2005.

CLASS 14—(Continued).

3,178,558. AZOTIC COATING TECHNOLOGY, INC., ROCHESTER, MN. SN 78-677,899. PUB. 4-25-2006, FILED 7-25-2005.

DIAMOND CLAD MYSTIC

THE MARK CONSISTS OF STANDARD CHARACTERS WITHOUT CLAIM TO ANY PARTICULAR FONT, STYLE, SIZE, OR COLOR.

NO CLAIM IS MADE TO THE EXCLUSIVE RIGHT TO USE DIAMOND CLAD, APART FROM THE MARK AS SHOWN.

FOR GEMSTONES AND JEWELRY (U.S. CLS. 2, 27, 28 AND 50).

FIRST USE 4-0-2005; IN COMMERCE 4-0-2005.

3,178,598. PEREZ, LEO J., SAN CLEMENTE, CA. SN 78-704,937. PUB. 5-16-2006, FILED 9-1-2005.

SS8

THE MARK CONSISTS OF STANDARD CHARACTERS WITHOUT CLAIM TO ANY PARTICULAR FONT, STYLE, SIZE, OR COLOR.

FOR CHRONOGRAPHS FOR USE AS WATCHES, PARTS FOR WATCHES, POCKET WATCHES, STOP WATCHES, WATCHES, WATCHES CONTAINING ELECTRONIC GAME FUNCTION, WRIST WATCHES (U.S. CLS. 2, 27, 28 AND 50).

FIRST USE 2-1-2001; IN COMMERCE 3-15-2003.

CLASS 15—MUSICAL INSTRUMENTS

3,178,139. MOOG MUSIC, INC., ASHEVILLE, NC. SN 78-550,014. PUB. 1-31-2006, FILED 1-19-2005.

ELECTRIC BLUE

THE MARK CONSISTS OF STANDARD CHARACTERS WITHOUT CLAIM TO ANY PARTICULAR FONT, STYLE, SIZE, OR COLOR.

NO CLAIM IS MADE TO THE EXCLUSIVE RIGHT TO USE ELECTRIC, APART FROM THE MARK AS SHOWN.

FOR MUSIC SYNTHESIZERS (U.S. CLS. 2, 21 AND 36).
FIRST USE 2-4-2005; IN COMMERCE 2-4-2005.

CLASS 16—PAPER GOODS AND PRINTED MATTER

3,177,360. BRESLIN, DANIEL V., PHILADELPHIA, PA. SN 76-393,771. PUB. 6-17-2003, FILED 4-11-2002.

LOTTOPEN

FOR WRITING INSTRUMENTS (U.S. CLS. 2, 5, 22, 23, 29, 37, 38 AND 50).
FIRST USE 8-26-2006; IN COMMERCE 8-26-2006.

3,177,375. MIELE, ROBERT C., DENVER, NJ. SN 76-475,110. PUB. 7-1-2003, FILED 12-13-2002.

SOFT THOUGHTS

FOR PILLOW SHAPED PAPER OR CARDBOARD BOX CONTAINING PRINTED CARDS OF QUOTATIONS, MAXIMS, AND OR POETRY PACKAGED AS A UNIT (U.S. CLS. 2, 5, 22, 23, 29, 37, 38 AND 50).
FIRST USE 9-13-2006; IN COMMERCE 9-13-2006.

3,177,393. THE NUANCING GROUP, LLC, SAN DIEGO, CA. SN 76-533,505. PUB. 5-31-2005, FILED 7-18-2003.

DUH! MARKETING

NO CLAIM IS MADE TO THE EXCLUSIVE RIGHT TO USE MARKETING, APART FROM THE MARK AS SHOWN.
FOR BOOKS AND NEWSLETTERS IN THE FIELD OF BRAND NAMING AND RECOGNITION (U.S. CLS. 2, 5, 22, 23, 29, 37, 38 AND 50).
FIRST USE 2-1-2001; IN COMMERCE 2-1-2001.

3,177,433. ALM PROPERTIES, INC., NEW YORK, NY. SN 76-581,551. PUB. 9-13-2005, FILED 3-15-2004.

EXECUTIVE LEGAL ADVISER

THE MARK CONSISTS OF STANDARD CHARACTERS WITHOUT CLAIM TO ANY PARTICULAR FONT, STYLE, SIZE, OR COLOR.
NO CLAIM IS MADE TO THE EXCLUSIVE RIGHT TO USE "LEGAL ADVISOR", APART FROM THE MARK AS SHOWN.
FOR LEGAL NEWSLETTERS, MAGAZINES, AND NEWSPAPERS (U.S. CLS. 2, 5, 22, 23, 29, 37, 38 AND 50).
FIRST USE 4-0-2004; IN COMMERCE 4-0-2004.

CLASS 16—(Continued).

3,177,500. THE FAMILY INSTITUTE, EVANSTON, IL. SN 76-615,227. PUB. 1-31-2006, FILED 10-12-2004.

STIC

THE MARK CONSISTS OF STANDARD CHARACTERS WITHOUT CLAIM TO ANY PARTICULAR FONT, STYLE, SIZE, OR COLOR.

FOR PSYCHOLOGICAL TESTING MATERIALS, NAMELY, PRINTED INSTRUCTION SHEETS AND QUESTIONNAIRES, BOOKLETS AND MANUALS IN THE FIELD OF PSYCHOLOGY; PRINTED PSYCHOLOGICAL TESTING MATERIALS, NAMELY, PRINTED SCORING, INTERPRETATION AND EVALUATION SHEETS AND MANUALS FOR TESTS (U.S. CLS. 2, 5, 22, 23, 29, 37, 38 AND 50).
FIRST USE 5-0-2004; IN COMMERCE 4-0-2006.

3,177,509. DIAMOND, AUDREY, WEST PALM BEACH, FL. SN 76-619,414. PUB. 10-4-2005, FILED 11-3-2004.

ART OF THE TIMES

THE MARK IS IN TIMES ROMAN TYPEFACE.
FOR MAGAZINE IN THE FIELD OF ART (U.S. CLS. 2, 5, 22, 23, 29, 37, 38 AND 50).
FIRST USE 8-0-2004; IN COMMERCE 10-0-2004.

3,177,534. LIFESAFE LLC, INDIANAPOLIS, IN. SN 76-627,378. PUB. 10-25-2005, FILED 1-10-2005.

LIFESAFE

THE MARK CONSISTS OF STANDARD CHARACTERS WITHOUT CLAIM TO ANY PARTICULAR FONT, STYLE, SIZE, OR COLOR.
FOR KITS FOR USE IN COMPILING INVENTORIES OF PERSONAL POSSESSIONS AND INFORMATION CONSISTING PRIMARILY OF THE FOLLOWING, NAMELY NOTE BOOKS, FOLDERS, DOCUMENT CONTAINERS, PAPER, STICKERS, AND OPTICAL DATA CARRIERS, ALL SOLD AS A UNIT (U.S. CLS. 2, 5, 22, 23, 29, 37, 38 AND 50).
FIRST USE 11-30-2005; IN COMMERCE 11-30-2005.

CLASS 16—(Continued).

3,177,536. CREATIVE ASSOCIATES INTERNATIONAL, INC., WASHINGTON, DC. SN 76-629,237. PUB. 10-25-2005, FILED 1-28-2005.

CREATIVE U

THE MARK CONSISTS OF STANDARD CHARACTERS WITHOUT CLAIM TO ANY PARTICULAR FONT, STYLE, SIZE, OR COLOR.

FOR PRINTED EDUCATION MATERIALS, BOOKS, BOOKLETS, BINDERS, MANUALS, REPORTS, BROCHURES, PAMPHLETS, AND NEWSLETTERS, ALL ON THE SUBJECT OF PROMOTING AND BUILDING DEMOCRACY AND IMPROVED EDUCATION SERVICES IN THE DEVELOPING WORLD (U.S. CLS. 2, 5, 22, 23, 29, 37, 38 AND 50).

FIRST USE 5-24-2006; IN COMMERCE 5-24-2006.

3,177,571. DANNY, JENNIFER A., STEVENSON RANCH, CA. SN 76-640,976. PUB. 4-11-2006, FILED 6-16-2005.

ERACISM

THE MARK CONSISTS OF STANDARD CHARACTERS WITHOUT CLAIM TO ANY PARTICULAR FONT, STYLE, SIZE, OR COLOR.

FOR OFFICE REQUISITES, NAMELY, ERASERS AND PENCILS (U.S. CLS. 2, 5, 22, 23, 29, 37, 38 AND 50).

FIRST USE 8-23-2006; IN COMMERCE 8-23-2006.

3,177,575. UP WITH PAPER, LLC, MASON, OH. SN 76-643,001. PUB. 4-11-2006, FILED 7-18-2005.

TRÉS PETITES

THE MARK CONSISTS OF STANDARD CHARACTERS WITHOUT CLAIM TO ANY PARTICULAR FONT, STYLE, SIZE, OR COLOR.

THE ENGLISH TRANSLATION OF THE WORD "TRÉS" IN THE MARK IS "VERY".

FOR GIFT CARDS (U.S. CLS. 2, 5, 22, 23, 29, 37, 38 AND 50).

FIRST USE 1-31-2006; IN COMMERCE 1-31-2006.

CLASS 16—(Continued).

3,177,577. WIZARDS OF THE COAST, INC., PAWTUCKET, RI. SN 76-644,310. PUB. 4-25-2006, FILED 8-5-2005.

TIME SPIES

THE MARK CONSISTS OF STANDARD CHARACTERS WITHOUT CLAIM TO ANY PARTICULAR FONT, STYLE, SIZE, OR COLOR.

FOR PUBLICATIONS, NAMELY CHILDREN'S NOVELS AND NEWSLETTERS (U.S. CLS. 2, 5, 22, 23, 29, 37, 38 AND 50).

FIRST USE 9-6-2006; IN COMMERCE 9-6-2006.

3,177,596. WASHINGTON MUTUAL, INC., SEATTLE, WA. SN 78-094,733. PUB. 12-17-2002, FILED 11-21-2001.

COINHEAD

FOR PRINTED MATTER, NAMELY, FLYERS, BROCHURES AND PROGRAM GUIDES ABOUT FINANCIAL AND BANKING INFORMATION AND SAVINGS ACCOUNTS; ERASERS; NOTEPADS; NOTEBOOKS; PENCILS (U.S. CLS. 2, 5, 22, 23, 29, 37, 38 AND 50).

FIRST USE 4-30-1998; IN COMMERCE 4-30-1998.

3,177,640. LUCZYK, PAUL A., MUKILTEO, WA. SN 78-223,259. PUB. 6-7-2005, FILED 3-8-2003.

I AM PRO CHOICE, I DRIVE A SUV

FOR BUMPER STICKERS, POSTERS; DECALS AND PAPER BANNERS (U.S. CLS. 2, 5, 22, 23, 29, 37, 38 AND 50).

FIRST USE 3-3-2006; IN COMMERCE 3-3-2006.

3,177,667. MULTNOMAH PUBLISHERS, INC., SISTERS, OR. SN 78-280,163. PUB. 4-6-2004, FILED 7-29-2003.

THE DREAM GIVER

FOR STATIONERY; POSTERS; PAPER NOTE PADS; DIARIES; WRITING JOURNALS; DEVOTIONALS; BOOKMARKS; BOOK COVERS, NAMELY CLOTH BIBLE COVERS; ART PRINTS; AND CALENDARS (U.S. CLS. 2, 5, 22, 23, 29, 37, 38 AND 50).

FIRST USE 1-13-2006; IN COMMERCE 1-13-2006.

CLASS 16—(Continued).

3,177,701. PFIZER INC., NEW YORK, NY. SN 78-320,648.
PUB. 8-3-2004, FILED 10-30-2003.

ON YOUR WAY

FOR PRINTED INSTRUCTIONAL MATERIALS REGARDING DEPRESSION AND/OR ANXIETY AND THE TREATMENT THEREOF (U.S. CLS. 2, 5, 22, 23, 29, 37, 38 AND 50).

FIRST USE 5-31-2004; IN COMMERCE 5-31-2004.

CLASS 16—(Continued).

3,177,787. JAMES P. LITCHKO, KENSINGTON, MD. SN 78-389,242. PUB. 2-21-2006, FILED 3-23-2004.

Know Books Series

THE MARK CONSISTS OF STANDARD CHARACTERS WITHOUT CLAIM TO ANY PARTICULAR FONT, STYLE, SIZE, OR COLOR.

NO CLAIM IS MADE TO THE EXCLUSIVE RIGHT TO USE "BOOKS SERIES", APART FROM THE MARK AS SHOWN.

FOR SERIES OF FICTION AND NON-FICTION BOOKS ON A VARIETY OF TOPICS (U.S. CLS. 2, 5, 22, 23, 29, 37, 38 AND 50).

FIRST USE 10-1-2004; IN COMMERCE 10-1-2004.

3,177,730. ANGEL STREET ENTERPRISES, INC., RICHMOND, IL. SN 78-348,981. PUB. 11-9-2004, FILED 1-7-2004.

SAND EXPRESSIONS

THE MARK CONSISTS OF STANDARD CHARACTERS WITHOUT CLAIM TO ANY PARTICULAR FONT, STYLE, SIZE, OR COLOR.

NO CLAIM IS MADE TO THE EXCLUSIVE RIGHT TO USE "SAND", APART FROM THE MARK AS SHOWN.

FOR SAND PAINTING ART BOARD AND KITS FOR CHILDREN AND ARTISTS AND SAND PAINTING CARDBOARD COATED ON ONE SIDE WITH PRESURE SENSITIVE ADHESIVE PROTECTED INITIALLY BY PEELABLE SHEET MATERIAL (U.S. CLS. 2, 5, 22, 23, 29, 37, 38 AND 50).

FIRST USE 9-1-2001; IN COMMERCE 9-1-2001.

3,177,841. THE PROCTER & GAMBLE COMPANY, CINCINNATI, OH. SN 78-424,570. PUB. 5-30-2006, FILED 5-25-2004.



3,177,766. ABROMOVITZ, JAIME, PHOENIX, AZ. SN 78-374,750. PUB. 11-2-2004, FILED 2-26-2004.

DOODLEY-DOO

THE MARK CONSISTS OF STANDARD CHARACTERS WITHOUT CLAIM TO ANY PARTICULAR FONT, STYLE, SIZE, OR COLOR.

FOR SERIES OF BOOKS FOR CHILDREN; CHILDREN'S ACTIVITY BOOKS; CHILDREN'S BOOKS; CHILDREN'S STORYBOOKS (U.S. CLS. 2, 5, 22, 23, 29, 37, 38 AND 50).

FIRST USE 4-19-2005; IN COMMERCE 4-19-2005.

OWNER OF U.S. REG. NOS. 793,371, 2,533,080, AND OTHERS.

THE MARK CONSISTS OF THE STYLIZED WORD BOUNTY SUPERIMPOSED ON AN ABSTRACT CORNUCOPIA AND LOCATED AT THE TOP OF A HEXAGONAL SHIELD DESIGN IN THE BACKGROUND WITH THE STYLIZED WORD BASIC, OUTLINED, SHADOWED, AND SUPERIMPOSED ACROSS THE HEXAGONAL DESIGN, AND A SMALLER HEXAGONAL SHAPE SHOWING A TEXTURED DESIGN AT THE BOTTOM OF THE LARGER HEXAGONAL SHAPE.

FOR PAPER TOWELS (U.S. CLS. 2, 5, 22, 23, 29, 37, 38 AND 50).

FIRST USE 4-11-2005; IN COMMERCE 4-11-2005.

CLASS 16—(Continued).

3,177,857. CAMPBELL, J. SCOTT, GOLDEN, CO. SN 78-434,247. PUB. 12-20-2005, FILED 6-11-2004.

CLASS 16—(Continued).

3,177,921. SMART DESTINATIONS, INC., BOSTON, MA. SN 78-457,542. PUB. 1-24-2006, FILED 7-27-2004.

WILDSIDERZ

THE MARK CONSISTS OF STANDARD CHARACTERS WITHOUT CLAIM TO ANY PARTICULAR FONT, STYLE, SIZE, OR COLOR.

FOR PRINTED MATTER, NAMELY, POSTERS, COMIC BOOKS, TRADING CARDS, AND MAGAZINE, BOOKLET, AND BOOK SECTIONS CONTAINING COMIC STORIES IN ILLUSTRATED FORM (U.S. CLS. 2, 5, 22, 23, 29, 37, 38 AND 50).

FIRST USE 8-0-2005; IN COMMERCE 8-0-2005.

Go San Francisco

THE MARK CONSISTS OF STANDARD CHARACTERS WITHOUT CLAIM TO ANY PARTICULAR FONT, STYLE, SIZE, OR COLOR.

NO CLAIM IS MADE TO THE EXCLUSIVE RIGHT TO USE "SAN FRANCISCO", APART FROM THE MARK AS SHOWN.

FOR CARDS, WHICH ARE NOT MAGNETICALLY CODED, FOR USE IN BUSINESS TRANSACTIONS, NAMELY, ENABLING ADMISSION TO ATTRACTIONS AND OFFERING SAVINGS ON SHOPPING, DINING AND TRAVEL (U.S. CLS. 2, 5, 22, 23, 29, 37, 38 AND 50).

FIRST USE 3-15-2005; IN COMMERCE 4-4-2005.

3,177,869. PEARSON EDUCATION, INC., UPPER SADDLE RIVER, NJ. SN 78-438,285. PUB. 10-25-2005, FILED 6-21-2004.

3,177,922. WELLNESS, INC., BROOKLINE, MA. SN 78-458,313. PUB. 6-28-2005, FILED 7-28-2004.

PORTFOLIO EDITIONS

THE MARK CONSISTS OF STANDARD CHARACTERS WITHOUT CLAIM TO ANY PARTICULAR FONT, STYLE, SIZE, OR COLOR.

NO CLAIM IS MADE TO THE EXCLUSIVE RIGHT TO USE "EDITIONS", APART FROM THE MARK AS SHOWN.

FOR PRINTED EDUCATIONAL MATERIALS, NAMELY, TEXTBOOKS TARGETED TO STUDENTS, FACULTY AND PROFESSIONALS IN THE HIGHER EDUCATION MARKET, IN THE FIELDS OF HUMANITIES AND SOCIAL SCIENCES (U.S. CLS. 2, 5, 22, 23, 29, 37, 38 AND 50).

FIRST USE 11-11-2003; IN COMMERCE 11-11-2003.

DICEWRITE

THE MARK CONSISTS OF STANDARD CHARACTERS WITHOUT CLAIM TO ANY PARTICULAR FONT, STYLE, SIZE, OR COLOR.

FOR EDUCATIONAL KITS FOR REINFORCING LITERACY, FITNESS AND COMMUNICATION, COMPRISING BOOKS AND DICE GAMES (U.S. CLS. 2, 5, 22, 23, 29, 37, 38 AND 50).

FIRST USE 9-24-2004; IN COMMERCE 9-24-2004.

CLASS 16—(Continued).

3,177,937. SANTÉ FÉMININE LIMITED, SMYRNA, GA. SN 78-463,625. PUB. 11-29-2005, FILED 8-6-2004.

SENSATOUCH

THE MARK CONSISTS OF STANDARD CHARACTERS WITHOUT CLAIM TO ANY PARTICULAR FONT, STYLE, SIZE, OR COLOR.

FOR PRINTED INSTRUCTIONAL MATERIALS FOR BREAST SELF-EXAMINATION USING A BREAST SELF-EXAMINATION GLOVE (U.S. CLS. 2, 5, 22, 23, 29, 37, 38 AND 50).

FIRST USE 8-20-2004; IN COMMERCE 8-20-2004.

CLASS 16—(Continued).

3,177,948. STERLING PUBLISHING CO., INC., NEW YORK, NY. SN 78-467,787. PUB. 1-10-2006, FILED 8-16-2004.

I'M GOING TO READ

THE MARK CONSISTS OF STANDARD CHARACTERS WITHOUT CLAIM TO ANY PARTICULAR FONT, STYLE, SIZE, OR COLOR.

NO CLAIM IS MADE TO THE EXCLUSIVE RIGHT TO USE "READ", APART FROM THE MARK AS SHOWN.

FOR CHILDREN'S BOOKS, EXCLUDING CHILDREN'S TRAVEL BOOKS (U.S. CLS. 2, 5, 22, 23, 29, 37, 38 AND 50).

FIRST USE 2-28-2005; IN COMMERCE 2-28-2005.

3,177,975. BOATRIGT, FAYE J., HOBOKEN, NJ. SN 78-473,485. PUB. 10-25-2005, FILED 8-25-2004.



NO CLAIM IS MADE TO THE EXCLUSIVE RIGHT TO USE "BABY", APART FROM THE MARK AS SHOWN.

FOR PRINTED MATERIALS, NAMELY, CALENDARS (U.S. CLS. 2, 5, 22, 23, 29, 37, 38 AND 50).

FIRST USE 2-7-2005; IN COMMERCE 2-7-2005.

3,177,947. MCAULIFFE PAPER, INC., LIVERPOOL, NY. SN 78-467,750. PUB. 11-23-2004, FILED 8-16-2004.

BOXNOTE

THE MARK CONSISTS OF STANDARD CHARACTERS WITHOUT CLAIM TO ANY PARTICULAR FONT, STYLE, SIZE, OR COLOR.

FOR PAPER GOODS AND PRINTED MATTER, NAMELY, WRITING PAPER, WRITING PADS, NOTE PAPER, NOTE PADS, AND NOTE PAD HOLDERS (U.S. CLS. 2, 5, 22, 23, 29, 37, 38 AND 50).

FIRST USE 1-15-2005; IN COMMERCE 1-15-2005.

3,177,981. BINNEY & SMITH PROPERTIES, INC., EASTON, PA. SN 78-475,720. PUB. 4-11-2006, FILED 8-30-2004.



OWNER OF U.S. REG. NOS. 641,294, 1,279,429, AND OTHERS.

THE MARK CONSISTS OF THE WORD CRAYOLA ABOVE AN INVERTED ARCH, SURROUNDED BY AN OVAL.

FOR MARKERS, CRAYONS, CHALK, HIGHLIGHTING MARKERS, PENS, PENCILS, PERSONAL ORGANIZERS, ARTS AND CRAFTS PAINT KITS, MODELING CLAY (U.S. CLS. 2, 5, 22, 23, 29, 37, 38 AND 50).

FIRST USE 1-31-2005; IN COMMERCE 1-31-2005.

CLASS 16—(Continued).

3,178,036. CHANG, JONATHAN, SAN JOSE, CA. SN 78-502,227. PUB. 4-4-2006, FILED 10-19-2004.

基督之家
THE HOME OF CHRIST

OWNER OF U.S. REG. NO. 3,024,712.
NO CLAIM IS MADE TO THE EXCLUSIVE RIGHT TO USE "CHRIST" AND "JIDU", APART FROM THE MARK AS SHOWN.

IN THE CHINESE MANDARIN DIALECT, THE CHINESE CHARACTERS TOGETHER ARE PRONOUNCED "JI-DU-ZHI-JIA" WHICH MEANS "THE HOME OF CHRIST". THE FIRST CHINESE CHARACTER IS PRONOUNCED "JI" WHICH MEANS "FOUNDATION OR BASE". THE SECOND CHINESE CHARACTER IS PRONOUNCED "DU" WHICH MEANS "TO SUPERVISE". THE FIRST TWO CHINESE CHARACTERS COMBINED IS PRONOUNCED "JI DU" WHICH MEANS "JESUS CHRIST". THE THIRD CHINESE CHARACTER IS PRONOUNCED "ZHI" WHICH MEANS "TO GO TO, TO LEAVE FOR, TO ARRIVE AT". THE FOURTH CHINESE CHARACTER IS PRONOUNCED "JIA" WHICH MEANS "HOME OR FAMILY".

FOR PRINTED MATERIALS AND PUBLICATIONS, WHICH MAY BE IN ENGLISH OR THE CHINESE LANGUAGE, NAMELY BROCHURES, PAMPHLETS, BOOKS, NEWSLETTERS, DIRECTORIES, LEAFLETS, MAGAZINES, NEWS REPORTS, BULLETINS, PROGRAM INFORMATION, MUSIC BOOKS, COOK BOOKS, GUIDEBOOKS, PRINTED ACTIVITY BOOKS, EDUCATIONAL MATERIALS WITH A FOCUS ON ALL ASPECTS OF CHRISTIANITY, EDUCATION, RELIGION, CHURCH SERVICES, CHRISTIAN DEVELOPMENT, COMMUNITY SERVICES, LIFESTYLE, VALUES, PRAYER, FAITH, CHILDREN, YOUTH, ADULT, FAMILY AND PARENT ISSUES, DISCIPLESHIP, EVANGELICAL SERVICES, CHURCH MISSION EVENTS AND BIBLE STUDIES; EDUCATIONAL PUBLICATIONS, NAMELY TEACHING AND CURRICULUM GUIDES, STUDENT BOOKS, STUDY GUIDES AND COURSE WORKBOOKS FOR BIBLE STUDIES, CHRISTIAN FAITH, CHRISTIAN TESTIMONY, PRAISE AND WORSHIP, PRAYER, MINISTRY, FELLOWSHIP AND SERVANTHOOD; TRAINING AND DEVELOPMENT MATERIALS FOR CONDUCTING CONFERENCES, WORKSHOPS, SEMINARS, DISCIPLESHIP, HOME EDUCATION AND SCHOOLING, NAMELY, PRINTED TRAINING MATERIAL IN THE SUBJECT OF CHRISTIAN FAITH, CHRISTIAN DEVELOPMENT, EVANGELISM, RELIGIOUS SERVICES, WORSHIP LEADERSHIP; PRINTED REWARD CERTIFICATES; PRINTED KITS, WHICH MAY BE TAILORED FOR SPECIFIC AUDIENCES SUCH AS CHILDREN, TEENAGERS, STUDENTS, COUPLES, FATHERS, MOTHERS, PARENTS, GRANDPARENTS, AND MULTI-GENERATIONAL AUDIENCES CONTAINING CHRISTIAN PRODUCTS AND GIFT ITEMS, NAMELY BOOKS AND PRINTED MATERIALS, NAMELY, BIBLES, RELIGIOUS GIFT BOOKS, ACTIVITY BOOKS, REFERENCE BOOKS,

CLASS 16—(Continued).

COOK BOOKS, FICTION BOOKS, NONFICTION BOOKS; STATIONERY PRODUCTS AND SCHOOL SUPPLIES, NAMELY BUSINESS CARDS, PERSONAL ORGANIZERS, JOURNAL BOOKS, CALENDARS, ADDRESS BOOKS, POSTCARDS, NOTEBOOKS, FOLDERS, NOTE-PADS, STATIONERY, BOOKMARKS, CHILDREN'S BOOKS, COLORING BOOKS, STICKERS, STICKER BOOKS, PAPER CROSSWORD PUZZLES, ANIMATION BOOKS, ACTIVITY BOOKS, PAPER POSTERS; WRITING INSTRUMENTS NAMELY, PENS, MARKERS, WRITING BRUSHES, WRITING INKS, PENCILS, ERASERS; PRINTED PAPER IDENTIFICATION TAGS, RUBBER STAMPS AND RUBBER STAMP PADS, STENCILS, TRADING CARDS, ARTS AND CRAFTS PAINTING AND DRAWING KITS FOR CHILDREN, TEMPORARY BODY STICKERS, LUNCH BAGS; PAPER PARTY FAVORS, NAMELY, PAPER FIGURES, PAPER HAND PUPPETS; GREETING CARDS, PRINTED INVITATIONS, PAPER NAPKINS, PAPER TABLECLOTHS, PAPER PARTY DECORATIONS, AND PAPER GIFT WRAP (U.S. CLS. 2, 5, 22, 23, 29, 37, 38 AND 50).

FIRST USE 12-1-1978; IN COMMERCE 12-1-1978.

3,178,061. CTI PAPER GROUP, INC., SUN PRAIRIE, WI. SN 78-513,119. PUB. 10-11-2005, FILED 11-8-2004.

COLOR - PURE &
SIMPLE

THE MARK CONSISTS OF STANDARD CHARACTERS WITHOUT CLAIM TO ANY PARTICULAR FONT, STYLE, SIZE, OR COLOR.

FOR PAPER, NAMELY, BOND, COPY, TRANSLUCENT, TRACING, DRAWING, ARTIST, PRINTING, SCRAP BOOK, AND WRITING PAPER; AND ENVELOPES (U.S. CLS. 2, 5, 22, 23, 29, 37, 38 AND 50).

FIRST USE 8-18-2006; IN COMMERCE 8-18-2006.

3,178,103. CROWN POLY, INC., HUNTINGTON PARK, CA. SN 78-533,948. PUB. 9-13-2005, FILED 12-16-2004.

HIPPO SAK

THE MARK CONSISTS OF STANDARD CHARACTERS WITHOUT CLAIM TO ANY PARTICULAR FONT, STYLE, SIZE, OR COLOR.

NO CLAIM IS MADE TO THE EXCLUSIVE RIGHT TO USE SACK, APART FROM THE MARK AS SHOWN.

FOR PLASTIC BAGS FOR PACKAGING; PLASTIC TRASH BAGS (U.S. CLS. 2, 5, 22, 23, 29, 37, 38 AND 50).

FIRST USE 6-0-2005; IN COMMERCE 6-0-2005.

CLASS 16—(Continued).

3,178,131. KN LTD., SAN RAFAEL, CA. SN 78-547,062. PUB. 11-29-2005, FILED 1-13-2005.

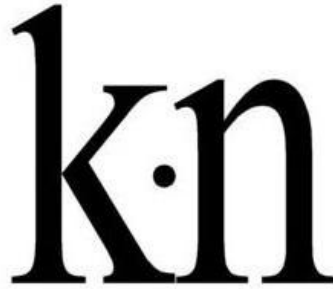

THE MARK CONSISTS OF STANDARD CHARACTERS WITHOUT CLAIM TO ANY PARTICULAR FONT, STYLE, SIZE, OR COLOR.

OWNER OF U.S. REG. NO. 2,259,410.

FOR ARTICLES OF PAPER OR OF CARDBOARD, NAMELY, INVITATIONS, GREETING CARDS, NOTE CARDS, GIFT TAGS, POST CARDS, NAME CARDS, PLACE CARDS, SCRAP BOOKING MATERIALS, NAMELY, VELLUM, VELVETEEN AND SATIN DECORATIVE PAPERS, ENVELOPES, STICKERS, BORDER STICKERS, PAPER DIE CUT SHAPES, FILE SORTERS, LETTERS MADE OF PAPER, RUBBER STAMPS AND STAMP INK, RIBBON AND WRAPPING PAPER; STATIONERY, STICKERS, BOOKS, NAMELY, CALENDARS, PICTURE BOOKS, STORY BOOKS, BLANK AND LINED NOTE BOOKS, AND PERSONAL JOURNALS AND ALBUMS (U.S. CLS. 2, 5, 22, 23, 29, 37, 38 AND 50).

FIRST USE 11-1-2005; IN COMMERCE 11-1-2005.

3,178,149. BARNES & NOBLE, INC., NEW YORK, NY. SN 78-553,177. PUB. 12-13-2005, FILED 1-25-2005.

**LIBRARY OF
ESSENTIAL READING**

THE MARK CONSISTS OF STANDARD CHARACTERS WITHOUT CLAIM TO ANY PARTICULAR FONT, STYLE, SIZE, OR COLOR.

NO CLAIM IS MADE TO THE EXCLUSIVE RIGHT TO USE "LIBRARY AND READING", APART FROM THE MARK AS SHOWN.

FOR SERIES OF NON-FICTION BOOKS FEATURING LITERATURE (U.S. CLS. 2, 5, 22, 23, 29, 37, 38 AND 50).
FIRST USE 2-28-2005; IN COMMERCE 2-28-2005.

CLASS 16—(Continued).

3,178,180. CIVICCARDS, INC., PITTSBURGH, PA. SN 78-565,305. PUB. 11-8-2005, FILED 2-11-2005.

CivicCards

THE MARK CONSISTS OF STANDARD CHARACTERS WITHOUT CLAIM TO ANY PARTICULAR FONT, STYLE, SIZE, OR COLOR.

FOR TRADING CARDS BEARING INFORMATION ABOUT AND IMAGES OF PUBLIC OFFICIALS (U.S. CLS. 2, 5, 22, 23, 29, 37, 38 AND 50).

FIRST USE 6-18-2005; IN COMMERCE 6-18-2005.

3,178,220. WORELL, KENNETH, MEMPHIS, TN. SN 78-573,662. PUB. 11-22-2005, FILED 2-23-2005.

BUBBLES & BONES

THE MARK CONSISTS OF STANDARD CHARACTERS WITHOUT CLAIM TO ANY PARTICULAR FONT, STYLE, SIZE, OR COLOR.

FOR COMIC BOOKS, NOTEBOOKS, TRADING CARDS, COMIC STRIPS, CARTOON PRINTS, NOTE-CARDS, GREETING CARDS, CALENDARS, DECALS, STICKERS, AND TEMPORARY TATTOOS (U.S. CLS. 2, 5, 22, 23, 29, 37, 38 AND 50).

FIRST USE 7-18-2006; IN COMMERCE 7-18-2006.

CLASS 16—(Continued).

3,178,239. LEE ADAMS-NORTH, ADENA, OH. SN 78-576,986.
PUB. 4-25-2006, FILED 2-28-2005.

Artist Review Today

THE MARK CONSISTS OF STANDARD CHARACTERS WITHOUT CLAIM TO ANY PARTICULAR FONT, STYLE, SIZE, OR COLOR.

NO CLAIM IS MADE TO THE EXCLUSIVE RIGHT TO USE "ARTIST REVIEW", APART FROM THE MARK AS SHOWN.

FOR MAGAZINES IN THE FIELD OF ART (U.S. CLS. 2, 5, 22, 23, 29, 37, 38 AND 50).

FIRST USE 10-1-2005; IN COMMERCE 6-1-2006.

3,178,242. CAMPUS MARKETING SERVICES, LLC, FRAMINGHAM, MA. SN 78-578,059. PUB. 12-6-2005, FILED 3-2-2005.

STUDENT HEALTH 101

THE MARK CONSISTS OF STANDARD CHARACTERS WITHOUT CLAIM TO ANY PARTICULAR FONT, STYLE, SIZE, OR COLOR.

NO CLAIM IS MADE TO THE EXCLUSIVE RIGHT TO USE "STUDENT HEALTH", APART FROM THE MARK AS SHOWN.

FOR STUDENT HANDBOOK RELATING TO HEALTH AND WELLNESS ISSUES (U.S. CLS. 2, 5, 22, 23, 29, 37, 38 AND 50).

FIRST USE 9-30-2004; IN COMMERCE 9-30-2004.

CLASS 16—(Continued).

3,178,254. CRI 2000, L.P., SAN DIEGO, CA. SN 78-581,402.
PUB. 12-20-2005, FILED 3-7-2005.

EUROTRAK

THE MARK CONSISTS OF STANDARD CHARACTERS WITHOUT CLAIM TO ANY PARTICULAR FONT, STYLE, SIZE, OR COLOR.

FOR DRY ERASE WRITING BOARDS AND CORK MEMORANDUM BOARDS (U.S. CLS. 2, 5, 22, 23, 29, 37, 38 AND 50).

FIRST USE 8-0-2004; IN COMMERCE 8-0-2004.

3,178,256. EK SUCCESS, LTD., CLIFTON, NJ. SN 78-581,843.
PUB. 5-2-2006, FILED 3-7-2005.

A TOUCH OF JOLEE'S

THE MARK CONSISTS OF STANDARD CHARACTERS WITHOUT CLAIM TO ANY PARTICULAR FONT, STYLE, SIZE, OR COLOR.

OWNER OF U.S. REG. NOS. 2,897,772 AND 2,977,071.
FOR THREE DIMENSIONAL HANDMADE STICKERS (U.S. CLS. 2, 5, 22, 23, 29, 37, 38 AND 50).

FIRST USE 8-10-2005; IN COMMERCE 8-10-2005.

3,178,274. BATTAT INCORPORATED, PLATTSBURGH, NY.
SN 78-585,668. PUB. 12-13-2005, FILED 3-11-2005.

ART STUDIO BY BATTAT

THE MARK CONSISTS OF STANDARD CHARACTERS WITHOUT CLAIM TO ANY PARTICULAR FONT, STYLE, SIZE, OR COLOR.

OWNER OF U.S. REG. NOS. 1,387,626 AND 1,755,506.

CLASS 16—(Continued).

NO CLAIM IS MADE TO THE EXCLUSIVE RIGHT TO USE "ART STUDIO", APART FROM THE MARK AS SHOWN.

THE TERM BATTAT IS TRANSLATED INTO ENGLISH AS "GEESE HERDER".

FOR ART SUPPLIES, NAMELY SELF-CONTAINED ART MATERIAL KITS COMPRISING WOODEN EASELS, PAINTS, PAINT BRUSHES, PALETTES FOR MIXING PAINT, AND CANVASSES (U.S. CLS. 2, 5, 22, 23, 29, 37, 38 AND 50).

FIRST USE 8-30-2005; IN COMMERCE 8-30-2005.

3,178,279. BAYUK, DIANE W, HELENA, MT. SN 78-586,421. PUB. 4-4-2006, FILED 3-14-2005.



FOR PAPER BOWS FOR GIFT WRAP AND GIFT PACKAGE ADORNMENT (U.S. CLS. 2, 5, 22, 23, 29, 37, 38 AND 50).

FIRST USE 7-24-2006; IN COMMERCE 6-28-2006.

3,178,299. BTB INTERNATIONAL MANUFACTURING CORPORATION, TEMPLE, TX. SN 78-590,383. PUB. 12-20-2005, FILED 3-18-2005.

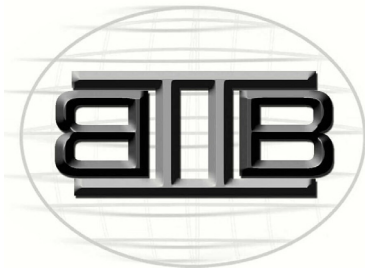

BUSINESS TO BUSINESS

FOR TACK BOARDS; FELT BOARDS; DIRECTORY BOARDS; CHALK, SLATE AND ERASABLE MARKER BOARDS FOR WRITING; WALL MOUNTED CHALK, BULLETIN AND BLACK BOARDS; EASELS; CORK BOARDS; PROJECTION SURFACES; ADJUSTABLE WALL MOUNTED CHALK, BULLETIN AND BLACK BOARDS AND PARTS AND FITTINGS FOR ALL OF THE FOREGOING, INCLUDING RESURFACING MATERIALS; MARKERS; ERASERS (U.S. CLS. 2, 5, 22, 23, 29, 37, 38 AND 50).

FIRST USE 5-1-2006; IN COMMERCE 7-19-2006.

CLASS 16—(Continued).

3,178,318. FIBRE-CRAFT MATERIALS CORPORATION, NILES, IL. SN 78-593,632. PUB. 12-20-2005, FILED 3-23-2005.

iTRAVEL

FOR ARTS AND CRAFT KITS FOR MAKING TOYS, DECORATIVE ITEMS AND FOAM SHAPES (U.S. CLS. 2, 5, 22, 23, 29, 37, 38 AND 50).

FIRST USE 5-25-2006; IN COMMERCE 5-25-2006.

3,178,332. KIND, ERIC, NEW YORK, NY. AND SADOWSKY, DEREK, NEW YORK, NY. SN 78-595,724. PUB. 12-20-2005, FILED 3-26-2005.

Pothead and Pans

THE MARK CONSISTS OF STANDARD CHARACTERS WITHOUT CLAIM TO ANY PARTICULAR FONT, STYLE, SIZE, OR COLOR.

FOR SERIES OF NON-FICTION BOOKS IN THE FIELD OF COOKBOOKS AND RECIPES (U.S. CLS. 2, 5, 22, 23, 29, 37, 38 AND 50).

FIRST USE 8-15-2006; IN COMMERCE 8-15-2006.

CLASS 16—(Continued).

3,178,351. VALLEY SCREEN PRINTING, INC., NORTH HOLLYWOOD, CA. SN 78-598,688. PUB. 12-20-2005, FILED 3-30-2005.



FOR MEMO NOTE PADS WITH STICKY ELEMENT ON BACK (U.S. CLS. 2, 5, 22, 23, 29, 37, 38 AND 50). FIRST USE 12-5-2005; IN COMMERCE 12-5-2005.

CLASS 16—(Continued).

3,178,353. EK SUCCESS, LTD., CLIFTON, NJ. SN 78-599,167. PUB. 12-27-2005, FILED 3-31-2005.

PEP RALLY

THE MARK CONSISTS OF STANDARD CHARACTERS WITHOUT CLAIM TO ANY PARTICULAR FONT, STYLE, SIZE, OR COLOR.

FOR HANDMADE DIMENSIONAL STICKERS, EMBROIDERED DIMENSIONAL STICKERS, STICKERS, FABRIC ALBUMS FOR STICKERS AND SCRAP BOOKING, CARDSTOCK DESIGNS, NAMELY, PRINTED PATTERNS, EMBROIDERED STICKER DESIGN PATTERNS AND PAPER (U.S. CLS. 2, 5, 22, 23, 29, 37, 38 AND 50). FIRST USE 9-21-2005; IN COMMERCE 9-21-2005.

3,178,352. STERLING PUBLISHING CO., INC., NEW YORK, NY. SN 78-599,063. PUB. 12-27-2005, FILED 3-31-2005.

MEMORIES OF A LIFETIME

THE MARK CONSISTS OF STANDARD CHARACTERS WITHOUT CLAIM TO ANY PARTICULAR FONT, STYLE, SIZE, OR COLOR.

FOR SERIES OF BOOKS FEATURING DECORATIVE ARTS, CRAFTS, ILLUSTRATIONS AND FABRICS FOR USE IN CREATING SCRAPBOOKS, CARDS AND DECORATIVE PROJECTS (U.S. CLS. 2, 5, 22, 23, 29, 37, 38 AND 50).

FIRST USE 5-30-2005; IN COMMERCE 5-30-2005.

3,178,372. BUDOKON, INC., WOODLAND HILLS, CA. SN 78-603,209. PUB. 12-27-2005, FILED 4-6-2005.

budokon 

THE MARK CONSISTS OF THE WORD BUDOKON IN STYLIZED LETTERING WITH A SYMBOL CONSISTING OF THREE STYLIZED CIRCULAR FIGURES WITH TAILS CONTAINED WITHIN A LARGER CIRCLE TO THE UPPER RIGHT OF THE WORD BUDOKON.

THE FOREIGN WORDING IN THE MARK TRANSLATES INTO ENGLISH AS THE WAY OF THE WARRIOR SPIRIT. FOR PRINTED MATTER, NAMELY, BOOKS AND PAMPHLETS ON THE SUBJECTS OF MARTIAL ARTS, YOGA, MEDITATION, WEIGHT-LOSS AND MOTIVATION (U.S. CLS. 2, 5, 22, 23, 29, 37, 38 AND 50).

FIRST USE 8-31-2005, THE MARK WAS FIRST USED ANYWHERE IN A DIFFERENT FORM OTHER THAN THAT SOUGHT TO BE REGISTERED ON 04/17/2003; IN COMMERCE 8-31-2005, THE MARK WAS FIRST USED IN COMMERCE IN A DIFFERENT FORM OTHER THAN THAT SOUGHT TO BE REGISTERED ON 04/17/2003..

CLASS 16—(Continued).

3,178,381. THE PROCTER & GAMBLE COMPANY, CINCINNATI, OH. SN 78-606,105. PUB. 1-3-2006, FILED 4-11-2005.

THE STRONG QUILTED PICKER
UPPER

THE MARK CONSISTS OF STANDARD CHARACTERS WITHOUT CLAIM TO ANY PARTICULAR FONT, STYLE, SIZE, OR COLOR.
FOR PAPER TOWELS (U.S. CLS. 2, 5, 22, 23, 29, 37, 38 AND 50).
FIRST USE 9-1-2005; IN COMMERCE 9-1-2005.

3,178,416. TROWBRIDGE-KITCHENS, NANCY, BOCA RATON, FL. SN 78-621,733. PUB. 1-17-2006, FILED 5-3-2005.

munch and learn

THE MARK CONSISTS OF STANDARD CHARACTERS WITHOUT CLAIM TO ANY PARTICULAR FONT, STYLE, SIZE, OR COLOR.
FOR LUNCH BAGS (U.S. CLS. 2, 5, 22, 23, 29, 37, 38 AND 50).
FIRST USE 6-26-2006; IN COMMERCE 8-15-2006.

3,178,450. M GROUP, INC., MANITOWOC, WI. SN 78-634,405. PUB. 2-21-2006, FILED 5-21-2005.

Hey Mr. Fireman

THE MARK CONSISTS OF STANDARD CHARACTERS WITHOUT CLAIM TO ANY PARTICULAR FONT, STYLE, SIZE, OR COLOR.
FOR STICKERS, ADHESIVE-BACKED PRINTED PAPER SIGNS AND LABELS (U.S. CLS. 2, 5, 22, 23, 29, 37, 38 AND 50).
FIRST USE 8-1-2005; IN COMMERCE 5-19-2006.

CLASS 16—(Continued).

3,178,460. BRICK PACKAGING, LLC, TRAVERSE CITY, MI. SN 78-639,408. PUB. 2-7-2006, FILED 5-27-2005.

Great Times Great Wines

THE MARK CONSISTS OF STANDARD CHARACTERS WITHOUT CLAIM TO ANY PARTICULAR FONT, STYLE, SIZE, OR COLOR.
NO CLAIM IS MADE TO THE EXCLUSIVE RIGHT TO USE "GREAT WINES", APART FROM THE MARK AS SHOWN.
FOR CORRUGATED BOXES FOR WINE BOTTLES (U.S. CLS. 2, 5, 22, 23, 29, 37, 38 AND 50).
FIRST USE 6-1-2005; IN COMMERCE 6-1-2005.

3,178,463. JOSWICK, PAUL GARRETT, MILWAUKEE, WI. SN 78-640,540. PUB. 2-21-2006, FILED 5-31-2005.

Cosmic Dominion

THE MARK CONSISTS OF STANDARD CHARACTERS WITHOUT CLAIM TO ANY PARTICULAR FONT, STYLE, SIZE, OR COLOR.
FOR COMIC BOOK (U.S. CLS. 2, 5, 22, 23, 29, 37, 38 AND 50).
FIRST USE 5-31-2006; IN COMMERCE 5-31-2006.

3,178,497. THE PROCTER & GAMBLE COMPANY, CINCINNATI, OH. SN 78-656,621. PUB. 3-21-2006, FILED 6-23-2005.

SOFTNESS, STRENGTH & VALUE
ROLLED INTO ONE

THE MARK CONSISTS OF STANDARD CHARACTERS WITHOUT CLAIM TO ANY PARTICULAR FONT, STYLE, SIZE, OR COLOR.
FOR TOILET TISSUE (U.S. CLS. 2, 5, 22, 23, 29, 37, 38 AND 50).
FIRST USE 2-28-2006; IN COMMERCE 2-28-2006.

CLASS 16—(Continued).

3,178,510. PATTERN EXPRESSIONS, LLC, LAWSON, MO. SN 78-659,603. PUB. 3-14-2006, FILED 6-28-2005.

PATTERN EXPRESSIONS BY K &
A

THE MARK CONSISTS OF STANDARD CHARACTERS WITHOUT CLAIM TO ANY PARTICULAR FONT, STYLE, SIZE, OR COLOR.

NO CLAIM IS MADE TO THE EXCLUSIVE RIGHT TO USE "PATTERN", APART FROM THE MARK AS SHOWN. FOR PRINTED CRAFT PATTERNS (U.S. CLS. 2, 5, 22, 23, 29, 37, 38 AND 50).

FIRST USE 9-15-2005; IN COMMERCE 9-15-2005.

3,178,564. POTLATCH CORPORATION, SPOKANE, WA. SN 78-680,914. PUB. 5-16-2006, FILED 7-28-2005.

PERFECTLY STRONG

THE MARK CONSISTS OF STANDARD CHARACTERS WITHOUT CLAIM TO ANY PARTICULAR FONT, STYLE, SIZE, OR COLOR.

NO CLAIM IS MADE TO THE EXCLUSIVE RIGHT TO USE "STRONG", APART FROM THE MARK AS SHOWN.

FOR PAPER TOWELS (U.S. CLS. 2, 5, 22, 23, 29, 37, 38 AND 50).

FIRST USE 5-1-2006; IN COMMERCE 5-1-2006.

3,178,588. FIRST CHOICE EDUCATION GROUP, LLC, WALTHAM, MA. SN 78-699,002. PUB. 5-9-2006, FILED 8-24-2005.

**Academic
Workout**

NO CLAIM IS MADE TO THE EXCLUSIVE RIGHT TO USE ACADEMIC, APART FROM THE MARK AS SHOWN.

FOR EDUCATIONAL MATERIALS AND TEACHER GUIDES FOR USE IN READING/LANGUAGE ARTS IN ENGLISH (U.S. CLS. 2, 5, 22, 23, 29, 37, 38 AND 50).

FIRST USE 11-9-2005; IN COMMERCE 11-9-2005.

CLASS 16—(Continued).

3,178,630. 7-MILE INVESTMENT, INC., LAKE OZARK, MO. SN 78-719,366. PUB. 6-6-2006, FILED 9-23-2005.

TOADLIFE

THE MARK CONSISTS OF STANDARD CHARACTERS WITHOUT CLAIM TO ANY PARTICULAR FONT, STYLE, SIZE, OR COLOR.

FOR MAGAZINES FEATURING TOPICS, SITES, ACTIVITIES, AND AFFAIRS IMPACTING LAKE COMMUNITY RESIDENTS, AND MAGAZINES FEATURING ENTERTAINMENT, REAL ESTATE, AND SOCIAL EVENTS (U.S. CLS. 2, 5, 22, 23, 29, 37, 38 AND 50).

FIRST USE 5-1-2006; IN COMMERCE 5-1-2006.

3,178,646. JAKKS PACIFIC, INC., MALIBU, CA. SN 78-733,826. PUB. 6-13-2006, FILED 10-14-2005.

miniz

FOR WRITING INSTRUMENTS (U.S. CLS. 2, 5, 22, 23, 29, 37, 38 AND 50).

FIRST USE 3-10-2006; IN COMMERCE 3-10-2006.

3,178,647. JAKKS PACIFIC, INC., MALIBU, CA. SN 78-733,841. PUB. 6-13-2006, FILED 10-14-2005.

MINIZ

THE MARK CONSISTS OF STANDARD CHARACTERS WITHOUT CLAIM TO ANY PARTICULAR FONT, STYLE, SIZE, OR COLOR.

FOR WRITING INSTRUMENTS (U.S. CLS. 2, 5, 22, 23, 29, 37, 38 AND 50).

FIRST USE 3-10-2006; IN COMMERCE 3-10-2006.

CLASS 16—(Continued).

3,178,660. BEST BUY ENTERPRISE SERVICES, INC., RICHFIELD, MN. SN 78-977,408. PUB. 10-18-2005, FILED 11-19-2004.

DYNEX

THE MARK CONSISTS OF STANDARD CHARACTERS WITHOUT CLAIM TO ANY PARTICULAR FONT, STYLE, SIZE, OR COLOR.

FOR PRINTING PAPER, COMPUTER PRINTER PAPER, AND PAPER SHREDDERS FOR OFFICE USE (U.S. CLS. 2, 5, 22, 23, 29, 37, 38 AND 50).

FIRST USE 6-19-2005; IN COMMERCE 6-19-2005.

CLASS 17—RUBBER GOODS

3,177,379. GPA ACQUISITION COMPANY, INC., CHICAGO, IL. SN 76-499,007. PUB. 12-27-2005, FILED 3-20-2003.

ULTRA DIGITAL

NO CLAIM IS MADE TO THE EXCLUSIVE RIGHT TO USE "DIGITAL", APART FROM THE MARK AS SHOWN.

FOR FILM PRODUCTS FOR USE ON PLATELESS IMAGING SYSTEMS, NAMELY, PLASTIC FILM FOR USE IN LAMINATING PAPER, PLASTIC FILM FOR USE IN REPRODUCTION OF IMAGES FROM PLATELESS IMAGING SYSTEMS (U.S. CLS. 1, 5, 12, 13, 35 AND 50).

FIRST USE 7-0-2003; IN COMMERCE 7-0-2003.

3,177,423. BKI HOLDING CORPORATION, WILMINGTON, DE. SN 76-574,341. PUB. 7-5-2005, FILED 2-6-2004.

BUCKEYE ULTRAFIBER 500

THE MARK CONSISTS OF STANDARD CHARACTERS WITHOUT CLAIM TO ANY PARTICULAR FONT, STYLE, SIZE, OR COLOR.

FOR POLYMERIC FIBERS FOR USE IN CONSTRUCTION MATERIALS, NAMELY, CEMENTITIOUS MIXTURES, ASPHALT AND COMPOSITES (U.S. CLS. 1, 5, 12, 13, 35 AND 50).

FIRST USE 6-1-2004; IN COMMERCE 6-1-2004.

CLASS 17—(Continued).

3,177,598. STROMDAHL, ANDREW W., MINOCQUA, WI. AND ROWSE, EDWARD S, WILMINGTON, DE. SN 78-107,994. PUB. 8-20-2002, FILED 2-11-2002.

ACRYLON

SEC. 2(F).
FOR COMPOUNDED RESINS FOR INJECTION AND BLOW MOLDING PURPOSES (U.S. CLS. 1, 5, 12, 13, 35 AND 50).

FIRST USE 1-0-2002; IN COMMERCE 10-21-2005.

3,177,791. OWENS-CORNING FIBERGLAS TECHNOLOGY INC., SUMMIT, IL. SN 78-392,394. PUB. 1-11-2005, FILED 3-29-2004.

PINKPLUS

THE MARK CONSISTS OF STANDARD CHARACTERS WITHOUT CLAIM TO ANY PARTICULAR FONT, STYLE, SIZE, OR COLOR.

FOR INSULATION USED IN BUILDING AND CONSTRUCTION (U.S. CLS. 1, 5, 12, 13, 35 AND 50).

FIRST USE 4-5-2006; IN COMMERCE 4-5-2006.

3,177,903. HUGHES BROTHERS INC, SEWARD, NE. SN 78-449,851. PUB. 7-5-2005, FILED 7-13-2004.

Aslan FRP



NO CLAIM IS MADE TO THE EXCLUSIVE RIGHT TO USE "FRP", APART FROM THE MARK AS SHOWN.

THE COLOR BLUE IS CLAIMED AS A FEATURE OF THE MARK.

THE COLOR BLUE APPEARS IN THE DESIGN PORTION OF THE MARK.

FOR NON-METALLIC BUILDING MATERIALS, NAMELY PLASTIC RODS AND BARS USED AS REINFORCING FOR CONCRETE, MASONRY AND WOOD (U.S. CLS. 1, 5, 12, 13, 35 AND 50).

FIRST USE 10-5-2002; IN COMMERCE 10-5-2002.

CLASS 17—(Continued).

3,177,950. TRU VUE, INC., MCCOOK, IL. SN 78-468,085. PUB. 7-5-2005, FILED 8-16-2004.

TRUGUARD

THE MARK CONSISTS OF STANDARD CHARACTERS WITHOUT CLAIM TO ANY PARTICULAR FONT, STYLE, SIZE, OR COLOR.

OWNER OF U.S. REG. NOS. 2,407,288 AND 2,514,991. FOR ACRYLIC SHEETS FOR PICTURE FRAMES (U.S. CLS. 1, 5, 12, 13, 35 AND 50). FIRST USE 9-15-2005; IN COMMERCE 9-15-2005.

CLASS 18—(Continued).

3,177,608. BROWN, HOWARD T., VENTURA, CA. SN 78-144,788. PUB. 9-16-2003, FILED 7-17-2002.

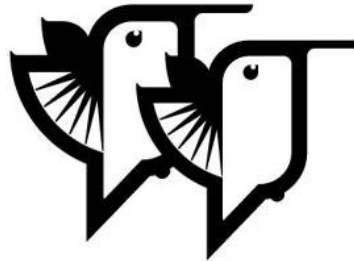

THE MARK CONSISTS OF STYLIZED REPRESENTATION OF TWO BIRDS.

FOR BAGS, NAMELY SHOULDER BAGS, TOTE BAGS, TRAVEL BAGS, COSMETIC BAGS SOLD EMPTY, AND PURSES (U.S. CLS. 1, 2, 3, 22 AND 41). FIRST USE 1-15-2006; IN COMMERCE 1-15-2006.

3,177,650. MAPLE LEAF SPORTS & ENTERTAINMENT, LTD., TORONTO, ONTARIO, CANADA. SN 78-247,348. PUB. 11-25-2003, FILED 5-8-2003.

CLASS 18—LEATHER GOODS

3,177,421. SANRIO COMPANY, LTD., TOKYO 141, JAPAN. SN 76-570,760. PUB. 6-28-2005, FILED 1-20-2004.

CHI CHAI MONCHAN

THE MARK CONSISTS OF STANDARD CHARACTERS WITHOUT CLAIM TO ANY PARTICULAR FONT, STYLE, SIZE, OR COLOR.

THE NAME "CHI CHAI MONCHAN" DOES NOT IDENTIFY A PARTICULAR LIVING INDIVIDUAL.

"CHI CHAI MONCHAN" IS TRANSLATED FROM THE JAPANESE LANGUAGE AS "DEAR SMALL MONKEY."

FOR TOTE BAGS, SHOULDER BAGS, TRAVEL BAGS, SCHOOL BAGS, ALL PURPOSE SPORT BAGS, DRAW-STRING CARRY-ON BAGS, BACKPACKS, PURSES, COIN PURSES, WALLETS, OVERNIGHT CARRYING CASES, VANITY CASES SOLD EMPTY, HANDBAGS (U.S. CLS. 1, 2, 3, 22 AND 41). FIRST USE 8-15-2004; IN COMMERCE 8-15-2004.



FOR ATHLETIC BAGS, SHOE BAGS FOR TRAVEL, OVERNIGHT BAGS, UMBRELLAS, BACKPACKS, BABY BACKPACKS, DUFFEL BAGS, TOTE BAGS, LUGGAGE, LUGGAGE TAGS, PATIO UMBRELLAS, VALISES, ATTACHE CASES, BILLFOLDS, WALLETS, BRIEFCASES, CANES, BUSINESS CARD CASES, BOOK BAGS, ALL PURPOSE SPORTS BAGS, GOLF UMBRELLAS, GYM BAGS, LUNCH BAGS, LUNCH BOXES, PURSES, COIN PURSES, FANNY PACKS, WAIST PACKS, COSMETIC CASES SOLD EMPTY, GARMENT BAGS FOR TRAVEL, HANDBAGS, KEY CASES, KNAPSACKS, SUITCASES, TOILETRY CASES SOLD EMPTY, TRUNKS FOR TRAVELING AND RUCKSACKS (U.S. CLS. 1, 2, 3, 22 AND 41).

FIRST USE 5-19-2006; IN COMMERCE 5-19-2006.

CLASS 18—(Continued).

3,177,723. CROSSFIRE AUSTRALIA PTY LTD, BRAIDWOOD, AUSTRALIA. SN 78-345,192. PUB. 1-18-2005, FILED 12-23-2003.

CLASS 18—(Continued).

3,177,843. NEXTEP, RENO, NV. SN 78-424,955. PUB. 12-27-2005, FILED 5-25-2004.

DG-6

THE MARK CONSISTS OF STANDARD CHARACTERS WITHOUT CLAIM TO ANY PARTICULAR FONT, STYLE, SIZE, OR COLOR.

FOR BACKPACKS; CHEST-PACKS; CARRY-ON BAGS; DRAW-STRING POUCHES; FANNY PACKS; DUFFEL BAGS; OVERNIGHT BAGS (U.S. CLS. 1, 2, 3, 22 AND 41). FIRST USE 4-30-2004; IN COMMERCE 2-28-2005.



3,177,724. CROSSFIRE AUSTRALIA PTY LTD, BRAIDWOOD, AUSTRALIA. SN 78-345,206. PUB. 1-18-2005, FILED 12-23-2003.

DUKZ GUTZ

THE MARK CONSISTS OF STANDARD CHARACTERS WITHOUT CLAIM TO ANY PARTICULAR FONT, STYLE, SIZE, OR COLOR.

FOR BACKPACKS; CHEST-PACKS; CARRY-ON BAGS; DRAW-STRING POUCHES; FANNY PACKS; DUFFEL BAGS; OVERNIGHT BAGS (U.S. CLS. 1, 2, 3, 22 AND 41). FIRST USE 4-30-2004; IN COMMERCE 2-28-2005.

BLACK ANGUS

THE MARK CONSISTS OF STANDARD CHARACTERS WITHOUT CLAIM TO ANY PARTICULAR FONT, STYLE, SIZE, OR COLOR.

FOR RAWHIDE CHEWS FOR PETS (U.S. CLS. 1, 2, 3, 22 AND 41). FIRST USE 11-9-2005; IN COMMERCE 11-9-2005.



3,177,904. PET ORAL CARE INTERNATIONAL, LLC, SCOTTSDALE, AZ. SN 78-450,371. PUB. 8-9-2005, FILED 7-14-2004.

REGIMEN

THE MARK CONSISTS OF STANDARD CHARACTERS WITHOUT CLAIM TO ANY PARTICULAR FONT, STYLE, SIZE, OR COLOR.

FOR RAWHIDE CHEWS FOR ANIMALS (U.S. CLS. 1, 2, 3, 22 AND 41). FIRST USE 8-31-2004; IN COMMERCE 10-31-2004.

CLASS 18—(Continued).

3,177,971. MARAHON U.S.A., SOUTH JORDAN, UT. SN 78-472,873. PUB. 12-27-2005, FILED 8-24-2004.

CLASS 18—(Continued).

3,178,436. HARVEYS INDUSTRIES, INC., SANTA ANA, CA. SN 78-629,007. PUB. 11-29-2005, FILED 5-12-2005.

ANNEX

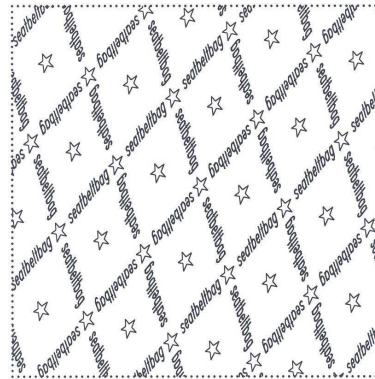

THE MARK CONSISTS OF STANDARD CHARACTERS WITHOUT CLAIM TO ANY PARTICULAR FONT, STYLE, SIZE, OR COLOR.

FOR LUGGAGE, DUFFLE BAGS, MESSENGER BAGS, ALL PURPOSE CARRYING BAGS, NAMELY, SATCHELS, BACKPACKS (U.S. CLS. 1, 2, 3, 22 AND 41).

FIRST USE 1-1-2005; IN COMMERCE 1-1-2005.

THE MARK CONSISTS OF A DIAMOND-SHAPED PATTERN COMPRISED OF THE WORD 'SEATBELTBAG' AND STYLIZED STARS.

FOR ALL PURPOSE SPORT BAGS, ALL PURPOSE ATHLETIC BAGS, ALL PURPOSE CARRYING BAGS, ATHLETIC BAGS, ATTACHE CASES, BACKPACKS, RUCKSACKS, BAGS AND HOLDALLS FOR SPORTS CLOTHING, BANKNOTE HOLDERS, BELT BAGS, BILLFOLDS, BOOK BAGS, BRIEFBAGS, BRIEFCASES, BRIEFCASE-TYPE PORTFOLIOS, BUMBAGS, BUSINESS CARD CASES, BUSINESS CASES, CARRYALLS, CARRYING CASES, CARRYING CASES FOR DOCUMENTS, CARRY-ALL BAGS, CARRY-ON BAGS, CHANGE PURSES, CLUTCH BAGS, CLUTCH PURSES, COIN PURSES, COSMETIC BAGS SOLD EMPTY, COSMETIC CASES SOLD EMPTY, DAYPACKS, DIAPER BAGS, DOCUMENT CASES, DUFFEL BAGS, EVENING HANDBAGS, FANNY PACKS, FOLDING BRIEFCASES, GYM BAGS, HANDBAGS, HANDBAGS FOR MEN, KEY CASES, LIPSTICK CASES, LUGGAGE, LUGGAGE TAGS, MULTI PURPOSE PURSES, OVERNIGHT BAGS, OVERNIGHT CASES, OVERNIGHT SUITCASES, POCKETBOOKS, PURSES, SCHOOL BAGS, SCHOOL BOOK BAGS, SHOULDER BAGS, SMALL BACKPACKS, SMALL BAGS FOR MEN, SMALL CLUTCH PURSES, SMALL PURSES, SMALL SUITCASES, SPORTS BAGS, SPORT PACKS, SUITCASES, TOILETRY CASES SOLD EMPTY, TOTE BAGS, TRAIN CASES, TRAVEL BAGS, LUGGAGE TRUNKS, WAIST BAGS, WAIST PACK, WALLETS, WRIST MOUNTED PURSES (U.S. CLS. 1, 2, 3, 22 AND 41).

FIRST USE 3-1-2005; IN COMMERCE 3-1-2005.

3,178,182. TAYLOR BRANDS, LLC, KINGSPORT, TN. SN 78-565,795. PUB. 11-8-2005, FILED 2-11-2005.

OLD TIMER

3,178,452. ALTITUDE PRODUCTS, LLC, LONGMONT, CO. SN 78-635,509. PUB. 2-7-2006, FILED 5-23-2005.

Snowblind Products

THE MARK CONSISTS OF STANDARD CHARACTERS WITHOUT CLAIM TO ANY PARTICULAR FONT, STYLE, SIZE, OR COLOR.

FOR HIKING BACKPACKS (U.S. CLS. 1, 2, 3, 22 AND 41).

FIRST USE 12-31-1958; IN COMMERCE 4-23-2006.

THE MARK CONSISTS OF STANDARD CHARACTERS WITHOUT CLAIM TO ANY PARTICULAR FONT, STYLE, SIZE, OR COLOR.

NO CLAIM IS MADE TO THE EXCLUSIVE RIGHT TO USE "PRODUCTS", APART FROM THE MARK AS SHOWN.

FOR BACKPACKS FOR CARRYING SKIS AND SNOWBOARDS (U.S. CLS. 1, 2, 3, 22 AND 41).

FIRST USE 12-1-2005; IN COMMERCE 12-1-2005.

CLASS 18—(Continued).

3,178,478. DEL VALLE, CATHERINE J., COSTA MESA, CA. SN 78-648,095. PUB. 5-2-2006, FILED 6-10-2005.

DADDY'S MATTER

THE MARK CONSISTS OF STANDARD CHARACTERS WITHOUT CLAIM TO ANY PARTICULAR FONT, STYLE, SIZE, OR COLOR.

FOR BABY PRODUCTS, NAMELY, DIAPER BAGS (U.S. CLS. 1, 2, 3, 22 AND 41).
FIRST USE 7-0-2005; IN COMMERCE 7-0-2005.

3,178,576. HEAD, DAVID T., TRUMBULL, CT. SN 78-688,307. PUB. 4-25-2006, FILED 8-9-2005.

RETRACT AROUND

THE MARK CONSISTS OF STANDARD CHARACTERS WITHOUT CLAIM TO ANY PARTICULAR FONT, STYLE, SIZE, OR COLOR.

NO CLAIM IS MADE TO THE EXCLUSIVE RIGHT TO USE "RETRACT", APART FROM THE MARK AS SHOWN. FOR ANIMAL LEASHES; RETRACTABLE TETHERS FOR ANIMALS (U.S. CLS. 1, 2, 3, 22 AND 41).
FIRST USE 9-12-2006; IN COMMERCE 9-12-2006.

CLASS 19—NON-METALLIC BUILDING MATERIALS

3,177,398. PROFESSIONAL COATING TECHNOLOGIES INC., CEDAR HILL, TX. SN 76-541,871. PUB. 5-25-2004, FILED 9-2-2003.

PHPM-50

FOR ASPHALTIC SEALANT AND MEMBRANE-FORMING COMPOSITION FOR ROAD REPAIR (U.S. CLS. 1, 12, 33 AND 50).
FIRST USE 8-1-2004; IN COMMERCE 8-1-2004.

CLASS 19—(Continued).

3,177,405. MONIERLIFETILE LLC, IRVINE, CA. SN 76-550,705. PUB. 5-25-2004, FILED 10-14-2003.

ZEPHYR VENT

NO CLAIM IS MADE TO THE EXCLUSIVE RIGHT TO USE "VENT", APART FROM THE MARK AS SHOWN. FOR ROOFING PRODUCTS, NAMELY, NON-METAL VENTED ROOF TILE (U.S. CLS. 1, 12, 33 AND 50).
FIRST USE 4-26-2005; IN COMMERCE 4-26-2005.

3,177,525. IMPACT CONTAINMENT SYSTEMS, INC., LAKE ZURICH, IL. SN 76-624,833. PUB. 11-15-2005, FILED 12-16-2004.

MOTO-ART

THE MARK CONSISTS OF STANDARD CHARACTERS WITHOUT CLAIM TO ANY PARTICULAR FONT, STYLE, SIZE, OR COLOR.

FOR NON-METAL CRASH BARRIERS AND CONCRETE-BASED METAL REINFORCED CRASH BARRIERS FOR ROADS, RACEWAYS, RACE TRACKS, RODEOS, AND GO-CART, SNOWMOBILE, MOTOR BIKE, AND MOTOR SPORT COURSES; NON-METAL BARRIERS AND CONCRETE-BASED METAL REINFORCED BARRIERS FOR PEDESTRIAN OR TRAFFIC CONTROL; NON-METAL PORTABLE BARRIERS AND PORTABLE CONCRETE-BASED METAL REINFORCED BARRIERS FOR USE AS CRASH BARRIERS AND FOR PEDESTRIAN OR TRAFFIC CONTROL (U.S. CLS. 1, 12, 33 AND 50).
FIRST USE 5-19-2005; IN COMMERCE 5-19-2005.

3,177,606. THERMOVIEV ACQUISITION CORPORATION, WASHINGTON, DC. SN 78-135,170. PUB. 11-9-2004, FILED 6-12-2002.

ALTER-LITE

FOR NON-METAL WINDOWS (U.S. CLS. 1, 12, 33 AND 50).
FIRST USE 2-0-2002; IN COMMERCE 2-0-2002.

CLASS 19—(Continued).

3,177,675. NORTHERN ELASTOMERIC, INC., BRENTWOOD, NH. SN 78-291,749. PUB. 3-21-2006, FILED 8-25-2003.

CLASS 19—(Continued).

3,177,942. STEADLY, CARL, RANCHO PALOS VERDES, CA. SN 78-465,853. PUB. 12-6-2005, FILED 8-11-2004.



The logo features a circular emblem on the left containing the letters 'AC'. To the right of the emblem, the words 'AC FoundationSeal' are written in a bold, sans-serif font. 'AC' is in a smaller size than 'FoundationSeal', which is in a larger, bolder size.

SUMI-E

OWNER OF U.S. REG. NOS. 2,139,211, 2,208,317, AND OTHERS.

NO CLAIM IS MADE TO THE EXCLUSIVE RIGHT TO USE ADVANCED COMPOSITES AND FOUNDATIONSEAL, APART FROM THE MARK AS SHOWN.

FOR LIQUID AIR BARRIER, NAMELY BITUMEN-BASED ROOFING SEALANTS (U.S. CLS. 1, 12, 33 AND 50).

FIRST USE 1-12-2006; IN COMMERCE 1-12-2006.

THE MARK CONSISTS OF STANDARD CHARACTERS WITHOUT CLAIM TO ANY PARTICULAR FONT, STYLE, SIZE, OR COLOR.

FOR GLASS TILE (U.S. CLS. 1, 12, 33 AND 50). FIRST USE 2-0-2004; IN COMMERCE 2-0-2004.

3,177,816. ASH GROVE CEMENT COMPANY, OVERLAND PARK, KS. SN 78-405,140. PUB. 10-11-2005, FILED 4-20-2004.

3,177,943. STEADLY, CARL, RANCHO PALOS VERDES, CA. SN 78-465,860. PUB. 8-30-2005, FILED 8-11-2004.

ASH GROVE DURABASE

NEBULA

THE MARK CONSISTS OF STANDARD CHARACTERS WITHOUT CLAIM TO ANY PARTICULAR FONT, STYLE, SIZE, OR COLOR.

OWNER OF U.S. REG. NOS. 257,000, 2,475,572, AND OTHERS.

FOR CEMENT KILN DUST USED FOR ROAD BASE (U.S. CLS. 1, 12, 33 AND 50).

FIRST USE 5-30-2005; IN COMMERCE 5-30-2005.

THE MARK CONSISTS OF STANDARD CHARACTERS WITHOUT CLAIM TO ANY PARTICULAR FONT, STYLE, SIZE, OR COLOR.

FOR GLASS TILE (U.S. CLS. 1, 12, 33 AND 50). FIRST USE 2-0-2004; IN COMMERCE 2-0-2004.

CLASS 19—(Continued).

3,178,033. DEGUSSA BUILDING SYSTEMS, INC., SHAKOPEE, MN. SN 78-498,390. PUB. 9-27-2005, FILED 10-12-2004.

SONOSKIM

THE MARK CONSISTS OF STANDARD CHARACTERS WITHOUT CLAIM TO ANY PARTICULAR FONT, STYLE, SIZE, OR COLOR.

FOR CEMENTITIOUS MIXTURES FOR FLOORS (U.S. CLS. 1, 12, 33 AND 50).
FIRST USE 1-17-2005; IN COMMERCE 1-17-2005.

3,178,163. KAROB CORPORATION, SHOREWOOD, WI. SN 78-560,076. PUB. 11-8-2005, FILED 2-3-2005.

NATUREWALL

THE MARK CONSISTS OF STANDARD CHARACTERS WITHOUT CLAIM TO ANY PARTICULAR FONT, STYLE, SIZE, OR COLOR.

FOR CONCRETE RETAINING WALL BLOCKS (U.S. CLS. 1, 12, 33 AND 50).
FIRST USE 2-28-2005; IN COMMERCE 2-28-2005.

3,178,528. BAILEY, WAYNE E., FREDERICKSBURG, VA. SN 78-665,680. PUB. 3-28-2006, FILED 7-7-2005.

FLOOR SHOW

THE MARK CONSISTS OF STANDARD CHARACTERS WITHOUT CLAIM TO ANY PARTICULAR FONT, STYLE, SIZE, OR COLOR.

CLASS 19—(Continued).

NO CLAIM IS MADE TO THE EXCLUSIVE RIGHT TO USE "FLOOR", APART FROM THE MARK AS SHOWN.

FOR MODULAR FLOOR TILES MADE OF A CEMENT MIXTURE, LAMINATED WITH OVERLAYS FOR FUNCTION AND DESIGN (U.S. CLS. 1, 12, 33 AND 50).
FIRST USE 2-10-2006; IN COMMERCE 2-10-2006.

3,178,604. VINYL VISIONS LLC, WILMINGTON, OH. SN 78-707,465. PUB. 5-16-2006, FILED 9-6-2005.

WOOD LOOK WITHOUT WOOD WORK

THE MARK CONSISTS OF STANDARD CHARACTERS WITHOUT CLAIM TO ANY PARTICULAR FONT, STYLE, SIZE, OR COLOR.

FOR NON-METAL GATES AND FENCES (U.S. CLS. 1, 12, 33 AND 50).
FIRST USE 1-17-2006; IN COMMERCE 1-17-2006.

3,178,672. HOMER TLC, INC., CLAYMONT, DE. SN 78-977,641. PUB. 8-2-2005, FILED 11-5-2003.

VERANDA

THE MARK CONSISTS OF STANDARD CHARACTERS WITHOUT CLAIM TO ANY PARTICULAR FONT, STYLE, SIZE, OR COLOR.

FOR NON-METAL BUILDING MATERIALS FOR USE IN BUILDING DECKS; NON-METAL FENCING; NON-METAL LATTICES (U.S. CLS. 1, 12, 33 AND 50).
FIRST USE 3-0-2004; IN COMMERCE 3-0-2004.

CLASS 20—FURNITURE AND ARTICLES NOT OTHERWISE CLASSIFIED

CLASS 20—(Continued).

3,177,336. KRUEGER INTERNATIONAL, INC., GREEN BAY, WI. SN 76-226,340. PUB. 3-7-2006, FILED 3-19-2001.

GENESIS

THE MARK CONSISTS OF STANDARD CHARACTERS WITHOUT CLAIM TO ANY PARTICULAR FONT, STYLE, SIZE, OR COLOR.

OWNER OF U.S. REG. NO. 1,920,920.
FOR TABLE AND DESK SOLD AS A UNIT (U.S. CLS. 2, 13, 22, 25, 32 AND 50).
FIRST USE 10-4-2001; IN COMMERCE 10-4-2001.

3,177,452. KOHL'S ILLINOIS, INC., AURORA, IL. SN 76-600,422. PUB. 11-22-2005, FILED 6-28-2004.

HOME CLASSICS

THE MARK CONSISTS OF STANDARD CHARACTERS WITHOUT CLAIM TO ANY PARTICULAR FONT, STYLE, SIZE, OR COLOR.

OWNER OF U.S. REG. NOS. 1,720,302, 2,287,784, AND 2,903,788.

NO CLAIM IS MADE TO THE EXCLUSIVE RIGHT TO USE "HOME", APART FROM THE MARK AS SHOWN.
FOR FITTED FABRIC SLIPCOVERS FOR FURNITURE (U.S. CLS. 2, 13, 22, 25, 32 AND 50).
FIRST USE 11-0-2004; IN COMMERCE 11-0-2004.

3,177,492. STUDIO RTA, PICO RIVERA, CA. SN 76-612,678. PUB. 1-10-2006, FILED 9-17-2004.

ODYSSEY

THE MARK CONSISTS OF STANDARD CHARACTERS WITHOUT CLAIM TO ANY PARTICULAR FONT, STYLE, SIZE, OR COLOR.

FOR READY-TO-ASSEMBLE OFFICE FURNITURE (U.S. CLS. 2, 13, 22, 25, 32 AND 50).
FIRST USE 4-0-2004; IN COMMERCE 5-0-2004.

CLASS 20—(Continued).

3,177,556. HIRSH INDUSTRIES, INC., DES MOINES, IA. SN 76-636,374. PUB. 10-25-2005, FILED 12-13-2004.

CREATE-A-DESK

THE MARK CONSISTS OF STANDARD CHARACTERS WITHOUT CLAIM TO ANY PARTICULAR FONT, STYLE, SIZE, OR COLOR.

FOR DESKS (U.S. CLS. 2, 13, 22, 25, 32 AND 50).
FIRST USE 12-31-2004; IN COMMERCE 12-31-2004.

3,177,617. J. K. SIMMONS ENTERPRISE, L.L.C., COMMERCE TOWNSHIP, MI. SN 78-159,043. PUB. 5-18-2004, FILED 8-29-2002.

THE KOOL TABLE

NO CLAIM IS MADE TO THE EXCLUSIVE RIGHT TO USE TABLE, APART FROM THE MARK AS SHOWN.

FOR TABLE DESIGNED TO COOL AND MAINTAIN THE COOL TEMPERATURES OF FOOD AND BEVERAGE FOR EXTENDED PERIODS OF TIME (U.S. CLS. 2, 13, 22, 25, 32 AND 50).
FIRST USE 3-1-2002; IN COMMERCE 3-1-2002.

3,177,635. PLEASE ASK, LLC, FORT LAUDERDALE, FL. SN 78-202,534. PUB. 10-28-2003, FILED 1-13-2003.

A LITTLE NAUGHTY A LOT OF FUN

FOR PILLOWFORMS AND PILLOWS (U.S. CLS. 2, 13, 22, 25, 32 AND 50).

FIRST USE 1-27-2003; IN COMMERCE 5-20-2003.

3,177,685. DAN-DEE INTERNATIONAL, LTD., JERSEY CITY, NJ. SN 78-301,633. PUB. 5-31-2005, FILED 9-17-2003.

TROPICAL TRANQUILITY

FOR PICTURE FRAMES MADE OF WOOD, METAL, PORCELAIN AND POLYRESIN; WIND CHIMES; DECORATIVE TABLE SCULPTURES MADE OF PLASTIC OR WOOD; POLYRESIN FIGURINES (U.S. CLS. 2, 13, 22, 25, 32 AND 50).

FIRST USE 10-29-2003; IN COMMERCE 10-29-2003.

CLASS 20—(Continued).

3,177,779. MINDER, INC., DALLAS, TX. SN 78-386,705. PUB. 12-20-2005, FILED 3-18-2004.

CLASS 20—(Continued).

3,177,925. BRANDRUD FURNITURE INC., AUBURN, WA. SN 78-459,810. PUB. 6-28-2005, FILED 7-30-2004.

MINDER

**Public Areas,
Personal Spaces**

THE MARK CONSISTS OF STANDARD CHARACTERS WITHOUT CLAIM TO ANY PARTICULAR FONT, STYLE, SIZE, OR COLOR.

FOR VERTICAL STORAGE RACKS FOR USE WITH SHELVING TO STORE FLAT OBJECTS SAFELY IN AN UPRIGHT POSITION, NOT INCLUDING LIGHTS; VERTICAL STORAGE RACKS TO STORE FLAT OBJECTS SAFELY IN AN UPRIGHT POSITION, NOT INCLUDING LIGHTS; SHOWER CURTAIN RODS AND RINGS (U.S. CLS. 2, 13, 22, 25, 32 AND 50).

FIRST USE 2-14-2006; IN COMMERCE 2-14-2006.

THE MARK CONSISTS OF STANDARD CHARACTERS WITHOUT CLAIM TO ANY PARTICULAR FONT, STYLE, SIZE, OR COLOR.

FOR FURNITURE (U.S. CLS. 2, 13, 22, 25, 32 AND 50). FIRST USE 9-12-2006; IN COMMERCE 9-12-2006.

3,177,934. HANSSEM CO., LTD., KYUNGKI-DO, REPUBLIC OF KOREA. SN 78-462,404. PUB. 10-25-2005, FILED 8-5-2004.

3,177,799. THE COLEMAN COMPANY, INC., WICHITA, KS. SN 78-397,632. PUB. 6-21-2005, FILED 4-7-2004.

TNTN

GUESTREST

THE MARK CONSISTS OF STANDARD CHARACTERS WITHOUT CLAIM TO ANY PARTICULAR FONT, STYLE, SIZE, OR COLOR.

FOR FURNITURE AND HOUSEHOLD FURNISHINGS, NAMELY, KITCHEN CABINETS, KITCHEN FURNITURE, DRESSERS, LOCKERS, HAT STANDS, SIDEBOARDS, FILING CABINETS, SECTIONAL FURNITURE, SOFAS, DINING TABLES, SHOE CABINETS, EASY CHAIRS, CLOTHES HANGERS, UMBRELLA STANDS, CHAIRS, WARDROBES, CUPBOARDS, TEA CABINETS, DESKS, BOOK RESTS, FULL-LENGTH MIRRORS, BEDS, DRESSING TABLES, INDOOR WINDOW BLINDS, PICTURE FRAMES, MATTRESSES, PILLOWS, CUSHIONS, AND INFANT WALKERS (U.S. CLS. 2, 13, 22, 25, 32 AND 50).

FIRST USE 12-10-2005; IN COMMERCE 12-10-2005.

THE MARK CONSISTS OF STANDARD CHARACTERS WITHOUT CLAIM TO ANY PARTICULAR FONT, STYLE, SIZE, OR COLOR.

FOR AIR MATTRESSES FOR NON-MEDICAL USE AND MATTRESS TOPPERS (U.S. CLS. 2, 13, 22, 25, 32 AND 50).

FIRST USE 9-1-2006; IN COMMERCE 9-1-2006.

CLASS 20—(Continued).

3,178,042. J.L. CLARK, INC., ROCKFORD, IL. SN 78-505,121.
PUB. 10-18-2005, FILED 10-25-2004.

CLASS 20—(Continued).

3,178,193. MASTERBRAND CABINETS, INC., JASPER, IN.
SN 78-568,254. PUB. 11-1-2005, FILED 2-16-2005.

FLIP-N-RIP

PERFORMA

THE MARK CONSISTS OF STANDARD CHARACTERS
WITHOUT CLAIM TO ANY PARTICULAR FONT, STYLE,
SIZE, OR COLOR.

FOR PLASTIC STORAGE CONTAINERS AND PLAS-
TIC STORAGE CONTAINER LIDS (U.S. CLS. 2, 13, 22, 25,
32 AND 50).

FIRST USE 8-7-2006; IN COMMERCE 8-7-2006.

THE MARK CONSISTS OF STANDARD CHARACTERS
WITHOUT CLAIM TO ANY PARTICULAR FONT, STYLE,
SIZE, OR COLOR.

FOR KITCHEN AND BATHROOM CABINETS (U.S.
CLS. 2, 13, 22, 25, 32 AND 50).

FIRST USE 2-0-2005; IN COMMERCE 2-0-2005.

3,178,049. GREEN DESIGN FURNITURE COMPANY, PORT-
LAND, ME. SN 78-507,578. PUB. 10-4-2005, FILED 10-28-
2004.

3,178,264. SIPDISC, INC., NEW YORK, NY. SN 78-582,911.
PUB. 11-29-2005, FILED 3-8-2005.

NEEHI

SIPDISC

THE MARK CONSISTS OF STANDARD CHARACTERS
WITHOUT CLAIM TO ANY PARTICULAR FONT, STYLE,
SIZE, OR COLOR.

FOR FURNITURE (U.S. CLS. 2, 13, 22, 25, 32 AND 50).
FIRST USE 11-9-2004; IN COMMERCE 11-9-2004.

THE MARK CONSISTS OF STANDARD CHARACTERS
WITHOUT CLAIM TO ANY PARTICULAR FONT, STYLE,
SIZE, OR COLOR.

FOR BEVERAGE STRAW HOLDER (U.S. CLS. 2, 13, 22,
25, 32 AND 50).

FIRST USE 6-1-2005; IN COMMERCE 6-1-2005.

CLASS 20—(Continued).

3,178,311. BOYD FLOTATION, INC., MARYLAND HEIGHTS, MO. SN 78-592,149. PUB. 12-20-2005, FILED 3-22-2005.

CLASS 20—(Continued).

3,178,320. FLYER, GARY, BRONX, NY. AND FLYER, SUSAN, BRONX, NY. SN 78-594,217. PUB. 12-27-2005, FILED 3-24-2005.

RELIEVE

URBINS

THE MARK CONSISTS OF STANDARD CHARACTERS WITHOUT CLAIM TO ANY PARTICULAR FONT, STYLE, SIZE, OR COLOR.
FOR BED PILLOWS, VISCO-ELASTIC MEMORY FOAM BED PILLOWS (U.S. CLS. 2, 13, 22, 25, 32 AND 50).
FIRST USE 1-1-2006; IN COMMERCE 1-1-2006.

THE MARK CONSISTS OF STANDARD CHARACTERS WITHOUT CLAIM TO ANY PARTICULAR FONT, STYLE, SIZE, OR COLOR.
FOR WALL-MOUNTED, CEILING MOUNTED OR FREE-STANDING METAL STORAGE CABINETS FOR USE IN PUBLIC AND PRIVATE GARAGES, COMMERCIAL AND RESIDENTIAL BUILDINGS (U.S. CLS. 2, 13, 22, 25, 32 AND 50).
FIRST USE 2-16-2005; IN COMMERCE 4-11-2005.

3,178,313. BOYD FLOTATION, INC., MARYLAND HEIGHTS, MO. SN 78-592,163. PUB. 12-20-2005, FILED 3-22-2005.

3,178,412. WAXMAN CONSUMER PRODUCTS GROUP INC., BEDFORD HEIGHTS, OH. SN 78-620,169. PUB. 1-31-2006, FILED 4-29-2005.

ENLIVEN

TITAN

THE MARK CONSISTS OF STANDARD CHARACTERS WITHOUT CLAIM TO ANY PARTICULAR FONT, STYLE, SIZE, OR COLOR.
FOR BED PILLOWS, VISCO-ELASTIC MEMORY FOAM BED PILLOWS, MILLED VISCO-ELASTIC MEMORY FOAM BED PILLOWS (U.S. CLS. 2, 13, 22, 25, 32 AND 50).
FIRST USE 1-1-2006; IN COMMERCE 1-1-2006.

THE MARK CONSISTS OF STANDARD CHARACTERS WITHOUT CLAIM TO ANY PARTICULAR FONT, STYLE, SIZE, OR COLOR.
FOR FURNITURE CASTERS AND SLIDES MADE OF PLASTIC FOR HOUSEHOLD, COMMERCIAL AND INDUSTRIAL USE; FELT PADS AND BUMPERS APPLIED TO LEGS OR WEIGHT BEARING SURFACES OF FURNITURE TO PREVENT FURNITURE FROM SCRATCHING OR SCUFFING FLOOR (U.S. CLS. 2, 13, 22, 25, 32 AND 50).
FIRST USE 6-0-2005; IN COMMERCE 6-0-2005.

CLASS 20—(Continued).

3,178,422. RGO ENTERPRISES, MEMPHIS, TN. SN 78-623,948. PUB. 5-16-2006, FILED 5-5-2005.

GATOR JAWS CLUB GUARD

THE MARK CONSISTS OF STANDARD CHARACTERS WITHOUT CLAIM TO ANY PARTICULAR FONT, STYLE, SIZE, OR COLOR.

NO CLAIM IS MADE TO THE EXCLUSIVE RIGHT TO USE CLUB, APART FROM THE MARK AS SHOWN.

FOR GOLF CLUB AND GOLF BAG ANTI-THEFT DEVICE IN THE NATURE OF PRIMARILY PLASTIC LOCKS (U.S. CLS. 2, 13, 22, 25, 32 AND 50).
FIRST USE 7-15-2006; IN COMMERCE 7-15-2006.

3,178,458. YANG, AARON, BREA, CA. SN 78-638,533. PUB. 4-11-2006, FILED 5-26-2005.

THEO

THE MARK CONSISTS OF STANDARD CHARACTERS WITHOUT CLAIM TO ANY PARTICULAR FONT, STYLE, SIZE, OR COLOR.

FOR PET FURNITURE NAMELY, PET BED, PET BED WITH ORGANIZER, PET SUPPLIES ORGANIZER, PET ORGANIZER WITH CLOSET, PET CLOSET, PET FOOD ORGANIZER, PET PLAY FURNITURE (U.S. CLS. 2, 13, 22, 25, 32 AND 50).

FIRST USE 8-23-2006; IN COMMERCE 8-23-2006.

CLASS 20—(Continued).

3,178,554. AUTHENTIC OZARKS, INC., CHEROKEE VILLAGE, AR. SN 78-676,097. PUB. 5-16-2006, FILED 7-22-2005.



NO CLAIM IS MADE TO THE EXCLUSIVE RIGHT TO USE "AUTHENTIC OZARKS", APART FROM THE MARK AS SHOWN.

THE COLOR(S) RED, WHITE, AND BLUE IS/ARE CLAIMED AS A FEATURE OF THE MARK.

THE COLOR(S) RED, WHITE AND BLUE APPEAR IN THE AMERICAN FLAG AND THE WORDING AUTHENTIC OZARKS. THE COLOR BLACK APPEARS IN THE EAGLE, AND RED IN THE LINE BELOW AUTHENTIC OZARKS IS/ARE CLAIMED AS A FEATURE OF THE MARK.

FOR SCULPTURES OF WOOD (U.S. CLS. 2, 13, 22, 25, 32 AND 50).

FIRST USE 3-1-2006; IN COMMERCE 3-1-2006.

3,178,609. ZOCALO, SAN FRANCISCO, CA. SN 78-710,323. PUB. 5-23-2006, FILED 9-9-2005.

FARALLON

THE MARK CONSISTS OF STANDARD CHARACTERS WITHOUT CLAIM TO ANY PARTICULAR FONT, STYLE, SIZE, OR COLOR.

FOR BEDROOM FURNITURE; BUMPER GUARDS FOR FURNITURE; CABINETS; CARPET COASTERS FOR PROTECTING FURNITURE LEGS; CAST STONE HOUSEHOLD AND GARDEN FURNITURE; COMPUTER FURNITURE; CUSHIONS; DOORS FOR FURNITURE; DRAFTING TABLES; ENTERTAINMENT CENTERS; FITTED FABRIC FURNITURE COVERS; FURNITURE; FURNITURE CHESTS; FURNITURE FOR CAMPING; FURNITURE FOR DISPLAYING GOODS; FURNITURE FOR HOUSE, OFFICE AND GARDEN; FURNITURE FRAMES; FURNITURE HARDWARE, NAMELY, DRAWER SLIDES; FURNITURE MADE FROM STEEL TUBING; FURNITURE MOLDINGS; FURNITURE PARTITIONS; FURNITURE PARTS; FURNITURE PARTS, NAMELY, COUNTERTOPS; FURNITURE, NAMELY, DISPLAY UNITS; FURNITURE, NAMELY, DRESSERS; FURNITURE, NAMELY, SALES AND DISPLAY COUNTERS; FURNITURE, NAMELY, WALL UNITS; FURNITURE, NAMELY, WARDROBES; INDOOR WINDOW BLINDS; LAWN FURNITURE; LIVING ROOM FURNITURE; MIRRORS; OFFICE FURNITURE; OUTDOOR FURNITURE; PLASTIC FURNITURE FOR GARDENS; PLASTIC MOLDS FOR USE IN MANUFACTURING FURNITURE, BED LINERS, TRAILER FLOORING AND DECKS; RECLINERS; SCREENS; SEATING FURNITURE; SEATS; TABLES; TOOL BOXES NOT OF METAL; TOOL CHESTS NOT OF METAL; TOY BOXES (U.S. CLS. 2, 13, 22, 25, 32 AND 50).

FIRST USE 9-12-2005; IN COMMERCE 10-20-2005.

CLASS 21—HOUSEWARES AND GLASS

3,177,396. SYRATECH CORPORATION, EAST BOSTON, MA.
SN 76-536,081. PUB. 5-10-2005, FILED 7-25-2003.

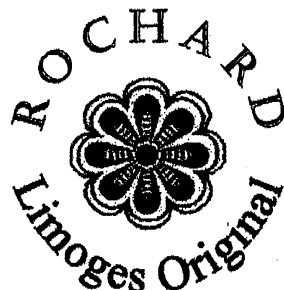

NO CLAIM IS MADE TO THE EXCLUSIVE RIGHT TO USE LIMOGES ORIGINAL, APART FROM THE MARK AS SHOWN.

FOR PORCELAIN LIMOGES BOXES AND PORCELAIN DINNERWARE (U.S. CLS. 2, 13, 23, 29, 30, 33, 40 AND 50).
FIRST USE 10-31-2003; IN COMMERCE 10-31-2003.

3,177,429. LIQUILITE, LLC, ARLINGTON HEIGHTS, IL. SN
76-579,960. PUB. 2-1-2005, FILED 3-8-2004.

LIQUILITE

FOR BEVERAGE BOTTLES, NAMELY, ILLUMINATED REFILLABLE SPORTS BOTTLE BEVERAGE CONTAINERS, SOLD EMPTY (U.S. CLS. 2, 13, 23, 29, 30, 33, 40 AND 50).

FIRST USE 2-0-2004; IN COMMERCE 2-0-2004.

3,177,740. EVENFLO COMPANY, INC., VANDALIA, OH. SN
78-359,271. PUB. 11-2-2004, FILED 1-29-2004.

SURESIP**CLASS 21—(Continued).**

THE MARK CONSISTS OF STANDARD CHARACTERS WITHOUT CLAIM TO ANY PARTICULAR FONT, STYLE, SIZE, OR COLOR.

FOR CHILDREN'S DRINKING CONTAINERS AND VALVES THEREFOR (U.S. CLS. 2, 13, 23, 29, 30, 33, 40 AND 50).

FIRST USE 1-31-2004; IN COMMERCE 1-31-2004.

3,177,784. AMDEN CORPORATION, IRVINE, CA. SN 78-388,781. PUB. 12-21-2004, FILED 3-22-2004.

DURA PICKS

THE MARK CONSISTS OF STANDARD CHARACTERS WITHOUT CLAIM TO ANY PARTICULAR FONT, STYLE, SIZE, OR COLOR.

NO CLAIM IS MADE TO THE EXCLUSIVE RIGHT TO USE "PICKS", APART FROM THE MARK AS SHOWN.

FOR TOOTHPICKS (U.S. CLS. 2, 13, 23, 29, 30, 33, 40 AND 50).

FIRST USE 2-28-2005; IN COMMERCE 2-28-2005.

3,177,878. REHCO, LLC, CHICAGO, IL. SN 78-443,050. PUB. 6-7-2005, FILED 6-29-2004.

SPEEDBRUSH

THE MARK CONSISTS OF STANDARD CHARACTERS WITHOUT CLAIM TO ANY PARTICULAR FONT, STYLE, SIZE, OR COLOR.

FOR TOOTHBRUSHES ELECTRIC AND NONELECTRIC (U.S. CLS. 2, 13, 23, 29, 30, 33, 40 AND 50).

FIRST USE 6-1-2005; IN COMMERCE 6-1-2005.

CLASS 21—(Continued).

3,177,962. JOHNSON, LEE, LAKE ELMO, MN. SN 78-470,014.
PUB. 12-6-2005, FILED 8-19-2004.

ROCKAVINO

THE MARK CONSISTS OF STANDARD CHARACTERS WITHOUT CLAIM TO ANY PARTICULAR FONT, STYLE, SIZE, OR COLOR.

FOR CRADLES FOR WINE BOTTLES (U.S. CLS. 2, 13, 23, 29, 30, 33, 40 AND 50).

FIRST USE 6-0-2005; IN COMMERCE 6-0-2005.

3,177,986. MOTTAHEDEH & COMPANY, INC., CRANBURY, NJ. SN 78-477,187. PUB. 12-6-2005, FILED 9-1-2004.

CARILLON

THE MARK CONSISTS OF STANDARD CHARACTERS WITHOUT CLAIM TO ANY PARTICULAR FONT, STYLE, SIZE, OR COLOR.

FOR POTTERY, NAMELY PORCELAIN DECORATIVE JARS, CACHE POTS, VASES, SERVING TRAYS, CANDLESTICKS, GINGER JARS SOLD EMPTY, AND BOWLS; GLASS BEVERAGE WARE; DECORATIVE BOXES MADE OF STONEWARE; CANDLESTICKS NOT OF PRECIOUS METAL; DINNERWARE, NAMELY, PLATES, CUPS, SAUCERS AND BOWLS; DECORATIVE PLATES, BOWLS AND PLATTERS; SOUP TUREENS; SERVING PLATTERS; SERVIETTE RINGS NOT OF PRECIOUS METAL; EARTHENWARE FIGURINES; STONEWARE, NAMELY, CASSEROLE DISHES, CACHE POTS AND NAPKIN RINGS (U.S. CLS. 2, 13, 23, 29, 30, 33, 40 AND 50).

FIRST USE 8-25-2005; IN COMMERCE 8-25-2005.

CLASS 21—(Continued).

3,178,070. THE GILLETTE COMPANY, BOSTON, MA. SN 78-515,836. PUB. 9-20-2005, FILED 11-12-2004.

SMART TECHNOLOGY... BRILLIANT RESULTS

THE MARK CONSISTS OF STANDARD CHARACTERS WITHOUT CLAIM TO ANY PARTICULAR FONT, STYLE, SIZE, OR COLOR.

NO CLAIM IS MADE TO THE EXCLUSIVE RIGHT TO USE "SMART TECHNOLOGY", APART FROM THE MARK AS SHOWN.

FOR TOOTHBRUSHES AND REPLACEMENT BRUSH-HEADS FOR TOOTHBRUSHES (U.S. CLS. 2, 13, 23, 29, 30, 33, 40 AND 50).

FIRST USE 9-30-2005; IN COMMERCE 9-30-2005.

3,178,247. THERMOS L.L.C., ROLLING MEADOWS, IL. SN 78-579,440. PUB. 11-29-2005, FILED 3-3-2005.

ELEMENT5

THE MARK CONSISTS OF STANDARD CHARACTERS WITHOUT CLAIM TO ANY PARTICULAR FONT, STYLE, SIZE, OR COLOR.

FOR THERMALLY INSULATED CONTAINERS FOR FOOD OR BEVERAGES (U.S. CLS. 2, 13, 23, 29, 30, 33, 40 AND 50).

FIRST USE 9-22-2005; IN COMMERCE 9-22-2005.

CLASS 21—(Continued).

3,178,338. CHELSEA INDUSTRIES, INC., PEABODY, MA. SN 78-596,758. PUB. 12-20-2005, FILED 3-29-2005.

GOOD SENSE

THE MARK CONSISTS OF STANDARD CHARACTERS WITHOUT CLAIM TO ANY PARTICULAR FONT, STYLE, SIZE, OR COLOR.

OWNER OF U.S. REG. NOS. 1,762,802 AND 1,842,358.
FOR DISPOSABLE PLASTIC FOOD STORAGE CONTAINERS AND LIDS FOR HOUSEHOLD USE (U.S. CLS. 2, 13, 23, 29, 30, 33, 40 AND 50).

FIRST USE 5-18-2006; IN COMMERCE 5-18-2006.

3,178,378. REXAM BEAUTY AND CLOSURES INC., THOMASTON, CT. SN 78-604,481. PUB. 1-10-2006, FILED 4-8-2005.

CRIMPLESS

THE MARK CONSISTS OF STANDARD CHARACTERS WITHOUT CLAIM TO ANY PARTICULAR FONT, STYLE, SIZE, OR COLOR.

OWNER OF U.S. REG. NO. 2,014,808.
FOR MANUALLY ACTUATED PUMP DISPENSERS FOR ATTACHMENT TO PERSONAL CARE PRODUCT CONTAINERS FOR USE IN DISPENSING LIQUIDS, LOTIONS AND CREAMS (U.S. CLS. 2, 13, 23, 29, 30, 33, 40 AND 50).

FIRST USE 10-3-2005; IN COMMERCE 10-3-2005.

CLASS 21—(Continued).

3,178,428. HILLYARD ENTERPRISES, INC., ST. JOSEPH, MO. SN 78-626,971. PUB. 5-9-2006, FILED 5-10-2005.

A-Gressive

THE MARK CONSISTS OF STANDARD CHARACTERS WITHOUT CLAIM TO ANY PARTICULAR FONT, STYLE, SIZE, OR COLOR.

FOR CLEANING SPONGES (U.S. CLS. 2, 13, 23, 29, 30, 33, 40 AND 50).

FIRST USE 7-10-2005; IN COMMERCE 7-10-2005.

CLASS 22—CORDAGE AND FIBERS

3,178,081. PARABEN CORPORATION, PLEASANT GROVE, UT. SN 78-522,933. PUB. 10-4-2005, FILED 11-24-2004.

**PARABEN'S WIRELESS
STRONGHOLD BAG**

THE MARK CONSISTS OF STANDARD CHARACTERS WITHOUT CLAIM TO ANY PARTICULAR FONT, STYLE, SIZE, OR COLOR.

NO CLAIM IS MADE TO THE EXCLUSIVE RIGHT TO USE "BAG", APART FROM THE MARK AS SHOWN.

FOR FORENSIC EVIDENCE STORAGE BAGS PRIMARILY MADE OUT OF FABRIC WITH METAL (U.S. CLS. 1, 2, 7, 19, 22, 42 AND 50).

FIRST USE 1-9-2005; IN COMMERCE 2-9-2005.

CLASS 23—YARNS AND THREADS

3,178,517. J. & P. COATS, LIMITED, GLASGOW, SCOTLAND. SN 78-661,355. PUB. 3-14-2006, FILED 6-30-2005.

FEDERO

THE MARK CONSISTS OF STANDARD CHARACTERS WITHOUT CLAIM TO ANY PARTICULAR FONT, STYLE, SIZE, OR COLOR.

FOR HANDKNITTING YARNS (U.S. CL. 43).
FIRST USE 10-19-2005; IN COMMERCE 10-19-2005.

CLASS 24—FABRICS

3,177,328. VICTORIA CLASSICS LTD., NEW YORK, NY. SN 75-926,524. PUB. 7-23-2002, FILED 2-24-2000.

VICTORIA CLASSICS

NO CLAIM IS MADE TO THE EXCLUSIVE RIGHT TO USE "CLASSICS", APART FROM THE MARK AS SHOWN.
FOR CURTAINS, BEDSPREADS, TEXTILE WALL HANGINGS, NON PAPER TABLE CLOTHS, SHEETS AND PILLOW CASES (U.S. CLS. 42 AND 50).
FIRST USE 6-30-2000; IN COMMERCE 6-30-2000.

3,177,366. BAMBERGER KALIKO GMBH, 96052 BAMBERG, FED REP GERMANY. SN 76-439,507. PUB. 6-7-2005, FILED 8-9-2002.

BAKASAVE

PRIORITY CLAIMED UNDER SEC. 44(D) ON ERP N CMNTY TM OFC APPLICATION NO. 2571792, FILED 2-11-2002, REG. NO. 2571792, DATED 6-13-2003, EXPIRES 2-11-2012.

FOR TEXTILES TREATED WITH PROTECTIVE OR PRESERVATIVE IMPREGNATIONS OR COATINGS IMPARTING PROTECTION AGAINST ENVIRONMENTAL CONDITIONS, LIGHT, FIRE, ODOR, OIL, GREASE, HUMIDITY, WATER, INSECTS FOR USE IN TECHNICAL APPLICATIONS AND NOT FOR USE IN CLOTHING, NAMELY SHADES AND BLINDS (U.S. CLS. 42 AND 50).
FIRST USE 12-2-2003; IN COMMERCE 7-23-2004.

3,177,373. URBAN SUN, INC., SAN DIEGO, CA. SN 76-470,686. PUB. 8-19-2003, FILED 11-29-2002.

URBAN SUN

FOR TOWELS (U.S. CLS. 42 AND 50).
FIRST USE 6-19-2006; IN COMMERCE 6-19-2006.

3,177,890. BIGFISH IMPORTS LLC, OAK HARBOR, WA. SN 78-446,010. PUB. 7-19-2005, FILED 7-6-2004.



NO CLAIM IS MADE TO THE EXCLUSIVE RIGHT TO USE "PELTS", APART FROM THE MARK AS SHOWN.
FOR BLANKETS, THROWS AND PILLOW COVERS (U.S. CLS. 42 AND 50).
FIRST USE 8-30-2004; IN COMMERCE 9-17-2004.

CLASS 24—(Continued).

3,178,106. FABRIC TENT, MIAMI, FL. SN 78-534,607. PUB. 4-18-2006, FILED 12-17-2004.



FOR 100% SOLUTION DYED ACRYLIC FABRIC (U.S. CLS. 42 AND 50).
FIRST USE 5-1-2005; IN COMMERCE 8-1-2005.

3,178,312. BOYD FLOTATION, INC., MARYLAND HEIGHTS, MO. SN 78-592,158. PUB. 12-20-2005, FILED 3-22-2005.

PURIFY

THE MARK CONSISTS OF STANDARD CHARACTERS WITHOUT CLAIM TO ANY PARTICULAR FONT, STYLE, SIZE, OR COLOR.

FOR MATTRESS PADS, ANTI-MICROBIAL MATTRESS PADS, HYPO-ALLERGENIC MATTRESS PADS (U.S. CLS. 42 AND 50).
FIRST USE 1-1-2006; IN COMMERCE 1-1-2006.

CLASS 24—(Continued).

3,178,606. THE ORVIS COMPANY, INC., MANCHESTER, VT.
SN 78-709,143. PUB. 5-30-2006, FILED 9-8-2005.

THREE DOG NIGHT BLANKET

THE MARK CONSISTS OF STANDARD CHARACTERS
WITHOUT CLAIM TO ANY PARTICULAR FONT, STYLE,
SIZE, OR COLOR.

NO CLAIM IS MADE TO THE EXCLUSIVE RIGHT TO
USE "BLANKET", APART FROM THE MARK AS SHOWN.
FOR PROTECTIVE COVERINGS FOR BEDS, BED
BLANKETS (U.S. CLS. 42 AND 50).
FIRST USE 3-3-2006; IN COMMERCE 3-3-2006.

3,178,612. PAC FUNG FEATHER CO., LTD., KWUN TONG,
HONG KONG. SN 78-712,040. PUB. 5-23-2006, FILED 9-13-
2005.

WrinkleGuard

FOR BED LINEN (U.S. CLS. 42 AND 50).
FIRST USE 8-26-2006; IN COMMERCE 8-26-2006.

3,178,650. HOMEGOODS, INC., FRAMINGHAM, MA. SN 78-
735,146. PUB. 3-21-2006, FILED 10-18-2005.

HOLLISTON HILL

THE MARK CONSISTS OF STANDARD CHARACTERS
WITHOUT CLAIM TO ANY PARTICULAR FONT, STYLE,
SIZE, OR COLOR.

FOR BATH TOWELS (U.S. CLS. 42 AND 50).
FIRST USE 4-30-2004; IN COMMERCE 4-30-2004.

CLASS 25—CLOTHING**CLASS 25—(Continued).**

3,177,325. KIK-WEAR, INC., LOS ANGELES, CA. SN 75-
496,332. PUB. 9-27-2005, FILED 6-4-1998.

KIK GIRL

NO CLAIM IS MADE TO THE EXCLUSIVE RIGHT TO
USE "GIRL", APART FROM THE MARK AS SHOWN.

FOR CLOTHING, NAMELY, PANTS, SHIRTS,
SHORTS, T-SHIRTS, TOPS AND HATS (U.S. CLS. 22
AND 39).

FIRST USE 1-6-1998; IN COMMERCE 1-6-1998.

3,177,327. PAYLESS SHOESOURCE WORLDWIDE, INC.,
TOPEKA, KS. SN 75-792,600. PUB. 12-13-2005, FILED 9-3-
1999.



FOR FOOTWEAR (U.S. CLS. 22 AND 39).
FIRST USE 11-15-1999; IN COMMERCE 11-15-1999.

3,177,343. CAMBO ENTERPRISES INVESTMENTS LIMITED,
TORTOLA, BR. VIRGIN ISLANDS. SN 76-301,912. PUB. 11-
19-2002, FILED 8-17-2001.



FOR ARTICLES OF CLOTHING, NAMELY, SHIRTS,
PANTS, SHORTS, T-SHIRTS, POLO SHIRTS, SWEAT-
SHIRTS, VESTS, JERSEYS, NECKTIES, JACKETS,
WATERPROOF PANTS AND JACKETS, TURTLENECKS,
SWEATERS, SOCKS, GLOVES, HATS, CAPS, SHOES
AND BOOTS; SPORTS APPAREL, NAMELY, BATHING
SUITS, BATHING TRUNKS; CYCLIST'S CLOTHING,
NAMELY, SHIRTS, PANTS, SHORTS, T-SHIRTS, AND
SHOES; BEACH CLOTHES, NAMELY, SHORTS AND
BATHING SUITS; AND GOLF CLOTHES, NAMELY,
SHIRTS, PANTS, SHORTS, T-SHIRTS, AND SHOES
(U.S. CLS. 22 AND 39).

FIRST USE 3-18-2004; IN COMMERCE 3-18-2004.

CLASS 25—(Continued).

3,177,347. JAVITS, ERIC M. JR., NEW YORK, NY. SN 76-318,549. PUB. 10-11-2005, FILED 9-26-2001.

SQUISHEE

FOR WOMEN'S SHOES SOLD IN UPSCALE RETAIL STORES (U.S. CLS. 22 AND 39).
FIRST USE 8-1-1995; IN COMMERCE 11-1-2002.

3,177,348. ABLECO FINANCE LLC, NEW YORK, NY. SN 76-332,328. PUB. 5-27-2003, FILED 10-30-2001.

FOR ALL MANKIND

FOR MEN'S, WOMEN'S, AND CHILDREN'S CLOTHING, NAMELY, SHIRTS, T-SHIRTS, BLOUSES, DRESSES, VESTS, SWEATSHIRTS, SWEATERS, TRENCH COATS, BELTS, AND SPORTSWEAR, NAMELY, PANTS, AND SKIRTS (U.S. CLS. 22 AND 39).
FIRST USE 2-28-2004; IN COMMERCE 2-28-2004.

3,177,361. ALLEGRA HICKS DESIGNS LIMITED, LONDON SW3 4QS, UNITED KINGDOM. SN 76-397,692. PUB. 12-16-2003, FILED 4-18-2002.

allegra hicks 

THE NAME "ALLEGRA HICKS" IDENTIFIES A LIVING INDIVIDUAL WHOSE CONSENT IS OF RECORD.

FOR CLOTHING, NAMELY, KAFTANS, TUNICS, TROUSERS, ROBES, SCARVES, SHAWLS, CARDIGANS, SHIRTS, T-SHIRTS, SKIRTS, DRESSES, JACKETS, COATS, JUMPERS; BEACHWEAR, NAMELY, WRAPS AND SARONGS; HEADWEAR, NAMELY, BEACH HATS, BANDANAS; SLEEPWEAR; FOOTWEAR, NAMELY, SHOES, BOOTS, AND SANDALS (U.S. CLS. 22 AND 39).
FIRST USE 1-1-2000; IN COMMERCE 1-1-2000.

3,177,370. A & H SPORTSWEAR CO., INC., STOCKERTOWN, PA. SN 76-456,784. PUB. 5-27-2003, FILED 10-7-2002.

**LOOK AND FEEL SLIMMER
IN SECONDS**

OWNER OF U.S. REG. NOS. 1,981,162, 2,340,925, AND OTHERS.

FOR MISSES' AND JUNIORS' SWIMWEAR AND LINGERIE, NAMELY, BRASSIERES, SLIPS, PANTIES, TEDDIES, UNDERGARMENTS, BODY SHAPING AND FIGURE ENHANCEMENT GARMENTS, NAMELY, BODYSUITS, BODYSLIPS AND GIRDLES (U.S. CLS. 22 AND 39).

FIRST USE 7-10-2006; IN COMMERCE 7-10-2006.

CLASS 25—(Continued).

3,177,397. THE BILLBOARD CLOTHING COMPANY, LLC., LOS ANGELES, CA. SN 76-540,334. PUB. 10-19-2004, FILED 8-14-2003.

EYELEVEL MARKETING

THE MARK CONSISTS OF STANDARD CHARACTERS WITHOUT CLAIM TO ANY PARTICULAR FONT, STYLE, SIZE, OR COLOR.

NO CLAIM IS MADE TO THE EXCLUSIVE RIGHT TO USE "MARKETING", APART FROM THE MARK AS SHOWN.

FOR CLOTHING, NAMELY, SHIRTS, JACKETS, VESTS AND APRONS, FOR USE AS CARRIERS FOR ADVERTISING PANELS (U.S. CLS. 22 AND 39).

FIRST USE 9-1-2003; IN COMMERCE 12-1-2003.

3,177,399. CHICA, INC., SAN FERNANDO, CA. SN 76-542,949. PUB. 11-2-2004, FILED 9-8-2003.

ROCKERA

FOR CLOTHING, NAMELY, SHIRTS, T-SHIRTS, DRESSES, SKIRTS, PYJAMAS, SWIMSUITS, SWEAT SHIRTS, SWEAT PANTS, TANK TOPS, SHORTS, PANTS, JACKETS, SNOW BIBS, GLOVES, SHOES, ATHLETIC SHOES, SANDALS, SLIPPERS, BOOTS, BEACH FOOTWEAR, HATS, CAPS, VISORS AND UNDERWEAR; THERMAL WEAR, NAMELY, THERMAL UNDERWEAR, THERMAL SOCKS (U.S. CLS. 22 AND 39).
FIRST USE 4-0-2005; IN COMMERCE 4-0-2005.

3,177,411. INTERNATIONAL DIRECT GROUP INC., NEW YORK, NY. SN 76-554,755. PUB. 1-3-2006, FILED 10-28-2003.

FUNDAMENTAL THINGS

FOR WOMEN'S APPAREL, NAMELY DRESSES, PANTS, SHIRTS, SKIRTS, JACKETS, BLAZERS, T-SHIRTS, BLOUSES, SWEATSHIRTS AND SHORTS (U.S. CLS. 22 AND 39).

FIRST USE 7-29-2004; IN COMMERCE 7-29-2004.

3,177,420. SANRIO COMPANY, LTD., TOKYO 141, JAPAN. SN 76-570,758. PUB. 6-28-2005, FILED 1-20-2004.

CHI CHAI MONCHAN

THE MARK CONSISTS OF STANDARD CHARACTERS WITHOUT CLAIM TO ANY PARTICULAR FONT, STYLE,

CLASS 25—(Continued).

SIZE, OR COLOR.

THE NAME "CHI CHAI MONCHAN" DOES NOT IDENTIFY A PARTICULAR LIVING INDIVIDUAL.

"CHI CHAI MONCHAN" IS TRANSLATED FROM THE JAPANESE LANGUAGE AS "DEAR SMALL MONKEY."

FOR T-SHIRTS, SOCKS, SANDALS, SLIPPERS, VISORS, SCARFS (U.S. CLS. 22 AND 39).

FIRST USE 9-15-2005; IN COMMERCE 9-15-2005.

CLASS 25—(Continued).

3,177,448. 5.11, INC., MODESTO, CA. SN 76-597,333. PUB. 5-17-2005, FILED 6-15-2004.

HRT

THE MARK CONSISTS OF STANDARD CHARACTERS WITHOUT CLAIM TO ANY PARTICULAR FONT, STYLE, SIZE, OR COLOR.

FOR FOOTWEAR, BOOTS, CLOTHING, NAMELY, PANTS, SHIRTS (U.S. CLS. 22 AND 39).

FIRST USE 12-20-2004; IN COMMERCE 12-20-2004.

3,177,422. MARK LEMP FOOTWEAR, ST. LOUIS, MO. SN 76-571,375. PUB. 11-16-2004, FILED 1-22-2004.

WALKING CRADLES ELITES

THE MARK CONSISTS OF STANDARD CHARACTERS WITHOUT CLAIM TO ANY PARTICULAR FONT, STYLE, SIZE, OR COLOR.

OWNER OF U.S. REG. NO. 2,685,965.

FOR FOOTWEAR (U.S. CLS. 22 AND 39).

FIRST USE 8-1-2006; IN COMMERCE 8-1-2006.

3,177,459. CHRONOLOGIE, LLC, WEST NEW YORK, NJ. SN 76-605,120. PUB. 6-21-2005, FILED 7-27-2004.

CHRONOLOGIE

3,177,439. BUNNY CORNWALL, PORT ANGELES, WA. SN 76-586,308. PUB. 7-12-2005, FILED 4-5-2004.

THE MARK CONSISTS OF STANDARD CHARACTERS WITHOUT CLAIM TO ANY PARTICULAR FONT, STYLE, SIZE, OR COLOR.

THE TERM "CHRONOLOGIE" IS TRANSLATED INTO ENGLISH AS "CHRONOLOGY".

FOR CLOTHING, NAMELY TOPS, SHIRTS, SWEATERS, JACKETS (U.S. CLS. 22 AND 39).

FIRST USE 2-15-2005; IN COMMERCE 2-15-2005.



THE LINING IS A FEATURE OF THE MARK AND DOES NOT INDICATE COLOR.

FOR PANTS, SHIRTS, DRESSES, JACKETS, SWEATERS (U.S. CLS. 22 AND 39).

FIRST USE 12-0-2003; IN COMMERCE 12-0-2003.

3,177,479. CAPITAL MERCURY APPAREL, LTD., NEW YORK, NY. SN 76-609,795. PUB. 12-20-2005, FILED 8-30-2004.

BACK PACKER

THE MARK CONSISTS OF STANDARD CHARACTERS WITHOUT CLAIM TO ANY PARTICULAR FONT, STYLE, SIZE, OR COLOR.

OWNER OF U.S. REG. NO. 1,328,631.

SEC. 2(F).

FOR WEARING APPAREL, NAMELY, SHIRTS, SWEATERS, SLACKS, SHORTS, VESTS, DRESSES, SKIRTS AND BLOUSES (U.S. CLS. 22 AND 39).

FIRST USE 5-22-2006; IN COMMERCE 5-22-2006.

CLASS 25—(Continued).

3,177,483. MARS, INCORPORATED, MCLEAN, VA. SN 76-610,078. PUB. 12-20-2005, FILED 9-3-2004.

STARBURST

THE MARK CONSISTS OF STANDARD CHARACTERS WITHOUT CLAIM TO ANY PARTICULAR FONT, STYLE, SIZE, OR COLOR.

OWNER OF U.S. REG. NOS. 1,000,007, 1,545,544, AND OTHERS.

FOR CLOTHING, NAMELY, T-SHIRTS AND SLEEPWEAR (U.S. CLS. 22 AND 39).

FIRST USE 10-0-2005; IN COMMERCE 10-0-2005.

3,177,502. GENEXUS INTERNATIONAL, INC., INGLEWOOD, CA. SN 76-615,340. PUB. 9-27-2005, FILED 10-12-2004.

SIMPLIFY

THE MARK CONSISTS OF STANDARD CHARACTERS WITHOUT CLAIM TO ANY PARTICULAR FONT, STYLE, SIZE, OR COLOR.

FOR MEN'S WEARING APPAREL, NAMELY, TSHIRTS, SWEATSHIRTS, TANK TOPS, WOVEN SHIRTS, SWEATERS, CARDIGANS, VESTS, JACKETS, PANTS, SWEATPANTS, JEANS, SHORTS, HATS, CAPS, COATS, PAJAMAS, SHOES, SOCKS, AND UNDERWEAR; AND WOMEN'S WEARING APPAREL, NAMELY, T-SHIRTS, SWEATSHIRTS, TANK TOPS, WOVEN SHIRTS, SWEATERS, CARDIGANS, VESTS, JACKETS, PANTS, SWEATPANTS, JEANS, SHORTS, HATS, CAPS, COATS, PAJAMAS, SHOES, SKIRTS, DRESSES, BLOUSES, SOCKS, LINGERIE, UNDERWEAR, PANTYHOSE, HOSIERY, TEDDIES, BRAS, PANTIES, SLIPS, FOUNDATION GARMENTS, GIRDLES, ROBES, AND LOUNGEWEAR (U.S. CLS. 22 AND 39).

FIRST USE 7-21-2005; IN COMMERCE 7-21-2005.

CLASS 25—(Continued).

3,177,538. AMERICAN SPORTING GOODS CORPORATION, IRVINE, CA. SN 76-631,435. PUB. 11-15-2005, FILED 2-16-2005.

AVI-LITE

THE MARK CONSISTS OF STANDARD CHARACTERS WITHOUT CLAIM TO ANY PARTICULAR FONT, STYLE, SIZE, OR COLOR.

FOR ATHLETIC FOOTWEAR (U.S. CLS. 22 AND 39).
FIRST USE 6-1-2005; IN COMMERCE 6-1-2005.

3,177,544. KELLY, GRACE, LAS VEGAS, NV. SN 76-633,350. PUB. 12-13-2005, FILED 3-14-2005.

BITTER BITCH

THE MARK CONSISTS OF STANDARD CHARACTERS WITHOUT CLAIM TO ANY PARTICULAR FONT, STYLE, SIZE, OR COLOR.

FOR CLOTHING, NAMELY, SHIRTS, LONG AND SHORT SLEEVE T-SHIRTS, UNDER SHIRTS, NIGHT SHIRTS, RUGBY SHIRTS, POLO SHIRTS, JERSEYS, UNIFORMS, ATHLETIC UNIFORMS, TOPS, BOTTOMS, APRONS, PANTS, TROUSERS, SLACKS, JEANS, DENIM JEANS, OVERALLS, COVERALLS, JUMPERS, JUMP SUITS, SHORTS, BOXER SHORTS, CROP TOPS, SWEAT SHIRTS, SWEAT SHORTS, SWEAT PANTS, SWEAT SUITS, WRAPS, WARM-UP SUITS, JUMP SUITS, JOGGING SUITS, JOGGING PANTS, BLOUSES, SKIRTS, DRESSES, SWEATERS, VESTS, FLEECE VESTS, PULL-OVERS, SNOW SUITS, PARKAS, ANORAKS, PONCHOS, JACKETS, REVERSIBLE JACKETS, COATS, BLAZERS, SUITS, TURTLENECKS, SKI BIBS, SWIMWEAR, BEACHWEAR, INFANTWEAR, CAPS, BERETS, BEANIES, HATS, VISORS, HEADBANDS, WRIST BANDS, SWEAT BANDS, HEADWEAR, EAR MUFFS, SCARVES, BANDANAS, BELTS, SUSPENDERS, NECKWEAR, NECKTIES, TIES, UNDERWEAR, BRIEFS, BOXER BRIEFS, WOMEN'S LOW RISE BOXER BRIEFS, SWIMMING AND BATHING TRUNKS, BRAS, SPORTS BRAS, BRASSIERES, BUSTIERS, CORSETS, PANTIES, THONG PANTIES, GARTERS AND GARTER BELTS, HOSIERY, CAMISOLES, SHAWLS, LEOTARDS, LEGGINGS, SOCKS, LOUNGEWEAR, SLEEPWEAR, ROBES, BATH-ROBES, UNDERCLOTHES, PAJAMAS, NIGHT GOWNS, LINGERIE, NEGLIGEEES, SLIPS, LEG WARMERS, KNEE HIGHS, BODY SUITS, GLOVES, MITTENS, FOOTWEAR, SHOES, SNEAKERS, BOOTS, SANDALS, SLIPPERS, RAINWEAR, GALOSHES, HALTER TOPS, TANK TOPS, 1-SHOULDER ASYMMETRICAL TOPS, V-NECK HALTER TOPS, SPAGHETTI STRAP TANK TOPS, TIE HALTER TOPS, CAP SLEEVE RAGLAN T-SHIRTS (U.S. CLS. 22 AND 39).

FIRST USE 5-15-2005; IN COMMERCE 5-15-2005.

CLASS 25—(Continued).

3,177,545. KELLY, GRACE, LAS VEGAS, NV. SN 76-633,392.
PUB. 12-13-2005, FILED 3-14-2005.



FOR CLOTHING, NAMELY, SHIRTS, LONG AND SHORT SLEEVE T-SHIRTS, UNDER SHIRTS, NIGHT SHIRTS, RUGBY SHIRTS, POLO SHIRTS, JERSEYS, UNIFORMS, ATHLETIC UNIFORMS, TOPS, BOTTOMS, APRONS, PANTS, TROUSERS, SLACKS, JEANS, DENIM JEANS, OVERALLS, COVERALLS, JUMPERS, JUMP SUITS, SHORTS, BOXER SHORTS, CROP TOPS, SWEAT SHIRTS, SWEAT SHORTS, SWEAT PANTS, SWEAT SUITS, WRAPS, WARM-UP SUITS, JUMP SUITS, JOGGING SUITS, JOGGING PANTS, BLOUSES, SKIRTS, DRESSES, SWEATERS, VESTS, FLEECE VESTS, PULL-OVERS, SNOW SUITS, PARKAS, ANORAKS, PONCHOS, JACKETS, REVERSIBLE JACKETS, COATS, BLAZERS, SUITS, TURTLENECKS, SKI BIBS, SWIMWEAR, BEACHWEAR, INFANTWEAR, CAPS, BERETS, BANANAS, HATS, VISORS, HEADBANDS, WRIST BANDS, SWEAT BANDS, HEADWEAR, EAR MUFFS, SCARVES, BANDANAS, BELTS, SUSPENDERS, NECKWEAR, NECKTIES, TIES, UNDERWEAR, BRIEFS, BOXER BRIEFS, WOMEN'S LOW RISE BOXER BRIEFS, SWIMMING AND BATHING TRUNKS, BRAS, SPORTS BRAS, BRASSIERES, BUSTIERS, CORSETS, PANTIES, THONG PANTIES, GARTERS AND GARTER BELTS, HOSE, CAMISOLES, SHAWLS, LEOTARDS, LEGGINGS, SOCKS, LOUNGEWEAR, SLEEPWEAR, ROBES, BATH-ROBES, UNDERCLOTHES, PAJAMAS, NIGHT GOWNS, LINGERIE, NEGLIGEEES, SLIPS, LEG WARMERS, KNEE HIGHS, BODY SUITS, GLOVES, MITTENS, FOOTWEAR, SHOES, SNEAKERS, BOOTS, SANDALS, SLIPPERS, RAINWEAR, GALOSHES, HALTER TOPS, TANK TOPS, I-SHOULDER ASYMMETRICAL TOPS, V-NECK HALTER TOPS, SPAGHETTI STRAP TANK TOPS, TIE HALTER TOPS, CAP SLEEVE RAGLAN T-SHIRTS (U.S. CLS. 22 AND 39).

FIRST USE 5-15-2005; IN COMMERCE 5-15-2005.

CLASS 25—(Continued).

3,177,549. PUTNAM SOURCING GROUP, INC., VERNON, CA. SN 76-634,132. PUB. 12-20-2005, FILED 3-24-2005.

TRI-FLEX

THE MARK CONSISTS OF STANDARD CHARACTERS WITHOUT CLAIM TO ANY PARTICULAR FONT, STYLE, SIZE, OR COLOR.

FOR HEADWEAR (U.S. CLS. 22 AND 39).
FIRST USE 12-16-2005; IN COMMERCE 7-7-2006.

3,177,550. ENGLAND, KAREN ANN, PENSACOLA BEACH, FL. AND ENGLAND, ROBERT L., PENSACOLA BEACH, FL. SN 76-634,376. PUB. 12-20-2005, FILED 3-25-2005.

COMFFYBAND

THE MARK CONSISTS OF STANDARD CHARACTERS WITHOUT CLAIM TO ANY PARTICULAR FONT, STYLE, SIZE, OR COLOR.

FOR CLOTHING, NAMELY HATS, CAPS, AND VISORS (U.S. CLS. 22 AND 39).
FIRST USE 5-28-2005; IN COMMERCE 5-28-2005.

3,177,559. ANDERS, ERIN C., KANSAS CITY, MO. SN 76-637,021. PUB. 2-28-2006, FILED 4-25-2005.



FOR CLOTHING, NAMELY, SHIRTS, SHORTS, SOCKS, SWEATPANTS, SWEATSHIRTS, SWEATSUITS, RAINSUITS, WARM-UP SUITS, RUNNING SUITS, JACKETS, ATHLETIC SLEEVES, HEADWEAR, WRISTBANDS, JERSEYS, ATHLETIC UNIFORMS, TANK TOPS, UNDERWEAR, HOODS, LEGGINGS, ATHLETIC BRAS, VESTS, HATS, PANTS, SKIRTS, GLOVES (U.S. CLS. 22 AND 39).

FIRST USE 8-11-2005; IN COMMERCE 8-11-2005.

CLASS 25—(Continued).

3,177,567. PAIGE, ISAIAH, NEW YORK, NY. SN 76-639,313.
PUB. 5-9-2006, FILED 5-24-2005.



FOR APPAREL FOR WOMEN, MEN, TEEN GIRLS AND TEEN BOYS NAMELY, HEADWEAR, NAMELY HATS, CAPS, HEADBANDS, SUN VISORS AND EAR MUFFS; SWIMWEAR, NAMELY SWIMSUITS, BATHING SUITS, BATHING TRUNKS, BIKINIS, WET SUITS AND SWIM TRUNKS; BEACH WEAR, NAMELY BATHROBES, BEACH COVERUPS, BERMUDA SHORTS, CAFTANS, CLOTHING DUSTERS, FISHING WADERS, FLIGHT SUITS, GYM SHORTS, HALTER TOPS, JACKETS, WIND RESISTANT JACKETS, RAIN RESISTANT JACKETS, CLOTHING JERSEYS, JOGGING SUITS, JUMPERS, JUMPSUITS, KERCHIEFS, LEG WARMERS, LEGGINGS, LEOTARDS, NECK BANDS, NECKERCHIEFS, PEDAL PUSHERS, PLAYSUITS, POLO SHIRTS, PONCHOS, PULLOVERS, ROBES, ROMPERS, SARONGS, SASHES, SCARVES, SHAWLS, SHIRTS, SHORTS, SWEAT SHORTS, SINGLET, SKIRTS, SLACK, SMOCKS, SPORT SHIRTS, SWEAT SUITS, SWEAT SHIRTS, SWEAT SHORTS, SWEAT SOCKS, WARM UP SUITS, TIGHTS, T-SHIRTS, TANK TOPS, TUNICS, UNDERSHIRTS, UN-TARDS, VESTS, FOUL WEATHER GEAR AND CLOTHING WRAPS; CASUAL WEAR, NAMELY WRIST BANDS, CLOTHING BELTS, BLAZERS, BLOUSES, BOTTOMS, BREECHES, CAPES, CHEMISES, COATS, RAIN COATS, SPORT COATS, TOP COATS, CULOTTES, OVER COATS, DUNGAREES, GLOVES, JEANS, SWEATERS, TAP PANTS, TRACK SUITS, TROUSERS, TURTLENECKS, SHIRTS, TURTLENECK SWEATERS AND WAIST COATS; FOOTWEAR, NAMELY ANKLETS, ATHLETIC SHOES, BOOTS, CLOGS, GOLF SHOES, TENNIS SHOES, FOOTWEAR THONGS, KNEE HIGHS, MOCCASINS, OVER SHOES, CANVAS SHOES, SHOE SOLES, UPPERS FOR JAPANESE STYLE SANDALS, SOCKS, STOCKINGS, SANDALS, SLIPPERS AND SNEAKERS; WOMENS' APPAREL, NAMELY DRESSES, MINI SKIRTS, SLACKS, PAJAMAS, NEGLIGEEES AND SLEEPING GOWNS; WOMENS' LINGERIE, NAMELY BANDEAUX, BODY SUITS, BRAS, BRASSIERES, BUSTIERS, CAMI-SOLES, CHEMISES, CORSELETS, CORSETS, GARTER BELTS, GIRDLES, FOUNDATION GARMENT GIRDLES, HOSE, PANTIES, PANTYHOSE, BOXER SHORTS, SLIPS, TEDDIES AND UNDERWEAR THONGS; MEN'S CLOTHING, NAMELY ASCOTS, CRAVATS, CUMMERBUNDS, UNDERWEAR, TOPS, UNDERWEAR BRIEFS, UNDERSHIRTS, SHORTS AND BOXER SHORTS (U.S. CLS. 22 AND 39).

FIRST USE 4-22-2005; IN COMMERCE 4-22-2005.

CLASS 25—(Continued).

3,177,569. DC LICENSING LLC, GREENWICH, CT. SN 76-640,481. PUB. 5-2-2006, FILED 6-8-2005.

LINCS DC & COMPANY

THE MARK CONSISTS OF STANDARD CHARACTERS WITHOUT CLAIM TO ANY PARTICULAR FONT, STYLE, SIZE, OR COLOR.

NO CLAIM IS MADE TO THE EXCLUSIVE RIGHT TO USE "COMPANY", APART FROM THE MARK AS SHOWN.

FOR CLOTHING, NAMELY TROUSERS, SLACKS, PANTS, DRESS SHIRTS, POLO SHIRTS, SWEAT PANTS, SWEATSHIRTS, PULLOVERS, TOPS, JACKETS, SHORTS, T-SHIRTS, SWEATERS, COATS, HATS, CAPS, VESTS (U.S. CLS. 22 AND 39).

FIRST USE 7-26-2006; IN COMMERCE 7-26-2006.

3,177,576. LOGOTEL LLC, SAN FRANCISCO, CA. SN 76-643,509. PUB. 12-13-2005, FILED 7-25-2005.

LOGOTEL

THE MARK CONSISTS OF STANDARD CHARACTERS WITHOUT CLAIM TO ANY PARTICULAR FONT, STYLE, SIZE, OR COLOR.

FOR UNDERWEAR, LOUNGEWEAR, TEE SHIRTS, AND SOCKS (U.S. CLS. 22 AND 39).

FIRST USE 6-14-2006; IN COMMERCE 6-14-2006.

3,177,609. ZOO YORK THC LLC, SOUTH RIVER, NJ. SN 78-145,226. PUB. 9-16-2003, FILED 7-18-2002.

UNBREAKABLE

FOR CLOTHING, NAMELY, JEANS, TOPS, SHIRTS, SWEATSHIRTS, JACKETS, SHORTS, SWIMWEAR, HEADWEAR (U.S. CLS. 22 AND 39).

FIRST USE 5-31-2002; IN COMMERCE 5-31-2002.

3,177,636. KARSTEN MANUFACTURING CORPORATION, PHOENIX, AZ. SN 78-202,942. PUB. 6-17-2003, FILED 1-14-2003.

PING A

OWNER OF U.S. REG. NOS. 704,552, 1,647,448, AND OTHERS.

FOR CAPS (U.S. CLS. 22 AND 39).

FIRST USE 9-6-2006; IN COMMERCE 9-6-2006.

CLASS 25—(Continued).

3,177,637. KARSTEN MANUFACTURING CORPORATION, PHOENIX, AZ. SN 78-202,955. PUB. 6-17-2003, FILED 1-14-2003.

PING E

OWNER OF U.S. REG. NOS. 704,552, 1,647,448, AND OTHERS.

FOR CAPS (U.S. CLS. 22 AND 39).
FIRST USE 9-6-2006; IN COMMERCE 9-6-2006.

3,177,649. STOKTON S.R.L., PIEVE A NIEVOLE, ITALY. SN 78-243,952. PUB. 12-6-2005, FILED 4-30-2003.

STOKTON

FOR CLOTHING ARTICLES, NAMELY, SHOES, FOOTWEAR (U.S. CLS. 22 AND 39).
FIRST USE 5-22-1986; IN COMMERCE 5-22-1986.

3,177,674. KURARAY CO., LTD., OKAYAMA PREFECTURE, JAPAN. SN 78-289,612. PUB. 5-18-2004, FILED 8-20-2003.

MICROFUSION

FOR FOOTWEAR, NAMELY ATHLETIC FOOTWEAR MADE FROM SYNTHETIC LEATHER, NAMELY, SKI BOOTS, CLIMBING BOOTS, HORSE-RIDING BOOTS, SHOES FOR GOLF, SOCCER, GYMNASTICS, TENNIS, BASKETBALL, VOLLEYBALL, HANDBALL, BOWLING, BOXING, HOCKEY, BASEBALL, RUGBY, AND SPIKED SHOES FOR RUNNING AND TRACK AND FIELD ATHLETICS (U.S. CLS. 22 AND 39).

FIRST USE 3-1-2006; IN COMMERCE 3-1-2006.

3,177,677. SHEVACK, BRETT, NEW YORK, NY. SN 78-296,805. PUB. 6-15-2004, FILED 9-5-2003.

BORN IN TWIN CITIES

FOR MEN'S, WOMEN'S AND CHILDREN'S CLOTHING, NAMELY, T-SHIRTS, SHIRTS, HATS, CAPS (U.S. CLS. 22 AND 39).

FIRST USE 5-0-2006; IN COMMERCE 5-0-2006.

3,177,690. ABERCROMBIE & FITCH TRADING CO., NEW ALBANY, OH. SN 78-305,539. PUB. 7-5-2005, FILED 9-25-2003.

TUGGER

FOR CLOTHING, NAMELY, SHORTS (U.S. CLS. 22 AND 39).

FIRST USE 2-0-1998; IN COMMERCE 2-0-1998.

CLASS 25—(Continued).

3,177,717. JACKSON, WILLIAM E. JR., SUNRISE, FL. SN 78-341,114. PUB. 11-9-2004, FILED 12-15-2003.

 The logo for T-GEAR features a stylized, bold letter 'T' on the left, followed by the word 'GEAR' in a clean, sans-serif font. The 'T' is uniquely designed with a vertical bar on its left side, creating a distinctive graphic element.

FOR GOLF APPAREL, NAMELY, SHIRTS, PANTS, SHORTS, SKIRTS, SHOES, HATS, VISORS, SWEATERS, WIND-RESISTANT JACKETS AND JACKETS (U.S. CLS. 22 AND 39).

FIRST USE 11-9-2004; IN COMMERCE 12-15-2004.

3,177,731. WARNER BROS. ENTERTAINMENT INC., BURBANK, CA. SN 78-349,082. PUB. 11-2-2004, FILED 1-7-2004.

THE SORTING HAT

THE MARK CONSISTS OF STANDARD CHARACTERS WITHOUT CLAIM TO ANY PARTICULAR FONT, STYLE, SIZE, OR COLOR.

OWNER OF U.S. REG. NOS. 2,595,096 AND 2,759,251.
NO CLAIM IS MADE TO THE EXCLUSIVE RIGHT TO USE "HAT", APART FROM THE MARK AS SHOWN.

FOR CLOTHING FOR MEN, WOMEN AND CHILDREN, NAMELY, HATS, CAPS, AND MASQUERADE AND HALLOWEEN COSTUMES AND MASKS SOLD IN CONNECTION THEREWITH (U.S. CLS. 22 AND 39).

FIRST USE 12-31-2002; IN COMMERCE 12-31-2002.

CLASS 25—(Continued).

3,177,753. COOK, JEAN C., KIRKLAND, WA. SN 78-366,539.
PUB. 7-5-2005, FILED 2-11-2004.

CLASS 25—(Continued).

3,177,777. WARD, CHANEL EDWARDS, BATON ROUGE,
LA. SN 78-386,158. PUB. 12-13-2005, FILED 3-17-2004.

Hip Couture



THE MARK CONSISTS OF STANDARD CHARACTERS WITHOUT CLAIM TO ANY PARTICULAR FONT, STYLE, SIZE, OR COLOR.

NO CLAIM IS MADE TO THE EXCLUSIVE RIGHT TO USE "COUTURE", APART FROM THE MARK AS SHOWN.

FOR CLOTHING AND CLOTHING ARTICLES FOR WOMEN, NAMELY T-SHIRTS UNDERSHIRTS, NIGHT SHIRTS, RUGBY SHIRTS, POLO SHIRTS, CARDIGANS, JERSEYS, UNIFORMS, PANTS, TROUSERS, SLACKS, JEANS, CULOTTES, CARGO PANTS, DENIM JEANS, OVERALLS, COVERALLS, JUMPERS, JUMP SUITS, SHORTS, BOXER SHORTS, TOPS, CROP TOPS, TANK TOPS, HALTER TOPS, BIKINI TOPS, SWEAT SHIRTS, SWEAT SHORTS, SWEAT PANTS, WRAPS, WARM UP SUITS, JOGGING SUITS, TRACK SUITS, BLOUSES, SKIRTS, DRESSES, GOWNS, SWEATERS, VESTS, PULL-OVERS, PARKAS, SNOW SUITS, CAPES, ANORAKS, PONCHOS, JACKETS, REVERSIBLE JACKETS, COATS, BLAZERS, SUITS, TURTLENECKS, SWIMWEAR, BEACH WEAR, TENNIS WEAR, SURF WEAR, SKI WEAR, HATS, HEADBANDS, HEADWEAR, SCARVES, BANDANAS, BELTS, NECKWEAR, TIES, NECKERCHIEFS, ASCOTS, UNDERWEAR, NAMELY, PANTIES, LADIES BRIEFS, THONGS, BOY SHORTS, SPORTS BRAS, BRAS, BUSTIERS, TEDDIES, GIRDLES, FOUNDATION GARMENTS, SOCKS, LOUNGEWEAR, ROBES, SMOCKS, UNDERCLOTHES, PAJAMAS, SLEEPWEAR, NAMELY NIGHT GOWNS, LINGERIE, CAMISOLES, NEGLIGEEES, CHEMISES, SLIPS, SARONGS, LEG WARMERS, HOSE, PANTYHOSE, BODY STOCKINGS, LEGGINGS, TIGHTS, LEOTARDS, BODY SUITS, UNITARDS, BODY SHAPERS, CORSETS, WATERPROOF CLOTHING, NAMELY RAINCOATS, COATS, PARKAS, PONCHOS, JACKETS, OVERCOATS, BLAZERS, WIND RESISTANT JACKETS, BOLEROS, CAFTANS, CAPES, OVERCOATS, PULLOVERS, SHAWLS, STOLEES, HEADWEAR, NAMELY HATS, CAPS, AND SCARVES (U.S. CLS. 22 AND 39).

FIRST USE 8-30-2005; IN COMMERCE 8-30-2005.

OWNER OF U.S. REG. NO. 2,637,581.

NO CLAIM IS MADE TO THE EXCLUSIVE RIGHT TO USE "POUCH POCKETS" OR "RECOVERY WEAR", APART FROM THE MARK AS SHOWN.

THE LINING IS A FEATURE OF THE MARK AND DOES NOT INDICATE COLOR.

FOR CLOTHING, NAMELY, SLEEPWEAR AND LOUNGEWEAR FOR POST-SURGICAL USE (U.S. CLS. 22 AND 39).

FIRST USE 2-0-2004; IN COMMERCE 7-12-2006.

CLASS 25—(Continued).

3,177,834. KMC ACQUISITION CORP., LAKEWOOD, CO. SN 78-417,706. PUB. 7-26-2005, FILED 5-12-2004.

CLASS 25—(Continued).

3,177,861. SENCION, JACQUELINE, NEW YORK, NY. SN 78-436,302. PUB. 11-8-2005, FILED 6-16-2004.

XD SERIES

UDit

THE MARK CONSISTS OF STANDARD CHARACTERS WITHOUT CLAIM TO ANY PARTICULAR FONT, STYLE, SIZE, OR COLOR.

NO CLAIM IS MADE TO THE EXCLUSIVE RIGHT TO USE "SERIES", APART FROM THE MARK AS SHOWN.

FOR WEARING APPAREL, NAMELY, T-SHIRTS, SWEATSHIRTS, UNDERWEAR, TANK TOPS, HATS, AND CAPS (U.S. CLS. 22 AND 39).

FIRST USE 3-0-2003; IN COMMERCE 3-0-2003.

THE MARK CONSISTS OF STANDARD CHARACTERS WITHOUT CLAIM TO ANY PARTICULAR FONT, STYLE, SIZE, OR COLOR.

FOR CLOTHING, NAMELY, DRESSES, SKIRTS, SHIRTS, VESTS, SWEATERS, BLOUSES AND PANTS (U.S. CLS. 22 AND 39).

FIRST USE 10-26-2004; IN COMMERCE 10-26-2004.

3,177,836. THE TOPLINE CORPORATION, BELLEVUE, WA. SN 78-422,148. PUB. 3-15-2005, FILED 5-20-2004.

3,177,873. SUNG, JONG HYUN MINUS, SEOUL, REPUBLIC OF KOREA. SN 78-440,764. PUB. 6-14-2005, FILED 6-24-2004.

LECTRONIC



minus_ung

THE MARK CONSISTS OF STANDARD CHARACTERS WITHOUT CLAIM TO ANY PARTICULAR FONT, STYLE, SIZE, OR COLOR.

FOR FOOTWEAR (U.S. CLS. 22 AND 39).

FIRST USE 5-0-2004; IN COMMERCE 5-0-2004.

FOR RAINCOATS, LONG COATS, HALF COATS, SUITS, SKIRTS, SLACKS, CEREMONIAL DRESSES, BLUE JEANS, EVENING DRESSES, JACKETS, JUMPERS, TWO PIECE DRESSES, PARKERS, T-SHIRTS, MUFFLERS, GLOVES, SHOULDER WRAPS, SCARVES, CAPS, TROUSERS, GOWNS, ONE PIECE DRESSES, COATS, LEATHER SHOES, SPORT SHOES AND BELTS (U.S. CLS. 22 AND 39).

FIRST USE 4-20-2004; IN COMMERCE 6-20-2006.

CLASS 25—(Continued).

3,177,882. WARNACO U.S., INC., MILFORD, CT. SN 78-443,354. PUB. 6-7-2005, FILED 6-29-2004.

CLASS 25—(Continued).

3,177,894. STEVE COUSINS AND AMMAAR KHAN, TORONTO, CANADA. SN 78-447,369. PUB. 4-4-2006, FILED 7-8-2004.

OLGA CURVES

vuicadi

THE MARK CONSISTS OF STANDARD CHARACTERS WITHOUT CLAIM TO ANY PARTICULAR FONT, STYLE, SIZE, OR COLOR.

OWNER OF U.S. REG. NOS. 780,385, 883,813, AND 2,472,412.

FOR INTIMATE APPAREL AND FIGURE ENHANCING GARMENTS, NAMELY, BRAS, UNDERWEAR, UNDERGARMENTS, AND UNDERCLOTHES (U.S. CLS. 22 AND 39).

FIRST USE 3-31-2005; IN COMMERCE 3-31-2005.

THE MARK CONSISTS OF STANDARD CHARACTERS WITHOUT CLAIM TO ANY PARTICULAR FONT, STYLE, SIZE, OR COLOR.

FOR CLOTHING, NAMELY, CAPS AND T-SHIRTS (U.S. CLS. 22 AND 39).

FIRST USE 11-22-2005; IN COMMERCE 9-1-2006.

3,177,896. KMC ACQUISITION CORP., LAKEWOOD, CO. SN 78-448,349. PUB. 7-26-2005, FILED 7-9-2004.

3,177,893. SENIZERGUES, PIERRE ANDRE, NEWPORT BEACH, CA. SN 78-447,207. PUB. 6-14-2005, FILED 7-7-2004.

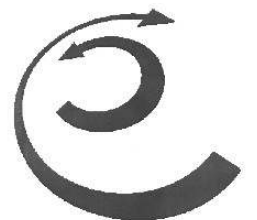

THE MARK CONSISTS OF THE WORDS "SYSTEM FLO2" IN STYLIZED FORMAT AND DEVICE.

FOR FOOTWEAR COMPONENT, NAMELY, SHOE TONGUES COMPRISED OF AIR FLOW VENTILATION FABRIC (U.S. CLS. 22 AND 39).

FIRST USE 7-31-2004; IN COMMERCE 7-31-2004.

THE MARK CONSISTS OF A PAIR OF CURVED ARROWS WHEREIN THE FIRST ARROW POINTS IN ONE DIRECTION AND THE SECOND ARROW POINTS IN A SECOND DIRECTION OPPOSITE THE FIRST DIRECTION AND FURTHER WHEREIN THE SECOND ARROW IS DISPOSED WITHIN THE CURVE OF THE FIRST ARROW.

FOR WEARING APPAREL, NAMELY, T-SHIRTS, SWEATSHIRTS, TANK TOPS, HATS AND CAPS (U.S. CLS. 22 AND 39).

FIRST USE 3-0-2003; IN COMMERCE 3-0-2003.

CLASS 25—(Continued).

3,177,899. MARCH, BARBARA, WESTLAKE VILLAGE, CA.
SN 78-449,412. PUB. 12-13-2005, FILED 7-12-2004.

STELLE

THE MARK CONSISTS OF STANDARD CHARACTERS
WITHOUT CLAIM TO ANY PARTICULAR FONT, STYLE,
SIZE, OR COLOR.

THE WORD STELLE IS THE MASCULINE VERSION OF
THE ITALIAN WORD FOR STAR.

FOR CLOTHING, NAMELY WOMEN'S JACKETS,
PANTS AND SHIRTS (U.S. CLS. 22 AND 39).

FIRST USE 2-0-2005; IN COMMERCE 11-7-2005.

CLASS 25—(Continued).

3,177,912. TEKO, LLC, BOULDER, CO. SN 78-452,923. PUB. 6-
21-2005, FILED 7-19-2004.

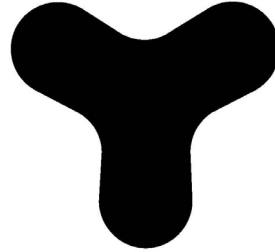

THE MARK CONSISTS OF A TRIANGLE OR "Y"-SHAPE
WITH ROUNDED POINTS.

FOR CLOTHING FOR MEN, WOMEN AND CHIL-
DREN, NAMELY, SOCKS, SHIRTS, T-SHIRTS (U.S. CLS.
22 AND 39).

FIRST USE 8-1-2004; IN COMMERCE 8-1-2006.

3,177,909. FIORE, ANTHONY R., LONG VALLEY, NJ. SN 78-
452,024. PUB. 6-21-2005, FILED 7-16-2004.

DIE-TAN

THE MARK CONSISTS OF STANDARD CHARACTERS
WITHOUT CLAIM TO ANY PARTICULAR FONT, STYLE,
SIZE, OR COLOR.

SEC. 2(F).

FOR CLOTHING, NAMELY; T-SHIRTS, SWEAT-
SHIRTS, HATS, SHORTS, PANTS AND BATHING SUITS
(U.S. CLS. 22 AND 39).

FIRST USE 12-31-1993; IN COMMERCE 12-31-1993.

3,177,914. BURNS, STANTON I., ANTIOCH, CA. SN 78-
454,012. PUB. 12-13-2005, FILED 7-21-2004.

MOTO SHMO

THE MARK CONSISTS OF STANDARD CHARACTERS
WITHOUT CLAIM TO ANY PARTICULAR FONT, STYLE,
SIZE, OR COLOR.

THE ENGLISH TRANSLATION OF THE WORD MOTO IN
THE MARK IS MOTORCYCLE.

FOR CLOTHING, NAMELY, T-SHIRTS, HATS,
SHORTS AND SWEATSHIRTS (U.S. CLS. 22 AND 39).

FIRST USE 10-1-2004; IN COMMERCE 10-1-2004.

CLASS 25—(Continued).

3,177,992. WEISSMAN'S THEATRICAL SUPPLIES, INC., ST. LOUIS, MO. SN 78-479,959. PUB. 12-27-2005, FILED 9-8-2004.



FOR CHILDREN'S BALLET AND DANCE COSTUMES, DRESS-UP COSTUMES SOLD EXCLUSIVELY AT DANCE AND COSTUME SPECIALTY STORES, CATALOGUES, TOY DEPARTMENTS, TOY STORES, ICE SKATING RINKS, DANCE STUDIOS, SKATING RINKS, AND PARKS AND RECREATIONAL FACILITIES (U.S. CLS. 22 AND 39).

FIRST USE 7-28-2004; IN COMMERCE 7-28-2004.

3,178,023. ARAI, KYLE K., KAHULUI, HI. SN 78-493,422. PUB. 9-13-2005, FILED 10-1-2004.

DASYHARD

THE MARK CONSISTS OF STANDARD CHARACTERS WITHOUT CLAIM TO ANY PARTICULAR FONT, STYLE, SIZE, OR COLOR.

FOR CLOTHING, NAMELY T-SHIRTS, SWEATSHIRTS, SHORTS, JACKETS, PAJAMAS, SWIM SUITS, SKIRTS, TANK TOPS, PANTS, COATS, SWEATERS, SOCKS AND BELTS, FOOTWEARS AND HEADWEAR (U.S. CLS. 22 AND 39).

FIRST USE 11-20-2004; IN COMMERCE 11-20-2004.

CLASS 25—(Continued).

3,178,025. EVERGREEN INTERNATIONAL GROUP, LLC, LOS ANGELES, CA. SN 78-494,999. PUB. 9-13-2005, FILED 10-5-2004.

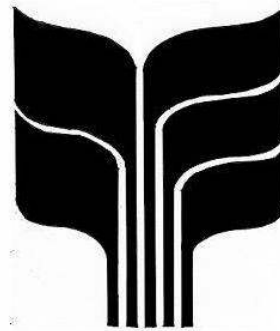

THE MARK CONSISTS OF LOGO DESIGN. FOR FOOTWEAR (U.S. CLS. 22 AND 39). FIRST USE 3-1-2005; IN COMMERCE 3-1-2005.

3,178,041. CHOI, YUN JUN, SEOUL, REPUBLIC OF KOREA. SN 78-504,553. PUB. 10-4-2005, FILED 10-22-2004.



OWNER OF U.S. REG. NO. 2,932,092. FOR LEATHER SHOES, SHOES, HALF-BOOTS, SANDALS, TRAINING SHOES, OVERCOATS, KNEE TROUSERS, HALF-COATS, BLOUSONS, SAFARI SUITS, SKIRTS, SLACKS, ONE PIECE SUITS, EVENING DRESSES, JACKETS, JUMPERS, BLUE JEANS, TWO PIECE SUITS, PARKAS, ALOHA SHIRTS, BLOUSES, SWIMSUITS, BATHING TRUNKS, SWEATERS, SWEAT SHIRTS, SWEAT PANTS, WHITE SHIRTS, NIGHTWEAR, PAJAMAS, POLO SHIRTS, PULLOVERS T-SHIRTS, CAPS AND HATS (U.S. CLS. 22 AND 39).

FIRST USE 2-10-2004; IN COMMERCE 12-1-2005.

CLASS 25—(Continued).

3,178,051. WOODS, NANCY ELIZABETH SANDAU, PORT ANGELES, WA. SN 78-508,352. PUB. 6-13-2006, FILED 10-29-2004.

CLASS 25—(Continued).

3,178,102. ASCOT, LLC, BALTIMORE, MD. SN 78-533,007. PUB. 11-8-2005, FILED 12-15-2004.

I'M NOT SPOILED,
I'M LOVED A LOT

THE MARK CONSISTS OF STANDARD CHARACTERS WITHOUT CLAIM TO ANY PARTICULAR FONT, STYLE, SIZE, OR COLOR.

FOR CLOTHING ARTICLES FOR MEN AND WOMEN, NAMELY SLEEPWEAR, T-SHIRTS, SWEATSHIRTS, HATS AND SCARVES, AND CLOTHING ARTICLES FOR CHILDREN, NAMELY SLEEPWEAR, T-SHIRTS, SWEATSHIRTS, BIB OVERALLS, COATS, HATS, SCARVES AND GLOVES (U.S. CLS. 22 AND 39).

FIRST USE 5-4-2006; IN COMMERCE 5-4-2006.

BELLO UOMO

THE MARK CONSISTS OF STANDARD CHARACTERS WITHOUT CLAIM TO ANY PARTICULAR FONT, STYLE, SIZE, OR COLOR.

NO CLAIM IS MADE TO THE EXCLUSIVE RIGHT TO USE "UOMO", APART FROM THE MARK AS SHOWN.

THE ENGLISH TRANSLATION OF THE ITALIAN WORD "BELLO UOMO" IN THE MARK IS "HANDSOME MAN".

FOR MEN'S FORMAL WEAR NAMELY, FORMAL SHIRTS AND ACCESSORIES NAMELY, VESTS, CUMMERBUNDS, BOW TIES AND LONG TIES (U.S. CLS. 22 AND 39).

FIRST USE 5-0-2005; IN COMMERCE 5-0-2005.

3,178,083. 1110452 ONTARIO INC., TORONTO, ONTARIO, CANADA. SN 78-523,698. PUB. 1-24-2006, FILED 11-29-2004.

3,178,110. DEMELLO, CHANI C., SEAL BEACH, CA. SN 78-535,660. PUB. 10-11-2005, FILED 12-20-2004.

MARIO TOMEI

THE MARK CONSISTS OF STANDARD CHARACTERS WITHOUT CLAIM TO ANY PARTICULAR FONT, STYLE, SIZE, OR COLOR.

THE NAME(S), PORTRAIT(S), AND/OR SIGNATURE(S) SHOWN IN THE MARK IDENTIFIES MARIO TOMEI, WHOSE CONSENT(S) TO REGISTER IS SUBMITTED.

FOR MEN'S, WOMEN'S AND CHILDREN'S CLOTHING, NAMELY, PANTS, TROUSERS, SHORTS, SHIRTS, TEE-SHIRTS, KNIT TOPS, WOVEN AND KNITTED DRESS SHIRTS AND SPORTS SHIRTS, SWEATERS, BLOUSES, JACKETS, VESTS, COATS, BELTS, TIES, POLOS (U.S. CLS. 22 AND 39).

FIRST USE 1-31-2005; IN COMMERCE 8-31-2005.

Moms On Boards

THE MARK CONSISTS OF STANDARD CHARACTERS WITHOUT CLAIM TO ANY PARTICULAR FONT, STYLE, SIZE, OR COLOR.

FOR SHIRTS, HATS, AND SWEATSHIRTS (U.S. CLS. 22 AND 39).

FIRST USE 11-20-2004; IN COMMERCE 12-20-2004.

CLASS 25—(Continued).

3,178,120. RHODES, VIRGINIA A., FAIRFIELD, AL. SN 78-541,572. PUB. 5-23-2006, FILED 1-4-2005.

CLASS 25—(Continued).

3,178,161. UNDEFEATED, INC., LOS ANGELES, CA. SN 78-559,312. PUB. 5-2-2006, FILED 2-2-2005.

**BIGGER AND BETTER
THAN EVER**

UNDFTD

THE MARK CONSISTS OF STANDARD CHARACTERS WITHOUT CLAIM TO ANY PARTICULAR FONT, STYLE, SIZE, OR COLOR.
FOR CLOTHING, NAMELY T-SHIRTS (U.S. CLS. 22 AND 39).

FIRST USE 10-0-2004; IN COMMERCE 10-0-2004.

THE MARK CONSISTS OF STANDARD CHARACTERS WITHOUT CLAIM TO ANY PARTICULAR FONT, STYLE, SIZE, OR COLOR.

FOR CLOTHING, NAMELY, SHIRTS, T-SHIRTS, FOOTWEAR, HEADWEAR, BASEBALL CAPS, SWEATSHIRTS, SHOES, AND WRIST BANDS (U.S. CLS. 22 AND 39).

FIRST USE 9-11-2003; IN COMMERCE 9-11-2003.

3,178,141. TAVDI, ALEX, LOS ANGELES, CA. SN 78-551,228. PUB. 12-20-2005, FILED 1-20-2005.

3,178,202. MANSFIELD, JOHN, PLACENTIA, CA. SN 78-569,525. PUB. 11-15-2005, FILED 2-17-2005.

INDEPENDENT MINDS

**seek truth observe
nature educate
yourself**

THE MARK CONSISTS OF STANDARD CHARACTERS WITHOUT CLAIM TO ANY PARTICULAR FONT, STYLE, SIZE, OR COLOR.

FOR CLOTHING, NAMELY, TOPS, JACKETS, SHIRTS, SWEATSHIRTS (U.S. CLS. 22 AND 39).

FIRST USE 5-9-2006; IN COMMERCE 5-9-2006.

THE MARK CONSISTS OF STANDARD CHARACTERS WITHOUT CLAIM TO ANY PARTICULAR FONT, STYLE, SIZE, OR COLOR.

FOR CLOTHING AND HEADWEAR, NAMELY T-SHIRTS; HATS; BEANIES; CAPS; WOVEN SHIRTS; KNIT SHIRTS; TANK TOPS (U.S. CLS. 22 AND 39).

FIRST USE 3-1-1999; IN COMMERCE 3-1-1999.

CLASS 25—(Continued).

3,178,206. LINK SNACKS, INC., MINONG, WI. SN 78-570,575. PUB. 11-15-2005, FILED 2-18-2005.

CLASS 25—(Continued).

3,178,226. RAFFLES INTERNATIONAL LIMITED, SINGAPORE, SINGAPORE. SN 78-575,028. PUB. 12-20-2005, FILED 2-25-2005.

**FEED YOUR WILD
SIDE**

RAFFLESAMRITA

THE MARK CONSISTS OF STANDARD CHARACTERS WITHOUT CLAIM TO ANY PARTICULAR FONT, STYLE, SIZE, OR COLOR.

FOR CLOTHING, NAMELY, SHIRTS, HATS, JACKETS, SWEATSHIRTS (U.S. CLS. 22 AND 39).
FIRST USE 5-1-2005; IN COMMERCE 5-1-2005.

THE MARK CONSISTS OF STANDARD CHARACTERS WITHOUT CLAIM TO ANY PARTICULAR FONT, STYLE, SIZE, OR COLOR.

OWNER OF U.S. REG. NOS. 2,960,147 AND 2,971,499.
FOR ARTICLES OF CLOTHING, NAMELY, BATHROBES, DRESSING GOWNS, SHORTS, JACKETS, T-SHIRTS, UNIFORMS; FOOTWEAR, NAMELY BATH SANDALS, BATH SLIPPERS; HEADGEAR, NAMELY, BATHING CAPS, SHOWER CAPS; SPORTS FOOTWEAR; AND SPORTS HEADGEAR, NAMELY, CAPS, HATS, SPORTS HEADBANDS (U.S. CLS. 22 AND 39).
FIRST USE 10-5-2000; IN COMMERCE 10-5-2000.

3,178,212. BE AWESOME, INC., SOUTHLAKE, TX. SN 78-571,645. PUB. 2-7-2006, FILED 2-21-2005.

3,178,252. FLEMINGTON FUR COMPANY, LLC, FLEMINGTON, NJ. SN 78-579,979. PUB. 1-3-2006, FILED 3-4-2005.

BE AWESOME

**Flemington Fur
Exchange**

THE MARK CONSISTS OF STANDARD CHARACTERS WITHOUT CLAIM TO ANY PARTICULAR FONT, STYLE, SIZE, OR COLOR.

FOR HEADWEAR; OUTERWEAR, NAMELY, T-SHIRTS (U.S. CLS. 22 AND 39).
FIRST USE 4-6-2005; IN COMMERCE 4-6-2005.

THE MARK CONSISTS OF STANDARD CHARACTERS WITHOUT CLAIM TO ANY PARTICULAR FONT, STYLE, SIZE, OR COLOR.

OWNER OF U.S. REG. NOS. 1,378,578 AND 1,386,063.
NO CLAIM IS MADE TO THE EXCLUSIVE RIGHT TO USE "FUR", APART FROM THE MARK AS SHOWN.
SEC. 2(F) AS TO "FLEMINGTON FUR".
FOR CLOTHING, NAMELY NEW AND PRE-OWNED FUR COATS, FUR JACKETS, FUR CAPES, FUR PONCHOS, FUR BOAS, FUR HATS, FUR SCARVES, AND FUR STOLES (U.S. CLS. 22 AND 39).
FIRST USE 9-6-2006; IN COMMERCE 9-6-2006.

CLASS 25—(Continued).

3,178,284. SWARTZ, JUDY B., WEST HOLLYWOOD, CA. SN 78-587,844. PUB. 12-6-2005, FILED 3-15-2005.

CLASS 25—(Continued).

3,178,287. THE STEP COMPANY, MARIETTA, GA. SN 78-588,277. PUB. 1-10-2006, FILED 3-16-2005.

GROUP CENTERGY

Judy B

THE MARK CONSISTS OF STANDARD CHARACTERS WITHOUT CLAIM TO ANY PARTICULAR FONT, STYLE, SIZE, OR COLOR.

FOR CLOTHING, NAMELY, T-SHIRTS, SWEAT-SHIRTS, JACKETS, PANTS, AND SHORTS (U.S. CLS. 22 AND 39).

FIRST USE 5-16-2005; IN COMMERCE 5-16-2005.

THE MARK CONSISTS OF STANDARD CHARACTERS WITHOUT CLAIM TO ANY PARTICULAR FONT, STYLE, SIZE, OR COLOR.

FOR CLOTHING, NAMELY SHIRTS, JACKETS, PANTS, SKIRTS, DRESSES, FOOTWEAR, CAPS, BELTS, SWIMSUITS AND SLEEPWEAR (U.S. CLS. 22 AND 39).

FIRST USE 11-12-2005; IN COMMERCE 11-12-2005.

3,178,300. SCOTT APPAREL, INC., PORTER RANCH, CA. SN 78-590,816. PUB. 12-13-2005, FILED 3-18-2005.

3,178,286. REDCATS USA, L.P., INDIANAPOLIS, IN. SN 78-588,210. PUB. 12-13-2005, FILED 3-16-2005.

Street Denim

STEP UP COMFORT

THE MARK CONSISTS OF STANDARD CHARACTERS WITHOUT CLAIM TO ANY PARTICULAR FONT, STYLE, SIZE, OR COLOR.

NO CLAIM IS MADE TO THE EXCLUSIVE RIGHT TO USE DENIM, APART FROM THE MARK AS SHOWN.

FOR CLOTHING AND APPAREL, NAMELY DENIM JEANS, SWEATERS, SHIRTS, T-SHIRTS, BLOUSES, DRESSES, SHORTS, PANTS, SKIRTS, JACKETS, AND COATS (U.S. CLS. 22 AND 39).

FIRST USE 6-13-2005; IN COMMERCE 6-13-2005.

THE MARK CONSISTS OF STANDARD CHARACTERS WITHOUT CLAIM TO ANY PARTICULAR FONT, STYLE, SIZE, OR COLOR.

FOR FOOTWEAR (U.S. CLS. 22 AND 39).

FIRST USE 8-23-2006; IN COMMERCE 8-23-2006.

CLASS 25—(Continued).

3,178,324. FRESH JIVE MANUFACTURING, INC., LOS ANGELES, CA. SN 78-594,418. PUB. 12-20-2005, FILED 3-24-2005.



THE MARK CONSISTS OF STANDARD CHARACTERS WITHOUT CLAIM TO ANY PARTICULAR FONT, STYLE, SIZE, OR COLOR.

FOR CLOTHING, NAMELY, SHIRTS, T-SHIRTS, SWEAT SHIRTS, JACKETS, VESTS, PANTS, SHORTS, AND HATS (U.S. CLS. 22 AND 39).

FIRST USE 9-13-2005; IN COMMERCE 9-13-2005.

3,178,361. LAUVER, CARL L., MORRISVILLE, PA. SN 78-600,919. PUB. 12-27-2005, FILED 4-4-2005.

COMBAT ZONE

THE MARK CONSISTS OF STANDARD CHARACTERS WITHOUT CLAIM TO ANY PARTICULAR FONT, STYLE, SIZE, OR COLOR.

FOR T-SHIRTS (U.S. CLS. 22 AND 39).

FIRST USE 12-1-2005; IN COMMERCE 12-1-2005.

3,178,369. SCOTTBAILEY & ASSOCIATES, INC., SAN CLEMENTE, CA. SN 78-603,012. PUB. 1-10-2006, FILED 4-6-2005.

holy-threads

FOR SHIRTS, DRESSES (U.S. CLS. 22 AND 39).
FIRST USE 4-1-2006; IN COMMERCE 4-1-2006.

CLASS 25—(Continued).

3,178,389. PHILLIPS, ROBERT NIGEL, BURBANK, CA. SN 78-611,074. PUB. 1-10-2006, FILED 4-18-2005.



FOR HATS, CAPS, JACKETS, PANTS, SWEAT PANTS, SHORTS, SWEAT SHIRTS, SHIRTS, T-SHIRTS, TANK TOPS, JERSEYS, BELTS, SOCKS, UNDERWEAR, ATHLETIC SHOES, HEADBANDS, WRISTBANDS, GLOVES, AND SLEEP WEAR (U.S. CLS. 22 AND 39).

FIRST USE 11-1-2001; IN COMMERCE 3-1-2006.

3,178,400. PHILLIPS, ROBERT NIGEL, BURBANK, CA. SN 78-614,783. PUB. 1-10-2006, FILED 4-22-2005.



FOR HATS, CAPS, JACKETS, PANTS, SWEAT PANTS, SWEAT SHIRTS, SHIRTS, T-SHIRTS, TANK TOPS, JERSEYS, BELTS, SOCKS, UNDERWEAR, ATHLETIC SHOES, HEADBANDS, WRISTBANDS, GLOVES, AND SLEEP WEAR (U.S. CLS. 22 AND 39).

FIRST USE 11-1-2001; IN COMMERCE 3-1-2006.

3,178,410. MARK LEMP FOOTWEAR, ST. LOUIS, MO. SN 78-619,894. PUB. 1-31-2006, FILED 4-29-2005.

DELLA ROSA

THE MARK CONSISTS OF STANDARD CHARACTERS WITHOUT CLAIM TO ANY PARTICULAR FONT, STYLE, SIZE, OR COLOR.

THE ENGLISH TRANSLATION OF "DELLA ROSA" IS "OF THE ROSE".

FOR FOOTWEAR (U.S. CLS. 22 AND 39).
FIRST USE 5-0-2006; IN COMMERCE 5-0-2006.

CLASS 25—(Continued).

3,178,411. MARK LEMP FOOTWEAR, ST. LOUIS, MO. SN 78-619,905. PUB. 1-31-2006, FILED 4-29-2005.

LADY ROSE

THE MARK CONSISTS OF STANDARD CHARACTERS WITHOUT CLAIM TO ANY PARTICULAR FONT, STYLE, SIZE, OR COLOR.

THE NAME IN THE MARK DOES NOT IDENTIFY A LIVING INDIVIDUAL.

FOR FOOTWEAR (U.S. CLS. 22 AND 39).
FIRST USE 5-0-2006; IN COMMERCE 5-0-2006.

3,178,419. OPERATION BASS, INC. BENTON, KY. SN 78-623,013. PUB. 3-31-2006, FILED 5-4-2005.

FLW OUTDOORS TOURNAMENT
QUALITY GEAR

THE MARK CONSISTS OF STANDARD CHARACTERS WITHOUT CLAIM TO ANY PARTICULAR FONT, STYLE, SIZE, OR COLOR.

OWNER OF U.S. REG. NOS. 2,885,003, 2,918,068, AND OTHERS.

NO CLAIM IS MADE TO THE EXCLUSIVE RIGHT TO USE "OUTDOORS TOURNAMENT QUALITY GEAR", APART FROM THE MARK AS SHOWN.

FOR CLOTHING ITEMS AND ACCESSORIES, NAMELY, JACKETS, T-SHIRTS AND SHORTS; OUTERWEAR, NAMELY, JACKETS AND PANTS (U.S. CLS. 22 AND 39).

FIRST USE 6-1-2006; IN COMMERCE 6-1-2006.

3,178,449. NEVERCASHED, IMPERIAL, CA. SN 78-634,102. PUB. 1-31-2006, FILED 5-20-2005.

NEVERCASHED

THE MARK CONSISTS OF STANDARD CHARACTERS WITHOUT CLAIM TO ANY PARTICULAR FONT, STYLE, SIZE, OR COLOR.

FOR CLOTHING, NAMELY, T-SHIRTS, HATS, PANTS, AND SHORTS (U.S. CLS. 22 AND 39).

FIRST USE 7-1-2001; IN COMMERCE 10-15-2004.

CLASS 25—(Continued).

3,178,468. WARNACO U.S., INC., MILFORD, CT. SN 78-641,994. PUB. 2-28-2006, FILED 6-2-2005.

SUDDENLY SLIM

THE MARK CONSISTS OF STANDARD CHARACTERS WITHOUT CLAIM TO ANY PARTICULAR FONT, STYLE, SIZE, OR COLOR.

OWNER OF U.S. REG. NO. 726,021.

FOR CLOTHING, NAMELY, SWIMWEAR, BEACHWEAR, BATHING SUITS AND COVER-UPS (U.S. CLS. 22 AND 39).

FIRST USE 1-31-2006; IN COMMERCE 1-31-2006.

3,178,476. PENTA GROUP LTD., NEW YORK, NY. SN 78-647,073. PUB. 2-28-2006, FILED 6-9-2005.

Vesti V

THE MARK CONSISTS OF STANDARD CHARACTERS WITHOUT CLAIM TO ANY PARTICULAR FONT, STYLE, SIZE, OR COLOR.

FOR WOMEN'S SPORTSWEAR NAMELY JACKETS, PANTS, BLOUSES, SKIRTS, AND DRESSES (U.S. CLS. 22 AND 39).

FIRST USE 6-30-2005; IN COMMERCE 6-30-2005.

3,178,484. CANTU ELLEBY, MARGARITA, GARZA GARCIA, MEXICO. SN 78-649,652. PUB. 5-2-2006, FILED 6-13-2005.

OMORIKA

THE MARK CONSISTS OF STANDARD CHARACTERS WITHOUT CLAIM TO ANY PARTICULAR FONT, STYLE, SIZE, OR COLOR.

THE FOREIGN WORDING IN THE MARK TRANSLATES INTO ENGLISH AS SERBIAN SPRUCE OR CHRISTMAS TREE.

FOR WOMEN'S, NAMELY, JACKETS, DRESSES, SKIRTS, BLOUSES, SLACKS, JEANS, SHORTS (U.S. CLS. 22 AND 39).

FIRST USE 11-22-2005; IN COMMERCE 11-22-2005.

CLASS 25—(Continued).

3,178,520. WASILEWSKI, DAVID, ATLANTA, GA. SN 78-662,167. PUB. 3-14-2006, FILED 6-30-2005.

ASSETS

THE MARK CONSISTS OF STANDARD CHARACTERS WITHOUT CLAIM TO ANY PARTICULAR FONT, STYLE, SIZE, OR COLOR.

FOR MEN'S AND WOMEN'S APPAREL, NAMELY, SHORTS, T-SHIRTS, HOSIERY, BODY SHAPERS, PANTYHOSE, BRAS AND SLEEPWEAR (U.S. CLS. 22 AND 39).

FIRST USE 7-21-2005; IN COMMERCE 7-21-2005.

3,178,521. BRANT, STACIE L., SPRING, TX. SN 78-662,730. PUB. 3-28-2006, FILED 7-1-2005.

THE NOTORIOUS P.U.G.

THE MARK CONSISTS OF STANDARD CHARACTERS WITHOUT CLAIM TO ANY PARTICULAR FONT, STYLE, SIZE, OR COLOR.

NO CLAIM IS MADE TO THE EXCLUSIVE RIGHT TO USE "PUG", APART FROM THE MARK AS SHOWN.

FOR CLOTHING, NAMELY T-SHIRTS (U.S. CLS. 22 AND 39).

FIRST USE 7-31-2005; IN COMMERCE 7-31-2005.

CLASS 25—(Continued).

3,178,546. NBA DEVELOPMENT LEAGUE, LLC, SECAUCUS, NJ. SN 78-673,320. PUB. 3-28-2006, FILED 7-19-2005.



THE MARK CONSISTS OF A SILHOUETTE OF A BASKETBALL PLAYER WITH A BASKETBALL IN HAND.

FOR CLOTHING, NAMELY HOSIERY, FOOTWEAR, BASKETBALL SHOES, BASKETBALL SNEAKERS, T-SHIRTS, SHIRTS, POLO SHIRTS, SWEATSHIRTS, SWEATPANTS, PANTS, TANK TOPS, JERSEYS, SHORTS, PAJAMAS, SPORT SHIRTS, RUGBY SHIRTS, SWEATERS, BELTS, TIES, NIGHTSHIRTS, HATS, CAPS, VISORS, WARM-UP SUITS, WARM-UP PANTS, WARM-UP TOPS/SHOOTING SHIRTS, JACKETS, WIND RESISTANT JACKETS, PARKAS, COATS, BABY BIBS NOT OF PAPER, HEAD BANDS, WRIST BANDS, APRONS, UNDERGARMENTS, BOXER SHORTS, SLACKS, EAR MUFFS, GLOVES, MITTENS, SCARVES, WOVEN AND KNIT SHIRTS, JERSEY DRESSES, DRESSES, CHEERLEADING DRESSES AND UNIFORMS, SWIM WEAR, BATHING SUITS, SWIMSUITS, BIKINIS, TANKINIS, SWIM TRUNKS, BATHING TRUNKS, BOARD SHORTS, WET SUITS, BEACH COVER-UPS, BATHING SUIT COVER-UPS, BATHING SUIT WRAPS, SANDALS, BEACH SANDALS, BEACH HATS, SUN VISORS, SWIM CAPS, BATHING CAPS, NOVELTY HEADWEAR WITH ATTACHED WIGS (U.S. CLS. 22 AND 39).

FIRST USE 8-1-2006; IN COMMERCE 8-1-2006.

3,178,547. UNDER ARMOUR, INC., BALTIMORE, MD. SN 78-674,048. PUB. 12-27-2005, FILED 7-20-2005.



OWNER OF U.S. REG. NOS. 2,509,632, 2,727,031, AND 2,951,069.

FOR FOOTWEAR (U.S. CLS. 22 AND 39).

FIRST USE 4-24-2006; IN COMMERCE 4-24-2006.

CLASS 25—(Continued).

3,178,548. UNDER ARMOUR, INC., BALTIMORE, MD. SN 78-674,051. PUB. 12-27-2005, FILED 7-20-2005.



OWNER OF U.S. REG. NOS. 2,509,632, 2,727,031, AND 2,951,069.
FOR FOOTWEAR (U.S. CLS. 22 AND 39).
FIRST USE 4-24-2006; IN COMMERCE 4-24-2006.

3,178,549. UNDER ARMOUR, INC., BALTIMORE, MD. SN 78-674,053. PUB. 12-27-2005, FILED 7-20-2005.

UNDER ARMOUR

THE MARK CONSISTS OF STANDARD CHARACTERS WITHOUT CLAIM TO ANY PARTICULAR FONT, STYLE, SIZE, OR COLOR.

OWNER OF U.S. REG. NOS. 2,279,668, 2,954,369, AND OTHERS.

FOR ATHLETIC FOOTWEAR (U.S. CLS. 22 AND 39).
FIRST USE 4-24-2006; IN COMMERCE 4-24-2006.

3,178,556. NATIONAL ASSOCIATION OF MUSIC MERCHANTS, INC., CARLSBAD, CA. SN 78-676,314. PUB. 4-25-2006, FILED 7-22-2005.

The Music Edge Fastest
Drummer

THE MARK CONSISTS OF STANDARD CHARACTERS WITHOUT CLAIM TO ANY PARTICULAR FONT, STYLE, SIZE, OR COLOR.

FOR CLOTHING, NAMELY, HATS, CAPS, BANDANAS, T-SHIRTS, SWEATSHIRTS, SHIRTS, AND JACKETS (U.S. CLS. 22 AND 39).

FIRST USE 7-14-2006; IN COMMERCE 7-14-2006.

CLASS 25—(Continued).

3,178,594. REAL INDIGO, LLC, CHARLOTTE, NC. SN 78-703,080. PUB. 5-23-2006, FILED 8-30-2005.

[deener]

FOR CLOTHING, NAMELY, BOTTOMS, NAMELY DENIM JEANS AND SKIRTS; TOPS, NAMELY, SHIRTS, BLOUSES, AND T-SHIRTS; OUTERWEAR, NAMELY JACKETS ALL FOR MEN, WOMEN AND CHILDREN (U.S. CLS. 22 AND 39).

FIRST USE 7-15-2006; IN COMMERCE 7-15-2006.

3,178,595. REAL INDIGO, LLC, CHARLOTTE, NC. SN 78-703,083. PUB. 5-23-2006, FILED 8-30-2005.



FOR CLOTHING, NAMELY, BOTTOMS, NAMELY DENIM JEANS AND SKIRTS; TOPS, NAMELY, SHIRTS, BLOUSES, AND T-SHIRTS; OUTERWEAR, NAMELY JACKETS ALL FOR MEN, WOMEN AND CHILDREN (U.S. CLS. 22 AND 39).

FIRST USE 7-15-2006; IN COMMERCE 7-15-2006.

3,178,627. SU, RONG, NEW YORK, NY. SN 78-717,600. PUB. 6-6-2006, FILED 9-21-2005.

AFTER THE RAIN

THE MARK CONSISTS OF STANDARD CHARACTERS WITHOUT CLAIM TO ANY PARTICULAR FONT, STYLE, SIZE, OR COLOR.

FOR BLOUSES; DENIMS; DRESS SHIRTS; HEAVY JACKETS; JACKETS; JOGGING PANTS; LEATHER JACKETS; PANTS; SHIRTS; SHIRTS FOR SUITS; SHORT-SLEEVED SHIRTS; SKIRTS; SKIRTS AND DRESSES; SLEEP SHIRTS; SOCKS; SPORTS SHIRTS; SWEAT PANTS; SWEAT SHIRTS; SWEATERS; T-SHIRTS; UNDERWEAR (U.S. CLS. 22 AND 39).

FIRST USE 7-30-2006; IN COMMERCE 7-30-2006.

CLASS 25—(Continued).

3,178,628. DISGUISE, INC., POWAY, CA. SN 78-717,806. PUB. 6-13-2006, FILED 9-21-2005.

SOUL STALKERS

THE MARK CONSISTS OF STANDARD CHARACTERS WITHOUT CLAIM TO ANY PARTICULAR FONT, STYLE, SIZE, OR COLOR.

FOR HALLOWEEN AND MASQUERADE COSTUMES, AND MASKS SOLD IN CONNECTION THEREWITH (U.S. CLS. 22 AND 39).

FIRST USE 8-14-2006; IN COMMERCE 8-15-2006.

3,178,638. SPERBER, JOSHUA D., BERKELEY, CA. AND MANDEL, LEV L., BERKELEY, CA. SN 78-725,724. PUB. 6-20-2006, FILED 10-3-2005.

dickrich

THE MARK CONSISTS OF STANDARD CHARACTERS WITHOUT CLAIM TO ANY PARTICULAR FONT, STYLE, SIZE, OR COLOR.

FOR HEADWEAR, T-SHIRTS (U.S. CLS. 22 AND 39).

FIRST USE 12-10-2005; IN COMMERCE 3-29-2006.

3,178,657. FEDERAL CARTRIDGE COMPANY, ANOKA, MN. SN 78-976,464. PUB. 1-18-2005, FILED 10-14-2003.



FOR CLOTHING, NAMELY HATS, T-SHIRTS, POLO SHIRTS, CAPS, VISORS, JACKETS, SWEATSHIRTS, BANDANAS, HUNTING VESTS, AND HUNTING COATS (U.S. CLS. 22 AND 39).

FIRST USE 1-1-2003; IN COMMERCE 1-1-2003.

CLASS 25—(Continued).

3,178,662. AQUARIUS RAGS, LLC, LOS ANGELES, CA. SN 78-977,500. PUB. 11-29-2005, FILED 7-18-2004.

ALLEN B. ALLEN SCHWARTZ

THE MARK CONSISTS OF STANDARD CHARACTERS WITHOUT CLAIM TO ANY PARTICULAR FONT, STYLE, SIZE, OR COLOR.

OWNER OF U.S. REG. NOS. 2,479,522, 2,686,864, AND OTHERS.

THE NAME IN THE MARK IDENTIFIES A LIVING INDIVIDUAL WHOSE CONSENT IS OF RECORD.

FOR CLOTHING, FOOTWEAR AND HEADGEAR FOR MEN, WOMEN AND CHILDREN, NAMELY, DRESSES, BLOUSES, JACKETS, LEGGINGS, PANTS, AND SWEATERS (U.S. CLS. 22 AND 39).

FIRST USE 1-0-2000; IN COMMERCE 1-0-2000.

3,178,663. AQUARIUS RAGS, LLC, LOS ANGELES, CA. SN 78-977,501. PUB. 11-29-2005, FILED 7-18-2004.

ALLEN BY A·B·S

THE MARK CONSISTS OF STANDARD CHARACTERS WITHOUT CLAIM TO ANY PARTICULAR FONT, STYLE, SIZE, OR COLOR.

OWNER OF U.S. REG. NOS. 2,228,025, 2,753,468, AND OTHERS.

THE NAME IN THE MARK IDENTIFIES A LIVING INDIVIDUAL WHOSE CONSENT IS OF RECORD.

FOR CLOTHING, FOOTWEAR AND HEADGEAR FOR MEN, WOMEN AND CHILDREN, NAMELY, BLOUSES, JACKETS, PANTS, AND SWEATERS (U.S. CLS. 22 AND 39).

FIRST USE 1-0-2005; IN COMMERCE 1-0-2005.

3,178,668. NAN YANG FABRIC CO., LTD., AMPHOR KHOAYOI, PETCHABURI PROVINCE, THAILAND. SN 78-977,625. PUB. 12-13-2005, FILED 3-18-2005.

DRI-BALANCE

THE MARK CONSISTS OF STANDARD CHARACTERS WITHOUT CLAIM TO ANY PARTICULAR FONT, STYLE, SIZE, OR COLOR.

FOR CLOTHING, NAMELY, PULLOVERS (U.S. CLS. 22 AND 39).

FIRST USE 12-0-2005; IN COMMERCE 12-0-2005.

CLASS 25—(Continued).

3,178,673. MAJORMAGIC HOLDINGS, LP, COMMERCE, CA.
SN 78-977,664. PUB. 1-10-2006, FILED 4-15-2005.

CLASS 28—(Continued).

3,177,323. MERCURY HOCKEY INCORPORATED, MCKEES
ROCKS, PA. SN 75-434,685. PUB. 7-1-2003, FILED 2-17-1998.

NORTHLAND**DEPARTMENT OF PEACE**

THE MARK CONSISTS OF STANDARD CHARACTERS
WITHOUT CLAIM TO ANY PARTICULAR FONT, STYLE,
SIZE, OR COLOR.

FOR CLOTHING, NAMELY JACKETS, SWEATERS,
SHIRTS, BLOUSES, T-SHIRTS, PANTS, SHORTS, AND
SKIRTS (U.S. CLS. 22 AND 39).

FIRST USE 8-24-2005; IN COMMERCE 8-24-2005.

FOR SPORTS EQUIPMENT, NAMELY, ICE AND NON-
ICE HOCKEY STICKS; HOCKEY STICK SHAFTS AND
BLADES; HOCKEY PROTECTIVE PADS AND GUARDS,
NAMELY, SHOULDER, ARM, ELBOW, CHEST, KNEE,
GROIN AND SHIN PROTECTORS; HOCKEY GLOVES;
ICE SKATES, NON-ICE INLINE ROLLER SKATES;
HOCKEY PUCKS, HOCKEY BALLS; HOCKEY GOAL
NETS; LACROSSE STICKS; LACROSSE STICK HANDLE
AND HEAD; LACROSSE PROTECTIVE PADS AND
GUARDS, NAMELY SHOULDER, ARM AND ELBOW
PROTECTORS; LACROSSE GLOVES; SKIING AND
SNOWBOARDING PROTECTIVE PADS AND GUARDS,
NAMELY, ARM, ELBOW, KNEE AND WRIST PROTEC-
TORS; INLINE ROLLER SKATING PROTECTIVE PADS
AND GUARDS, NAMELY, ARM, ELBOW, KNEE AND
WRIST PROTECTORS (U.S. CLS. 22, 23, 38 AND 50).

FIRST USE 7-24-2006; IN COMMERCE 8-1-2006.

CLASS 26—FANCY GOODS

3,177,345. WARREN, CAROLYN T., CHICAGO, IL. SN 76-
311,099. PUB. 5-13-2003, FILED 9-12-2001.

3,177,349. ALL PRO EXERCISE PRODUCTS, INC., LONG-
BOAT KEY, FL. SN 76-334,634. PUB. 4-25-2006, FILED 11-7-
2001.

DREAD LOCKERS

FOR HAIR ACCESSORIES, NAMELY, TWISTERS FOR
DREADLOCKS (U.S. CLS. 37, 39, 40, 42 AND 50).

FIRST USE 1-0-2006; IN COMMERCE 1-0-2006.

WATER WALKER

NO CLAIM IS MADE TO THE EXCLUSIVE RIGHT TO
USE "WATER", APART FROM THE MARK AS SHOWN.

FOR WEIGHT ADJUSTABLE WATER EXERCISE BELT
WORN DURING A WALKING EXERCISE IN THE POOL
(U.S. CLS. 22, 23, 38 AND 50).

FIRST USE 9-1-2002; IN COMMERCE 9-1-2002.

CLASS 27—FLOOR COVERINGS

3,177,633. KARSTEN MANUFACTURING CORPORATION,
PHOENIX, AZ. SN 78-197,564. PUB. 6-17-2003, FILED 12-23-
2002.

3,177,415. ME, L.L.C., DBA MEG, MANHATTAN BEACH,
CA. SN 76-564,055. PUB. 6-21-2005, FILED 12-8-2003.

PING

OWNER OF U.S. REG. NOS. 704,552, 1,647,448, AND
OTHERS.

FOR RUGS (U.S. CLS. 19, 20, 37, 42 AND 50).

FIRST USE 9-7-2006; IN COMMERCE 9-7-2006.

SCENT STARS

THE MARK CONSISTS OF STANDARD CHARACTERS
WITHOUT CLAIM TO ANY PARTICULAR FONT, STYLE,
SIZE, OR COLOR.

NO CLAIM IS MADE TO THE EXCLUSIVE RIGHT TO
USE "SCENT", APART FROM THE MARK AS SHOWN.

FOR DOLLS (U.S. CLS. 22, 23, 38 AND 50).
FIRST USE 8-1-2004; IN COMMERCE 8-1-2004.

CLASS 28—TOYS AND SPORTING GOODS

CLASS 28—(Continued).

3,177,430. DAIWA SEIKO, INC., HIGASHIKURUME-CITY, TOKYO, JAPAN. SN 76-579,984. PUB. 12-28-2004, FILED 3-8-2004.

D|FORCE

FOR FISHING REELS, FISHING RODS, FISHING LURES, FISHING SINKERS, FISHING FLOATS, FISHING TACKLE BOXES AND FISHING LINES (U.S. CLS. 22, 23, 38 AND 50).

FIRST USE 1-0-2005; IN COMMERCE 1-0-2005.

3,177,468. IMPULSION GOLF, INC., ZEPHYRHILLS, FL. SN 76-608,346. PUB. 11-29-2005, FILED 8-20-2004.

NO-YIP GRIP

THE MARK CONSISTS OF STANDARD CHARACTERS WITHOUT CLAIM TO ANY PARTICULAR FONT, STYLE, SIZE, OR COLOR.

NO CLAIM IS MADE TO THE EXCLUSIVE RIGHT TO USE GRIP, APART FROM THE MARK AS SHOWN.

FOR GOLF AND GOLF COURSE RELATED ACCESSORIES, NAMELY, GOLF PUTTERS, GOLF CLUB INSERTS, GOLF PUTTER HEADS AND GOLF CLUB HEAD COVERS (U.S. CLS. 22, 23, 38 AND 50).

FIRST USE 8-11-2004; IN COMMERCE 8-11-2004.

3,177,471. HASBRO, INC., PAWTUCKET, RI. SN 76-608,982. PUB. 7-12-2005, FILED 8-27-2004.

SCOUT IX-3

THE MARK CONSISTS OF STANDARD CHARACTERS WITHOUT CLAIM TO ANY PARTICULAR FONT, STYLE, SIZE, OR COLOR.

FOR TOY DART SHOOTERS AND FOAM TOY DARTS FOR USE THEREWITH (U.S. CLS. 22, 23, 38 AND 50).

FIRST USE 7-26-2004; IN COMMERCE 7-26-2004.

CLASS 28—(Continued).

3,177,524. PRECIOUS BABY DOLL COMPANY, LLC, ROCHESTER, MI. SN 76-624,768. PUB. 11-29-2005, FILED 12-17-2004.

Precious Baby

THE MARK CONSISTS OF STANDARD CHARACTERS WITHOUT CLAIM TO ANY PARTICULAR FONT, STYLE, SIZE, OR COLOR.

NO CLAIM IS MADE TO THE EXCLUSIVE RIGHT TO USE "BABY", APART FROM THE MARK AS SHOWN.

FOR DOLLS (U.S. CLS. 22, 23, 38 AND 50).

FIRST USE 8-21-2006; IN COMMERCE 8-21-2006.

3,177,586. DIC ENTERTAINMENT CORPORATION, BURBANK, CA. SN 76-978,152. PUB. 10-4-2005, FILED 9-13-2004.

ONYX VON TROLLENBERG

THE MARK CONSISTS OF STANDARD CHARACTERS WITHOUT CLAIM TO ANY PARTICULAR FONT, STYLE, SIZE, OR COLOR.

THE NAME IN THE MARK DOES NOT IDENTIFY A LIVING INDIVIDUAL.

FOR DOLLS, DOLL CLOTHING, DOLL ACCESSORIES, SWIMMING AIDS, NAMELY, POOL RINGS AND ARM FLOATS FOR RECREATIONAL USE (U.S. CLS. 22, 23, 38 AND 50).

FIRST USE 8-0-2005; IN COMMERCE 9-0-2005.

3,177,626. PURSUIT MARKETING, INC., DES PLAINES, IL. SN 78-181,477. PUB. 5-20-2003, FILED 11-4-2002.

MINION

FOR PAINTBALL GUNS, PAINTBALLS, AND PAINTBALL EQUIPMENT, NAMELY, PAINTBALL GUN BARRELS, PAINTBALL GUN EXPANSION CHAMBERS, NON-TELESCOPIC PAINTBALL GUN SIGHTS, PAINTBALL GUN BARREL PLUGS AND PAINTBALL FILLER ADAPTERS (U.S. CLS. 22, 23, 38 AND 50).

FIRST USE 5-21-2006; IN COMMERCE 5-21-2006.

3,177,664. TRUE TEMPER SPORTS, INC., MEMPHIS, TN. SN 78-275,622. PUB. 5-25-2004, FILED 7-17-2003.

PRECISION SABER

OWNER OF U.S. REG. NOS. 2,303,575, 2,632,654, AND OTHERS.

FOR GOLF CLUB SHAFTS (U.S. CLS. 22, 23, 38 AND 50).

FIRST USE 12-31-2003; IN COMMERCE 12-31-2003.

CLASS 28—(Continued).

3,177,707. KARSTEN MANUFACTURING CORPORATION, PHOENIX, AZ. SN 78-327,332. PUB. 9-21-2004, FILED 11-13-2003.

CLASS 28—(Continued).

3,177,754. SCHUS, STEPHANIE, GLENDALE, CA. AND NELSON, MARLA, GLENDALE, CA. SN 78-366,630. PUB. 12-21-2004, FILED 2-11-2004.

WRX

FLUZZIES

THE MARK CONSISTS OF STANDARD CHARACTERS WITHOUT CLAIM TO ANY PARTICULAR FONT, STYLE, SIZE, OR COLOR.
FOR GOLF CLUBS (U.S. CLS. 22, 23, 38 AND 50).
FIRST USE 8-30-2006; IN COMMERCE 8-30-2006.

THE MARK CONSISTS OF STANDARD CHARACTERS WITHOUT CLAIM TO ANY PARTICULAR FONT, STYLE, SIZE, OR COLOR.

FOR PLAYTHINGS, NAMELY, PLUSH TOYS AND CLOTHING ACCESSORIES THEREFOR (U.S. CLS. 22, 23, 38 AND 50).
FIRST USE 3-10-2006; IN COMMERCE 8-14-2006.

3,177,720. MATTEL, INC., EL SEGUNDO, CA. SN 78-344,726. PUB. 5-24-2005, FILED 12-23-2003.

3,177,755. CHIH AN INTERNATIONAL, INC., CITY OF INDUSTRY, CA. SN 78-366,777. PUB. 11-16-2004, FILED 2-12-2004.

CAFFIEND

GODDESS

THE MARK CONSISTS OF STANDARD CHARACTERS WITHOUT CLAIM TO ANY PARTICULAR FONT, STYLE, SIZE, OR COLOR.

FOR TOYS, GAMES AND PLAYTHINGS, NAMELY, TOY VEHICLES AND ACCESSORIES THEREFOR (U.S. CLS. 22, 23, 38 AND 50).
FIRST USE 6-28-2006; IN COMMERCE 6-28-2006.

THE MARK CONSISTS OF STANDARD CHARACTERS WITHOUT CLAIM TO ANY PARTICULAR FONT, STYLE, SIZE, OR COLOR.

FOR GOLF CLUBS (U.S. CLS. 22, 23, 38 AND 50).
FIRST USE 6-28-2004; IN COMMERCE 6-28-2004.

CLASS 28—(Continued).

3,177,764. MATTEL, INC., EL SEGUNDO, CA. SN 78-374,001.
PUB. 7-12-2005, FILED 2-25-2004.

G MACHINES

THE MARK CONSISTS OF STANDARD CHARACTERS WITHOUT CLAIM TO ANY PARTICULAR FONT, STYLE, SIZE, OR COLOR.

FOR TOYS, GAMES AND PLAYTHINGS, NAMELY, TOY VEHICLES AND ACCESSORIES THEREFOR (U.S. CLS. 22, 23, 38 AND 50).

FIRST USE 12-12-2005; IN COMMERCE 12-12-2005.

3,177,775. WORLD WRESTLING ENTERTAINMENT, INC., STAMFORD, CT. SN 78-386,079. PUB. 12-27-2005, FILED 3-17-2004.

ROB VAN DAM

THE MARK CONSISTS OF STANDARD CHARACTERS WITHOUT CLAIM TO ANY PARTICULAR FONT, STYLE, SIZE, OR COLOR.

OWNER OF U.S. REG. NO. 2,739,105.

THE NAME SHOWN IN THE MARK IDENTIFIES ROBERT SZATFOWSKI, WHOSE CONSENT IS OF RECORD.

FOR TOY ACTION FIGURES AND ACCESSORIES THEREFOR; CASES FOR ACTION FIGURES; TOY VEHICLES; BOARD GAMES; PLAYING CARDS; TOY SPINNING TOPS; STAND ALONE VIDEO OUTPUT GAME MACHINES FEATURING WRESTLING; ARCADE GAMES RELATED TO WRESTLING; PINBALL GAMES RELATED TO WRESTLING; HAND-HELD UNITS FOR PLAYING ELECTRONIC GAME; TABLETOP ACTION SKILL GAMES RELATED TO WRESTLING; JIGSAW PUZZLES; KITES; TOY WRESTLING RINGS; DOLLS; PUPPETS; STUFFED TOY ANIMALS; CARD GAMES; TOY GUITARS; WATER GUNS; CHRISTMAS TREE DECORATIONS; COSTUME MASKS; TOY BELTS, DOLL FURNITURE; PARTY FAVORS IN THE NATURE OF CRACKERS AND NOISEMAKERS; SKATEBOARDS; BOWLING BALLS AND ACCESSORIES, NAMELY, BOWLING GLOVES, WRIST SUPPORTS, BOWLING BALL BAGS; WINDUP TOYS; TOY SCOOTERS; BOWLING PINS; KNEE AND ELBOW PADS FOR ATHLETIC USE; YO-YO'S; PLASTIC MODEL KITS FOR MAKING TOY VEHICLES; POOL CUES; NOVELTY TOYS, NAMELY, TOY BANKS MADE OF TIN; TOY GUM MACHINES; TOY CANDY BOWL MECHANICAL DISPENSERS; TOY STICK GUM DISPENSERS; TOY GUM FIGURE MAKERS; CONFETTI (U.S. CLS. 22, 23, 38 AND 50).

FIRST USE 1-31-2002; IN COMMERCE 1-31-2002.

CLASS 28—(Continued).

3,177,776. WORLD WRESTLING ENTERTAINMENT, INC., STAMFORD, CT. SN 78-386,119. PUB. 12-27-2005, FILED 3-17-2004.

RVD

THE MARK CONSISTS OF STANDARD CHARACTERS WITHOUT CLAIM TO ANY PARTICULAR FONT, STYLE, SIZE, OR COLOR.

OWNER OF U.S. REG. NO. 2,735,677.

FOR TOY ACTION FIGURES AND ACCESSORIES THEREFOR; CASES FOR ACTION FIGURES; TOY VEHICLES; BOARD GAMES; PLAYING CARDS; TOY SPINNING TOPS; STAND ALONE VIDEO OUTPUT GAME MACHINES FEATURING WRESTLING; ARCADE GAMES RELATED TO WRESTLING; PINBALL GAMES RELATED TO WRESTLING; HAND-HELD UNITS FOR PLAYING ELECTRONIC GAME; TABLETOP ACTION SKILL GAMES RELATED TO WRESTLING; JIGSAW PUZZLES; KITES; TOY WRESTLING RINGS; DOLLS; PUPPETS; STUFFED TOY ANIMALS; CARD GAMES; TOY GUITARS; WATER GUNS; INFLATABLE INNER TUBES FOR AQUATIC RECREATIONAL USE; AND FOOT PUMPS FOR INFLATING SPORTS OR RECREATIONAL EQUIPMENT; CHRISTMAS TREE DECORATIONS; COSTUME MASKS; TOY BELTS, DOLL FURNITURE; PARTY FAVORS IN THE NATURE OF CRACKERS AND NOISEMAKERS; SKATEBOARDS; BOWLING BALLS AND ACCESSORIES, NAMELY, BOWLING GLOVES, WRIST SUPPORTS, BOWLING BALL BAGS; WINDUP TOYS; TOY SCOOTERS; BOWLING PINS; KNEE AND ELBOW PADS FOR ATHLETIC USE; YO-YO'S; PLASTIC MODEL KITS FOR MAKING TOY VEHICLES; POOL CUES; NOVELTY TOYS, NAMELY, TOY BANKS MADE OF TIN; TOY GUM MACHINES; TOY CANDY BOWL MECHANICAL DISPENSERS; TOY STICK GUM DISPENSERS; TOY GUM FIGURE MAKERS; CONFETTI (U.S. CLS. 22, 23, 38 AND 50).

FIRST USE 1-31-2002; IN COMMERCE 1-31-2002.

3,177,804. FABRIC EDITIONS LLC, FORMERLY FE ACQUISITION LLC, GREENVILLE, SC. SN 78-400,764. PUB. 6-28-2005, FILED 4-13-2004.

QUILT
Simply!

NO CLAIM IS MADE TO THE EXCLUSIVE RIGHT TO

CLASS 28—(Continued).

USE "QUILT", APART FROM THE MARK AS SHOWN.
 THE STIPPLING IS A FEATURE OF THE MARK.
 THE MARK CONSISTS OF THE WORDS "QUILT SIMPLY!" AND DESIGN.
 FOR HOBBY CRAFT KIT COMPRISED OF FABRIC PATCHWORK PIECES FOR USE IN MAKING QUILTS (U.S. CLS. 22, 23, 38 AND 50).
 FIRST USE 6-1-2004; IN COMMERCE 6-1-2004.

3,177,821. JECKLE, MILAN, SPOKANE, WA. SN 78-409,358.
 PUB. 2-21-2006, FILED 4-28-2004.

FOOL-A-FISH

THE MARK CONSISTS OF STANDARD CHARACTERS WITHOUT CLAIM TO ANY PARTICULAR FONT, STYLE, SIZE, OR COLOR.
 FOR LURES FOR FISHING (U.S. CLS. 22, 23, 38 AND 50).
 FIRST USE 4-28-2004; IN COMMERCE 4-28-2004.

3,177,870. DYRDAHL, LINKE, SEATTLE, WA. SN 78-438,989.
 PUB. 7-26-2005, FILED 6-22-2004.

HUGAWUGS

THE MARK CONSISTS OF STANDARD CHARACTERS WITHOUT CLAIM TO ANY PARTICULAR FONT, STYLE, SIZE, OR COLOR.
 FOR PLUSH TOYS (U.S. CLS. 22, 23, 38 AND 50).
 FIRST USE 2-15-2006; IN COMMERCE 8-15-2006.

3,177,879. RAPPORT SHAFT TECHNOLOGIES, LLC, WEST-FIELD, IN. SN 78-443,075. PUB. 6-7-2005, FILED 6-29-2004.

Pro·jec

FOR GOLF CLUB SHAFTS (U.S. CLS. 22, 23, 38 AND 50).
 FIRST USE 9-10-2004; IN COMMERCE 9-10-2004.

CLASS 28—(Continued).

3,177,887. NATIONAL PAINTBALL SUPPLY, INC., SEWELL, NJ. SN 78-445,534. PUB. 11-29-2005, FILED 7-2-2004.

NITE LOADER

THE MARK CONSISTS OF STANDARD CHARACTERS WITHOUT CLAIM TO ANY PARTICULAR FONT, STYLE, SIZE, OR COLOR.
 NO CLAIM IS MADE TO THE EXCLUSIVE RIGHT TO USE "LOADER", APART FROM THE MARK AS SHOWN.
 FOR PAINTBALL LOADERS (U.S. CLS. 22, 23, 38 AND 50).
 FIRST USE 1-19-2005; IN COMMERCE 1-25-2005.

3,177,916. TATE, JANE D., ALBION, CA. SN 78-456,138. PUB. 9-13-2005, FILED 7-24-2004.

Skruffy P. Bear

THE MARK CONSISTS OF STANDARD CHARACTERS WITHOUT CLAIM TO ANY PARTICULAR FONT, STYLE, SIZE, OR COLOR.
 NO CLAIM IS MADE TO THE EXCLUSIVE RIGHT TO USE "BEAR", APART FROM THE MARK AS SHOWN.
 FOR TOYS, NAMELY, TEDDY BEARS (U.S. CLS. 22, 23, 38 AND 50).
 FIRST USE 8-7-2006; IN COMMERCE 8-7-2006.

CLASS 28—(Continued).

3,177,928. PRINCE LIONHEART, INC., SANTA MARIA, CA.
SN 78-460,336. PUB. 12-13-2005, FILED 8-2-2004.



NO CLAIM IS MADE TO THE EXCLUSIVE RIGHT TO USE "SINCE 2003", APART FROM THE MARK AS SHOWN. THE COLOR(S) RED, WHITE, YELLOW, BLUE, GRAY, AND BLACK IS/ARE CLAIMED AS A FEATURE OF THE MARK.

THE LETTERS RED ARE RED IN COLOR. THE LETTERS ROCKET ARE WHITE IN COLOR. THE LETTERS SINCE 2003 ARE GRAY IN COLOR. THE EXTERIOR RIM OF THE OVAL DESIGN IS RED IN COLOR. THE INTERIOR PORTION OF THE OVAL DESIGN IS BLUE IN COLOR. THE AREA BETWEEN THE RIM AND THE INTERIOR PORTION OF THE OVAL DESIGN IS GRAY IN COLOR. THE ROCKET SHIP IS RED IN COLOR. THE ROCKET FINS AND THE DOG EARS AND NOSE ON THE ROCKET ARE BLACK IN COLOR. THE FUMES EXPELLED BY THE ROCKET AND CIRCLING AROUND THE OVAL DESIGN ARE YELLOW IN COLOR.

FOR PLAY TOYS FOR PET ANIMALS (U.S. CLS. 22, 23, 38 AND 50).

FIRST USE 12-20-2003; IN COMMERCE 8-17-2006.

3,177,945. PARADISE GALLERIES, INC., SAN DIEGO, CA.
SN 78-466,843. PUB. 7-5-2005, FILED 8-12-2004.

TRUE TOUCH

THE MARK CONSISTS OF STANDARD CHARACTERS WITHOUT CLAIM TO ANY PARTICULAR FONT, STYLE, SIZE, OR COLOR.

FOR DOLLS (U.S. CLS. 22, 23, 38 AND 50).
FIRST USE 9-2-2004; IN COMMERCE 9-2-2004.

CLASS 28—(Continued).

3,177,982. BINNEY & SMITH PROPERTIES, INC., EASTON, PA. SN 78-475,733. PUB. 3-14-2006, FILED 8-30-2004.



OWNER OF U.S. REG. NOS. 641,294, 1,279,429, AND OTHERS.

THE MARK CONSISTS OF THE WORD CRAYOLA ABOVE AN INVERTED ARCH, SURROUNDED BY AN OVAL.

FOR CHILDREN'S MULTIPLE ACTIVITY TOYS, FANTASY CHARACTER TOYS (U.S. CLS. 22, 23, 38 AND 50).
FIRST USE 5-31-2003; IN COMMERCE 5-31-2003.

3,178,001. HOBBY PRODUCTS INTERNATIONAL, INC.,
FOOTHILL RANCH, CA. SN 78-484,347. PUB. 12-20-2005,
FILED 9-15-2004.

TRUCKZILLA

THE MARK CONSISTS OF STANDARD CHARACTERS WITHOUT CLAIM TO ANY PARTICULAR FONT, STYLE, SIZE, OR COLOR.

FOR TOYS, NAMELY, REMOTE CONTROLLED VEHICLE KITS AND PARTS THEREFORE (U.S. CLS. 22, 23, 38 AND 50).
FIRST USE 5-0-2003; IN COMMERCE 5-0-2003.

CLASS 28—(Continued).

3,178,038. RADIO FLYER INC., CHICAGO, IL. SN 78-502,697.
PUB. 12-13-2005, FILED 10-20-2004.

CLASS 28—(Continued).

3,178,056. MATTEL, INC., EL SEGUNDO, CA. SN 78-509,587.
PUB. 1-10-2006, FILED 11-2-2004.

INNOVATING PLAY
SINCE 1917

CATFIELDS

THE MARK CONSISTS OF STANDARD CHARACTERS
WITHOUT CLAIM TO ANY PARTICULAR FONT, STYLE,
SIZE, OR COLOR.
FOR CHILDREN'S RIDING TOYS (U.S. CLS. 22, 23, 38
AND 50).
FIRST USE 3-31-2005; IN COMMERCE 3-31-2005.

THE MARK CONSISTS OF STANDARD CHARACTERS
WITHOUT CLAIM TO ANY PARTICULAR FONT, STYLE,
SIZE, OR COLOR.
FOR TOYS, GAMES AND PLAYTHINGS, NAMELY,
PLUSH TOYS AND ACCESSORIES THEREFOR (U.S.
CLS. 22, 23, 38 AND 50).
FIRST USE 11-17-2005; IN COMMERCE 11-17-2005.

3,178,044. ARCHON PAINTBALL, INC., GREENVILLE, SC.
SN 78-505,291. PUB. 9-27-2005, FILED 10-25-2004.

3,178,059. MATTEL, INC., EL SEGUNDO, CA. SN 78-511,908.
PUB. 10-11-2005, FILED 11-5-2004.

REVOLT

SHELL SHOCKER

THE MARK CONSISTS OF STANDARD CHARACTERS
WITHOUT CLAIM TO ANY PARTICULAR FONT, STYLE,
SIZE, OR COLOR.
FOR PAINTBALLS (U.S. CLS. 22, 23, 38 AND 50).
FIRST USE 6-29-2004; IN COMMERCE 6-29-2004.

THE MARK CONSISTS OF STANDARD CHARACTERS
WITHOUT CLAIM TO ANY PARTICULAR FONT, STYLE,
SIZE, OR COLOR.
FOR TOYS, GAMES AND PLAYTHINGS, NAMELY,
TRANSFORMING TOY VEHICLES, RADIO-CON-
TROLLED TOY VEHICLES, TOY VEHICLES, TOY FIG-
URES AND ACCESSORIES FOR ALL OF THE
FOREGOING (U.S. CLS. 22, 23, 38 AND 50).
FIRST USE 9-1-2005; IN COMMERCE 9-1-2005.

CLASS 28—(Continued).

3,178,145. MOVING TARGETS, INCORPORATED, NORTH BRANCH, MN. SN 78-552,167. PUB. 12-20-2005, FILED 1-22-2005.

CLASS 28—(Continued).

3,178,152. THREE-D SPIRITS, INC., PETALUMA, CA. SN 78-554,186. PUB. 11-1-2005, FILED 1-26-2005.

Power Thrower

REDRUM

THE MARK CONSISTS OF STANDARD CHARACTERS WITHOUT CLAIM TO ANY PARTICULAR FONT, STYLE, SIZE, OR COLOR.

NO CLAIM IS MADE TO THE EXCLUSIVE RIGHT TO USE THROWER, APART FROM THE MARK AS SHOWN.

FOR TARGET LAUNCHER FOR CLAY PIGEONS (U.S. CLS. 22, 23, 38 AND 50).

FIRST USE 10-1-2005; IN COMMERCE 10-1-2005.

THE MARK CONSISTS OF STANDARD CHARACTERS WITHOUT CLAIM TO ANY PARTICULAR FONT, STYLE, SIZE, OR COLOR.

FOR BOARDS FOR USE IN THE PRACTICE OF SPORTS, NAMELY SKATEBOARDS, WAKE BOARDS, SURF BOARDS, SKIM BOARDS, BODY BOARDS AND SAIL BOARDS; SKATES FOR USE IN THE PRACTICE OF SPORTS, NAMELY SNOW SKATES (U.S. CLS. 22, 23, 38 AND 50).

FIRST USE 6-29-2006; IN COMMERCE 6-29-2006.

3,178,150. DARON WORLDWIDE TRADING INC., FAIRFIELD, NJ. SN 78-553,535. PUB. 11-1-2005, FILED 1-25-2005.

3,178,167. CAMPBELL, SUSAN, ROCKPORT, MA. SN 78-561,320. PUB. 11-1-2005, FILED 2-5-2005.

YOTOP

**Teacher's
Creatures**

THE MARK CONSISTS OF STANDARD CHARACTERS WITHOUT CLAIM TO ANY PARTICULAR FONT, STYLE, SIZE, OR COLOR.

FOR TOYS IN THE NATURE OF A COMBINATION YO-YO AND SPINNING TOP (U.S. CLS. 22, 23, 38 AND 50).

FIRST USE 4-0-2005; IN COMMERCE 4-0-2005.

THE MARK CONSISTS OF STANDARD CHARACTERS WITHOUT CLAIM TO ANY PARTICULAR FONT, STYLE, SIZE, OR COLOR.

FOR FULL LINE OF PET TOYS (U.S. CLS. 22, 23, 38 AND 50).

FIRST USE 3-23-2006; IN COMMERCE 3-23-2006.

CLASS 28—(Continued).

3,178,184. TAYLOR BRANDS, LLC, KINGSPORT, TN. SN 78-565,853. PUB. 11-8-2005, FILED 2-11-2005.

OLD TIMER

THE MARK CONSISTS OF STANDARD CHARACTERS WITHOUT CLAIM TO ANY PARTICULAR FONT, STYLE, SIZE, OR COLOR.

FOR FISHING TACKLE, FISHING LURES, FISHING TACKLE BOXES, REELS, RODS, SINKERS, WEIGHTS (U.S. CLS. 22, 23, 38 AND 50).

FIRST USE 12-31-1958; IN COMMERCE 5-27-2006.

3,178,209. Z-MAN FISHING PRODUCTS, INC., HANAHAN, SC. SN 78-571,428. PUB. 12-20-2005, FILED 2-21-2005.

EZ SKIRT

THE MARK CONSISTS OF STANDARD CHARACTERS WITHOUT CLAIM TO ANY PARTICULAR FONT, STYLE, SIZE, OR COLOR.

NO CLAIM IS MADE TO THE EXCLUSIVE RIGHT TO USE SKIRT, APART FROM THE MARK AS SHOWN.

FOR FISHING LURES, ARTIFICIAL FISHING LURES, LURES FOR FISHING AND FISHING LURE PARTS (U.S. CLS. 22, 23, 38 AND 50).

FIRST USE 5-29-2005; IN COMMERCE 5-29-2005.

CLASS 28—(Continued).

3,178,227. KINGSTATE CORP., NEW YORK, NY. SN 78-575,045. PUB. 11-29-2005, FILED 2-25-2005.

HANNAH

THE MARK CONSISTS OF STANDARD CHARACTERS WITHOUT CLAIM TO ANY PARTICULAR FONT, STYLE, SIZE, OR COLOR.

FOR DOLLS (U.S. CLS. 22, 23, 38 AND 50).

FIRST USE 8-21-2006; IN COMMERCE 8-21-2006.

3,178,290. CORGI CLASSICS LIMITED, LEICESTER, UNITED KINGDOM. SN 78-588,606. PUB. 11-29-2005, FILED 3-16-2005.

Jumpin Jack Fast

THE MARK CONSISTS OF STANDARD CHARACTERS WITHOUT CLAIM TO ANY PARTICULAR FONT, STYLE, SIZE, OR COLOR.

FOR TOYS, NAMELY, TOY VEHICLES AND ACCESSORIES THEREFOR, AND TOY VEHICLE PLAYSETS AND ACCESSORIES THEREFOR (U.S. CLS. 22, 23, 38 AND 50).

FIRST USE 9-0-2005; IN COMMERCE 9-0-2005.

CLASS 28—(Continued).

3,178,340. MAUI TOYS, INC., YOUNGSTOWN, OH. SN 78-596,994. PUB. 12-20-2005, FILED 3-29-2005.

COSMIC HOPPER

THE MARK CONSISTS OF STANDARD CHARACTERS WITHOUT CLAIM TO ANY PARTICULAR FONT, STYLE, SIZE, OR COLOR.

OWNER OF U.S. REG. NO. 2,703,964.

FOR TOYS, NAMELY, STICK WITH A BULB AT ONE END WITH LIGHT-UP BALLS INSIDE THAT IS SPUN AROUND ANKLE ON ONE LEG (U.S. CLS. 22, 23, 38 AND 50).

FIRST USE 3-1-2005; IN COMMERCE 3-1-2005.

3,178,356. KINGSTATE CORP., NEW YORK, NY. SN 78-599,537. PUB. 12-27-2005, FILED 3-31-2005.

SWEET CUTIE

THE MARK CONSISTS OF STANDARD CHARACTERS WITHOUT CLAIM TO ANY PARTICULAR FONT, STYLE, SIZE, OR COLOR.

FOR DOLLS (U.S. CLS. 22, 23, 38 AND 50).

FIRST USE 6-0-2006; IN COMMERCE 6-0-2006.

3,178,391. BATTAT INCORPORATED, PLATTSBURGH, NY. SN 78-611,589. PUB. 6-6-2006, FILED 4-19-2005.

CUDDLE CUBS

THE MARK CONSISTS OF STANDARD CHARACTERS WITHOUT CLAIM TO ANY PARTICULAR FONT, STYLE, SIZE, OR COLOR.

NO CLAIM IS MADE TO THE EXCLUSIVE RIGHT TO USE CUBS, APART FROM THE MARK AS SHOWN.

FOR TOYS, NAMELY BABY DOLLS AND BABY DOLL ACCESSORIES (U.S. CLS. 22, 23, 38 AND 50).

FIRST USE 7-31-2005; IN COMMERCE 7-31-2005.

CLASS 28—(Continued).

3,178,496. B & D SPECIALTY CONCEPTS, INC., SHAKER HEIGHTS, OH. SN 78-656,188. PUB. 2-28-2006, FILED 6-22-2005.

GYMVALET

THE MARK CONSISTS OF STANDARD CHARACTERS WITHOUT CLAIM TO ANY PARTICULAR FONT, STYLE, SIZE, OR COLOR.

FOR FITNESS EQUIPMENT ACCESSORY HOLDER (U.S. CLS. 22, 23, 38 AND 50).

FIRST USE 1-1-2006; IN COMMERCE 1-1-2006.

3,178,499. TOYTRACKERZ LLC, FORT SCOTT, KS. SN 78-657,012. PUB. 3-7-2006, FILED 6-23-2005.

**JOHNNY WEST
ADVENTURE**

NO CLAIM IS MADE TO THE EXCLUSIVE RIGHT TO USE "ADVENTURE", APART FROM THE MARK AS SHOWN.

"JOHNNY WEST" DOES NOT IDENTIFY A REAL PERSON, LIVING OR DEAD.

THE COLOR(S) RED AND BLACK ARE CLAIMED AS A FEATURE OF THE MARK.

THE COLOR RED APPEARS WITHIN THE TEXT AND THE COLOR BLACK APPEARS AS A BORDER ON THE LETTERS.

THE MARK CONSISTS OF RED TEXT IN CAPITAL LETTERS WITH BLACK BORDER ON LETTERS.

FOR COLLECTIBLE ACTION FIGURES AND ACCESSORIES (U.S. CLS. 22, 23, 38 AND 50).

FIRST USE 6-1-2005; IN COMMERCE 6-1-2005.

CLASS 28—(Continued).

3,178,523. NOVATOY, PALO ALTO, CA. SN 78-663,403. PUB. 3-21-2006, FILED 7-4-2005.



THE COLORS WHITE, RED, BLUE, PINK, DEEP VIOLET, YELLOW, GREEN ARE CLAIMED AS A FEATURE OF THE MARK.

THE MARK CONSISTS OF WHITE BACKGROUND; RED FRAME AROUND STYLIZED WORD; STYLIZED WORD CONSISTS OF FOUR COLOR LETTERS: STYLIZED LETTER "B" IS BLUE; LETTER "I" IS COMBINED OF PINK, DEEP VIOLET AND YELLOW COLORS AND IS STYLIZED TO FORM A COIL SPRING STRETCHED VERTICALLY AND WITH YELLOW BALL ON TOP OF IT; STYLIZED LETTER "G" IS YELLOW; STYLIZED LETTER "A" IS GREEN.

FOR GAMES, PLASTIC AND OTHER SYNTHETIC MATERIAL TOYS AND PLAYTHINGS, NAMELY BOARD GAMES AND EQUIPMENT SOLD AS A UNIT FOR PLAYING BOARD GAMES, ACTION FIGURES, TOY BUILDING BLOCKS AND TOY PLASTIC BALLS (U.S. CLS. 22, 23, 38 AND 50).

FIRST USE 12-5-2005; IN COMMERCE 3-1-2006.

3,178,539. DENNCO, INC., SALEM, NH. SN 78-670,193. PUB. 5-2-2006, FILED 7-14-2005.

EXPAND-A-GREEN

THE MARK CONSISTS OF STANDARD CHARACTERS WITHOUT CLAIM TO ANY PARTICULAR FONT, STYLE, SIZE, OR COLOR.

FOR MODULAR PREFABRICATED SYNTHETIC PUTTING GREEN (U.S. CLS. 22, 23, 38 AND 50).

FIRST USE 8-29-2005; IN COMMERCE 8-29-2005.

3,178,545. TOY STATE INDUSTRIAL LTD., KOWLOON, HONG KONG. SN 78-673,315. PUB. 4-11-2006, FILED 7-19-2005.

COOL ROLLER

THE MARK CONSISTS OF STANDARD CHARACTERS WITHOUT CLAIM TO ANY PARTICULAR FONT, STYLE, SIZE, OR COLOR.

FOR TOY VEHICLES (U.S. CLS. 22, 23, 38 AND 50). FIRST USE 6-12-2006; IN COMMERCE 6-12-2006.

CLASS 28—(Continued).

3,178,581. CORBETT, CRAIG ALLEN, COLLINS, GA. SN 78-695,190. PUB. 5-9-2006, FILED 8-18-2005.

Strumpet

THE MARK CONSISTS OF STANDARD CHARACTERS WITHOUT CLAIM TO ANY PARTICULAR FONT, STYLE, SIZE, OR COLOR.

FOR HUNTING GAME CALLS (U.S. CLS. 22, 23, 38 AND 50).

FIRST USE 2-17-2005; IN COMMERCE 6-16-2005.

3,178,637. ZIZZLE (HONG KONG) LIMITED, KOWLOON, HONG KONG. SN 78-724,938. PUB. 6-13-2006, FILED 10-3-2005.

GUT WRENCHER

THE MARK CONSISTS OF STANDARD CHARACTERS WITHOUT CLAIM TO ANY PARTICULAR FONT, STYLE, SIZE, OR COLOR.

FOR BATTERY OPERATED ACTION TOYS; ELECTRONICALLY OPERATED TOY MOTOR VEHICLES; RADIO CONTROLLED TOY VEHICLES; TOY VEHICLES AND ACCESSORIES THEREFOR (U.S. CLS. 22, 23, 38 AND 50).

FIRST USE 7-11-2006; IN COMMERCE 7-11-2006.

3,178,664. DISNEY ENTERPRISES, INC., BURBANK, CA. SN 78-977,548. PUB. 11-29-2005, FILED 12-28-2004.



NO CLAIM IS MADE TO THE EXCLUSIVE RIGHT TO USE "CARS", APART FROM THE MARK AS SHOWN.

THE MARK CONSISTS OF THE WORD CARS IN STYLIZED LETTERING, SURROUNDED BY A DARK OBLONG AND SUPERIMPOSED OVER A STYLIZED "V".

FOR CARD GAMES; ELECTRIC ACTION TOYS; INFLATABLE TOYS; MANIPULATIVE GAMES; PLUSH TOYS; STUFFED TOYS; TOY VEHICLES; TOY CARS; TOY TRUCKS (U.S. CLS. 22, 23, 38 AND 50).

FIRST USE 6-9-2006; IN COMMERCE 6-9-2006.

CLASS 29—MEATS AND PROCESSED FOODS

3,177,623. FOSTER POULTRY FARMS, DBA FOSTER FARMS, LIVINGSTON, CA. SN 78-179,187. PUB. 1-17-2006, FILED 10-28-2002.

CLASS 29—(Continued).

3,177,881. WAWONA FROZEN FOODS, CLOVIS, CA. SN 78-443,232. PUB. 9-13-2005, FILED 6-29-2004.

FRESH & EASY

THE MARK CONSISTS OF STANDARD CHARACTERS WITHOUT CLAIM TO ANY PARTICULAR FONT, STYLE, SIZE, OR COLOR.

FOR EVISCERATED POULTRY (U.S. CL. 46).
FIRST USE 4-21-2006; IN COMMERCE 4-21-2006.



3,177,653. SHAMROCK FOODS COMPANY, PHOENIX, AZ. SN 78-250,603. PUB. 6-15-2004, FILED 5-15-2003.



OWNER OF U.S. REG. NOS. 1,761,590, 1,826,743, AND OTHERS.

FOR PICKLES; FROZEN POTATOES; VEGETABLE, SALAD AND COOKING OILS; MARGARINE AND BUTTER; SHORTENING; PROCESSED ARTICHOKE HEARTS; PROCESSED TOMATOES, TOMATO PASTE AND TOMATO PUREE; CANNED AND FROZEN VEGETABLES; LOW SODIUM DIETARY CANNED VEGETABLES; MEATS AND PROCESSED MEATS, NAMELY BEEF, SAUSAGE, PEPPERONI AND PORK; POULTRY AND PROCESSED POULTRY; EGGS; BATTERED AND BREADED FROZEN VEGETABLES; CANNED, FROZEN AND DEHYDRATED FRUIT; PROCESSED OLIVES; JAMS, JELLIES AND PRESERVES; PROCESSED PEPPERS; SOUP BASES; PEANUT BUTTER; GAME; FISH AND PROCESSED FISH; SEAFOOD AND PROCESSED SEAFOOD; SHELLFISH AND PROCESSED SHELLFISH (U.S. CL. 46).

FIRST USE 8-0-2005; IN COMMERCE 8-0-2005.

SPECTRUM BLEND

THE MARK CONSISTS OF STANDARD CHARACTERS WITHOUT CLAIM TO ANY PARTICULAR FONT, STYLE, SIZE, OR COLOR.

NO CLAIM IS MADE TO THE EXCLUSIVE RIGHT TO USE "BLEND", APART FROM THE MARK AS SHOWN. FOR CANNED MIXED FRUIT BLENDS; FROZEN MIXED FRUIT BLENDS; CUPS OF MIXED CANNED FRUIT (U.S. CL. 46).

FIRST USE 11-30-2005; IN COMMERCE 11-30-2005.



3,177,902. W3 PARTNERS LLC, ROGERS, AR. SN 78-449,823. PUB. 11-1-2005, FILED 7-13-2004.

BIDDY BITES

THE MARK CONSISTS OF STANDARD CHARACTERS WITHOUT CLAIM TO ANY PARTICULAR FONT, STYLE, SIZE, OR COLOR.

NO CLAIM IS MADE TO THE EXCLUSIVE RIGHT TO USE "BITES", APART FROM THE MARK AS SHOWN.

FOR SNACKS MADE FROM POULTRY, NAMELY, CHICKEN RINGS (U.S. CL. 46).

FIRST USE 10-1-2004; IN COMMERCE 10-1-2004.

CLASS 29—(Continued).

3,177,931. VDF FUTURECEUTICALS, INC., MOMENCE, IL.
SN 78-461,613. PUB. 8-23-2005, FILED 8-4-2004.

SPROUTGARDEN

THE MARK CONSISTS OF STANDARD CHARACTERS WITHOUT CLAIM TO ANY PARTICULAR FONT, STYLE, SIZE, OR COLOR.

FOR FOOD INGREDIENTS, NAMELY PROCESSED VEGETABLES (U.S. CL. 46).
FIRST USE 5-22-2006; IN COMMERCE 5-22-2006.

3,178,047. ADMIRALTY ISLAND FISHERIES, INC., DBA AQUA STAR, SEATTLE, WA. SN 78-506,197. PUB. 10-4-2005, FILED 10-26-2004.

WHEN YOU CAN'T
CATCH YOUR OWN

THE MARK CONSISTS OF STANDARD CHARACTERS WITHOUT CLAIM TO ANY PARTICULAR FONT, STYLE, SIZE, OR COLOR.

FOR SEAFOOD; PREPACKAGED PROCESSED FOOD CONSISTING PRIMARILY OF SEAFOOD SERVED WITH VEGETABLES, PASTA, OR RICE (U.S. CL. 46).
FIRST USE 12-31-2004; IN COMMERCE 12-31-2004.

CLASS 29—(Continued).

3,178,170. SELECT PRODUCTS, INC., OSCEOLA, IA. SN 78-563,076. PUB. 5-30-2006, FILED 2-8-2005.

**TAILGATER
MEAT!**

NO CLAIM IS MADE TO THE EXCLUSIVE RIGHT TO USE "MEAT", APART FROM THE MARK AS SHOWN.

FOR FOOD PACKAGE COMBINATIONS COMPRISED PRIMARILY OF FRESH AND FROZEN PORK, FURTHER PROCESSED PORK, COOKED PORK, PROCESSED COOKED PORK AND LUNCHEON MEATS, HOT DOGS, SAUSAGE DOGS CONTAINING PORK; FRESH AND FROZEN BEEF, FURTHER PROCESSED BEEF, COOKED BEEF, PROCESSED COOKED BEEF AND LUNCHEON MEATS, HOT DOGS CONTAINING BEEF; FRESH AND FROZEN POULTRY, FURTHER PROCESSED POULTRY, COOKED POULTRY, PROCESSED COOKED POULTRY; CHEESE, CHEESE SPREADS, CHEESE BALLS AND LOGS, SNACK DIPS, SOUPS, SAUSAGE, HAMS, TURKEY, SAUERKRAUT, PICKLES; FRESH AND FROZEN BISON, FURTHER PROCESSED BISON, COOKED BISON, PROCESSED COOKED BISON; FRESH AND FROZEN LAMB, FURTHER PROCESSED LAMB, COOKED LAMB, PROCESSED COOKED LAMB, FRESH SEAFOOD, FISH, FURTHER COOKED SEAFOOD; DAIRY PRODUCTS EXCLUDING ICE CREAM, ICE MILK AND FROZEN YOGURT; DRIED, CANNED OR FROZEN FRUITS AND VEGETABLES (U.S. CL. 46).

FIRST USE 7-31-2005; IN COMMERCE 7-31-2005.

3,178,174. STERN, BRETT, PORTLAND, OR. SN 78-564,303. PUB. 11-29-2005, FILED 2-10-2005.

Beer chips

THE MARK CONSISTS OF STANDARD CHARACTERS WITHOUT CLAIM TO ANY PARTICULAR FONT, STYLE, SIZE, OR COLOR.

NO CLAIM IS MADE TO THE EXCLUSIVE RIGHT TO USE "CHIPS", APART FROM THE MARK AS SHOWN.
FOR POTATO BASED SNACK FOOD (U.S. CL. 46).
FIRST USE 7-29-2006; IN COMMERCE 7-29-2006.

CLASS 29—(Continued).

3,178,221. LA TERRE, LLC, NEWPORT BEACH, CA. SN 78-574,127. PUB. 12-13-2005, FILED 2-24-2005.

AMARANTE

THE MARK CONSISTS OF STANDARD CHARACTERS WITHOUT CLAIM TO ANY PARTICULAR FONT, STYLE, SIZE, OR COLOR.

FOR EDIBLE OIL, COOKING OIL, AND NUTS WHICH ARE SHELLED, ROASTED OR OTHERWISE PROCESSED (U.S. CL. 46).

FIRST USE 6-30-2005; IN COMMERCE 9-19-2005.

3,178,384. ARCHER DANIELS MIDLAND COMPANY, DECATUR, IL. SN 78-608,413. PUB. 1-17-2006, FILED 4-14-2005.

TOUCH OF GOLD

THE MARK CONSISTS OF STANDARD CHARACTERS WITHOUT CLAIM TO ANY PARTICULAR FONT, STYLE, SIZE, OR COLOR.

FOR SOYBEAN OIL BASED NON-STICK COOKING SPRAY (U.S. CL. 46).

FIRST USE 4-0-2005; IN COMMERCE 4-0-2005.

3,178,438. PET INCORPORATED, MINNEAPOLIS, MN. SN 78-629,462. PUB. 1-31-2006, FILED 5-13-2005.

OLD EL PASO

THE MARK CONSISTS OF STANDARD CHARACTERS WITHOUT CLAIM TO ANY PARTICULAR FONT, STYLE, SIZE, OR COLOR.

OWNER OF U.S. REG. NOS. 647,574, 2,057,187, AND OTHERS.

FOR CANNED SOUP (U.S. CL. 46).

FIRST USE 9-1-2005; IN COMMERCE 9-1-2005.

CLASS 29—(Continued).

3,178,467. PPC MARKETING, LTD., PITTSBURGH, TX. SN 78-641,755. PUB. 4-4-2006, FILED 6-1-2005.



OWNER OF U.S. REG. NOS. 935,768, 2,401,500, AND 2,918,933.

NO CLAIM IS MADE TO THE EXCLUSIVE RIGHT TO USE "KIDS", APART FROM THE MARK AS SHOWN.

THE STIPPLING IS A FEATURE OF THE MARK.

THE NAME(S), PORTRAIT(S), AND/OR SIGNATURE(S) SHOWN IN THE MARK IDENTIFIES BO PILGRIM, WHOSE CONSENT(S) TO REGISTER IS SUBMITTED.

FOR POULTRY (U.S. CL. 46).

FIRST USE 5-1-2005; IN COMMERCE 5-1-2005.

3,178,483. VDF FUTURECEUTICALS, INC., MOMENCE, IL. SN 78-649,089. PUB. 3-7-2006, FILED 6-13-2005.

VITAGRANATE

THE MARK CONSISTS OF STANDARD CHARACTERS WITHOUT CLAIM TO ANY PARTICULAR FONT, STYLE, SIZE, OR COLOR.

FOR FOOD AND BEVERAGE INGREDIENT, NAMELY, PROCESSED POMEGRANATES (U.S. CL. 46).

FIRST USE 4-27-2006; IN COMMERCE 4-27-2006.

3,178,495. PPC MARKETING, LTD., PITTSBURGH, TX. SN 78-655,797. PUB. 3-7-2006, FILED 6-22-2005.

EAT WELL STAY HEALTHY

THE MARK CONSISTS OF STANDARD CHARACTERS WITHOUT CLAIM TO ANY PARTICULAR FONT, STYLE, SIZE, OR COLOR.

FOR POULTRY (U.S. CL. 46).

FIRST USE 5-1-2005; IN COMMERCE 5-1-2005.

CLASS 29—(Continued).

3,178,555. ROYAL WINE CORPORATION, DBA KEDEM FOOD PRODUCTS, BAYONNE, NJ. SN 78-676,233. PUB. 4-11-2006, FILED 7-22-2005.

REDWOOD FARMS

THE MARK CONSISTS OF STANDARD CHARACTERS WITHOUT CLAIM TO ANY PARTICULAR FONT, STYLE, SIZE, OR COLOR.
FOR VEGETABLE BASED SNACKS (U.S. CL. 46).
FIRST USE 12-29-2005; IN COMMERCE 12-29-2005.

3,178,570. SYRIAN BAKERY COMPANY, CICERO, IL. AND ZB IMPORTING, INC., CICERO, IL. SN 78-683,737. PUB. 4-25-2006, FILED 8-2-2005.

HUMMUS TO GO!

THE MARK CONSISTS OF STANDARD CHARACTERS WITHOUT CLAIM TO ANY PARTICULAR FONT, STYLE, SIZE, OR COLOR.
NO CLAIM IS MADE TO THE EXCLUSIVE RIGHT TO USE HUMMUS, APART FROM THE MARK AS SHOWN.
FOR HUMMUS (U.S. CL. 46).
FIRST USE 12-29-2005; IN COMMERCE 12-29-2005.

3,178,596. SWIFT BRANDS COMPANY, GREELEY, CO. SN 78-703,776. PUB. 5-16-2006, FILED 8-30-2005.

FLAVOR STARTER

THE MARK CONSISTS OF STANDARD CHARACTERS WITHOUT CLAIM TO ANY PARTICULAR FONT, STYLE, SIZE, OR COLOR.
FOR MEAT (U.S. CL. 46).
FIRST USE 12-0-2005; IN COMMERCE 12-0-2005.

CLASS 29—(Continued).

3,178,670. DANNON COMPANY, INC., THE, WHITE PLAINS, NY. SN 78-977,638. PUB. 12-13-2005, FILED 5-31-2005.

CRAVE CONTROL

THE MARK CONSISTS OF STANDARD CHARACTERS WITHOUT CLAIM TO ANY PARTICULAR FONT, STYLE, SIZE, OR COLOR.
FOR YOGURT AND YOGURT-BASED BEVERAGES (U.S. CL. 46).
FIRST USE 7-0-2006; IN COMMERCE 7-0-2006.

CLASS 30—STAPLE FOODS

3,177,333. NATURE'S PATH FOODS, INC., RICHMOND, BRITISH COLUMBIA, CANADA. SN 76-110,832. PUB. 2-19-2002, FILED 8-16-2000.

OPTIMUM

PRIORITY CLAIMED UNDER SEC. 44(D) ON CANADA APPLICATION NO. 1060874, FILED 6-1-2000.
FOR BREAKFAST CEREALS (U.S. CL. 46).
FIRST USE 11-8-2000; IN COMMERCE 11-8-2000.

3,177,342. A. LOACKER S.P.A. A.G., BOLZANO, ITALY. SN 76-298,748. PUB. 9-27-2005, FILED 8-13-2001.

DO THE CUBE! TASTE THE DIFFERENCE!!

FOR BISCUITS, CAKES, PIES, TARTS, GRAIN-BASED SNACK FOODS, BUNS, BAKERY GOODS, COOKIES, SWEETMEATS, WAFERS AND BONBONS (U.S. CL. 46).
FIRST USE 8-0-2001; IN COMMERCE 8-0-2001.

3,177,363. GOURMET GURU, INC., BRONX, NY. SN 76-421,398. PUB. 6-17-2003, FILED 6-14-2002.

BUBBELA'S BAKERY

NO CLAIM IS MADE TO THE EXCLUSIVE RIGHT TO USE "BAKERY", APART FROM THE MARK AS SHOWN.
THE ENGLISH TRANSLATION OF "BUBBELA" IS "GRANDMOTHER".
FOR BAKERY GOODS AND RUGGELACH (U.S. CL. 46).
FIRST USE 9-8-2006; IN COMMERCE 9-8-2006.

CLASS 30—(Continued).

3,177,383. PASTIFICIO LUCIO GAROFALO S.P.A., GRAGNANO (NAPOLI), ITALY. SN 76-514,104. PUB. 5-31-2005, FILED 5-14-2003.



THE TRANSLATION OF THE WORDING SANTA IS SAINT.
FOR PROCESSED CEREAL AND FROZEN CONFECTIONS (U.S. CL. 46).
FIRST USE 8-12-2002; IN COMMERCE 8-12-2002.

3,177,414. LOPEZ, ERIBERTO CANDELARIO, ZAPOPAN JALISCO, MEXICO. SN 76-560,359. PUB. 9-13-2005, FILED 11-14-2003.

JOVY FRUTI MAX EXTREME

THE MARK CONSISTS OF STANDARD CHARACTERS WITHOUT CLAIM TO ANY PARTICULAR FONT, STYLE, SIZE, OR COLOR.

NO CLAIM IS MADE TO THE EXCLUSIVE RIGHT TO USE "FRUTI", APART FROM THE MARK AS SHOWN.

FOR COFFEE, TEA COCOA, SUGAR, RICE, TAPIOCA, SAGO, ARTIFICIAL COFFEE, FLOUR AND PROCESSED CEREAL PRODUCTS, NAMELY CEREAL BARS, CEREAL BASED SNACK FOODS, BREAD, PASTRY AND CONFECTIONERY CHIPS, HONEY (U.S. CL. 46).

FIRST USE 7-15-2006; IN COMMERCE 7-15-2006.

3,177,426. PARIS GOURMET OF NEW YORK INC., CARLSTADT, NJ. SN 76-577,298. PUB. 1-3-2006, FILED 2-24-2004.

ALMONDAS

THE MARK CONSISTS OF STANDARD CHARACTERS WITHOUT CLAIM TO ANY PARTICULAR FONT, STYLE, SIZE, OR COLOR.

FOR PASTRY AND CONFECTION PREPARATIONS, NAMELY INGREDIENTS USED IN THE BAKING OF PASTRIES AND BAKED GOODS, NAMELY, FLOUR, NUT FLOUR, SUGAR, CHOCOLATE, NON-ESSENTIAL OIL FOOD FLAVORINGS AND NUT PASTES (U.S. CL. 46).

FIRST USE 3-1-2004; IN COMMERCE 3-1-2004.

CLASS 30—(Continued).

3,177,432. MARS, INCORPORATED, MCLEAN, VA. SN 76-581,162. PUB. 8-30-2005, FILED 3-16-2004.

MY BLEND

THE MARK CONSISTS OF STANDARD CHARACTERS WITHOUT CLAIM TO ANY PARTICULAR FONT, STYLE, SIZE, OR COLOR.

NO CLAIM IS MADE TO THE EXCLUSIVE RIGHT TO USE "BLEND", APART FROM THE MARK AS SHOWN.

FOR CONFECTIONERY, NAMELY, CANDY (U.S. CL. 46).

FIRST USE 5-0-2004; IN COMMERCE 5-0-2004.

3,177,460. A&A GLOBAL INDUSTRIES, INC., COCKEYSVILLE, MD. SN 76-605,666. PUB. 7-19-2005, FILED 8-5-2004.



NO CLAIM IS MADE TO THE EXCLUSIVE RIGHT TO USE CANDIES, APART FROM THE MARK AS SHOWN.

FOR CANDY (U.S. CL. 46).

FIRST USE 1-14-2005; IN COMMERCE 1-14-2005.

3,177,477. CONAGRA FOODS PACKAGED FOODS COMPANY, INC., OMAHA, NE. SN 76-609,591. PUB. 7-12-2005, FILED 8-30-2004.

TAKE A MOMENT & COVER IT IN CHOCOLATE

THE MARK CONSISTS OF STANDARD CHARACTERS WITHOUT CLAIM TO ANY PARTICULAR FONT, STYLE, SIZE, OR COLOR.

FOR COCOA MIXES (U.S. CL. 46).

FIRST USE 9-20-2005; IN COMMERCE 9-20-2005.

CLASS 30—(Continued).

3,177,480. FAMIGLIA-DEBARTOLO, LLC, WHITE PLAINS, NY. SN 76-609,926. PUB. 12-13-2005, FILED 9-2-2004.

CAFFÉ FAMIGLIA

NO CLAIM IS MADE TO THE EXCLUSIVE RIGHT TO USE CAFFÉ, APART FROM THE MARK AS SHOWN.

THE ENGLISH TRANSLATION OF THE WORD CAFFÉ IN THE MARK IS "COFFEE" OR "CAFE". THE ENGLISH TRANSLATION OF THE WORD FAMIGLIA IN THE MARK IS "FAMILY".

FOR COFFEE (U.S. CL. 46).
FIRST USE 7-1-2005; IN COMMERCE 7-1-2005.

CLASS 30—(Continued).

3,177,663. CARGILL, INCORPORATED, WAYZATA, MN. SN 78-270,911. PUB. 7-6-2004, FILED 7-7-2003.

CARGILL TEX

OWNER OF U.S. REG. NOS. 880,991, 2,333,632, AND OTHERS.

FOR FOOD STARCHES (U.S. CL. 46).
FIRST USE 12-9-2002; IN COMMERCE 12-9-2002.

3,177,503. LEE KUM KEE COMPANY LIMITED, TAI PO, NEW TERRITORIES, HONG KONG. SN 76-615,757. PUB. 1-17-2006, FILED 10-14-2004.

財神
CHOY SUN



OWNER OF U.S. REG. NO. 1,575,317.
THE WORD CHOY IN THE MARK TRANSLATES TO "FORTUNE;" THE WORD SUN IN THE MARK TRANSLATES TO "GOD".

THE NON-LATIN CHARACTERS IN THE MARK TRANSLITERATE TO "CHOY SUN."

FOR SAUCES, SEASONINGS, OYSTER SAUCE, OYSTER FLAVOURED SAUCE (U.S. CL. 46).
FIRST USE 10-0-2004; IN COMMERCE 1-0-2006.

3,177,681. TATE & LYLE INGREDIENTS AMERICAS, INC., DECATUR, IL. SN 78-298,742. PUB. 2-8-2005, FILED 9-10-2003.

MATRIX

FOR CORN SYRUP USED IN THE MANUFACTURE OF FOOD AND AS AN ADHESIVE TO ADHERE FLAVORINGS TO MANUFACTURED FOOD PRODUCTS (U.S. CL. 46).

FIRST USE 12-8-2003; IN COMMERCE 12-8-2003.

3,177,551. CONAGRA BRANDS, INC., OMAHA, NE. SN 76-634,889. PUB. 12-27-2005, FILED 3-31-2005.

LISTEN TO THE POP TO KNOW WHEN TO STOP

THE MARK CONSISTS OF STANDARD CHARACTERS WITHOUT CLAIM TO ANY PARTICULAR FONT, STYLE, SIZE, OR COLOR.

FOR POPPED POPCORN, UNPOPPED POPCORN AND MICROWAVE POPCORN (U.S. CL. 46).
FIRST USE 10-17-2005; IN COMMERCE 10-17-2005.

3,177,752. KEVIN A. MCCOY AND EFREN TERAN, ALBUQUERQUE, NM. SN 78-366,494. PUB. 12-7-2004, FILED 2-11-2004.

MAYONICE

THE MARK CONSISTS OF STANDARD CHARACTERS WITHOUT CLAIM TO ANY PARTICULAR FONT, STYLE, SIZE, OR COLOR.

FOR SOY BASED MAYONNAISE (U.S. CL. 46).
FIRST USE 8-11-2006; IN COMMERCE 8-11-2006.

CLASS 30—(Continued).

3,177,786. CAFE BELMONDO, LLC, TAMPA, FL. SN 78-389,014. PUB. 3-1-2005, FILED 3-23-2004.

CLASS 30—(Continued).

3,177,850. LOCKE, SHEILA, REDMOND, WA. AND HOANG, TUANHAI, REDMOND, WA. SN 78-429,209. PUB. 4-19-2005, FILED 6-3-2004.

CAFE ZANZIBAR

THE MARK CONSISTS OF STANDARD CHARACTERS WITHOUT CLAIM TO ANY PARTICULAR FONT, STYLE, SIZE, OR COLOR.

NO CLAIM IS MADE TO THE EXCLUSIVE RIGHT TO USE "CAFE", APART FROM THE MARK AS SHOWN.

THE FOREIGN WORDING IN THE MARK TRANSLATES INTO ENGLISH AS COFFEE.

FOR COFFEE (U.S. CL. 46).

FIRST USE 7-27-2006; IN COMMERCE 7-27-2006.

BOBACHINE

THE MARK CONSISTS OF STANDARD CHARACTERS WITHOUT CLAIM TO ANY PARTICULAR FONT, STYLE, SIZE, OR COLOR.

THE FOREIGN WORDING IN THE MARK TRANSLATES INTO ENGLISH AS TAPIOCA CHINA.

FOR TEA BASED BEVERAGES CONTAINING MILK AND OPTIONALLY CONTAINING TAPIOCA BALLS (U.S. CL. 46).

FIRST USE 7-1-2004; IN COMMERCE 7-10-2006.

3,177,844. KRAFT FOODS HOLDINGS, INC., NORTHFIELD, IL. SN 78-425,151. PUB. 6-14-2005, FILED 5-26-2004.

3,177,901. BEN & JERRY'S HOMEMADE, INC., VERMONT, VT. SN 78-449,699. PUB. 6-7-2005, FILED 7-13-2004.

BEECHIES

THE MARK CONSISTS OF STANDARD CHARACTERS WITHOUT CLAIM TO ANY PARTICULAR FONT, STYLE, SIZE, OR COLOR.

OWNER OF U.S. REG. NOS. 253,465, 625,957, AND 1,580,346.

FOR CANDY (U.S. CL. 46).

FIRST USE 6-1-2006; IN COMMERCE 6-1-2006.

**GOBFATHER, THE
FLAVOR YOU CAN'T
REFUSE**

THE MARK CONSISTS OF STANDARD CHARACTERS WITHOUT CLAIM TO ANY PARTICULAR FONT, STYLE, SIZE, OR COLOR.

FOR ICE CREAM AND FROZEN CONFECTIONS (U.S. CL. 46).

FIRST USE 1-0-2005; IN COMMERCE 1-0-2005.

CLASS 30—(Continued).

3,177,944. CARGILL, INCORPORATED, WAYZATA, MN. SN 78-466,599. PUB. 7-5-2005, FILED 8-12-2004.

VERSAGUM

THE MARK CONSISTS OF STANDARD CHARACTERS WITHOUT CLAIM TO ANY PARTICULAR FONT, STYLE, SIZE, OR COLOR.

FOR FOOD ADDITIVES FOR NON-NUTRITIONAL PURPOSES FOR USE AS AN INGREDIENT (U.S. CL. 46). FIRST USE 10-20-2005; IN COMMERCE 10-20-2005.

CLASS 30—(Continued).

3,177,993. TRUFOODS SYSTEMS, INC., LAKE SUCCESS, NY. SN 78-480,024. PUB. 5-30-2006, FILED 9-8-2004.

WALL STREET COFFEE COMPANY

THE MARK CONSISTS OF STANDARD CHARACTERS WITHOUT CLAIM TO ANY PARTICULAR FONT, STYLE, SIZE, OR COLOR.

NO CLAIM IS MADE TO THE EXCLUSIVE RIGHT TO USE COFFEE AND COMPANY, APART FROM THE MARK AS SHOWN.

FOR FOOD AND DRINKS NAMELY, BREWED COFFEE AT RETAIL FOOD ESTABLISHMENTS (U.S. CL. 46). FIRST USE 3-31-2004; IN COMMERCE 3-31-2004.

3,178,063. UNILEVER SUPPLY CHAIN, INC., CLINTON, CT. SN 78-513,947. PUB. 10-11-2005, FILED 11-9-2004.

3,177,961. GONGGA FOOD SDN BHD, IPOH, PERAK, MALAYSIA. SN 78-469,893. PUB. 12-27-2005, FILED 8-19-2004.

南洋 Nan Yang

THE MARK CONSISTS OF LETTERS IN STYLIZED MANNER AND INSCRIPTION IN CHINESE CHARACTERS. THE FOREIGN WORDING IN THE MARK TRANSLATES INTO ENGLISH AS SOUTH SEA.

THE NON-LATIN CHARACTER(S) IN THE MARK TRANSLITERATES INTO NAN YANG, AND THIS MEANS SOUTH SEA IN ENGLISH.

FOR COFFEE AND TEA (U.S. CL. 46). FIRST USE 12-13-2004; IN COMMERCE 12-13-2004.

CHOCSICLE

THE MARK CONSISTS OF STANDARD CHARACTERS WITHOUT CLAIM TO ANY PARTICULAR FONT, STYLE, SIZE, OR COLOR.

OWNER OF U.S. REG. NOS. 528,830 AND 593,672. FOR FROZEN CONFECTIONS (U.S. CL. 46). FIRST USE 2-0-2005; IN COMMERCE 2-0-2005.

CLASS 30—(Continued).

3,178,126. DONGWON F&B CO., LTD., SEOUL, REPUBLIC OF KOREA. SN 78-543,198. PUB. 1-3-2006, FILED 1-6-2005.



FOR PREPARED ENTREES CONSISTING PRIMARILY OF RICE, NAMELY, BIBIMBAP DISHES CONSISTING OF RICE MIXED WITH SEASONINGS AND SUPPLEMENTAL INGREDIENTS SUCH AS MEAT, FISH, POULTRY, VEGETABLES AND GRAINS; FROZEN BOILED RICE; PACKED BOILED RICE; DOYN-JANG, NAMELY, FERMENTED SOYBEAN PASTE; GOCHU-JANG, NAMELY, FERMENTED HOT PEPPER PASTE; RICE; NOODLES; DUMPLINGS; RICE CAKES; COOKIES; CHOCOLATE; HONEY; COFFEE; BLACK TEA, ENGLISH TEA; GREEN TEA (U.S. CL. 46).
FIRST USE 3-1-2005; IN COMMERCE 3-1-2005.

CLASS 30—(Continued).

3,178,146. P. Q. LICENSING, S.A., 11 AT B-1000 BRUSSELS, BELGIUM. SN 78-552,303. PUB. 5-9-2006, FILED 1-23-2005.

LE PAIN QUOTIDIEN

THE MARK CONSISTS OF STANDARD CHARACTERS WITHOUT CLAIM TO ANY PARTICULAR FONT, STYLE, SIZE, OR COLOR.

OWNER OF U.S. REG. NO. 2,211,381.

THE ENGLISH TRANSLATION OF THE FRENCH WORDING "LE PAIN QUOTIDIEN" IN THE MARK IS "DAILY BREAD".

FOR BAKERY PRODUCTS, NAMELY, BREAD, PASTRIES AND SANDWICHES (U.S. CL. 46).

FIRST USE 1-0-1997; IN COMMERCE 1-0-1997.

3,178,142. DONNA MIROS, INC., CRANFORD, NJ. SN 78-551,405. PUB. 2-14-2006, FILED 1-21-2005.

COCOA BEE

THE MARK CONSISTS OF STANDARD CHARACTERS WITHOUT CLAIM TO ANY PARTICULAR FONT, STYLE, SIZE, OR COLOR.

NO CLAIM IS MADE TO THE EXCLUSIVE RIGHT TO USE "COCOA", APART FROM THE MARK AS SHOWN.

FOR CHOCOLATE; CHOCOLATE CANDY BARS (U.S. CL. 46).

FIRST USE 6-1-2005; IN COMMERCE 6-1-2005.

3,178,232. AN COFEE DISTRIBUTOR INC., NEW YORK, NY. SN 78-576,093. PUB. 12-20-2005, FILED 2-28-2005.

Los Primos Coffee

THE MARK CONSISTS OF STANDARD CHARACTERS WITHOUT CLAIM TO ANY PARTICULAR FONT, STYLE, SIZE, OR COLOR.

NO CLAIM IS MADE TO THE EXCLUSIVE RIGHT TO USE "PRIMOS COFFEE", APART FROM THE MARK AS SHOWN.

FOR COFFEE (U.S. CL. 46).

FIRST USE 9-13-2006; IN COMMERCE 9-13-2006.

CLASS 30—(Continued).

3,178,246. ROMAN MEAL COMPANY, TACOMA, WA. SN 78-579,100. PUB. 11-22-2005, FILED 3-3-2005.

**THE WISDOM OF
WHOLE GRAINS**

THE MARK CONSISTS OF STANDARD CHARACTERS WITHOUT CLAIM TO ANY PARTICULAR FONT, STYLE, SIZE, OR COLOR.

NO CLAIM IS MADE TO THE EXCLUSIVE RIGHT TO USE "WHOLE GRAINS", APART FROM THE MARK AS SHOWN.

FOR BREAD, BUNS, ROLLS, ENGLISH MUFFINS, BAGELS, FRESH AND FROZEN WAFFLES, COOKIES, PROCESSED CEREALS, PASTA, CRACKERS, SCONE AND MUFFIN MIXES, BREAD MACHINE MIXES, FLOUR, PANCAKE AND WAFFLE MIXES, AND WHOLE-GRAIN SNACK FOODS (U.S. CL. 46).

FIRST USE 2-0-2006; IN COMMERCE 2-0-2006.

3,178,294. JALIMA COFFEE LLC, BRADENTON, FL. SN 78-589,393. PUB. 12-20-2005, FILED 3-17-2005.

JALIMA

THE MARK CONSISTS OF STANDARD CHARACTERS WITHOUT CLAIM TO ANY PARTICULAR FONT, STYLE, SIZE, OR COLOR.

FOR COFFEE, CHILI SAUCES, HONEY, COCOA, VANILLA AND SALAD DRESSINGS (U.S. CL. 46).

FIRST USE 8-1-2005; IN COMMERCE 8-1-2005.

CLASS 30—(Continued).

3,178,323. CARGILL, INCORPORATED, WAYZATA, MN. SN 78-594,384. PUB. 12-27-2005, FILED 3-24-2005.

 **MaizeWise**

FOR CORN MEAL, CORN FLOUR, CORN MASA FLOUR AND CORN BRAN (U.S. CL. 46).

FIRST USE 11-11-2005; IN COMMERCE 11-11-2005.

3,178,347. ARCHER-DANIELS-MIDLAND COMPANY, DECATUR, IL. SN 78-597,640. PUB. 12-20-2005, FILED 3-29-2005.

KANSAS DIAMOND

THE MARK CONSISTS OF STANDARD CHARACTERS WITHOUT CLAIM TO ANY PARTICULAR FONT, STYLE, SIZE, OR COLOR.

FOR FLOUR (U.S. CL. 46).

FIRST USE 4-1-2005; IN COMMERCE 4-1-2005.

3,178,373. RUBY JEWEL TREATS, INC., PORTLAND, OR. SN 78-603,223. PUB. 12-27-2005, FILED 4-6-2005.

RUBY JEWEL

THE MARK CONSISTS OF STANDARD CHARACTERS WITHOUT CLAIM TO ANY PARTICULAR FONT, STYLE, SIZE, OR COLOR.

FOR ICE CREAM SANDWICHES; FROZEN CONFECTIONS (U.S. CL. 46).

FIRST USE 6-0-2005; IN COMMERCE 8-0-2005.

CLASS 30—(Continued).

3,178,396. CADBURY ADAMS USA LLC, PARSIPPANY, NJ.
SN 78-612,701. PUB. 1-10-2006, FILED 4-20-2005.

CLASS 30—(Continued).

3,178,508. RALEY'S TM, INC., WEST SACRAMENTO, CA. SN
78-659,251. PUB. 3-14-2006, FILED 6-27-2005.

RALEY'S BEL AIR FINE FOODS

AVALANCHE MINT

THE MARK CONSISTS OF STANDARD CHARACTERS
WITHOUT CLAIM TO ANY PARTICULAR FONT, STYLE,
SIZE, OR COLOR.

NO CLAIM IS MADE TO THE EXCLUSIVE RIGHT TO
USE "MINT", APART FROM THE MARK AS SHOWN.

FOR CONFECTIONERY, NAMELY CHEWING GUM
(U.S. CL. 46).

FIRST USE 12-31-2005; IN COMMERCE 12-31-2005.

THE MARK CONSISTS OF STANDARD CHARACTERS
WITHOUT CLAIM TO ANY PARTICULAR FONT, STYLE,
SIZE, OR COLOR.

NO CLAIM IS MADE TO THE EXCLUSIVE RIGHT TO
USE "FINE FOODS", APART FROM THE MARK AS
SHOWN.

FOR BAKING SODA, BARBECUE SAUCE, BREAD-
CRUMBS, BREAKFAST CEREALS, CAFFEINE-FREE
COFFEE, CANDY, CAPERS, CHEESECAKE, CHILI
POWERS, CHILI SEASONING, CHOCOLATE, CHOCO-
LATE CANDIES, CHOCOLATE CHIPS, CHOCOLATE
COVERED NUTS, CHOCOLATE SYRUP, CINNAMON
ROLLS, CINNAMON POWDER, COCOA, COCOA
MIXES, COFFEE, CONES FOR ICE CREAM, COOKIES,
CORN FLAKES, COUSCOUS, CRACKERS, CROUTONS,
DRIED PASTA, FLOUR, FRUIT ICE BAR, FRUIT PIES,
GRANOLA-BASED SNACK BARS, GRAVY, GRAVY
MIXES, GROUND COFFEE BEANS, HONEY, ICE MILK
BARS, INSTANT COFFEE, INSTANT PANCAKE MIXES,
INSTANT PUDDING MIXES, KETCHUP, LASAGNA,
MACARONI, MACARONI AND CHEESE, MACARONI
SALAD, MAPLE SYRUP, MARINADES, MARSHMAL-
LOW TOPPING, MARSHMALLOWS, MAYONNAISE,
MICROWAVE POPCORN, MINCED GARLIC, MIX FOR
NOODLE AND SAUCE DISH, MIXES FOR BAKERY
GOODS, MUSTARD, NOODLES, OATMEAL, PANCAKE
MIXES, PANCAKE SYRUP, PANCAKES, PASTA, PASTA
SHELLS, PEPPER, PEPPERMINT CANDY, PICKLE RELI-
SH, PIZZA, PRETZELS, RELISH, RICE, RICE CAKES,
RISOTTO, ROLLED OATS, ROLLS, SALAD DRESSINGS,
SALSA, SALT, SAUCES, SEASONINGS, SLOPPY JOE
SAUCE, SOY SAUCE, SPAGHETTI, SPAGHETTI SAUCE,
SPICES, SUGAR, SUGAR SUBSTITUTES, TABLE SYR-
UP, TARTAR SAUCE, TEA, TOMATO SAUCE, UN-
POPPED POPCORN KERNELS, VANILLA, VINEGAR,
WAFERS, WAFFLES, WINE VINEGAR (U.S. CL. 46).
FIRST USE 5-7-2005; IN COMMERCE 5-7-2005.

3,178,500. OWENS, STEPHEN M., SR., WILMINGTON, NC.
SN 78-657,116. PUB. 3-7-2006, FILED 6-23-2005.

3,178,516. PREFERRED MEAL SYSTEMS, INC., BERKELEY,
IL. SN 78-660,978. PUB. 4-25-2006, FILED 6-29-2005.

VACATION GROUNDS

THE MARK CONSISTS OF STANDARD CHARACTERS
WITHOUT CLAIM TO ANY PARTICULAR FONT, STYLE,
SIZE, OR COLOR.

FOR COFFEE (U.S. CL. 46).
FIRST USE 9-1-2005; IN COMMERCE 9-1-2005.

MAMA CARLINA

THE MARK CONSISTS OF STANDARD CHARACTERS
WITHOUT CLAIM TO ANY PARTICULAR FONT, STYLE,
SIZE, OR COLOR.

THE NAME(S), PORTRAIT(S), AND/OR SIGNATURE(S)
SHOWN IN THE MARK DOES NOT IDENTIFY A PARTI-
CULAR LIVING INDIVIDUAL.

FOR PIZZA FOR INSTITUTIONAL USE (U.S. CL. 46).
FIRST USE 8-2-2006; IN COMMERCE 8-2-2006.

CLASS 30—(Continued).

3,178,533. HOT STUFF FOODS, LLC, SIOUX FALLS, SD. SN 78-666,283. PUB. 3-21-2006, FILED 7-8-2005.



OWNER OF U.S. REG. NOS. 1,982,416, 2,449,152, AND OTHERS.

NO CLAIM IS MADE TO THE EXCLUSIVE RIGHT TO USE FOODS AND PIZZA, APART FROM THE MARK AS SHOWN.

FOR PIZZA (U.S. CL. 46).

FIRST USE 10-27-2005; IN COMMERCE 10-27-2005.

3,178,536. MENCOBONI FOODS, INC., FRAMINGHAM, MA. SN 78-667,654. PUB. 5-16-2006, FILED 7-11-2005.



THE STIPPLING IS FOR SHADING PURPOSES ONLY. THE NAME(S), PORTRAIT(S), AND/OR SIGNATURE(S) SHOWN IN THE MARK DOES NOT IDENTIFY A PARTICULAR LIVING INDIVIDUAL.

FOR SAUCES; SALAD DRESSINGS (U.S. CL. 46).

FIRST USE 7-14-2006; IN COMMERCE 7-14-2006.

3,178,559. W3 PARTNERS, LLC, ROGERS, AR. SN 78-678,106. PUB. 4-11-2006, FILED 7-26-2005.

Olde Hearth

CLASS 30—(Continued).

THE MARK CONSISTS OF STANDARD CHARACTERS WITHOUT CLAIM TO ANY PARTICULAR FONT, STYLE, SIZE, OR COLOR.

FOR BAKERY GOODS; BAKERY PRODUCTS (U.S. CL. 46).

FIRST USE 1-0-2006; IN COMMERCE 1-0-2006.

3,178,582. GRUMA CORPORATION, IRVING, TX. SN 78-695,433. PUB. 5-9-2006, FILED 8-18-2005.

TORTILLAS PLUS

THE MARK CONSISTS OF STANDARD CHARACTERS WITHOUT CLAIM TO ANY PARTICULAR FONT, STYLE, SIZE, OR COLOR.

NO CLAIM IS MADE TO THE EXCLUSIVE RIGHT TO USE "TORTILLAS", APART FROM THE MARK AS SHOWN. FOR TORTILLAS (U.S. CL. 46).

FIRST USE 1-0-2006; IN COMMERCE 1-0-2006.

3,178,617. MARS, INCORPORATED, MCLEAN, VA. SN 78-712,765. PUB. 12-6-2005, FILED 9-14-2005.

FINDERS CREEPERS

THE MARK CONSISTS OF STANDARD CHARACTERS WITHOUT CLAIM TO ANY PARTICULAR FONT, STYLE, SIZE, OR COLOR.

FOR CONFECTIONERY, NAMELY, CANDY (U.S. CL. 46).

FIRST USE 9-0-2005; IN COMMERCE 9-0-2005.

3,178,631. SCHWAN'S IP, LLC, MARSHALL, MN. SN 78-720,160. PUB. 1-24-2006, FILED 9-26-2005.

RED BARON THE BIG BARON

THE MARK CONSISTS OF STANDARD CHARACTERS WITHOUT CLAIM TO ANY PARTICULAR FONT, STYLE, SIZE, OR COLOR.

FOR PIZZA (U.S. CL. 46).

FIRST USE 12-1-2005; IN COMMERCE 12-1-2005.

CLASS 30—(Continued).

3,178,644. ROMA FOODS ENTERPRISES, INC., PISCATAWAY, NJ. SN 78-729,963. PUB. 6-13-2006, FILED 10-10-2005.

PIANCONE CREMA D'ORO

THE MARK CONSISTS OF STANDARD CHARACTERS WITHOUT CLAIM TO ANY PARTICULAR FONT, STYLE, SIZE, OR COLOR.

OWNER OF U.S. REG. NO. 1,203,751.
THE FOREIGN WORDING IN THE MARK TRANSLATES INTO ENGLISH AS GOLDEN CREAM.
FOR COFFEE (U.S. CL. 46).
FIRST USE 10-31-2005; IN COMMERCE 10-31-2005.

CLASS 31—NATURAL AGRICULTURAL PRODUCTS

3,177,465. ALL AMERICAN PET COMPANY, INC., BEVERLY HILLS, CA. SN 76-607,428. PUB. 7-5-2005, FILED 8-17-2004.

CHOMPIONS

THE MARK CONSISTS OF STANDARD CHARACTERS WITHOUT CLAIM TO ANY PARTICULAR FONT, STYLE, SIZE, OR COLOR.

FOR PET FOOD (U.S. CLS. 1 AND 46).
FIRST USE 12-31-2004; IN COMMERCE 12-31-2004.

3,177,572. ABBOTT & COBB, INC., TREVOSE, PA. SN 76-641,371. PUB. 4-25-2006, FILED 6-22-2005.

XLS

THE MARK CONSISTS OF STANDARD CHARACTERS WITHOUT CLAIM TO ANY PARTICULAR FONT, STYLE, SIZE, OR COLOR.

FOR FRUITED VEGETABLE SEEDS FOR PLANTING AND UNPROCESSED FRESH FRUITED VEGETABLES (U.S. CLS. 1 AND 46).
FIRST USE 11-9-2004; IN COMMERCE 11-9-2004.

CLASS 31—(Continued).

3,177,579. ABBOTT & COBB, INC., TREVOSE, PA. SN 76-645,286. PUB. 5-9-2006, FILED 8-19-2005.

VITA SWEET

THE MARK CONSISTS OF STANDARD CHARACTERS WITHOUT CLAIM TO ANY PARTICULAR FONT, STYLE, SIZE, OR COLOR.

OWNER OF U.S. REG. NO. 1,397,855.
NO CLAIM IS MADE TO THE EXCLUSIVE RIGHT TO USE "SWEET", APART FROM THE MARK AS SHOWN.
FOR VEGETABLE AND FRUIT SEEDS FOR PLANTING AND FRESH VEGETABLES AND FRUIT (U.S. CLS. 1 AND 46).
FIRST USE 1-1-1990; IN COMMERCE 1-1-1990.

3,177,632. TURF MERCHANTS, INC., TANGENT, OR. SN 78-190,621. PUB. 6-24-2003, FILED 12-3-2002.

DSR

FOR GRASS SEED (U.S. CLS. 1 AND 46).
FIRST USE 4-28-2006; IN COMMERCE 4-28-2006.

3,177,668. KIRIN BEER KABUSHIKI KAISHA, TA KIRIN BREWERY CO., LTD., CHUO-KU, TOKYO, JAPAN. SN 78-281,430. PUB. 4-27-2004, FILED 7-31-2003.

PRIMLET

FOR LIVE PRIMROSE PLANTS AND SEEDS FOR PRIMROSE PLANTS (U.S. CLS. 1 AND 46).
FIRST USE 11-22-2005; IN COMMERCE 11-22-2005.

3,177,688. WITTEMAN HOLDING B.V., 2180AA HILLEGOM, NETHERLANDS. SN 78-302,374. PUB. 5-25-2004, FILED 9-18-2003.

MIGHTY

FOR LIVING ORNAMENTAL PLANTS (U.S. CLS. 1 AND 46).
FIRST USE 9-6-2006; IN COMMERCE 9-6-2006.

CLASS 31—(Continued).

3,177,710. BAHARI ENTERPRISES INC., GREENPORT, NY.
SN 78-331,076. PUB. 4-4-2006, FILED 11-20-2003.

Pipes Cove Oysters

THE MARK CONSISTS OF STANDARD CHARACTERS WITHOUT CLAIM TO ANY PARTICULAR FONT, STYLE, SIZE, OR COLOR.

NO CLAIM IS MADE TO THE EXCLUSIVE RIGHT TO USE "OYSTERS", APART FROM THE MARK AS SHOWN. FOR LIVE OYSTERS (U.S. CLS. 1 AND 46). FIRST USE 11-12-2003; IN COMMERCE 11-12-2003.

3,177,814. E.G. HILL COMPANY, INC., RICHMOND, IN. SN 78-404,749. PUB. 6-21-2005, FILED 4-20-2004.

ERIN

THE MARK CONSISTS OF STANDARD CHARACTERS WITHOUT CLAIM TO ANY PARTICULAR FONT, STYLE, SIZE, OR COLOR.

FOR LIVE ROSE PLANTS AND PARTS OF ROSE PLANTS, NAMELY CUT FLOWERS (U.S. CLS. 1 AND 46). FIRST USE 2-0-2004; IN COMMERCE 2-0-2004.

CLASS 31—(Continued).

3,177,974. FLICK, STEVE A., KINGSVILLE, MO. SN 78-473,483. PUB. 10-4-2005, FILED 8-25-2004.

AMERICAN PRIDE NATIVE PRAIRIE FESCUE GRASS SEED

THE MARK CONSISTS OF STANDARD CHARACTERS WITHOUT CLAIM TO ANY PARTICULAR FONT, STYLE, SIZE, OR COLOR.

NO CLAIM IS MADE TO THE EXCLUSIVE RIGHT TO USE "AMERICAN" AND "FESCUE GRASS SEED", APART FROM THE MARK AS SHOWN.

FOR AGRICULTURAL SEED, NAMELY, FESCUE GRASS SEED (U.S. CLS. 1 AND 46). FIRST USE 10-15-2005; IN COMMERCE 10-15-2005.

3,177,990. SAKATA SEED CORPORATION, YOKOHAMA, JAPAN. SN 78-478,246. PUB. 7-12-2005, FILED 9-2-2004.

SunPatiens

THE MARK CONSISTS OF STANDARD CHARACTERS WITHOUT CLAIM TO ANY PARTICULAR FONT, STYLE, SIZE, OR COLOR.

FOR SEEDS FOR HORTICULTURAL PURPOSES, NAMELY, FLOWER SEEDS; LIVE FLOWER PRODUCTS, NAMELY, IMPATIENS (U.S. CLS. 1 AND 46). FIRST USE 3-16-2006; IN COMMERCE 3-16-2006.

CLASS 31—(Continued).

3,178,020. STONEVILLE PEDIGREED SEED COMPANY, ST. LOUIS, MO. SN 78-492,138. PUB. 12-27-2005, FILED 9-30-2004.

The Next Generation of Cotton

THE MARK CONSISTS OF STANDARD CHARACTERS WITHOUT CLAIM TO ANY PARTICULAR FONT, STYLE, SIZE, OR COLOR.

NO CLAIM IS MADE TO THE EXCLUSIVE RIGHT TO USE "COTTON", APART FROM THE MARK AS SHOWN. FOR COTTON SEED (U.S. CLS. 1 AND 46). FIRST USE 7-31-2004; IN COMMERCE 7-31-2004.

3,178,043. DISTINCTIVE COMPONENTS LTD., BALDWIN, MD. SN 78-505,218. PUB. 9-27-2005, FILED 10-25-2004.

"Potpourri for your Pots"

THE MARK CONSISTS OF STANDARD CHARACTERS WITHOUT CLAIM TO ANY PARTICULAR FONT, STYLE, SIZE, OR COLOR.

FOR MULCHES FOR PLANTS (U.S. CLS. 1 AND 46). FIRST USE 1-12-2006; IN COMMERCE 1-12-2006.

3,178,349. GIORGIFRED COMPANY, WILMINGTON, DE. SN 78-598,292. PUB. 12-27-2005, FILED 3-30-2005.

SALAD 'SHROOMS

CLASS 31—(Continued).

THE MARK CONSISTS OF STANDARD CHARACTERS WITHOUT CLAIM TO ANY PARTICULAR FONT, STYLE, SIZE, OR COLOR.

FOR FRESH MUSHROOMS (U.S. CLS. 1 AND 46). FIRST USE 4-11-2005; IN COMMERCE 4-11-2005.

3,178,526. THE MEOW MIX COMPANY, SECAUCUS, NJ. SN 78-664,900. PUB. 3-28-2006, FILED 7-6-2005.

CRUSTACEAN CRUNCH

THE MARK CONSISTS OF STANDARD CHARACTERS WITHOUT CLAIM TO ANY PARTICULAR FONT, STYLE, SIZE, OR COLOR.

FOR PET FOOD AND PET TREATS (U.S. CLS. 1 AND 46). FIRST USE 10-1-2005; IN COMMERCE 10-1-2005.

3,178,527. THE MEOW MIX COMPANY, SECAUCUS, NJ. SN 78-664,991. PUB. 3-28-2006, FILED 7-6-2005.

ON THE RANGE

THE MARK CONSISTS OF STANDARD CHARACTERS WITHOUT CLAIM TO ANY PARTICULAR FONT, STYLE, SIZE, OR COLOR.

FOR PET FOOD AND PET TREATS (U.S. CLS. 1 AND 46). FIRST USE 10-1-2005; IN COMMERCE 10-1-2005.

3,178,613. KAYTEE PRODUCTS INCORPORATED, CHILTON, WI. SN 78-712,131. PUB. 2-14-2006, FILED 9-13-2005.

EGG-CITE!

THE MARK CONSISTS OF STANDARD CHARACTERS WITHOUT CLAIM TO ANY PARTICULAR FONT, STYLE, SIZE, OR COLOR.

FOR SMALL ANIMAL FOOD (U.S. CLS. 1 AND 46). FIRST USE 2-0-2006; IN COMMERCE 2-0-2006.

CLASS 31—(Continued).

3,178,625. SOCIETE DES PRODUITS NESTLE S.A., VEVEY, SWITZERLAND. SN 78-715,789. PUB. 5-23-2006, FILED 9-19-2005.

CLASS 32—(Continued).

3,177,790. SUPERVALU INC., EDEN PRAIRIE, MN. SN 78-392,363. PUB. 12-28-2004, FILED 3-29-2004.

ELEGANT MEDLEYS

THE MARK CONSISTS OF STANDARD CHARACTERS WITHOUT CLAIM TO ANY PARTICULAR FONT, STYLE, SIZE, OR COLOR.

FOR CAT FOOD (U.S. CLS. 1 AND 46).
FIRST USE 6-19-2006; IN COMMERCE 6-19-2006.

FRUITENSITY

THE MARK CONSISTS OF STANDARD CHARACTERS WITHOUT CLAIM TO ANY PARTICULAR FONT, STYLE, SIZE, OR COLOR.

FOR SOFT DRINKS; NON-CARBONATED FRUIT DRINKS; FRUIT JUICE; FRUIT JUICE CONCENTRATES; POWDERED PREPARATIONS FOR MAKING SOFT DRINKS (U.S. CLS. 45, 46 AND 48).

FIRST USE 1-3-2005; IN COMMERCE 1-3-2005.

CLASS 32—LIGHT BEVERAGES

3,177,535. THIRSTY DOG BREWING COMPANY, INDEPENDENCE, OH. SN 76-628,237. PUB. 10-25-2005, FILED 1-18-2005.

CALIFORNIA CRISP

THE MARK CONSISTS OF STANDARD CHARACTERS WITHOUT CLAIM TO ANY PARTICULAR FONT, STYLE, SIZE, OR COLOR.

FOR MALT BEVERAGES, NAMELY, BEER AND ALE (U.S. CLS. 45, 46 AND 48).
FIRST USE 3-23-2001; IN COMMERCE 3-23-2001.

3,177,913. RWI RESOURCES, LLC, MARIETTA, GA. SN 78-453,223. PUB. 7-5-2005, FILED 7-20-2004.

ZIPTIDE

3,177,578. CARMEL SUNSET GROUP, LLC, LAS VEGAS, NV. SN 76-645,189. PUB. 5-2-2006, FILED 8-18-2005.

GIGGLE WATER

THE MARK CONSISTS OF STANDARD CHARACTERS WITHOUT CLAIM TO ANY PARTICULAR FONT, STYLE, SIZE, OR COLOR.

FOR NON-ALCOHOLIC ENERGY DRINK STIMULATING ALERTNESS, ENERGY-STAMINA AND BRIGHTNESS (U.S. CLS. 45, 46 AND 48).
FIRST USE 11-19-2005; IN COMMERCE 11-19-2005.

THE MARK CONSISTS OF STANDARD CHARACTERS WITHOUT CLAIM TO ANY PARTICULAR FONT, STYLE, SIZE, OR COLOR.

OWNER OF U.S. REG. NO. 2,875,637.
FOR BEVERAGES, NAMELY, FLAVORED AND NON-FLAVORED SPARKLING WATER, SPRING WATER, CAFFEINATED AND NON-CAFFEINATED DRINKS WITH OR WITHOUT FRUIT FLAVORING, SMOOTHIES AND CAFFEINATED AND NON-CAFFEINATED TEA (U.S. CLS. 45, 46 AND 48).

FIRST USE 8-24-2006; IN COMMERCE 8-24-2006.

CLASS 32—(Continued).

3,177,972. OY NORD WATER LTD., 00240 HELSINKI, FINLAND. SN 78-472,890. PUB. 9-27-2005, FILED 8-24-2004.

CLASS 32—(Continued).

3,178,078. ICA CO., LTD., SEOUL, REPUBLIC OF KOREA. SN 78-522,124. PUB. 1-24-2006, FILED 11-23-2004.

DERMONA

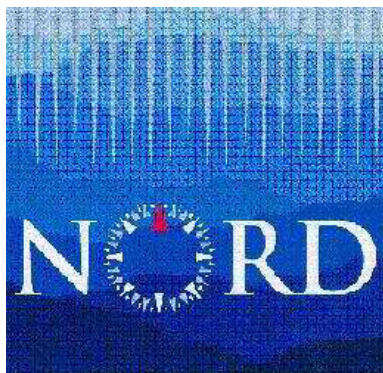

THE MARK CONSISTS OF STANDARD CHARACTERS WITHOUT CLAIM TO ANY PARTICULAR FONT, STYLE, SIZE, OR COLOR.

FOR CONCENTRATED CHERRY FRUIT JUICE; VEGETABLE JUICE FOR BEVERAGES; NON-ALCOHOLIC MALT BEVERAGES, NAMELY, NON-ALCOHOLIC SWEET MALT DRINKS PREPARED WITH RICE; FRUIT POWDER AND FRUIT SYRUP FOR MAKING FRUIT DRINKS; CONCENTRATED FRUIT JUICE; LEMONADES; SYRUP FOR MAKING LEMONADE; MANDARIN ORANGE JUICE; POWDERS AND PASTILLES USED IN THE PREPARATION OF SOFT DRINKS, NAMELY, EFFERVESCING BEVERAGES; NON-ALCOHOLIC FRUIT NECTARS; NON-ALCOHOLIC COCKTAILS; APPLE JUICE; SODA POP; SELTZER WATER; SODA WATER; ISOTONIC BEVERAGES; ORANGE JUICE; WHEY BEVERAGES; NON-ALCOHOLIC BEVERAGES, NAMELY, SHERBETS; GINSENG JUICE; GINGER ALE; COLA SYRUP USED IN THE PREPARATION OF SOFT DRINKS; AERATED WATER; PINEAPPLE JUICE; UNFERMENTED MUST; GRAPE JUICE; NATURAL AND ARTIFICIAL MINERAL WATER; SPRING WATER (U.S. CLS. 45, 46 AND 48).

FIRST USE 9-2-2005; IN COMMERCE 9-2-2005.

3,178,133. SUNNY DELIGHT BEVERAGES CO., CINCINNATI, OH. SN 78-547,208. PUB. 12-27-2005, FILED 1-13-2005.

THE COLORS DARK BLUE, LIGHT BLUE, WHITE, SILVER, AND RED ARE CLAIMED AS A FEATURE OF THE MARK.

THE COLOR DARK BLUE APPEARS IN THE FIRST, SECOND, AND THIRD MOUNTAIN RANGES IN THE MARK, THE COLOR LIGHT BLUE APPEARS IN THE SKY AND FOURTH, FIFTH, AND SIXTH MOUNTAIN RANGES IN THE MARK, THE COLOR WHITE APPEARS IN THE LETTERING AND BACKGROUND COMPASS POINTS IN THE MARK, THE COLOR SILVER APPEARS IN THE FOREGROUND COMPASS POINTS AND THE DESCENDING VERTICAL LINES IN THE MARK, AND THE COLOR RED APPEARS IN THE ARROW IN THE COMPASS IN THE MARK.

THE ENGLISH TRANSLATION OF THE ITALIAN AND SWEDISH WORD "NORD" IS "NORTH".

FOR STILL WATER, SPARKLING OR AERATED WATER, PROCESSED WATER, SPRING WATER (U.S. CLS. 45, 46 AND 48).

FIRST USE 4-30-2004; IN COMMERCE 3-31-2005.

SUNNY D BAJA

THE MARK CONSISTS OF STANDARD CHARACTERS WITHOUT CLAIM TO ANY PARTICULAR FONT, STYLE, SIZE, OR COLOR.

OWNER OF U.S. REG. NOS. 1,343,111, 1,367,998, AND 1,734,136.

FOR FRUIT JUICE DRINKS CONTAINING WATER, FRUIT PUNCH AND FRUIT JUICE NECTAR (U.S. CLS. 45, 46 AND 48).

FIRST USE 7-13-2006; IN COMMERCE 7-13-2006.

CLASS 32—(Continued).

3,178,148. OLD EUROPEAN BREWERY COMPANY, SAN DIEGO, CA. SN 78-552,838. PUB. 10-25-2005, FILED 1-24-2005.

QUICK CHILL

THE MARK CONSISTS OF STANDARD CHARACTERS WITHOUT CLAIM TO ANY PARTICULAR FONT, STYLE, SIZE, OR COLOR.
FOR BEER; SOFT DRINKS (U.S. CLS. 45, 46 AND 48).
FIRST USE 6-5-2005; IN COMMERCE 6-5-2005.

3,178,238. THE KROGER CO. OF MICHIGAN, LIVONIA, MI. SN 78-576,896. PUB. 11-22-2005, FILED 2-28-2005.

STOW 'N GO

THE MARK CONSISTS OF STANDARD CHARACTERS WITHOUT CLAIM TO ANY PARTICULAR FONT, STYLE, SIZE, OR COLOR.
FOR CARBONATED BEVERAGES, NAMELY SOFT DRINKS AND SPARKLING WATERS SOLD IN CARDBOARD CARTONS (U.S. CLS. 45, 46 AND 48).
FIRST USE 5-1-2006; IN COMMERCE 5-1-2006.

CLASS 32—(Continued).

3,178,383. DEAD RED CORPORATION, UNIVERSITY PLACE, WA. SN 78-607,342. PUB. 2-28-2006, FILED 4-12-2005.

DEAD RED

THE MARK CONSISTS OF STANDARD CHARACTERS WITHOUT CLAIM TO ANY PARTICULAR FONT, STYLE, SIZE, OR COLOR.
OWNER OF U.S. REG. NOS. 2,323,770 AND 2,398,698.
FOR NON-ALCOHOLIC BEVERAGE, NAMELY, CARBONATED BEVERAGE (U.S. CLS. 45, 46 AND 48).
FIRST USE 4-6-2006; IN COMMERCE 4-6-2006.

3,178,578. NUTRISYSTEM IPHC, INC., WILMINGTON, DE. SN 78-690,205. PUB. 4-25-2006, FILED 8-10-2005.

NUTRIPEPTIDE

THE MARK CONSISTS OF STANDARD CHARACTERS WITHOUT CLAIM TO ANY PARTICULAR FONT, STYLE, SIZE, OR COLOR.
FOR FRUIT DRINKS, FRUIT JUICES, AND OTHER PREPARATIONS, NAMELY, POWDER MIXES FOR MAKING LEMONADE AND CITRUS FLAVORED DRINKS, AND ORANGEADE (U.S. CLS. 45, 46 AND 48).
FIRST USE 11-11-2005; IN COMMERCE 11-11-2005.

3,178,593. TSITSUASHVILI, ZURAB, FOREST HILLS, NY. SN 78-702,073. PUB. 5-30-2006, FILED 8-28-2005.

Mr. Re

THE MARK CONSISTS OF STANDARD CHARACTERS WITHOUT CLAIM TO ANY PARTICULAR FONT, STYLE, SIZE, OR COLOR.
FOR BEVERAGES, NAMELY, NON-ALCOHOLIC AERATED WATER CONSISTING OF BOTH FRUIT AND HERB SYRUPS (U.S. CLS. 45, 46 AND 48).
FIRST USE 9-1-2006; IN COMMERCE 9-1-2006.

CLASS 32—(Continued).

3,178,602. THE COCA-COLA COMPANY, ATLANTA, GA. SN 78-707,244. PUB. 5-23-2006, FILED 9-6-2005.



THE MARK CONSISTS OF AN "S" DESIGN, FOR NON-ALCOHOLIC BEVERAGES, NAMELY CARBONATED SOFT DRINKS; SYRUPS AND CONCENTRATES FOR MAKING NON-ALCOHOLIC BEVERAGES, NAMELY CARBONATED SOFT DRINKS (U.S. CLS. 45, 46 AND 48).
FIRST USE 5-23-2006; IN COMMERCE 5-23-2006.

CLASS 33—(Continued).

3,177,356. RED HEAD, INC., DBA CABO WABO ENTERPRISES, NOVATO, CA. SN 76-370,742. PUB. 12-27-2005, FILED 2-13-2002.

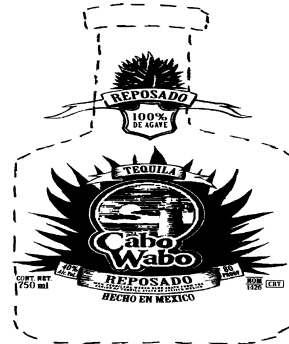

NO CLAIM IS MADE TO THE EXCLUSIVE RIGHT TO USE "TEQUILA" AND "HECHO EN MEXICO" AND "100% DE AGAVE, 40% ALC. VOL., 100%. WEBER BLUE AGAVE FROM THE REGION OF TEQUILA, STATE OF JALISCO, MEXICO." 80 PROOF", "NOM 1426 CRT", "CONT. NET 750 ML", APART FROM THE MARK AS SHOWN.

THE LINING IS FOR SHADING PURPOSES ONLY.
THE WORDS "100% TEQUILANA WEBER BLUE AGAVE FROM THE REGION OF TEQUILA, STATE OF JALISCO MEXICO" ARE FEATURED IN SMALL PRINT BETWEEN THE WORDS "REPOSADO" AND "HECHO EN MEXICO".
THE SPANISH WORD "REPOSADO" MEANS "RESTED" IN ENGLISH. THE WORD "DE" TRANSLATES TO "OF". THE ENGLISH TRANSLATION FOR THE WORD "CABO" IS "CAPE". THE TERM "WABO" HAS NO MEANING IN ANY LANGUAGE. THE ENGLISH TRANSLATION FOR "HECHO EN MEXICO" IS "MADE IN MEXICO".
FOR TEQUILA (U.S. CLS. 47 AND 49).
FIRST USE 7-31-2002; IN COMMERCE 7-31-2002.

3,177,407. QUAKING HILLS WINERY, INC., CLOVERDALE, CA. SN 76-552,758. PUB. 6-8-2004, FILED 10-1-2003.

QUAKING HILLS

FOR WINE (U.S. CLS. 47 AND 49).
FIRST USE 8-1-2005; IN COMMERCE 11-1-2005.

CLASS 33—WINES AND SPIRITS

CLASS 33—(Continued).

3,177,546. EVO, INC., YOUNTVILLE, CA. SN 76-633,477. PUB. 12-13-2005, FILED 3-18-2005.

MODICUM

THE MARK CONSISTS OF STANDARD CHARACTERS WITHOUT CLAIM TO ANY PARTICULAR FONT, STYLE, SIZE, OR COLOR.

FOR WINE (U.S. CLS. 47 AND 49).
FIRST USE 5-31-2004; IN COMMERCE 5-31-2004.

3,177,570. LIQUOR BARN # 3, LLC., LEXINGTON, KY. SN 76-640,709. PUB. 3-14-2006, FILED 6-13-2005.

NINGALOO

THE MARK CONSISTS OF STANDARD CHARACTERS WITHOUT CLAIM TO ANY PARTICULAR FONT, STYLE, SIZE, OR COLOR.

FOR WINE (U.S. CLS. 47 AND 49).
FIRST USE 12-8-2005; IN COMMERCE 12-8-2005.

3,177,634. PERNOD RICARD USA, WHITE PLAINS, NY. SN 78-200,611. PUB. 11-1-2005, FILED 1-7-2003.

SEAGRAM'S SMOOTH

OWNER OF U.S. REG. NOS. 301,726, 2,613,238, AND OTHERS.

NO CLAIM IS MADE TO THE EXCLUSIVE RIGHT TO USE "SMOOTH", APART FROM THE MARK AS SHOWN.

FOR ALCOHOLIC MALT COOLERS (U.S. CLS. 47 AND 49).
FIRST USE 3-31-2003; IN COMMERCE 3-31-2003.

CLASS 33—(Continued).

3,177,643. SOCIEDADE VITIVINICOLA QUINTA DE SANTA EUFEMIA, LDA, PORTO, PORTUGAL. SN 78-231,011. PUB. 6-14-2005, FILED 3-27-2003.

QUINTA SANTA EUFEMIA

THE MARK CONSISTS OF STANDARD CHARACTERS WITHOUT CLAIM TO ANY PARTICULAR FONT, STYLE, SIZE, OR COLOR.

NO CLAIM IS MADE TO THE EXCLUSIVE RIGHT TO USE "QUINTA", APART FROM THE MARK AS SHOWN.

THE MARK TRANSLATES INTO ENGLISH AS ESTATE OF SANTA EUFEMIA.

FOR WINE (U.S. CLS. 47 AND 49).
FIRST USE 0-0-1964; IN COMMERCE 9-13-2001.

3,177,686. E. & J. GALLO WINERY, MODESTO, CA. SN 78-302,040. PUB. 6-8-2004, FILED 9-18-2003.

MATTIE'S PERCH

FOR WINES (U.S. CLS. 47 AND 49).
FIRST USE 8-24-2006; IN COMMERCE 8-24-2006.

3,177,737. HERNANDEZ, ALFONSO P, JERSEY CITY, NJ. AND MALONY, ERIC, JERSEY CITY, NJ. SN 78-357,030. PUB. 12-27-2005, FILED 1-23-2004.

SANGRIZA

THE MARK CONSISTS OF STANDARD CHARACTERS WITHOUT CLAIM TO ANY PARTICULAR FONT, STYLE, SIZE, OR COLOR.

FOR SANGRIA; FLAVORED BREWED MALT BEVERAGES (U.S. CLS. 47 AND 49).
FIRST USE 8-4-2005; IN COMMERCE 7-19-2006.

CLASS 33—(Continued).

3,177,742. GUY ANDERSON WINES LTD., SHERBORNE, UNITED KINGDOM. SN 78-362,497. PUB. 12-20-2005, FILED 2-4-2004.

Mad Dogs and Englishmen

THE MARK CONSISTS OF STANDARD CHARACTERS WITHOUT CLAIM TO ANY PARTICULAR FONT, STYLE, SIZE, OR COLOR.
FOR WINES (U.S. CLS. 47 AND 49).
FIRST USE 4-3-2004; IN COMMERCE 4-3-2004.

3,177,773. INGLEBURNE WINE COMPANY PTY LTD, SOUTH AUSTRALIA, AUSTRALIA. SN 78-385,073. PUB. 6-14-2005, FILED 3-16-2004.

PENNY'S HILL RED DOT

THE MARK CONSISTS OF STANDARD CHARACTERS WITHOUT CLAIM TO ANY PARTICULAR FONT, STYLE, SIZE, OR COLOR.
PRIORITY CLAIMED UNDER SEC. 44(D) ON AUSTRALIA APPLICATION NO. 990398, FILED 2-26-2004, REG. NO. 990398, DATED 2-26-2004, EXPIRES 2-26-2014.
FOR WINES, SPIRITS AND LIQUEURS (U.S. CLS. 47 AND 49).
FIRST USE 5-5-2004; IN COMMERCE 5-5-2004.

3,177,813. DIAGEO NORTH AMERICA, INC., NORWALK, CT. SN 78-403,880. PUB. 5-24-2005, FILED 4-19-2004.

TATTOO YOUR NIGHT

THE MARK CONSISTS OF STANDARD CHARACTERS WITHOUT CLAIM TO ANY PARTICULAR FONT, STYLE, SIZE, OR COLOR.
FOR ALCOHOLIC BEVERAGES, NAMELY, RUM, AND FLAVORED RUMS (U.S. CLS. 47 AND 49).
FIRST USE 4-30-2005; IN COMMERCE 4-30-2005.

CLASS 33—(Continued).

3,177,900. DAUCOURT MARTIN IMPORTS, LLC, DALLAS, TX. SN 78-449,457. PUB. 6-7-2005, FILED 7-12-2004.

JEAN-MARC

THE MARK CONSISTS OF STANDARD CHARACTERS WITHOUT CLAIM TO ANY PARTICULAR FONT, STYLE, SIZE, OR COLOR.
THE NAME JEAN-MARC IDENTIFIES A LIVING INDIVIDUAL WHOSE CONSENT IS OF RECORD.
FOR DISTILLED SPIRITS (U.S. CLS. 47 AND 49).
FIRST USE 1-0-2004; IN COMMERCE 1-0-2004.

3,177,915. CHURCHILL AND CARR LIMITED, ST. HELIER, JERSEY. SN 78-454,478. PUB. 11-22-2005, FILED 7-21-2004.

SOLALTO

THE MARK CONSISTS OF STANDARD CHARACTERS WITHOUT CLAIM TO ANY PARTICULAR FONT, STYLE, SIZE, OR COLOR.
FOR WINE (U.S. CLS. 47 AND 49).
FIRST USE 1-5-2006; IN COMMERCE 1-5-2006.

CLASS 33—(Continued).

3,177,919. SINCLAIR, DANIEL J., JR., MANDEVILLE, LA. SN 78-456,716. PUB. 10-11-2005, FILED 7-26-2004.

KUSH

THE MARK CONSISTS OF STANDARD CHARACTERS WITHOUT CLAIM TO ANY PARTICULAR FONT, STYLE, SIZE, OR COLOR.

FOR ALCOHOLIC BEVERAGES, NAMELY WINES, BRANDY, BRANDY SPIRITS, CALVADOS, LIQUORS, COGNAC, DISTILLED SPIRITS, HERB LIQUEURS (U.S. CLS. 47 AND 49).

FIRST USE 12-31-2005; IN COMMERCE 1-31-2006.

3,178,115. BARTON BRANDS, LTD., CHICAGO, IL. SN 78-537,860. PUB. 2-14-2006, FILED 12-23-2004.

**DANFIELD'S PRIVATE
RESERVE**

THE MARK CONSISTS OF STANDARD CHARACTERS WITHOUT CLAIM TO ANY PARTICULAR FONT, STYLE, SIZE, OR COLOR.

NO CLAIM IS MADE TO THE EXCLUSIVE RIGHT TO USE "PRIVATE RESERVE", APART FROM THE MARK AS SHOWN.

FOR ALCOHOLIC BEVERAGES, NAMELY WHISKY (U.S. CLS. 47 AND 49).

FIRST USE 9-1-2005; IN COMMERCE 9-1-2005.

CLASS 33—(Continued).

3,178,155. DIAGEO NORTH AMERICA, INC., NORWALK, CT. SN 78-556,791. PUB. 12-27-2005, FILED 1-31-2005.

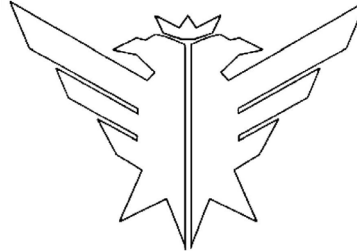

THE MARK CONSISTS OF AN EAGLE DESIGN WITH CROWN.

FOR ALCOHOLIC BEVERAGES, NAMELY, DISTILLED SPIRITS, PREPARED ALCOHOLIC COCKTAILS, AND FLAVORED BREWED MALT BEVERAGES (U.S. CLS. 47 AND 49).

FIRST USE 9-1-2003; IN COMMERCE 9-1-2003.

3,178,186. BRINTON, WILLIAM W., SONOMA, CA. SN 78-566,341. PUB. 12-27-2005, FILED 2-13-2005.

Club Tecolote

THE MARK CONSISTS OF STANDARD CHARACTERS WITHOUT CLAIM TO ANY PARTICULAR FONT, STYLE, SIZE, OR COLOR.

THE ENGLISH TRANSLATION OF THE WORD "TELECOTE" IN THE MARK IS "OWL".

FOR WINE (U.S. CLS. 47 AND 49).

FIRST USE 9-27-2004; IN COMMERCE 1-3-2005.

3,178,253. DIAGEO NORTH AMERICA, INC., NORWALK, CT. SN 78-580,609. PUB. 10-4-2005, FILED 3-4-2005.

Beaulieu Vineyard

OWNER OF U.S. REG. NOS. 1,159,373, 2,409,799, AND OTHERS.

NO CLAIM IS MADE TO THE EXCLUSIVE RIGHT TO USE "VINEYARD", APART FROM THE MARK AS SHOWN.

CLASS 33—(Continued).

THE ENGLISH TRANSLATION OF THE WORD "BEAU-LIEU" IN THE MARK IS "BEAUTIFUL PLACE".
FOR ALCOHOLIC BEVERAGES, NAMELY, WINES
(U.S. CLS. 47 AND 49).
FIRST USE 0-0-1936; IN COMMERCE 0-0-1936.

CLASS 33—(Continued).

3,178,374. SWIERZEWSKI, STANLEY J. III, HOLYOKE, MA.
SN 78-603,789. PUB. 1-3-2006, FILED 4-7-2005.

3,178,277. SOUTH WEST DISTILLERS PTY LTD., DURBAN
NORTH, SOUTH AFRICA. SN 78-586,216. PUB. 12-13-2005,
FILED 3-14-2005.

STOWETINI

HOG MASTER

THE MARK CONSISTS OF STANDARD CHARACTERS
WITHOUT CLAIM TO ANY PARTICULAR FONT, STYLE,
SIZE, OR COLOR.
FOR LIQUEURS, NAMELY HERB LIQUEURS (U.S.
CLS. 47 AND 49).
FIRST USE 5-24-2006; IN COMMERCE 8-18-2006.

THE MARK CONSISTS OF STANDARD CHARACTERS
WITHOUT CLAIM TO ANY PARTICULAR FONT, STYLE,
SIZE, OR COLOR.
FOR PREPARED ALCOHOLIC COCKTAIL (U.S. CLS.
47 AND 49).
FIRST USE 2-1-2006; IN COMMERCE 2-1-2006.

3,178,341. MENDOCINO WINE GROUP, UKIAH, CA. SN 78-
597,056. PUB. 12-27-2005, FILED 3-29-2005.

3,178,398. LAVA VINE LLC, CALISTOGA, CA. SN 78-614,146.
PUB. 1-10-2006, FILED 4-21-2005.

True Grit

ZACHERLE

THE MARK CONSISTS OF STANDARD CHARACTERS
WITHOUT CLAIM TO ANY PARTICULAR FONT, STYLE,
SIZE, OR COLOR.
FOR WINE (U.S. CLS. 47 AND 49).
FIRST USE 8-28-2006; IN COMMERCE 8-28-2006.

THE MARK CONSISTS OF STANDARD CHARACTERS
WITHOUT CLAIM TO ANY PARTICULAR FONT, STYLE,
SIZE, OR COLOR.
FOR WINES (U.S. CLS. 47 AND 49).
FIRST USE 8-30-2006; IN COMMERCE 8-30-2006.

CLASS 33—(Continued).

3,178,432. FASHION SPIRITS, LLP, LONDON, UNITED KINGDOM. SN 78-628,438. PUB. 5-16-2006, FILED 5-12-2005.

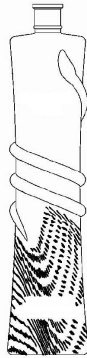

FOR VODKA (U.S. CLS. 47 AND 49).
FIRST USE 6-1-2005; IN COMMERCE 6-1-2005.

CLASS 33—(Continued).

3,178,505. SOUTH WEST LIQUORS (PTY) LTD., DURBAN NORTH, KWA ZULU NATAL, SOUTH AFRICA. SN 78-658,334. PUB. 4-11-2006, FILED 6-25-2005.



NO CLAIM IS MADE TO THE EXCLUSIVE RIGHT TO USE "AFRICAN CREAM LIQUEUR", "750 ML", "17% VOL", AND "PRODUCED AND BOTTLED IN THE REPUBLIC OF SOUTH AFRICA", APART FROM THE MARK AS SHOWN. THE COLOR(S) BLACK, WHITE, GOLD AND RED IS/ARE CLAIMED AS A FEATURE OF THE MARK.

THE COLORS RED, GOLD AND WHITE APPEAR IN THE BORDER SURROUNDING THE IMAGE. THE COLOR GOLD APPEARS IN THE WORDS "BWANA", "THE SAVANNAH KING'S CHOICE", "750 ML", "LIQUEUR", "17% VOL", AND "PRODUCED AND BOTTLED IN THE REPUBLIC OF SOUTH AFRICA". THE COLORS BLACK AND WHITE APPEAR IN THE LION HEAD AND IN THE STRIPES ABOVE THE WORD "BWANA" AND IN THE STRIPES BELOW THE LION HEAD. THE COLOR BLACK APPEARS IN THE WORD "AFRICAN CREAM" AND THE COLOR WHITE APPEARS IN THE OVAL FRAME AROUND THE WORDS "AFRICAN CREAM". THE COLOR BLACK APPEARS IN THE AREA ON THE LEFT AND RIGHT SIDE OF THE LION HEAD.

FOR LIQUEURS (U.S. CLS. 47 AND 49).
FIRST USE 8-23-2006; IN COMMERCE 8-23-2006.

3,178,470. EAST END MERLOT ALLIANCE INC., CUTCROGUE, NY. SN 78-642,315. PUB. 2-21-2006, FILED 6-2-2005.

MERLIANCE

THE MARK CONSISTS OF STANDARD CHARACTERS WITHOUT CLAIM TO ANY PARTICULAR FONT, STYLE, SIZE, OR COLOR.

FOR WINE (U.S. CLS. 47 AND 49).
FIRST USE 9-1-2006; IN COMMERCE 9-1-2006.

3,178,487. DIAGEO NORTH AMERICA, INC., NORWALK, CT. SN 78-650,394. PUB. 3-7-2006, FILED 6-14-2005.

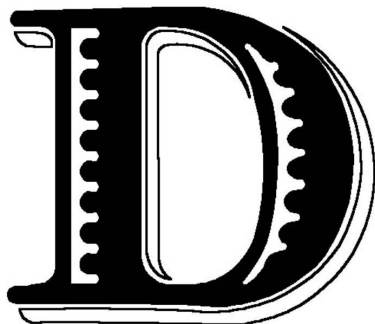

FOR ALCOHOLIC BEVERAGES, NAMELY, LIQUEURS (U.S. CLS. 47 AND 49).
FIRST USE 9-0-2005; IN COMMERCE 9-0-2005.

3,178,512. KNOWLEDGE BASED CONSULTING, INC, SAN FRANCISCO, CA. SN 78-660,003. PUB. 3-28-2006, FILED 6-28-2005.

CURIOUS BEAGLE

THE MARK CONSISTS OF STANDARD CHARACTERS WITHOUT CLAIM TO ANY PARTICULAR FONT, STYLE, SIZE, OR COLOR.

FOR WINE (U.S. CLS. 47 AND 49).
FIRST USE 9-8-2006; IN COMMERCE 9-8-2006.

CLASS 33—(Continued).

3,178,656. KNOWLEDGE BASED CONSULTING, INC, SAN FRANCISCO, CA. SN 78-768,578. PUB. 3-28-2006, FILED 12-7-2005.

SURFING BEAGLE

THE MARK CONSISTS OF STANDARD CHARACTERS WITHOUT CLAIM TO ANY PARTICULAR FONT, STYLE, SIZE, OR COLOR.

FOR WINE (U.S. CLS. 47 AND 49).
FIRST USE 9-8-2006; IN COMMERCE 9-8-2006.

CLASS 34—(Continued).

3,178,215. SELECTOS VARADERO, INC., MIAMI, FL. SN 78-572,878. PUB. 2-28-2006, FILED 2-23-2005.

SELECTOS VARADERO

THE MARK CONSISTS OF STANDARD CHARACTERS WITHOUT CLAIM TO ANY PARTICULAR FONT, STYLE, SIZE, OR COLOR.

NO CLAIM IS MADE TO THE EXCLUSIVE RIGHT TO USE "SELECTOS", APART FROM THE MARK AS SHOWN. THE ENGLISH TRANSLATION OF SELECTOS VARADERO IS SELECT VARADERO.

FOR CIGARS; CIGARILLOS; CIGAR BANDS; CIGAR CUTTERS; CIGAR TUBES; HUMIDORS; MATCHES; MATCH BOXES NOT OF PRECIOUS METAL; MATCH HOLDERS NOT OF PRECIOUS METAL; NON-ELECTRIC CIGAR LIGHTERS NOT OF PRECIOUS METAL; SMOKING TOBACCO; SMOKING PIPES; SMOKING PIPES CLEANERS; SMOKING URNS; TOBACCO; TOBACCO POUCHES; TOBACCO SPITTOONS; SNUFF; SNUFF BOXES, NOT OF PRECIOUS METAL; SMOKELESS TOBACCO; CHEWING TOBACCO; ASHTRAYS, NOT OF PRECIOUS METAL; CIGARETTES CONTAINING TOBACCO SUBSTITUTES NOT FOR MEDICAL PURPOSES; CIGARETTES; CIGARETTES ROLLING PAPERS; CIGARETTE PAPERS; CIGARETTE LIGHTERS NOT OF PRECIOUS METAL; CIGARETTE LIGHTERS NOT FOR LAND VEHICLES; CIGARETTE HOLDERS, NOT OF PRECIOUS METAL; CIGARETTE CASES, NOT OF PRECIOUS METAL; CIGARETTE ASH RECEPTACLES; FLINTS FOR LIGHTERS; HERBS FOR SMOKING (U.S. CLS. 2, 8, 9 AND 17).

FIRST USE 3-1-2006; IN COMMERCE 3-1-2006.

CLASS 34—SMOKERS' ARTICLES

3,177,431. MAX ROHR, INC., WILMINGTON, DE. SN 76-580,685. PUB. 12-28-2004, FILED 3-12-2004.

QUIKSMOKE

THE MARK CONSISTS OF STANDARD CHARACTERS WITHOUT CLAIM TO ANY PARTICULAR FONT, STYLE, SIZE, OR COLOR.

FOR CIGARS AND LITTLE CIGARS (U.S. CLS. 2, 8, 9 AND 17).
FIRST USE 8-10-2006; IN COMMERCE 8-10-2006.

3,178,459. K. HANSOTIA & CO., INC., MIAMI, FL. SN 78-638,704. PUB. 3-21-2006, FILED 5-27-2005.

FOR TOBACCO, CIGARETTES, CIGARS; ARTICLES FOR SMOKERS NOT OF PRECIOUS METAL, NAMELY, CIGARETTE LIGHTERS, CIGARETTE CASES, CIGAR CASES, CIGARETTE HOLDERS, AND CIGAR HOLDERS (U.S. CLS. 2, 8, 9 AND 17).

FIRST USE 8-14-2003; IN COMMERCE 9-0-2005.

SERVICE MARKS**CLASS 35—ADVERTISING AND BUSINESS**

CLASS 35—(Continued).

3,177,331. DIGEO, INC., KIRKLAND, WA. SN 76-101,992.
PUB. 2-18-2003, FILED 8-2-2000.



THE MARK CONSISTS OF THE WORDS "DIGEO" WITH AN OUTLINE OF A TELEVISION SCREEN BEGINNING AT THE TOP OF THE "E" AND ENDING BELOW THE "E".

FOR ORDER FULFILLMENT SERVICES FOR OTHERS; PROVIDING BUSINESS MANAGEMENT ASSISTANCE, NAMELY, PROVIDING ASSISTANCE TO MERCHANTS AND CONSUMERS IN CONNECTION WITH ELECTRONIC ORDER AND PAYMENT PROCESSING NAD ORDER FULFILLMENT (U.S. CLS. 100, 101 AND 102).

FIRST USE 5-0-2004; IN COMMERCE 5-0-2004.

3,177,338. NORTH AMERICAN LATINO BEER INDUSTRIES, INC., WHITTIER, CA. SN 76-243,151. PUB. 11-12-2002, FILED 4-19-2001.

OTRA BEER

NO CLAIM IS MADE TO THE EXCLUSIVE RIGHT TO USE "BEER", APART FROM THE MARK AS SHOWN.

THE TERM "OTRA" LITERALLY TRANSLATED IN THE SPANISH LANGUAGE, MEANS "OTHER," OR "ANOTHER".

FOR DISTRIBUTORSHIPS IN THE FIELD OF ALCOHOLIC BEVERAGES (U.S. CLS. 100, 101 AND 102).

FIRST USE 9-1-2001; IN COMMERCE 9-1-2001.

3,177,350. ECAPITAL FINANCIAL CORP., SANTA MONICA, CA. SN 76-335,776. PUB. 12-20-2005, FILED 11-8-2001.

PEACHDIRECT

FOR DISTRIBUTORSHIP SERVICES IN THE FIELD OF COMPUTERS AND COMPUTER PERIPHERALS AND IN THE FIELD OF TECHNOLOGY PRODUCTS, NAMELY, MP3 PLAYERS, RADIOS, AUDIO CASSETTE RECORDERS, AUDIO SPEAKERS, ELECTRONIC MUSICAL KEYBOARDS, CD PLAYERS, DIGITAL CAMERAS AND CAMCORDERS, PDAS, TELEPHONE ANSWERING MACHINES, WIRELESS TELEPHONES; HANDS-FREE DEVICES FOR USE WITH WIRELESS TELEPHONES, MONITOR TELEVISIONS; FLAT PANEL TELEVISION AND DISPLAY MONITORS; PLASMA DISPLAYS; PROJECTION TELEVISIONS; HIGH DEFINITION PROJECTION TELEVISIONS, TELEVISION SETS, DIGITAL VIDEO RECORDERS, VIDEO MONITORS, VIDEO OUTPUT GAME MACHINES FOR USE WITH TELEVISIONS, DVD MACHINES; AND DIRECT MARKETING ADVERTISING FOR OTHERS IN THE FIELD OF TECHNOLOGY (U.S. CLS. 100, 101 AND 102).

FIRST USE 7-31-2002; IN COMMERCE 7-31-2002.

CLASS 35—(Continued).

3,177,351. FINLEY PRODUCTS INC., LANCASTER, PA. SN 76-347,422. PUB. 11-8-2005, FILED 12-12-2001.

FINLEY PRODUCTS INC.

NO CLAIM IS MADE TO THE EXCLUSIVE RIGHT TO USE "PRODUCTS INC.", APART FROM THE MARK AS SHOWN.

FOR WHOLESALE DISTRIBUTORSHIPS FEATURING HOME FURNISHINGS AND YARD IMPLEMENTS AND ACCESSORIES (U.S. CLS. 100, 101 AND 102).

FIRST USE 1-1-2003; IN COMMERCE 1-1-2003.

3,177,364. GIFT FOR LIFE BLOCK WALK, HOUSTON, TX. SN 76-427,377. PUB. 1-18-2005, FILED 6-26-2002.

GIFT FOR LIFE BLOCK WALK

NO CLAIM IS MADE TO THE EXCLUSIVE RIGHT TO USE "BLOCK WALK", APART FROM THE MARK AS SHOWN.

FOR PROMOTING PUBLIC AWARENESS OF THE NEED FOR BREAST HEALTH AND BREAST CANCER AWARENESS IN THE MINORITY COMMUNITY (U.S. CLS. 100, 101 AND 102).

FIRST USE 10-1-1994; IN COMMERCE 10-1-1994.

3,177,377. INCISIVE SURGICAL, INC., MINNETONKA, MN. SN 76-484,551. PUB. 7-26-2005, FILED 1-23-2003.



NO CLAIM IS MADE TO THE EXCLUSIVE RIGHT TO USE "SURGICAL", APART FROM THE MARK AS SHOWN.

FOR WHOLESALE DISTRIBUTORSHIPS AND RETAIL STORE SERVICES ALL FEATURING SURGICAL INSTRUMENTS AND MEDICAL EQUIPMENT AND ACCESSORIES (U.S. CLS. 100, 101 AND 102).

FIRST USE 9-4-2004; IN COMMERCE 9-4-2004.

CLASS 35—(Continued).

3,177,404. HRM OUTSOURCING, INC., SAINT LOUIS, MO.
SN 76-550,227. PUB. 6-29-2004, FILED 10-9-2003.



NO CLAIM IS MADE TO THE EXCLUSIVE RIGHT TO USE "SENIOR", APART FROM THE MARK AS SHOWN.

THE MARK CONSISTS OF THE WORDS "SENIOR FORCE" IMPOSED ON AN OVAL.

FOR EMPLOYMENT CONSULTING, RECRUITING AND PLACEMENT SERVICES (U.S. CLS. 100, 101 AND 102).

FIRST USE 8-16-2006; IN COMMERCE 8-18-2006.

3,177,408. JADE EXPRESS, INC., LOS ANGELES, CA. SN 76-553,093. PUB. 5-10-2005, FILED 9-29-2003.

J.E. TOYS

NO CLAIM IS MADE TO THE EXCLUSIVE RIGHT TO USE TOYS, APART FROM THE MARK AS SHOWN.

FOR TOY AND GENERAL MERCHANDISE IMPORT AND EXPORT AGENCY (U.S. CLS. 100, 101 AND 102).

FIRST USE 1-1-1993; IN COMMERCE 1-1-1993.

3,177,416. SAGITTA INDUSTRIAL CORP., TAIPEI, TAIWAN.
SN 76-566,359. PUB. 6-14-2005, FILED 12-22-2003.

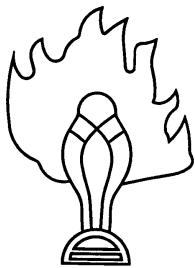
**SAGITTA**

FOR ADVERTISING AGENCY SERVICES; DESIGNING AND PREPARING ADVERTISEMENTS FOR OTHERS; IMPORT-EXPORT AGENCIES; BUSINESS INFORMATION SERVICES, NAMELY, COMMERCIAL INFORMATION AGENCIES; PROMOTING THE GOODS AND SERVICES OF OTHERS BY PROVIDING HYPERTEXT LINKS TO THE WEB SITES OF OTHERS; AND PROVIDING RADIO AND TELEVISION ADVERTISING FOR OTHERS (U.S. CLS. 100, 101 AND 102).

FIRST USE 2-10-2004; IN COMMERCE 2-10-2004.

CLASS 35—(Continued).

3,177,435. AVACUS CORPORATION, SANTA MONICA, CA.
SN 76-582,092. PUB. 12-21-2004, FILED 3-15-2004.

CLUB 360°

THE MARK CONSISTS OF STANDARD CHARACTERS WITHOUT CLAIM TO ANY PARTICULAR FONT, STYLE, SIZE, OR COLOR.

FOR INCENTIVE AWARDS PROGRAMS, WHEREBY PURCHASE POINTS CAN BE REDEEMED FOR MERCHANDISE (U.S. CLS. 100, 101 AND 102).

FIRST USE 11-30-2003; IN COMMERCE 11-30-2003.

3,177,437. MICHIGAN ECONOMIC DEVELOPMENT CORPORATION, LANSING, MI. SN 76-585,099. PUB. 1-3-2006, FILED 4-5-2004.

COOL CITIES

THE MARK CONSISTS OF STANDARD CHARACTERS WITHOUT CLAIM TO ANY PARTICULAR FONT, STYLE, SIZE, OR COLOR.

NO CLAIM IS MADE TO THE EXCLUSIVE RIGHT TO USE "CITIES", APART FROM THE MARK AS SHOWN.

FOR PROMOTING ECONOMIC DEVELOPMENT IN THE STATE OF MICHIGAN BY ENCOURAGING YOUNG PEOPLE TO LIVE AND WORK IN CITIES (U.S. CLS. 100, 101 AND 102).

FIRST USE 2-0-2003; IN COMMERCE 6-2-2004.

CLASS 35—(Continued).

3,177,464. LINDSTROM & MCKENNEY, INC., CHESTERFIELD, MO. SN 76-606,343. PUB. 12-13-2005, FILED 8-10-2004.

SELL US YOUR VALUABLES!

THE MARK CONSISTS OF STANDARD CHARACTERS WITHOUT CLAIM TO ANY PARTICULAR FONT, STYLE, SIZE, OR COLOR.

FOR PROCUREMENT SERVICES, NAMELY, PURCHASING VALUABLES OF ALL KINDS, NAMELY, COLLECTIBLES, ANTIQUE AND ESTATE JEWELRY AND WATCHES, JEWELRY, STERLING SILVER, FINE ART, ANTIQUES, HISTORICAL DOCUMENTS, COINS, CURRENCY, ARTIFACTS, AUTOGRAPHS, AND PHOTOGRAPHS; CONSULTING SERVICES IN THE FIELD OF MARKETING AND SELLING ESTATE VALUABLES; PROMOTIONAL SERVICES FOR OTHERS, NAMELY, PROMOTING THE PRODUCTS AND SERVICES OF OTHERS IN THE FIELD OF ESTATE VALUABLES THROUGH SPECIAL EVENTS, LECTURES, TRADE SHOWS, CONVENTIONS, EDUCATION MATERIALS, AND PUBLICATIONS RELATING TO THE PROCUREMENT, MARKETING, AUCTIONING, SELLING, AND BROKERING OF ESTATE VALUABLES; RETAIL CONSIGNMENT SERVICES IN THE FIELD OF ESTATE VALUABLES OF ALL KINDS (U.S. CLS. 100, 101 AND 102).

FIRST USE 1-0-2000; IN COMMERCE 1-0-2000.

3,177,469. DORCHESTER CAPITAL MANAGEMENT COMPANY, HOUSTON, TX. SN 76-608,541. PUB. 7-19-2005, FILED 8-25-2004.

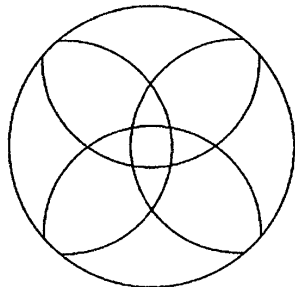

FOR ANALYZING AND COMPILING DATA FOR MEASURING THE PERFORMANCE OF FINANCIAL MARKETS AND PROVIDING THAT DATA TO OTHERS (U.S. CLS. 100, 101 AND 102).

FIRST USE 5-3-2006; IN COMMERCE 5-3-2006.

CLASS 35—(Continued).

3,177,474. CHRISTINE'S KITCHEN LLC, WASHINGTON, DC. SN 76-609,502. PUB. 12-20-2005, FILED 8-31-2004.

CHRISTINE'S COFFEE

THE MARK CONSISTS OF STANDARD CHARACTERS WITHOUT CLAIM TO ANY PARTICULAR FONT, STYLE, SIZE, OR COLOR.

NO CLAIM IS MADE TO THE EXCLUSIVE RIGHT TO USE "COFFEE", APART FROM THE MARK AS SHOWN.

FOR IMPORT AND EXPORT SERVICES, NAMELY, THE IMPORT AND EXPORT OF COFFEES (U.S. CLS. 100, 101 AND 102).

FIRST USE 7-19-2006; IN COMMERCE 7-19-2006.

3,177,489. MCBRIDE, KEVIN, FULLERTON, CA. SN 76-612,322. PUB. 12-20-2005, FILED 9-16-2004.

HAVE YOU HUGGED YOUR FAMILY TODAY

THE MARK CONSISTS OF STANDARD CHARACTERS WITHOUT CLAIM TO ANY PARTICULAR FONT, STYLE, SIZE, OR COLOR.

FOR ONLINE RETAIL STORE SERVICES FEATURING STICKERS, MUGS, CLOTHING, HATS, BEACH WEAR, BEACH GEAR, PATCHES, GREETING CARDS, STATIONERY, BOOKS, MAGAZINES, APRONS, PET ACCESSORIES AND BAGS (U.S. CLS. 100, 101 AND 102).

FIRST USE 11-14-2004; IN COMMERCE 11-14-2004.

3,177,497. DREAMWELL, LTD., LAS VEGAS, NV. SN 76-614,277. PUB. 1-24-2006, FILED 10-1-2004.



FOR RETAIL STORE SERVICES AND ONLINE RETAIL STORE SERVICES FEATURING BEDDING PRODUCTS (U.S. CLS. 100, 101 AND 102).

FIRST USE 11-1-2004; IN COMMERCE 11-1-2004.

CLASS 35—(Continued).

3,177,499. METRUS GROUP, INC., SOMERVILLE, NJ. SN 76-614,396. PUB. 12-20-2005, FILED 10-1-2004.

PEOPLE EQUITY

THE MARK CONSISTS OF STANDARD CHARACTERS WITHOUT CLAIM TO ANY PARTICULAR FONT, STYLE, SIZE, OR COLOR.

FOR BUSINESS MANAGEMENT CONSULTING, NAMELY, PERFORMING INTERNAL AND EXTERNAL BUSINESS SURVEYS AND ASSESSMENTS; BUSINESS PROCESS REENGINEERING AND TEAM BUILDING CONSULTING; BUSINESS PROCESS IMPROVEMENT CONSULTING (U.S. CLS. 100, 101 AND 102).

FIRST USE 8-31-2004; IN COMMERCE 8-31-2004.

3,177,531. TEAM CHEMISTRY LLC, RENO, NV. SN 76-625,829. PUB. 3-28-2006, FILED 12-27-2004.

TEAM CHEMISTRY

THE MARK CONSISTS OF STANDARD CHARACTERS WITHOUT CLAIM TO ANY PARTICULAR FONT, STYLE, SIZE, OR COLOR.

FOR BUSINESS CONSULTING SERVICES, NAMELY MANAGEMENT CONSULTING IN THE FIELD OF CHEMICAL PRODUCTS AND CHEMICAL INDUSTRY AND MANAGEMENT CONSULTING SERVING MANUFACTURERS, THEIR AGENTS AND REPRESENTATIVES, IN B2B ENVIRONMENTS (U.S. CLS. 100, 101 AND 102).

FIRST USE 1-0-2005; IN COMMERCE 1-0-2005.

3,177,539. TACTICAL SHACK, INC., FORT WAYNE, IN. SN 76-631,695. PUB. 11-15-2005, FILED 2-18-2005.

TACTICAL SHACK

THE MARK CONSISTS OF STANDARD CHARACTERS WITHOUT CLAIM TO ANY PARTICULAR FONT, STYLE, SIZE, OR COLOR.

FOR ON-LINE RETAIL STORE SERVICES FEATURING A WIDE VARIETY OF ACCESSORIES AND GEAR FOR USE WITH FIREARMS (U.S. CLS. 100, 101 AND 102).

FIRST USE 5-1-2005; IN COMMERCE 5-1-2005.

CLASS 35—(Continued).

3,177,540. VERTASOURCE, LLC, BUFFALO, NY. SN 76-631,967. PUB. 11-22-2005, FILED 2-23-2005.

YOUR HOMETOWN HOMEPAGE

THE MARK CONSISTS OF STANDARD CHARACTERS WITHOUT CLAIM TO ANY PARTICULAR FONT, STYLE, SIZE, OR COLOR.

NO CLAIM IS MADE TO THE EXCLUSIVE RIGHT TO USE "HOMEPAGE", APART FROM THE MARK AS SHOWN.

FOR PROVIDING A WEBSITE WHICH FEATURES ADVERTISING FOR THE GOODS AND SERVICES OF OTHERS ON A GLOBAL COMPUTER NETWORK AND PROVIDING INFORMATION ABOUT CONSUMER PRODUCTS AND SERVICES FOR RETAIL SERVICES CONCERNING PRODUCTS, SERVICES, EVENTS, ACTIVITIES AND ATTRACTIONS IN A PARTICULAR GEOGRAPHIC REGION VIA A WEBSITE ON A GLOBAL COMPUTER NETWORK (U.S. CLS. 100, 101 AND 102).

FIRST USE 11-0-2004; IN COMMERCE 11-0-2004.

3,177,542. AMC, INC., ATLANTA, GA. SN 76-632,400. PUB. 11-29-2005, FILED 3-1-2005.

HOUSE OF CREATIVITY

THE MARK CONSISTS OF STANDARD CHARACTERS WITHOUT CLAIM TO ANY PARTICULAR FONT, STYLE, SIZE, OR COLOR.

FOR ORGANIZING, ARRANGING AND CONDUCTING TRADE SHOWS IN THE FIELDS OF FURNITURE, APPAREL, CHINA, CRYSTAL, JEWELRY, RUGS, CARPETS, AND OTHER FLOOR COVERINGS, HOUSEWARE ITEMS, DECORATIVE ACCESSORIES FOR THE HOME, AND RELATED MERCHANDISE (U.S. CLS. 100, 101 AND 102).

FIRST USE 7-0-2005; IN COMMERCE 7-0-2005.

3,177,543. GREENFIELD ONLINE, INC., WILTON, CT. SN 76-632,641. PUB. 11-29-2005, FILED 3-3-2005.

STAY AHEAD

THE MARK CONSISTS OF STANDARD CHARACTERS WITHOUT CLAIM TO ANY PARTICULAR FONT, STYLE, SIZE, OR COLOR.

FOR CONDUCTING QUALITATIVE AND QUANTITATIVE SURVEYS ON CONSUMER'S BUYING BEHAVIORS VIA A GLOBAL COMPUTER INFORMATION NETWORK (U.S. CLS. 100, 101 AND 102).

FIRST USE 9-30-2003; IN COMMERCE 9-30-2003.

CLASS 35—(Continued).

3,177,555. FISHER, CASEY, LAYTON, UT. SN 76-636,312. PUB. 1-17-2006, FILED 4-18-2005.

LIV SURE

THE MARK CONSISTS OF STANDARD CHARACTERS WITHOUT CLAIM TO ANY PARTICULAR FONT, STYLE, SIZE, OR COLOR.

FOR ON-LINE RETAIL STORE SERVICES FEATURING HOME AND HEALTH RELATED PRODUCTS (U.S. CLS. 100, 101 AND 102).

FIRST USE 12-14-2005; IN COMMERCE 12-14-2005.

3,177,560. NEW WEST MARKETING LLC, CENTENNIAL, CO. SN 76-637,380. PUB. 5-16-2006, FILED 4-29-2005.

ONE STOP WIZARD

THE MARK CONSISTS OF STANDARD CHARACTERS WITHOUT CLAIM TO ANY PARTICULAR FONT, STYLE, SIZE, OR COLOR.

FOR PROVIDING ON-LINE BUSINESS DIRECTORIES FEATURING VENDORS OF HOME REPAIRS, CONSTRUCTION AND CONTRACTING SERVICES INCLUDING CUSTOMER FEEDBACK FOR HOMEOWNERS AND REAL ESTATE PROFESSIONALS (U.S. CLS. 100, 101 AND 102).

FIRST USE 8-1-2005; IN COMMERCE 8-1-2005.

3,177,561. ALLEGIANCE BENEFIT PLAN MANAGEMENT, INC., MISSOULA, MT. SN 76-637,485. PUB. 5-23-2006, FILED 4-29-2005.

Serving Business, Benefitting People

THE MARK CONSISTS OF STANDARD CHARACTERS WITHOUT CLAIM TO ANY PARTICULAR FONT, STYLE, SIZE, OR COLOR.

FOR ADVERTISING SERVICES (U.S. CLS. 100, 101 AND 102).

FIRST USE 1-4-2005; IN COMMERCE 1-4-2005.

CLASS 35—(Continued).

3,177,600. MIROMAR DEVELOPMENT CORPORATION, ESTERO, FL. SN 78-118,219. PUB. 6-3-2003, FILED 3-28-2002.

DESIGNER ON CALL

FOR RETAIL SHOWROOM STORE SERVICES IN THE FIELD OF INTERIOR FURNISHINGS; SHOWROOM DISPLAY SERVICES IN THE FIELD OF INTERIOR FURNISHINGS; ONLINE SHOWROOM SERVICES IN THE FIELD OF INTERIOR FURNISHINGS; AND PROVIDING INTERIOR FURNISHINGS INFORMATION VIA GLOBAL COMPUTER NETWORKS (U.S. CLS. 100, 101 AND 102).

FIRST USE 8-28-2006; IN COMMERCE 8-28-2006.

3,177,610. BRISTOL-MYERS SQUIBB COMPANY, NEW YORK, NY. SN 78-148,853. PUB. 7-22-2003, FILED 7-30-2002.

TOGETHER WE SUCCEED

FOR CORPORATE AND BUSINESS DEVELOPMENT SERVICES IN THE FIELD OF PHARMACEUTICALS; BUSINESS MARKETING CONSULTING SERVICES, NAMELY, DESIGNING AND IMPLEMENTING CUSTOMIZED MARKETING STRATEGIES FOR HEALTHCARE ORGANIZATIONS AND BUSINESSES THROUGH THE DISTRIBUTION OF PRINTED PROMOTIONAL MATERIALS, ORGANIZING PROGRAMS AND BY RENDERING SALES PROMOTION ADVICE (U.S. CLS. 100, 101 AND 102).

FIRST USE 9-23-2002; IN COMMERCE 9-23-2002.

3,177,612. VSS HOLDING, INC., SALT LAKE CITY, UT. SN 78-152,954. PUB. 7-15-2003, FILED 8-9-2002.

VISTA STAFFING

OWNER OF U.S. REG. NO. 2,218,901.
NO CLAIM IS MADE TO THE EXCLUSIVE RIGHT TO USE "STAFFING", APART FROM THE MARK AS SHOWN, FOR EMPLOYMENT PLACEMENT AND RECRUITING SERVICES (U.S. CLS. 100, 101 AND 102).

FIRST USE 8-0-2005; IN COMMERCE 8-0-2005.

3,177,614. THOMAS PUBLISHING COMPANY, NEW YORK, NY. SN 78-153,815. PUB. 12-23-2003, FILED 8-13-2002.

**INDUSTRIAL PURCHASING
BAROMETER**

NO CLAIM IS MADE TO THE EXCLUSIVE RIGHT TO USE "INDUSTRIAL PURCHASING", APART FROM THE MARK AS SHOWN.

FOR CONDUCTING BUSINESS AND MARKET RESEARCH SURVEYS (U.S. CLS. 100, 101 AND 102).

FIRST USE 7-31-2006; IN COMMERCE 7-31-2006.

CLASS 35—(Continued).

3,177,624. STAPLES THE OFFICE SUPERSTORE, INC., FRAMINGHAM, MA. SN 78-179,188. PUB. 5-20-2003, FILED 10-28-2002.

IN. OUT. DONE.

FOR RETAIL STORE SERVICES, MAIL ORDER CATALOG SERVICES, AND COMPUTERIZED ONLINE RETAIL STORE SERVICES FEATURING OFFICE SUPPLIES, OFFICE EQUIPMENT, INCLUDING COMPUTER HARDWARE, COPIERS AND TELEPHONES, AND OFFICE FURNITURE (U.S. CLS. 100, 101 AND 102).

FIRST USE 11-0-2005; IN COMMERCE 11-0-2005.

3,177,657. KAZI, ANWAR R., HONOLULU, HI. SN 78-254,077. PUB. 8-17-2004, FILED 5-24-2003.

INC. PAGES

NO CLAIM IS MADE TO THE EXCLUSIVE RIGHT TO USE "PAGES", APART FROM THE MARK AS SHOWN.

FOR BUSINESS INFORMATION IN THE FIELD OF COMPANY AND INDUSTRY PROFILES, JOB SEARCHES; ADVERTISING, NAMELY DISSEMINATION OF ADVERTISING FOR OTHERS VIA AN ONLINE COMMUNICATIONS NETWORK (U.S. CLS. 100, 101 AND 102).

FIRST USE 2-28-2005; IN COMMERCE 8-30-2006.

3,177,665. EVERDRIVE, INC., MIDLOTHIAN, VA. SN 78-278,116. PUB. 6-1-2004, FILED 7-24-2003.

EVERDRIVE
Guaranteed Used Parts

NO CLAIM IS MADE TO THE EXCLUSIVE RIGHT TO USE "GUARANTEED USED PARTS", APART FROM THE MARK AS SHOWN.

FOR COMPUTERIZED ON-LINE RETAIL SERVICES IN THE FIELD OF USED AUTOMOTIVE PARTS, NAMELY OFFERING USED AUTOMOTIVE PARTS THROUGH KIOSKS AND/OR POINT OF SALES TERMINALS THAT ARE LOCATED AT RETAIL AUTOMOTIVE PARTS STORES OWNED BY OTHERS (U.S. CLS. 100, 101 AND 102).

FIRST USE 7-1-2003; IN COMMERCE 6-22-2004.

CLASS 35—(Continued).

3,177,683. KALCORP ENTERPRISES, INC., COLLEGE STATION, TX. SN 78-298,977. PUB. 7-5-2005, FILED 9-11-2003.

SAW 'EM OFF

FOR RETAIL STORE SERVICES FEATURING-SHIRTS, SWEATSHIRTS, PANTS, HATS, SCARVES, DRESS SHIRTS, BLANKETS, CUPS, GLASSES, LICENSE PLATE FRAMES, DECALS, SIGNS, AUDIO RECORDINGS, PRINTS AND PHOTOGRAPHS, FLAGS, AND BANNERS (U.S. CLS. 100, 101 AND 102).

FIRST USE 10-31-2005; IN COMMERCE 10-31-2005.

3,177,697. PROFESSIONAL DEVELOPMENT GROUP, INC., PITTSFORD, NY. SN 78-318,783. PUB. 12-13-2005, FILED 10-27-2003.

JOB FIT

THE MARK CONSISTS OF STANDARD CHARACTERS WITHOUT CLAIM TO ANY PARTICULAR FONT, STYLE, SIZE, OR COLOR.

NO CLAIM IS MADE TO THE EXCLUSIVE RIGHT TO USE "JOB", APART FROM THE MARK AS SHOWN.

FOR MANAGEMENT CONSULTING SERVICES IN THE FIELDS OF JOB RELATED COMPETENCIES, INTERPERSONAL SKILLS, AND COGNITIVE SKILLS; TESTING SERVICES IN THE FIELDS OF JOB RELATED COMPETENCIES, INTERPERSONAL SKILLS, AND COGNITIVE SKILLS (U.S. CLS. 100, 101 AND 102).

FIRST USE 1-0-2003; IN COMMERCE 1-0-2003.

3,177,765. MATTEL, INC., EL SEGUNDO, CA. SN 78-374,079. PUB. 1-10-2006, FILED 2-25-2004.

RED LINE

THE MARK CONSISTS OF STANDARD CHARACTERS WITHOUT CLAIM TO ANY PARTICULAR FONT, STYLE, SIZE, OR COLOR.

OWNER OF U.S. REG. NO. 2,192,653.

FOR CUSTOMER LOYALTY SERVICES AND CUSTOMER CLUB SERVICES FOR COMMERCIAL, PROMOTIONAL AND/OR ADVERTISING PURPOSES (U.S. CLS. 100, 101 AND 102).

FIRST USE 2-23-2004; IN COMMERCE 2-23-2004.

CLASS 35—(Continued).

3,177,792. MATTRESS WAREHOUSE, INC., FREDERICK, MD. SN 78-393,931. PUB. 7-26-2005, FILED 3-31-2004.

CLASS 35—(Continued).

3,177,819. R.A. INTERNATIONAL, INC., BURLINGTON, VT. SN 78-408,824. PUB. 10-18-2005, FILED 4-27-2004.

TOP OF THE LINE



THE MARK CONSISTS OF STANDARD CHARACTERS WITHOUT CLAIM TO ANY PARTICULAR FONT, STYLE, SIZE, OR COLOR.

FOR RETAIL STORE SERVICES FEATURING BEDS, MATTRESSES, BEDSPRINGS, BED FRAMES AND RELATED ACCESSORIES (U.S. CLS. 100, 101 AND 102). FIRST USE 6-8-2006; IN COMMERCE 6-8-2006.

NO CLAIM IS MADE TO THE EXCLUSIVE RIGHT TO USE "HOME", APART FROM THE MARK AS SHOWN.

THE COLOR(S) GREEN, SALMON AND BURNT SIENNA ARE CLAIMED AS A FEATURE OF THE MARK.

THE ELEMENTS COMPRISING THE FIRST VERTICAL BAR FROM THE LEFT, THE LETTERING COMPRISING THE WORDS HOME LIFE AND THE SHADED CIRCLE DESIGN AT THE TOP OF THE LETTER "L" ARE DISPLAYED IN GREEN. THE DESIGN ELEMENTS COMPRISING THE TWO HORIZONTAL BARS ARE DISPLAYED IN BURNT SIENNA ON TOP AND SALMON ON THE BOTTOM.

FOR RETAIL STORE SERVICES IN THE FIELD OF FURNITURE, FURNITURE ACCESSORIES AND HOME FURNISHINGS (U.S. CLS. 100, 101 AND 102). FIRST USE 6-1-2004; IN COMMERCE 6-1-2004.

3,177,803. FOUR QUADRANTS, LLC, EDMOND, OK. SN 78-399,829. PUB. 9-20-2005, FILED 4-10-2004.

3,177,820. PREVO'S FAMILY MARKETS, INC., GRAND RAPIDS, MI. SN 78-408,827. PUB. 4-11-2006, FILED 4-27-2004.

FOUR QUADRANTS

YOU'RE IN GLEN'S NEIGHBORHOOD

THE MARK CONSISTS OF STANDARD CHARACTERS WITHOUT CLAIM TO ANY PARTICULAR FONT, STYLE, SIZE, OR COLOR.

FOR BUSINESS MANAGEMENT CONSULTING WITH RELATION TO STRATEGY, MARKETING, PRODUCTION, PERSONNEL AND RETAIL SALE MATTERS (U.S. CLS. 100, 101 AND 102). FIRST USE 10-18-2004; IN COMMERCE 10-18-2004.

THE MARK CONSISTS OF STANDARD CHARACTERS WITHOUT CLAIM TO ANY PARTICULAR FONT, STYLE, SIZE, OR COLOR.

FOR RETAIL SUPERMARKET SERVICES (U.S. CLS. 100, 101 AND 102). FIRST USE 5-17-2004; IN COMMERCE 5-17-2004.

CLASS 35—(Continued).

3,177,886. HONEYWELL INTERNATIONAL INC., MORRISTOWN, NJ. SN 78-445,317. PUB. 11-1-2005, FILED 7-2-2004.

CLASS 35—(Continued).

3,177,905. OUTSOURCE PARTNERS INTERNATIONAL, INC., LOS ANGELES, CA. SN 78-450,564. PUB. 12-27-2005, FILED 7-14-2004.

AL/EX

THE MARK CONSISTS OF STANDARD CHARACTERS WITHOUT CLAIM TO ANY PARTICULAR FONT, STYLE, SIZE, OR COLOR.

FOR EXCHANGE SERVICES FOR AIRLINES, NAMELY PROVIDING REPLACEMENT AIRCRAFT AVIONICS PRODUCTS TO AIRLINES IN EXCHANGE FOR REPAIRABLE UNITS (U.S. CLS. 100, 101 AND 102). FIRST USE 9-29-2004; IN COMMERCE 10-4-2004.



3,177,892. TIM MCCARTHY ADVERTISING, INC., DBA THE MCCARTHY COMPANIES, DALLAS, TX. SN 78-446,437. PUB. 11-1-2005, FILED 7-6-2004.

**DOMINATE YOUR
MARKET**

THE MARK CONSISTS OF STANDARD CHARACTERS WITHOUT CLAIM TO ANY PARTICULAR FONT, STYLE, SIZE, OR COLOR.

FOR ADVERTISING AGENCIES, NAMELY PROMOTING THE GOODS AND SERVICES OF OTHERS THROUGH THE DISTRIBUTION OF PRINTED AND AUDIO PROMOTIONAL MATERIALS AND BY RENDERING SALES PROMOTION ADVICE (U.S. CLS. 100, 101 AND 102).

FIRST USE 1-0-2004; IN COMMERCE 1-0-2004.

THE MARK CONSISTS OF A BLACK GLOBE WITH THREE WHITE LINES ASCENDING FROM THE LOWER LEFT SIDE TO/AND MEETING AT THE UPPER RIGHT SIDE OF THE GLOBE, ENCIRCLING A SMALLER BLACK GLOBE.

FOR BUSINESS OUTSOURCING SERVICES IN FINANCE; NAMELY, ASSISTING OTHERS WITH THE COMPLETION OF FINANCIAL TRANSACTIONS; REPORTING AND REGULATORY COMPLIANCE; BUSINESS OUTSOURCING SERVICES IN ACCOUNTING; DATA PROCESSING AND DATA ENTRY SERVICES FOR OTHERS; BUSINESS PROCESS OUTSOURCING; AND BUSINESS MANAGEMENT CONSULTING, NAMELY, BEST PRACTICES MONITORING SERVICES (U.S. CLS. 100, 101 AND 102).

FIRST USE 8-30-2002; IN COMMERCE 8-30-2002.

CLASS 35—(Continued).

3,177,920. COLDWATER CREEK INC., SANDPOINT, ID. SN 78-456,991. PUB. 6-21-2005, FILED 7-26-2004.

COLDWATER CREEK SPORT

THE MARK CONSISTS OF STANDARD CHARACTERS WITHOUT CLAIM TO ANY PARTICULAR FONT, STYLE, SIZE, OR COLOR.

OWNER OF U.S. REG. NOS. 1,531,418, 1,876,534, AND OTHERS.

FOR MAIL ORDER CATALOG SERVICES, RETAIL STORE SERVICES, AND ELECTRONIC MEDIA DISPLAY CATALOG SERVICES, ALL FEATURING BEDDING, BLANKETS, LINEN, DRAPERIES, PILLOWS, WALL COVERINGS, RUGS, DOORMATS AND OTHER FLOOR COVERINGS, TOWELS, WALL HANGINGS, ARTIST'S MATERIALS AND SUPPLIES, ARTWORK, BATHROOM ACCESSORIES AND DECORATIONS, BEDROOM ACCESSORIES AND DECORATIONS, SOAP, BATH PRODUCTS, BEDROOM FURNITURE, LIVING ROOM ACCESSORIES AND DECORATIONS, SLIPPERS, BATH ROBES, TABLES, CANDLES, CANDLE HOLDERS, BIRDFEEDERS, MIRRORS, LAMPS, PLANTERS AND PLANT HOLDERS, COASTERS, NAPKIN RINGS, PLATE HOLDERS, PAPER WEIGHTS, VASES, FURNITURE, WREATHS, PICTURE FRAMES, FOUNTAINS, GLASSES, PITCHERS AND OTHER HOUSE WARES, JEWELRY, PURSES, WATCHES, BELTS, SUNGLASSES, EYEGLASSES, LINGERIE, SWIMSUITS, SHOES AND CLOTHING (U.S. CLS. 100, 101 AND 102).

FIRST USE 8-18-2004; IN COMMERCE 8-18-2004.

CLASS 35—(Continued).

3,177,946. NORTHERN ELECTRONICS AUTOMATION, INC., LONDONDERRY, NH. SN 78-467,087. PUB. 12-20-2005, FILED 8-13-2004.

SMTAUCTION.COM

THE MARK CONSISTS OF STANDARD CHARACTERS WITHOUT CLAIM TO ANY PARTICULAR FONT, STYLE, SIZE, OR COLOR.

FOR ON-LINE TRADING SERVICES IN WHICH SELLER POSTS PRINTER CIRCUIT BOARD ASSEMBLY AND TEST EQUIPMENT TO BE AUCTIONED AND BIDDING IS DONE ELECTRONICALLY (U.S. CLS. 100, 101 AND 102).

FIRST USE 9-20-2005; IN COMMERCE 9-20-2005.

3,177,949. IVOX, INC, ATLANTA, GA. SN 78-467,860. PUB. 12-13-2005, FILED 8-16-2004.

3,177,929. ORLANDO REGIONAL REALTOR ASSOCIATION, INC., ORLANDO, FL. SN 78-460,568. PUB. 6-28-2005, FILED 8-2-2004.

ORRASGS

THE MARK CONSISTS OF STANDARD CHARACTERS WITHOUT CLAIM TO ANY PARTICULAR FONT, STYLE, SIZE, OR COLOR.

FOR PUBLIC OPINION POLLING SERVICES FOR OTHERS; PUBLIC OPINION SURVEY SERVICES FOR OTHERS (U.S. CLS. 100, 101 AND 102).

FIRST USE 6-1-2004; IN COMMERCE 6-1-2004.

DRIVER SCORE

THE MARK CONSISTS OF STANDARD CHARACTERS WITHOUT CLAIM TO ANY PARTICULAR FONT, STYLE, SIZE, OR COLOR.

NO CLAIM IS MADE TO THE EXCLUSIVE RIGHT TO USE "DRIVER", APART FROM THE MARK AS SHOWN.

FOR COMPILING AND ANALYZING VEHICLE USAGE DATA FOR BUSINESS USE IN THE FIELDS OF INSURANCE, MARKETING, SAFETY, COST/PRICE ANALYSIS, CONSUMER RESEARCH, BUSINESS RESEARCH AND MARKET RESEARCH (U.S. CLS. 100, 101 AND 102).

FIRST USE 8-9-2006; IN COMMERCE 8-9-2006.

CLASS 35—(Continued).

3,177,952. INVERSIONES CIFCO S.A., LAS CONDES, CHILE. SN 78-468,544. PUB. 1-10-2006, FILED 8-17-2004.



FOR PROMOTING TOURISM IN LATIN AMERICA (U.S. CLS. 100, 101 AND 102). FIRST USE 5-10-2006; IN COMMERCE 5-10-2006.



3,177,953. FORD MOTOR COMPANY, DEARBORN, MI. SN 78-468,770. PUB. 7-5-2005, FILED 8-17-2004.

**ONE VEHICLE.
ENDLESS
POSSIBILITIES**

THE MARK CONSISTS OF STANDARD CHARACTERS WITHOUT CLAIM TO ANY PARTICULAR FONT, STYLE, SIZE, OR COLOR.

FOR PROMOTING THE SALE OF GOODS AND SERVICES OF OTHERS IN THE AUTOMOBILE INDUSTRY BY DISSEMINATION OF PROMOTIONAL MATERIAL AND PRODUCT INFORMATION THROUGH AN ONLINE GLOBAL COMPUTER NETWORK, THROUGH THE DISTRIBUTION OF PRINTED MATERIAL, TELEVISION AND RADIO BROADCASTS (U.S. CLS. 100, 101 AND 102). FIRST USE 10-15-2004; IN COMMERCE 10-15-2004.

CLASS 35—(Continued).

3,177,958. PHNS INC., DALLAS, TX. SN 78-469,465. PUB. 11-22-2005, FILED 8-18-2004.

**PHNS FINANCIAL
INFORMATION
EXCHANGE**

THE MARK CONSISTS OF STANDARD CHARACTERS WITHOUT CLAIM TO ANY PARTICULAR FONT, STYLE, SIZE, OR COLOR.

OWNER OF U.S. REG. NO. 2,703,884. NO CLAIM IS MADE TO THE EXCLUSIVE RIGHT TO USE "FINANCIAL INFORMATION EXCHANGE", APART FROM THE MARK AS SHOWN.

FOR OUTSOURCING SERVICES FOR OTHERS AND BUSINESS PROCESS RE-ENGINEERING SERVICES IN THE HEALTH CARE INDUSTRY (U.S. CLS. 100, 101 AND 102). FIRST USE 12-27-2004; IN COMMERCE 12-27-2004.



3,177,963. MARK I ENTERPRISES, TOWSON, MD. SN 78-470,419. PUB. 7-5-2005, FILED 8-19-2004.

**Nothing is faster
than not at all.**

THE MARK CONSISTS OF STANDARD CHARACTERS WITHOUT CLAIM TO ANY PARTICULAR FONT, STYLE, SIZE, OR COLOR.

FOR BUSINESS CONSULTING AND INFORMATION SERVICES (U.S. CLS. 100, 101 AND 102). FIRST USE 12-1-2005; IN COMMERCE 2-1-2006.

CLASS 35—(Continued).

3,177,991. SMARTWOOL CORP., STEAMBOAT SPRINGS, CO. SN 78-479,616. PUB. 8-9-2005, FILED 9-7-2004.

SMART BASKET

THE MARK CONSISTS OF STANDARD CHARACTERS WITHOUT CLAIM TO ANY PARTICULAR FONT, STYLE, SIZE, OR COLOR.

NO CLAIM IS MADE TO THE EXCLUSIVE RIGHT TO USE "SMART", APART FROM THE MARK AS SHOWN.

FOR ONLINE RETAIL STORE SERVICES FEATURING CLOTHING AND FOOTWEAR (U.S. CLS. 100, 101 AND 102).

FIRST USE 3-20-2005; IN COMMERCE 3-20-2005.

3,177,999. QUIN, MARY P., ANCHORAGE, AK. SN 78-481,664. PUB. 11-1-2005, FILED 9-10-2004.

TULIQI

THE MARK CONSISTS OF STANDARD CHARACTERS WITHOUT CLAIM TO ANY PARTICULAR FONT, STYLE, SIZE, OR COLOR.

FOR RETAIL STORE SERVICES FEATURING TEXTILE GOODS, MEN'S AND WOMEN'S CLOTHING, SKIN AND HAIR CARE PRODUCTS, BOOKS AND CDS, AND BEDROOM AND BATH ACCESSORIES SUCH AS CANDLES, SOAP DISHES, CONTAINERS SUCH AS JARS AND BASKETS, MIRRORS, TOILETRY BAGS, AND DECORATIVE ITEMS (U.S. CLS. 100, 101 AND 102).

FIRST USE 11-2-2004; IN COMMERCE 11-2-2004.

CLASS 35—(Continued).

3,178,012. AMERICAN CANCER SOCIETY, INC., ATLANTA, GA. SN 78-489,285. PUB. 12-20-2005, FILED 9-24-2004.

GREAT AMERICAN HEALTH CHECK

THE MARK CONSISTS OF STANDARD CHARACTERS WITHOUT CLAIM TO ANY PARTICULAR FONT, STYLE, SIZE, OR COLOR.

NO CLAIM IS MADE TO THE EXCLUSIVE RIGHT TO USE "HEALTH CHECK", APART FROM THE MARK AS SHOWN.

FOR PROMOTING PUBLIC AWARENESS OF CANCER PREVENTION (U.S. CLS. 100, 101 AND 102).

FIRST USE 5-31-2005; IN COMMERCE 5-31-2005.

3,178,017. FUEL MANAGERS, INCORPORATED, TULSA, OK. SN 78-491,194. PUB. 10-18-2005, FILED 9-29-2004.

CUSTOMIZE, OPTIMIZE, MAXIMIZE

THE MARK CONSISTS OF STANDARD CHARACTERS WITHOUT CLAIM TO ANY PARTICULAR FONT, STYLE, SIZE, OR COLOR.

FOR FUEL MANAGEMENT SERVICES FOR OTHERS, NAMELY, INVENTORY MANAGEMENT, PROVIDING DATA FOR COMPLIANCE WITH ENVIRONMENTAL LAWS AND REGULATIONS, AND FUEL TRANSPORTATION LOGISTICS MANAGEMENT SERVICES IN THE NATURE OF DELIVERY SCHEDULING, PURCHASE TIMING OPTIMIZATION AND FUEL REPORTING (U.S. CLS. 100, 101 AND 102).

FIRST USE 10-1-2005; IN COMMERCE 10-1-2005.

CLASS 35—(Continued).

3,178,021. PRN CORPORATION, SAN FRANCISCO, CA. SN 78-492,676. PUB. 9-6-2005, FILED 9-30-2004.

CLASS 35—(Continued).

3,178,034. SNIDER, SEAN M., DENVER, CO. SN 78-499,762. PUB. 12-27-2005, FILED 10-14-2004.

YOUR CHANNEL

THE MARK CONSISTS OF STANDARD CHARACTERS WITHOUT CLAIM TO ANY PARTICULAR FONT, STYLE, SIZE, OR COLOR.

FOR ADVERTISING SERVICES, NAMELY, PROMOTING THE GOODS AND SERVICES OF OTHERS IN A WIDE VARIETY OF FIELDS, THROUGH THE DISTRIBUTION OF PRINTED, AUDIO AND AUDIO-VISUAL PROMOTIONAL MATERIALS AND BY RENDERING SALES AND PROMOTION ADVICE; ADVERTISING AGENCY SERVICES; PLACING ADVERTISEMENTS FOR OTHERS; PRODUCTION AND DISTRIBUTION OF RADIO AND TELEVISION COMMERCIALS; PRODUCING AUDIO AND VIDEO INFOMERCIALS; BUSINESS MARKETING CONSULTING SERVICES; PROVIDING INFORMATION TO THE PUBLIC ABOUT THE PRODUCTS AND SERVICES OF OTHERS VIA IN-STORE DELIVERY OF FULL MOTION VIDEO, AUDIO, TEXT AND GRAPHIC IMAGES IN THE FORM OF TELEVISION PROGRAMS, MUSIC VIDEOS, MOVIE PREVIEWS, COMMERCIALS AND INFOMERCIALS (U.S. CLS. 100, 101 AND 102).

FIRST USE 11-10-2004; IN COMMERCE 11-10-2004.

Wicked Ways Art Gallery and Brokerage

THE MARK CONSISTS OF STANDARD CHARACTERS WITHOUT CLAIM TO ANY PARTICULAR FONT, STYLE, SIZE, OR COLOR.

NO CLAIM IS MADE TO THE EXCLUSIVE RIGHT TO USE "ART GALLERY AND BROKERAGE", APART FROM THE MARK AS SHOWN.

FOR ONLINE RETAIL CONSIGNMENT STORES IN THE FIELD OF ARTWORK (U.S. CLS. 100, 101 AND 102). FIRST USE 4-14-2005; IN COMMERCE 4-14-2005.

3,178,032. WORKSTREAM U.S.A., INC., MAITLAND, FL. SN 78-498,371. PUB. 1-3-2006, FILED 10-12-2004.

3,178,054. GRAND TETON HOLDINGS, INC., JACKSON, WY. SN 78-508,817. PUB. 11-29-2005, FILED 10-30-2004.

TALENTCENTER

THE MARK CONSISTS OF STANDARD CHARACTERS WITHOUT CLAIM TO ANY PARTICULAR FONT, STYLE, SIZE, OR COLOR.

FOR PROVIDING A WEBSITE FEATURING INFORMATION ABOUT EMPLOYEE MANAGEMENT, INCLUDING RECRUITMENT, PERFORMANCE EVALUATION, COMPENSATION, REWARDS AND TRANSITION (U.S. CLS. 100, 101 AND 102).

FIRST USE 10-0-2004; IN COMMERCE 10-0-2004.

NEW SOLUTION TOOLING

THE MARK CONSISTS OF STANDARD CHARACTERS WITHOUT CLAIM TO ANY PARTICULAR FONT, STYLE, SIZE, OR COLOR.

NO CLAIM IS MADE TO THE EXCLUSIVE RIGHT TO USE "TOOLING", APART FROM THE MARK AS SHOWN.

FOR MANUFACTURER'S REPRESENTATIVE SERVICES FOR THE INDUSTRIAL CUTTING TOOLS INDUSTRY (U.S. CLS. 100, 101 AND 102).

FIRST USE 11-30-2004; IN COMMERCE 11-30-2004.

CLASS 35—(Continued).

3,178,072. LIGHTNING MARKETING GROUP, LLC, HOLLYWOOD, FL. SN 78-518,451. PUB. 3-7-2006, FILED 11-17-2004.



FOR MULTI-LEVEL MARKETING BUSINESS SERVICES; RETAIL SERVICES BY DIRECT SOLICITATION BY SALES AGENTS IN THE FIELDS OF ADULT SEXUAL AIDS, LINGERIE, AND OILS FOR PERSONAL USE (U.S. CLS. 100, 101 AND 102).

FIRST USE 1-1-2006; IN COMMERCE 1-1-2006.

CLASS 35—(Continued).

3,178,088. HOME DECOR PRODUCTS, INC., EDISON, NJ. SN 78-527,494. PUB. 11-1-2005, FILED 12-6-2004.

CLIQUIDATE

THE MARK CONSISTS OF STANDARD CHARACTERS WITHOUT CLAIM TO ANY PARTICULAR FONT, STYLE, SIZE, OR COLOR.

FOR COMPUTERIZED ONLINE RETAIL SERVICES FEATURING GENERAL MERCHANDISE FOR THE HOME; COMPUTERIZED ONLINE CONSIGNMENT SERVICES FEATURING GENERAL MERCHANDISE FOR THE HOME; ONLINE MERCHANDISE LIQUIDATION SERVICES INVOLVING SURPLUS GENERAL MERCHANDISE FOR THE HOME (U.S. CLS. 100, 101 AND 102).

FIRST USE 4-22-2006; IN COMMERCE 4-22-2006.

3,178,076. AMERICAN ASSOCIATION OF HOMES AND SERVICES FOR THE AGING, WASHINGTON, DC. SN 78-519,876. PUB. 12-27-2005, FILED 11-19-2004.



OWNER OF U.S. REG. NOS. 1,435,075 AND 2,686,002. THE MARK CONSISTS OF A HEART CUPPED BY HANDS.

FOR ASSOCIATION SERVICES, NAMELY, PROMOTING THE INTERESTS OF THE ELDERLY IN THE AREAS OF HOME, HOUSING AND COMMUNITY SERVICES (U.S. CLS. 100, 101 AND 102).

FIRST USE 10-31-2004; IN COMMERCE 10-31-2004.

3,178,092. TARGET BRANDS, INC., MINNEAPOLIS, MN. SN 78-529,032. PUB. 2-21-2006, FILED 12-8-2004.

DESIGN FOR ALL

THE MARK CONSISTS OF STANDARD CHARACTERS WITHOUT CLAIM TO ANY PARTICULAR FONT, STYLE, SIZE, OR COLOR.

NO CLAIM IS MADE TO THE EXCLUSIVE RIGHT TO USE "DESIGN", APART FROM THE MARK AS SHOWN. FOR RETAIL DEPARTMENT STORE SERVICES (U.S. CLS. 100, 101 AND 102).

FIRST USE 1-16-2005; IN COMMERCE 1-16-2005.

CLASS 35—(Continued).

3,178,095. AMERICAN SPORTS BUILDERS ASSOCIATION, ELLICOT CITY, MD. SN 78-530,115. PUB. 11-22-2005, FILED 12-9-2004.

**AMERICAN SPORTS
BUILDERS
ASSOCIATION**

THE MARK CONSISTS OF STANDARD CHARACTERS WITHOUT CLAIM TO ANY PARTICULAR FONT, STYLE, SIZE, OR COLOR.

NO CLAIM IS MADE TO THE EXCLUSIVE RIGHT TO USE "AMERICAN" AND "BUILDERS ASSOCIATION", APART FROM THE MARK AS SHOWN.

FOR ASSOCIATION SERVICES, NAMELY PROMOTING THE INTERESTS OF BUILDERS OF TENNIS COURTS, RUNNING TRACKS, SWIMMING POOLS, BASKETBALL COURTS, BASEBALL FIELDS, SOCCER FIELDS AND SPORTS STADIUMS (U.S. CLS. 100, 101 AND 102).

FIRST USE 12-1-2005; IN COMMERCE 12-1-2005.

3,178,099. MARMCO PROPERTIES, LLC, SCOTTSDALE, AZ. SN 78-531,838. PUB. 12-6-2005, FILED 12-13-2004.

HILP IS ON THE WAY

THE MARK CONSISTS OF STANDARD CHARACTERS WITHOUT CLAIM TO ANY PARTICULAR FONT, STYLE, SIZE, OR COLOR.

FOR ARRANGING FOR CONTRACTUAL HOME IMPROVEMENT AND INTERIOR DESIGN SERVICES WITH THIRD PARTIES; REAL ESTATE ADVERTISING AND MARKETING SERVICES; REAL ESTATE SALES MANAGEMENT (U.S. CLS. 100, 101 AND 102).

FIRST USE 3-31-2005; IN COMMERCE 3-31-2005.

CLASS 35—(Continued).

3,178,135. ANDERSON, BENJAMIN L., NEW YORK, NY. SN 78-548,372. PUB. 12-6-2005, FILED 1-16-2005.

**Standard Research
Consultants**

THE MARK CONSISTS OF STANDARD CHARACTERS WITHOUT CLAIM TO ANY PARTICULAR FONT, STYLE, SIZE, OR COLOR.

NO CLAIM IS MADE TO THE EXCLUSIVE RIGHT TO USE RESEARCH CONSULTANTS, APART FROM THE MARK AS SHOWN.

FOR BUSINESS VALUATIONS, INVESTIGATIONS, EVALUATIONS, EXPERT APPRAISALS, INFORMATION AND RESEARCH OF TANGIBLE AND INTANGIBLE BUSINESS PROPERTY (U.S. CLS. 100, 101 AND 102).

FIRST USE 3-19-2006; IN COMMERCE 3-19-2006.

3,178,143. DONNA MIROS, INC., CRANFORD, NJ. SN 78-551,407. PUB. 2-14-2006, FILED 1-21-2005.

DONNA & COMPANY

THE MARK CONSISTS OF STANDARD CHARACTERS WITHOUT CLAIM TO ANY PARTICULAR FONT, STYLE, SIZE, OR COLOR.

NO CLAIM IS MADE TO THE EXCLUSIVE RIGHT TO USE "COMPANY", APART FROM THE MARK AS SHOWN.

FOR RETAIL STORE SERVICES, ONLINE RETAIL STORE SERVICES AND MAIL ORDER SERVICES, ALL FEATURING CANDY AND CONFECTIONS, CHOCOLATE, WEDDING FAVORS, CHOCOLATE CANDY BARS AND NON-CUSTOMIZED GIFT BASKETS CONTAINING CANDY AND CONFECTIONS, CHOCOLATE, WEDDING FAVORS AND CHOCOLATE CANDY BARS (U.S. CLS. 100, 101 AND 102).

FIRST USE 6-1-2005; IN COMMERCE 6-1-2005.

CLASS 35—(Continued).

3,178,147. PARTACZ, RONALD W., WEST SENECA, NY. AND PARTACZ, MARCIA H., WEST SENECA, NY. AND EWEN, JONATHAN R., WEST SENECA, NY. AND STOVER, KRISTEN A., WEST SENECA, NY. AND CRISTINA, JOSEPH R., DEPEW, NY. SN 78-552,591. PUB. 3-21-2006, FILED 1-24-2005.



FOR OPERATING AN ONLINE MARKETPLACE FOR SELLERS OF GOODS AND/OR SERVICES; COMPUTERIZED ONLINE ORDERING FEATURING GENERAL MERCHANDISE AND GENERAL CONSUMER GOODS (U.S. CLS. 100, 101 AND 102).
FIRST USE 11-16-2005; IN COMMERCE 11-16-2005.

3,178,154. COLONIAL TAX COMPLIANCE CO., ROSWELL, GA. SN 78-556,331. PUB. 1-3-2006, FILED 1-28-2005.



THE MARK CONSISTS OF THE WORD SALIS WITH MULTIPLE STYLIZED DOTS ABOVE THE LETTER "I".
FOR TAX PLANNING FOR BUSINESSES (U.S. CLS. 100, 101 AND 102).
FIRST USE 3-1-2005; IN COMMERCE 6-1-2005.

CLASS 35—(Continued).

3,178,190. ENERGY INDUSTRIES, HONOLULU, HI. SN 78-567,919. PUB. 5-16-2006, FILED 2-15-2005.

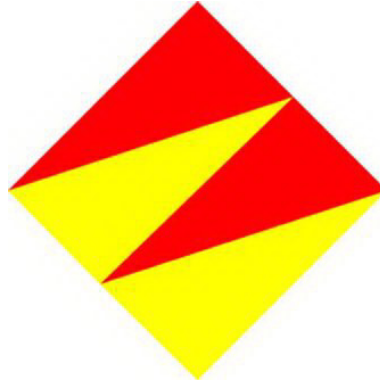

THE COLORS RED AND YELLOW ARE CLAIMED AS A FEATURE OF THE MARK.

THE MARK CONSISTS OF A SQUARE DIVIDED INTO 4 TRIANGLES OF EQUAL SIZE. THE COLORS RED AND YELLOW APPEAR ON ALTERNATING TRIANGLES WITHIN THE SQUARE.

FOR ENERGY AUDITING (U.S. CLS. 100, 101 AND 102).
FIRST USE 1-1-1997; IN COMMERCE 5-1-1998.

3,178,213. REED, MARY HUTCHINGS, CHICAGO, IL. AND POWELL, CURT, CHICAGO, IL. SN 78-572,588. PUB. 1-24-2006, FILED 2-22-2005.



THE MARK CONSISTS OF STANDARD CHARACTERS WITHOUT CLAIM TO ANY PARTICULAR FONT, STYLE, SIZE, OR COLOR.

FOR LICENSING OF MUSICAL THEATRICAL ENTERTAINMENT (U.S. CLS. 100, 101 AND 102).
FIRST USE 4-15-2006; IN COMMERCE 4-15-2006.

CLASS 35—(Continued).

3,178,230. JFC TEMPS, INC., CAMP HILL, PA. SN 78-575,240.
PUB. 11-29-2005, FILED 2-25-2005.

JFC GLOBAL

THE MARK CONSISTS OF STANDARD CHARACTERS WITHOUT CLAIM TO ANY PARTICULAR FONT, STYLE, SIZE, OR COLOR.

OWNER OF U.S. REG. NOS. 2,326,411 AND 2,480,513.
NO CLAIM IS MADE TO THE EXCLUSIVE RIGHT TO USE "GLOBAL", APART FROM THE MARK AS SHOWN.
FOR PERSONNEL PLACEMENT SERVICES (U.S. CLS. 100, 101 AND 102).

FIRST USE 5-31-2005; IN COMMERCE 5-31-2005.

CLASS 35—(Continued).

3,178,269. CITY OF HOMESTEAD, HOMESTEAD, FL. SN 78-585,146. PUB. 12-13-2005, FILED 3-11-2005.

Homestead is Home

THE MARK CONSISTS OF STANDARD CHARACTERS WITHOUT CLAIM TO ANY PARTICULAR FONT, STYLE, SIZE, OR COLOR.

NO CLAIM IS MADE TO THE EXCLUSIVE RIGHT TO USE "HOMESTEAD", APART FROM THE MARK AS SHOWN.

FOR MUNICIPAL SERVICES, NAMELY, PROMOTING THE ECONOMIC AND BUSINESS DEVELOPMENT OF THE CITY OF HOMESTEAD, FLORIDA, INCLUDING ADVANCING ITS COMMUNITY, EDUCATIONAL, RECREATIONAL, CULTURAL, HISTORICAL, AND MUNICIPAL INTERESTS (U.S. CLS. 100, 101 AND 102).

FIRST USE 1-17-2005; IN COMMERCE 8-14-2006.

3,178,231. ALLEGIANCE CORPORATION, MCGAW PARK, IL. SN 78-575,414. PUB. 1-10-2006, FILED 2-25-2005.

PARCONNECT

THE MARK CONSISTS OF STANDARD CHARACTERS WITHOUT CLAIM TO ANY PARTICULAR FONT, STYLE, SIZE, OR COLOR.

FOR WHOLESALE DISTRIBUTORSHIPS IN THE FIELD OF MEDICAL SUPPLIES, HEALTHCARE AND PHARMACEUTICALS (U.S. CLS. 100, 101 AND 102).
FIRST USE 8-2-2005; IN COMMERCE 8-2-2005.

3,178,319. LOVE & PRIDE, LLC, PHILADELPHIA, PA. SN 78-593,772. PUB. 12-20-2005, FILED 3-23-2005.

loveandpride.com

THE MARK CONSISTS OF STANDARD CHARACTERS WITHOUT CLAIM TO ANY PARTICULAR FONT, STYLE, SIZE, OR COLOR.

OWNER OF CANADA REG. NO. TMA467632, DATED 12-13-1996, EXPIRES 12-13-2011.

FOR COMPUTERIZED ONLINE RETAIL SERVICES IN THE FIELD OF JEWELRY, CLOTHING AND ACCESSORIES (U.S. CLS. 100, 101 AND 102).

FIRST USE 2-1-2005; IN COMMERCE 4-17-2005.

CLASS 35—(Continued).

3,178,440. I-SAFE AMERICA, INC., CARLSBAD, CA. SN 78-631,369. PUB. 2-7-2006, FILED 5-17-2005.

Learn Before You Burn

THE MARK CONSISTS OF STANDARD CHARACTERS WITHOUT CLAIM TO ANY PARTICULAR FONT, STYLE, SIZE, OR COLOR.

FOR PROMOTING PUBLIC AWARENESS OF THE NEED TO PROTECT INTELLECTUAL PROPERTY AND TO PREVENT ILLEGAL MUSIC DOWNLOADING (U.S. CLS. 100, 101 AND 102).

FIRST USE 4-3-2006; IN COMMERCE 4-3-2006.

3,178,443. PORTAUTHORITY TECHNOLOGIES, INC., PALO ALTO, CA. SN 78-631,909. PUB. 1-31-2006, FILED 5-17-2005.

PORTAUTHORITY TECHNOLOGIES

THE MARK CONSISTS OF STANDARD CHARACTERS WITHOUT CLAIM TO ANY PARTICULAR FONT, STYLE, SIZE, OR COLOR.

OWNER OF U.S. REG. NO. 2,772,306.

NO CLAIM IS MADE TO THE EXCLUSIVE RIGHT TO USE "TECHNOLOGIES", APART FROM THE MARK AS SHOWN.

FOR BUSINESS CONSULTATION SERVICES, NAMELY REVIEWING, EVALUATING AND PREPARING POLICIES, PROCEDURES AND PROTOCOLS FOR BUSINESSES TO MONITOR AND CONTROL PRIVATE, PROPRIETARY AND CONFIDENTIAL DATA AND INFORMATION; ANALYZING, COMPILING AND CLASSIFYING DATA TO CREATE POLICIES, PROCEDURES AND PROTOCOLS FOR ENTERPRISE DATA AND INFORMATION PROTECTION (U.S. CLS. 100, 101 AND 102).

FIRST USE 5-15-2005; IN COMMERCE 5-30-2005.

3,178,451. BOTTLENOTES, INC., PALO ALTO, CA. SN 78-634,873. PUB. 2-7-2006, FILED 5-23-2005.

BOTTLE NOTES

THE MARK CONSISTS OF STANDARD CHARACTERS WITHOUT CLAIM TO ANY PARTICULAR FONT, STYLE, SIZE, OR COLOR.

FOR ONLINE RETAIL STORE SERVICES FEATURING WINE (U.S. CLS. 100, 101 AND 102).

FIRST USE 8-31-2006; IN COMMERCE 8-31-2006.

CLASS 35—(Continued).

3,178,461. POLVI, S JACOB, BEND, OR. SN 78-640,480. PUB. 3-14-2006, FILED 5-31-2005.

CENTER OF SUSTAINABILITY

THE MARK CONSISTS OF STANDARD CHARACTERS WITHOUT CLAIM TO ANY PARTICULAR FONT, STYLE, SIZE, OR COLOR.

FOR ASSOCIATION SERVICES, NAMELY, PROMOTING THE INTERESTS OF SUSTAINABILITY PROFESSIONALS (U.S. CLS. 100, 101 AND 102).

FIRST USE 5-1-2005; IN COMMERCE 6-1-2006.

3,178,465. SCHOLASTIC INC., NEW YORK, NY. SN 78-640,995. PUB. 4-18-2006, FILED 6-1-2005.



NO CLAIM IS MADE TO THE EXCLUSIVE RIGHT TO USE "INTERACTIVE LEARNING CLUB", APART FROM THE MARK AS SHOWN.

FOR MAIL ORDER AND ON-LINE BUYING CLUB SERVICES FEATURING COMPUTER SOFTWARE AND PRERECORDED VIDEO, AUDIO AND CD-ROMS FOR STUDENTS (U.S. CLS. 100, 101 AND 102).

FIRST USE 9-1-2005; IN COMMERCE 9-1-2005.

3,178,475. ANCHOR DISTRIBUTORS, NEW KENSINGTON, PA. SN 78-646,623. PUB. 2-21-2006, FILED 6-8-2005.

Think Outside the Big Box

THE MARK CONSISTS OF STANDARD CHARACTERS WITHOUT CLAIM TO ANY PARTICULAR FONT, STYLE, SIZE, OR COLOR.

FOR ADVERTISING AND PROMOTION OF INDEPENDENT BOOKSELLERS THROUGH THE PRINT MEDIA (U.S. CLS. 100, 101 AND 102).

FIRST USE 7-1-2005; IN COMMERCE 7-1-2005.

CLASS 35—(Continued).

3,178,492. DESILVESTRO, HANS, HOWICK, AUCKLAND, NEW ZEALAND. SN 78-653,717. PUB. 4-18-2006, FILED 6-18-2005.

KNOW HOUND

THE MARK CONSISTS OF STANDARD CHARACTERS WITHOUT CLAIM TO ANY PARTICULAR FONT, STYLE, SIZE, OR COLOR.

FOR BUSINESS MANAGEMENT AND BUSINESS CONSULTING AND ADVISORY SERVICES IN THE FIELDS OF NEW TECHNOLOGY INNOVATION; PROVIDING INFORMATION IN THE FIELD OF MARKET RESEARCH (U.S. CLS. 100, 101 AND 102).

FIRST USE 5-1-2005; IN COMMERCE 6-15-2005.

3,178,503. GENERAL ELECTRIC COMPANY, SCHENECTADY, NY. SN 78-657,618. PUB. 3-14-2006, FILED 6-24-2005.

GE

THE MARK CONSISTS OF STANDARD CHARACTERS WITHOUT CLAIM TO ANY PARTICULAR FONT, STYLE, SIZE, OR COLOR.

OWNER OF U.S. REG. NOS. 986,362, 1,679,636, AND OTHERS.

FOR SUPPLY CHAIN MANAGEMENT AND CONSULTING SERVICES IN THE AREAS OF CHEMICAL PRODUCT AND SERVICE SOURCING AND PROCUREMENT, PRODUCT INVENTORY AND SUPPLY MANAGEMENT AND COST CONTAINMENT; CONSULTING, MARKETING, COST AND PRICING ANALYSIS RELATING TO ELECTROCHEMICAL LIQUID PURIFICATION UNITS FOR USE IN THE INDUSTRIAL SECTOR (U.S. CLS. 100, 101 AND 102).

FIRST USE 1-31-2003; IN COMMERCE 1-31-2003.

3,178,531. COPY CAT USA, L.L.C., CHESTERFIELD, MO. SN 78-665,889. PUB. 5-2-2006, FILED 7-7-2005.



NO CLAIM IS MADE TO THE EXCLUSIVE RIGHT TO USE "USA", APART FROM THE MARK AS SHOWN.

FOR PHOTOCOPYING, REPRODUCING AND COMPILING DOCUMENTS FOR OTHERS; PRINTING, WORD PROCESSING, TYPING, AND ASSEMBLING DOCUMENTS FOR OTHERS (U.S. CLS. 100, 101 AND 102).

FIRST USE 8-29-2005; IN COMMERCE 8-29-2005.

CLASS 35—(Continued).

3,178,532. JOBJOINER.COM, LLC, BOYERTOWN, PA. SN 78-666,066. PUB. 3-21-2006, FILED 7-8-2005.

JOBJOINER.COM

THE MARK CONSISTS OF STANDARD CHARACTERS WITHOUT CLAIM TO ANY PARTICULAR FONT, STYLE, SIZE, OR COLOR.

FOR PROVIDING ON-LINE INFORMATION IN THE FIELDS OF EMPLOYMENT, RECRUITMENT, CAREERS, JOB RESOURCES, JOB LISTINGS AND RESUMES; PROVIDING ON-LINE INTERACTIVE EMPLOYMENT COUNSELING AND RECRUITMENT SERVICES; PROVIDING ON-LINE EMPLOYMENT PLACEMENT SERVICES, NAMELY, RESUME MATCHING SERVICES VIA A GLOBAL COMPUTER NETWORK (U.S. CLS. 100, 101 AND 102).

FIRST USE 5-31-2006; IN COMMERCE 5-31-2006.

3,178,535. MANHEIM AUCTIONS, INC., ATLANTA, GA. SN 78-667,489. PUB. 4-11-2006, FILED 7-11-2005.

TOTAL RESOURCE AUCTIONS

THE MARK CONSISTS OF STANDARD CHARACTERS WITHOUT CLAIM TO ANY PARTICULAR FONT, STYLE, SIZE, OR COLOR.

NO CLAIM IS MADE TO THE EXCLUSIVE RIGHT TO USE "AUCTIONS", APART FROM THE MARK AS SHOWN. FOR SALVAGE VEHICLE AUCTIONS (U.S. CLS. 100, 101 AND 102).

FIRST USE 8-15-2005; IN COMMERCE 8-15-2005.

3,178,552. PORTER, JESSICA L., NEW YORK CITY, NY. SN 78-675,455. PUB. 4-11-2006, FILED 7-21-2005.

Raandesk

THE MARK CONSISTS OF STANDARD CHARACTERS WITHOUT CLAIM TO ANY PARTICULAR FONT, STYLE, SIZE, OR COLOR.

FOR ART GALLERIES (U.S. CLS. 100, 101 AND 102).

FIRST USE 8-4-2005; IN COMMERCE 8-4-2005.

CLASS 35—(Continued).

3,178,568. VICKERS, BILLY, L, PHOENIX, AZ. SN 78-682,322. PUB. 5-16-2006, FILED 7-31-2005.

AuditMatrix

THE MARK CONSISTS OF STANDARD CHARACTERS WITHOUT CLAIM TO ANY PARTICULAR FONT, STYLE, SIZE, OR COLOR.

FOR BUSINESS AUDITING (U.S. CLS. 100, 101 AND 102).

FIRST USE 11-1-2005; IN COMMERCE 3-1-2006.

3,178,569. MANHEIM AUCTIONS, INC., ATLANTA, GA. SN 78-683,250. PUB. 4-18-2006, FILED 8-2-2005.

TOTAL RESOURCE AUCTIONS

NO CLAIM IS MADE TO THE EXCLUSIVE RIGHT TO USE "AUCTIONS", APART FROM THE MARK AS SHOWN. THE MARK CONSISTS OF TWO ARROWS THAT FORM THE LETTER O IN THE WORD RESOURCE.

FOR SALVAGE VEHICLE AUCTIONS (U.S. CLS. 100, 101 AND 102).

FIRST USE 8-15-2005; IN COMMERCE 8-15-2005.

3,178,571. AMERICAN ACADEMY OF HOSPITALITY SCIENCES, INC., NEW YORK, NY. SN 78-685,770. PUB. 4-18-2006, FILED 8-4-2005.

SIX STAR DIAMOND AWARD

THE MARK CONSISTS OF STANDARD CHARACTERS WITHOUT CLAIM TO ANY PARTICULAR FONT, STYLE, SIZE, OR COLOR.

OWNER OF U.S. REG. NOS. 2,667,791 AND 2,945,427.

NO CLAIM IS MADE TO THE EXCLUSIVE RIGHT TO USE "AWARD", APART FROM THE MARK AS SHOWN.

FOR CONDUCTING BUSINESS ESTABLISHMENT AWARD PROGRAMS TO PROMOTE AND RECOGNIZE ON THE JOB EXCELLENCE, HOSPITALITY AND QUALITY IN THE HOSPITALITY INDUSTRY (U.S. CLS. 100, 101 AND 102).

FIRST USE 8-2-2006; IN COMMERCE 8-2-2006.

CLASS 35—(Continued).

3,178,573. GIFT CERTIFICATE CENTER, INC., MINNEAPOLIS, MN. SN 78-686,019. PUB. 4-25-2006, FILED 8-4-2005.

MEANINGFUL MEMORABLE MEASURABLE

THE MARK CONSISTS OF STANDARD CHARACTERS WITHOUT CLAIM TO ANY PARTICULAR FONT, STYLE, SIZE, OR COLOR.

FOR PROMOTING BY TELEPHONE, FACSIMILE, MAIL, ELECTRONIC MAIL, OR THE WORLD WIDE WEB THE SALE OF GOODS AND SERVICES OF OTHERS THROUGH THE DISTRIBUTION OF ACTUAL OR VIRTUAL GIFT CERTIFICATES, GIFT CARDS, DEBIT CARDS OR STORED VALUE CARDS TO EMPLOYEES TO REWARD LOYALTY, PERFORMANCE, SALES OR OTHER ACHIEVEMENTS OR EVENTS, OR TO CONSUMERS TO PROMOTE PARTICULAR PRODUCTS, SERVICES, BRANDS OR COMPANIES; PROVIDING BUSINESS CONSULTING SERVICES IN THE FIELD OF EMPLOYEE AND CONSUMER RECOGNITION PROGRAMS TO IMPROVE AND REWARD THE PERFORMANCE, ACQUISITION, RETENTION AND LOYALTY OF EMPLOYEES, CUSTOMERS AND PARTNERS; AND MANAGEMENT OF EMPLOYEE AND CONSUMER RECOGNITION PROGRAMS TO IMPROVE AND REWARD THE PERFORMANCE, ACQUISITION, RETENTION AND LOYALTY OF EMPLOYEES, CUSTOMERS AND PARTNERS (U.S. CLS. 100, 101 AND 102).

FIRST USE 10-7-2005; IN COMMERCE 10-7-2005.

3,178,585. WHITING, JENNIFER M., FLORENCE, MA. SN 78-697,647. PUB. 6-6-2006, FILED 8-22-2005.

got rhythm?

THE MARK CONSISTS OF STANDARD CHARACTERS WITHOUT CLAIM TO ANY PARTICULAR FONT, STYLE, SIZE, OR COLOR.

FOR ADVERTISING AND PROMOTION SERVICES FOR ONLINE OR RETAIL ESTABLISHMENTS FEATURING TOOLS TO TEACH RHYTHMIC MOVEMENT (U.S. CLS. 100, 101 AND 102).

FIRST USE 1-19-2006; IN COMMERCE 1-19-2006.

3,178,608. ACORN MEDIA GROUP INC., SILVER SPRING, MD. SN 78-709,699. PUB. 5-23-2006, FILED 9-9-2005.

Acacia

CLASS 35—(Continued).

THE MARK CONSISTS OF STANDARD CHARACTERS WITHOUT CLAIM TO ANY PARTICULAR FONT, STYLE, SIZE, OR COLOR.

FOR CATALOG ORDERING SERVICE FEATURING HEALTH AND WELLNESS VIDEOS AND HEALTH AND WELLNESS-RELATED ACCESSORIES, INCLUDING CLOTHING; ELECTRONIC CATALOG SERVICES FEATURING HEALTH AND WELLNESS VIDEOS AND HEALTH AND WELLNESS-RELATED ACCESSORIES, INCLUDING CLOTHING; MAIL ORDER CATALOG SERVICES FEATURING HEALTH AND WELLNESS VIDEOS AND HEALTH AND WELLNESS-RELATED ACCESSORIES, INCLUDING CLOTHING (U.S. CLS. 100, 101 AND 102).

FIRST USE 2-21-2006; IN COMMERCE 2-21-2006.

CLASS 35—(Continued).

3,178,632. HALLMARK LICENSING, INC., KANSAS CITY, MO. SN 78-721,230. PUB. 6-6-2006, FILED 9-27-2005.

3,178,610. FAIR MARKET, INC., WENTZVILLE, MO. SN 78-710,761. PUB. 5-23-2006, FILED 9-12-2005.

HALLMARK INSIGHTS**SCHOOL LUNCH SOLUTIONS**

THE MARK CONSISTS OF STANDARD CHARACTERS WITHOUT CLAIM TO ANY PARTICULAR FONT, STYLE, SIZE, OR COLOR.

NO CLAIM IS MADE TO THE EXCLUSIVE RIGHT TO USE "SCHOOL LUNCH", APART FROM THE MARK AS SHOWN.

FOR DISTRIBUTORSHIPS IN THE FIELD OF FOOD (U.S. CLS. 100, 101 AND 102).

FIRST USE 4-1-2006; IN COMMERCE 4-1-2006.

3,178,616. ARONSON FURNITURE COMPANY, CHICAGO, IL. SN 78-712,700. PUB. 6-6-2006, FILED 9-14-2005.

ARONSON ROOMS & MORE

THE MARK CONSISTS OF STANDARD CHARACTERS WITHOUT CLAIM TO ANY PARTICULAR FONT, STYLE, SIZE, OR COLOR.

NO CLAIM IS MADE TO THE EXCLUSIVE RIGHT TO USE "ROOMS", APART FROM THE MARK AS SHOWN.

FOR RETAIL FURNITURE STORES (U.S. CLS. 100, 101 AND 102).

FIRST USE 1-18-2006; IN COMMERCE 1-18-2006.

THE MARK CONSISTS OF STANDARD CHARACTERS WITHOUT CLAIM TO ANY PARTICULAR FONT, STYLE, SIZE, OR COLOR.

FOR BUSINESS CONSULTING SERVICES IN THE FIELD OF EMPLOYEE AND CONSUMER RECOGNITION PROGRAMS TO IMPROVE AND REWARD THE PERFORMANCE, ACQUISITION, RETENTION AND LOYALTY OF EMPLOYEES, CUSTOMERS, AND PARTNERS; CONDUCTING EMPLOYEE AND CONSUMER RECOGNITION PROGRAMS TO IMPROVE AND REWARD THE PERFORMANCE, ACQUISITION, RETENTION AND LOYALTY OF EMPLOYEES, CUSTOMERS AND PARTNERS; AND BUSINESS MANAGEMENT AND CONSULTATION IN THE FIELD OF EMPLOYEE AND CONSUMER RECOGNITION PROGRAMS TO IMPROVE AND REWARD THE PERFORMANCE, ACQUISITION, RETENTION AND LOYALTY OF EMPLOYEES, CUSTOMERS AND PARTNERS; PROMOTING BY TELEPHONE, FACSIMILE, MAIL, ELECTRONIC MAIL, OR THE WORLD WIDE WEB THE GOODS AND SERVICES OF OTHERS THROUGH THE DISTRIBUTION OF ACTUAL OR VIRTUAL GIFT CERTIFICATES, GIFT CARDS, DEBIT CARDS, STORED VALUE CARDS, OR ELECTRONIC GREETING CARDS TO EMPLOYEES TO REWARD LOYALTY, PERFORMANCE, SALES OR OTHER ACHIEVEMENTS OR EVENTS, OR TO CONSUMERS TO PROMOTE PARTICULAR PRODUCTS, SERVICES, BRANDS OR COMPANIES; AND GIFT CARD SERVICES, NAMELY, ISSUING GIFT CARD CERTIFICATES THAT MAY BE REDEEMED FOR GOODS OR SERVICES (U.S. CLS. 100, 101 AND 102).

FIRST USE 3-15-2006; IN COMMERCE 3-15-2006.

CLASS 35—(Continued).

3,178,633. HALLMARK LICENSING, INC., KANSAS CITY, MO. SN 78-721,246. PUB. 6-6-2006, FILED 9-27-2005.

HALLMARK INSIGHTS BUSINESS
INCENTIVE SOLUTIONS

THE MARK CONSISTS OF STANDARD CHARACTERS WITHOUT CLAIM TO ANY PARTICULAR FONT, STYLE, SIZE, OR COLOR.

NO CLAIM IS MADE TO THE EXCLUSIVE RIGHT TO USE BUSINESS INCENTIVE SOLUTIONS, APART FROM THE MARK AS SHOWN.

FOR BUSINESS CONSULTING SERVICES IN THE FIELD OF EMPLOYEE AND CONSUMER RECOGNITION PROGRAMS TO IMPROVE AND REWARD THE PERFORMANCE, ACQUISITION, RETENTION AND LOYALTY OF EMPLOYEES, CUSTOMERS, AND PARTNERS; CONDUCTING EMPLOYEE AND CONSUMER RECOGNITION PROGRAMS TO IMPROVE AND REWARD THE PERFORMANCE, ACQUISITION, RETENTION AND LOYALTY OF EMPLOYEES, CUSTOMERS AND PARTNERS; AND BUSINESS MANAGEMENT AND CONSULTATION IN THE FIELD OF EMPLOYEE AND CONSUMER RECOGNITION PROGRAMS TO IMPROVE AND REWARD THE PERFORMANCE, ACQUISITION, RETENTION AND LOYALTY OF EMPLOYEES, CUSTOMERS AND PARTNERS; PROMOTING BY TELEPHONE, FACSIMILE, MAIL, ELECTRONIC MAIL, OR THE WORLD WIDE WEB THE GOODS AND SERVICES OF OTHERS THROUGH THE DISTRIBUTION OF ACTUAL OR VIRTUAL GIFT CERTIFICATES, GIFT CARDS, DEBIT CARDS, STORED VALUE CARDS, OR ELECTRONIC GREETING CARDS TO EMPLOYEES TO REWARD LOYALTY, PERFORMANCE, SALES OR OTHER ACHIEVEMENTS OR EVENTS, OR TO CONSUMERS TO PROMOTE PARTICULAR PRODUCTS, SERVICES, BRANDS OR COMPANIES; AND GIFT CARD SERVICES, NAMELY, ISSUING GIFT CARD CERTIFICATES THAT MAY BE REDEEMED FOR GOODS OR SERVICES (U.S. CLS. 100, 101 AND 102).

FIRST USE 3-15-2006; IN COMMERCE 3-15-2006.

CLASS 35—(Continued).

3,178,634. DANIS, PAUL O., DBA EASTWOODS CONSULTING, BOYLSTON, MA. SN 78-721,453. PUB. 5-30-2006, FILED 9-27-2005.

Eastwoods

THE MARK CONSISTS OF STANDARD CHARACTERS WITHOUT CLAIM TO ANY PARTICULAR FONT, STYLE, SIZE, OR COLOR.

FOR ACQUISITION AND MERGER CONSULTATION; ADVERTISING AND BUSINESS MANAGEMENT CONSULTANCY; ADVERTISING AND PROMOTION SERVICES AND RELATED CONSULTING; ADVERTISING CONSULTATION; ASSISTANCE, ADVISORY SERVICES AND CONSULTANCY WITH REGARD TO BUSINESS PLANNING, BUSINESS ANALYSIS, BUSINESS MANAGEMENT, AND BUSINESS ORGANIZATION; BUSINESS ACQUISITION AND MERGER CONSULTATION; BUSINESS ACQUISITIONS CONSULTATION; BUSINESS ADMINISTRATION CONSULTANCY; BUSINESS ADVISORY SERVICES, CONSULTANCY AND INFORMATION; BUSINESS CONSULTATION; BUSINESS CONSULTATION AND MANAGEMENT REGARDING MARKETING ACTIVITIES AND LAUNCHING OF NEW PRODUCTS; BUSINESS CONSULTATION SERVICES; BUSINESS CONSULTING AND BUSINESS INFORMATION FOR ENTERPRISES; BUSINESS CONSULTING SERVICES RELATING TO PRODUCT DISTRIBUTION, OPERATIONS MANAGEMENT SERVICES, LOGISTICS, REVERSE LOGISTICS, SUPPLY CHAIN, AND PRODUCTION SYSTEMS AND DISTRIBUTION SOLUTIONS; BUSINESS CONSULTING, INQUIRIES OR INFORMATION; BUSINESS CONSULTING, MANAGEMENT, PLANNING AND SUPERVISION; BUSINESS MANAGEMENT AND CONSULTATION; BUSINESS MANAGEMENT CONSULTANCY AND ADVISORY SERVICES; BUSINESS MANAGEMENT CONSULTANCY AS WELL AS DEVELOPMENT OF PROCESSES FOR THE ANALYSIS AND THE IMPLEMENTATION OF STRATEGY PLANS AND MANAGEMENT PROJECTS; BUSINESS MANAGEMENT CONSULTANCY SERVICES; BUSINESS MANAGEMENT CONSULTATION; BUSINESS MANAGEMENT CONSULTING AND ADVISORY SERVICES; BUSINESS MARKETING CONSULTING SERVICES; BUSINESS MERGER CONSULTATION; BUSINESS ORGANISATION AND MANAGEMENT CONSULTING SERVICES; BUSINESS ORGANIZATION AND OPERATION CONSULTANCY; BUSINESS RESEARCH CONSULTATION; COMMERCIAL CONSULTANCY; CONSULTANCY SERVICES REGARDING BUSINESS STRATEGIES; CONSULTATION IN THE FIELD OF BUSINESS ACQUISITIONS; CONSULTATION SERVICES IN THE FIELD OF COMPANY, BUSINESS SECTOR AND INDUSTRY DATA AND RESEARCH; CONSULTING SERVICES IN BUSINESS ORGANIZATION AND MANAGEMENT; CONSULTING SERVICES IN THE FIELD OF MANAGING INTELLECTUAL PROPERTIES; CONSULTING SERVICES RELATING TO PUBLICITY; MARKET RESEARCH CONSULTATION; MARKET SEGMENTATION CONSULTATION; MARKETING CONSULTING (U.S. CLS. 100, 101 AND 102).

FIRST USE 9-1-2006; IN COMMERCE 9-1-2006.

CLASS 36—INSURANCE AND FINANCIAL

CLASS 36—(Continued).

3,177,329. ACE LIMITED, HAMILTON BM 08, BERMUDA.
SN 76-006,410. PUB. 12-20-2005, FILED 3-21-2000.

ACE

FOR INSURANCE SERVICES, NAMELY, PROPERTY AND CASUALTY INSURANCE AND REINSURANCE UNDERWRITING, CLAIMS ADMINISTRATION AND LOSS CONTROL SERVICES, AND RELATED FINANCIAL SERVICES, NAMELY, FINANCIAL GUARANTY AND SURETY INSURANCE UNDERWRITING, MORTGAGE GUARANTY AND GUARANTY ASSURANCE UNDERWRITING, AND FINANCIAL RISK MANAGEMENT SERVICES, NAMELY, UNDERWRITING CREDIT DEFAULT SWAPS, FINITE RISK STRUCTURES AND OTHER FINANCIAL DERIVATIVES AND BALANCE SHEET PROTECTION PRODUCTS (U.S. CLS. 100, 101 AND 102).

FIRST USE 5-31-1998; IN COMMERCE 5-31-1998.

3,177,362. BOHAN GROUP LLC, SAN FRANCISCO, CA. SN
76-398,461. PUB. 3-18-2003, FILED 4-19-2002.

BRAINWEB

FOR FINANCIAL ANALYSIS AND CONSULTATION SERVICES, NAMELY REVIEWING, ANALYZING, PROVIDING DUE DILIGENCE, UNDERWRITING, QUALITY CONTROL, AUDITING AND REPORTING ON LOANS, LOAN PORTFOLIOS AND LINES OF CREDIT; MANIPULATING DATA, CREATING DATABASES AND DATABASE MANAGEMENT FOR DATA REGARDING LOANS, LOAN PORTFOLIOS AND LINES OF CREDIT, AND REPORTING ON FINANCIAL ANALYSIS AND INFORMATION OVER COMPUTER NETWORKS, INCLUDING A GLOBAL COMPUTER NETWORK (U.S. CLS. 100, 101 AND 102).

FIRST USE 2-0-2003; IN COMMERCE 2-0-2003.

3,177,441. MERCANTILE BANKSHARES CORPORATION,
BALTIMORE, MD. SN 76-589,481. PUB. 1-17-2006, FILED 4-
30-2004.

MERCANTILE SOUTHERN MARYLAND BANK

THE MARK CONSISTS OF STANDARD CHARACTERS WITHOUT CLAIM TO ANY PARTICULAR FONT, STYLE, SIZE, OR COLOR.

OWNER OF U.S. REG. NO. 2,866,156.

NO CLAIM IS MADE TO THE EXCLUSIVE RIGHT TO USE SOUTHERN MARYLAND BANK, APART FROM THE MARK AS SHOWN.

SEC. 2(F) AS TO "MERCANTILE".

FOR FINANCIAL SERVICES, NAMELY, MONEY LENDING AND INVESTMENT FUND TRANSFER AND TRANSACTION SERVICES; BANKING SERVICES; ON-LINE BANKING SERVICES; MUTUAL FUND BROKERAGE SERVICES; MORTGAGE LENDING SERVICES; MORTGAGE BROKERAGE SERVICES; HOME EQUITY LOAN SERVICES; AUTOMOBILE LOANS; SAVINGS ACCOUNT SERVICES; ESTATE PLANNING SERVICES; TRUST MANAGEMENT SERVICES; WEALTH MANAGEMENT SERVICES; ESTATE TRUST MANAGEMENT SERVICES; INVESTMENT MANAGEMENT SERVICES (U.S. CLS. 100, 101 AND 102).

FIRST USE 10-31-2004; IN COMMERCE 10-31-2004.

CLASS 36—(Continued).

3,177,442. MERCANTILE BANKSHARES CORPORATION,
BALTIMORE, MD. SN 76-589,484. PUB. 1-10-2006, FILED 4-
30-2004.

MERCANTILE PENINSULA BANK

THE MARK CONSISTS OF STANDARD CHARACTERS WITHOUT CLAIM TO ANY PARTICULAR FONT, STYLE, SIZE, OR COLOR.

OWNER OF U.S. REG. NO. 2,866,156.

NO CLAIM IS MADE TO THE EXCLUSIVE RIGHT TO USE BANK, APART FROM THE MARK AS SHOWN.

SEC. 2(F) AS TO "MERCANTILE".

FOR FINANCIAL SERVICES, NAMELY, MONEY LENDING AND INVESTMENT FUND TRANSFER AND TRANSACTION SERVICES; BANKING SERVICES; ON-LINE BANKING SERVICES; MUTUAL FUND BROKERAGE SERVICES; MORTGAGE LENDING SERVICES; MORTGAGE BROKERAGE SERVICES; HOME EQUITY LOAN SERVICES; AUTOMOBILE LOANS; SAVINGS ACCOUNT SERVICES; ESTATE PLANNING SERVICES; TRUST MANAGEMENT SERVICES; WEALTH MANAGEMENT SERVICES; ESTATE TRUST MANAGEMENT SERVICES; INVESTMENT MANAGEMENT SERVICES (U.S. CLS. 100, 101 AND 102).

FIRST USE 10-31-2004; IN COMMERCE 10-31-2004.

3,177,443. MERCANTILE BANKSHARES CORPORATION,
BALTIMORE, MD. SN 76-589,485. PUB. 1-10-2006, FILED 4-
30-2004.

MERCANTILE COUNTY BANK

THE MARK CONSISTS OF STANDARD CHARACTERS WITHOUT CLAIM TO ANY PARTICULAR FONT, STYLE, SIZE, OR COLOR.

OWNER OF U.S. REG. NO. 2,866,156.

NO CLAIM IS MADE TO THE EXCLUSIVE RIGHT TO USE BANK, APART FROM THE MARK AS SHOWN.

SEC. 2(F) AS TO "MERCANTILE".

FOR FINANCIAL SERVICES, NAMELY, MONEY LENDING AND INVESTMENT FUND TRANSFER AND TRANSACTION SERVICES; BANKING SERVICES; ON-LINE BANKING SERVICES; MUTUAL FUND BROKERAGE SERVICES; MORTGAGE LENDING SERVICES; MORTGAGE BROKERAGE SERVICES; HOME EQUITY LOAN SERVICES; AUTOMOBILE LOANS; SAVINGS ACCOUNT SERVICES; ESTATE PLANNING SERVICES; TRUST MANAGEMENT SERVICES; WEALTH MANAGEMENT SERVICES; ESTATE TRUST MANAGEMENT SERVICES; INVESTMENT MANAGEMENT SERVICES (U.S. CLS. 100, 101 AND 102).

FIRST USE 10-31-2004; IN COMMERCE 10-31-2004.

CLASS 36—(Continued).

3,177,453. COMMERCE BANCORP, INC., CHERRY HILL, NJ. SN 76-600,501. PUB. 11-22-2005, FILED 7-2-2004.

COMMERCE TRADEFINANCEDIRECT

THE MARK CONSISTS OF STANDARD CHARACTERS WITHOUT CLAIM TO ANY PARTICULAR FONT, STYLE, SIZE, OR COLOR.

OWNER OF U.S. REG. NOS. 2,084,001, 2,839,401, AND OTHERS.

FOR BANKING AND FINANCIAL SERVICES PROVIDED VIA THE INTERNET PERMITTING CUSTOMER INITIATION, TRACKING, AND REPORT GENERATION FOR LETTERS OF CREDIT, AMENDMENTS, PAYMENTS, ACCEPTANCES, AND DOCUMENTARY COLLECTIONS (U.S. CLS. 100, 101 AND 102).

FIRST USE 11-1-2004; IN COMMERCE 11-1-2004.

3,177,475. PATELCO CREDIT UNION, SAN FRANCISCO, CA. SN 76-609,506. PUB. 8-16-2005, FILED 8-31-2004.

YOUR MONEY. MORE VALUE. SMART CHOICE.

THE MARK CONSISTS OF STANDARD CHARACTERS WITHOUT CLAIM TO ANY PARTICULAR FONT, STYLE, SIZE, OR COLOR.

FOR CREDIT UNION SERVICES, NAMELY, PROVIDING BANKING SERVICES, SAVINGS AND CHECKING ACCOUNTS, CERTIFICATES OF DEPOSIT, HOME AND BUSINESS LOANS; ALL OF THE FOREGOING EXCLUDING CREDIT, DEBIT, OR OTHER MONETARY/PAYMENT CARD SERVICES (U.S. CLS. 100, 101 AND 102).

FIRST USE 1-1-2005; IN COMMERCE 1-1-2005.

3,177,478. PATELCO CREDIT UNION, SAN FRANCISCO, CA. SN 76-609,738. PUB. 8-16-2005, FILED 9-1-2004.



CREDIT UNION

Your money. More value. Smart choice.

NO CLAIM IS MADE TO THE EXCLUSIVE RIGHT TO USE "CREDIT UNION", APART FROM THE MARK AS SHOWN.

FOR CREDIT UNION SERVICES, NAMELY, PROVIDING BANKING SERVICES, SAVINGS AND CHECKING ACCOUNTS, CERTIFICATES OF DEPOSIT, HOME AND BUSINESS LOANS; ALL OF THE FOREGOING EXCLUDING CREDIT, DEBIT, OR OTHER MONETARY/PAYMENT CARD SERVICES (U.S. CLS. 100, 101 AND 102).

FIRST USE 1-1-2005; IN COMMERCE 1-1-2005.

CLASS 36—(Continued).

3,177,558. PORTLAND TEACHERS CREDIT UNION, PORTLAND, OR. SN 76-636,984. PUB. 5-2-2006, FILED 4-25-2005.

ONPOINT

THE MARK CONSISTS OF STANDARD CHARACTERS WITHOUT CLAIM TO ANY PARTICULAR FONT, STYLE, SIZE, OR COLOR.

FOR FINANCIAL SERVICES FOR CREDIT UNION MEMBERS, NAMELY SAVINGS, CHECKING, INDIVIDUAL RETIREMENT ACCOUNT SERVICES, SECURED AND UNSECURED LOAN FINANCING SERVICES, AND CREDIT CARD SERVICES (U.S. CLS. 100, 101 AND 102).

FIRST USE 12-3-2005; IN COMMERCE 12-3-2005.

3,177,563. RADIAN GUARANTY INC., PHILADELPHIA, PA. SN 76-638,102. PUB. 2-14-2006, FILED 5-9-2005.

SPLITEDGE

THE MARK CONSISTS OF STANDARD CHARACTERS WITHOUT CLAIM TO ANY PARTICULAR FONT, STYLE, SIZE, OR COLOR.

FOR MORTGAGE GUARANTY INSURANCE UNDERWRITING SERVICES (U.S. CLS. 100, 101 AND 102).

FIRST USE 4-0-2005; IN COMMERCE 7-25-2005.

3,177,573. FLOYD, JAMES CHRISTOPHER, DALLAS, TX. SN 76-642,544. PUB. 3-28-2006, FILED 7-8-2005.



THE MARK CONSISTS OF STANDARD CHARACTERS WITHOUT CLAIM TO ANY PARTICULAR FONT, STYLE, SIZE, OR COLOR.

FOR INVESTMENT MANAGEMENT AND INVESTMENT ADVISORY SERVICES (U.S. CLS. 100, 101 AND 102).

FIRST USE 10-1-2005; IN COMMERCE 10-1-2005.

CLASS 36—(Continued).

3,177,583. PORTLAND TEACHERS CREDIT UNION, PORTLAND, OR. SN 76-648,579. PUB. 4-25-2006, FILED 10-17-2005.

OnPoint

COMMUNITY CREDIT UNION

Real. Smart. Value.

NO CLAIM IS MADE TO THE EXCLUSIVE RIGHT TO USE "COMMUNITY CREDIT UNION", APART FROM THE MARK AS SHOWN.

FOR FINANCIAL SERVICES FOR CREDIT UNION MEMBERS, NAMELY SAVINGS, CHECKING, INDIVIDUAL RETIREMENT ACCOUNT SERVICES, SECURED AND UNSECURED LOAN FINANCING SERVICES, INVESTMENT ADVISORY SERVICES, DEBIT CARD SERVICES, AND CREDIT CARD SERVICES (U.S. CLS. 100, 101 AND 102).

FIRST USE 12-3-2005; IN COMMERCE 12-3-2005.

3,177,584. PORTLAND TEACHERS CREDIT UNION, PORTLAND, OR. SN 76-648,580. PUB. 4-25-2006, FILED 10-17-2005.

OnPoint

COMMUNITY CREDIT UNION

NO CLAIM IS MADE TO THE EXCLUSIVE RIGHT TO USE "COMMUNITY CREDIT UNION", APART FROM THE MARK AS SHOWN.

FOR FINANCIAL SERVICES FOR CREDIT UNION MEMBERS, NAMELY SAVINGS, CHECKING, INDIVIDUAL RETIREMENT ACCOUNT SERVICES, SECURED AND UNSECURED LOAN FINANCING SERVICES, INVESTMENT ADVISORY SERVICES, DEBIT CARD SERVICES, AND CREDIT CARD SERVICES (U.S. CLS. 100, 101 AND 102).

FIRST USE 12-3-2005; IN COMMERCE 12-3-2005.

CLASS 36—(Continued).

3,177,588. CLEARPOINT FINANCIAL SOLUTIONS, INC., RICHMOND, VA. SN 76-978,277. PUB. 11-15-2005, FILED 2-4-2005.

CLEARPOINT FINANCIAL SOLUTIONS

THE MARK CONSISTS OF STANDARD CHARACTERS WITHOUT CLAIM TO ANY PARTICULAR FONT, STYLE, SIZE, OR COLOR.

NO CLAIM IS MADE TO THE EXCLUSIVE RIGHT TO USE "FINANCIAL", APART FROM THE MARK AS SHOWN.

FOR CONSUMER CREDIT COUNSELING SERVICES, INCLUDING BUDGET DEBT COUNSELING, CREDIT REPORT COUNSELING CONSUMER FINANCIAL PLANNING SERVICES; CONSUMER FINANCIAL MANAGEMENT SERVICES, ALL OF THE FOREGOING SERVICES EXPRESSLY EXCLUDING SERVICES IN THE FIELD OF INVESTMENTS (U.S. CLS. 100, 101 AND 102).

FIRST USE 8-0-2005; IN COMMERCE 8-0-2005.

3,177,595. TRANSURETY, LLC, MINNEAPOLIS, MN. SN 78-045,923. PUB. 6-24-2003, FILED 1-31-2001.

INSURITI

FOR INSURANCE AGENCY SERVICES IN THE FIELD OF INTERNET TRANSMISSION LIABILITY; INSURANCE UNDERWRITING IN THE FIELD OF INTERNET TRANSMISSION LIABILITY (U.S. CLS. 100, 101 AND 102).

FIRST USE 6-30-2002; IN COMMERCE 6-30-2002.

3,177,678. PACIFIC CAPITAL GROUP, IRVINE, CA. SN 78-296,919. PUB. 6-1-2004, FILED 9-5-2003.

EVERYLOAN

FOR LENDING, NAMELY, MORTGAGE LENDING, HOME EQUITY LOANS, INSTALLMENT LOANS, LEASE-PURCHASE LOANS, AND TEMPORARY LOANS (U.S. CLS. 100, 101 AND 102).

FIRST USE 6-1-2004; IN COMMERCE 6-1-2004.

CLASS 36—(Continued).

3,177,747. HICKS, VERONICA, IRVINE, CA. SN 78-364,652. PUB. 6-28-2005, FILED 2-9-2004.

CONDOS ETC

THE MARK CONSISTS OF STANDARD CHARACTERS WITHOUT CLAIM TO ANY PARTICULAR FONT, STYLE, SIZE, OR COLOR.

NO CLAIM IS MADE TO THE EXCLUSIVE RIGHT TO USE "CONDOS", APART FROM THE MARK AS SHOWN.

FOR REAL ESTATE AGENCY SERVICES; REAL ESTATE MANAGEMENT SERVICES; REAL ESTATE MANAGEMENT SERVICES IN THE NATURE OF HOME OWNERS' ASSOCIATION SERVICES; MORTGAGE AND FINANCIAL SERVICES PERTAINING TO REAL ESTATE, NAMELY, MORTGAGE PROCUREMENT FOR OTHERS, BUYER PRE-QUALIFICATION OF MORTGAGES FOR MORTGAGE BROKERS AND BANKS, AND FINANCIAL VALUATION OF REAL ESTATE (U.S. CLS. 100, 101 AND 102).

FIRST USE 7-17-2004; IN COMMERCE 7-17-2004.

3,177,810. STANCORP FINANCIAL GROUP, INC., PORTLAND, OR. SN 78-402,722. PUB. 3-15-2005, FILED 4-15-2004.



TheStandard

FOR PROVIDING INVESTMENT AND ASSET MANAGEMENT SERVICES; UNDERWRITING OF ANNUITIES; INVESTMENT MANAGEMENT OF AND DISTRIBUTION OF ANNUITIES; UNDERWRITING OF INSURANCE, NAMELY, LIFE, ACCIDENTAL DEATH AND DISMEMBERMENT, DISABILITY, DISABILITY INCOME, LONG TERM CARE, DENTAL AND MEDICAL; ADMINISTRATION OF DISABILITY AND LIFE INSURANCE CLAIMS; FINANCIAL SERVICES IN THE NATURE OF PROVIDING FUNDING OPTIONS FOR RETIREMENT PLANS, FOR PROVIDING AND ADMINISTERING ANNUITIES, AND FOR ADMINISTERING RETIREMENT PLANS; INSURANCE ADMINISTRATION; INSURANCE BROKERAGE SERVICES; INSURANCE CONSULTATION; REGISTERED INVESTMENT ADVISER SERVICES PROVIDING PERFORMANCE ANALYSIS, FUND SUPPORT AND MODEL PORTFOLIOS; INVESTMENT BROKERAGE SERVICES; MORTGAGE LENDING (U.S. CLS. 100, 101 AND 102).

FIRST USE 2-10-2005; IN COMMERCE 2-10-2005.

CLASS 36—(Continued).

3,177,884. BERGMAN, JOHN, SCOTTSDALE, AZ. SN 78-444,784. PUB. 11-1-2005, FILED 7-1-2004.

ON Q FINANCIAL

THE MARK CONSISTS OF STANDARD CHARACTERS WITHOUT CLAIM TO ANY PARTICULAR FONT, STYLE, SIZE, OR COLOR.

NO CLAIM IS MADE TO THE EXCLUSIVE RIGHT TO USE "FINANCIAL", APART FROM THE MARK AS SHOWN.

FOR FINANCIAL SERVICES, NAMELY, MORTGAGE BANKING SERVICES (U.S. CLS. 100, 101 AND 102).

FIRST USE 5-8-2005; IN COMMERCE 5-8-2005.

3,177,891. FINANCIAL SOLUTIONS PARTNERS, LLC, NEW YORK, NY. SN 78-446,180. PUB. 5-2-2006, FILED 7-6-2004.



NO CLAIM IS MADE TO THE EXCLUSIVE RIGHT TO USE "FINANCIAL SOLUTIONS PARTNERS", APART FROM THE MARK AS SHOWN.

FOR FINANCIAL SERVICES, NAMELY LIFE INSURANCE UNDERWRITING AND CONSULTATION RELATED THERETO (U.S. CLS. 100, 101 AND 102).

FIRST USE 9-24-2004; IN COMMERCE 9-24-2004.

CLASS 36—(Continued).

3,177,924. WELLS FARGO & COMPANY, MINNEAPOLIS, MN. SN 78-459,789. PUB. 6-28-2005, FILED 7-30-2004.

CLASS 36—(Continued).

3,178,035. AMERICAN INTERNATIONAL GROUP, INC., NEW YORK, NY. SN 78-499,811. PUB. 12-27-2005, FILED 10-14-2004.

ESSENTIALS OF EXCELLENCE

THE MARK CONSISTS OF STANDARD CHARACTERS WITHOUT CLAIM TO ANY PARTICULAR FONT, STYLE, SIZE, OR COLOR.

FOR FINANCIAL RESEARCH AND ANALYSIS SERVICES PROVIDED TO FINANCIAL ADVISORS, NAMELY, PROVIDING FINANCIAL ADVISORS WITH ANALYSIS OF FINANCIAL ADVISOR PRACTICES IN THE FIELDS OF ASSETS UNDER MANAGEMENT, COMMISSIONS, FINANCIAL PLANNING FEES, AND PROFITABILITY (U.S. CLS. 100, 101 AND 102).

FIRST USE 11-30-2002; IN COMMERCE 11-30-2002.

REPUTATIONGUARD

THE MARK CONSISTS OF STANDARD CHARACTERS WITHOUT CLAIM TO ANY PARTICULAR FONT, STYLE, SIZE, OR COLOR.

FOR INSURANCE UNDERWRITING SERVICES IN THE FIELD OF BUSINESS CRISIS INSURANCE (U.S. CLS. 100, 101 AND 102).

FIRST USE 3-1-2005; IN COMMERCE 3-1-2005.

3,178,000. ABSOLUTE INVESTMENT ADVISERS LLC, HINGHAM, MA. SN 78-481,733. PUB. 12-27-2005, FILED 9-10-2004.

3,178,048. SIRMANS, JAMES R. JR., GAINESVILLE, FL. SN 78-507,411. PUB. 11-29-2005, FILED 10-28-2004.

Absolute Strategies Fund

THE MARK CONSISTS OF STANDARD CHARACTERS WITHOUT CLAIM TO ANY PARTICULAR FONT, STYLE, SIZE, OR COLOR.

NO CLAIM IS MADE TO THE EXCLUSIVE RIGHT TO USE "STRATEGIES FUND", APART FROM THE MARK AS SHOWN.

FOR FINANCIAL ADVISORY SERVICES (U.S. CLS. 100, 101 AND 102).

FIRST USE 1-4-2005; IN COMMERCE 1-28-2005.

FITNSURANCE

THE MARK CONSISTS OF STANDARD CHARACTERS WITHOUT CLAIM TO ANY PARTICULAR FONT, STYLE, SIZE, OR COLOR.

FOR INSURANCE ACTUARIAL SERVICES IN THE NATURE OF PROGRAMS IN PROMOTING HEALTH MAINTENANCE BY INDIVIDUAL PARTICIPANTS, NAMELY MONITORING HEALTH-RELATED ACTIVITIES OF INDIVIDUAL PARTICIPANTS AND ASSESSING INSURANCE PREMIUMS, AND ANY ASSOCIATED DISCOUNTS OR INCENTIVES, BASED ON INDIVIDUAL INSURED EFFORTS IN MAINTAINING THEIR HEALTH (U.S. CLS. 100, 101 AND 102).

FIRST USE 10-1-2005; IN COMMERCE 10-1-2005.

CLASS 36—(Continued).

3,178,052. IDEAL VALUE, LLC, CHARLOTTE, NC. SN 78-508,538. PUB. 11-29-2005, FILED 10-29-2004.

IDEAL VALUE

THE MARK CONSISTS OF STANDARD CHARACTERS WITHOUT CLAIM TO ANY PARTICULAR FONT, STYLE, SIZE, OR COLOR.
FOR REAL ESTATE BROKERAGE (U.S. CLS. 100, 101 AND 102).
FIRST USE 4-28-2005; IN COMMERCE 4-28-2005.

3,178,073. EDUCATIONAL CREDIT MANAGEMENT CORPORATION, ST. PAUL, MN. SN 78-519,058. PUB. 2-21-2006, FILED 11-18-2004.

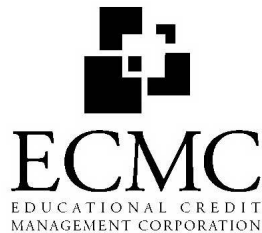

OWNER OF U.S. REG. NO. 2,540,611.
NO CLAIM IS MADE TO THE EXCLUSIVE RIGHT TO USE "CREDIT MANAGEMENT CORPORATION", APART FROM THE MARK AS SHOWN.
THE MARK CONSISTS OF SIX OVERLAPPING SQUARES ABOVE THE WORDING ECMC EDUCATIONAL CREDIT MANAGEMENT CORPORATION.
SEC. 2(F) AS TO "EDUCATIONAL CREDIT MANAGEMENT CORPORATION".
FOR EDUCATIONAL LOAN SERVICES (U.S. CLS. 100, 101 AND 102).
FIRST USE 3-11-2005; IN COMMERCE 3-11-2005.

CLASS 36—(Continued).

3,178,074. UNITED SAN ANTONIO COMMUNITY FEDERAL CREDIT UNION, SAN ANTONIO, TX. SN 78-519,670. PUB. 5-2-2006, FILED 11-18-2004.

**UNITED SAN ANTONIO
COMMUNITY FEDERAL
CREDIT UNION**

THE MARK CONSISTS OF STANDARD CHARACTERS WITHOUT CLAIM TO ANY PARTICULAR FONT, STYLE, SIZE, OR COLOR.
NO CLAIM IS MADE TO THE EXCLUSIVE RIGHT TO USE "SAN ANTONIO COMMUNITY FEDERAL CREDIT UNION", APART FROM THE MARK AS SHOWN.
FOR CREDIT UNION SERVICES AND CONSUMER AND COMMERCIAL LENDING SERVICES (U.S. CLS. 100, 101 AND 102).
FIRST USE 2-15-2006; IN COMMERCE 2-15-2006.

3,178,075. UNITED SAN ANTONIO COMMUNITY FEDERAL CREDIT UNION, SAN ANTONIO, TX. SN 78-519,679. PUB. 4-11-2006, FILED 11-18-2004.

UNITED SAN ANTONIO

THE MARK CONSISTS OF STANDARD CHARACTERS WITHOUT CLAIM TO ANY PARTICULAR FONT, STYLE, SIZE, OR COLOR.
NO CLAIM IS MADE TO THE EXCLUSIVE RIGHT TO USE "SAN ANTONIO", APART FROM THE MARK AS SHOWN.
FOR CREDIT UNION SERVICES AND CONSUMER AND COMMERCIAL LENDING SERVICES (U.S. CLS. 100, 101 AND 102).
FIRST USE 2-15-2006; IN COMMERCE 2-15-2006.

3,178,125. E*TRADE FINANCIAL CORPORATION, NEW YORK, NY. SN 78-542,808. PUB. 1-3-2006, FILED 1-5-2005.

BE E*TRAORDINARY.

THE MARK CONSISTS OF STANDARD CHARACTERS WITHOUT CLAIM TO ANY PARTICULAR FONT, STYLE,

CLASS 36—(Continued).

SIZE, OR COLOR.

OWNER OF U.S. REG. NOS. 2,220,629, 2,479,300, AND OTHERS.

FOR FINANCIAL SERVICES, NAMELY, BROKERAGE SERVICES IN THE FIELD OF STOCKS, BONDS, OPTIONS AND MUTUAL FUNDS; BANKING SERVICES (U.S. CLS. 100, 101 AND 102).

FIRST USE 3-29-2004; IN COMMERCE 3-29-2004.

3,178,127. SUNTRUST BANKS, INC., ORLANDO, FL. SN 78-544,556. PUB. 10-11-2005, FILED 1-10-2005.

HOME VALUE POWER

THE MARK CONSISTS OF STANDARD CHARACTERS WITHOUT CLAIM TO ANY PARTICULAR FONT, STYLE, SIZE, OR COLOR.

NO CLAIM IS MADE TO THE EXCLUSIVE RIGHT TO USE "HOME VALUE", APART FROM THE MARK AS SHOWN.

FOR PROVIDING HOME VALUE INFORMATION, NAMELY, PREDICTING HOME VALUES BASED ON MODELING TECHNOLOGIES COMPOSED OF COMPARABLE PROPERTY VALUES AND TAX ASSESSMENTS AND A HOME APPRECIATION INDEX (U.S. CLS. 100, 101 AND 102).

FIRST USE 5-25-2005; IN COMMERCE 5-25-2005.

3,178,130. THE BANCORP BANK, WILMINGTON, DE. SN 78-546,610. PUB. 12-6-2005, FILED 1-12-2005.

TOTALCASH MANAGER

THE MARK CONSISTS OF STANDARD CHARACTERS WITHOUT CLAIM TO ANY PARTICULAR FONT, STYLE, SIZE, OR COLOR.

NO CLAIM IS MADE TO THE EXCLUSIVE RIGHT TO USE "MANAGER", APART FROM THE MARK AS SHOWN.

FOR ONLINE BANKING SERVICES, NAMELY, MANAGEMENT OF CASH BALANCE REPORTING, STOP PAYMENTS ON CHECKS, ACCOUNT RECONCILIATION, SAVINGS AND CHECKING ACCOUNT SERVICES; FUND TRANSFER SERVICES, NAMELY, ACCOUNT TRANSFERS, WIRE TRANSFERS AND ELECTRONIC OR AUTOMATED CLEARING HOUSE TRANSFERS (U.S. CLS. 100, 101 AND 102).

FIRST USE 1-7-2005; IN COMMERCE 3-2-2005.

CLASS 36—(Continued).

3,178,159. THE MCGRAW-HILL COMPANIES, INC., NEW YORK, NY. SN 78-557,192. PUB. 4-18-2006, FILED 1-31-2005.

**STANDARD & POOR'S
SIGNATURE MAP**

THE MARK CONSISTS OF STANDARD CHARACTERS WITHOUT CLAIM TO ANY PARTICULAR FONT, STYLE, SIZE, OR COLOR.

OWNER OF U.S. REG. NOS. 527,414, 765,131, AND OTHERS.

NO CLAIM IS MADE TO THE EXCLUSIVE RIGHT TO USE "MAP", APART FROM THE MARK AS SHOWN.

FOR INVESTMENT CONSULTATION AND ADVICE; FINANCIAL ASSET ALLOCATION SERVICES (U.S. CLS. 100, 101 AND 102).

FIRST USE 2-0-2006; IN COMMERCE 2-0-2006.

3,178,181. CALKAIN REALTY ADVISORS, INC., RESTON, VA. SN 78-565,643. PUB. 3-28-2006, FILED 2-11-2005.

CALKAIN

THE MARK CONSISTS OF STANDARD CHARACTERS WITHOUT CLAIM TO ANY PARTICULAR FONT, STYLE, SIZE, OR COLOR.

FOR REAL ESTATE SERVICES, NAMELY, REAL ESTATE BROKERAGE, REAL ESTATE MANAGEMENT AND REAL ESTATE CONSULTATION SERVICES (U.S. CLS. 100, 101 AND 102).

FIRST USE 1-0-2005; IN COMMERCE 1-0-2005.

3,178,195. DOBSON CELLULAR SYSTEMS, INC., OKLAHOMA CITY, OK. SN 78-568,426. PUB. 11-15-2005, FILED 2-16-2005.

POWER OF A NEW TOWER

CLASS 36—(Continued).

THE MARK CONSISTS OF STANDARD CHARACTERS WITHOUT CLAIM TO ANY PARTICULAR FONT, STYLE, SIZE, OR COLOR.

FOR PHILANTHROPIC SERVICES IN THE FIELD OF MONETARY DONATIONS (U.S. CLS. 100, 101 AND 102).
FIRST USE 3-11-2005; IN COMMERCE 3-11-2005.

3,178,199. UNITRIN, INC., CHICAGO, IL. SN 78-569,250. PUB. 12-6-2005, FILED 2-17-2005.

UNITRIN BUSINESS INSURANCE

THE MARK CONSISTS OF STANDARD CHARACTERS WITHOUT CLAIM TO ANY PARTICULAR FONT, STYLE, SIZE, OR COLOR.

OWNER OF U.S. REG. NOS. 1,857,369 AND 2,526,077.

NO CLAIM IS MADE TO THE EXCLUSIVE RIGHT TO USE BUSINESS INSURANCE, APART FROM THE MARK AS SHOWN.

FOR INSURANCE UNDERWRITING SERVICES IN THE FIELD OF PROPERTY AND CASUALTY INSURANCE (U.S. CLS. 100, 101 AND 102).

FIRST USE 3-25-2005; IN COMMERCE 5-1-2005.

3,178,205. CHITTENDEN TRUST COMPANY, BURLINGTON, VT. SN 78-570,237. PUB. 11-15-2005, FILED 2-18-2005.



OWNER OF U.S. REG. NOS. 1,463,075, 2,038,338, AND OTHERS.

THE COLOR(S) BLUE AND GRAY IS/ARE CLAIMED AS A FEATURE OF THE MARK.

THE MARK CONSISTS OF THE WORD CHITTENDEN IN BLUE STYLIZED LETTERS, AND A GRAY DESIGN SUGGESTING A RECTANGULAR STRIP OF RIBBON OR PAPER WHICH HAS BEEN FOLDED AT A 45-DEGREE ANGLE, HAVING STRIPES ON ONE SIDE.

SEC. 2(F) AS TO "CHITTENDEN".

FOR FULL RANGE OF FINANCIAL SERVICES, NAMELY, BANKING SERVICES, ONLINE BANKING SERVICES, PERSONAL TRUST SERVICES, CORPORATE TRUST SERVICES, LENDING SERVICES, ISSUING CHECKS AND LETTERS OF CREDIT, CASH AND FOREIGN EXCHANGE TRANSACTIONS, CASH MANAGEMENT SERVICES, FINANCIAL PLANNING SERVICES, INVESTMENT MANAGEMENT SERVICES, INVESTMENT ADVISORY SERVICES, SECURITIES BROKERAGE SERVICES, CREDIT CARD PROCESSING, INSURANCE CONSULTATION, INSURANCE ADMINISTRATION, INSURANCE BROKERAGE, INSURANCE AGENCIES, PROVIDING INFORMATION IN INSURANCE MATTERS AND PROVIDING FINANCIAL INFORMATION BY ELECTRONIC MEANS (U.S. CLS. 100, 101 AND 102).

FIRST USE 3-0-2005; IN COMMERCE 3-0-2005.

CLASS 36—(Continued).

3,178,210. MORTGAGE RESOURCE CENTER, INC., EAGAN, MN. SN 78-571,511. PUB. 11-29-2005, FILED 2-21-2005.

MORTGAGEMENTOR

THE MARK CONSISTS OF STANDARD CHARACTERS WITHOUT CLAIM TO ANY PARTICULAR FONT, STYLE, SIZE, OR COLOR.

FOR PROVIDING FINANCIAL INFORMATION OF A TECHNICAL NATURE IN THE FIELD OF MORTGAGE LENDING VIA THE INTERNET FOR USE BY LENDERS; PROVIDING DOCUMENTS AND INSTRUCTIONS IN THE FIELD OF MORTGAGE LENDING VIA THE INTERNET FOR USE BY LENDERS; PROVIDING DOCUMENTS AND INSTRUCTIONS ABOUT LOAN PROGRAMS, LOAN APPLICATIONS, LENDING PRACTICES, AND UNDERWRITING POLICIES IN THE FIELD OF MORTGAGE LENDING VIA THE INTERNET FOR USE BY LENDERS (U.S. CLS. 100, 101 AND 102).

FIRST USE 3-14-2005; IN COMMERCE 3-14-2005.

3,178,225. AFRISEC, LLC, ASHBURN, VA. SN 78-574,749. PUB. 1-24-2006, FILED 2-24-2005.

AFRIsec, LLC

THE MARK CONSISTS OF STANDARD CHARACTERS WITHOUT CLAIM TO ANY PARTICULAR FONT, STYLE, SIZE, OR COLOR.

NO CLAIM IS MADE TO THE EXCLUSIVE RIGHT TO USE "LLC", APART FROM THE MARK AS SHOWN.

FOR CONSULTATION IN THE FIELD OF RISK MANAGEMENT FOR COMPANIES OPERATING IN AFRICA (U.S. CLS. 100, 101 AND 102).

FIRST USE 12-25-2005; IN COMMERCE 12-25-2005.

CLASS 36—(Continued).

3,178,273. SSM CORPORATION, MEMPHIS, TN. SN 78-585,541. PUB. 12-6-2005, FILED 3-11-2005.

CLASS 36—(Continued).

3,178,360. SUNTRUST BANKS, INC., ORLANDO, FL. SN 78-600,849. PUB. 5-23-2006, FILED 4-4-2005.

SSM PARTNERS

THE MARK CONSISTS OF STANDARD CHARACTERS WITHOUT CLAIM TO ANY PARTICULAR FONT, STYLE, SIZE, OR COLOR.

OWNER OF U.S. REG. NO. 2,835,974.

NO CLAIM IS MADE TO THE EXCLUSIVE RIGHT TO USE "PARTNERS", APART FROM THE MARK AS SHOWN.

FOR FINANCIAL MANAGEMENT SERVICES, NAMELY, VENTURE CAPITAL AND/OR PRIVATE EQUITY FUND MANAGEMENT SERVICES, CAPITAL INVESTMENT SERVICES, INVESTMENT MANAGEMENT, INVESTMENT ADVISORY SERVICES, INVESTMENT AND TRADING STRATEGY RESEARCH, FINANCIAL PRODUCT DEVELOPMENT; PROVIDING INVESTMENT INFORMATION AND INVESTMENT ADVICE (U.S. CLS. 100, 101 AND 102).

FIRST USE 4-22-2005; IN COMMERCE 4-22-2005.

AMC Fund Select

THE MARK CONSISTS OF STANDARD CHARACTERS WITHOUT CLAIM TO ANY PARTICULAR FONT, STYLE, SIZE, OR COLOR.

OWNER OF U.S. REG. NOS. 2,873,252, 2,873,254, AND OTHERS.

NO CLAIM IS MADE TO THE EXCLUSIVE RIGHT TO USE "FUND SELECT", APART FROM THE MARK AS SHOWN.

FOR FINANCIAL SERVICES, NAMELY, DISCRETIONARY MUTUAL FUND ASSET ALLOCATION (U.S. CLS. 100, 101 AND 102).

FIRST USE 5-0-2005; IN COMMERCE 5-0-2005.

3,178,309. FIRST AMERICAN COMMERCIAL BANCORP, INC., CHICAGO, IL. SN 78-592,027. PUB. 12-20-2005, FILED 3-22-2005.

3,178,362. MCLEARN, SHARON, ORLANDO, FL. SN 78-601,275. PUB. 1-3-2006, FILED 4-4-2005.

 **FIRST
AMERICAN**
EQUIPMENT FINANCE

MANOR QUEST

NO CLAIM IS MADE TO THE EXCLUSIVE RIGHT TO USE AMERICAN EQUIPMENT FINANCE, APART FROM THE MARK AS SHOWN.

FOR LEASE PURCHASE FINANCING OF OFFICE EQUIPMENT (U.S. CLS. 100, 101 AND 102).

FIRST USE 1-1-2005; IN COMMERCE 1-1-2005.

THE MARK CONSISTS OF STANDARD CHARACTERS WITHOUT CLAIM TO ANY PARTICULAR FONT, STYLE, SIZE, OR COLOR.

FOR REAL ESTATE BROKERAGE SERVICES (U.S. CLS. 100, 101 AND 102).

FIRST USE 6-1-2005; IN COMMERCE 6-1-2005.

CLASS 36—(Continued).

3,178,363. MCLEARN, SHARON, ORLANDO, FL. SN 78-601,310. PUB. 1-3-2006, FILED 4-4-2005.

WE MAKE YOUR HOME
HAPPEN

THE MARK CONSISTS OF STANDARD CHARACTERS WITHOUT CLAIM TO ANY PARTICULAR FONT, STYLE, SIZE, OR COLOR.

FOR REAL ESTATE BROKERAGE SERVICES (U.S. CLS. 100, 101 AND 102).

FIRST USE 6-1-2005; IN COMMERCE 6-1-2005.

3,178,370. COMMUNITY CENTRAL BANK, MOUNT CLEMENS, MI. SN 78-603,070. PUB. 12-27-2005, FILED 4-6-2005.

River Place Trust

THE MARK CONSISTS OF STANDARD CHARACTERS WITHOUT CLAIM TO ANY PARTICULAR FONT, STYLE, SIZE, OR COLOR.

NO CLAIM IS MADE TO THE EXCLUSIVE RIGHT TO USE "TRUST", APART FROM THE MARK AS SHOWN.

FOR BANKING SERVICES (U.S. CLS. 100, 101 AND 102).

FIRST USE 6-30-2005; IN COMMERCE 6-30-2005.

CLASS 36—(Continued).

3,178,397. FIRST COMMUNITY BANK OF EAST TENNESSEE, ROGERSVILLE, TN. SN 78-613,805. PUB. 4-25-2006, FILED 4-21-2005.



NO CLAIM IS MADE TO THE EXCLUSIVE RIGHT TO USE "FIRST COMMUNITY FINANCIAL SERVICES", APART FROM THE MARK AS SHOWN.

THE MARK CONSISTS OF STYLIZED WORDS "FIRST COMMUNITY FINANCIAL SERVICES" PLUS DESIGN. DESIGN IS SQUARE CONTAINING TWO CONCENTRIC CIRCLES THAT CONTAIN THREE STARS.

FOR INVESTMENT ADVICE AND BROKERAGE SERVICES FOR FINANCIAL INVESTMENTS FEATURING STOCKS, BONDS, MUTUAL FUNDS, MANAGED ACCOUNTS, REAL ESTATE INVESTMENT TRUST (REIT'S) AND INSURANCE ADVICE, BROKERAGE AND INITIAL UNDERWRITING IN THE FIELD OF LIFE, LONG TERM CARE AND DISABILITY INCOME (U.S. CLS. 100, 101 AND 102).

FIRST USE 8-1-2005; IN COMMERCE 8-1-2005.

3,178,403. BPG PROPERTIES, LTD., YARDLEY, PA. SN 78-617,142. PUB. 1-24-2006, FILED 4-26-2005.

ELLIS PRESERVE

THE MARK CONSISTS OF STANDARD CHARACTERS WITHOUT CLAIM TO ANY PARTICULAR FONT, STYLE, SIZE, OR COLOR.

FOR COMMERCIAL AND RESIDENTIAL REAL ESTATE INVESTMENT AND MANAGEMENT SERVICES (U.S. CLS. 100, 101 AND 102).

FIRST USE 4-20-2006; IN COMMERCE 4-20-2006.

CLASS 36—(Continued).

3,178,404. BPG PROPERTIES, LTD., YARDLEY, PA. SN 78-617,146. PUB. 1-17-2006, FILED 4-26-2005.

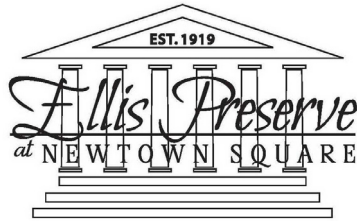

NO CLAIM IS MADE TO THE EXCLUSIVE RIGHT TO USE "EST. 1919" AND "AT NEWTOWN SQUARE", APART FROM THE MARK AS SHOWN.

FOR COMMERCIAL AND RESIDENTIAL REAL ESTATE INVESTMENT AND MANAGEMENT SERVICES (U.S. CLS. 100, 101 AND 102).

FIRST USE 4-20-2006; IN COMMERCE 4-20-2006.

CLASS 36—(Continued).

3,178,472. THE PNC FINANCIAL SERVICES GROUP, INC., PITTSBURGH, PA. SN 78-645,002. PUB. 3-28-2006, FILED 6-7-2005.

PNC MORTGAGE, LLC

THE MARK CONSISTS OF STANDARD CHARACTERS WITHOUT CLAIM TO ANY PARTICULAR FONT, STYLE, SIZE, OR COLOR.

OWNER OF U.S. REG. NOS. 1,416,898, 2,508,843, AND OTHERS.

NO CLAIM IS MADE TO THE EXCLUSIVE RIGHT TO USE "MORTGAGE, LLC", APART FROM THE MARK AS SHOWN.

FOR CONSUMER MORTGAGE BANKING (U.S. CLS. 100, 101 AND 102).

FIRST USE 9-12-2005; IN COMMERCE 9-12-2005.

3,178,480. PIONEER LICENSING SERVICES, INC., LAS VEGAS, NV. SN 78-648,798. PUB. 3-7-2006, FILED 6-11-2005.

THE RESPONSIBLE ALTERNATIVE

THE MARK CONSISTS OF STANDARD CHARACTERS WITHOUT CLAIM TO ANY PARTICULAR FONT, STYLE, SIZE, OR COLOR.

FOR PROVIDING CONSUMER LOAN SERVICES AND CONSUMER CREDIT COUNSELING SERVICES (U.S. CLS. 100, 101 AND 102).

FIRST USE 6-9-2005; IN COMMERCE 6-9-2005.

3,178,444. RETIREMENT CAPITAL ADVISORS, INC., CINCINNATI, OH. SN 78-632,178. PUB. 2-7-2006, FILED 5-18-2005.

3,178,481. PIONEER LICENSING SERVICES, INC., LAS VEGAS, NV. SN 78-648,799. PUB. 3-7-2006, FILED 6-11-2005.

THE RESPONSIBLE LENDING ALTERNATIVE

THE MARK CONSISTS OF STANDARD CHARACTERS WITHOUT CLAIM TO ANY PARTICULAR FONT, STYLE, SIZE, OR COLOR.

NO CLAIM IS MADE TO THE EXCLUSIVE RIGHT TO USE "LENDING", APART FROM THE MARK AS SHOWN.

FOR PROVIDING CONSUMER LOAN SERVICES AND CONSUMER CREDIT COUNSELING SERVICES (U.S. CLS. 100, 101 AND 102).

FIRST USE 6-9-2005; IN COMMERCE 6-9-2005.

NO CLAIM IS MADE TO THE EXCLUSIVE RIGHT TO USE ACCOUNT, APART FROM THE MARK AS SHOWN.

FOR INVESTMENT SERVICES, NAMELY, INVESTMENT ADVICE, MANAGEMENT, AND CONSULTATION; FINANCIAL SERVICES, NAMELY, FINANCIAL PLANNING, MANAGEMENT AND PORTFOLIO MANAGEMENT (U.S. CLS. 100, 101 AND 102).

FIRST USE 10-31-2005; IN COMMERCE 10-31-2005.

CLASS 36—(Continued).

3,178,482. PIONEER LICENSING SERVICES, INC., LAS VEGAS, NV. SN 78-648,800. PUB. 3-7-2006, FILED 6-11-2005.

BREAK THE DEBT CYCLE

THE MARK CONSISTS OF STANDARD CHARACTERS WITHOUT CLAIM TO ANY PARTICULAR FONT, STYLE, SIZE, OR COLOR.

NO CLAIM IS MADE TO THE EXCLUSIVE RIGHT TO USE "DEBT CYCLE", APART FROM THE MARK AS SHOWN.

FOR PROVIDING CONSUMER LOANS SERVICES AND CONSUMER CREDIT COUNSELING SERVICES (U.S. CLS. 100, 101 AND 102).

FIRST USE 6-9-2005; IN COMMERCE 6-9-2006.

CLASS 36—(Continued).

3,178,509. MAC BAREN FINANCIAL, LLC, ST. PETERSBURG, FL. SN 78-659,318. PUB. 4-4-2006, FILED 6-27-2005.

MAC BAREN

THE MARK CONSISTS OF STANDARD CHARACTERS WITHOUT CLAIM TO ANY PARTICULAR FONT, STYLE, SIZE, OR COLOR.

THE NAME(S), PORTRAIT(S), AND/OR SIGNATURE(S) SHOWN IN THE MARK DOES NOT IDENTIFY A PARTICULAR LIVING INDIVIDUAL.

FOR FINANCIAL SERVICES IN THE FIELD OF AUTOMOTIVE INDUSTRY FEATURING DEVELOPMENT OF RETAIL CUSTOMER ALTERNATIVE PAYMENT PROGRAMS (U.S. CLS. 100, 101 AND 102).

FIRST USE 10-0-2005; IN COMMERCE 10-0-2005.

3,178,544. UPSTAR FINANCIAL, LLC., NORCROSS, GA. SN 78-672,755. PUB. 4-11-2006, FILED 7-18-2005.

UPSTAR

THE MARK CONSISTS OF STANDARD CHARACTERS WITHOUT CLAIM TO ANY PARTICULAR FONT, STYLE, SIZE, OR COLOR.

FOR LOAN BROKERAGE SERVICES (U.S. CLS. 100, 101 AND 102).

FIRST USE 7-31-2006; IN COMMERCE 7-31-2006.

3,178,489. MICROSOFT CORPORATION, REDMOND, WA. SN 78-651,500. PUB. 2-28-2006, FILED 6-15-2005.

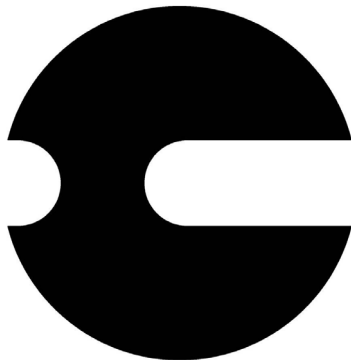

THE MARK CONSISTS OF A CIRCLE WITH TWO HORIZONTAL NOTCHES.

FOR DIGITAL PRE-PAID PURCHASE SERVICES, NAMELY, PROCESSING ONLINE PAYMENTS (U.S. CLS. 100, 101 AND 102).

FIRST USE 11-22-2005; IN COMMERCE 11-22-2005.

3,178,563. TRIGRAM CAPITAL MANAGEMENT LP, GREENWICH, CT. SN 78-680,803. PUB. 4-18-2006, FILED 7-28-2005.

TRIGRAM CAPITAL MANAGEMENT

THE MARK CONSISTS OF STANDARD CHARACTERS WITHOUT CLAIM TO ANY PARTICULAR FONT, STYLE, SIZE, OR COLOR.

NO CLAIM IS MADE TO THE EXCLUSIVE RIGHT TO USE "CAPITAL MANAGEMENT", APART FROM THE MARK AS SHOWN.

FOR FINANCIAL SERVICES, NAMELY, INVESTMENT ADVISORY SERVICES, INVESTMENT MANAGEMENT SERVICES, AND ASSET MANAGEMENT SERVICES (U.S. CLS. 100, 101 AND 102).

FIRST USE 7-25-2005; IN COMMERCE 7-17-2006.

CLASS 36—(Continued).

3,178,580. VINTAGE WINE TRUST INC., SAN RAFAEL, CA. SN 78-691,070. PUB. 5-2-2006, FILED 8-11-2005.

VWT

THE MARK CONSISTS OF STANDARD CHARACTERS WITHOUT CLAIM TO ANY PARTICULAR FONT, STYLE, SIZE, OR COLOR.

FOR FINANCIAL SERVICES, NAMELY, REAL ESTATE INVESTMENT TRUST SERVICES (U.S. CLS. 100, 101 AND 102).

FIRST USE 6-0-2004; IN COMMERCE 3-23-2005.

3,178,583. FUNDING EXCHANGE LLC, THE, CHICAGO, IL. SN 78-696,794. PUB. 5-16-2006, FILED 8-19-2005.



NO CLAIM IS MADE TO THE EXCLUSIVE RIGHT TO USE "FUNDING" AND "YOUR ONLINE MARKET FOR LITIGATION FUNDING", APART FROM THE MARK AS SHOWN.

THE COLOR(S) THE APPLICANT CLAIMS COLOR AS A FEATURE OF THE MARK, NAMELY, BLUE, DARK BLUE, GREEN, DARK GREEN, BLACK. IS/ARE CLAIMED AS A FEATURE OF THE MARK.

THE MARK CONSISTS OF TWO ARROWS PUSHING PAST ONE ANOTHER IN A CIRCULAR MOTION. THE BOTTOM ARROW PUSHES UPWARD WITH THE BOTTOM UNDERSIDE OF THE ARROW APPEARING IN DARK GREEN AND THE TOP OF THE ARROW APPEARING IN GREEN. THE TOP ARROW PUSHES DOWNWARD WITH THE BOTTOM UNDERSIDE OF THE ARROW APPEARING IN DARK BLUE AND THE TOP OF THE ARROW APPEARING IN BLUE. THE WORDING "THE FUNDING EXCHANGE" APPEARS BELOW THE CIRCULAR ARROW DESIGN IN BLACK. A GREEN LINE SEPARATES THE WORDING "THE FUNDING EXCHANGE" FROM THE WORDING "YOUR ONLINE MARKET FOR LITIGATION FUNDING" WHICH APPEARS UNDER THE GREEN LINE IN BLACK.

FOR ELECTRONIC COMMERCE PAYMENT SERVICES, NAMELY, ESTABLISHING FUNDED ACCOUNTS USED TO PURCHASE GOODS AND SERVICES ON THE INTERNET (U.S. CLS. 100, 101 AND 102).

FIRST USE 8-1-2005; IN COMMERCE 8-1-2005.

CLASS 36—(Continued).

3,178,586. CHARLESTON'S LANDSHARKS INC., ISLE OF PALMS, SC. SN 78-697,914. PUB. 5-16-2006, FILED 8-22-2005.



FOR REAL ESTATE INVESTMENT (U.S. CLS. 100, 101 AND 102).

FIRST USE 4-0-2005; IN COMMERCE 4-0-2005.

3,178,587. BARCLAYS BANK PLC, LONDON, UNITED KINGDOM. SN 78-698,671. PUB. 5-9-2006, FILED 8-23-2005.

iPath

THE MARK CONSISTS OF STANDARD CHARACTERS WITHOUT CLAIM TO ANY PARTICULAR FONT, STYLE, SIZE, OR COLOR.

FOR FINANCIAL SERVICES IN THE NATURE OF AN INVESTMENT SECURITY (U.S. CLS. 100, 101 AND 102).

FIRST USE 9-7-2005; IN COMMERCE 6-7-2006.

3,178,589. FMR CORP., BOSTON, MA. SN 78-699,111. PUB. 6-20-2006, FILED 8-24-2005.

MUSIC LIVES

THE MARK CONSISTS OF STANDARD CHARACTERS WITHOUT CLAIM TO ANY PARTICULAR FONT, STYLE, SIZE, OR COLOR.

NO CLAIM IS MADE TO THE EXCLUSIVE RIGHT TO USE "MUSIC", APART FROM THE MARK AS SHOWN.

FOR CHARITABLE FUND RAISING (U.S. CLS. 100, 101 AND 102).

FIRST USE 9-16-2005; IN COMMERCE 9-16-2005.

CLASS 36—(Continued).

3,178,591. CAPSTONE ADVISORS LLC, SCOTTSDALE, AZ. SN 78-701,292. PUB. 5-30-2006, FILED 8-26-2005.

LAUCHEQUITY PARTNERS

THE MARK CONSISTS OF STANDARD CHARACTERS WITHOUT CLAIM TO ANY PARTICULAR FONT, STYLE, SIZE, OR COLOR.

NO CLAIM IS MADE TO THE EXCLUSIVE RIGHT TO USE "PARTNERS", APART FROM THE MARK AS SHOWN. FOR FINANCIAL AND EQUITY INVESTMENT AND MANAGEMENT SERVICES AND FINANCIAL CONSULTING SERVICES (U.S. CLS. 100, 101 AND 102). FIRST USE 1-18-2005; IN COMMERCE 1-18-2005.

3,178,618. CDRE TM CORP., MISSION VIEJO, CA. SN 78-713,347. PUB. 5-30-2006, FILED 9-15-2005.

LIVE WHO YOU ARE

THE MARK CONSISTS OF STANDARD CHARACTERS WITHOUT CLAIM TO ANY PARTICULAR FONT, STYLE, SIZE, OR COLOR.

FOR REAL ESTATE BROKERAGE (U.S. CLS. 100, 101 AND 102). FIRST USE 2-3-2006; IN COMMERCE 2-3-2006.

3,178,640. BARCLAYS BANK PLC, LONDON, UNITED KINGDOM. SN 78-728,344. PUB. 5-9-2006, FILED 10-6-2005.



THE COLOR(S) BLUE IS/ARE CLAIMED AS A FEATURE OF THE MARK.

THE MARK CONSISTS OF A BLUE ARROW DEVICE POINTING TOWARD THE DESIGNATION IPATH. FOR FINANCIAL SERVICES IN THE NATURE OF AN INVESTMENT SECURITY (U.S. CLS. 100, 101 AND 102). FIRST USE 9-7-2005; IN COMMERCE 6-7-2006.

CLASS 36—(Continued).

3,178,641. BARCLAYS BANK PLC, LONDON, UNITED KINGDOM. SN 78-728,360. PUB. 5-9-2006, FILED 10-6-2005.



THE MARK CONSISTS OF AN ARROW DEVICE POINTING TOWARD THE DESIGNATION IPATH.

FOR FINANCIAL SERVICES IN THE NATURE OF AN INVESTMENT SECURITY (U.S. CLS. 100, 101 AND 102). FIRST USE 9-7-2005; IN COMMERCE 6-7-2006.

CLASS 37—CONSTRUCTION AND REPAIR

3,177,444. ALLIANCE STORE, LTD., THE, JOSHUA TREE, CA. SN 76-590,575. PUB. 9-27-2005, FILED 5-5-2004.

SMART ENVIRONMENTS ... UNDER THE SUN

THE MARK CONSISTS OF STANDARD CHARACTERS WITHOUT CLAIM TO ANY PARTICULAR FONT, STYLE, SIZE, OR COLOR.

FOR INSTALLATION OF RESIDENTIAL AND COMMERCIAL ENERGY REDUCING SYSTEMS, NAMELY, INTERIOR AND EXTERIOR INSULATION, ROOFING PRODUCTS THAT REDUCE ENERGY USAGE, SOLAR POWERED SKYLIGHTS, SOLAR POWERED AIR CIRCULATING FANS, AND SOLAR POWERED VAPOR COOLERS (U.S. CLS. 100, 103 AND 106). FIRST USE 1-1-2005; IN COMMERCE 1-1-2006.

3,177,809. BERGER, SCOTT A., DENVER, CO. SN 78-402,087. PUB. 10-11-2005, FILED 4-15-2004.

PARK PLACE

THE MARK CONSISTS OF STANDARD CHARACTERS WITHOUT CLAIM TO ANY PARTICULAR FONT, STYLE, SIZE, OR COLOR.

FOR CONSTRUCTION AND RENOVATION OF BUILDINGS; INSTALLATION OF FLOORING; INSTALLATION OF CABINETS, SHELVES, HOOKS AND BASKETS FOR STORAGE (U.S. CLS. 100, 103 AND 106). FIRST USE 5-30-2004; IN COMMERCE 9-30-2004.

CLASS 37—(Continued).

3,177,968. LOUGHLIN, BRIAN P., EAST NORTHPORT, NY.
SN 78-471,703. PUB. 4-11-2006, FILED 8-23-2004.



NO CLAIM IS MADE TO THE EXCLUSIVE RIGHT TO USE "CLEANING SERVICE", APART FROM THE MARK AS SHOWN.

THE MARK CONSISTS OF A FEMALE IN A MAID OUTFIT EXTENDING A LEG WHILE SITTING IN A CIRCLE OUTLINED WITH THE WORDS LITTLE LACEY CLEANING SERVICE.

FOR CLEANING OF RESIDENTIAL HOUSES (U.S. CLS. 100, 103 AND 106).

FIRST USE 1-1-2004; IN COMMERCE 1-1-2004.

CLASS 37—(Continued).

3,177,988. REED, THOMAS, AURORA, CO. SN 78-478,028.
PUB. 12-20-2005, FILED 9-2-2004.



NO CLAIM IS MADE TO THE EXCLUSIVE RIGHT TO USE "WASTE AND INC", APART FROM THE MARK AS SHOWN.

THE COLOR(S) YELLOW AND BLACK IS/ARE CLAIMED AS A FEATURE OF THE MARK.

THE MARK CONSISTS OF FOUR DIAGONAL BARS REPRESENTING THE LETTER A (WITHOUT CROSSBAR) SUPERIMPOSED UPON THE LETTER W, FOLLOWED BY THE WORDS WASTE ADVANTAGE INC. THE COLOR YELLOW APPEARS IN THE UPPER BARS OF THE LETTER "W" AND IN THE WORD "WASTE" WHILE THE COLOR BLACK APPEARS IN THE TRIANGULAR PORTION OF THE "WA" (SUPERIMPOSED) AND IN THE WORDING "ADVANTAGE INC".

FOR COMPACTION, COLLECTION, REMOVAL AND DISPOSAL OF NON-HAZARDOUS WASTES OF RESIDENTIAL, MUNICIPAL, COMMERCIAL AND INDUSTRIAL CLIENTS (U.S. CLS. 100, 103 AND 106).

FIRST USE 3-9-2006; IN COMMERCE 3-9-2006.

3,177,977. MINTIE CORPORATION, LOS ANGELES, CA. SN 78-475,204. PUB. 10-18-2005, FILED 8-27-2004.



THE MARK CONSISTS OF THE WORD "MINTIE" AND THREE VERTICAL LINES ABOVE THE WORD FORMING THE STYLIZED LETTER "M".

FOR SERVICES OF SPECIALIZED CLEANING, MAINTENANCE AND REHABILITATION OF MACHINES, ENCLOSURES, HEATING, VENTILATING AND AIR CONDITIONING EQUIPMENT AND LIGHTING EQUIPMENT (U.S. CLS. 100, 103 AND 106).

FIRST USE 10-30-2004; IN COMMERCE 10-30-2004.

3,178,101. TERMINIX INTERNATIONAL COMPANY LP, MEMPHIS, TN. SN 78-532,428. PUB. 10-25-2005, FILED 12-14-2004.



NO CLAIM IS MADE TO THE EXCLUSIVE RIGHT TO USE "INSULATION", APART FROM THE MARK AS SHOWN.

FOR INSTALLATION OF BUILDING INSULATION (U.S. CLS. 100, 103 AND 106).

FIRST USE 1-1-2000; IN COMMERCE 1-1-2000.

CLASS 37—(Continued).

3,178,303. ECOVAC SERVICES, WOODSTOCK, GA. SN 78-591,298. PUB. 1-3-2006, FILED 3-21-2005.

SURFAC

THE MARK CONSISTS OF STANDARD CHARACTERS WITHOUT CLAIM TO ANY PARTICULAR FONT, STYLE, SIZE, OR COLOR.

FOR VACUUMING SERVICES FOR REMOVING VAPOR, ABSORBED, DISSOLVED, AND FREE PHASE VOLATILE ORGANIC COMPOUNDS FROM THE EARTH'S SUBSURFACE (U.S. CLS. 100, 103 AND 106).

FIRST USE 3-15-2005; IN COMMERCE 3-21-2005.

3,178,418. WHALEY FOODSERVICE REPAIRS, LEXINGTON, SC. SN 78-622,466. PUB. 3-14-2006, FILED 5-4-2005.

No one works harder to
keep you working.

THE MARK CONSISTS OF STANDARD CHARACTERS WITHOUT CLAIM TO ANY PARTICULAR FONT, STYLE, SIZE, OR COLOR.

OWNER OF U.S. REG. NO. 2,303,570.

FOR REPAIR AND MAINTENANCE OF COMMERCIAL FOODSERVICE EQUIPMENT (U.S. CLS. 100, 103 AND 106).

FIRST USE 4-1-2005; IN COMMERCE 6-1-2005.

CLASS 37—(Continued).

3,178,464. DAVID N. BROWN, INC., DBA FOX PLUMBING AND HEATING, SEATTLE, WA. SN 78-640,663. PUB. 2-28-2006, FILED 5-31-2005.

HELPING DESPERATE HOUSEWIVES SINCE 1964

THE MARK CONSISTS OF STANDARD CHARACTERS WITHOUT CLAIM TO ANY PARTICULAR FONT, STYLE, SIZE, OR COLOR.

FOR PLUMBING SERVICES (U.S. CLS. 100, 103 AND 106).

FIRST USE 7-0-2005; IN COMMERCE 7-0-2005.

3,178,486. ALTA ENTERPRISES, INC., MEAD, WA. SN 78-650,312. PUB. 5-9-2006, FILED 6-14-2005.

THE DETAIL DIFFERENCE

THE MARK CONSISTS OF STANDARD CHARACTERS WITHOUT CLAIM TO ANY PARTICULAR FONT, STYLE, SIZE, OR COLOR.

FOR MINOR COSMETIC RESTORATION OF INTERIOR AND EXTERIOR SURFACES OF CARPET, CAST POLYMERS, CHROME, CONCRETE, CERAMICS, FABRIC, FIBERGLASS, FOAM, GLASS, LAMINATES, LEATHER, METAL, MORTAR, PAINT, PAPER, PLASTIC, PLASTER, PORCELAIN, RESIN COMPOSITES, RUBBER, PLASTER WALL BOARD, STONE, VINYL AND WOOD DAMAGED BY AN ABRASION, BURN, CHIP, CRACK, DISCOLORATION, GOUGE, PUNCTURE OR TEAR (U.S. CLS. 100, 103 AND 106).

FIRST USE 6-1-2006; IN COMMERCE 6-1-2006.

3,178,498. OPTION1 RESTORATION, INC., POMPANO BEACH, FL. SN 78-656,927. PUB. 3-21-2006, FILED 6-23-2005.

OPTION1 RESTORATION

THE MARK CONSISTS OF STANDARD CHARACTERS WITHOUT CLAIM TO ANY PARTICULAR FONT, STYLE, SIZE, OR COLOR.

NO CLAIM IS MADE TO THE EXCLUSIVE RIGHT TO USE "RESTORATION", APART FROM THE MARK AS SHOWN.

FOR REPAIR, RESTORATION AND RECONSTRUCTION SERVICES TO BUILDINGS AND OTHER STRUCTURES AND ATTACHED REAL PROPERTY NECESSITATED BY FIRE, SMOKE, WATER, VANDALISM, WIND, HAIL OR OTHER DAMAGE OR CATASTROPHE (U.S. CLS. 100, 103 AND 106).

FIRST USE 6-20-2005; IN COMMERCE 6-20-2005.

CLASS 37—(Continued).

3,178,560. MAIDCOR LLC, GREEN BAY, WI. SN 78-678,360.
PUB. 4-18-2006, FILED 7-26-2005.

MAIDCOR

THE MARK CONSISTS OF STANDARD CHARACTERS WITHOUT CLAIM TO ANY PARTICULAR FONT, STYLE, SIZE, OR COLOR.

FOR RESIDENTIAL AND COMMERCIAL CLEANING SERVICE (U.S. CLS. 100, 103 AND 106).

FIRST USE 12-31-2005; IN COMMERCE 12-31-2005.

3,178,572. BAUMEISTER AUDIO VIDEO INTERIORS, INCORPORATED, DBA BAUMEISTER ELECTRONIC ARCHITECTS, NILES, IL. SN 78-685,810. PUB. 5-16-2006, FILED 8-4-2005.

DIVINE INTEGRATION

THE MARK CONSISTS OF STANDARD CHARACTERS WITHOUT CLAIM TO ANY PARTICULAR FONT, STYLE, SIZE, OR COLOR.

NO CLAIM IS MADE TO THE EXCLUSIVE RIGHT TO USE "INTEGRATION", APART FROM THE MARK AS SHOWN.

FOR INSTALLATION AND INTEGRATION OF WIRING AND ASSOCIATED ELECTRONIC COMPONENTS FOR THEATER, ENTERTAINMENT, AND AUTOMATION SYSTEMS FOR RESIDENTIAL AND COMMERCIAL USE (U.S. CLS. 100, 103 AND 106).

FIRST USE 9-15-2005; IN COMMERCE 9-0-2005.

CLASS 38—COMMUNICATION

3,177,337. MICROSTRATEGY INCORPORATED, MCLEAN, VA. SN 76-227,261. PUB. 6-14-2005, FILED 3-19-2001.

ANGEL

FOR PROVIDING MULTIPLE USE ACCESS TO GLOBAL COMPUTER INFORMATION NETWORKS FOR THE TRANSFER AND DISSEMINATION OF A WIDE RANGE OF INFORMATION (U.S. CLS. 100, 101 AND 104).

FIRST USE 3-0-2000; IN COMMERCE 1-0-2002.

CLASS 38—(Continued).

3,177,449. SES AMERICOM, INC., PRINCETON, NJ. SN 76-597,686. PUB. 5-31-2005, FILED 6-16-2004.

IP PRIME

THE MARK CONSISTS OF STANDARD CHARACTERS WITHOUT CLAIM TO ANY PARTICULAR FONT, STYLE, SIZE, OR COLOR.

NO CLAIM IS MADE TO THE EXCLUSIVE RIGHT TO USE IP, APART FROM THE MARK AS SHOWN.

FOR SATELLITE TRANSMISSION SERVICES, NAMELY, TRANSMISSION OF IP PROGRAMS AND IP SERVICES VIA TELECOMMUNICATIONS SATELLITES (U.S. CLS. 100, 101 AND 104).

FIRST USE 11-0-2005; IN COMMERCE 11-0-2005.

3,177,644. CENTENNIAL COMMUNICATIONS CORP., WALL, NJ. SN 78-232,509. PUB. 12-2-2003, FILED 4-1-2003.

CENTENNIAL TE ESCUCHA

THE ENGLISH TRANSLATION OF "CENTENNIAL TE ESCUCHA" IS "CENTENNIAL LISTENS TO YOU".

FOR WIRELESS TELEPHONE SERVICES (U.S. CLS. 100, 101 AND 104).

FIRST USE 9-0-2003; IN COMMERCE 9-0-2003.

3,177,727. WESTPORT COMMUNICATIONS LP, BEVERLY, MA. SN 78-347,657. PUB. 6-14-2005, FILED 1-5-2004.

Good Time Favorites

THE MARK CONSISTS OF STANDARD CHARACTERS WITHOUT CLAIM TO ANY PARTICULAR FONT, STYLE, SIZE, OR COLOR.

NO CLAIM IS MADE TO THE EXCLUSIVE RIGHT TO USE FAVORITES, APART FROM THE MARK AS SHOWN.

FOR RADIO BROADCASTING SERVICES (U.S. CLS. 100, 101 AND 104).

FIRST USE 1-5-2004; IN COMMERCE 1-5-2004.

CLASS 38—(Continued).

3,177,729. BELLSOUTH INTELLECTUAL PROPERTY CORPORATION, WILMINGTON, DE. SN 78-348,694. PUB. 11-2-2004, FILED 1-7-2004.

CLASS 38—(Continued).

3,177,812. DANIEL, COLONNESE, CAMBRIDGE, MA. SN 78-403,839. PUB. 9-20-2005, FILED 4-19-2004.

WAVEGATE

THE MARK CONSISTS OF STANDARD CHARACTERS WITHOUT CLAIM TO ANY PARTICULAR FONT, STYLE, SIZE, OR COLOR.

FOR TELECOMMUNICATION SERVICES, NAMELY PRIVATE LINE VOICE, TEXT, FACSIMILE, VIDEO AND DATA TELECOMMUNICATIONS TRANSMISSIONS SERVICES (U.S. CLS. 100, 101 AND 104).

FIRST USE 6-6-2005; IN COMMERCE 10-31-2005.

3,177,745. AMERICATEL CORPORATION, MIAMI, FL. SN 78-363,306. PUB. 7-5-2005, FILED 2-5-2004.

**HAPPY HOUR
TELEFONICO DEL 1010-
123 DE AMERICATEL**

THE MARK CONSISTS OF STANDARD CHARACTERS WITHOUT CLAIM TO ANY PARTICULAR FONT, STYLE, SIZE, OR COLOR.

NO CLAIM IS MADE TO THE EXCLUSIVE RIGHT TO USE "TELEFONICO", APART FROM THE MARK AS SHOWN.

THE FOREIGN WORDING IN THE MARK TRANSLATES INTO ENGLISH AS TELEPHONIC HAPPY HOUR OF THE 1010-123 FROM AMERICATEL.

SEC. 2(F) AS TO "1010-123".

FOR TELECOMMUNICATION SERVICES, NAMELY LONG DISTANCE AND INTERNATIONAL VOICE, TEXT, FACSIMILE, VIDEO, IMAGE, DATA AND WIRELESS TRANSMISSION VIA SATELLITE, TERRESTRIAL AND UNDERSEA COMMUNICATION LINKS; TELEPHONE TELECOMMUNICATIONS SERVICES PROVIDED VIA PREPAID TELEPHONE CALLING CARDS; PROVIDING MULTIPLE USER ACCESS TO A GLOBAL COMPUTER NETWORK (U.S. CLS. 100, 101 AND 104).

FIRST USE 2-9-2004; IN COMMERCE 2-9-2004.

PEAK OIL

THE MARK CONSISTS OF STANDARD CHARACTERS WITHOUT CLAIM TO ANY PARTICULAR FONT, STYLE, SIZE, OR COLOR.

FOR PROVIDING ON-LINE ELECTRONIC BULLETIN BOARDS FOR TRANSMISSION OF MESSAGES AMONG COMPUTER USERS CONCERNING NEWS ABOUT OIL (U.S. CLS. 100, 101 AND 104).

FIRST USE 2-23-2004; IN COMMERCE 2-23-2004.

3,178,530. COPY CAT USA, L.L.C., CHESTERFIELD, MO. SN 78-665,888. PUB. 3-21-2006, FILED 7-7-2005.



NO CLAIM IS MADE TO THE EXCLUSIVE RIGHT TO USE "USA", APART FROM THE MARK AS SHOWN.

FOR COMMUNICATION SERVICES, NAMELY, ELECTRONIC MAIL SERVICES AND ELECTRONIC TRANSMISSION OF DATA AND DOCUMENTS VIA COMPUTER TERMINALS; FACSIMILE TRANSMISSION SERVICES (U.S. CLS. 100, 101 AND 104).

FIRST USE 8-29-2005; IN COMMERCE 8-29-2005.

CLASS 38—(Continued).

3,178,565. PURPLECOMM, INC., SANTA CLARA, CA. SN 78-681,122. PUB. 5-2-2006, FILED 7-28-2005.

PsipTN

THE MARK CONSISTS OF STANDARD CHARACTERS WITHOUT CLAIM TO ANY PARTICULAR FONT, STYLE, SIZE, OR COLOR.

FOR PROVIDING COMPUTER NETWORK BASED TELECOMMUNICATION SERVICES, INTERNET TELEPHONY SERVICES, AND A VOICE OVER INTERNET PROTOCOL/VOIP TELEPHONY NETWORK SERVICES BASED ON SESSION INITIATION PROTOCOLS/SIP (U.S. CLS. 100, 101 AND 104).

FIRST USE 8-1-2005; IN COMMERCE 8-1-2005.

3,178,651. TELEGUAM HOLDINGS, LLC, TAMUNING, GUAM. SN 78-740,898. PUB. 5-2-2006, FILED 10-26-2005.

MPULSE

THE MARK CONSISTS OF STANDARD CHARACTERS WITHOUT CLAIM TO ANY PARTICULAR FONT, STYLE, SIZE, OR COLOR.

FOR CELLULAR TELEPHONE SERVICES (U.S. CLS. 100, 101 AND 104).

FIRST USE 12-1-2005; IN COMMERCE 12-1-2005.



FOR CELLULAR TELEPHONE SERVICES (U.S. CLS. 100, 101 AND 104).

FIRST USE 12-1-2005; IN COMMERCE 12-1-2005.

CLASS 39—TRANSPORTATION AND STORAGE

CLASS 39—(Continued).

3,177,629. GROUPEX FINANCIAL CORPORATION, LA MIRADA, CA. SN 78-186,475. PUB. 7-1-2003, FILED 11-19-2002.

REYMESA

FOR COURIER SERVICES (U.S. CLS. 100 AND 105).
FIRST USE 9-13-2006; IN COMMERCE 9-13-2006.

3,177,827. LAKE REGION ELECTRIC COOPERATIVE, INC., HULBERT, OK. SN 78-414,088. PUB. 4-12-2005, FILED 5-6-2004.



NO CLAIM IS MADE TO THE EXCLUSIVE RIGHT TO USE ELECTRIC COOPERATIVE, APART FROM THE MARK AS SHOWN.

THE COLOR BLUE IS CLAIMED AS A FEATURE OF THE MARK.

THE MARK CONSISTS OF LREC IN CAPITAL WHITE LETTERS ON A BLUE BACKGROUND WITH A BURST OF LIGHTNING BOLTS COMING OUT OF THE LREC. THE WORDS LAKE REGION ELECTRIC COOPERATIVE APPEAR BELOW IN BLUE.

FOR PUBLIC UTILITY SERVICES IN THE NATURE OF ELECTRICITY DISTRIBUTION (U.S. CLS. 100 AND 105).

FIRST USE 6-1-1992; IN COMMERCE 6-1-1992.

3,177,829. TXU CORP., DALLAS, TX. SN 78-414,495. PUB. 4-26-2005, FILED 5-6-2004.

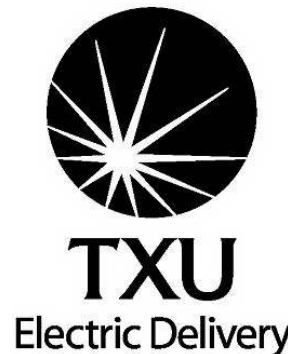

OWNER OF U.S. REG. NOS. 2,784,505, 2,869,869, AND OTHERS.

CLASS 39—(Continued).

NO CLAIM IS MADE TO THE EXCLUSIVE RIGHT TO USE ELECTRIC DELIVERY, APART FROM THE MARK AS SHOWN.

THE MARK CONSISTS OF A LITERAL ELEMENT COMBINED WITH A MULTI-POINT STAR BURST DESIGN IMPOSED ON A CIRCLE.

FOR ELECTRIC UTILITY SERVICES, NAMELY, TRANSMISSION AND DISTRIBUTION OF ELECTRIC POWER (U.S. CLS. 100 AND 105).

FIRST USE 6-25-2004; IN COMMERCE 6-25-2004.

CLASS 39—(Continued).

3,178,030. ASSISI ANIMAL CLINICS OF VIRGINIA, INC., ROANOKE, VA. SN 78-497,732. PUB. 10-11-2005, FILED 10-11-2004.

Harmony Farm Sanctuary

3,177,959. PHNS INC., DALLAS, TX. SN 78-469,474. PUB. 11-22-2005, FILED 8-18-2004.

THE MARK CONSISTS OF STANDARD CHARACTERS WITHOUT CLAIM TO ANY PARTICULAR FONT, STYLE, SIZE, OR COLOR.

NO CLAIM IS MADE TO THE EXCLUSIVE RIGHT TO USE "FARM SANCTUARY", APART FROM THE MARK AS SHOWN.

FOR ANIMAL RESCUE SERVICES FOR DOMESTIC ANIMALS AND WILDLIFE (U.S. CLS. 100 AND 105).

FIRST USE 1-1-2005; IN COMMERCE 1-1-2005.

3,178,037. MAHÉ FREIGHT A/S, KASTRUP, DENMARK. SN 78-502,568. PUB. 2-28-2006, FILED 10-20-2004.

PHNS FINANCIAL INFORMATION EXCHANGE

Mahé

THE MARK CONSISTS OF STANDARD CHARACTERS WITHOUT CLAIM TO ANY PARTICULAR FONT, STYLE, SIZE, OR COLOR.

OWNER OF U.S. REG. NO. 2,703,884.

NO CLAIM IS MADE TO THE EXCLUSIVE RIGHT TO USE "FINANCIAL INFORMATION EXCHANGE", APART FROM THE MARK AS SHOWN.

FOR ELECTRONIC STORAGE AND RETRIEVAL OF INFORMATION IN THE HEALTH CARE INDUSTRY (U.S. CLS. 100 AND 105).

FIRST USE 12-27-2004; IN COMMERCE 12-27-2004.

THE MARK CONSISTS OF STANDARD CHARACTERS WITHOUT CLAIM TO ANY PARTICULAR FONT, STYLE, SIZE, OR COLOR.

OWNER OF DENMARK REG. NO. VR199901597, DATED 5-17-1999, EXPIRES 5-17-2009.

FOR WAREHOUSING SERVICES, PACKING ARTICLES FOR TRANSPORTATION, FREIGHT FORWARDING, FREIGHT BROKERAGE, GLOBAL TRANSPORTATION OF FREIGHT FOR OTHERS BY ALL AVAILABLE MEANS (U.S. CLS. 100 AND 105).

FIRST USE 12-31-1975; IN COMMERCE 12-31-2001.

CLASS 39—(Continued).

3,178,334. MXENERGY INC., STAMFORD, CT. SN 78-596,184. PUB. 12-27-2005, FILED 3-28-2005.

MAX

THE MARK CONSISTS OF STANDARD CHARACTERS WITHOUT CLAIM TO ANY PARTICULAR FONT, STYLE, SIZE, OR COLOR.

FOR DISTRIBUTION OF ENERGY, NAMELY ELECTRICITY AND NATURAL GAS, TO COMMERCIAL AND RESIDENTIAL CONSUMERS (U.S. CLS. 100 AND 105). FIRST USE 1-1-2005; IN COMMERCE 1-1-2005.

3,178,457. WORLDPASS TRAVEL GROUP, LLC, EL DORADO HILLS, CA. SN 78-638,445. PUB. 2-14-2006, FILED 5-26-2005.

WORLDPASS TRAVEL

THE MARK CONSISTS OF STANDARD CHARACTERS WITHOUT CLAIM TO ANY PARTICULAR FONT, STYLE, SIZE, OR COLOR.

NO CLAIM IS MADE TO THE EXCLUSIVE RIGHT TO USE TRAVEL, APART FROM THE MARK AS SHOWN.

FOR ARRANGING TRAVEL TOURS; ARRANGING TRAVEL RESERVATIONS AND BOOKING TOURS FOR GROUPS; ARRANGING AND CONDUCTING EDUCATIONAL SIGHTSEEING TOURS FOR OTHERS RELATED TO CULTURAL, HISTORIC AND SOCIAL SUBJECTS, PLACES AND EVENTS (U.S. CLS. 100 AND 105).

FIRST USE 8-1-2005; IN COMMERCE 8-1-2005.

CLASS 39—(Continued).

3,178,529. COPY CAT USA, L.L.C., CHESTERFIELD, MO. SN 78-665,885. PUB. 3-21-2006, FILED 7-7-2005.



NO CLAIM IS MADE TO THE EXCLUSIVE RIGHT TO USE "USA", APART FROM THE MARK AS SHOWN.

FOR PACKAGING PARCELS, CORRESPONDENCE AND MAIL PRIOR TO SHIPMENT AND DELIVERY; ARRANGING SHIPMENT AND DELIVERY OF PARCELS, CORRESPONDENCE AND MAIL; AND RENTAL OF MAILBOXES (U.S. CLS. 100 AND 105).

FIRST USE 8-29-2005; IN COMMERCE 8-29-2005.

3,178,584. UNION PRIVILEGE, INC., WASHINGTON, DC. SN 78-696,887. PUB. 5-9-2006, FILED 8-19-2005.



OWNER OF U.S. REG. NOS. 2,180,858, 2,558,846, AND OTHERS.

NO CLAIM IS MADE TO THE EXCLUSIVE RIGHT TO USE "UNION", APART FROM THE MARK AS SHOWN.

FOR TRAVEL TICKET RESERVATION SERVICE (U.S. CLS. 100 AND 105).

FIRST USE 11-1-2005; IN COMMERCE 11-1-2005.

CLASS 40—MATERIAL TREATMENT

CLASS 40—(Continued).

3,177,800. SOUTER, JOHN, WAYZATA, MN. SN 78-398,404. PUB. 9-6-2005, FILED 4-8-2004.

Dr Colour

THE MARK CONSISTS OF STANDARD CHARACTERS WITHOUT CLAIM TO ANY PARTICULAR FONT, STYLE, SIZE, OR COLOR.

NO CLAIM IS MADE TO THE EXCLUSIVE RIGHT TO USE COLOUR, APART FROM THE MARK AS SHOWN.

FOR PRINTING SERVICES AND COLOR REPRODUCTION SERVICES (U.S. CLS. 100, 103 AND 106). FIRST USE 5-1-2005; IN COMMERCE 6-5-2005.

3,177,911. FOOD INVESTMENTS LIMITED, LONDON, UNITED KINGDOM. SN 78-452,759. PUB. 6-21-2005, FILED 7-19-2004.

PAT ADVANTAGE

THE MARK CONSISTS OF STANDARD CHARACTERS WITHOUT CLAIM TO ANY PARTICULAR FONT, STYLE, SIZE, OR COLOR.

FOR PHYSIOLOGICAL SEED PRIMING TREATMENT FOR SUGAR BEET SEED TO PROMOTE FASTER AND MORE UNIFORM FIELD GERMINATION (U.S. CLS. 100, 103 AND 106). FIRST USE 0-0-2005; IN COMMERCE 0-0-2005.

CLASS 41—EDUCATION AND ENTERTAINMENT

CLASS 41—(Continued).

3,177,352. RAIMONDI, GEORGIA, STAMFORD, CT. SN 76-347,619. PUB. 5-27-2003, FILED 12-12-2001.

GARDEN DIVA

NO CLAIM IS MADE TO THE EXCLUSIVE RIGHT TO USE "GARDEN", APART FROM THE MARK AS SHOWN.

FOR ENTERTAINMENT SERVICES IN THE NATURE OF AN ON-GOING TELEVISION, VIDEO AND INTERNET PROGRAMS SERIES IN THE FIELD OF GARDENING, RECIPES, CRAFTS, AROMATHERAPY, DECORATING AND ENTERTAINING, EDUCATIONAL SERVICES, NAMELY, CONDUCTING WORKSHOPS AND PUBLIC LECTURES IN THE FIELD OF GARDENING, RECIPES, CRAFTS, AROMATHERAPY, DECORATING AND ENTERTAINING (U.S. CLS. 100, 101 AND 107). FIRST USE 8-10-2006; IN COMMERCE 8-10-2006.

3,177,371. SMITH, PHILLIP H., PITTSBURGH, PA. SN 76-457,448. PUB. 9-2-2003, FILED 10-10-2002.

LADLESHEET PRESS

NO CLAIM IS MADE TO THE EXCLUSIVE RIGHT TO USE "PRESS", APART FROM THE MARK AS SHOWN.

FOR PUBLICATION OF BOOKS (U.S. CLS. 100, 101 AND 107).

FIRST USE 3-0-2005; IN COMMERCE 3-0-2005.

3,177,427. ZHI GANG SHA, LLC, PETALUMA, CA. SN 76-577,395. PUB. 8-30-2005, FILED 2-13-2004.

SAY HELLO HEALING

THE MARK CONSISTS OF STANDARD CHARACTERS WITHOUT CLAIM TO ANY PARTICULAR FONT, STYLE, SIZE, OR COLOR.

NO CLAIM IS MADE TO THE EXCLUSIVE RIGHT TO USE "HEALING", APART FROM THE MARK AS SHOWN.

FOR EDUCATIONAL SERVICES, NAMELY CONDUCTING CLASSES, COURSES, SEMINARS, CONFERENCES AND WORKSHOPS IN THE FIELD OF ENERGY AND SPIRITUAL HEALING AND PROVIDING COURSE MATERIALS AND SOFTWARE IN CONNECTION THEREWITH (U.S. CLS. 100, 101 AND 107).

FIRST USE 8-1-2006; IN COMMERCE 8-1-2006.

CLASS 41—(Continued).

3,177,446. SIERRA SUITES FRANCHISE, L.P., WICHITA, KS.
SN 76-593,328. PUB. 6-21-2005, FILED 5-20-2004.

SIERRA SUITESTAKES

THE MARK CONSISTS OF STANDARD CHARACTERS WITHOUT CLAIM TO ANY PARTICULAR FONT, STYLE, SIZE, OR COLOR.

FOR ENTERTAINMENT SERVICES, NAMELY, PROVIDING ON-LINE GAMES, SWEEPSTAKES AND CONTESTS (U.S. CLS. 100, 101 AND 107).

FIRST USE 4-21-2004; IN COMMERCE 4-21-2004.

3,177,450. MORRIS, JOHN C., DBA YOW-ZAH! PRODUCTIONS, BELTON, MO. SN 76-598,979. PUB. 5-24-2005, FILED 6-23-2004.

NEON BEAT

THE MARK CONSISTS OF STANDARD CHARACTERS WITHOUT CLAIM TO ANY PARTICULAR FONT, STYLE, SIZE, OR COLOR.

FOR RADIO SHOW FEATURING ADULT STANDARDS FROM THE 40'S, 50'S AND 60'S (U.S. CLS. 100, 101 AND 107).

FIRST USE 1-1-2005; IN COMMERCE 1-1-2005.

3,177,461. VENTURE ARCHITECTS, LLC, NEW YORK, NY.
SN 76-605,756. PUB. 6-28-2005, FILED 8-3-2004.

RADICAL SIMPLIFICATION

THE MARK CONSISTS OF STANDARD CHARACTERS WITHOUT CLAIM TO ANY PARTICULAR FONT, STYLE, SIZE, OR COLOR.

FOR EDUCATIONAL SERVICES, NAMELY SEMINARS AND WORKSHOPS IN THE FIELD OF BUSINESS PLANNING, FINANCIAL PROJECTIONS, CAPITAL RAISING AND CONSULTING FOR EARLY STAGE COMPANIES AND DISTRIBUTING COURSE MATERIALS IN CONNECTION THEREWITH (U.S. CLS. 100, 101 AND 107).

FIRST USE 9-12-2006; IN COMMERCE 9-12-2006.

CLASS 41—(Continued).

3,177,473. THE WORLD HYPERTENSION LEAGUE, TOLEDO, OH. SN 76-609,334. PUB. 11-1-2005, FILED 8-26-2004.



NO CLAIM IS MADE TO THE EXCLUSIVE RIGHT TO USE "HYPERTENSION", APART FROM THE MARK AS SHOWN.

THE MARK CONSISTS OF THE WORDING WORLD HYPERTENSION DAY WITH AN H INSIDE A GLOBE SEPARATED BY MERIDIAN LINES. THE GLOBE IS INSIDE THE LETTER "O" WHICH IN TURN IS DEPICTED IN A HEART SHAPE. THERE ARE ALSO TWO RECTANGLES, ONE AFTER THE WORD "WORLD" AND ANOTHER BEFORE THE WORD "DAY".

FOR EDUCATIONAL SERVICES, NAMELY, CONDUCTING CLASSES, CONFERENCES, WORKSHOPS AND SEMINARS IN THE FIELD OF HYPERTENSION AND RELATED HEALTH CARE ISSUES; EDUCATIONAL SERVICES, NAMELY, CONDUCTING CLASSES, CONFERENCES, WORKSHOPS AND SEMINARS IN THE FIELD OF THE DETECTION, CONTROL AND PREVENTION OF HYPERTENSION; CONDUCT CLASSES, CONFERENCES, WORKSHOPS AND SEMINARS IN THE FIELD OF HYPERTENSION AND RELATED HEALTH CARE ISSUES AND DISTRIBUTING COURSE MATERIALS IN CONNECTION WITH ALL OF THE ABOVE MENTIONED (U.S. CLS. 100, 101 AND 107).

FIRST USE 5-1-2005; IN COMMERCE 5-1-2005.

3,177,476. SHEAKLEY UNICOMP, INC., CINCINNATI, OH.
SN 76-609,566. PUB. 12-27-2005, FILED 8-27-2004.

SHEAKLEY E-TRAINING SOLUTIONS

THE MARK CONSISTS OF STANDARD CHARACTERS WITHOUT CLAIM TO ANY PARTICULAR FONT, STYLE, SIZE, OR COLOR.

OWNER OF U.S. REG. NO. 2,239,665.

NO CLAIM IS MADE TO THE EXCLUSIVE RIGHT TO USE "E-TRAINING", APART FROM THE MARK AS SHOWN.

FOR EDUCATIONAL SERVICES, NAMELY, CONDUCTING WORKSHOPS AND ONLINE INSTRUCTION IN THE FIELDS OF NURSING, HEALTHCARE AND MEDICINE TO EDUCATE NURSES, HEALTHCARE PROFESSIONALS AND OTHER MEDICAL PROFESSIONALS (U.S. CLS. 100, 101 AND 107).

FIRST USE 11-15-2004; IN COMMERCE 11-15-2004.

CLASS 41—(Continued).

3,177,493. NGO, RICHARD B., FRANKLIN, TN. SN 76-612,879. PUB. 12-20-2005, FILED 9-17-2004.



FOR EDUCATIONAL SERVICES, NAMELY, CONDUCTING CLASSES, SEMINARS, CONFERENCES, WORKSHOPS IN THE FIELD OF SELF-DEFENSE TECHNIQUES, AND DISTRIBUTING COURSE MATERIALS, NAMELY, DVDS AND PUBLICATIONS, IN CONNECTION THEREWITH (U.S. CLS. 100, 101 AND 107).
FIRST USE 8-31-2004; IN COMMERCE 8-31-2004.

CLASS 41—(Continued).

3,177,514. ARENA FOOTBALL LEAGUE, LLC, NEW YORK, NY. SN 76-621,004. PUB. 12-20-2005, FILED 11-18-2004.



OWNER OF U.S. REG. NOS. 2,191,816 AND 2,591,115.
THE MARK CONSISTS, IN PART, OF A CAT TOSSING A FOOTBALL.
FOR ENTERTAINMENT SERVICES, NAMELY ORGANIZING AND PRESENTING FOOTBALL GAMES BEFORE LIVE AUDIENCES AND ON TELEVISION, RADIO, FOR GLOBAL COMPUTER NETWORK DISPLAY AND OTHER MEDIA (U.S. CLS. 100, 101 AND 107).
FIRST USE 1-1-1997; IN COMMERCE 1-1-1997.

3,177,507. GYM POSSIBLE, INC., BARNSTEAD, NH. SN 76-617,439. PUB. 9-6-2005, FILED 10-25-2004.

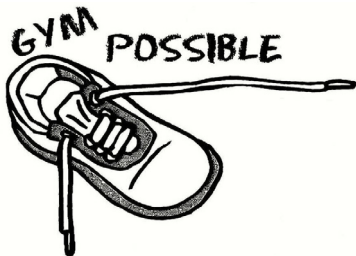

FOR PROVIDING A FITNESS CENTER FOR CHILDREN (U.S. CLS. 100, 101 AND 107).
FIRST USE 5-17-2006; IN COMMERCE 5-17-2006.

3,177,522. FIRST 5 CONTRA COSTA CHILDREN AND FAMILIES COMMISSION, MARTINEZ, CA. SN 76-623,263. PUB. 12-20-2005, FILED 12-6-2004.

TIGO

THE MARK CONSISTS OF STANDARD CHARACTERS WITHOUT CLAIM TO ANY PARTICULAR FONT, STYLE, SIZE, OR COLOR.
FOR EDUCATIONAL SERVICES, NAMELY, PROVIDING INFORMATION, INSTRUCTION, CONSULTATION, WORKSHOPS, SUPPORT GROUPS, AND ONLINE INFORMATION, LEARNING ACTIVITIES AND INSTRUCTION IN THE FIELD OF SCHOOL READINESS (U.S. CLS. 100, 101 AND 107).
FIRST USE 9-1-2005; IN COMMERCE 9-1-2005.

CLASS 41—(Continued).

3,177,529. RUBINGER, NICOLE, GOLDEN VALLEY, MN. SN 76-625,440. PUB. 12-20-2005, FILED 12-22-2004.

DE-CLUTTER CLUB!

THE MARK CONSISTS OF STANDARD CHARACTERS WITHOUT CLAIM TO ANY PARTICULAR FONT, STYLE, SIZE, OR COLOR.

NO CLAIM IS MADE TO THE EXCLUSIVE RIGHT TO USE CLUB FOR CLASS 41, APART FROM THE MARK AS SHOWN.

FOR EDUCATIONAL SERVICES, NAMELY CONDUCTING WORKSHOPS TO TRAIN INDIVIDUALS IN PERSONAL ORGANIZATION (U.S. CLS. 100, 101 AND 107).

FIRST USE 12-5-2004; IN COMMERCE 12-5-2004.

3,177,537. A DANCER'S DREAM, INC., MARBLEHEAD, MA. SN 76-629,402. PUB. 5-30-2006, FILED 1-26-2005.



THE MARK CONSISTS OF A SHOOTING STAR DESIGN. FOR DANCE INSTRUCTION (U.S. CLS. 100, 101 AND 107).

FIRST USE 0-0-1984; IN COMMERCE 0-0-1984.

3,177,581. XERVIOUS NETWORKS LLC, FLUSHING, NY. SN 76-646,476. PUB. 5-23-2006, FILED 9-9-2005.

XERVIOUS NETWORKS

THE MARK CONSISTS OF STANDARD CHARACTERS WITHOUT CLAIM TO ANY PARTICULAR FONT, STYLE, SIZE, OR COLOR.

NO CLAIM IS MADE TO THE EXCLUSIVE RIGHT TO USE NETWORKS, APART FROM THE MARK AS SHOWN.

FOR ENTERTAINMENT SERVICES, NAMELY, PROVIDING ADULT-ORIENTED ONLINE COMPUTER GAMES (U.S. CLS. 100, 101 AND 107).

FIRST USE 9-1-2005; IN COMMERCE 9-1-2005.

3,177,603. TENDERLOIN TECHNOLOGIES, INC., TREASURE ISLAND, CA. SN 78-128,119. PUB. 6-24-2003, FILED 5-13-2002.

BROWN BOTTLE RECORDS**CLASS 41—(Continued).**

NO CLAIM IS MADE TO THE EXCLUSIVE RIGHT TO USE "RECORDS", APART FROM THE MARK AS SHOWN. FOR PRODUCTION OF AUDIO AND VIDEO RECORDINGS; RECORDING STUDIO SERVICES (U.S. CLS. 100, 101 AND 107).

FIRST USE 4-22-2006; IN COMMERCE 4-22-2006.

3,177,641. TELEVERSE MEDIA, LLC, MILFORD, CT. SN 78-228,673. PUB. 12-7-2004, FILED 3-21-2003.

TELEVERSEMEDIA

THE MARK CONSISTS OF STANDARD CHARACTERS WITHOUT CLAIM TO ANY PARTICULAR FONT, STYLE, SIZE, OR COLOR.

FOR MEDIA PRODUCTION AND POST-PRODUCTION SERVICES, NAMELY, CABLE, BROADCAST AND CORPORATE TELEVISION PROGRAMMING PRODUCTION AND POST-PRODUCTION SERVICES (U.S. CLS. 100, 101 AND 107).

FIRST USE 8-8-2003; IN COMMERCE 8-8-2003.

3,177,651. GLOBAL GAMING LEAGUE, INC., BURBANK, CA. SN 78-247,630. PUB. 7-27-2004, FILED 5-9-2003.



NO CLAIM IS MADE TO THE EXCLUSIVE RIGHT TO USE "GLOBAL GAMING LEAGUE", APART FROM THE MARK AS SHOWN.

FOR ENTERTAINMENT SERVICES, NAMELY, PROVIDING COMPETITIVE MULTI-PLAYER VIDEO GAMING (U.S. CLS. 100, 101 AND 107).

FIRST USE 6-1-2003; IN COMMERCE 6-1-2003.

3,177,656. OULUN MUSIIKKIVIDEOFESTIVAALIT RY, OULU, FINLAND. SN 78-252,939. PUB. 3-21-2006, FILED 5-22-2003.



NO CLAIM IS MADE TO THE EXCLUSIVE RIGHT TO USE "AIR GUITAR WORLD CHAMPIONSHIPS", APART FROM THE MARK AS SHOWN.

THE COLORS GRAY, BLACK AND WHITE ARE CLAIMED AS A FEATURE OF THE MARK.

CLASS 41—(Continued).

THE MARK CONSISTS OF WORDS AIR GUITAR WORLD CHAMPIONSHIPS IN BLACK AND A PICTURE OF A HAND HOLDING TWO FINGERS TOGETHER AND TWO ARROWS ABOVE AND BELOW THE HAND IN THE COLOR BLACK WITH THE HAND SHOWN IN WHITE WITH BLACK BORDER. THE WORDS HAVE GRAY SHADING AND ON THE BACKGROUND ARE 8 (EIGHT) GRAY WAVY LINES.

FOR ENTERTAINMENT IN THE NATURE OF AIR GUITAR PLAYING COMPETITION, WHICH IS AN EVENT OR A SERIES OF EVENTS WHERE ONE WINNER WILL BE SELECTED FROM A GROUP OF PEOPLE PLAYING INVISIBLE INSTRUMENT TO MUSIC THE WINNER IS TO BE CALLED "THE WORLD CHAMPION" (U.S. CLS. 100, 101 AND 107).

FIRST USE 8-27-2002; IN COMMERCE 1-1-2003.

3,177,680. VALERIO, BENNY A., TOMBALL, TX. SN 78-298,399. PUB. 1-3-2006, FILED 9-10-2003.

JUKE JOINT RECORDS

NO CLAIM IS MADE TO THE EXCLUSIVE RIGHT TO USE "RECORDS", APART FROM THE MARK AS SHOWN. FOR RECORD LABEL SERVICES, NAMELY, RECORDING AND PRODUCTION OF PHONOGRAPH RECORDS, CASSETTE TAPES AND AUDIO COMPACT DISCS FEATURING MUSIC (U.S. CLS. 100, 101 AND 107).

FIRST USE 7-30-2006; IN COMMERCE 8-1-2006.

3,177,692. QWEST COMMUNICATIONS INTERNATIONAL INC., DENVER, CO. SN 78-312,388. PUB. 4-19-2005, FILED 10-10-2003.

INCREDIBLE INTERNET GUY

THE MARK CONSISTS OF STANDARD CHARACTERS WITHOUT CLAIM TO ANY PARTICULAR FONT, STYLE, SIZE, OR COLOR.

FOR EDUCATIONAL SERVICES, NAMELY, PROVIDING A WEBSITE FEATURING COMPUTER, TELECOMMUNICATION AND INTERNET TRAINING INFORMATION (U.S. CLS. 100, 101 AND 107).

FIRST USE 9-30-2003; IN COMMERCE 9-30-2003.

3,177,702. SSS PTY LTD, KINGS PARK, NEW SOUTH WALES, AUSTRALIA. SN 78-320,766. PUB. 9-13-2005, FILED 10-30-2003.

CREATIVE WORLD MASTERS**CLASS 41—(Continued).**

PRIORITY CLAIMED UNDER SEC. 44(D) ON AUSTRALIA APPLICATION NO. 972874, FILED 10-3-2003, REG. NO. 972874, DATED 10-3-2003, EXPIRES 10-3-2013.

FOR ORGANIZING, ARRANGING AND CONDUCTING COMPETITIONS, EXHIBITIONS, TRAINING CLASSES, WORKSHOPS, PRESENTATIONS AND ENTERTAINMENT NAMELY SUCH SERVICES FOR SEWING, KNITTING, EMBROIDERY, CRAFTS, QUILT MAKING AND QUILTS (U.S. CLS. 100, 101 AND 107).

FIRST USE 2-1-2004; IN COMMERCE 4-1-2006.

3,177,719. GUARDSMARK, LLC, MEMPHIS, TN. SN 78-343,974. PUB. 11-9-2004, FILED 12-21-2003.

MPS

THE MARK CONSISTS OF STANDARD CHARACTERS WITHOUT CLAIM TO ANY PARTICULAR FONT, STYLE, SIZE, OR COLOR.

FOR CUSTOM WRITING SERVICES IN THE FIELD OF SECURITY SERVICES FEATURING WRITTEN DUTIES FOR SECURITY SERVICE PROVIDERS (U.S. CLS. 100, 101 AND 107).

FIRST USE 8-31-2005; IN COMMERCE 8-31-2005.

3,177,732. PRIMADONNA COMPANY, LLC, PRIMM, NV. SN 78-352,704. PUB. 8-30-2005, FILED 1-15-2004.



OWNER OF U.S. REG. NOS. 2,600,924 AND 2,781,649. NO CLAIM IS MADE TO THE EXCLUSIVE RIGHT TO USE "REWARDS" AND "PLAYERS CLUB", APART FROM THE MARK AS SHOWN.

THE MARK CONSISTS OF PICTURE OF PRIMM VALLEY RESORT WITH ROLLERCOASTER OVER THE WORD "PRIMM" IN CAPITAL LETTERS, OVER THE WORD "REWARDS", OVER THE WORDS "PLAYERS CLUB" IN ALL CAPITAL LETTERS.

FOR CASINOS AND CASINO SERVICES (U.S. CLS. 100, 101 AND 107).

FIRST USE 3-8-2005; IN COMMERCE 3-8-2005.

CLASS 41—(Continued).

3,177,768. KHER, RAGHAV, SAMMAMISH, WA. SN 78-376,271. PUB. 9-27-2005, FILED 3-1-2004.

CLASS 41—(Continued).

3,177,855. DRAMATIC CHANGE PTY LTD, SYDNEY, NSW, AUSTRALIA. SN 78-431,347. PUB. 12-13-2005, FILED 6-7-2004.

KARODPATI**Correct Patient**

THE MARK CONSISTS OF STANDARD CHARACTERS WITHOUT CLAIM TO ANY PARTICULAR FONT, STYLE, SIZE, OR COLOR.

THE ENGLISH TRANSLATION OF THE HINDI WORD KARODPATI IN THE MARK IS MILLIONAIRE.

FOR RENTAL OF COMPUTER GAME PROGRAMS AND PRE-RECORDED-VIDEOTAPES, MUSICAL SOUND RECORDINGS, DIGITAL VIDEO DISKS, AND AUDIO BOOKS BY MEANS OF COMMUNICATION NETWORKS (U.S. CLS. 100, 101 AND 107).

FIRST USE 8-1-2004; IN COMMERCE 8-1-2005.

THE MARK CONSISTS OF STANDARD CHARACTERS WITHOUT CLAIM TO ANY PARTICULAR FONT, STYLE, SIZE, OR COLOR.

OWNER OF ERPN CMNTY TM OFC REG. NO. 002960847, DATED 8-3-2004, EXPIRES 2-12-2012.

NO CLAIM IS MADE TO THE EXCLUSIVE RIGHT TO USE "PATIENT", APART FROM THE MARK AS SHOWN.

FOR EDUCATIONAL SERVICES AND TRAINING SERVICES, NAMELY CONDUCTING CLASSES, CONFERENCES, SEMINARS AND WORKSHOPS IN THE AREA OF THE SALES AND MARKETING OF PHARMACEUTICAL PRODUCTS AND RELATED GOODS (U.S. CLS. 100, 101 AND 107).

FIRST USE 8-14-1999; IN COMMERCE 10-12-2005.

3,177,823. COMPUTER HISTORY MUSEUM, MOUNTAIN VIEW, CA. SN 78-410,130. PUB. 9-27-2005, FILED 4-29-2004.

3,177,856. MASTERS OF POKER LLC, SANTA MONICA, CA. SN 78-431,385. PUB. 10-25-2005, FILED 6-8-2004.

THE COMPUTER BOWL**MASTERS OF POKER**

THE MARK CONSISTS OF STANDARD CHARACTERS WITHOUT CLAIM TO ANY PARTICULAR FONT, STYLE, SIZE, OR COLOR.

NO CLAIM IS MADE TO THE EXCLUSIVE RIGHT TO USE COMPUTER, APART FROM THE MARK AS SHOWN.

FOR EDUCATIONAL AND ENTERTAINMENT SERVICES, NAMELY, ORGANIZING AND CONDUCTING COMPUTER TRIVIA CONTESTS AND TOURNAMENTS (U.S. CLS. 100, 101 AND 107).

FIRST USE 6-7-2004; IN COMMERCE 6-7-2004.

THE MARK CONSISTS OF STANDARD CHARACTERS WITHOUT CLAIM TO ANY PARTICULAR FONT, STYLE, SIZE, OR COLOR.

NO CLAIM IS MADE TO THE EXCLUSIVE RIGHT TO USE "POKER", APART FROM THE MARK AS SHOWN.

FOR ORGANIZING POKER LEAGUES, CONDUCTING POKER TOURNAMENTS, POKER CLUBS, AND ARRANGING POKER CONTESTS (U.S. CLS. 100, 101 AND 107).

FIRST USE 5-1-2003; IN COMMERCE 2-1-2006.

CLASS 41—(Continued).

3,177,872. VAN LOON, MATTHEW, D, CEDAR KNOLLS, NJ.
SN 78-439,758. PUB. 6-28-2005, FILED 6-23-2004.

CLASS 41—(Continued).

3,177,898. TSUBURAYA PRODUCTIONS CO., LTD., TOKYO,
157, JAPAN. SN 78-449,019. PUB. 6-28-2005, FILED 7-12-
2004.

KLEP

THE MARK CONSISTS OF STANDARD CHARACTERS
WITHOUT CLAIM TO ANY PARTICULAR FONT, STYLE,
SIZE, OR COLOR.

FOR EDUCATIONAL SERVICES, NAMELY CON-
DUCTING PROGRAMS IN THE FIELD OF PRE-SCHOOL
EDUCATION, NAMELY PRE-KINDERGARTEN IN-
STRUCTION IN THE AREAS OF READING, ARITH-
METIC, COMPUTER SKILLS, AND OTHERS (U.S. CLS.
100, 101 AND 107).

FIRST USE 8-1-2006; IN COMMERCE 8-1-2006.

ULTRAMAN TIGA

3,177,897. TSUBURAYA PRODUCTIONS CO., LTD., TOKYO,
157, JAPAN. SN 78-449,015. PUB. 6-21-2005, FILED 7-12-
2004.

ULTRAMAN

THE MARK CONSISTS OF STANDARD CHARACTERS
WITHOUT CLAIM TO ANY PARTICULAR FONT, STYLE,
SIZE, OR COLOR.

OWNER OF U.S. REG. NOS. 2,893,821 AND 2,893,822.
FOR ENTERTAINMENT SERVICES, NAMELY, PRO-
DUCTION OF TELEVISION PROGRAMS (U.S. CLS. 100,
101 AND 107).

FIRST USE 9-14-2002; IN COMMERCE 9-14-2002.

THE MARK CONSISTS OF STANDARD CHARACTERS
WITHOUT CLAIM TO ANY PARTICULAR FONT, STYLE,
SIZE, OR COLOR.

OWNER OF U.S. REG. NOS. 2,893,821 AND 2,893,822.
FOR ENTERTAINMENT SERVICES, NAMELY, PRO-
DUCTION OF TELEVISION PROGRAMS (U.S. CLS. 100,
101 AND 107).

FIRST USE 9-14-2002; IN COMMERCE 9-14-2002.

CLASS 41—(Continued).

3,177,933. ALLIANT TECHSYSTEMS INC., EDINA, MN. SN 78-462,386. PUB. 12-13-2005, FILED 8-5-2004.



THE COLOR(S) GOLD AND BLACK IS/ARE CLAIMED AS A FEATURE OF THE MARK.

THE COLOR GOLD APPEARS AS THE OVERALL BACKGROUND COLOR IN THE LOGO, WHICH BEARS BLACK LETTERING AND GRAPHIC ELEMENTS. THE COLOR BLACK IS ALSO USED TO DEFINE THE OVERALL SHAPE OF THE DESIGN.

THE MARK CONSISTS OF A GRAPHICAL REPRESENTATION OF THE HEADSTAMPING END OF A FIREARM CARTRIDGE, BEARING THE WORDING "FEDERAL PREMIUM" AND TWO SHOCKWAVE DESIGNS.

FOR CONDUCTING EDUCATIONAL SEMINARS AND COURSES OF INSTRUCTION IN THE FIELDS OF FIREARMS, AMMUNITION, AMMUNITION HAND LOADING AND RELOADING, HUNTING, WILDLIFE, TARGET SHOOTING, SAFETY, DEFENSE, AND CONSERVATION AND DISTRIBUTING COURSE MATERIALS THEREWITH; ON-LINE PUBLICATION OF EDUCATIONAL AND INFORMATIONAL MATERIALS IN THE FIELDS OF FIREARMS, AMMUNITION, AMMUNITION HAND LOADING AND RELOADING, HUNTING, WILDLIFE, TARGET SHOOTING, SAFETY, DEFENSE, AND CONSERVATION; PROVIDING ON-LINE EDUCATIONAL SEMINARS RELATING TO FIREARMS, AMMUNITION, AMMUNITION HAND LOADING AND RELOADING, HUNTING, WILDLIFE, TARGET SHOOTING, SAFETY, DEFENSE, AND CONSERVATION; PROVIDING INFORMATION IN THE FIELDS OF RECREATIONAL HUNTING, TARGET SHOOTING AND WILDLIFE OBSERVATION (U.S. CLS. 100, 101 AND 107).

FIRST USE 2-12-2003; IN COMMERCE 2-12-2003.

CLASS 41—(Continued).

3,177,966. VAPPIE, JORDAN P., LOS ANGELES, CA. SN 78-471,576. PUB. 5-9-2006, FILED 8-22-2004.

GYMbalaya

THE MARK CONSISTS OF STANDARD CHARACTERS WITHOUT CLAIM TO ANY PARTICULAR FONT, STYLE, SIZE, OR COLOR.

FOR TRAINING SERVICES, NAMELY, CONDUCTING INDIVIDUAL AND GROUP FITNESS TRAINING SESSIONS, SEMINARS, AND WORKSHOPS FOR THE PURPOSE OF PROVIDING INSTRUCTION AND TRAINING IN THE FIELD OF PHYSICAL FITNESS (U.S. CLS. 100, 101 AND 107).

FIRST USE 5-1-2006; IN COMMERCE 5-1-2006.

3,177,998. AMERICAN BROADCASTING COMPANIES, INC., BURBANK, CA. SN 78-481,254. PUB. 12-27-2005, FILED 9-9-2004.

THE SCHOLAR

THE MARK CONSISTS OF STANDARD CHARACTERS WITHOUT CLAIM TO ANY PARTICULAR FONT, STYLE, SIZE, OR COLOR.

FOR ENTERTAINMENT SERVICES IN THE NATURE OF A CONTINUING TELEVISION REALITY SHOW (U.S. CLS. 100, 101 AND 107).

FIRST USE 6-6-2005; IN COMMERCE 6-6-2005.

CLASS 41—(Continued).

3,178,015. BARRY'S BOOTCAMP LLC, HIDDEN HILLS, CA. SN 78-491,057. PUB. 12-13-2005, FILED 9-28-2004.

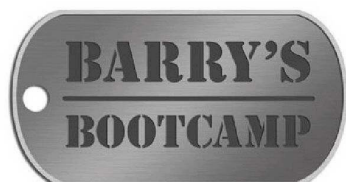

OWNER OF U.S. REG. NO. 2,326,729.
NO CLAIM IS MADE TO THE EXCLUSIVE RIGHT TO USE "BOOTCAMP", APART FROM THE MARK AS SHOWN. THE COLOR(S) GREY AND BLACK IS/ARE CLAIMED AS A FEATURE OF THE MARK.

THE MARK CONSISTS OF A METALLIC SILVER ARMY DOG TAG WITH MILITARY STYLE STENCILED LETTERING IN BLACK WITH THE WORD "BARRY'S" DIVIDED BY A LINE OVER THE WORD "BOOTCAMP" WHICH APPEARS IN A SLIGHTLY SMALLER FONT SIZE. THE DOG TAG IS GREY AND THE "BARRY'S BOOTCAMP" IS BLACK.

FOR EXERCISE CLASSES AT A SPECIALIZED FITNESS STUDIO FEATURING TREADMILLS AND FREE WEIGHTS FOR A COMPREHENSIVE CARDIO AND STRENGTH WORKOUT (U.S. CLS. 100, 101 AND 107).
FIRST USE 7-1-2000; IN COMMERCE 7-1-2000.

CLASS 41—(Continued).

3,178,026. JANG, YOUNG, LOS ANGELES, CA. SN 78-495,109. PUB. 3-14-2006, FILED 10-5-2004.



NO CLAIM IS MADE TO THE EXCLUSIVE RIGHT TO USE "UNIVERSITY OF WESTERN CALIFORNIA", APART FROM THE MARK AS SHOWN.

THE COLOR(S) RED, BLUE, AND GOLD IS/ARE CLAIMED AS A FEATURE OF THE MARK.

THE MARK CONSISTS OF A CONCENTRIC MARK WITH THE INNER MOST CIRCLE BEARING THE COLOR RED, AND THE OUTER MOST CIRCLE BEARING THE COLOR BLUE, IN WHICH CIRCLE IS BORN THE WORDS UNIVERSITY OF WESTERN CALIFORNIA IN WHITE, TOGETHER WITH A TOTAL OF EIGHT WHITE STARS DIVIDING THE WORDS "UNIVERSITY OF" FROM "WESTERN CALIFORNIA". THE CONCENTRIC MARK IS THEN ENCOMPASSED BY FLOWER PEDALS WHICH ARE BORN IN THE COLOR GOLD.

FOR EDUCATIONAL SERVICES, NAMELY PROVIDING COURSES OF INSTRUCTION AND TRAINING AT THE UNIVERSITY LEVEL AND GRADUATE LEVEL IN THE FIELDS OF BUSINESS, ART, MUSIC, LAW, SCIENCE, DENTISTRY, MEDICINE, ENGINEERING, ARCHITECTURE, LANGUAGE, HUMANITIES, HISTORY, PHILOSOPHY, PHYSICAL SCIENCE, SOCIAL SCIENCE, RELIGION, ORIENTAL MEDICINE, POLITICS, AND REAL ESTATES; EDUCATIONAL RESEARCH; ARRANGING AND CONDUCTING EDUCATIONAL CONFERENCES (U.S. CLS. 100, 101 AND 107).

FIRST USE 1-1-2005; IN COMMERCE 2-1-2005.

3,178,022. PEOPLES BANK, PARIS, TX. SN 78-492,763. PUB. 10-11-2005, FILED 10-1-2004.

MONEY ESSENTIALS

THE MARK CONSISTS OF STANDARD CHARACTERS WITHOUT CLAIM TO ANY PARTICULAR FONT, STYLE, SIZE, OR COLOR.

NO CLAIM IS MADE TO THE EXCLUSIVE RIGHT TO USE "MONEY", APART FROM THE MARK AS SHOWN.

FOR EDUCATIONAL SERVICES, NAMELY, FINANCIAL LITERACY TRAINING (U.S. CLS. 100, 101 AND 107).

FIRST USE 8-21-2006; IN COMMERCE 8-21-2006.

CLASS 41—(Continued).

3,178,027. SIERRA HEALTHSTYLES LLC, TUCSON, AZ. SN 78-496,279. PUB. 9-27-2005, FILED 10-7-2004.

BODYMINDFULNESS

THE MARK CONSISTS OF STANDARD CHARACTERS WITHOUT CLAIM TO ANY PARTICULAR FONT, STYLE, SIZE, OR COLOR.

OWNER OF U.S. REG. NO. 2,291,498.

FOR CONDUCTING WORKSHOPS, SEMINARS AND LECTURES IN THE FIELDS OF STRESS MANAGEMENT, SELF DISCOVERY, THE HEALTH AND WELLNESS OF THE BODY, MIND AND SPIRIT, FITNESS, NUTRITION, WELLNESS, SEXUALITY, VITALITY, WOMEN'S HEALTH AND MOTHERHOOD, MOVEMENT, PERSONAL GROWTH, HEALING, YOGA, AND MEDITATION, AND DISTRIBUTING COURSE MATERIALS IN CONNECTION THEREWITH; PROVIDING FACILITIES FOR FITNESS AND EXERCISE, AND FOR RECREATION ACTIVITIES IN THE NATURE OF AQUATIC FACILITIES, HEALTH CLUB FACILITIES; PHYSICAL FITNESS INSTRUCTION AND CONSULTATION (U.S. CLS. 100, 101 AND 107).

FIRST USE 11-30-1995; IN COMMERCE 11-30-1995.

3,178,031. ADDIE'S STUDIO 1 ON 1, INC., SAN DIEGO, CA. SN 78-497,785. PUB. 9-20-2005, FILED 10-11-2004.

REMODEL YOUR BODY

THE MARK CONSISTS OF STANDARD CHARACTERS WITHOUT CLAIM TO ANY PARTICULAR FONT, STYLE, SIZE, OR COLOR.

FOR PERSONAL TRAINING SERVICES, NAMELY, STRENGTH AND CONDITIONING TRAINING (U.S. CLS. 100, 101 AND 107).

FIRST USE 7-1-2004; IN COMMERCE 7-1-2004.

CLASS 41—(Continued).

3,178,086. FOCUS ON THE FAMILY, COLORADO SPRINGS, CO. SN 78-526,975. PUB. 5-16-2006, FILED 12-3-2004.

**Focus on the
Family's The Truth
Project**

THE MARK CONSISTS OF STANDARD CHARACTERS WITHOUT CLAIM TO ANY PARTICULAR FONT, STYLE, SIZE, OR COLOR.

OWNER OF U.S. REG. NOS. 1,104,503 AND 2,240,764.

FOR EDUCATIONAL SERVICES, NAMELY TRAINING AND EDUCATION SEMINARS RELATING TO A WORLDVIEW PERSPECTIVE BASED ON CHRISTIAN PHILOSOPHY (U.S. CLS. 100, 101 AND 107).

FIRST USE 5-5-2006; IN COMMERCE 5-5-2006.

3,178,121. TRIPLE PLAY FUN ZONE, LLC, SHEBOYGAN, WI. SN 78-541,664. PUB. 5-16-2006, FILED 1-4-2005.

**TRIPLE PLAY FUN
ZONE**

THE MARK CONSISTS OF STANDARD CHARACTERS WITHOUT CLAIM TO ANY PARTICULAR FONT, STYLE, SIZE, OR COLOR.

FOR MULTI-USE RECREATIONAL SERVICES, NAMELY MINI-GOLF COURSES, ROCK CLIMBING WALLS, BATTING CAGES, FACILITIES FOR LASER TAG GAMES, PLAY AREAS FOR CHILDREN AND DRIVING RANGES (U.S. CLS. 100, 101 AND 107).

FIRST USE 10-0-2005; IN COMMERCE 10-18-2005.

CLASS 41—(Continued).

3,178,124. SUPER BAKERY, INCORPORATED, PITTSBURGH, PA. SN 78-542,769. PUB. 4-18-2006, FILED 1-5-2005.

**Grid Iron Golf
Tournament**

THE MARK CONSISTS OF STANDARD CHARACTERS WITHOUT CLAIM TO ANY PARTICULAR FONT, STYLE, SIZE, OR COLOR.

OWNER OF U.S. REG. NO. 2,242,100.

NO CLAIM IS MADE TO THE EXCLUSIVE RIGHT TO USE GOLF TOURNAMENT, APART FROM THE MARK AS SHOWN.

FOR ENTERTAINMENT IN THE NATURE OF ORGANIZING CELEBRITY GOLF EVENTS (U.S. CLS. 100, 101 AND 107).

FIRST USE 2-4-2005; IN COMMERCE 2-4-2005.

CLASS 41—(Continued).

3,178,132. MILLIONAIRE UNIVERSITY, L.L.C., JACKSONVILLE, FL. SN 78-547,146. PUB. 5-30-2006, FILED 1-13-2005.

**Millionaire
University**

THE MARK CONSISTS OF STANDARD CHARACTERS WITHOUT CLAIM TO ANY PARTICULAR FONT, STYLE, SIZE, OR COLOR.

NO CLAIM IS MADE TO THE EXCLUSIVE RIGHT TO USE UNIVERSITY, APART FROM THE MARK AS SHOWN.

FOR EDUCATIONAL SERVICES, NAMELY PROVIDING CLASSES, WORKSHOPS, AND SEMINARS WHICH PROMOTE BIBLICAL CONCEPTS OF WEALTH ACCUMULATION (U.S. CLS. 100, 101 AND 107).

FIRST USE 1-10-2005; IN COMMERCE 2-1-2006.

3,178,128. RUTH GORDON HOWARD COMPANY LLC, THE, CHARLOTTE, NC. SN 78-544,995. PUB. 5-2-2006, FILED 1-10-2005.

ENERGY GIRLS

THE MARK CONSISTS OF STANDARD CHARACTERS WITHOUT CLAIM TO ANY PARTICULAR FONT, STYLE, SIZE, OR COLOR.

FOR CONDUCTING SEMINARS, WORKSHOPS, CONFERENCES, TRAINING PROGRAMS IN THE FIELD OF LIFE BALANCE ISSUES VIA LIVE PRESENTATIONS AND DISTRIBUTING COURSE MATERIALS IN CONNECTION THEREWITH; CONDUCTING COUNSELING IN THE FIELD OF LIFE BALANCE ISSUES, NAMELY, CAREER COUNSELING (U.S. CLS. 100, 101 AND 107).

FIRST USE 2-1-2006; IN COMMERCE 2-1-2006.

3,178,208. BUDDY MORROW PRODUCTIONS, MAITLAND, FL. SN 78-571,061. PUB. 11-8-2005, FILED 2-18-2005.

**Salute to the
World's Greatest
Generation**

THE MARK CONSISTS OF STANDARD CHARACTERS WITHOUT CLAIM TO ANY PARTICULAR FONT, STYLE, SIZE, OR COLOR.

FOR ENTERTAINMENT SERVICES IN THE NATURE OF MUSICAL PERFORMANCES BY AN ORCHESTRA (U.S. CLS. 100, 101 AND 107).

FIRST USE 11-9-2005; IN COMMERCE 11-9-2005.

CLASS 41—(Continued).

3,178,268. HOUSE OF BLUES BRANDS CORP., HOLLYWOOD, CA. SN 78-584,612. PUB. 11-29-2005, FILED 3-10-2005.

HELP EVER - HURT
NEVER

THE MARK CONSISTS OF STANDARD CHARACTERS WITHOUT CLAIM TO ANY PARTICULAR FONT, STYLE, SIZE, OR COLOR.

OWNER OF U.S. REG. NOS. 1,817,564 AND 1,866,434.
FOR CASINO ENTERTAINMENT SERVICES (U.S. CLS. 100, 101 AND 107).
FIRST USE 7-4-2005; IN COMMERCE 7-4-2005.

3,178,289. HAILEY B, INC., COLD SPRING HARBOR, NY. SN 78-588,577. PUB. 11-29-2005, FILED 3-16-2005.

NURTURING
CREATIVITY

THE MARK CONSISTS OF STANDARD CHARACTERS WITHOUT CLAIM TO ANY PARTICULAR FONT, STYLE, SIZE, OR COLOR.

FOR EDUCATIONAL SERVICES, NAMELY, PROVIDING EDUCATIONAL PROGRAMS AND SPECIAL EVENTS PROGRAMS IN THE AREAS OF ART, MUSIC, SCIENCE, LANGUAGE, AND CULTURAL ENRICHMENT (U.S. CLS. 100, 101 AND 107).
FIRST USE 3-1-2005; IN COMMERCE 3-1-2005.

CLASS 41—(Continued).

3,178,298. ECOLE DE BUDO RAJI INTERNATIONAL, PORTLAND, OR. SN 78-590,252. PUB. 12-13-2005, FILED 3-18-2005.



NO CLAIM IS MADE TO THE EXCLUSIVE RIGHT TO USE "ECOLE DE BUDO" OR "INTERNATIONAL", APART FROM THE MARK AS SHOWN.

THE NAME SHOWN IN THE MARK IDENTIFIES JAFF RAJI, A LIVING INDIVIDUAL WHOSE CONSENT IS OF RECORD.

THE FOREIGN WORDING IN THE MARK TRANSLATES INTO ENGLISH AS SCHOOL OF MARTIAL ARTS.
FOR AIKIDO INSTRUCTION (U.S. CLS. 100, 101 AND 107).
FIRST USE 5-1-2005; IN COMMERCE 5-1-2005.

3,178,322. AMERICAN COMMAND PERFORMANCE, LLC, GROSSE POINTE SHORES, MI. SN 78-594,372. PUB. 12-27-2005, FILED 3-24-2005.



NO CLAIM IS MADE TO THE EXCLUSIVE RIGHT TO USE "WHEELS", APART FROM THE MARK AS SHOWN.

THE MARK CONSISTS OF A CREST, HAVING THE STYLIZED WORDING OPERATION IN AN ARC-SHAPED ORIENTATION NEAR THE TOP EDGE AND THE STYLIZED WORDING WHEELS OF FREEDOM NEAR THE BOTTOM EDGE. THE MARK CONSISTS OF A WHEEL IN THE CENTER OF THE CREST, AND LEAF-LIKE ORNAMENTATION NEAR THE LEFT AND RIGHT EDGES OF THE CREST. THE CREST CONTAINS TWO QUADRILATERAL-LIKE SHAPES TO THE LEFT AND RIGHT OF THE WHEEL, THE LEFT SHAPE HAVING A BORDER WITH MULTIPLE STARS DESCENDING IN SIZE FROM TOP TO BOTTOM.

FOR ENTERTAINMENT SERVICES, NAMELY, ORGANIZING, PRODUCING AND CONDUCTING AUTO SHOWS (U.S. CLS. 100, 101 AND 107).
FIRST USE 2-0-2005; IN COMMERCE 2-0-2005.

CLASS 41—(Continued).

3,178,330. HAYES, TIMOTHY, EAST HAMPTON, NY. SN 78-595,530. PUB. 12-20-2005, FILED 3-25-2005.

**BE A BETTER HUMAN
BE A BETTER HORSE**

THE MARK CONSISTS OF STANDARD CHARACTERS WITHOUT CLAIM TO ANY PARTICULAR FONT, STYLE, SIZE, OR COLOR.

FOR HORSE TRAINING; EDUCATIONAL SERVICES, NAMELY CONDUCTING CLINICS, TUTORIAL SESSIONS, SPEECHES AND LECTURES IN THE FIELD OF HORSEMANSHIP, HORSE HANDLING AND HORSE TRAINING; ENTERTAINMENT SERVICES IN THE NATURE OF HORSEMANSHIP DEMONSTRATIONS (U.S. CLS. 100, 101 AND 107).

FIRST USE 1-1-2002; IN COMMERCE 1-1-2002.

3,178,337. EMMIS RADIO, LLC, INDIANAPOLIS, IN. SN 78-596,550. PUB. 3-21-2006, FILED 3-28-2005.

WHO'S NEXT

THE MARK CONSISTS OF STANDARD CHARACTERS WITHOUT CLAIM TO ANY PARTICULAR FONT, STYLE, SIZE, OR COLOR.

FOR ENTERTAINMENT SERVICES, NAMELY, PROVIDING PRE-RECORDED MUSIC, INFORMATION IN THE FIELD OF MUSIC, AND COMMENTARY AND ARTICLES IN THE FIELD OF MUSIC, ALL VIA AN ONLINE GLOBAL NETWORK (U.S. CLS. 100, 101 AND 107).

FIRST USE 4-1-2005; IN COMMERCE 4-1-2005.

CLASS 41—(Continued).

3,178,339. NEW FRONTIER MEDIA, INC., BOULDER, CO. SN 78-596,795. PUB. 1-3-2006, FILED 3-29-2005.



THE MARK CONSISTS OF STYLIZED LETTERS WITH A STYLIZED STAR BETWEEN THE WORDS.

FOR ENTERTAINMENT SERVICES, NAMELY, TELEVISION, SATELLITE, INTERNET AND CABLE TELEVISION BROADCASTING SERVICES FEATURING ADULT PROGRAMMING (U.S. CLS. 100, 101 AND 107).

FIRST USE 10-31-2005; IN COMMERCE 10-31-2005.

3,178,354. LIONBRIDGE TECHNOLOGIES, INC., WALTHAM, MA. SN 78-599,280. PUB. 12-27-2005, FILED 3-31-2005.

LOGOPORT

THE MARK CONSISTS OF STANDARD CHARACTERS WITHOUT CLAIM TO ANY PARTICULAR FONT, STYLE, SIZE, OR COLOR.

FOR TRANSLATION AND LOCALIZATION SERVICES WHEREBY COMPUTER PROGRAMS AND ACCOMPANYING DOCUMENTATION ARE TRANSLATED FROM ONE SPOKEN LANGUAGE TO ANOTHER AND ADAPTED TO FOREIGN STANDARDS AND USAGE (U.S. CLS. 100, 101 AND 107).

FIRST USE 2-2-2005; IN COMMERCE 2-2-2005.

3,178,359. NEXSTAR, INC., WHITE BEAR LAKE, MN. SN 78-599,997. PUB. 12-27-2005, FILED 4-1-2005.

NEXSTAR NETWORK

THE MARK CONSISTS OF STANDARD CHARACTERS WITHOUT CLAIM TO ANY PARTICULAR FONT, STYLE,

CLASS 41—(Continued).

SIZE, OR COLOR.

OWNER OF U.S. REG. NO. 2,953,607.

NO CLAIM IS MADE TO THE EXCLUSIVE RIGHT TO USE NETWORK, APART FROM THE MARK AS SHOWN.

FOR EDUCATIONAL SERVICES, NAMELY PROVIDING CLASSES, SEMINARS, WORKSHOPS, AND EDUCATIONAL CONFERENCES FOR PLUMBING, ELECTRICAL, HEATING, VENTILATING, AND AIR CONDITIONING SERVICE PROVIDERS (U.S. CLS. 100, 101 AND 107).

FIRST USE 2-19-2006; IN COMMERCE 2-19-2006.

CLASS 41—(Continued).

3,178,367. CR LICENSE, LLC, TUCSON, AZ. SN 78-602,524. PUB. 1-10-2006, FILED 4-5-2005.

CANYON RANCH

THE MARK CONSISTS OF STANDARD CHARACTERS WITHOUT CLAIM TO ANY PARTICULAR FONT, STYLE, SIZE, OR COLOR.

OWNER OF U.S. REG. NOS. 1,350,012, 1,409,026, AND OTHERS.

FOR HEALTH CLUB SERVICES, NAMELY, PROVIDING INSTRUCTION AND EQUIPMENT IN THE FIELD OF PHYSICAL EXERCISE; PHYSICAL EDUCATION SERVICES, NAMELY, PROVIDING EXERCISE CLASSES TO OTHERS AND CONDUCTING CLASSES IN EXERCISE AND PHYSICAL CONDITIONING; EDUCATIONAL SERVICES, NAMELY, CONDUCTING CLASSES, SEMINARS, CONFERENCES, AND WORKSHOPS IN THE FIELDS OF NUTRITION, EXERCISE, PHYSICAL CONDITIONING, CONFLICT MANAGEMENT, FAMILY HEALTH, WELLNESS, PREVENTION OF DISEASE, BEAUTY, SKIN CARE, PHYSICAL FITNESS, PHYSICAL TRAINING, STRESS MANAGEMENT AND BEHAVIOR MODIFICATION; COUNSELING AND CONSULTATION SERVICES IN THE FIELDS OF EXERCISE AND PHYSICAL CONDITIONING, PHYSICAL FITNESS AND PHYSICAL TRAINING (U.S. CLS. 100, 101 AND 107).

FIRST USE 12-31-1979; IN COMMERCE 12-31-1979.

3,178,366. SIERRA HEALTHSTYLES LLC, TUCSON, AZ. SN 78-601,818. PUB. 12-27-2005, FILED 4-5-2005.

**NUTRITION IN
BALANCE**

3,178,387. NATIONAL ASSOCIATION FOR STOCK CAR AUTO RACING, INC., DAYTONA BEACH, FL. SN 78-609,670. PUB. 3-28-2006, FILED 4-15-2005.



THE MARK CONSISTS OF STANDARD CHARACTERS WITHOUT CLAIM TO ANY PARTICULAR FONT, STYLE, SIZE, OR COLOR.

OWNER OF U.S. REG. NOS. 2,114,500 AND 2,114,511.

NO CLAIM IS MADE TO THE EXCLUSIVE RIGHT TO USE "NUTRITION", APART FROM THE MARK AS SHOWN.

FOR CONDUCTING WORKSHOPS, SEMINARS AND LECTURES IN THE FIELDS OF NUTRITION AND COOKING, AND DISTRIBUTING COURSE MATERIAL IN CONNECTION THEREWITH (U.S. CLS. 100, 101 AND 107).

FIRST USE 8-11-2005; IN COMMERCE 8-11-2005.

NO CLAIM IS MADE TO THE EXCLUSIVE RIGHT TO USE "PRESEASON", APART FROM THE MARK AS SHOWN.

FOR ENTERTAINMENT SERVICES IN THE NATURE OF MOTORSPORTS RACING EVENTS, REGULATING, GOVERNING, AND SANCTIONING MOTORSPORTS RACING EVENTS (U.S. CLS. 100, 101 AND 107).

FIRST USE 1-6-2004; IN COMMERCE 1-6-2004.

CLASS 41—(Continued).

3,178,388. PHILLIPS, ROBERT NIGEL, BURBANK, CA. SN 78-610,551. PUB. 1-17-2006, FILED 4-17-2005.

CHOPPERKINGS

THE MARK CONSISTS OF STANDARD CHARACTERS WITHOUT CLAIM TO ANY PARTICULAR FONT, STYLE, SIZE, OR COLOR.

FOR ENTERTAINMENT SERVICES, NAMELY LIVE PERFORMANCES BY A MUSICAL GROUP (U.S. CLS. 100, 101 AND 107).

FIRST USE 11-1-1999; IN COMMERCE 3-1-2006.

3,178,420. BIKETRIP.COM INCORPORATED, ANDOVER, MN. SN 78-623,383. PUB. 4-11-2006, FILED 5-4-2005.

Million Mile Challenge

THE MARK CONSISTS OF STANDARD CHARACTERS WITHOUT CLAIM TO ANY PARTICULAR FONT, STYLE, SIZE, OR COLOR.

NO CLAIM IS MADE TO THE EXCLUSIVE RIGHT TO USE "CHALLENGE", APART FROM THE MARK AS SHOWN.

FOR PHYSICAL FITNESS INSTRUCTION AND CONSULTATION PROGRAMS PROVIDED VIA THE INTERNET FOR ORGANIZATIONS; EDUCATIONAL SERVICES, NAMELY, PROVIDING FITNESS PROGRAMS IN THE FIELD OF WALKING, RUNNING AND BIKING THROUGH DISTANCE TRACKING VIA THE INTERNET FOR ORGANIZATIONS (U.S. CLS. 100, 101 AND 107).

FIRST USE 12-1-2003; IN COMMERCE 8-1-2006.

3,178,426. ROTH I.G.A. FOODLINER, INCORPORATED, SALEM, OR. SN 78-626,545. PUB. 1-31-2006, FILED 5-10-2005.

BLOOMS AND BREWS

THE MARK CONSISTS OF STANDARD CHARACTERS WITHOUT CLAIM TO ANY PARTICULAR FONT, STYLE, SIZE, OR COLOR.

NO CLAIM IS MADE TO THE EXCLUSIVE RIGHT TO USE BREWS, APART FROM THE MARK AS SHOWN.

FOR ENTERTAINMENT SERVICES, NAMELY, ORGANIZING BEER AND ALE FESTIVALS WITH FACILITIES FOR ENTERTAINMENT, GAMES AND REFRESHMENTS (U.S. CLS. 100, 101 AND 107).

FIRST USE 4-28-2005; IN COMMERCE 4-28-2005.

CLASS 41—(Continued).

3,178,431. SONY KABUSHIKI KAISHA, TA SONY CORPORATION, TOKYO, JAPAN. SN 78-628,385. PUB. 1-31-2006, FILED 5-12-2005.



FOR ENTERTAINMENT SERVICES, NAMELY, ARRANGING AND CONDUCTING AUTOMOBILE RACES (U.S. CLS. 100, 101 AND 107).

FIRST USE 4-30-2005; IN COMMERCE 4-30-2005.

3,178,454. DC COMICS, NEW YORK, NY. SN 78-636,990. PUB. 6-6-2006, FILED 5-25-2005.



THE MARK CONSISTS OF THE LETTERS DC ENCIRCLED BY A WHIRLPOOL-LIKE RING WITH A SINGLE STAR.

FOR ENTERTAINMENT SERVICES IN THE NATURE OF LIVE-ACTION, COMEDY, DRAMA AND ANIMATED TELEVISION SERIES; PRODUCTION OF LIVE-ACTION, COMEDY, DRAMA AND ANIMATED TELEVISION SERIES; DISTRIBUTION AND DISPLAY OF LIVE-ACTION, COMEDY, DRAMA AND ANIMATED MOTION PICTURE THEATRICAL FILMS; PRODUCTION OF LIVE-ACTION, COMEDY, DRAMA AND ANIMATED MOTION PICTURE THEATRICAL FILMS; INTERNET SERVICES PROVIDING INFORMATION VIA AN ELECTRONIC GLOBAL COMPUTER NETWORK IN THE FIELD OF ENTERTAINMENT RELATING SPECIFICALLY TO MOVIES, AND TELEVISION; PROVIDING NEWS ABOUT CURRENT EVENTS AND ENTERTAINMENT, AND INFORMATION RELATED TO EDUCATION AND CULTURAL EVENTS, VIA A GLOBAL COMPUTER NETWORK; AND PROVIDING INFORMATION FOR AND ACTUAL ENTERTAINMENT VIA AN ELECTRONIC GLOBAL COMMUNICATIONS NETWORK IN THE NATURE OF LIVE ACTION, COMEDY, DRAMA AND ANIMATED PROGRAMS AND PRODUCTION OF LIVE-ACTION COMEDY, ACTION AND ANIMATED MOTION FILMS FOR DISTRIBUTION VIA A GLOBAL COMPUTER NETWORK (U.S. CLS. 100, 101 AND 107).

FIRST USE 5-0-2005; IN COMMERCE 5-0-2005.

CLASS 41—(Continued).

3,178,456. REDMOND, CYNTHIA, SHOREWOOD, MN. SN 78-638,201. PUB. 2-28-2006, FILED 5-26-2005.

CINDY'S REEL REVIEW

THE MARK CONSISTS OF STANDARD CHARACTERS WITHOUT CLAIM TO ANY PARTICULAR FONT, STYLE, SIZE, OR COLOR.

NO CLAIM IS MADE TO THE EXCLUSIVE RIGHT TO USE "REVIEW", APART FROM THE MARK AS SHOWN.

FOR ENTERTAINMENT SERVICES, NAMELY, AN ONGOING TELEVISION OR VIDEO PROGRAM PROVIDED VIA BROADCAST, CABLE AND OVER THE INTERNET FEATURING CRITICAL REVIEWS OF MOTION PICTURES AND FILMS (U.S. CLS. 100, 101 AND 107).

FIRST USE 4-11-2005; IN COMMERCE 4-11-2005.

3,178,466. YESHIVA UNIVERSITY, NEW YORK, NY. SN 78-641,216. PUB. 5-16-2006, FILED 6-1-2005.

BRING WISDOM TO LIFE

THE MARK CONSISTS OF STANDARD CHARACTERS WITHOUT CLAIM TO ANY PARTICULAR FONT, STYLE, SIZE, OR COLOR.

FOR EDUCATIONAL SERVICES, NAMELY, PROVIDING COURSES OF INSTRUCTION AT THE UNDER-GRADUATE, GRADUATE AND PROFESSIONAL LEVELS AND DISTRIBUTING COURSE MATERIAL IN CONNECTION THEREWITH (U.S. CLS. 100, 101 AND 107).

FIRST USE 6-30-2005; IN COMMERCE 6-30-2005.

3,178,473. REGULAR RICHES LLC, ATLANTA, GA. SN 78-645,563. PUB. 2-28-2006, FILED 6-7-2005.

REGULAR RICHES

THE MARK CONSISTS OF STANDARD CHARACTERS WITHOUT CLAIM TO ANY PARTICULAR FONT, STYLE, SIZE, OR COLOR.

FOR EDUCATIONAL SERVICES, NAMELY CONDUCTING SEMINARS, CONFERENCES AND WORKSHOPS IN THE FIELD OF INVESTMENT STRATEGIES AND WEALTH MANAGEMENT AND DISTRIBUTING COURSE MATERIALS RELATED THERETO VIA PRINTED MATERIALS AND THE INTERNET (U.S. CLS. 100, 101 AND 107).

FIRST USE 3-0-2006; IN COMMERCE 3-0-2006.

CLASS 41—(Continued).

3,178,511. PROFESSIONAL EDUCATION INTERNATIONAL, INC., CHICAGO, IL. SN 78-659,825. PUB. 3-14-2006, FILED 6-28-2005.

WiMAX GLOBAL COMFORUM

THE MARK CONSISTS OF STANDARD CHARACTERS WITHOUT CLAIM TO ANY PARTICULAR FONT, STYLE, SIZE, OR COLOR.

OWNER OF U.S. REG. NOS. 1,473,566 AND 2,623,532.

NO CLAIM IS MADE TO THE EXCLUSIVE RIGHT TO USE "WIMAX GLOBAL", APART FROM THE MARK AS SHOWN.

FOR EDUCATION SERVICES, NAMELY, CONDUCTING WORKSHOPS AND SEMINARS IN THE FIELDS OF TELECOMMUNICATIONS, WIRELESS COMMUNICATIONS AND INFORMATION TECHNOLOGY INDUSTRIES AND DISTRIBUTING MATERIALS IN CONNECTION THEREWITH, NAMELY, BOOKS, PAMPHLETS AND THE LIKE (U.S. CLS. 100, 101 AND 107).

FIRST USE 6-5-2005; IN COMMERCE 6-5-2005.

3,178,518. GROUP FITNESS USA, LLC, GAITHERSBURG, MD. SN 78-661,566. PUB. 3-14-2006, FILED 6-30-2005.

DANCEX

THE MARK CONSISTS OF STANDARD CHARACTERS WITHOUT CLAIM TO ANY PARTICULAR FONT, STYLE, SIZE, OR COLOR.

FOR PHYSICAL FITNESS INSTRUCTION; PHYSICAL FITNESS CONSULTATION; DANCE INSTRUCTION; PERSONAL MOTIVATION THROUGH PHYSICAL FITNESS INSTRUCTION SERVICES (U.S. CLS. 100, 101 AND 107).

FIRST USE 12-17-2004; IN COMMERCE 12-17-2004.

3,178,525. PAIS, JOSH, NEW YORK, NY. SN 78-664,620. PUB. 3-21-2006, FILED 7-6-2005.

COMMITTED IMPULSE

THE MARK CONSISTS OF STANDARD CHARACTERS WITHOUT CLAIM TO ANY PARTICULAR FONT, STYLE, SIZE, OR COLOR.

FOR PROVIDING TRAINING AND TEACHING SERVICES FOR ACTORS THROUGH AN ACTING TECHNIQUE (U.S. CLS. 100, 101 AND 107).

FIRST USE 9-0-2005; IN COMMERCE 9-0-2005.

CLASS 41—(Continued).

3,178,538. FFTOOLBOX.COM LLC, FAIRFAX, VA. SN 78-669,027. PUB. 4-25-2006, FILED 7-12-2005.

Fantasy Football Toolbox

THE MARK CONSISTS OF STANDARD CHARACTERS WITHOUT CLAIM TO ANY PARTICULAR FONT, STYLE, SIZE, OR COLOR.

NO CLAIM IS MADE TO THE EXCLUSIVE RIGHT TO USE "FANTASY FOOTBALL", APART FROM THE MARK AS SHOWN.

FOR PROVIDING ON-LINE NEWS AND INFORMATION AND ARTICLES IN THE FIELDS OF SPORT FANTASY GAMES, SPORTS FIGURES, ATHLETES, SPORTS EVENTS, PLAYER RANKINGS, ADVICE ON SELECTING PLAYERS FOR A FANTASY TEAM AND GENERAL FANTASY SPORTS AND FANTASY GAMES TIPS (U.S. CLS. 100, 101 AND 107).

FIRST USE 8-14-2000; IN COMMERCE 8-14-2000.

3,178,541. HEALTH AND WELLNESS PARTNERS L.L.C., RAMSEY, NJ. SN 78-672,123. PUB. 5-30-2006, FILED 7-18-2005.

HWP

THE MARK CONSISTS OF STANDARD CHARACTERS WITHOUT CLAIM TO ANY PARTICULAR FONT, STYLE, SIZE, OR COLOR.

FOR MEDICAL EDUCATION SERVICES, NAMELY, PROVIDING COURSES OF INSTRUCTION, SEMINARS, SYMPOSIUMS, ADVISORY BOARDS, AND TRAINING SESSIONS IN THE FIELD OF HEALTH CARE TO PHYSICIANS, PHARMACEUTICAL COMPANIES, AND THE GENERAL PUBLIC (U.S. CLS. 100, 101 AND 107).

FIRST USE 9-0-2005; IN COMMERCE 9-0-2005.

CLASS 41—(Continued).

3,178,590. TELEVISA, S.A. DE C.V., MEXICO, D.F., MEXICO. SN 78-700,807. PUB. 5-16-2006, FILED 8-25-2005.

OTRO ROLLO

THE MARK CONSISTS OF STANDARD CHARACTERS WITHOUT CLAIM TO ANY PARTICULAR FONT, STYLE, SIZE, OR COLOR.

THE ENGLISH TRANSLATION OF OTRO ROLLO IS OTHER ROLL.

FOR ENTERTAINMENT SERVICES, NAMELY, AN ONGOING VARIETY TELEVISION PROGRAM (U.S. CLS. 100, 101 AND 107).

FIRST USE 2-21-1999; IN COMMERCE 5-4-1999.

3,178,600. CITY OF PALMDALE, PALMDALE, CA. SN 78-705,635. PUB. 5-16-2006, FILED 9-1-2005.

BEST OF THE WEST

THE MARK CONSISTS OF STANDARD CHARACTERS WITHOUT CLAIM TO ANY PARTICULAR FONT, STYLE, SIZE, OR COLOR.

FOR ENTERTAINMENT SERVICES, NAMELY, ORGANIZING AND PROVIDING FACILITIES FOR SOFTBALL GAMES AND SPORTS ACTIVITIES (U.S. CLS. 100, 101 AND 107).

FIRST USE 6-24-2006; IN COMMERCE 8-5-2006.

3,178,614. XM SATELLITE RADIO INC., WASHINGTON, DC. SN 78-712,464. PUB. 6-6-2006, FILED 9-14-2005.

CLASSICAL CONFIDENTIAL

THE MARK CONSISTS OF STANDARD CHARACTERS WITHOUT CLAIM TO ANY PARTICULAR FONT, STYLE, SIZE, OR COLOR.

NO CLAIM IS MADE TO THE EXCLUSIVE RIGHT TO USE "CLASSICAL", APART FROM THE MARK AS SHOWN.

FOR ENTERTAINMENT SERVICES, NAMELY AN ONGOING SATELLITE RADIO PROGRAM FEATURING CELEBRITY INTERVIEWS (U.S. CLS. 100, 101 AND 107).

FIRST USE 12-7-2005; IN COMMERCE 12-7-2005.

CLASS 41—(Continued).

3,178,623. MAGUIRE, JERROD J., PHOENIX, AZ. SN 78-715,508. PUB. 6-6-2006, FILED 9-19-2005.

StrengthLab

THE MARK CONSISTS OF STANDARD CHARACTERS WITHOUT CLAIM TO ANY PARTICULAR FONT, STYLE, SIZE, OR COLOR.

FOR ONE-ON-ONE PERSONAL TRAINING FOR THE PURPOSE OF HEALTH AND FITNESS (U.S. CLS. 100, 101 AND 107).

FIRST USE 9-1-2005; IN COMMERCE 9-1-2005.

3,178,624. SEVAN SOFTWARE, INC., LA CRESCENTA, CA. SN 78-715,588. PUB. 6-6-2006, FILED 9-19-2005.



THE COLOR(S) RED, BLACK IS/ARE CLAIMED AS A FEATURE OF THE MARK.

THE MARK CONSISTS OF A TICKET ICON WITH A DROP-SHADOW BELOW IT ON THE LEFT SIDE OF THE LOGO, IN RED. THE MAIN KEYWORD "ITSMYSEAT.COM" IS ALSO IN RED, FOLLOWED BY THE SLOGAN IN BLACK, BELOW THE MAIN NAME.

FOR ARRANGING FOR TICKET RESERVATIONS FOR SHOWS AND OTHER ENTERTAINMENT EVENTS; BOOKING OF SEATS FOR SHOWS AND BOOKING OF THEATRE TICKETS; PROVIDING WILL-CALL TICKET SERVICES (U.S. CLS. 100, 101 AND 107).

FIRST USE 9-18-2005; IN COMMERCE 5-1-2006.

CLASS 42—SCIENTIFIC, COMPUTER AND LEGAL SERVICES

CLASS 42—(Continued).

3,177,326. ACEITUNO, JAVIER MIGUEL, 24049 VERDELLO (BG), ITALY. SN 75-782,352. PUB. 3-1-2005, FILED 8-23-1999.

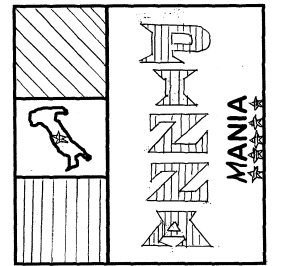

ITALIA

NO CLAIM IS MADE TO THE EXCLUSIVE RIGHT TO USE "PIZZA" AND "ITALIA", APART FROM THE MARK AS SHOWN.

THE MARK IS LINED FOR THE COLORS GREEN, WHITE, RED, BLACK. THE LINING SHOWN IN THE DRAWING IS A FEATURE OF THE MARK.

THE MARK CONSISTS OF A DESIGN WITH THE WORDS PIZZA MANIA ITALIA, PIZZA MANIA WRITTEN ON THE RIGHT PART (WITH FIVE STARS UNDER THE WORD MANIA), ITALIA WRITTEN UNDERNEATH THE LOGO, AND WITH THREE CUBES (COLORS GREEN, WHITE, RED) ON THE LEFT PART OF THE DESIGN WITH THE PROFILE OF THE ITALIAN TERRITORY IN THE WHITE CUBE, ALL ENCLOSED IN BLACK AND WITH AN AWARD DESIGN.

THE ENGLISH TRANSLATION OF THE WORD "ITALIA" IS "ITALY".

FOR RESTAURANT SERVICES (U.S. CLS. 100 AND 101).

FIRST USE 8-31-2006; IN COMMERCE 8-31-2006.

3,177,463. ABRW ASSOCIATES, INC., SAN DIEGO, CA. SN 76-605,985. PUB. 12-20-2005, FILED 8-5-2004.

CertTECH

FOR TESTING, ANALYSIS AND EVALUATION OF OTHERS FOR THE PURPOSE OF CERTIFICATION, NAMELY, THE ASSESSMENT OF A CONTRACTOR'S BUSINESS STRATEGY BASED ON ITS MARKETING PROFILE, ORGANIZATION AND OPERATIONS (U.S. CLS. 100 AND 101).

FIRST USE 8-5-2004; IN COMMERCE 8-5-2004.

CLASS 42—(Continued).

3,177,470. MACCONOCHIE, KATHARINE, DBA KATBOX PRODUCTIONS, BROOMFIELD, CO. SN 76-608,798. PUB. 12-20-2005, FILED 8-23-2004.

KATZGRAFIX

THE MARK CONSISTS OF STANDARD CHARACTERS WITHOUT CLAIM TO ANY PARTICULAR FONT, STYLE, SIZE, OR COLOR.

FOR ART DIRECTION IN THE FIELD OF GRAPHIC ILLUSTRATION AND COMMERCIAL ART DESIGN FOR OTHERS; GRAPHIC ART DESIGN, PACKAGE DESIGNING FOR OTHERS; DESIGNING NEW PRODUCTS FOR OTHERS (U.S. CLS. 100 AND 101).

FIRST USE 0-0-1999; IN COMMERCE 0-0-1999.

3,177,532. AUTOMATED DATA SOLUTIONS, LLC, FLOR-
ENCE, KY. SN 76-627,231. PUB. 12-6-2005, FILED 1-6-2005.

DATAMAXX

THE MARK CONSISTS OF STANDARD CHARACTERS WITHOUT CLAIM TO ANY PARTICULAR FONT, STYLE, SIZE, OR COLOR.

FOR COMPUTER PROJECT MANAGEMENT SERVICES DIRECTED TO MULTIPLE USERS IN CONSTRUCTION, INDUSTRIAL, AND INSTITUTIONAL FIELDS VIA A GLOBAL INFORMATION NETWORK (U.S. CLS. 100 AND 101).

FIRST USE 2-25-2005; IN COMMERCE 2-25-2005.

3,177,594. SAGEMETRICS CORPORATION, N. HOLLY-
WOOD, CA. SN 78-043,347. PUB. 6-21-2005, FILED 1-16-
2001.

SAGEANALYST

FOR COMPUTER SOFTWARE APPLICATION SERVICES, NAMELY ANALYZING ONLINE AND OFFLINE DATA FOR BUSINESS INTELLIGENCE PURPOSES (U.S. CLS. 100 AND 101).

FIRST USE 1-1-2001; IN COMMERCE 1-1-2001.

CLASS 42—(Continued).

3,177,774. NICK MILLER, INC., PALM BEACH GARDENS,
FL. SN 78-385,953. PUB. 7-19-2005, FILED 3-17-2004.

Bringing Order to Chaos

THE MARK CONSISTS OF STANDARD CHARACTERS WITHOUT CLAIM TO ANY PARTICULAR FONT, STYLE, SIZE, OR COLOR.

FOR LAND SURVEYING, MAPPING, AND CONSULTING SERVICES IN THE FIELDS OF LAND ACQUISITION, LAND MANAGEMENT, GEOGRAPHICAL INFORMATION SERVICES, AND SPATIAL SCIENCES; PROVIDING TEMPORARY USE OF NON-DOWNLOADABLE WEB-BASED COMPUTER SOFTWARE FOR THE ELECTRONIC MANAGEMENT OF DATA IN THE FIELDS OF LAND ACQUISITION, LAND MANAGEMENT, GEOGRAPHICAL INFORMATION SERVICES, AND SPATIAL SCIENCES (U.S. CLS. 100 AND 101).

FIRST USE 7-7-2003; IN COMMERCE 7-7-2003.

3,177,782. MONTCLAIR CONSULTING GROUP, LLC, MON-
TCLAIR, NJ. SN 78-387,850. PUB. 12-20-2005, FILED 3-19-
2004.



THE COLOR(S) DARK GREEN, LIGHT GREEN IS/ARE CLAIMED AS A FEATURE OF THE MARK.

THE ENTIRE MARK IS THE COLOR GREEN.

THE MARK CONSISTS OF TWO LINES THAT LOOK LIKE PARTS OF TWO MOUNTAINS; THEY ALSO LOOK LIKE TWO DRUMSTICKS OR A PAIR OF CHOPSTICKS.

FOR PROVIDING TEMPORARY USE OF ONLINE NON-DOWNLOADABLE SOFTWARE FOR USE IN DATABASE MANAGEMENT FOR DIRECT MARKETING AND SALES; CONSULTING SERVICES IN THE FIELD OF DESIGN, SELECTION, IMPLEMENTATION AND USE OF COMPUTER HARDWARE AND SOFTWARE SYSTEMS FOR OTHERS (U.S. CLS. 100 AND 101).

FIRST USE 2-21-2004; IN COMMERCE 2-21-2004.

CLASS 42—(Continued).

3,177,811. VERTAFORE, INC., FORMERLY AMS SERVICES, INC., WINDSOR, CT. SN 78-402,956. PUB. 9-13-2005, FILED 4-16-2004.



FOR PROVIDING TEMPORARY USE OF ONLINE NON-DOWNLOADABLE COMPUTER SOFTWARE FOR DATABASE MANAGEMENT, FOR APPLICATION AND DATABASE INTEGRATION, FOR CREATING SEARCHABLE DATABASES OF INFORMATION AND DATA, FOR THE COLLECTION, EDITING, ORGANIZING, MODIFYING, TRANSMISSION, STORAGE, RECEIVING, AND SHARING OF DATA AND INFORMATION, FOR OBTAINING REAL-TIME QUOTES AND INFORMATION, AND FOR POLICY SUBMISSION AND ISSUANCE, ALL IN THE FIELD OF INSURANCE (U.S. CLS. 100 AND 101).

FIRST USE 9-0-2004; IN COMMERCE 9-0-2004.

3,177,849. NITROMED, INC., LEXINGTON, MA. SN 78-428,719. PUB. 11-8-2005, FILED 6-2-2004.



OWNER OF U.S. REG. NO. 2,631,849.
FOR PHARMACEUTICAL RESEARCH AND DEVELOPMENT SERVICES (U.S. CLS. 100 AND 101).
FIRST USE 7-0-2004; IN COMMERCE 7-0-2004.

CLASS 42—(Continued).

3,177,859. TAKENET, LLC, NEW YORK, NY. SN 78-435,662. PUB. 5-24-2005, FILED 6-15-2004.

LokoMix

THE MARK CONSISTS OF STANDARD CHARACTERS WITHOUT CLAIM TO ANY PARTICULAR FONT, STYLE, SIZE, OR COLOR.

FOR APPLICATION SERVICE PROVIDER (ASP) FEATURING SOFTWARE FOR DOWNLOAD TO MOBILE DEVICES IN THE FIELD OF MUSICAL SOUND RECORDINGS, VIDEO RECORDINGS AND IMAGES (U.S. CLS. 100 AND 101).

FIRST USE 6-1-2005; IN COMMERCE 6-1-2006.

3,177,876. RESEARCH THINK TANK, INC., ALPHARETTA, GA. SN 78-441,269. PUB. 11-29-2005, FILED 6-25-2004.

GENETANKER

THE MARK CONSISTS OF STANDARD CHARACTERS WITHOUT CLAIM TO ANY PARTICULAR FONT, STYLE, SIZE, OR COLOR.

FOR BIOLOGICAL RESEARCH AND CLINICAL TESTING SERVICES (U.S. CLS. 100 AND 101).

FIRST USE 4-24-2004; IN COMMERCE 6-22-2004.

CLASS 42—(Continued).

3,177,880. MCLEODUSA HOLDINGS, INC., CEDAR RAPIDS, IA. SN 78-443,200. PUB. 10-4-2005, FILED 6-29-2004.

CLASS 42—(Continued).

3,177,985. AC NIELSEN (US), INC., SCHAUMBURG, IL. SN 78-477,074. PUB. 9-13-2005, FILED 9-1-2004.

**ANSWERS
INTERACTIVE**

**PREFERRED
ADVANTAGE**

THE MARK CONSISTS OF STANDARD CHARACTERS WITHOUT CLAIM TO ANY PARTICULAR FONT, STYLE, SIZE, OR COLOR.

NO CLAIM IS MADE TO THE EXCLUSIVE RIGHT TO USE INTERACTIVE, APART FROM THE MARK AS SHOWN.

FOR PROVIDING TEMPORARY USE OF ON-LINE NON-DOWNLOADABLE COMPUTER SOFTWARE FOR CREATING, ACCESSING, UPDATING, DOWNLOADING, VIEWING AND MANIPULATING INFORMATION FROM COMPUTER DATABASES VIA A GLOBAL COMPUTER NETWORK, DIAL-UP COMPUTER, OR OTHER COMPUTER NETWORK, IN THE MARKET RESEARCH, ADVERTISING AND MARKETING INFORMATION FIELDS (U.S. CLS. 100 AND 101).

FIRST USE 10-31-2005; IN COMMERCE 10-31-2005.

THE MARK CONSISTS OF STANDARD CHARACTERS WITHOUT CLAIM TO ANY PARTICULAR FONT, STYLE, SIZE, OR COLOR.

OWNER OF U.S. REG. NOS. 2,817,177 AND 2,902,483.

NO CLAIM IS MADE TO THE EXCLUSIVE RIGHT TO USE "PREFERRED", APART FROM THE MARK AS SHOWN.

FOR COMPUTER CONSULTATION SERVICES IN THE NATURE OF OFFERING TECHNICAL ASSISTANCE RELATING TO THE IMPLEMENTATION, INTEGRATION, CONDUCT AND MAINTENANCE OF WEB SITES IN ELECTRONIC COMMERCE ACTIVITIES; CREATING, IMPLEMENTING, HOSTING, TECHNICAL MONITORING AND MAINTAINING; APPLICATION SERVICE PROVIDER (ASP) NAMELY, HOSTING COMPUTER APPLICATIONS OF OTHERS; DISPLAYING THE WEB SITES AND IMAGES OF OTHERS ON A COMPUTER SERVER; HOSTING THE WEB SITES OF OTHERS ON A COMPUTER SERVER FOR A GLOBAL COMPUTER NETWORK; COMPUTER SERVICES, NAMELY, MANAGING WEB SITES FOR OTHERS; COMPUTER SERVICES, NAMELY, REDIRECTING ELECTRONIC MAIL TO CHANGED PERSONAL ELECTRONIC ADDRESSES; COMPUTER SERVICES, NAMELY, FILTERING UNWANTED E-MAILS; REGISTRATION OF DOMAIN NAMES FOR IDENTIFICATION OF THE USERS ON A GLOBAL COMPUTER NETWORK (U.S. CLS. 100 AND 101).

FIRST USE 7-1-2004; IN COMMERCE 7-1-2004.

3,178,014. POWER WELL SERVICES, INC., HOUSTON, TX. SN 78-489,406. PUB. 12-13-2005, FILED 9-24-2004.

**PowerWell
SERVICES**

NO CLAIM IS MADE TO THE EXCLUSIVE RIGHT TO USE "SERVICES", APART FROM THE MARK AS SHOWN.

FOR OIL AND GAS SURFACE WELL TESTING SERVICES (U.S. CLS. 100 AND 101).

FIRST USE 7-0-2004; IN COMMERCE 7-0-2004.

CLASS 42—(Continued).

3,178,053. STATISTICAL ANALYSIS INC., RIVERSIDE, CA.
SN 78-508,716. PUB. 4-11-2006, FILED 10-29-2004.



THE COLOR(S) BLACK AND BLUE IS/ARE CLAIMED AS A FEATURE OF THE MARK.

THE MARK CONSISTS OF A BELL CURVE AND THE WORDING SAI. THE COLOR BLACK APPEARS IN THE OUTLINE OF THE BELL CURVE AND IN HORIZONTAL LINES WITHIN THE CURVE; THE COLOR BLUE APPEARS WITHIN THE BELL CURVE AND IN THE LETTERING SAI.

FOR LITIGATION CONSULTANCY (U.S. CLS. 100 AND 101).

FIRST USE 12-31-2003; IN COMMERCE 12-31-2003.

3,178,064. MENDIVE, SUSIE, NEW YORK, NY. SN 78-514,038.
PUB. 11-29-2005, FILED 11-9-2004.

**DESIGN FOR EVERY
DIMENSION**

THE MARK CONSISTS OF STANDARD CHARACTERS WITHOUT CLAIM TO ANY PARTICULAR FONT, STYLE, SIZE, OR COLOR.

NO CLAIM IS MADE TO THE EXCLUSIVE RIGHT TO USE "DESIGN", APART FROM THE MARK AS SHOWN.

FOR DESIGN SERVICES FOR OTHERS IN THE FIELDS OF TEXTILES, PAPER GOODS, AND ACCESSORIES FOR HOME LIVING, ENTERTAINING, SLEEPING, BATHING, WORKING, PLAYING AND FASHION (U.S. CLS. 100 AND 101).

FIRST USE 10-31-2005; IN COMMERCE 10-31-2005.

CLASS 42—(Continued).

3,178,079. PAGET GROUP, INC., THE, MADISON, WI. SN 78-522,433. PUB. 2-7-2006, FILED 11-24-2004.

Home Highlights

THE MARK CONSISTS OF STANDARD CHARACTERS WITHOUT CLAIM TO ANY PARTICULAR FONT, STYLE, SIZE, OR COLOR.

NO CLAIM IS MADE TO THE EXCLUSIVE RIGHT TO USE "HOME", APART FROM THE MARK AS SHOWN.

FOR INTERIOR AND EXTERIOR HOME DECORATING SERVICES FOR THE PURPOSE OF STAGING A HOME FOR SALE (U.S. CLS. 100 AND 101).

FIRST USE 11-12-2004; IN COMMERCE 3-2-2005.

3,178,085. CIPHER INTEGRATIONS, INC., LAKELAND, FL.
SN 78-526,649. PUB. 3-21-2006, FILED 12-3-2004.

**CIPHER
INTEGRATIONS**

THE MARK CONSISTS OF STANDARD CHARACTERS WITHOUT CLAIM TO ANY PARTICULAR FONT, STYLE, SIZE, OR COLOR.

NO CLAIM IS MADE TO THE EXCLUSIVE RIGHT TO USE "INTEGRATIONS", APART FROM THE MARK AS SHOWN.

FOR DESIGN, DEVELOPMENT AND IMPLEMENTATION OF SOFTWARE; COMPUTER NETWORK DESIGN FOR OTHERS; CUSTOM COMPUTER PROGRAM FOR OTHERS; DESIGN OF HOMEPAGES AND WEBSITES (U.S. CLS. 100 AND 101).

FIRST USE 12-31-2004; IN COMMERCE 12-31-2004.

CLASS 42—(Continued).

3,178,094. DISCOVERY RESEARCH GROUP OF UTAH, INC., SALT LAKE CITY, UT. SN 78-529,881. PUB. 11-29-2005, FILED 12-9-2004.

COMPASSVISION

THE MARK CONSISTS OF STANDARD CHARACTERS WITHOUT CLAIM TO ANY PARTICULAR FONT, STYLE, SIZE, OR COLOR.

FOR ONLINE SERVICES, NAMELY, COMPUTERIZED ONLINE DATA AUTOMATION AND COLLECTION SERVICES USING PROPRIETARY SOFTWARE TO EVALUATE, ANALYZE, COLLECT, AND REPORT DATA, AND PROVIDING ONLINE NON-DOWNLOADABLE SOFTWARE FOR USE IN REAL-TIME DATA REPORTING (U.S. CLS. 100 AND 101).

FIRST USE 1-19-2005; IN COMMERCE 1-19-2005.

3,178,112. OBLON, SPIVAK, MCCLELLAND, MAIER & NEUSTADT, P.C., ALEXANDRIA, VA. SN 78-536,967. PUB. 12-20-2005, FILED 12-22-2004.

ALWAYS ON YOUR IP SHORT LIST.

THE MARK CONSISTS OF STANDARD CHARACTERS WITHOUT CLAIM TO ANY PARTICULAR FONT, STYLE, SIZE, OR COLOR.

FOR LEGAL SERVICES; PROVIDING INFORMATION RELATING TO LEGAL AFFAIRS IN THE FIELD OF INTELLECTUAL PROPERTY LAW BY MEANS OF THE INTERNET (U.S. CLS. 100 AND 101).

FIRST USE 2-28-2005; IN COMMERCE 2-28-2005.

CLASS 42—(Continued).

3,178,196. MARK ROBERT BEESON, MANHATTAN BEACH, CA. SN 78-568,596. PUB. 11-15-2005, FILED 2-16-2005.



THE COLOR(S) GRAY AND GREEN IS/ARE CLAIMED AS A FEATURE OF THE MARK.

THE MARK CONSISTS OF A STYLIZED LOGO CONSISTING OF A GREEN EXCLAMATION POINT REPLACING THE L IN HELUNA. THE MARK APPEARS IN GRAY WITH THE EXCLAMATION POINT REPRESENTING THE LETTER "L" IN GREEN.

THE ENGLISH TRANSLATION OF HELUNA IS "COUNT" OR "NUMBER."

FOR COMPUTER SERVICES, NAMELY, FILTERING OF UNWANTED E-MAILS (U.S. CLS. 100 AND 101).

FIRST USE 5-1-2005; IN COMMERCE 5-1-2005.

3,178,243. CAVANAUGH, ROBERT M., MORGANTON, NC. SN 78-578,174. PUB. 12-27-2005, FILED 3-2-2005.

KeyDecisions

THE MARK CONSISTS OF STANDARD CHARACTERS WITHOUT CLAIM TO ANY PARTICULAR FONT, STYLE, SIZE, OR COLOR.

FOR CONSULTING SERVICES IN THE FIELD OF SOFTWARE AUTHORING AND GRAPHIC ART DESIGN PERTAINING TO THE DESIGN, CREATION, AND MAINTENANCE OF WEB BASED INTERNET SITES (U.S. CLS. 100 AND 101).

FIRST USE 1-1-1997; IN COMMERCE 1-1-1998.

CLASS 42—(Continued).

3,178,250. COMPUTER SCIENCES CORPORATION, EL SEGUNDO, CA. SN 78-579,859. PUB. 3-14-2006, FILED 3-3-2005.

CLASS 42—(Continued).

3,178,297. ECONTINUUM LLC, MINNEAPOLIS, MN. SN 78-589,871. PUB. 12-6-2005, FILED 3-17-2005.

SECURITYSIGHT

THE MARK CONSISTS OF STANDARD CHARACTERS WITHOUT CLAIM TO ANY PARTICULAR FONT, STYLE, SIZE, OR COLOR.

FOR COMPUTER PROGRAMMING FOR OTHERS; COMPUTER PROGRAM INTEGRATION SERVICES, NAMELY, IMPLEMENTATION OF INTERNET-BASED SECURITY SYSTEMS THAT FACILITATE THE MONITORING AND OVERSIGHT OF BUSINESS ENTERPRISE COMPUTER SYSTEMS BY THE SYSTEM OWNER OR OPERATOR (U.S. CLS. 100 AND 101).

FIRST USE 2-1-2005; IN COMMERCE 2-1-2005.

OVERTURE

THE MARK CONSISTS OF STANDARD CHARACTERS WITHOUT CLAIM TO ANY PARTICULAR FONT, STYLE, SIZE, OR COLOR.

FOR PROVIDING TEMPORARY USE OF ON-LINE, NON-DOWNLOADABLE COMPUTER PROGRAMS FOR USE IN APPLICANT TRACKING AND REVIEWING AND RANKING THE QUALIFICATIONS OF JOB APPLICANTS AND POTENTIAL EMPLOYEES (U.S. CLS. 100 AND 101).

FIRST USE 8-1-2005; IN COMMERCE 8-1-2005.

3,178,295. EMPRESA NACIONAL DE INFORMATICA AUTOMATIZACION Y CONTROL, C.A. – ENIAC, C.A., CARACAS, VENEZUELA. SN 78-589,507. PUB. 12-13-2005, FILED 3-17-2005.

3,178,308. BARROWS, JENNIFER T, AVON, CT. SN 78-591,874. PUB. 12-27-2005, FILED 3-21-2005.

XOPANTECH

THE MARK CONSISTS OF STANDARD CHARACTERS WITHOUT CLAIM TO ANY PARTICULAR FONT, STYLE, SIZE, OR COLOR.

FOR COMPUTER CONSULTATION; TECHNICAL SUPPORT SERVICES, NAMELY, TROUBLESHOOTING OF COMPUTER HARDWARE AND SOFTWARE PROBLEMS (U.S. CLS. 100 AND 101).

FIRST USE 5-19-2003; IN COMMERCE 5-19-2003.

StagingWorks

THE MARK CONSISTS OF STANDARD CHARACTERS WITHOUT CLAIM TO ANY PARTICULAR FONT, STYLE, SIZE, OR COLOR.

FOR PROVIDING DESIGN CONSULTATION RELATING TO THE INTERIORS OF HOMES SO AS TO SHOW-CASE THEM AS THEY GO ON THE MARKET (U.S. CLS. 100 AND 101).

FIRST USE 6-10-2005; IN COMMERCE 6-10-2005.

CLASS 42—(Continued).

3,178,379. ANTOINETTE G. GIUGLIANO, P.C., LYNN-FIELD, MA. SN 78-604,573. PUB. 1-17-2006, FILED 4-8-2005.

INNOVATION
TECHNOLOGY
PROTECT IT

THE MARK CONSISTS OF STANDARD CHARACTERS WITHOUT CLAIM TO ANY PARTICULAR FONT, STYLE, SIZE, OR COLOR.

FOR LEGAL SERVICES, NAMELY, INTELLECTUAL PROPERTY ADVICE; DRAFTING AND PROSECUTING PATENT AND TRADEMARK APPLICATIONS AND COPYRIGHT REGISTRATIONS (U.S. CLS. 100 AND 101).
FIRST USE 9-1-2006; IN COMMERCE 9-1-2006.

CLASS 42—(Continued).

3,178,417. EMPIRICAL LABORATORIES, LLC, DAYTONA BEACH, FL. SN 78-622,090. PUB. 5-16-2006, FILED 5-4-2005.

Empirical Laboratories

THE MARK CONSISTS OF STANDARD CHARACTERS WITHOUT CLAIM TO ANY PARTICULAR FONT, STYLE, SIZE, OR COLOR.

NO CLAIM IS MADE TO THE EXCLUSIVE RIGHT TO USE "LABORATORIES", APART FROM THE MARK AS SHOWN.

FOR ENVIRONMENTAL LABORATORIES FOR THE TESTING OF DRINKING WATER, WASTEWATER, GROUNDWATER, SOILS, SLUDGE, AND SEDIMENTS (U.S. CLS. 100 AND 101).

FIRST USE 10-1-2005; IN COMMERCE 10-1-2005.

3,178,409. KEMSLEY, SANDRA G., BLOOMFIELD HILLS, MI. SN 78-619,694. PUB. 4-18-2006, FILED 4-29-2005.

ABCTOOLS

THE MARK CONSISTS OF STANDARD CHARACTERS WITHOUT CLAIM TO ANY PARTICULAR FONT, STYLE, SIZE, OR COLOR.

OWNER OF U.S. REG. NO. 2,763,217.
FOR PROVIDING TEMPORARY USE OF ONLINE, NON-DOWNLOADABLE INTERACTIVE SOFTWARE FOR GENERATING TAILORED EDUCATIONAL MATERIALS IN THE FIELDS OF PRIMARY AND MIDDLE-SCHOOL EDUCATION AND LANGUAGE INSTRUCTION (U.S. CLS. 100 AND 101).
FIRST USE 11-23-2004; IN COMMERCE 11-23-2004.

3,178,491. TRANSFUTURE WEB DESIGN & MULTIMEDIA, LLC, DOBBS FERRY, NY. SN 78-652,553. PUB. 3-14-2006, FILED 6-16-2005.

TRANSFUTURE

THE MARK CONSISTS OF STANDARD CHARACTERS WITHOUT CLAIM TO ANY PARTICULAR FONT, STYLE, SIZE, OR COLOR.

FOR DESIGN OF HOMEPAGES AND WEB-SITES (U.S. CLS. 100 AND 101).
FIRST USE 1-1-2002; IN COMMERCE 1-1-2002.

CLASS 42—(Continued).

3,178,519. FRESINIUS MEDICAL CARE HOLDINGS, INC., LEXINGTON, MA. SN 78-661,764. PUB. 3-21-2006, FILED 6-30-2005.



THE COLOR(S) BLUE AND RED IS/ARE CLAIMED AS A FEATURE OF THE MARK.

THE MARK CONSISTS OF AN UPPER DESIGN ELEMENT IN BLUE AND A LOWER DESIGN ELEMENT IN RED.

FOR MEDICAL LABORATORY SERVICES (U.S. CLS. 100 AND 101).

FIRST USE 7-14-2005; IN COMMERCE 7-14-2005.

3,178,645. HEALTHPROLINK, INC., BELLEVUE, WA. SN 78-731,773. PUB. 6-20-2006, FILED 10-12-2005.

AMPLIFI

THE MARK CONSISTS OF STANDARD CHARACTERS WITHOUT CLAIM TO ANY PARTICULAR FONT, STYLE, SIZE, OR COLOR.

FOR PROVIDING ONLINE NON-DOWNLOADABLE DATABASE MANAGEMENT SOFTWARE FOR USE BY HEALTH CARE PROFESSIONALS TO ASSIST IN CLINICAL AND MANAGEMENT DECISIONMAKING (U.S. CLS. 100 AND 101).

FIRST USE 12-3-2005; IN COMMERCE 12-3-2005.

CLASS 43—HOTEL AND RESTAURANT SERVICES

3,177,382. TRAVEL PLANNERS, INC., NEW YORK, NY. SN 76-510,167. PUB. 1-6-2004, FILED 4-28-2003.

MYHOTELREPORTS.COM

FOR PROVIDING INFORMATION ABOUT HOTELS AND HOTEL RESERVATIONS VIA THE GLOBAL COMPUTER NETWORK (U.S. CLS. 100 AND 101).

FIRST USE 9-8-2006; IN COMMERCE 9-8-2006.

CLASS 43—(Continued).

3,177,508. T-REX CAFE, INC., HOUSTON, TX. SN 76-619,299. PUB. 10-4-2005, FILED 11-4-2004.

T-REX

THE MARK CONSISTS OF STANDARD CHARACTERS WITHOUT CLAIM TO ANY PARTICULAR FONT, STYLE, SIZE, OR COLOR.

FOR RESTAURANT SERVICES FOR CONSUMPTION ON THE PREMISES (U.S. CLS. 100 AND 101).

FIRST USE 7-25-2006; IN COMMERCE 7-25-2006.

3,177,557. THE ROASTED PEPPER, INC., ROSWELL, GA. SN 76-636,808. PUB. 1-17-2006, FILED 4-25-2005.

SEE WHAT HAPPENS WHEN AN ITALIAN MARRIES A GREEK.

THE MARK CONSISTS OF STANDARD CHARACTERS WITHOUT CLAIM TO ANY PARTICULAR FONT, STYLE, SIZE, OR COLOR.

FOR RESTAURANT SERVICES (U.S. CLS. 100 AND 101).

FIRST USE 4-1-2005; IN COMMERCE 4-1-2005.

3,177,601. FRAKES, R ERIC, VACAVILLE, CA. SN 78-124,888. PUB. 11-19-2002, FILED 4-29-2002.

THE ORIGINAL PIZZA PUCKS

NO CLAIM IS MADE TO THE EXCLUSIVE RIGHT TO USE "THE ORIGINAL PIZZA", APART FROM THE MARK AS SHOWN.

FOR RESTAURANT, FOOD SERVICES (U.S. CLS. 100 AND 101).

FIRST USE 4-29-2002; IN COMMERCE 4-29-2002.

CLASS 43—(Continued).

3,177,704. COLORADO NATURE RANCH, L.P., ORLANDO, FL. SN 78-324,546. PUB. 7-5-2005, FILED 11-7-2003.

CLASS 43—(Continued).

3,177,854. QWEST COMMUNICATIONS INTERNATIONAL INC., DENVER, CO. SN 78-431,316. PUB. 6-21-2005, FILED 6-7-2004.

**Be Moved. Be
Challenged. Be
Changed.**

QWEST FIELD

THE MARK CONSISTS OF STANDARD CHARACTERS WITHOUT CLAIM TO ANY PARTICULAR FONT, STYLE, SIZE, OR COLOR.

FOR RESORT HOTEL SERVICES (U.S. CLS. 100 AND 101).

FIRST USE 1-1-2004; IN COMMERCE 1-1-2004.

THE MARK CONSISTS OF STANDARD CHARACTERS WITHOUT CLAIM TO ANY PARTICULAR FONT, STYLE, SIZE, OR COLOR.

NO CLAIM IS MADE TO THE EXCLUSIVE RIGHT TO USE "FIELD", APART FROM THE MARK AS SHOWN.

FOR ARENA SERVICES, NAMELY, PROVIDING FACILITIES FOR BUSINESS EVENTS, CONSUMER SHOWS, TRADE SHOWS, ARTISTIC ACTIVITIES, COMMUNITY ACTIVITIES, ENTERTAINMENT EVENTS, PUBLIC EVENTS, SPORTING EVENTS AND TOURNAMENTS, EDUCATIONAL EVENTS, CONVENTIONS AND EXHIBITIONS (U.S. CLS. 100 AND 101).

FIRST USE 6-30-2004; IN COMMERCE 6-30-2004.

3,177,743. ASSAF, VITTORIO, NEW YORK, NY. AND GRANATO, FABIO, NEW YORK, NY. SN 78-363,102. PUB. 11-2-2004, FILED 2-5-2004.

3,177,926. QWEST COMMUNICATIONS INTERNATIONAL INC., DENVER, CO. SN 78-459,954. PUB. 6-21-2005, FILED 7-30-2004.

LOLLIPOP



THE MARK CONSISTS OF STANDARD CHARACTERS WITHOUT CLAIM TO ANY PARTICULAR FONT, STYLE, SIZE, OR COLOR.

FOR RESTAURANT AND BAR SERVICES (U.S. CLS. 100 AND 101).

FIRST USE 7-1-2006; IN COMMERCE 7-1-2006.

NO CLAIM IS MADE TO THE EXCLUSIVE RIGHT TO USE "FIELD", APART FROM THE MARK AS SHOWN.

FOR ARENA SERVICES, NAMELY, PROVIDING FACILITIES FOR BUSINESS EVENTS, CONSUMER SHOWS, TRADE SHOWS, ARTISTIC ACTIVITIES, COMMUNITY ACTIVITIES, ENTERTAINMENT EVENTS, PUBLIC EVENTS, SPORTING EVENTS AND TOURNAMENTS, EDUCATIONAL EVENTS, CONVENTIONS AND EXHIBITIONS (U.S. CLS. 100 AND 101).

FIRST USE 6-30-2004; IN COMMERCE 6-30-2004.

CLASS 43—(Continued).

3,177,932. RAISING CANE'S U.S.A., LLC, BATON ROUGE, LA. SN 78-461,999. PUB. 11-15-2005, FILED 8-4-2004.

FEED YOUR GAME
FACE

THE MARK CONSISTS OF STANDARD CHARACTERS WITHOUT CLAIM TO ANY PARTICULAR FONT, STYLE, SIZE, OR COLOR.

FOR RESTAURANT SERVICES (U.S. CLS. 100 AND 101).

FIRST USE 4-0-2004; IN COMMERCE 4-0-2004.

CLASS 43—(Continued).

3,178,007. CAMPBELL'S FRESH, L.L.C., GRAFTON, ND. SN 78-488,461. PUB. 12-13-2005, FILED 9-23-2004.



NO CLAIM IS MADE TO THE EXCLUSIVE RIGHT TO USE "FRESH WOODFIRED BURGERS", APART FROM THE MARK AS SHOWN.

THE COLOR(S) GREEN, RED, ORANGE, YELLOW, BLACK AND WHITE IS/ARE CLAIMED AS A FEATURE OF THE MARK.

THE MARK CONSISTS OF THE WORD "CAMPBELL'S" AND THE SWOOSH UNDER THE WORD "FRESH" COLORED GREEN, WITH THE WORD "FRESH" COLORED RED. THE FLAME BELOW THE WORD "CAMPBELL'S" CONTAINS RED, YELLOW AND ORANGE. THE BANNER AND OUTLINING ON THE WORD "CAMPBELL'S" ARE COLORED BLACK. THE WORDING "WOODFIRED BURGERS" IS COLORED WHITE.

FOR RESTAURANT SERVICES FEATURING FAST FOOD HAMBURGERS (U.S. CLS. 100 AND 101).

FIRST USE 1-1-2005; IN COMMERCE 1-1-2005.

3,177,995. LEE'S SANDWICHES INTERNATIONAL INC., SAN JOSE, CA. SN 78-480,356. PUB. 8-2-2005, FILED 9-8-2004.

KING OF BAGUETTES

THE MARK CONSISTS OF STANDARD CHARACTERS WITHOUT CLAIM TO ANY PARTICULAR FONT, STYLE, SIZE, OR COLOR.

NO CLAIM IS MADE TO THE EXCLUSIVE RIGHT TO USE "BAGUETTES", APART FROM THE MARK AS SHOWN.

FOR RESTAURANT SERVICES, FEATURING SANDWICHES, COFFEE AND BAKED GOODS, NAMELY BREAD, PIES AND CAKES (U.S. CLS. 100 AND 101).

FIRST USE 3-31-2003; IN COMMERCE 4-1-2003.

3,178,019. LETTUCE ENTERTAIN YOU ENTERPRISES, INC., CHICAGO, IL. SN 78-492,070. PUB. 10-18-2005, FILED 9-30-2004.



FOR RESTAURANT SERVICES (U.S. CLS. 100 AND 101).

FIRST USE 10-6-2004; IN COMMERCE 10-6-2004.

CLASS 43—(Continued).

3,178,024. MAGGIORE, JOSEPH P, CARLSBAD, CA. SN 78-493,855. PUB. 9-20-2005, FILED 10-4-2004.

JOEY'S SMOKIN' B-B-Q - OUR
RIBS ARE SMOKIN'

THE MARK CONSISTS OF STANDARD CHARACTERS WITHOUT CLAIM TO ANY PARTICULAR FONT, STYLE, SIZE, OR COLOR.

NO CLAIM IS MADE TO THE EXCLUSIVE RIGHT TO USE "B-B-Q", APART FROM THE MARK AS SHOWN.

FOR RESTAURANT SERVICES (U.S. CLS. 100 AND 101).

FIRST USE 1-1-2005; IN COMMERCE 5-16-2005.

CLASS 43—(Continued).

3,178,157. TROPICAL BREEZE SMOOTHIES FRANCHISE COMPANY, BOCA RATON, FL. SN 78-557,005. PUB. 12-27-2005, FILED 1-31-2005.



NO CLAIM IS MADE TO THE EXCLUSIVE RIGHT TO USE "FRUIT SMOOTHIES FRESH SQUEEZED JUICE, SHAVED ICE & MORE", APART FROM THE MARK AS SHOWN.

THE MARK CONSISTS OF SWIRL BEHIND STYLIZED LETTERING.

FOR RESTAURANT SERVICES INCLUDING RESTAURANTS AND FOOD COUNTERS FEATURING JUICES, SHAVED ICE, SMOOTHIES, SALADS, PITAS, SOUPS AND SANDWICHES (U.S. CLS. 100 AND 101).

FIRST USE 4-19-2005; IN COMMERCE 4-19-2005.

3,178,144. LYONS GROUP, LTD., BOSTON, MA. SN 78-551,496. PUB. 11-29-2005, FILED 1-21-2005.



BRRRING IT ON!

THE COLOR(S) RED, WHITE, AND BLUE IS/ARE CLAIMED AS A FEATURE OF THE MARK.

THE STYLIZED REPRESENTATION OF A PERSON IS COLORED WHITE. THE PORTION OF THE MARK TO THE LEFT OF THE PERSON IS COLORED BLUE, AND THE PORTIONS ABOVE AND TO THE RIGHT OF THE PERSON ARE COLORED RED.

FOR SPORTS BAR SERVICES (U.S. CLS. 100 AND 101).
FIRST USE 4-12-2005; IN COMMERCE 4-12-2005.

3,178,168. AMERICAN DAIRY QUEEN CORPORATION, EDINA, MN. SN 78-561,582. PUB. 10-25-2005, FILED 2-7-2005.

THE MARK CONSISTS OF STANDARD CHARACTERS WITHOUT CLAIM TO ANY PARTICULAR FONT, STYLE, SIZE, OR COLOR.

FOR RESTAURANT SERVICES AND CARRY-OUT FOOD SERVICES (U.S. CLS. 100 AND 101).

FIRST USE 4-24-2005; IN COMMERCE 4-24-2005.

CLASS 43—(Continued).

3,178,176. OVERSTOCK.COM, INC., SALT LAKE CITY, UT.
SN 78-564,647. PUB. 6-13-2006, FILED 2-10-2005.



THE MARK CONSISTS OF WORD "ISLANDESCAPES" FOLLOWED BY ONE LARGE FLOWER, FOLLOWED BY ONE SMALL FLOWER.

FOR TRAVEL AGENCY SERVICES, NAMELY, MAKING RESERVATIONS AND BOOKINGS FOR TEMPORARY LODGING (U.S. CLS. 100 AND 101).

FIRST USE 3-13-2006; IN COMMERCE 3-13-2006.

3,178,177. OVERSTOCK.COM, INC., SALT LAKE CITY, UT.
SN 78-564,665. PUB. 6-6-2006, FILED 2-10-2005.



NO CLAIM IS MADE TO THE EXCLUSIVE RIGHT TO USE "MOUNTAIN RESERVATIONS" AND "LODGING", APART FROM THE MARK AS SHOWN.

THE MARK CONSISTS OF WORDS "MOUNTAIN RESERVATIONS" FOLLOWED BY THREE SMALL SNOWFLAKES. UNDERNEATH MOUNTAIN RESERVATIONS APPEARS THE WORDS "LODGING. ANYTIME. ANYWHERE."

FOR TRAVEL AGENCY SERVICES, NAMELY, MAKING RESERVATIONS AND BOOKINGS FOR TEMPORARY LODGING (U.S. CLS. 100 AND 101).

FIRST USE 3-13-2006; IN COMMERCE 3-13-2006.

3,178,223. EVERYONE'S A CHEF, INC., CEDAR FALLS, IA.
SN 78-574,371. PUB. 11-22-2005, FILED 2-24-2005.

EVERYONE'S A CHEF

THE MARK CONSISTS OF STANDARD CHARACTERS WITHOUT CLAIM TO ANY PARTICULAR FONT, STYLE, SIZE, OR COLOR.

FOR FOOD PREPARATION SERVICES, NAMELY, PROVIDING RECIPES AND INGREDIENTS FOR ASSEMBLY BY THE GENERAL PUBLIC (U.S. CLS. 100 AND 101).

FIRST USE 7-0-2006; IN COMMERCE 7-0-2006.

CLASS 43—(Continued).

3,178,314. THE CORT COFFEE COMPANY, PLANTATION, FL. SN 78-592,402. PUB. 12-20-2005, FILED 3-22-2005.

CORT'S COFFEEHOUSE

THE MARK CONSISTS OF STANDARD CHARACTERS WITHOUT CLAIM TO ANY PARTICULAR FONT, STYLE, SIZE, OR COLOR.

NO CLAIM IS MADE TO THE EXCLUSIVE RIGHT TO USE "COFFEEHOUSE", APART FROM THE MARK AS SHOWN.

FOR RESTAURANT SERVICES FEATURING COFFEE AND ESPRESSO BEVERAGES, SANDWICHES AND BREAKFAST (U.S. CLS. 100 AND 101).

FIRST USE 7-1-2005; IN COMMERCE 7-1-2005.

3,178,315. INN AT ST. JOHN'S, LLC, BLOOMFIELD HILLS, MI. SN 78-592,411. PUB. 12-20-2005, FILED 3-22-2005.



NO CLAIM IS MADE TO THE EXCLUSIVE RIGHT TO USE "RESTAURANT", APART FROM THE MARK AS SHOWN.

FOR RESTAURANT AND BAR SERVICES (U.S. CLS. 100 AND 101).

FIRST USE 1-16-2006; IN COMMERCE 1-16-2006.

CLASS 43—(Continued).

3,178,328. JAQUES, EBER, SAN ANSELMO, CA. SN 78-595,439. PUB. 12-27-2005, FILED 3-25-2005.

LIFE IS A LATTE

THE MARK CONSISTS OF STANDARD CHARACTERS WITHOUT CLAIM TO ANY PARTICULAR FONT, STYLE, SIZE, OR COLOR.

FOR RESTAURANT SERVICES (U.S. CLS. 100 AND 101).

FIRST USE 5-18-2005; IN COMMERCE 5-18-2005.

3,178,437. SIX CONTINENTS HOTELS, INC., ATLANTA, GA. SN 78-629,023. PUB. 1-31-2006, FILED 5-12-2005.



THE MARK CONSISTS OF THE WORD "PHI" DEPICTED IN STYLIZED LETTERS WITH AN OLIVE AND A TOOTH-PICK OVER THE "I".

FOR COCKTAIL LOUNGE AND BAR SERVICES RENDERED IN A HOTEL (U.S. CLS. 100 AND 101).

FIRST USE 5-16-2005; IN COMMERCE 5-16-2005.

3,178,615. THE ORIGINAL GINO'S, INC., TOLEDO, OH. SN 78-712,594. PUB. 5-23-2006, FILED 9-14-2005.

SAUCI'S PIZZERIA

THE MARK CONSISTS OF STANDARD CHARACTERS WITHOUT CLAIM TO ANY PARTICULAR FONT, STYLE, SIZE, OR COLOR.

NO CLAIM IS MADE TO THE EXCLUSIVE RIGHT TO USE "PIZZERIA", APART FROM THE MARK AS SHOWN.

FOR RESTAURANT FEATURING PIZZA AND OTHER ITALIAN DISHES AND PROVIDING BOTH ON-SITE SEATING AND DELIVERY (U.S. CLS. 100 AND 101).

FIRST USE 9-14-2006; IN COMMERCE 9-14-2006.

CLASS 44—MEDICAL, BEAUTY AND AGRICULTURAL SERVICES

3,177,365. CERUS CORPORATION, CONCORD, CA. SN 76-427,849. PUB. 6-24-2003, FILED 6-28-2002.

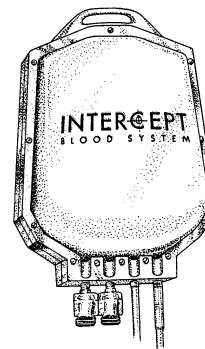

NO CLAIM IS MADE TO THE EXCLUSIVE RIGHT TO USE "BLOOD SYSTEM", APART FROM THE MARK AS SHOWN.

THE STIPLING IS A FEATURE OF THE MARK AND DOES NOT INDICATE COLOR.

FOR PROVIDING INFORMATION IN THE FIELD OF TRANSFUSION MEDICINE (U.S. CLS. 100 AND 101).

FIRST USE 11-26-2003; IN COMMERCE 11-26-2003.

3,177,374. TRACEY TECHNOLOGIES LLC, HOUSTON, TX. SN 76-471,324. PUB. 12-13-2005, FILED 11-18-2002.

TRACEY

FOR OPTOMETRY SERVICES, NAMELY, PROVIDING EYE EXAMINATIONS TO DETERMINE VISION CHARACTERISTICS OF THE EYE, NAMELY TO DETERMINE ABERRATIONS OF THE CORNEA, LENS, RETINA AND TOTAL EYE AND TO DETERMINE WAVE FRONT ABERRATIONS OF THE EYE AND COMPONENT PARTS THEREOF (U.S. CLS. 100 AND 101).

FIRST USE 0-0-2001; IN COMMERCE 0-0-2001.

3,177,412. SOUTH COAST WINERY, INC., SANTA ANA, CA. SN 76-556,328. PUB. 12-14-2004, FILED 11-3-2003.

GRAPE SEED SPA

NO CLAIM IS MADE TO THE EXCLUSIVE RIGHT TO USE "SPA", APART FROM THE MARK AS SHOWN.

FOR HEALTH SPA SERVICES, NAMELY, COSMETIC BODY CARE SERVICES (U.S. CLS. 100 AND 101).

FIRST USE 6-23-2006; IN COMMERCE 7-15-2006.

CLASS 44—(Continued).

3,177,454. CALEEN CANTRELL DDS, PA, FRISCO, TX. SN 76-600,866. PUB. 11-22-2005, FILED 7-7-2004.

CHILDSMILE

THE MARK CONSISTS OF STANDARD CHARACTERS WITHOUT CLAIM TO ANY PARTICULAR FONT, STYLE, SIZE, OR COLOR.

FOR PEDIATRIC DENTISTRY SERVICES (U.S. CLS. 100 AND 101).

FIRST USE 5-1-2005; IN COMMERCE 5-1-2005.

3,177,512. BURTON, CHARLES V., EXCELSIOR, MN. SN 76-620,645. PUB. 10-11-2005, FILED 11-12-2004.

CONSULTATION EXPRESS

THE MARK CONSISTS OF STANDARD CHARACTERS WITHOUT CLAIM TO ANY PARTICULAR FONT, STYLE, SIZE, OR COLOR.

NO CLAIM IS MADE TO THE EXCLUSIVE RIGHT TO USE "CONSULTATION", APART FROM THE MARK AS SHOWN.

FOR MEDICAL CONSULTATIVE SERVICES (U.S. CLS. 100 AND 101).

FIRST USE 5-6-1993; IN COMMERCE 5-6-1993.

3,177,712. SHIM, MI OCG, BURKE, VA. SN 78-331,657. PUB. 10-11-2005, FILED 11-21-2003.

일류 Hair Bank

NO CLAIM IS MADE TO THE EXCLUSIVE RIGHT TO USE ILRYU HAIR, APART FROM THE MARK AS SHOWN. THE ENGLISH TRANSLATION OF "ILRYU" IS "FIRST RATE".

THE NON-LATIN CHARACTERS IN THE MARK TRANSLITERATE TO ILRYU.

FOR HAIRDRESSING SERVICES (U.S. CLS. 100 AND 101).

FIRST USE 1-1-2004; IN COMMERCE 1-1-2004.

CLASS 44—(Continued).

3,177,721. METRO INFECTIOUS DISEASE CONSULTANTS, L.L.C., HINSDALE, IL. SN 78-344,818. PUB. 1-11-2005, FILED 12-23-2003.

HHI INFUSION SERVICES

THE MARK CONSISTS OF STANDARD CHARACTERS WITHOUT CLAIM TO ANY PARTICULAR FONT, STYLE, SIZE, OR COLOR.

NO CLAIM IS MADE TO THE EXCLUSIVE RIGHT TO USE "INFUSION SERVICES", APART FROM THE MARK AS SHOWN.

FOR MEDICAL SERVICES, DIAGNOSTIC SERVICES IN THE FIELD OF HUMAN HEALTHCARE AND TREATMENT SERVICES, INFUSION SERVICES, MEDICAL LABORATORIES, NURSING CARE, AMBULATORY CARE, WELLNESS PROGRAMS, SMOKING CESSATION PROGRAMS AND PROVIDING HEALTH INFORMATION (U.S. CLS. 100 AND 101).

FIRST USE 5-0-2004; IN COMMERCE 5-0-2004.

3,177,860. NAVITAS CANCER REHABILITATION CENTERS OF AMERICA, INC., WESTMINSTER, CO. SN 78-436,155. PUB. 5-17-2005, FILED 6-16-2004.

NAVITAS

THE MARK CONSISTS OF STANDARD CHARACTERS WITHOUT CLAIM TO ANY PARTICULAR FONT, STYLE, SIZE, OR COLOR.

FOR CANCER REHABILITATION SERVICES (U.S. CLS. 100 AND 101).

FIRST USE 3-1-2005; IN COMMERCE 3-1-2006.

CLASS 44—(Continued).

3,177,868. WALDREP, DONALD J., ROSEVILLE, CA. SN 78-437,326. PUB. 5-3-2005, FILED 6-17-2004.

SCALES

THE MARK CONSISTS OF STANDARD CHARACTERS WITHOUT CLAIM TO ANY PARTICULAR FONT, STYLE, SIZE, OR COLOR.

FOR SURGERY CLINICS AND CENTERS, NAMELY, PROVIDING SURGERY SERVICES; SURGERY COUNSELING; MEDICAL INFORMATION; LAPAROSCOPIC SURGERY; MICROLAPAROSCOPIC SURGERY; AND PRE-SURGERY AND POST SURGERY PATIENT CARE (U.S. CLS. 100 AND 101).

FIRST USE 12-0-2004; IN COMMERCE 1-29-2006.

3,177,927. THE WESTMINSTER KENNEL CLUB, NEW YORK, NY. SN 78-460,297. PUB. 12-13-2005, FILED 8-2-2004.

ANGEL ON A LEASH

THE MARK CONSISTS OF STANDARD CHARACTERS WITHOUT CLAIM TO ANY PARTICULAR FONT, STYLE, SIZE, OR COLOR.

FOR THERAPEUTIC SERVICES, NAMELY, PROVIDING ANIMAL THERAPY FOR PEOPLE IN THE NATURE OF PROVIDING COMPANIONSHIP AND SUPPORT TO CONTRIBUTE TO THE EMOTIONAL AND PHYSICAL HEALING PROCESS FOR PATIENTS UNDERGOING PHYSICAL THERAPY, SURGICAL PROCEDURES OR SUFFERING FROM CHRONIC ILLNESS (U.S. CLS. 100 AND 101).

FIRST USE 11-9-2004; IN COMMERCE 11-9-2004.

CLASS 44—(Continued).

3,178,060. RODRIGUEZ, RAUL P., DALLAS, TX. SN 78-512,871. PUB. 10-18-2005, FILED 11-8-2004.

THINJECTION

THE MARK CONSISTS OF STANDARD CHARACTERS WITHOUT CLAIM TO ANY PARTICULAR FONT, STYLE, SIZE, OR COLOR.

FOR MEDICAL SERVICES, NAMELY, ADMINISTERING INJECTIONS, NUTRITIONAL SUPPLEMENTS AND PHARMACEUTICAL PREPARATIONS FOR USE IN LOCALIZED FAT AND CELLULITE REDUCTION (U.S. CLS. 100 AND 101).

FIRST USE 7-1-2002; IN COMMERCE 7-1-2002.

3,178,156. AXIUM HEALTHCARE PHARMACY, INC., LAKE MARY, FL. SN 78-556,955. PUB. 2-21-2006, FILED 1-31-2005.

GHVISIONS

THE MARK CONSISTS OF STANDARD CHARACTERS WITHOUT CLAIM TO ANY PARTICULAR FONT, STYLE, SIZE, OR COLOR.

FOR DISPENSING OF MEDICATIONS AND PHARMACY CARE MANAGEMENT SERVICES TO AID IN THE MANAGEMENT OF COMPREHENSIVE MEDICAL TREATMENT FOR PATIENTS WITH GROWTH HORMONE DISORDERS, NAMELY PEDIATRIC AND ADULT GROWTH HORMONE DEFICIENCIES (U.S. CLS. 100 AND 101).

FIRST USE 1-1-2006; IN COMMERCE 1-1-2006.

CLASS 44—(Continued).

3,178,233. PREMIER HEALTH CARE SERVICES, INC., DAYTON, OH. SN 78-576,443. PUB. 5-9-2006, FILED 2-28-2005.

REVITALIZ MEDICAL SPA

THE MARK CONSISTS OF STANDARD CHARACTERS WITHOUT CLAIM TO ANY PARTICULAR FONT, STYLE, SIZE, OR COLOR.

NO CLAIM IS MADE TO THE EXCLUSIVE RIGHT TO USE "MEDICAL SPA", APART FROM THE MARK AS SHOWN.

FOR COSMETIC AND PLASTIC SURGERY; MEDICAL SERVICES, NAMELY, DERMATOLOGY; HAIR TRANSPLANTATION, HAIR REPLACEMENT AND PERMANENT HAIR REMOVAL SERVICES; SKIN CARE SALON; HEALTH SPA; AND HAIR AND BEAUTY SALON SERVICES; HEALTH SPA SERVICES, NAMELY, COSMETIC BODY CARE SERVICES (U.S. CLS. 100 AND 101).

FIRST USE 11-30-2005; IN COMMERCE 11-30-2005.

3,178,258. LDM GROUP, LLC, ST. LOUIS, MO. SN 78-581,929. PUB. 5-9-2006, FILED 3-7-2005.

CarePoints

THE MARK CONSISTS OF STANDARD CHARACTERS WITHOUT CLAIM TO ANY PARTICULAR FONT, STYLE, SIZE, OR COLOR.

FOR PROVIDING INFORMATION TO CONSUMERS RELATING TO PATIENT MEDICATION AND DRUG THERAPY (U.S. CLS. 100 AND 101).

FIRST USE 1-1-2005; IN COMMERCE 3-15-2005.

CLASS 44—(Continued).

3,178,447. TRIMERIS, INC., MORRISVILLE, NC. SN 78-633,206. PUB. 1-31-2006, FILED 5-19-2005.

CONNECTIONS

THE MARK CONSISTS OF STANDARD CHARACTERS WITHOUT CLAIM TO ANY PARTICULAR FONT, STYLE, SIZE, OR COLOR.

FOR HEALTH INFORMATION SERVICES, NAMELY PROVIDING INFORMATION TO PATIENTS, CAREGIVERS, AND HEALTHCARE PROFESSIONALS ON TOPICS OF THERAPY OF HIV INFECTION/DISEASE WITH ENFUVIRTIDE, TREATMENT WITH ENFUVIRTIDE, AND SELF-MANAGEMENT SKILLS FOR PATIENTS UNDERGOING TREATMENT WITH ENFUVIRTIDE; AND PROVIDING ACCESS TO INFORMATION AND SUPPORT BY TELEPHONE, INTERNET, AND IN-PERSON, TO START OR CONTINUE TREATMENT WITH ENFUVIRTIDE (U.S. CLS. 100 AND 101).

FIRST USE 4-24-2006; IN COMMERCE 6-13-2006.

3,178,597. CIGNA INTELLECTUAL PROPERTY, INC., CLAYMONT, DE. SN 78-704,384. PUB. 5-16-2006, FILED 8-31-2005.

CIGNA HEALTHY PREGNANCIES, HEALTHY BABIES

THE MARK CONSISTS OF STANDARD CHARACTERS WITHOUT CLAIM TO ANY PARTICULAR FONT, STYLE, SIZE, OR COLOR.

OWNER OF U.S. REG. NOS. 1,270,224, 2,243,553, AND OTHERS.

NO CLAIM IS MADE TO THE EXCLUSIVE RIGHT TO USE "HEALTHY PREGNANCIES, HEALTHY BABIES", APART FROM THE MARK AS SHOWN.

FOR PRENATAL AND POST PARTUM HEALTH CARE SERVICES (U.S. CLS. 100 AND 101).

FIRST USE 2-15-2006; IN COMMERCE 2-15-2006.

3,178,607. CHILDREN'S HOSPITAL & RESEARCH CENTER OAKLAND, OAKLAND, CA. SN 78-709,371. PUB. 5-23-2006, FILED 9-8-2005.

UNDIVIDED ATTENTION. UNSURPASSED CARE.

THE MARK CONSISTS OF STANDARD CHARACTERS WITHOUT CLAIM TO ANY PARTICULAR FONT, STYLE, SIZE, OR COLOR.

FOR HOSPITALS (U.S. CLS. 100 AND 101).

FIRST USE 10-3-2005; IN COMMERCE 10-3-2005.

CLASS 45—PERSONAL SERVICES

CLASS 45—(Continued).

3,177,910. NASSIRI, NICK, EL SEGUNDO, CA. SN 78-452,353.
PUB. 9-20-2005, FILED 7-17-2004.

3,178,365. CR LICENSE, LLC, TUCSON, AZ. SN 78-601,546.
PUB. 1-3-2006, FILED 4-4-2005.

VERIFX

CANYON RANCH

THE MARK CONSISTS OF STANDARD CHARACTERS WITHOUT CLAIM TO ANY PARTICULAR FONT, STYLE, SIZE, OR COLOR.

FOR COMPUTER VERIFICATION SERVICES, NAMELY, VERIFICATION OF A PERSON'S SIGNATURE AND VERIFICATION OF NOTARIZATION ON A DOCUMENT, VERIFICATION OF FINGERPRINTS, VERIFICATION OF PROFESSIONAL LICENSES AND THE VERIFICATION OF HAVING OBTAINED GOVERNMENTAL PERMITS (U.S. CLS. 100 AND 101).
FIRST USE 6-10-2005; IN COMMERCE 9-1-2005.

THE MARK CONSISTS OF STANDARD CHARACTERS WITHOUT CLAIM TO ANY PARTICULAR FONT, STYLE, SIZE, OR COLOR.

OWNER OF U.S. REG. NOS. 1,350,012, 1,409,026, AND OTHERS.

FOR PROVIDING ON-LINE INFORMATION IN THE FIELDS OF SPIRITUALITY, SELF-HELP, AND PERSONAL EMPOWERMENT SUBJECT MATTERS; PROVIDING SELECTION OF ON-LINE GREETING CARDS (U.S. CLS. 100 AND 101).
FIRST USE 8-1-2006; IN COMMERCE 8-1-2006.

* * * * *

PRIOR UNITED STATES CLASSIFICATION

APPLICATION IN ONE CLASS

CERTIFICATION MARKS

CLASS B—SERVICES

3,177,714. THEATRICAL DEALERS ASSOCIATION, DBA ENTERTAINMENT SERVICES AND TECHNOLOGY ASSOCIATION, NEW YORK, NY. SN 78-337,871. PUB. 12-7-2004, FILED 12-8-2003.

THE CERTIFICATION MARK, AS USED BY PERSONS AUTHORIZED BY THE CERTIFIER, CERTIFIES THAT SUCH PERSONS MEET THE CERTIFIER'S STANDARDS AS TO KNOWLEDGE, EXPERIENCE AND COMPETENCE AS REFLECTED BY THE SUCCESSFUL COMPLETION OF WRITTEN EXAMINATIONS.

FOR TECHNICAL SERVICES IN THE FIELD OF ENTERTAINMENT THAT PROMOTE THE HEALTH AND SAFETY OF PERFORMERS, CREW MEMBERS AND AUDIENCES (U.S. CL. B).

FIRST USE 1-20-2006; IN COMMERCE 1-20-2006.



NO CLAIM IS MADE TO THE EXCLUSIVE RIGHT TO USE CERTIFIED, APART FROM THE MARK AS SHOWN.

* * * * *

SUPPLEMENTAL REGISTER

These registrations are not subject to opposition.

SECTION 1.— INTERNATIONAL CLASSIFICATION

The short titles associated below with the international class numbers are terms designed merely for quick identification and are not an official part of the international classification. The full names of international classes are given in section 6.1 of the trademark rules of practice.

The designation "U.S. Cl." appearing in this section refers to the U.S. class in effect prior to Sep. 1, 1973 rather than the international class which applies to applications filed on or after that date. For adoption of international classification see notice in the OFFICIAL GAZETTE of Jun. 26, 1973 (911 O.G. TM 210).

Application in more than one class

3,178,698. MHC TT LEASING COMPANY, INC., CHICAGO, IL. SN 78-403,059. FILED P.R. 4-16-2004; AM. S.R. 8-23-2006.

3,178,705. SHAW, PHILIP, HERMOSA BEACH, CA. SN 78-476,015. FILED P.R. 8-30-2004; AM. S.R. 10-5-2006.

MACLAURIN

GETAWAY CLUB

THE MARK CONSISTS OF STANDARD CHARACTERS WITHOUT CLAIM TO ANY PARTICULAR FONT, STYLE, SIZE, OR COLOR.

CLASS 9—ELECTRICAL AND SCIENTIFIC APPARATUS

FOR GUITAR AND BASS AMPLIFIERS, METRONOMES, ELECTRONIC EFFECTS BOXES FOR GUITARS AND BASSES, DATA CABLES FOR ELECTRIC GUITARS AND BASSES, HEADPHONES, ELECTRIC CORDS FOR GUITARS AND BASSES, GUITAR AND BASS ELECTRONIC PICKUPS; ROLLING HARD CASES FOR GUITAR AMPLIFIERS; SOFT AND HARD CASES FOR ELECTRONIC EFFECTS BOXES (U.S. CLS. 21, 23, 26, 36 AND 38).

FIRST USE 11-15-2005; IN COMMERCE 11-15-2005.

CLASS 15—MUSICAL INSTRUMENTS

FOR ELECTRIC AND ACOUSTIC GUITARS, ELECTRIC AND ACOUSTIC BASSES, AND STRINGS, TUNING KEYS, PICKS, PICKGUARDS AND TREMOLOS FOR GUITARS AND BASSES; DIGITAL TUNERS FOR MUSICAL INSTRUMENTS; DIGITAL CHORD ANALYZERS FOR MUSICAL INSTRUMENTS; SOFT CASES AND HARD CASES FOR ELECTRIC AND ACOUSTIC GUITARS AND BASSES; CLOTH GUITAR STRAPS (U.S. CLS. 2, 21 AND 36).

FIRST USE 11-15-2005; IN COMMERCE 11-15-2005.

CLASS 25—CLOTHING

FOR TEE SHIRTS, FLEECE PULLOVERS AND SWEATSHIRTS, TOPS, BOTTOMS, HATS, VISORS AND BANDANAS (U.S. CLS. 22 AND 39).

FIRST USE 11-15-2005; IN COMMERCE 11-15-2005.

THE MARK CONSISTS OF STANDARD CHARACTERS WITHOUT CLAIM TO ANY PARTICULAR FONT, STYLE, SIZE, OR COLOR.

NO CLAIM IS MADE TO THE EXCLUSIVE RIGHT TO USE "GETAWAY", APART FROM THE MARK AS SHOWN.

CLASS 41—EDUCATION AND ENTERTAINMENT

FOR PROVIDING FACILITIES FOR RECREATION ACTIVITIES; RECREATIONAL SERVICES IN THE NATURE OF HORSEBACK RIDING, GAMES, TENNIS, BOATING, FISHING, HIKING; RECREATIONAL CAMPS (U.S. CLS. 100, 101 AND 107).

FIRST USE 1-1-2004; IN COMMERCE 1-1-2004.

CLASS 43—HOTEL AND RESTAURANT SERVICES

FOR PROVIDING CAMPGROUND FACILITIES; PROVIDING LODGING WITH POOLS; TRAVEL AGENCY SERVICES, NAMELY, MAKING RESERVATIONS AND BOOKING FOR TEMPORARY LODGING (U.S. CLS. 100 AND 101).

FIRST USE 1-1-2004; IN COMMERCE 1-1-2004.

3,178,707. INVIVO CORPORATION, ORLANDO, FL. SN 78-503,798. FILED P.R. 10-21-2004; AM. S.R. 9-5-2006.

3,178,713. HALFORDS LIMITED, WORCESTERSHIRE, UNITED KINGDOM. SN 78-540,022. FILED P.R. 12-30-2004; AM. S.R. 9-8-2006.

INVIVO

THE MARK CONSISTS OF STANDARD CHARACTERS WITHOUT CLAIM TO ANY PARTICULAR FONT, STYLE, SIZE, OR COLOR.

CLASS 9—ELECTRICAL AND SCIENTIFIC APPARATUS

FOR SENSORS, NAMELY, BIOMEDICAL AND PHYSIOLOGICAL, NAMELY TEMPERATURE SENSORS, BLOOD PRESSURE SENSORS, RESPIRATORY SENSORS, OXYGEN AND GAS SENSORS, AND RECORDING EQUIPMENT, NAMELY, AUDIO VISUAL TAPE RECORDERS, AUDIO, VISUAL, ELECTRONIC, AND DIGITAL RECORDERS, HARD COPY RECORDERS, AND DISPLAY MONITORS, ALL FOR USE IN SCIENTIFIC RESEARCH IN LABORATORIES; APPARATUS FOR RECORDING, TRANSMISSION OR REPRODUCTION OF SOUND OR IMAGES, BLANK MAGNETIC DATA CARRIERS, AND DATA PROCESSORS FOR BIOMEDICAL AND SCIENTIFIC RESEARCH (U.S. CLS. 21, 23, 26, 36 AND 38).

FIRST USE 0-0-1979; IN COMMERCE 0-0-1979.

CLASS 10—MEDICAL APPARATUS

FOR PRECISION BIOMEDICAL MONITORING DEVICES, NAMELY, ELECTROCARDIOGRAPH MONITORS, HEART RATE MONITORS, SINUS TACHYCARDIA ELEVATION/DEPRESSION MONITORS, RESPIRATION MONITORS, EKG MONITORS, SPOT OXYGEN SATURATION MONITORS, NON-INVASIVE BLOOD PRESSURE MONITORS, INVASIVE BLOOD PRESSURE MONITORS, END-TIDAL CARBON DIOXIDE MONITORS, AND CRITICAL CARE VITAL SIGNS MONITORS; ANESTHETIC AGENT DELIVERY MEASUREMENT DEVICES; DISPOSABLE BLOOD PRESSURE CUFFS; MRI COILS, NAMELY, ANTENNAS FOR CAPTURING OR TRANSMITTING ELECTRICAL SIGNALS DURING MAGNETIC RESONANCE IMAGING PROCEDURES; MRI PATIENT MONITORS; PULSE OXIMETERS; ALL THE FOREGOING BEING MEDICAL APPARATUS AND INSTRUMENTS FOR USE IN MEDICAL, SURGICAL, DENTAL, AND VETERINARY FIELDS (U.S. CLS. 26, 39 AND 44).

FIRST USE 0-0-1979; IN COMMERCE 0-0-1979.

CLASS 42—SCIENTIFIC, COMPUTER AND LEGAL SERVICES

FOR RESEARCH, DESIGN AND DEVELOPMENT OF PRECISION BIOMEDICAL MONITORING DEVICES FOR USE IN SCIENTIFIC RESEARCH IN LABORATORIES AND IN THE MEDICAL, SURGICAL, DENTAL AND VETERINARY FIELDS (U.S. CLS. 100 AND 101).

FIRST USE 0-0-1979; IN COMMERCE 0-0-1979.

HALFORDS

THE MARK CONSISTS OF STANDARD CHARACTERS WITHOUT CLAIM TO ANY PARTICULAR FONT, STYLE, SIZE, OR COLOR.

OWNER OF UNITED KINGDOM REG. NO. 884757, DATED 9-25-1965, RENEWED AS REG. NO. 884758, DATED 9-25-2000, EXPIRES 9-25-2010.

OWNER OF UNITED KINGDOM REG. NO. 884745, DATED 9-25-1965, RENEWED AS REG. NO. 884758, DATED 9-25-2000, EXPIRES 9-25-2010.

OWNER OF UNITED KINGDOM REG. NO. 884744, DATED 9-25-1965, RENEWED AS REG. NO. 884758, DATED 9-25-2000, EXPIRES 9-25-2010.

OWNER OF UNITED KINGDOM REG. NO. 884743, DATED 9-25-1965, RENEWED AS REG. NO. 884758, DATED 9-25-2000, EXPIRES 9-25-2010.

CLASS 7—MACHINERY

FOR POWER TOOLS, NAMELY, DRILLS, SANDERS, SCREW DRIVERS AND ANGLE GRINDERS (U.S. CLS. 13, 19, 21, 23, 31, 34 AND 35).

CLASS 8—HAND TOOLS

FOR HAND TOOLS, NAMELY, SCREW DRIVERS, SPANNERS, RATCHETS, SOCKET SETS, PLIERS AND SAWS; HAND OPERATED JACKS; TROLLEY JACKS (U.S. CLS. 23, 28 AND 44).

CLASS 9—ELECTRICAL AND SCIENTIFIC APPARATUS

FOR BATTERIES; CABLE JUMP LEADS (U.S. CLS. 21, 23, 26, 36 AND 38).

CLASS 27—FLOOR COVERINGS

FOR FLOOR MATS FOR VEHICLES (U.S. CLS. 19, 20, 37, 42 AND 50).

3,178,714. VERAXSYS, INC., LYNCHBURG, VA. SN 78-541,557. FILED P.R. 1-4-2005; AM. S.R. 10-18-2006.

Unified Lifecycle Test and Reporting Architecture

THE MARK CONSISTS OF STANDARD CHARACTERS WITHOUT CLAIM TO ANY PARTICULAR FONT, STYLE, SIZE, OR COLOR.

CLASS 9—ELECTRICAL AND SCIENTIFIC APPARATUS

FOR TEST EQUIPMENT FOR VOICE QUALITY TESTING FOR SYSTEMS UTILIZING VOICE TRANSMISSION INCLUDING MOBILE RADIO SYSTEMS (U.S. CLS. 21, 23, 26, 36 AND 38).

FIRST USE 3-18-2004; IN COMMERCE 3-18-2004.

CLASS 42—SCIENTIFIC, COMPUTER AND LEGAL SERVICES

FOR SERVICES RELATED TO VOICE QUALITY TESTING FOR SYSTEMS USING VOICE TRANSMISSION, NAMELY, MONITORING, TESTING, EVALUATING, ANALYZING AND REPORTING VOICE QUALITY (U.S. CLS. 100 AND 101).

FIRST USE 3-18-2004; IN COMMERCE 3-18-2004.

3,178,718. ISLAM, MOHAMMAD R, DIX HILLS, NY. SN 78-561,294. FILED P.R. 2-5-2005; AM. S.R. 8-14-2006.

PDA TRADE

THE MARK CONSISTS OF STANDARD CHARACTERS WITHOUT CLAIM TO ANY PARTICULAR FONT, STYLE, SIZE, OR COLOR.

CLASS 9—ELECTRICAL AND SCIENTIFIC APPARATUS

FOR COMPUTER APPLICATION SOFTWARE FOR MOBILE DEVICES IN THE NATURE OF MOBILE PHONES, NAMELY, A SOFTWARE APPLICATION ALLOWING CONSUMERS TO UPDATE AND RECEIVE DATA IN AN ENTERPRISE'S COMPUTER DATABASES IN REAL TIME, AND CARRY OUT ALL KINDS OF FINANCIAL TRANSACTIONS USING A MOBILE DEVICE WITH A WIRELESS NETWORK CARD AND FULL TELEPHONY INTEGRATION WITH TELEPHONE AND SOFTWARE FEATURES OF THE MOBILE DEVICE (U.S. CLS. 21, 23, 26, 36 AND 38).

FIRST USE 3-21-2006; IN COMMERCE 3-21-2006.

CLASS 36—INSURANCE AND FINANCIAL

FOR FINANCIAL SERVICES, NAMELY PROVIDING INFORMATION ABOUT STOCKS, BONDS, SECURITIES AND EQUITIES (U.S. CLS. 100, 101 AND 102).

FIRST USE 3-21-2006; IN COMMERCE 3-21-2006.

3,178,722. MUSCO CORPORATION, OSKALOOSA, IA. SN 78-562,879. FILED P.R. 2-8-2005; AM. S.R. 10-13-2006.

SMART LAMP

THE MARK CONSISTS OF STANDARD CHARACTERS WITHOUT CLAIM TO ANY PARTICULAR FONT, STYLE, SIZE, OR COLOR.

CLASS 9—ELECTRICAL AND SCIENTIFIC APPARATUS

FOR ELECTRICAL CIRCUITS FOR OPERATING WIDE AREA AND SPORTS LIGHTING FIXTURES (U.S. CLS. 21, 23, 26, 36 AND 38).

FIRST USE 3-5-2005; IN COMMERCE 3-5-2005.

CLASS 11—ENVIRONMENTAL CONTROL APPARATUS

FOR ELECTRICAL WIDE AREA AND SPORTS LIGHTING FIXTURES (U.S. CLS. 13, 21, 23, 31 AND 34).

FIRST USE 3-5-2005; IN COMMERCE 3-5-2005.

3,178,745. MORAVIA IT, A.S., BRNO, CZECH REPUBLIC. SN 78-665,686. FILED P.R. 7-7-2005; AM. S.R. 5-17-2006.

MORAVIA IT

OWNER OF CZECH REPUBLIC REG. NO. 254901, DATED 6-25-2003, EXPIRES 6-25-2013.

CLASS 9—ELECTRICAL AND SCIENTIFIC APPARATUS

FOR COMPUTER SOFTWARE FOR APPLICATION AND DATABASE INTEGRATION AND FOR USE IN OPERATING, REVISING AND UPDATING INTERNET WEB SITES, FOR FOREIGN LANGUAGE TRANSLATION, MACHINE TRANSLATION AND ADAPTING INTERNET WEB SITES, INTRANETS, E-MAILS AND INSTANT MESSAGING TO BE COMPATIBLE WITH INTERNATIONAL AND COUNTRY SPECIFIC OPERATING SYSTEM AND SOFTWARE (U.S. CLS. 21, 23, 26, 36 AND 38).

CLASS 35—ADVERTISING AND BUSINESS

FOR BUSINESS PROJECT MANAGEMENT SERVICES FOR OTHERS IN THE FIELD OF LANGUAGE TRANSLATION; AND BUSINESS INTERMEDIARY SERVICES IN THE NATURE OF ARRANGING CONTRACTUAL SERVICES FOR THE DEVELOPMENT OF COMPUTER SOFTWARE TO BE USED TO ADAPT PRODUCTS TO OTHER LANGUAGES AND CULTURES (U.S. CLS. 100, 101 AND 102).

CLASS 40—MATERIAL TREATMENT

FOR DESKTOP PUBLISHING FOR OTHERS (U.S. CLS. 100, 103 AND 106).

CLASS 41—EDUCATION AND ENTERTAINMENT

FOR LANGUAGE TRANSLATION, LANGUAGE INTERPRETING AND TRAINING IN THE USE OF COMPUTER SOFTWARE AND DESKTOP PUBLISHING TOOLS (U.S. CLS. 100, 101 AND 107).

CLASS 42—SCIENTIFIC, COMPUTER AND LEGAL SERVICES

FOR DEVELOPMENT OF COMPUTER SOFTWARE FOR USE IN ADAPTING WEB-BASED APPLICATIONS AND TEXTS TO A SPECIFIC INTERNATIONAL LANGUAGE OR CULTURE; COMPUTER PROJECT MANAGEMENT SERVICES; DEVELOPMENT OF COMPUTER SOFTWARE COMPONENTS FOR OTHERS; COMPUTER SERVICES, NAMELY, DESIGNING AND IMPLEMENTING WEB SITES FOR OTHERS; COMPUTER SOFTWARE CONSULTATION SERVICES; INFORMATION TECHNOLOGY CONSULTATION; TESTING OF COMPUTER SOFTWARE FOR OTHERS; GRAPHIC ART DESIGN SERVICES FOR OTHERS; AND INTEGRATION OF COMPUTER SYSTEMS AND NETWORKS (U.S. CLS. 100 AND 101).

3,178,747. OLD FORGE PIZZA VENTURES LLC, OLD FORGE, PA. SN 78-673,069. FILED P.R. 7-19-2005; AM. S.R. 8-8-2006.

OLD FORGE PIZZA EXPRESS

THE MARK CONSISTS OF STANDARD CHARACTERS WITHOUT CLAIM TO ANY PARTICULAR FONT, STYLE, SIZE, OR COLOR.

NO CLAIM IS MADE TO THE EXCLUSIVE RIGHT TO USE "PIZZA", APART FROM THE MARK AS SHOWN.

CLASS 30—STAPLE FOODS

FOR UNBAKED PIZZA, PASTA AND BREAD STICKS, PREPARED FOR OFF-PREMISES COOKING AND CONSUMPTION (U.S. CL. 46).

FIRST USE 5-26-2005; IN COMMERCE 6-19-2006.

CLASS 35—ADVERTISING AND BUSINESS

FOR RETAIL STORE SERVICES FEATURING PIZZA, PASTA AND SALAD, ONLINE RETAIL STORE SERVICES FEATURING PIZZA PASTA AND SALAD (U.S. CLS. 100, 101 AND 102).

FIRST USE 5-26-2005; IN COMMERCE 6-19-2006.

3,178,749. DIRECT SUPPLY, INC., MILWAUKEE, WI. SN 78-688,794. FILED P.R. 8-9-2005; AM. S.R. 9-14-2006.

ELDERCARE INTERIORS

THE MARK CONSISTS OF STANDARD CHARACTERS WITHOUT CLAIM TO ANY PARTICULAR FONT, STYLE, SIZE, OR COLOR.

NO CLAIM IS MADE TO THE EXCLUSIVE RIGHT TO USE "ELDERCARE", APART FROM THE MARK AS SHOWN.

CLASS 35—ADVERTISING AND BUSINESS

FOR BUSINESS MANAGEMENT CONSULTANCY AS WELL AS DEVELOPMENT OF PROCESSES FOR THE ANALYSIS AND IMPLANTATION OF STRATEGY PLANS AND MANAGEMENT PROJECTS FOR LONG TERM CARE FACILITIES; LOGISTICS MANAGEMENT SERVICES FOR LONG TERM CARE FACILITIES (U.S. CLS. 100, 101 AND 102).

FIRST USE 1-31-2002; IN COMMERCE 1-31-2002.

CLASS 42—SCIENTIFIC, COMPUTER AND LEGAL SERVICES

FOR INTERIOR DESIGN SERVICES (U.S. CLS. 100 AND 101).

FIRST USE 1-31-2002; IN COMMERCE 1-31-2002.

3,178,756. SYSTEMS SUPPORT PRODUCTS, LLC, FAIRFAX, VA. SN 78-695,559. FILED P.R. 8-18-2005; AM. S.R. 9-12-2006.

BEST ERGONOMICS

THE MARK CONSISTS OF STANDARD CHARACTERS WITHOUT CLAIM TO ANY PARTICULAR FONT, STYLE, SIZE, OR COLOR.

NO CLAIM IS MADE TO THE EXCLUSIVE RIGHT TO USE "ERGONOMICS", APART FROM THE MARK AS SHOWN.

CLASS 9—ELECTRICAL AND SCIENTIFIC APPARATUS

FOR ERGONOMIC PRODUCTS, NAMELY, MOUSE PADS, PALM AND WRIST PADS FOR USE WITH COMPUTERS (U.S. CLS. 21, 23, 26, 36 AND 38).
FIRST USE 8-0-2005; IN COMMERCE 8-0-2005.

CLASS 11—ENVIRONMENTAL CONTROL APPARATUS

FOR LIGHTING FIXTURES, TASK LIGHTING FIXTURES, DESKTOP LIGHTING FIXTURES, PANEL MOUNTED LIGHTING FIXTURES, HUTCH MOUNTED LIGHTING FIXTURES, PENDANT HUNG LIGHTING FIXTURES, FLOOR SUPPORTED LIGHTING FIXTURES, AMBIENT LIGHTING FIXTURES (U.S. CLS. 13, 21, 23, 31 AND 34).
FIRST USE 8-0-2005; IN COMMERCE 8-0-2005.

CLASS 20—FURNITURE AND ARTICLES NOT OTHERWISE CLASSIFIED

FOR OFFICE PRODUCTS, NAMELY, DESKTOP DIVIDER PANELS, DESKING SYSTEMS, NAMELY, DESKS AND COMPONENT PARTS THEREFOR INCLUDING LEGS, FILING PEDESTALS, SUPPORT PEDESTALS, WORK SURFACES, TABLETOPS, TABLES, FIXED HEIGHT TABLES, ADJUSTABLE HEIGHT TABLES, FOLDING TABLES, FLIP TOP TABLES, TRAINING TABLES, CLASSROOM TABLES AND FURNITURE, SCHOOL FURNITURE; CORNER MAKERS USED WITH FURNITURE, CORNER FILLERS USED WITH FURNITURE; ERGONOMIC PRODUCTS, NAMELY, ARTICULATING KEYBOARD ARMS, KEYBOARD ARMS FIXED MOUNTED OR ADJUSTABLE, KEYBOARD PLATFORMS, MOUSING PLATFORMS, AND TRAYS FOR USE WITH COMPUTERS, ROLLOUT KEYBOARD DRAWERS, TRAYS AND PLATFORMS, CPU STORAGE UNITS, CPU HOLDERS, CPU CADDIES, COMPUTER MONITOR ARMS, FLAT SCREEN MONITOR ARMS, MONITOR SUPPORTS, AND CRT SUPPORTS (U.S. CLS. 2, 13, 22, 25, 32 AND 50).
FIRST USE 8-0-2005; IN COMMERCE 8-0-2005.

3,178,762. ENTERTAINMENT PUBLICATIONS, INC., TROY, MI. SN 78-705,142. FILED P.R. 9-1-2005; AM. S.R. 9-20-2006.

ULTIMATE SAVINGS CARD

THE MARK CONSISTS OF STANDARD CHARACTERS WITHOUT CLAIM TO ANY PARTICULAR FONT, STYLE, SIZE, OR COLOR.
NO CLAIM IS MADE TO THE EXCLUSIVE RIGHT TO USE "CARD", APART FROM THE MARK AS SHOWN.

CLASS 16—PAPER GOODS AND PRINTED MATTER

FOR BOOKS CONTAINING COUPONS AND DISCOUNT OFFERS, AND NON-MAGNETICALLY ENCODED CARDS WHICH ENTITLE THE HOLDER TO RECEIVE DISCOUNTS ON DINING, HOTEL ACCOMMODATIONS, CONSUMER MERCHANDISE, TRAVEL, MOVIES, SPORTS, THEATER AND OTHER LEISURE ACTIVITIES; AND PRINTED DIRECTORIES OF BUSINESSES HONORING SUCH DISCOUNTS (U.S. CLS. 2, 5, 22, 23, 29, 37, 38 AND 50).
FIRST USE 8-15-2006; IN COMMERCE 8-15-2006.

CLASS 35—ADVERTISING AND BUSINESS

FOR ADVERTISING AND PROMOTING THE GOODS AND SERVICES OF OTHERS BY MEANS OF PROGRAMS TO BUILD CUSTOMER LOYALTY; PROVIDING VIA COMPUTER ON-LINE SERVICES A MEMBERSHIP PROGRAM ENTITLING PARTICIPANTS TO RECEIVE DISCOUNTS ON DINING, HOTEL ACCOMMODATIONS, CONSUMER MERCHANDISE, TRAVEL, MOVIES, SPORTS, THEATER AND OTHER LEISURE ACTIVITIES, AND PROVIDING IN CONNECTION WHEREWITH AN ON-LINE DIRECTORY OF INFORMATION ABOUT THE PROGRAM AND THE PARTICIPATING BUSINESSES; AND FOR PROVIDING A CONSUMER BENEFIT MEMBERSHIP PROGRAM, NAMELY, PROMOTING THE GOODS AND SERVICES OF OTHERS THROUGH THE DISTRIBUTION OF COUPONS AND DISCOUNT OFFERS WHICH ENTITLE THE HOLDER TO RECEIVE DISCOUNTS ON DINING, HOTEL ACCOMMODATIONS, CONSUMER MERCHANDISE, TRAVEL, MOVIES, SPORTS, THEATER AND OTHER LEISURE ACTIVITIES (U.S. CLS. 100, 101 AND 102).
FIRST USE 8-15-2006; IN COMMERCE 8-15-2006.

3,178,768. GRIGGER, ROSALIND R., NEW CASTLE, DE. AND DAVIS, DAVITA Q., NEW CASTLE, DE. SN 78-713,369. FILED P.R. 9-15-2005; AM. S.R. 9-22-2006.

THE TEE SHOP

THE MARK CONSISTS OF STANDARD CHARACTERS WITHOUT CLAIM TO ANY PARTICULAR FONT, STYLE, SIZE, OR COLOR.
NO CLAIM IS MADE TO THE EXCLUSIVE RIGHT TO USE "TEE" FOR CLASS 25 AND "SHOP" FOR CLASS 35, APART FROM THE MARK AS SHOWN.

CLASS 25—CLOTHING

FOR SHORT-SLEEVED, LONG SLEEVED, OR SLEEVELESS T-SHIRTS (U.S. CLS. 22 AND 39).
FIRST USE 0-0-2003; IN COMMERCE 0-0-2003.

CLASS 35—ADVERTISING AND BUSINESS

FOR RETAIL APPAREL STORES; ON-LINE RETAIL STORE SERVICES FEATURING APPAREL (U.S. CLS. 100, 101 AND 102).
FIRST USE 0-0-2003; IN COMMERCE 0-0-2003.

3,178,777. SELIGSON, DOUGLAS S., NEW MARKET, MD. SN 78-724,040. FILED P.R. 9-30-2005; AM. S.R. 10-2-2006.



NO CLAIM IS MADE TO THE EXCLUSIVE RIGHT TO USE "MD", APART FROM THE MARK AS SHOWN.

CLASS 16—PAPER GOODS AND PRINTED MATTER

FOR PRINTED MATERIAL, NAMELY, PRINTED PAPER SIGNS, DECALS, BUMPER STICKERS, POSTERS, CALENDARS (U.S. CLS. 2, 5, 22, 23, 29, 37, 38 AND 50). FIRST USE 1-1-2001; IN COMMERCE 2-21-2001.

CLASS 25—CLOTHING

FOR CLOTHING, NAMELY, HATS, SHIRTS, PANTS, JACKETS, SOCKS, UNDERWEAR (U.S. CLS. 22 AND 39). FIRST USE 1-1-2001; IN COMMERCE 2-21-2001.

3,178,794. GAUTHIER, CAROLE, NEW YORK, NY. SN 78-766,150. FILED P.R. 12-3-2005; AM. S.R. 10-19-2006.

THE MIDLIFE INSTITUTE

THE MARK CONSISTS OF STANDARD CHARACTERS WITHOUT CLAIM TO ANY PARTICULAR FONT, STYLE, SIZE, OR COLOR.

NO CLAIM IS MADE TO THE EXCLUSIVE RIGHT TO USE "INSTITUTE", APART FROM THE MARK AS SHOWN.

CLASS 41—EDUCATION AND ENTERTAINMENT

FOR EDUCATION AND SELF-DEVELOPMENT AND HEALTH IMPROVEMENT PRACTICES, NAMELY, CONDUCTING SEMINARS AND WORKSHOPS IN THE FIELD OF PSYCHOLOGICAL DEVELOPMENT AND MIDLIFE CHANGE PROCESSES; PUBLISHING OF JOURNALS, BOOKS AND HANDBOOKS IN THE FIELD OF PSYCHOLOGICAL DEVELOPMENT AND MIDLIFE CHANGE PROCESSES; PRODUCTION OF FILM STUDIES IN THE FIELD OF PSYCHOLOGICAL DEVELOPMENT AND MIDLIFE CHANGE PROCESSES (U.S. CLS. 100, 101 AND 107).

FIRST USE 1-1-2005; IN COMMERCE 1-1-2005.

CLASS 42—SCIENTIFIC, COMPUTER AND LEGAL SERVICES

FOR RESEARCH IN THE FIELD OF PSYCHOLOGICAL DEVELOPMENT AND MIDLIFE CHANGE PROCESSES (U.S. CLS. 100 AND 101).

FIRST USE 1-1-2005; IN COMMERCE 1-1-2005.

CLASS 44—MEDICAL, BEAUTY AND AGRICULTURAL SERVICES

FOR PSYCHOLOGICAL AND PHYSIOLOGICAL TESTING, COACHING, MENTAL HEALTH COUNSELING, INDIVIDUAL AND GROUP PSYCHOTHERAPY, AND ART THERAPY, RELATING PSYCHOLOGICAL DEVELOPMENT AND MIDLIFE CHANGE PROCESSES; PROVIDING INFORMATION IN THE FIELD OF PSYCHOLOGICAL DEVELOPMENT AND MIDLIFE CHANGE PROCESSES (U.S. CLS. 100 AND 101).

FIRST USE 1-1-2005; IN COMMERCE 1-1-2005.

3,178,795. BROWN, KEITH M. PLANO, TX. SN 78-773,707. FILED P.R. 12-14-2005; AM. S.R. 9-15-2006.

American Button Machines

THE MARK CONSISTS OF STANDARD CHARACTERS WITHOUT CLAIM TO ANY PARTICULAR FONT, STYLE, SIZE, OR COLOR.

NO CLAIM IS MADE TO THE EXCLUSIVE RIGHT TO USE "BUTTON MACHINES", APART FROM THE MARK AS SHOWN.

CLASS 8—HAND TOOLS

FOR HAND TOOL COMPRISING DIE AND PRESS ASSEMBLY FOR MAKING PIN BACK BUTTONS AND BADGES (U.S. CLS. 23, 28 AND 44).

FIRST USE 8-11-2004; IN COMMERCE 8-11-2004.

CLASS 26—FANCY GOODS

FOR ORNAMENTAL NOVELTY BUTTONS AND PINS (U.S. CLS. 37, 39, 40, 42 AND 50).

FIRST USE 8-11-2004; IN COMMERCE 8-11-2004.

3,178,799. ONE CALL CONCEPTS, INC., HANOVER, MD. SN 78-784,275. FILED P.R. 1-3-2006; AM. S.R. 10-16-2006.

NATIONAL TICKET MANAGEMENT SYSTEM

THE MARK CONSISTS OF STANDARD CHARACTERS WITHOUT CLAIM TO ANY PARTICULAR FONT, STYLE, SIZE, OR COLOR.

CLASS 35—ADVERTISING AND BUSINESS

3,178,815. JMJ ASSOCIATES, LLC, AUSTIN, TX. SN 78-852,776. FILED P.R. 4-3-2006; AM. S.R. 9-19-2006.

FOR MANAGING COMPUTERIZED DATABASES FOR EVALUATING, SORTING AND ANALYZING INFORMATION IN RELATION TO UNDERGROUND FACILITIES; NAMELY, DETERMINING THE LOCATION OF PIPES, LINES AND CABLES; CUSTOMER SERVICES IN THE FIELD OF UNDERGROUND FACILITIES; NAMELY, PROVIDING INFORMATION CONCERNING THE LOCATION OF PIPES, LINES AND CABLES FOR THE BENEFIT OF CUSTOMERS (U.S. CLS. 100, 101 AND 102).

FIRST USE 6-9-2005; IN COMMERCE 6-9-2005.

CLASS 42—SCIENTIFIC, COMPUTER AND LEGAL SERVICES

FOR PROGRAMMING, DESIGNING AND MAINTAINING COMPUTERIZED DATABASES AVAILABLE OVER THE INTERNET FOR OTHERS USING PROPRIETARY SOFTWARE FOR EVALUATING, SORTING AND ANALYZING INFORMATION IN RELATION TO UNDERGROUND FACILITIES; NAMELY, DETERMINING THE LOCATION OF PIPES, LINES AND CABLES; PROVIDING INFORMATION ABOUT UNDERGROUND FACILITIES; NAMELY, THE LOCATION OF PIPES, LINES AND CABLES, USING PROPRIETARY SOFTWARE; ON-LINE DATABASE SERVICES, NAMELY, PROVIDING INFORMATION REGARDING THE LOCATION AND MARKING OF UNDERGROUND FACILITIES; NAMELY, PIPES, LINES AND CABLES, PRIOR TO CONSTRUCTION, AND PROVIDING SEARCH AND STATUS SERVICES OF UNDERGROUND FACILITIES FOR USE BY THE GENERAL PUBLIC, USING PROPRIETARY SOFTWARE (U.S. CLS. 100 AND 101).

FIRST USE 6-9-2005; IN COMMERCE 6-9-2005.

3,178,800. FIREBRAND MEDIA, INC., LONDON, KY. SN 78-792,038. FILED P.R. 1-15-2006; AM. S.R. 10-6-2006.

ALL-STAR CHEER

THE MARK CONSISTS OF STANDARD CHARACTERS WITHOUT CLAIM TO ANY PARTICULAR FONT, STYLE, SIZE, OR COLOR.

CLASS 9—ELECTRICAL AND SCIENTIFIC APPARATUS

FOR DOWNLOADABLE ELECTRONIC PUBLICATIONS IN THE NATURE OF MAGAZINES ON THE SUBJECT OF CHEERLEADING AVAILABLE ON THE INTERNET (U.S. CLS. 21, 23, 26, 36 AND 38).

FIRST USE 3-0-2006; IN COMMERCE 3-0-2006.

CLASS 16—PAPER GOODS AND PRINTED MATTER

FOR MAGAZINES ON THE SUBJECT OF CHEERLEADING (U.S. CLS. 2, 5, 22, 23, 29, 37, 38 AND 50).

FIRST USE 3-0-2006; IN COMMERCE 3-0-2006.

INCIDENT AND INJURY FREE

THE MARK CONSISTS OF STANDARD CHARACTERS WITHOUT CLAIM TO ANY PARTICULAR FONT, STYLE, SIZE, OR COLOR.

CLASS 35—ADVERTISING AND BUSINESS

FOR BUSINESS ORGANIZATION AND MANAGEMENT CONSULTING SERVICES, NAMELY, PROVIDING BUSINESS MANAGEMENT AND ADVICE IN THE FIELDS OF BUSINESS MANAGEMENT, COLLABORATIVE VENTURES, EMPLOYEE SAFETY, PROJECT MANAGEMENT AND ORGANIZATIONAL TRANSFORMATION (U.S. CLS. 100, 101 AND 102).

FIRST USE 1-1-1996; IN COMMERCE 1-1-1996.

CLASS 41—EDUCATION AND ENTERTAINMENT

FOR CONDUCTING SAFETY PRACTICES AND PROCEDURES TRAINING THROUGH SEMINARS, WORKSHOPS AND PERSONAL COACHING IN THE FIELD OF INDUSTRIAL AND BUSINESS WORKPLACE SAFETY; TRAINING AND EDUCATIONAL SERVICES, NAMELY, CONDUCTING TRAINING AND MOTIVATIONAL CLASSES, SEMINARS, AND WORKSHOPS IN THE FIELD OF WORKPLACE SAFETY FOR MAJOR CAPITAL AND ENGINEERING PROJECTS AND RELATED ACTIVITIES; CONDUCTING BUSINESS TRAINING COURSES AND PERSONAL COACHING SEMINARS IN THE FIELDS OF COMMERCIAL AND INDUSTRIAL SAFETY, LEADERSHIP AND BUSINESS PROJECT MANAGEMENT (U.S. CLS. 100, 101 AND 107).

FIRST USE 1-1-1996; IN COMMERCE 1-1-1996.

3,178,829. IBACOS, INC., PITTSBURGH, PA. SN 78-976,731. FILED P.R. 12-7-2004; AM. S.R. 1-17-2006.

BEST PRACTICES

THE MARK CONSISTS OF STANDARD CHARACTERS WITHOUT CLAIM TO ANY PARTICULAR FONT, STYLE, SIZE, OR COLOR.

CLASS 9—ELECTRICAL AND SCIENTIFIC APPARATUS

FOR DOWNLOADABLE ELECTRONIC PUBLICATIONS, NAMELY, ONLINE PUBLICATIONS VIA A GLOBAL COMPUTER NETWORK IN THE NATURE OF MAGAZINES, NEWSLETTERS, BOOKS AND BROCHURES RELATING TO DESIGN ENGINEERING, TROUBLESHOOTING, RESEARCH, TRAINING AND QUALITY ASSESSMENT SERVICES FOR RESIDENTIAL CONSTRUCTION (U.S. CLS. 21, 23, 26, 36 AND 38).

FIRST USE 0-0-2005; IN COMMERCE 0-0-2005.

CLASS 16—PAPER GOODS AND PRINTED MATTER

FOR PRINT PUBLICATIONS, NAMELY, MAGAZINES, NEWSLETTERS, BOOKS AND BROCHURES ABOUT DESIGN ENGINEERING, TROUBLESHOOTING, RESEARCH, TRAINING AND QUALITY ASSESSMENT SERVICES FOR RESIDENTIAL CONSTRUCTION (U.S. CLS. 2, 5, 22, 23, 29, 37, 38 AND 50).

FIRST USE 0-0-2005; IN COMMERCE 0-0-2005.

CLASS 37—CONSTRUCTION AND REPAIR

FOR CONSULTING SERVICES, NAMELY, DESIGN ENGINEERING, TROUBLESHOOTING, RESEARCH AND QUALITY ASSESSMENT IN THE FIELD OF RESIDENTIAL CONSTRUCTION (U.S. CLS. 100, 103 AND 106).

FIRST USE 0-0-2005; IN COMMERCE 0-0-2005.

CLASS 42—SCIENTIFIC, COMPUTER AND LEGAL SERVICES

FOR TECHNICAL CONSULTATION, NAMELY, DESIGN ENGINEERING, TROUBLESHOOTING, RESEARCH AND QUALITY ASSESSMENT AND CONSULTATION IN THE FIELD OF RESIDENTIAL CONSTRUCTION (U.S. CLS. 100 AND 101).

FIRST USE 0-0-2005; IN COMMERCE 0-0-2005.

* * * * *

SECTION 2.— INTERNATIONAL CLASSIFICATION

The short titles associated below with the international class numbers are terms designed merely for quick identification and are not an official part of the international classification. The full names of international classes are given in section 6.1 of the trademark rules of practice.

The designation "U.S. Cl." appearing in this section refers to the U.S. class in effect prior to Sep. 1, 1973 rather than the international class which applies to applications filed on or after that date. For adoption of international classification see notice in the OFFICIAL GAZETTE of Jun. 26, 1973 (911 O.G. TM 210).

Application in one class

CLASS 1—CHEMICALS

3,178,763. RESIN RESEARCH, INC., INDIAN HARBOUR BEACH, FL. SN 78-705,542. FILED P.R. 9-1-2005; AM. S.R. 9-20-2006.

RESIN RESEARCH EPOXY SYSTEMS

THE MARK CONSISTS OF STANDARD CHARACTERS WITHOUT CLAIM TO ANY PARTICULAR FONT, STYLE, SIZE, OR COLOR.

NO CLAIM IS MADE TO THE EXCLUSIVE RIGHT TO USE RESIN AND EPOXY SYSTEMS, APART FROM THE MARK AS SHOWN.

FOR CHEMICAL ADDITIVES USED TO PREPARE SOLID COATINGS (U.S. CLS. 1, 5, 6, 10, 26 AND 46). FIRST USE 2-1-1982; IN COMMERCE 2-1-1982.

CLASS 3—(Continued).

3,178,683. TRACIE MARTYN, INC., NEW YORK, NY. SN 76-622,286. FILED P.R. 11-24-2004; AM. S.R. 9-11-2006.

PURPLE

THE MARK CONSISTS OF STANDARD CHARACTERS WITHOUT CLAIM TO ANY PARTICULAR FONT, STYLE, SIZE, OR COLOR.

OWNER OF U.S. REG. NOS. 3,044,034 AND 3,044,035. FOR NON-MEDICATED SKIN CARE PREPARATIONS (U.S. CLS. 1, 4, 6, 50, 51 AND 52).

FIRST USE 9-8-2006; IN COMMERCE 9-8-2006.

3,178,730. RDL DESIGNS, LLC, NORTH HOLLYWOOD, CA. SN 78-609,250. FILED P.R. 4-14-2005; AM. S.R. 8-21-2006.

CLASS 2—PAINTS

3,178,816. ESSENTIAL PRODUCTS, INC., LAS VEGAS, NV. SN 78-859,094. FILED P.R. 4-11-2006; AM. S.R. 9-20-2006.

GREAT INK! GREAT PRICE!

THE MARK CONSISTS OF STANDARD CHARACTERS WITHOUT CLAIM TO ANY PARTICULAR FONT, STYLE, SIZE, OR COLOR.

FOR INK JET CARTRIDGES (U.S. CLS. 6, 11 AND 16). FIRST USE 3-31-2005; IN COMMERCE 3-31-2005.

THE MARK CONSISTS OF STANDARD CHARACTERS WITHOUT CLAIM TO ANY PARTICULAR FONT, STYLE, SIZE, OR COLOR.

NO CLAIM IS MADE TO THE EXCLUSIVE RIGHT TO USE "TAN", APART FROM THE MARK AS SHOWN.

FOR NATURAL OR SYNTHETIC COSMETIC COMPOUNDS TRANSCUTANEOUSLY APPLIED IN THE NATURE OF LIQUIDS AND POWDERS THAT ARE USED TO CHANGE THE COLOR OF ONE'S OWN NATURAL PIGMENT COLOR AND EXFOLIATING PREPARATIONS, NAMELY LOTIONS, CREAMS, CLEANSERS, GELS, MISTS, SPRAYS AND SOAPS, ALL FOR THE USE ON SKIN, WHICH MAINTAIN, PROMOTE OR FACILITATE THE DIFFERENT COLOR OF THE SKIN AND SKIN ABRASIVE PREPARATIONS, PRODUCTS THAT PREVENT DEGRADATION OF THE SKIN BY THE SUN, NAMELY COSMETIC SUN TANNING PREPARATIONS, SUN BLOCKS, SUN LOTIONS, AND SKIN MOISTURIZERS (U.S. CLS. 1, 4, 6, 50, 51 AND 52).

FIRST USE 8-15-2006; IN COMMERCE 8-15-2006.

CLASS 3—COSMETICS AND CLEANING PREPARATIONS

CLASS 3—(Continued).

3,178,735. MICHAEL STARS, INC., HAWTHORNE, CA. SN 78-643,020. FILED P.R. 6-3-2005; AM. S.R. 4-19-2006.

THE ORIGINAL SCENT

THE MARK CONSISTS OF STANDARD CHARACTERS WITHOUT CLAIM TO ANY PARTICULAR FONT, STYLE, SIZE, OR COLOR.

NO CLAIM IS MADE TO THE EXCLUSIVE RIGHT TO USE "SCENT", APART FROM THE MARK AS SHOWN.

FOR PERFUMES, BODY LOTIONS, SKIN LOTIONS, SHOWER GEL, LIP GLOSS, NON-MEDICATED LIP CARE PREPARATIONS (U.S. CLS. 1, 4, 6, 50, 51 AND 52).

FIRST USE 2-0-2003; IN COMMERCE 2-0-2003.

3,178,809. ALTERNA HOLDINGS CORPORATION, LOS ANGELES, CA. SN 78-839,413. FILED P.R. 3-16-2006; AM. S.R. 9-11-2006.

VOLUME MOLDING CREAM

THE MARK CONSISTS OF STANDARD CHARACTERS WITHOUT CLAIM TO ANY PARTICULAR FONT, STYLE, SIZE, OR COLOR.

FOR HAIR CARE PREPARATIONS, NAMELY, STYLING LOTIONS, GELS, GLAZES, TONICS, MOUSSES, STYLING FOAMS, HAIR SPRAYS, HAIR BALMS, WAXES, AND POMADES (U.S. CLS. 1, 4, 6, 50, 51 AND 52).

FIRST USE 6-8-2006; IN COMMERCE 6-8-2006.

3,178,817. KBWEST INC. MOORPARK, CA. SN 78-861,502. FILED P.R. 4-14-2006; AM. S.R. 10-10-2006.

Surfer Suds

THE MARK CONSISTS OF STANDARD CHARACTERS WITHOUT CLAIM TO ANY PARTICULAR FONT, STYLE, SIZE, OR COLOR.

FOR BODY SOAP, BATH AND SHOWER GEL WASH, BATH AND SHOWER CREAM WASH FOR BODY CARE IN LIQUID, SOLID OR GEL FORM; USED SPECIFICALLY FOR PERSONAL CLEANING BY INDIVIDUALS (U.S. CLS. 1, 4, 6, 50, 51 AND 52).

FIRST USE 11-18-2004; IN COMMERCE 9-3-2005.

CLASS 5—PHARMACEUTICALS**CLASS 5—(Continued).**

3,178,766. NUTRACEUTIX, INC., REDMOND, WA. SN 78-710,974. FILED P.R. 9-12-2005; AM. S.R. 9-21-2006.

IMMUNOBIOTIX

THE MARK CONSISTS OF STANDARD CHARACTERS WITHOUT CLAIM TO ANY PARTICULAR FONT, STYLE, SIZE, OR COLOR.

FOR DIETARY SUPPLEMENTS AND VITAMIN AND MINERAL SUPPLEMENTS (U.S. CLS. 6, 18, 44, 46, 51 AND 52).

FIRST USE 6-1-2006; IN COMMERCE 6-1-2006.

3,178,792. NUTOPICALS, L.L.C., NEWCASTLE, OK. SN 78-743,454. FILED P.R. 10-31-2005; AM. S.R. 10-11-2006.

BANANA CREAM

THE MARK CONSISTS OF STANDARD CHARACTERS WITHOUT CLAIM TO ANY PARTICULAR FONT, STYLE, SIZE, OR COLOR.

NO CLAIM IS MADE TO THE EXCLUSIVE RIGHT TO USE "CREAM", APART FROM THE MARK AS SHOWN.

FOR TOPICAL MEDICATED PREPARATIONS CONTAINING A BANANA PEEL EXTRACT FOR USE ON HUMANS AND ANIMALS, NAMELY, SKIN CREAMS, DERMATITIS CREAMS, WOUND CREAMS AND BURN CREAMS (U.S. CLS. 6, 18, 44, 46, 51 AND 52).

FIRST USE 4-1-2006; IN COMMERCE 4-1-2006.

3,178,796. ESSENTIAL NUTRACEUTICALS, LLC, BIRMINGHAM, AL. SN 78-778,527. FILED P.R. 12-21-2005; AM. S.R. 6-30-2006.

ESSENTIAL NUTRACEUTICALS

THE MARK CONSISTS OF STANDARD CHARACTERS WITHOUT CLAIM TO ANY PARTICULAR FONT, STYLE, SIZE, OR COLOR.

NO CLAIM IS MADE TO THE EXCLUSIVE RIGHT TO USE "NUTRACEUTICALS", APART FROM THE MARK AS SHOWN.

FOR DIETARY SUPPLEMENTS (U.S. CLS. 6, 18, 44, 46, 51 AND 52).

FIRST USE 12-1-2005; IN COMMERCE 12-1-2005.

CLASS 6—METAL GOODS

3,178,701. OFFICERS ONLY INCORPORATED, OGDEN, UT.
SN 78-444,085. FILED P.R. 6-30-2004; AM. S.R. 9-27-2006.



THE COLOR(S) RED IS/ARE CLAIMED AS A FEATURE OF THE MARK.

THE MARK CONSISTS OF THE COLOR RED AS APPLIED TO THE ENTIRE HANDCUFF. THE CONFIGURATION OF THE GOODS IS NOT PART OF THE MARK AS SHOWN.

FOR RESTRAINTS, NAMELY, HANDCUFFS AND LEG IRONS (U.S. CLS. 2, 12, 13, 14, 23, 25 AND 50).
FIRST USE 6-0-2002; IN COMMERCE 6-0-2002.



3,178,702. OFFICERS ONLY INCORPORATED, OGDEN, UT.
SN 78-444,094. FILED P.R. 6-30-2004; AM. S.R. 9-27-2006.



THE COLOR(S) ORANGE IS/ARE CLAIMED AS A FEATURE OF THE MARK.

THE MARK CONSISTS OF THE COLOR ORANGE AS APPLIED TO THE ENTIRE HANDCUFF. THE CONFIGURATION OF THE GOODS IS NOT PART OF THE MARK AS SHOWN.

FOR RESTRAINTS, NAMELY, HANDCUFFS AND LEG IRONS (U.S. CLS. 2, 12, 13, 14, 23, 25 AND 50).
FIRST USE 6-0-2002; IN COMMERCE 6-0-2002.

CLASS 6—(Continued).

3,178,703. OFFICERS ONLY INCORPORATED, OGDEN, UT.
SN 78-444,104. FILED P.R. 6-30-2004; AM. S.R. 9-27-2006.



THE COLOR(S) BLUE IS/ARE CLAIMED AS A FEATURE OF THE MARK.

THE MARK CONSISTS OF THE COLOR BLUE AS APPLIED TO THE ENTIRE HANDCUFF. THE CONFIGURATION OF THE GOODS IS NOT PART OF THE MARK AS SHOWN.

FOR RESTRAINTS, NAMELY, HANDCUFFS AND LEG IRONS (U.S. CLS. 2, 12, 13, 14, 23, 25 AND 50).
FIRST USE 6-0-2002; IN COMMERCE 6-0-2002.



3,178,704. OFFICERS ONLY INCORPORATED, OGDEN, UT.
SN 78-444,108. FILED P.R. 6-30-2004; AM. S.R. 9-27-2006.



THE COLOR(S) PURPLE IS/ARE CLAIMED AS A FEATURE OF THE MARK.

THE MARK CONSISTS OF THE COLOR PURPLE AS APPLIED TO THE ENTIRE HANDCUFF. THE CONFIGURATION OF THE GOODS IS NOT PART OF THE MARK AS SHOWN.

FOR RESTRAINTS, NAMELY, HANDCUFFS AND LEG IRONS (U.S. CLS. 2, 12, 13, 14, 23, 25 AND 50).
FIRST USE 6-0-2002; IN COMMERCE 6-0-2002.



CLASS 7—MACHINERY

3,178,750. SAILRAIL AUTOMATED SYSTEMS INC., MARKHAM, ONTARIO, CANADA. SN 78-689,894. FILED P.R. 8-10-2005; AM. S.R. 8-23-2006.

INDEXER

THE MARK CONSISTS OF STANDARD CHARACTERS WITHOUT CLAIM TO ANY PARTICULAR FONT, STYLE, SIZE, OR COLOR.

CLASS 7—(Continued).

PRIORITY CLAIMED UNDER SEC. 44(D) ON CANADA APPLICATION NO. 1265785, FILED 7-21-2005, REG. NO. TMA668827, DATED 7-27-2006, EXPIRES 7-27-2021.

FOR MATERIALS HANDLING AND WAREHOUSING EQUIPMENT, NAMELY AUTOMATED LIFT AND CARRY ACCUMULATION SYSTEMS FOR MOVING, STORING AND RETRIEVING CARTS WITH PALLETIZED LOADS (U.S. CLS. 13, 19, 21, 23, 31, 34 AND 35).

3,178,754. DELAWARE CAPITAL FORMATION, INC., WILMINGTON, DE. SN 78-693,911. FILED P.R. 8-16-2005; AM. S.R. 9-11-2006.

EROTARY

THE MARK CONSISTS OF STANDARD CHARACTERS WITHOUT CLAIM TO ANY PARTICULAR FONT, STYLE, SIZE, OR COLOR.

OWNER OF U.S. REG. NOS. 556,864, 2,570,302, AND OTHERS.

FOR MACHINES, NAMELY, ELECTRIC MOTOR-DRIVEN ACTUATORS FOR THE AUTOMATION INDUSTRY (U.S. CLS. 13, 19, 21, 23, 31, 34 AND 35).

FIRST USE 9-30-2005; IN COMMERCE 9-30-2005.

3,178,757. FARADAY TECHNOLOGY, INC., CLAYTON, OH. SN 78-696,168. FILED P.R. 8-19-2005; AM. S.R. 9-15-2006.

FARADAYIC

THE MARK CONSISTS OF STANDARD CHARACTERS WITHOUT CLAIM TO ANY PARTICULAR FONT, STYLE, SIZE, OR COLOR.

FOR PLATING MACHINES; ETCHING MACHINES; REEL TO REEL PROCESSING MACHINES; COATING EVALUATION MACHINES; RECYCLING MACHINES; POWER SUPPLY MACHINES; AND WATER INTRUSION CONTROL MACHINES (U.S. CLS. 13, 19, 21, 23, 31, 34 AND 35).

FIRST USE 2-0-2003; IN COMMERCE 7-0-2006.

CLASS 8—HAND TOOLS**CLASS 8—(Continued).**

3,178,729. BLADE-TECH INDUSTRIES, INC., LAKEWOOD, WA. SN 78-595,799. FILED P.R. 3-27-2005; AM. S.R. 10-10-2006.



THE MARK IS A HOLE IN THE BLADE OF A FOLDING KNIFE. IN THE DRAWING, THE DASH-DOUBLE-DOT LINES DEPICT AN ENVIRONMENT FOR THE MARK, WHICH IS SHOWN IN SOLID LINES, AS A SOMEWHAT V-SHAPED HOLE IN THE BLADE OF A FOLDING KNIFE. FOR FOLDING KNIVES (U.S. CLS. 23, 28 AND 44). FIRST USE 6-1-2002; IN COMMERCE 6-1-2002.

3,178,810. MIDWEST TOOL AND CUTLERY COMPANY, STURGIS, MI. SN 78-842,996. FILED P.R. 3-22-2006; AM. S.R. 9-20-2006.

POWER CUTTER

THE MARK CONSISTS OF STANDARD CHARACTERS WITHOUT CLAIM TO ANY PARTICULAR FONT, STYLE, SIZE, OR COLOR.

FOR MULTI-PURPOSE SHEARS (U.S. CLS. 23, 28 AND 44).

FIRST USE 3-8-2006; IN COMMERCE 3-8-2006.

CLASS 9—ELECTRICAL AND SCIENTIFIC APPARATUS

3,178,684. ESCORT INC., WEST CHESTER, OH. SN 76-623,368. FILED P.R. 12-6-2004; AM. S.R. 9-27-2006.

THE RADAR AND LASER EXPERTS

THE MARK CONSISTS OF STANDARD CHARACTERS WITHOUT CLAIM TO ANY PARTICULAR FONT, STYLE, SIZE, OR COLOR.

FOR POLICE RADAR AND LASER DETECTORS COMBINED WITH AN AUDIBLE AND/OR VISIBLE WARNING ANNUNCIATOR (U.S. CLS. 21, 23, 26, 36 AND 38).

FIRST USE 4-0-2005; IN COMMERCE 4-0-2005.

CLASS 9—(Continued).

3,178,697. JAKKS PACIFIC, INC., MALIBU, CA. SN 78-383,611. FILED P.R. 3-12-2004; AM. S.R. 10-18-2005.

CLASS 9—(Continued).

3,178,726. RETAIL MANAGEMENT PRODUCTS LTD., DELAWARE, OH. SN 78-573,286. FILED P.R. 2-23-2005; AM. S.R. 10-4-2006.

SKATE SCENE PINBALL

THE MARK CONSISTS OF STANDARD CHARACTERS WITHOUT CLAIM TO ANY PARTICULAR FONT, STYLE, SIZE, OR COLOR.

NO CLAIM IS MADE TO THE EXCLUSIVE RIGHT TO USE "PINBALL", APART FROM THE MARK AS SHOWN.

FOR ELECTRONIC GAMES, NAMELY PORTABLE GAMING SYSTEM FOR USE WITH TELEVISIONS COMPRISED PRIMARILY OF A HAND HELD UNIT FOR PLAYING ELECTRONIC GAMES (U.S. CLS. 21, 23, 26, 36 AND 38).

FIRST USE 5-28-2004; IN COMMERCE 5-28-2004.

NDC SMART

THE MARK CONSISTS OF STANDARD CHARACTERS WITHOUT CLAIM TO ANY PARTICULAR FONT, STYLE, SIZE, OR COLOR.

NO CLAIM IS MADE TO THE EXCLUSIVE RIGHT TO USE "NDC", APART FROM THE MARK AS SHOWN.

FOR OPTICAL SCANNERS FOR READING BAR CODES (U.S. CLS. 21, 23, 26, 36 AND 38).

FIRST USE 10-3-2006; IN COMMERCE 10-3-2006.

3,178,720. INTEC, INC., MIAMI, FL. SN 78-562,188. FILED P.R. 2-7-2005; AM. S.R. 10-5-2006.

3,178,732. TRAPEZE NETWORKS, INC., PLEASANTON, CA. SN 78-610,527. FILED P.R. 4-17-2005; AM. S.R. 8-28-2006.

GAME BUDS

THE MARK CONSISTS OF STANDARD CHARACTERS WITHOUT CLAIM TO ANY PARTICULAR FONT, STYLE, SIZE, OR COLOR.

FOR AUDIO ACCESSORY FOR PORTABLE ELECTRONIC DEVICE, NAMELY EARPHONE SPEAKERS (U.S. CLS. 21, 23, 26, 36 AND 38).

FIRST USE 8-25-2004; IN COMMERCE 8-25-2004.

MOBILITY SYSTEM

THE MARK CONSISTS OF STANDARD CHARACTERS WITHOUT CLAIM TO ANY PARTICULAR FONT, STYLE, SIZE, OR COLOR.

NO CLAIM IS MADE TO THE EXCLUSIVE RIGHT TO USE "SYSTEM", APART FROM THE MARK AS SHOWN.

FOR COMPUTER NETWORKING HARDWARE FOR WIRELESS COMMUNICATIONS; COMPUTER NETWORKING SOFTWARE FOR WIRELESS COMMUNICATIONS AND CONNECTIVITY (U.S. CLS. 21, 23, 26, 36 AND 38).

FIRST USE 11-1-2002; IN COMMERCE 2-1-2003.

CLASS 9—(Continued).

3,178,740. 500 HOME RUN CLUB LLC, MARINA DEL RAY, CA. SN 78-660,115. FILED P.R. 6-28-2005; AM. S.R. 9-26-2006.

GREATEST POWER HITTERS

THE MARK CONSISTS OF STANDARD CHARACTERS WITHOUT CLAIM TO ANY PARTICULAR FONT, STYLE, SIZE, OR COLOR.

FOR VIDEO GAME CARTRIDGES AND DISCS; INTERACTIVE VIDEO GAME PROGRAMS; AND VIDEO GAME SOFTWARE (U.S. CLS. 21, 23, 26, 36 AND 38).
FIRST USE 6-0-2005; IN COMMERCE 6-0-2005.

CLASS 9—(Continued).

3,178,803. RAD DATA COMMUNICATIONS, TEL AVIV, ISRAEL. SN 78-811,227. FILED P.R. 2-9-2006; AM. S.R. 8-23-2006.

SYSTEM ON AN SFP

THE MARK CONSISTS OF STANDARD CHARACTERS WITHOUT CLAIM TO ANY PARTICULAR FONT, STYLE, SIZE, OR COLOR.

NO CLAIM IS MADE TO THE EXCLUSIVE RIGHT TO USE "SFP", APART FROM THE MARK AS SHOWN.
FOR TRANSCEIVERS (U.S. CLS. 21, 23, 26, 36 AND 38).
FIRST USE 7-11-2005; IN COMMERCE 7-11-2005.

3,178,755. AGORA INDUSTRIES, INC., EAGLE, ID. SN 78-694,295. FILED P.R. 8-17-2005; AM. S.R. 8-29-2006.

SECURMOUNT

THE MARK CONSISTS OF STANDARD CHARACTERS WITHOUT CLAIM TO ANY PARTICULAR FONT, STYLE, SIZE, OR COLOR.

FOR FULLY ADJUSTABLE, UNIVERSAL OR CUSTOM DESIGNED WALL, CEILING, UNDER CABINET, TABLETOP AND FLOOR MOUNTING AND DISPLAY DEVICES FOR AFFIXING TO LCD OR PLASMA TELEVISION MONITORS (U.S. CLS. 21, 23, 26, 36 AND 38).
FIRST USE 9-15-2005; IN COMMERCE 9-15-2005.

3,178,759. PFLANZ INTEGRATED SYSTEMS, SIOUX CITY, IA. SN 78-702,349. FILED P.R. 8-29-2005; AM. S.R. 9-13-2006.

PFLANZ INTEGRATED SYSTEMS

THE MARK CONSISTS OF STANDARD CHARACTERS WITHOUT CLAIM TO ANY PARTICULAR FONT, STYLE, SIZE, OR COLOR.

NO CLAIM IS MADE TO THE EXCLUSIVE RIGHT TO USE "INTEGRATED SYSTEMS", APART FROM THE MARK AS SHOWN.

FOR COMPUTER SOFTWARE FOR MANAGING A RETAILER TO MANAGE TRANSACTIONAL DATA, PROVIDE STATISTICAL ANALYSIS, PRODUCE NOTIFICATIONS, REPORTS, RECEIPTS, STATEMENTS, CUSTOMER SERVICE LOGS, PAYROLL, AND PRICE TAGS, PROVIDE TECHNICIAN AND DELIVERY SCHEDULING, AND ORDER PARTS ALL IN THE FIELD OF RETAIL SALES (U.S. CLS. 21, 23, 26, 36 AND 38).
FIRST USE 1-1-2005; IN COMMERCE 6-30-2005.

CLASS 10—MEDICAL APPARATUS

3,178,728. NDI MEDICAL, LLC, CLEVELAND, OH. SN 78-581,524. FILED P.R. 3-7-2005; AM. S.R. 9-12-2006.

MICROPULSE

THE MARK CONSISTS OF STANDARD CHARACTERS WITHOUT CLAIM TO ANY PARTICULAR FONT, STYLE, SIZE, OR COLOR.

FOR STIMULATOR FOR APPLYING ELECTRICAL PULSES DIRECTLY TO TISSUE (U.S. CLS. 26, 39 AND 44).
FIRST USE 8-16-2006; IN COMMERCE 8-16-2006.

3,178,802. HEADWEAR, LLC, CHARLOTTE, NC. SN 78-803,755. FILED P.R. 1-31-2006; AM. S.R. 10-2-2006.

HALO

THE MARK CONSISTS OF STANDARD CHARACTERS WITHOUT CLAIM TO ANY PARTICULAR FONT, STYLE, SIZE, OR COLOR.

FOR MEDICAL DEVICE FOR THE TREATMENT OF SLEEP DISORDERS; NAMELY, HEADGEAR DESIGNED FOR NON-INFANTS TO SUPPORT THE LOWER CHIN (U.S. CLS. 26, 39 AND 44).
FIRST USE 1-20-2006; IN COMMERCE 1-20-2006.

CLASS 11—ENVIRONMENTAL CONTROL APPARATUS

3,178,677. EUROPEAN TOUCH HOLDINGS, INC., MILWAUKEE, WI. SN 76-536,583. FILED P.R. 7-1-2003; AM. S.R. 3-10-2006.

PIPE-FREE

NO CLAIM IS MADE TO THE EXCLUSIVE RIGHT TO USE "PIPE", APART FROM THE MARK AS SHOWN. FOR PEDICURE WHIRLPOOL BATHS FOR THE FEET (U.S. CLS. 13, 21, 23, 31 AND 34). FIRST USE 7-0-2003; IN COMMERCE 9-0-2003.

3,178,682. SAVIO ENGINEERING, INC., SANTA FE, NM. SN 76-620,933. FILED P.R. 11-17-2004; AM. S.R. 8-7-2006.

POND FREE

THE MARK CONSISTS OF STANDARD CHARACTERS WITHOUT CLAIM TO ANY PARTICULAR FONT, STYLE, SIZE, OR COLOR.

FOR KITS FOR BUILDING WATER FEATURES WHICH DO NOT INCLUDE A POND, COMPRISING, WATER PUMPS, WATER FILTERS, WATER PURIFICATION UNITS, AND PLUMBING FITTINGS (U.S. CLS. 13, 21, 23, 31 AND 34). FIRST USE 4-1-2005; IN COMMERCE 4-1-2005.

3,178,776. J. KINDERMAN & SONS, INC., PHILADELPHIA, PA. SN 78-723,022. FILED P.R. 9-29-2005; AM. S.R. 9-28-2006.

Sparkling Lights

THE MARK CONSISTS OF STANDARD CHARACTERS WITHOUT CLAIM TO ANY PARTICULAR FONT, STYLE, SIZE, OR COLOR.

NO CLAIM IS MADE TO THE EXCLUSIVE RIGHT TO USE "LIGHTS", APART FROM THE MARK AS SHOWN. FOR ELECTRIC HOLIDAY LIGHTS (U.S. CLS. 13, 21, 23, 31 AND 34). FIRST USE 3-0-2004; IN COMMERCE 3-0-2004.

CLASS 12—VEHICLES**CLASS 12—(Continued).**

3,178,738. BRUCE KIRBY, INC., ROWAYTON, CT. SN 78-651,808. FILED P.R. 6-16-2005; AM. S.R. 7-17-2006.

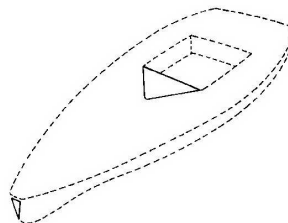

THE MARK CONSISTS OF THE PLACEMENT OF TRIANGULAR SHAPES ON THE SHALLOW RECESSED AREA OF THE DECK AND BOW OF A BOAT. FOR BOATS (U.S. CLS. 19, 21, 23, 31, 35 AND 44). FIRST USE 1-0-1971; IN COMMERCE 1-0-1971.

3,178,748. WALBRO INC., AURORA, CO. SN 78-681,779. FILED P.R. 7-29-2005; AM. S.R. 5-30-2006.

PRECISIONFIT SEAT COVERS

THE MARK CONSISTS OF STANDARD CHARACTERS WITHOUT CLAIM TO ANY PARTICULAR FONT, STYLE, SIZE, OR COLOR.

NO CLAIM IS MADE TO THE EXCLUSIVE RIGHT TO USE "SEAT COVERS", APART FROM THE MARK AS SHOWN. FOR VEHICLE SEAT COVERS (U.S. CLS. 19, 21, 23, 31, 35 AND 44). FIRST USE 6-0-2003; IN COMMERCE 6-0-2003.

CLASS 15—MUSICAL INSTRUMENTS

3,178,711. SION INC., KANAGAWA-KEN, JAPAN. SN 78-531,580. FILED P.R. 12-13-2004; AM. S.R. 9-8-2006.

SINGING RIN

THE MARK CONSISTS OF STANDARD CHARACTERS WITHOUT CLAIM TO ANY PARTICULAR FONT, STYLE,

CLASS 15—(Continued).

SIZE, OR COLOR.

THE ENGLISH TRANSLATION OF "RIN" IS "BUDDHIST ALTAR FITTING".

FOR MUSICAL INSTRUMENTS (U.S. CLS. 2, 21 AND 36).

FIRST USE 12-22-2004; IN COMMERCE 10-26-2005.

3,178,782. BRESNAN, DANIEL, WASHINGTON, CT. SN 78-728,420. FILED P.R. 10-6-2005; AM. S.R. 10-2-2006.

BRESNAN GUITARS

THE MARK CONSISTS OF STANDARD CHARACTERS WITHOUT CLAIM TO ANY PARTICULAR FONT, STYLE, SIZE, OR COLOR.

NO CLAIM IS MADE TO THE EXCLUSIVE RIGHT TO USE "GUITARS", APART FROM THE MARK AS SHOWN.

FOR GUITARS (U.S. CLS. 2, 21 AND 36).

FIRST USE 5-0-2005; IN COMMERCE 5-0-2005.

CLASS 16—PAPER GOODS AND PRINTED MATTER

3,178,678. TAFF, JAMI B., POTOMAC, MD. SN 76-598,416. FILED P.R. 6-21-2004; AM. S.R. 10-11-2006.

LAY-IT-OUT

THE MARK CONSISTS OF STANDARD CHARACTERS WITHOUT CLAIM TO ANY PARTICULAR FONT, STYLE, SIZE, OR COLOR.

FOR PRINTED MATERIALS CONSISTING OF FULL SCALE, LENGTH AND WIDTH DIMENSIONED TEMPLATES IN THE SHAPE OF ASSORTED, GENERIC FURNITURE PIECES, SUCH AS SOFAS, LOVESEATS AND CHAIRS, FOR USE IN HOME DESIGN AND DECORATING TO ASSIST THE USER IN DETERMINING WHERE TO LOCATE FURNITURE WITHIN A ROOM (U.S. CLS. 2, 5, 22, 23, 29, 37, 38 AND 50).

FIRST USE 10-0-2004; IN COMMERCE 10-0-2004.

CLASS 16—(Continued).

3,178,688. ROYAL CONSUMER PRODUCTS LLC, NORWALK, CT. SN 76-630,892. FILED P.R. 2-10-2005; AM. S.R. 10-17-2006.

CLEAN CUT

THE MARK CONSISTS OF STANDARD CHARACTERS WITHOUT CLAIM TO ANY PARTICULAR FONT, STYLE, SIZE, OR COLOR.

FOR PRINTABLE BLANK BUSINESS CARD PAPER (U.S. CLS. 2, 5, 22, 23, 29, 37, 38 AND 50).

FIRST USE 12-0-2003; IN COMMERCE 12-0-2003.

3,178,690. C. W. ALLEN GROUP, LLC, THE, BIRMINGHAM, AL. SN 76-645,221. FILED P.R. 8-18-2005; AM. S.R. 9-8-2006.

BUYERS' EVENT PLANNING KIT

THE MARK CONSISTS OF STANDARD CHARACTERS WITHOUT CLAIM TO ANY PARTICULAR FONT, STYLE, SIZE, OR COLOR.

NO CLAIM IS MADE TO THE EXCLUSIVE RIGHT TO USE "KIT", APART FROM THE MARK AS SHOWN.

FOR DIRECT MAILING POSTCARDS, PAMPHLETS, BROCHURES AND FLYERS IN THE FIELDS OF TRADESHOW MARKETING AND EXHIBITING (U.S. CLS. 2, 5, 22, 23, 29, 37, 38 AND 50).

FIRST USE 6-0-2005; IN COMMERCE 6-0-2005.

3,178,695. PLASTIC WELDING TECHNOLOGIES INTERNATIONAL, INC., DIAMOND SPRINGS, CA. SN 78-358,334. FILED P.R. 1-27-2004; AM. S.R. 8-21-2006.

PLASTIC WELDING TECHNOLOGIES

THE MARK CONSISTS OF STANDARD CHARACTERS WITHOUT CLAIM TO ANY PARTICULAR FONT, STYLE, SIZE, OR COLOR.

FOR PRINTED GOODS, NAMELY, CATALOGS, BROCHURES, PAMPHLETS, GUIDES, MANUALS, BOOKS, OPERATIONS MANUALS AND REPAIR MANUALS ALL ON THE SUBJECT OF INSTALLATION AND REPAIR OF MEMBRANE BARRIERS, NAMELY, GEOMEMBRANES, ROOFING MEMBRANES, LANDSCAPING MEMBRANES AND STRUCTURAL WATER PROOFING MEMBRANES; WRITING IMPLEMENTS; ALL OF THE FOREGOING FOR CONSTRUCTION AND ENGINEERING PROFESSIONALS (U.S. CLS. 2, 5, 22, 23, 29, 37, 38 AND 50).

FIRST USE 12-10-2001; IN COMMERCE 12-10-2001.

CLASS 16—(Continued).

3,178,700. PERRY, JASPER, ELLENWOOD, GA. SN 78-417,997. FILED P.R. 5-13-2004; AM. S.R. 9-29-2006.

CLASS 16—(Continued).

3,178,767. NEW YORK MAGAZINE HOLDINGS LLC, NEW YORK, NY. SN 78-711,847. FILED P.R. 9-13-2005; AM. S.R. 9-29-2006.

IT'S A GREAT DAY TO BE A REPUBLICAN

THE MARK CONSISTS OF STANDARD CHARACTERS WITHOUT CLAIM TO ANY PARTICULAR FONT, STYLE, SIZE, OR COLOR.
FOR STICKERS (U.S. CLS. 2, 5, 22, 23, 29, 37, 38 AND 50).
FIRST USE 11-0-2004; IN COMMERCE 11-0-2004.

THE APPROVAL MATRIX

THE MARK CONSISTS OF STANDARD CHARACTERS WITHOUT CLAIM TO ANY PARTICULAR FONT, STYLE, SIZE, OR COLOR.
NO CLAIM IS MADE TO THE EXCLUSIVE RIGHT TO USE "MATRIX", APART FROM THE MARK AS SHOWN.
FOR COLUMN IN A MAGAZINE ABOUT CURRENT ENTERTAINMENT AND POPULAR CULTURAL EVENTS (U.S. CLS. 2, 5, 22, 23, 29, 37, 38 AND 50).
FIRST USE 11-1-2004; IN COMMERCE 11-1-2004.

3,178,783. WORLD FUTURE SOCIETY, BETHESDA, MD. SN 78-729,134. FILED P.R. 10-7-2005; AM. S.R. 10-4-2006.

FUTURE SURVEY

THE MARK CONSISTS OF STANDARD CHARACTERS WITHOUT CLAIM TO ANY PARTICULAR FONT, STYLE, SIZE, OR COLOR.
NO CLAIM IS MADE TO THE EXCLUSIVE RIGHT TO USE "SURVEY", APART FROM THE MARK AS SHOWN.
FOR JOURNALS CONCERNING BOOKS, ARTICLES, AND REPORTS CONCERNING FORECASTS, TRENDS, AND IDEAS ABOUT THE FUTURE (U.S. CLS. 2, 5, 22, 23, 29, 37, 38 AND 50).
FIRST USE 1-1-1979; IN COMMERCE 1-1-1979.

3,178,719. AMERICAN SOCIETY OF CLINICAL ONCOLOGY, ALEXANDRIA, VA. SN 78-562,182. FILED P.R. 2-7-2005; AM. S.R. 3-2-2006.

3,178,784. NEWBAY MEDIA LLC, NEW YORK, NY. SN 78-729,160. FILED P.R. 10-7-2005; AM. S.R. 10-11-2006.

Journal of Oncology Practice

MUSIC TECHNOLOGY BUYER'S GUIDE

THE MARK CONSISTS OF STANDARD CHARACTERS WITHOUT CLAIM TO ANY PARTICULAR FONT, STYLE, SIZE, OR COLOR.
NO CLAIM IS MADE TO THE EXCLUSIVE RIGHT TO USE "JOURNAL", APART FROM THE MARK AS SHOWN.
FOR PRINTED MATTER, NAMELY, JOURNALS CONCERNING THE PRACTICE OF ONCOLOGY (U.S. CLS. 2, 5, 22, 23, 29, 37, 38 AND 50).
FIRST USE 5-0-2005; IN COMMERCE 5-0-2005.

THE MARK CONSISTS OF STANDARD CHARACTERS WITHOUT CLAIM TO ANY PARTICULAR FONT, STYLE, SIZE, OR COLOR.
NO CLAIM IS MADE TO THE EXCLUSIVE RIGHT TO USE "BUYER'S GUIDE", APART FROM THE MARK AS SHOWN.
FOR PUBLICATIONS, NAMELY, ANNUAL MAGAZINES IN THE FIELDS OF MUSIC, MUSICAL PERFORMERS AND EQUIPMENT RELATED TO THE USE OF MUSICAL INSTRUMENTS, AND MUSICAL AND ENTERTAINMENT TECHNOLOGY (U.S. CLS. 2, 5, 22, 23, 29, 37, 38 AND 50).
FIRST USE 1-0-1997; IN COMMERCE 1-0-1997.

CLASS 16—(Continued).

3,178,789. READING COMPREHENSION MINISTRY, MISSOULA., MT. SN 78-733,724. FILED P.R. 10-14-2005; AM. S.R. 10-13-2006.

CLASS 19—NON-METALLIC BUILDING MATERIALS

3,178,674. HOMELAND VINYL PRODUCTS, INC., BIRMINGHAM, AL. SN 76-361,399. FILED P.R. 1-18-2002; AM. S.R. 10-21-2002.

CHRISTIAN HOLY BIBLE

THE MARK CONSISTS OF STANDARD CHARACTERS WITHOUT CLAIM TO ANY PARTICULAR FONT, STYLE, SIZE, OR COLOR.

NO CLAIM IS MADE TO THE EXCLUSIVE RIGHT TO USE HOLY BIBLE, APART FROM THE MARK AS SHOWN.

FOR SERIES OF BOOKS IN THE FIELD OF RELIGION (U.S. CLS. 2, 5, 22, 23, 29, 37, 38 AND 50).

FIRST USE 4-15-2005; IN COMMERCE 5-17-2005.

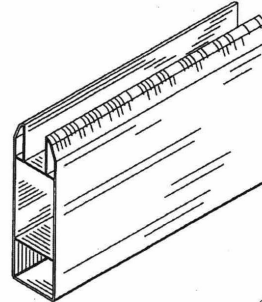

3,178,813. RICHARDSON COMPANY, PHILADELPHIA, PA. SN 78-847,578. FILED P.R. 3-28-2006; AM. S.R. 9-25-2006.

CYBERSALES TIPS

THE MARK CONSISTS OF STANDARD CHARACTERS WITHOUT CLAIM TO ANY PARTICULAR FONT, STYLE, SIZE, OR COLOR.

NO CLAIM IS MADE TO THE EXCLUSIVE RIGHT TO USE "TIPS", APART FROM THE MARK AS SHOWN.

FOR PRINTED NEWSLETTERS, EDUCATIONAL MATERIALS, AND PRINTED PERIODICALS ALL IN THE FIELD OF SALES AND SALES TECHNIQUES (U.S. CLS. 2, 5, 22, 23, 29, 37, 38 AND 50).

FIRST USE 1-1-2000; IN COMMERCE 1-1-2000.

THE LINING IN THE MARK IS FOR SHADING PURPOSES ONLY AND DOES NOT REPRESENT COLOR.

THE MARK CONSISTS OF THE CONFIGURATION OF A FENCE RAIL.

FOR NON-METAL FENCE RAILS (U.S. CLS. 1, 12, 33 AND 50).

FIRST USE 1-2-2002; IN COMMERCE 1-2-2002.

3,178,828. RICHARDSON COMPANY, PHILADELPHIA, PA. SN 78-939,851. FILED P.R. 7-28-2006; AM. S.R. 9-25-2006.

3,178,753. TIMBERTECH LIMITED, COLUMBUS, OH. SN 78-693,198. FILED P.R. 8-16-2005; AM. S.R. 10-2-2006.

BUILDERBOARD**CYBER SALES MANAGEMENT TIPS**

THE MARK CONSISTS OF STANDARD CHARACTERS WITHOUT CLAIM TO ANY PARTICULAR FONT, STYLE, SIZE, OR COLOR.

NO CLAIM IS MADE TO THE EXCLUSIVE RIGHT TO USE "SALES MANAGEMENT TIPS", APART FROM THE MARK AS SHOWN.

FOR PRINTED NEWSLETTERS, EDUCATIONAL MATERIALS, AND PRINTED PERIODICALS ALL IN THE FIELD OF SALES AND SALES TECHNIQUES (U.S. CLS. 2, 5, 22, 23, 29, 37, 38 AND 50).

FIRST USE 1-1-2003; IN COMMERCE 1-1-2003.

THE MARK CONSISTS OF STANDARD CHARACTERS WITHOUT CLAIM TO ANY PARTICULAR FONT, STYLE, SIZE, OR COLOR.

FOR GOODS MADE FROM A COMPOSITE MATERIAL, NAMELY, AN ENGINEERED BOARD MATERIAL MADE OF RECYCLED WOOD AND POLYMERS, USED AS A WOOD SUBSTITUTE, FOR BUILDING AND CONSTRUCTION (U.S. CLS. 1, 12, 33 AND 50).

FIRST USE 10-25-2005; IN COMMERCE 10-25-2005.

CLASS 19—(Continued).

3,178,785. THE W. W. HENRY COMPANY, L.P., ALIQUIPPA, PA. SN 78-730,425. FILED P.R. 10-11-2005; AM. S.R. 10-12-2006.

FLOOR SMOOTHER

THE MARK CONSISTS OF STANDARD CHARACTERS WITHOUT CLAIM TO ANY PARTICULAR FONT, STYLE, SIZE, OR COLOR.

FOR PORTLAND CEMENT-BASED SELF-LEVELING FLOORING UNDERLAYMENTS (U.S. CLS. 1, 12, 33 AND 50).

FIRST USE 11-30-2004; IN COMMERCE 11-30-2004.

CLASS 20—FURNITURE AND ARTICLES NOT OTHERWISE CLASSIFIED

3,178,686. EMECO INDUSTRIES, INC., HANOVER, PA. SN 76-628,100. FILED P.R. 12-15-2004; AM. S.R. 9-22-2006.

SUPERLIGHT

FOR CHAIRS (U.S. CLS. 2, 13, 22, 25, 32 AND 50).
FIRST USE 4-15-2004; IN COMMERCE 5-15-2004.

3,178,743. HITCHCOCK, DALLAS W., MALIBU, CA. SN 78-665,033. FILED P.R. 7-6-2005; AM. S.R. 3-31-2006.

TRUNQ

THE MARK CONSISTS OF STANDARD CHARACTERS WITHOUT CLAIM TO ANY PARTICULAR FONT, STYLE, SIZE, OR COLOR.

FOR CONTAINERS, NOT OF METAL, FOR THE STORAGE AND TRANSPORTATION OF SURFING GEAR NOT BEING LUGGAGE (U.S. CLS. 2, 13, 22, 25, 32 AND 50).

FIRST USE 8-8-2005; IN COMMERCE 8-8-2005.

CLASS 20—(Continued).

3,178,744. HITCHCOCK, DALLAS W., MALIBU, CA. SN 78-665,082. FILED P.R. 7-6-2005; AM. S.R. 3-31-2006.



FOR CONTAINERS, NOT OF METAL, FOR THE STORAGE AND TRANSPORTATION OF SURFING GEAR NOT BEING LUGGAGE (U.S. CLS. 2, 13, 22, 25, 32 AND 50).

FIRST USE 8-8-2005; IN COMMERCE 8-8-2005.

3,178,780. THE COAST DISTRIBUTION SYSTEM, INC., MORGAN HILL, CA. SN 78-727,426. FILED P.R. 10-5-2005; AM. S.R. 10-9-2006.

FOR OUTDOOR FURNITURE (U.S. CLS. 2, 13, 22, 25, 32 AND 50).

FIRST USE 2-0-2006; IN COMMERCE 2-0-2006.

CLASS 21—HOUSEWARES AND GLASS

3,178,681. GOLDMAX INDUSTRIES, INC., CITY OF INDUSTRY, CA. SN 76-616,383. FILED P.R. 10-18-2004; AM. S.R. 9-25-2006.

ELASTIQUE

THE MARK CONSISTS OF STANDARD CHARACTERS WITHOUT CLAIM TO ANY PARTICULAR FONT, STYLE, SIZE, OR COLOR.

THE ENGLISH TRANSLATION OF THE FRENCH WORD, ELASTIQUE, IS ELASTIC.

FOR GENERAL PURPOSE DISPOSABLE GLOVES MADE OF VINYL (U.S. CLS. 2, 13, 23, 29, 30, 33, 40 AND 50).

FIRST USE 10-0-2004; IN COMMERCE 10-0-2004.

CLASS 25—CLOTHING

CLASS 25—(Continued).

3,178,694. JUNE, RICKY G., NAPLES, FL. SN 78-273,390.
FILED P.R. 7-11-2003; AM. S.R. 9-5-2006.

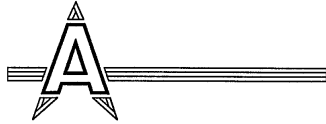

THE LINING IS A FEATURE OF THE MARK AND DOES NOT INDICATE COLOR.

THE MARK CONSISTS OF THE LETTER "A" IN UPPER CASE, INCLUDING THREE TRIANGULAR POINTS ORIENTED ABOUT THE LETTER, AND INCLUDING A HORIZONTAL BAR INTERSECTING THE LETTER A, THE HORIZONTAL BAR CONSISTING OF THREE STRIPES.

FOR CLOTHING, NAMELY SHIRTS, JACKETS, HATS, VISORS, AND SHORTS (U.S. CLS. 22 AND 39).

FIRST USE 10-15-2005; IN COMMERCE 10-15-2005.

3,178,712. BARTON, MARY, FORT PIERCE, FL. SN 78-533,194. FILED P.R. 12-15-2004; AM. S.R. 11-10-2005.

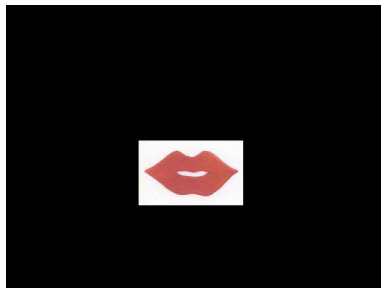

THE COLOR(S) RUBY RED IS/ARE CLAIMED AS A FEATURE OF THE MARK.

THE MARK CONSISTS OF RUBY RED LIPS.
FOR SHIRTS, PANTS, HATS, AND SHOES (U.S. CLS. 22 AND 39).

FIRST USE 11-1-2004; IN COMMERCE 11-1-2004.

CLASS 25—(Continued).

3,178,758. R.D. SIMPSON, INC., NEW YORK, NY. SN 78-699,426. FILED P.R. 8-24-2005; AM. S.R. 8-21-2006.

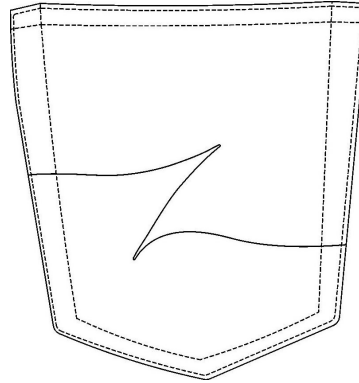

THE MARK CONSISTS OF THE STYLIZED LETTER "Z" STITCHED ACROSS THE BACK POCKETS OF JEANS. THE DOUBLE ROW OF BROKEN LINES AROUND THE INSIDE OF THE POCKET REPRESENTS STITCHING AND SHOWS THE POSITION OF THE MARK ON THE GOODS, AND IS NOT CLAIMED AS PART OF THE MARK.

FOR CLOTHING, NAMELY, JEANS (U.S. CLS. 22 AND 39).

FIRST USE 8-1-2002; IN COMMERCE 8-1-2002.

3,178,760. LORIA, STEVE, V., LOS ANGELES, CA. SN 78-703,904. FILED P.R. 8-31-2005; AM. S.R. 9-15-2006.

GROwN Up BiBs

THE MARK CONSISTS OF STANDARD CHARACTERS WITHOUT CLAIM TO ANY PARTICULAR FONT, STYLE, SIZE, OR COLOR.

NO CLAIM IS MADE TO THE EXCLUSIVE RIGHT TO USE "BIBS", APART FROM THE MARK AS SHOWN.

FOR CLOTH BIBS FOR ADULTS; PLASTIC BIBS FOR ADULTS (U.S. CLS. 22 AND 39).

FIRST USE 9-9-2006; IN COMMERCE 9-9-2006.

CLASS 25—(Continued).

3,178,765. WILLVER SEVILLEY, LLC, NEW YORK, NY. SN 78-709,717. FILED P.R. 9-9-2005; AM. S.R. 9-20-2006.

YOU'RE ALREADY ON THE JOURNEY

THE MARK CONSISTS OF STANDARD CHARACTERS WITHOUT CLAIM TO ANY PARTICULAR FONT, STYLE, SIZE, OR COLOR.

FOR CLOTHING, NAMELY, T-SHIRTS (U.S. CLS. 22 AND 39).

FIRST USE 8-17-2005; IN COMMERCE 8-17-2005.

3,178,775. WEITENG, DAI, FUJIAN PROVINCE, CHINA. SN 78-720,952. FILED P.R. 9-26-2005; AM. S.R. 10-5-2006.

KUERTEN

THE MARK CONSISTS OF STANDARD CHARACTERS WITHOUT CLAIM TO ANY PARTICULAR FONT, STYLE, SIZE, OR COLOR.

FOR CLOTHING, NAMELY, SHIRTS, T-SHIRTS, TROUSERS, SHORTS, DRESSES, COATS, JACKETS; FOOTWEAR; HATS AND CAPS; LAYETTES; UNDERWEAR; SPORTS SHIRTS; SPORTS JACKETS; COLLARS; WATERPROOF JACKETS AND PANTS; MASQUERADE COSTUMES; ATHLETIC SHOES; SHOE SOLES; SOCKS; GLOVES; NECKTIES; SCARVES; BELTS FOR CLOTHING; WEDDING GOWNS (U.S. CLS. 22 AND 39).

FIRST USE 12-15-2003; IN COMMERCE 10-21-2005.

3,178,793. NEW YORK CASUAL LLC, GRAND BLANC, MI. SN 78-759,901. FILED P.R. 11-23-2005; AM. S.R. 10-6-2006.

New York Casual

THE MARK CONSISTS OF STANDARD CHARACTERS WITHOUT CLAIM TO ANY PARTICULAR FONT, STYLE, SIZE, OR COLOR.

FOR MEN AND WOMEN JACKETS, COATS, TROUSERS, VESTS (U.S. CLS. 22 AND 39).

FIRST USE 7-18-2005; IN COMMERCE 7-18-2005.

CLASS 25—(Continued).

3,178,819. BALLARD, STEVE R., MANHATTAN, KS. SN 78-870,215. FILED P.R. 4-26-2006; AM. S.R. 10-2-2006.



NO CLAIM IS MADE TO THE EXCLUSIVE RIGHT TO USE "SINCE 2006", APART FROM THE MARK AS SHOWN. THE COLORS PURPLE AND WHITE ARE CLAIMED AS A FEATURE OF THE MARK.

THE COLOR PURPLE APPEARS IN THE BACKGROUND OF THE ENTIRE MARK; THE COLOR WHITE APPEARS IN ALL OF THE LETTERING, DOTS AND BASKETBALL HOOP, NET AND BACKBOARD.

FOR T-SHIRTS, HATS, JACKETS, SWEATSHIRTS, TANK TOPS (U.S. CLS. 22 AND 39).

FIRST USE 3-31-2006; IN COMMERCE 3-31-2006.

CLASS 28—TOYS AND SPORTING GOODS

3,178,731. AB COLLAR INTERNATIONAL, INC., SAN DIEGO, CA. SN 78-609,993. FILED P.R. 4-15-2005; AM. S.R. 9-22-2006.

ABCOLLAR

THE MARK CONSISTS OF STANDARD CHARACTERS WITHOUT CLAIM TO ANY PARTICULAR FONT, STYLE, SIZE, OR COLOR.

FOR MANUALLY OPERATED EXERCISE EQUIPMENT (U.S. CLS. 22, 23, 38 AND 50).

FIRST USE 4-1-2005; IN COMMERCE 1-1-2006.

CLASS 28—(Continued).

3,178,739. HEBBLETHWAITE, SUSAN, MONTREAL, QUEBEC, CANADA. SN 78-653,443. FILED P.R. 6-17-2005; AM. S.R. 7-16-2006.

COMIC CUBE PUZZLE

NO CLAIM IS MADE TO THE EXCLUSIVE RIGHT TO USE CUBE PUZZLE, APART FROM THE MARK AS SHOWN.

THE COLOR(S) BLUE IS/ARE CLAIMED AS A FEATURE OF THE MARK.

THE MARK CONSISTS OF LETTERING APPEARING IN THE COLOR BLUE.

FOR GAMES, NAMELY PUZZLES, BRAIN TEASING PUZZLES AND MANIPULATIVE PUZZLES (U.S. CLS. 22, 23, 38 AND 50).

FIRST USE 4-19-2004; IN COMMERCE 10-8-2004.

3,178,751. BONE-A-FIDE FITNESS, LLC, RIDGEFIELD, CT. SN 78-691,002. FILED P.R. 8-11-2005; AM. S.R. 9-13-2006.

BODYMAT

THE MARK CONSISTS OF STANDARD CHARACTERS WITHOUT CLAIM TO ANY PARTICULAR FONT, STYLE, SIZE, OR COLOR.

FOR PERSONAL EXERCISE MATS (U.S. CLS. 22, 23, 38 AND 50).

FIRST USE 11-3-2005; IN COMMERCE 11-3-2005.

3,178,778. SHUFFLE MASTER, INC., LAS VEGAS, NV. SN 78-724,557. FILED P.R. 9-30-2005; AM. S.R. 10-6-2006.

THREE CARD POKER

THE MARK CONSISTS OF STANDARD CHARACTERS WITHOUT CLAIM TO ANY PARTICULAR FONT, STYLE, SIZE, OR COLOR.

OWNER OF U.S. REG. NOS. 2,233,569, 3,011,356, AND OTHERS.

FOR LOTTERY GAMES, NAMELY, SCRATCH OFF LOTTERY CARDS, LOTTERY TICKETS AND INSTANT LOTTERY TICKETS (U.S. CLS. 22, 23, 38 AND 50).

FIRST USE 10-1-2006; IN COMMERCE 10-1-2006.

CLASS 30—STAPLE FOODS

CLASS 30—(Continued).

3,178,706. STANGEL, JOHN V., SAN ANTONIO, TX. SN 78-501,263. FILED P.R. 10-18-2004; AM. S.R. 10-4-2006.

**TEXAS COWBOY
COFFEE**

THE MARK CONSISTS OF STANDARD CHARACTERS WITHOUT CLAIM TO ANY PARTICULAR FONT, STYLE, SIZE, OR COLOR.

NO CLAIM IS MADE TO THE EXCLUSIVE RIGHT TO USE "COFFEE", APART FROM THE MARK AS SHOWN.

FOR COFFEE, COFFEE BEANS, GROUND COFFEE BEANS (U.S. CL. 46).

FIRST USE 4-7-2004; IN COMMERCE 4-7-2004.

3,178,733. VITALICIOUS INC., NEW YORKE, NY. SN 78-624,573. FILED P.R. 5-6-2005; AM. S.R. 7-11-2006.

ONLY 100 DELICIOUS CALORIES

THE MARK CONSISTS OF STANDARD CHARACTERS WITHOUT CLAIM TO ANY PARTICULAR FONT, STYLE, SIZE, OR COLOR.

FOR FAT FREE, LOW FAT BAKED GOODS, NAMELY MUFFINS, MUFFIN TOPS, COOKIES, CAKES, BROWNIES (U.S. CL. 46).

FIRST USE 1-1-2004; IN COMMERCE 1-1-2004.

3,178,826. TYSON FOODS, INC., SPRINGDALE, AR. SN 78-880,187. FILED P.R. 5-10-2006; AM. S.R. 10-9-2006.

ORIGINAL WRAPS

THE MARK CONSISTS OF STANDARD CHARACTERS WITHOUT CLAIM TO ANY PARTICULAR FONT, STYLE, SIZE, OR COLOR.

OWNER OF U.S. REG. NO. 2,330,359.

FOR TORTILLAS (U.S. CL. 46).

FIRST USE 1-0-1997; IN COMMERCE 1-0-1997.

CLASS 31—NATURAL AGRICULTURAL PRODUCTS

CLASS 31—(Continued).

3,178,725. THE KROGER CO. OF MICHIGAN, LIVONIA, MI.
SN 78-567,837. FILED P.R. 2-15-2005; AM. S.R. 9-20-2006.

GOOD 'N' MEATY

THE MARK CONSISTS OF STANDARD CHARACTERS
WITHOUT CLAIM TO ANY PARTICULAR FONT, STYLE,
SIZE, OR COLOR.

FOR DOG FOOD, NAMELY BURGERS FOR DOGS
(U.S. CLS. 1 AND 46).
FIRST USE 5-1-2006; IN COMMERCE 5-1-2006.

3,178,786. KAWAHARA NURSERY, INC., MORGAN HILL,
CA. SN 78-732,043. FILED P.R. 10-12-2005; AM. S.R. 10-3-
2006.

QUICKCOLOR

THE MARK CONSISTS OF STANDARD CHARACTERS
WITHOUT CLAIM TO ANY PARTICULAR FONT, STYLE,
SIZE, OR COLOR.

FOR LIVE PLANTS, FLOWERS, LIVE FLOWERING
PLANTS (U.S. CLS. 1 AND 46).
FIRST USE 2-24-2005; IN COMMERCE 2-24-2005.

CLASS 32—LIGHT BEVERAGES

3,178,689. JUICEHEADS, INC., SAN BERNARDINO, CA. SN
76-641,916. FILED P.R. 6-29-2005; AM. S.R. 9-18-2006.



-THE WORDS SENOR TORRES IS SPANISH FOR MR.
TOWERS.-

FOR BEVERAGES, NAMELY FRUIT JUICES, VEGE-
TABLE JUICES AND SMOOTHIES (U.S. CLS. 45, 46 AND
48).
FIRST USE 7-30-2005; IN COMMERCE 7-30-2005.

CLASS 32—(Continued).

3,178,696. OLD EUROPEAN BREWERY COMPANY, SAN
DIEGO, CA. SN 78-365,034. FILED P.R. 2-9-2004; AM. S.R. 3-
23-2005.

**PREMIUM DORADA
LIGHT LAGER**

THE MARK CONSISTS OF STANDARD CHARACTERS
WITHOUT CLAIM TO ANY PARTICULAR FONT, STYLE,
SIZE, OR COLOR.

NO CLAIM IS MADE TO THE EXCLUSIVE RIGHT TO
USE "DORADA LIGHT LAGER", APART FROM THE
MARK AS SHOWN.

THE FOREIGN WORDING IN THE MARK TRANSLATES
INTO ENGLISH AS GOLDEN.

FOR BEER (U.S. CLS. 45, 46 AND 48).
FIRST USE 4-0-2004; IN COMMERCE 4-0-2004.

3,178,721. COORS GLOBAL PROPERTIES, INC., LAKE-
WOOD, CO. SN 78-562,737. FILED P.R. 2-8-2005; AM. S.R.
9-15-2006.

**BREWED WITH ROCKY
MOUNTAIN WATER IN
GOLDEN COLORADO**

THE MARK CONSISTS OF STANDARD CHARACTERS
WITHOUT CLAIM TO ANY PARTICULAR FONT, STYLE,
SIZE, OR COLOR.

OWNER OF U.S. REG. NOS. 519,643, 2,591,793, AND
OTHERS.

FOR BEER (U.S. CLS. 45, 46 AND 48).
FIRST USE 11-30-2004; IN COMMERCE 11-30-2004.

CLASS 32—(Continued).

3,178,736. FRIES, ALEXANDER E., SARATOGA, CA. AND HEIM, JIM, SARATOGA, CA. SN 78-643,746. FILED P.R. 6-4-2005; AM. S.R. 9-22-2006.

Pure Swiss

THE MARK CONSISTS OF STANDARD CHARACTERS WITHOUT CLAIM TO ANY PARTICULAR FONT, STYLE, SIZE, OR COLOR.

FOR BOTTLED WATER (U.S. CLS. 45, 46 AND 48).
FIRST USE 2-1-2005; IN COMMERCE 8-31-2006.

CLASS 34—(Continued).

3,178,708. RUBIN, ALAN, WESTON, FL. SN 78-505,875. FILED P.R. 10-26-2004; AM. S.R. 9-22-2006.

HAVANA SUN GROWN

THE MARK CONSISTS OF STANDARD CHARACTERS WITHOUT CLAIM TO ANY PARTICULAR FONT, STYLE, SIZE, OR COLOR.

NO CLAIM IS MADE TO THE EXCLUSIVE RIGHT TO USE "SUN GROWN", APART FROM THE MARK AS SHOWN.

FOR CIGARS MADE WITH CUBAN SEED TOBACCO, CIGAR BANDS AND CIGAR CUTTERS (U.S. CLS. 2, 8, 9 AND 17).

FIRST USE 8-1-2001; IN COMMERCE 8-1-2001.

3,178,824. TROPICANA PRODUCTS, INC., BRADENTON, FL. SN 78-876,308. FILED P.R. 5-4-2006; AM. S.R. 10-10-2006.

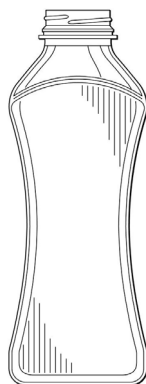

NO CLAIM IS MADE TO THE EXCLUSIVE RIGHT TO USE THE ORDINARY BOTTLE CONFIGURATION FEATURES OF A SCREW TOP, FLAT BOTTOM AND OVERALL CYLINDRICAL SHAPE, APART FROM THE MARK AS SHOWN.

THE VERTICAL LINING ON THE UPPER RIGHT AND LOWER LEFT OF THE DRAWING IS FOR SHADING PURPOSES ONLY.

THE FEATURES CLAIMED AS THE MARK ARE THE INWARDLY SLOPING FOUR SIDES OF THE BOTTLE CONFIGURATION.

FOR FRUIT JUICE AND NON-ALCOHOLIC FRUIT JUICE BEVERAGES (U.S. CLS. 45, 46 AND 48).

FIRST USE 5-1-2006; IN COMMERCE 5-1-2006.

3,178,746. SANTA CLARA, INC., WHIPPANY, NJ. SN 78-666,455. FILED P.R. 7-8-2005; AM. S.R. 10-17-2006.

Barrister Bookcase Humidor

THE MARK CONSISTS OF STANDARD CHARACTERS WITHOUT CLAIM TO ANY PARTICULAR FONT, STYLE, SIZE, OR COLOR.

NO CLAIM IS MADE TO THE EXCLUSIVE RIGHT TO USE "HUMIDOR", APART FROM THE MARK AS SHOWN.

FOR HUMIDOR (U.S. CLS. 2, 8, 9 AND 17).

FIRST USE 8-24-2004; IN COMMERCE 8-24-2004.

SERVICE MARKS

CLASS 35—ADVERTISING AND BUSINESS

3,178,687. TENNISON GROUP, DENVER, CO. SN 76-628,842. FILED P.R. 1-24-2005; AM. S.R. 8-21-2006.

TENNISON GROUP

THE MARK CONSISTS OF STANDARD CHARACTERS WITHOUT CLAIM TO ANY PARTICULAR FONT, STYLE, SIZE, OR COLOR.

NO CLAIM IS MADE TO THE EXCLUSIVE RIGHT TO USE "GROUP", APART FROM THE MARK AS SHOWN.

FOR PERSONNEL PLACEMENT AND RECRUITMENT SERVICES (U.S. CLS. 100, 101 AND 102).

FIRST USE 12-0-2004; IN COMMERCE 12-0-2004.

CLASS 34—SMOKERS' ARTICLES

CLASS 35—(Continued).

3,178,716. PROGRAM PLANNING PROFESSIONALS, INC., ANN ARBOR, MI. SN 78-552,499. FILED P.R. 1-24-2005; AM. S.R. 7-24-2006.

MPUG Global

THE MARK CONSISTS OF STANDARD CHARACTERS WITHOUT CLAIM TO ANY PARTICULAR FONT, STYLE, SIZE, OR COLOR.

NO CLAIM IS MADE TO THE EXCLUSIVE RIGHT TO USE "GLOBAL", APART FROM THE MARK AS SHOWN.

FOR USER GROUP SERVICES, NAMELY PROMOTING THE INTERESTS OF COMPUTER SOFTWARE PROJECT MANAGEMENT PROFESSIONALS (U.S. CLS. 100, 101 AND 102).

FIRST USE 4-1-1997; IN COMMERCE 4-1-1997.

3,178,723. PROMEDICA HEALTH SYSTEM, TOLEDO, OH. SN 78-564,801. FILED P.R. 2-10-2005; AM. S.R. 9-25-2006.

Lake Erie Regional Cooperative

THE MARK CONSISTS OF STANDARD CHARACTERS WITHOUT CLAIM TO ANY PARTICULAR FONT, STYLE, SIZE, OR COLOR.

NO CLAIM IS MADE TO THE EXCLUSIVE RIGHT TO USE REGIONAL COOPERATIVE, APART FROM THE MARK AS SHOWN.

FOR COOPERATIVE PURCHASING SERVICES FOR HOSPITALS AND HEALTH CARE ORGANIZATIONS (U.S. CLS. 100, 101 AND 102).

FIRST USE 12-1-2003; IN COMMERCE 12-1-2003.

3,178,770. SERENA SOFTWARE, INC., SAN MATEO, CA. SN 78-714,193. FILED P.R. 9-15-2005; AM. S.R. 10-2-2006.

CHANGE GOVERNANCE

CLASS 35—(Continued).

THE MARK CONSISTS OF STANDARD CHARACTERS WITHOUT CLAIM TO ANY PARTICULAR FONT, STYLE, SIZE, OR COLOR.

FOR BUSINESS CONSULTING SERVICES IN THE FIELD OF IMPLEMENTING AND MANAGING CHANGES THROUGHOUT AN ENTERPRISE, COMPANY OR ORGANIZATION, NAMELY, IDENTIFYING AND QUANTIFYING THE COSTS AND BENEFITS OF DEALING WITH SUCH CHANGE, ESTABLISHING CHANGE AND IMPLEMENTING CHANGE MANAGEMENT PRACTICES AND SOLUTIONS (U.S. CLS. 100, 101 AND 102).

FIRST USE 9-15-2006; IN COMMERCE 9-15-2006.

3,178,774. CBK STYLES, INC., UNION CITY, TN. SN 78-720,393. FILED P.R. 9-26-2005; AM. S.R. 9-20-2006.

METAL ARTS

THE MARK CONSISTS OF STANDARD CHARACTERS WITHOUT CLAIM TO ANY PARTICULAR FONT, STYLE, SIZE, OR COLOR.

NO CLAIM IS MADE TO THE EXCLUSIVE RIGHT TO USE "ARTS", APART FROM THE MARK AS SHOWN.

FOR WHOLESALE DISTRIBUTORSHIP SERVICES FEATURING GIFTWARE AND HOME ACCESSORIES INTENDED FOR INTERIOR OR EXTERIOR USE, NAMELY, WALL DECOR, MIRRORS, PICTURE FRAMES, SERVEWARE, PLANTERS, VASES, OBJECTS D'ART, BOOK ENDS, BOOK RESTS, BOOK STANDS, CANDLE HOLDERS, SCONCES, PLATE RACKS, DOORSTOPS, STATUETTES, FIGURINES, FURNITURE, PILLOWS, CUSHIONS, TEXTILES, BEVERAGE RACKS, LAMPS, BASKETS, STOCKING HOLDERS, TREE ORNAMENTS, TREE SKIRTS AND STOCKING HOLDERS (U.S. CLS. 100, 101 AND 102).

FIRST USE 0-0-2001; IN COMMERCE 0-0-2001.

3,178,797. PRIME SITES, INC., LOS ANGELES, CA. SN 78-783,338. FILED P.R. 12-30-2005; AM. S.R. 7-31-2006.

AUDITIONS.COM

THE MARK CONSISTS OF STANDARD CHARACTERS WITHOUT CLAIM TO ANY PARTICULAR FONT, STYLE, SIZE, OR COLOR.

FOR ONLINE DATABASE TALENT AGENCIES WHERE TALENT PROFILES GET MATCHED AND SUBMITTED TO CURRENT CASTINGS AND AUDITIONS (U.S. CLS. 100, 101 AND 102).

FIRST USE 4-30-1996; IN COMMERCE 4-30-1996.

CLASS 35—(Continued).

3,178,804. ALPER'S JOBBING, LLC, SAN ANTONIO, TX. SN 78-822,969. FILED P.R. 2-24-2006; AM. S.R. 10-16-2006.

COPSHOES

THE MARK CONSISTS OF STANDARD CHARACTERS WITHOUT CLAIM TO ANY PARTICULAR FONT, STYLE, SIZE, OR COLOR.

FOR ON-LINE RETAIL STORE SERVICES FEATURING FOOTWEAR (U.S. CLS. 100, 101 AND 102). FIRST USE 8-31-2003; IN COMMERCE 8-31-2003.

3,178,812. W. P. TAX & ACCOUNTING SERVICES, OWING MILLS, MD. AND WEBPAGE INCORPORATED, OWINGS MILLS, MD. SN 78-846,091. FILED P.R. 3-24-2006; AM. S.R. 9-16-2006.

I.T. & FINANCIAL COMPANY

THE MARK CONSISTS OF STANDARD CHARACTERS WITHOUT CLAIM TO ANY PARTICULAR FONT, STYLE, SIZE, OR COLOR.

NO CLAIM IS MADE TO THE EXCLUSIVE RIGHT TO USE "COMPANY", APART FROM THE MARK AS SHOWN.

FOR ACCOUNT AUDITING; ACCOUNTANCY SERVICES; ACCOUNTING CONSULTATION; ACCOUNTING SERVICES; ACCOUNTS RECEIVABLE SERVICES; BUSINESS ADVISORY SERVICES, CONSULTANCY AND INFORMATION; BUSINESS CONSULTING AND INFORMATION SERVICES; BUSINESS INFORMATION AND ACCOUNTING ADVISORY SERVICES; BUSINESS INFORMATION MANAGEMENT; INFORMATION, ADVISORY AND CONSULTANCY SERVICES RELATING TO BUSINESS AND MANAGEMENT OR BUSINESS ADMINISTRATION, INCLUDING SUCH SERVICES PROVIDED ON LINE OR VIA THE INTERNET; PROVIDING INFORMATION ABOUT COMMERCIAL BUSINESS AND COMMERCIAL INFORMATION VIA THE GLOBAL COMPUTER NETWORK; TAX AND TAXATION PLANNING, ADVICE, INFORMATION AND CONSULTANCY SERVICES (U.S. CLS. 100, 101 AND 102). FIRST USE 1-1-2000; IN COMMERCE 1-1-2000.

CLASS 35—(Continued).

3,178,822. MUNOZ, RAFAEL, WHITTIER, CA. SN 78-876,012. FILED P.R. 5-3-2006; AM. S.R. 10-18-2006.

BUYMYLIFT.COM

THE MARK CONSISTS OF STANDARD CHARACTERS WITHOUT CLAIM TO ANY PARTICULAR FONT, STYLE, SIZE, OR COLOR.

FOR ADVERTISING SERVICES; RETAIL STORES FEATURING INDUSTRIAL LIFT TRUCKS; WHOLESALE STORES FEATURING INDUSTRIAL LIFT TRUCKS (U.S. CLS. 100, 101 AND 102). FIRST USE 4-1-2005; IN COMMERCE 5-1-2005.

CLASS 36—INSURANCE AND FINANCIAL

3,178,675. DUNDEE CORPORATION, TORONTO, ONTARIO, CANADA. SN 76-371,678. FILED P.R. 2-15-2002; AM. S.R. 8-30-2006.

DISCIPLINED WEALTH MANAGEMENT

PRIORITY CLAIMED UNDER SEC. 44(D) ON CANADA APPLICATION NO. 1127173, FILED 1-10-2002, REG. NO. TMA634957, DATED 3-10-2005, EXPIRES 3-10-2020.

NO CLAIM IS MADE TO THE EXCLUSIVE RIGHT TO USE WEALTH MANAGEMENT, APART FROM THE MARK AS SHOWN.

FOR MANAGING MUTUAL FUNDS (U.S. CLS. 100, 101 AND 102).

3,178,676. DUNDEE CORPORATION, TORONTO, ONTARIO, CANADA. SN 76-371,725. FILED P.R. 2-15-2002; AM. S.R. 8-30-2006.

DISCIPLINED INVESTMENT SOLUTIONS

PRIORITY CLAIMED UNDER SEC. 44(D) ON CANADA APPLICATION NO. 1127172, FILED 1-10-2002, REG. NO. TMA635146, DATED 3-14-2005, EXPIRES 3-14-2020.

NO CLAIM IS MADE TO THE EXCLUSIVE RIGHT TO USE INVESTMENT SOLUTIONS, APART FROM THE MARK AS SHOWN.

FOR MANAGING MUTUAL FUNDS (U.S. CLS. 100, 101 AND 102).

3,178,679. MARSH USA INC., NEW YORK, NY. SN 76-604,536. FILED P.R. 7-28-2004; AM. S.R. 9-6-2005.

RISK-ADJUSTED SUPPLY CHAIN MANAGEMENT

CLASS 36—(Continued).

THE MARK CONSISTS OF STANDARD CHARACTERS WITHOUT CLAIM TO ANY PARTICULAR FONT, STYLE, SIZE, OR COLOR.

NO CLAIM IS MADE TO THE EXCLUSIVE RIGHT TO USE SUPPLY CHAIN MANAGEMENT, APART FROM THE MARK AS SHOWN.

FOR FINANCIAL MANAGEMENT SERVICES, NAMELY, EVALUATION AND QUANTIFICATION OF RISKS IN AN ORGANIZATION'S SUPPLY CHAIN; IDENTIFICATION AND ASSESSMENT OF VULNERABILITIES, RISK ALTERNATIVES, AND ECONOMIC IMPACT OF AN ORGANIZATION'S SUPPLY CHAIN RISK PROFILE; IDENTIFICATION OF STRATEGIES TO MINIMIZE THE RISKS IN AN ORGANIZATION'S SUPPLY CHAIN (U.S. CLS. 100, 101 AND 102).

FIRST USE 8-0-2003; IN COMMERCE 8-0-2003.

CLASS 36—(Continued).

3,178,709. ALTERNATIVE INVESTMENT RESEARCH AND TECHNOLOGIES LLC, NEW YORK, NY. SN 78-520,115. FILED P.R. 11-19-2004; AM. S.R. 9-28-2006.

INSTITUTIONAL BENCHMARKS SERIES

3,178,691. OFFICE OF THE ASSISTANT SECRETARY FOR ADMINISTRATION AND MANAGEMENT, WASHINGTON, DC. SN 76-646,320. FILED P.R. 9-6-2005; AM. S.R. 9-13-2006.

GOVLOANS.GOV

THE MARK CONSISTS OF STANDARD CHARACTERS WITHOUT CLAIM TO ANY PARTICULAR FONT, STYLE, SIZE, OR COLOR.

FOR PROVIDING INFORMATION IN THE FIELD OF FEDERAL GOVERNMENT LOANS AND LOAN PROGRAMS (U.S. CLS. 100, 101 AND 102).

FIRST USE 4-29-2004; IN COMMERCE 4-29-2004.

THE MARK CONSISTS OF STANDARD CHARACTERS WITHOUT CLAIM TO ANY PARTICULAR FONT, STYLE, SIZE, OR COLOR.

NO CLAIM IS MADE TO THE EXCLUSIVE RIGHT TO USE SERIES, APART FROM THE MARK AS SHOWN.

FOR FINANCIAL INVESTMENT IN THE FIELDS OF ALTERNATIVE ASSETS AND HEDGE FUNDS; FINANCIAL MANAGEMENT IN THE FIELDS OF ALTERNATIVE ASSETS AND HEDGE FUNDS (U.S. CLS. 100, 101 AND 102).

FIRST USE 10-10-2003; IN COMMERCE 10-10-2003.

3,178,692. OFFICE OF THE ASSISTANT SECRETARY FOR ADMINISTRATION AND MANAGEMENT, WASHINGTON, DC. SN 76-646,323. FILED P.R. 9-6-2005; AM. S.R. 9-13-2006.

GOVBENEFITS.GOV

THE MARK CONSISTS OF STANDARD CHARACTERS WITHOUT CLAIM TO ANY PARTICULAR FONT, STYLE, SIZE, OR COLOR.

FOR PROVIDING INFORMATION IN THE FIELD OF FEDERAL GOVERNMENT BENEFITS, AND BENEFITS AND ASSISTANCE PROGRAMS (U.S. CLS. 100, 101 AND 102).

FIRST USE 4-29-2002; IN COMMERCE 4-29-2002.

3,178,715. ADVANCED EDUCATION SYSTEMS, LLC, LUTHERVILLE, MD. SN 78-547,001. FILED P.R. 1-13-2005; AM. S.R. 9-8-2006.

LENDING NET

THE MARK CONSISTS OF STANDARD CHARACTERS WITHOUT CLAIM TO ANY PARTICULAR FONT, STYLE, SIZE, OR COLOR.

FOR PROVIDING FINANCIAL INFORMATION ON MORTGAGE LOANS, AUTO AND CONSUMER LOANS, INSURANCE, MORTGAGE COMPANIES, MORTGAGE BROKERS, REAL ESTATE AGENTS, INSURANCE AGENTS, MONEY LENDERS AND INSURANCE COMPANIES VIA AN INTERNET WEBSITE; PLACEMENT OF MORTGAGE LOANS BETWEEN MORTGAGE BROKERS AND MORTGAGE LENDERS, NAMELY, MORTGAGE PROCUREMENT FOR OTHERS; CONSUMER LOANS BETWEEN CONSUMERS AND LENDERS, NAMELY, LOAN FINANCING (U.S. CLS. 100, 101 AND 102).

FIRST USE 9-7-2006; IN COMMERCE 9-7-2006.

CLASS 36—(Continued).

3,178,752. ALPINE MORTGAGE CORPORATION, WARREN, MI. SN 78-691,250. FILED P.R. 8-12-2005; AM. S.R. 10-3-2006.

RENT 2 OWN LOAN

THE MARK CONSISTS OF STANDARD CHARACTERS WITHOUT CLAIM TO ANY PARTICULAR FONT, STYLE, SIZE, OR COLOR.

NO CLAIM IS MADE TO THE EXCLUSIVE RIGHT TO USE LOAN, APART FROM THE MARK AS SHOWN.

FOR FINANCIAL SERVICES, NAMELY, MORTGAGE BROKERAGE AND MORTGAGE CONSULTING SERVICES (U.S. CLS. 100, 101 AND 102).

FIRST USE 6-30-2004; IN COMMERCE 6-30-2004.

3,178,764. LEVIN CAPITAL STRATEGIES, LP, NEW YORK, NY. SN 78-705,851. FILED P.R. 9-2-2005; AM. S.R. 9-15-2006.

LEVIN CAPITAL STRATEGIES, LP

THE MARK CONSISTS OF STANDARD CHARACTERS WITHOUT CLAIM TO ANY PARTICULAR FONT, STYLE, SIZE, OR COLOR.

NO CLAIM IS MADE TO THE EXCLUSIVE RIGHT TO USE "CAPITAL STRATEGIES, LP", APART FROM THE MARK AS SHOWN.

FOR FINANCIAL SERVICES, NAMELY, INVESTMENT ADVISORY SERVICES, INVESTMENT MANAGEMENT SERVICES, AND ASSET MANAGEMENT SERVICES (U.S. CLS. 100, 101 AND 102).

FIRST USE 9-0-2005; IN COMMERCE 9-0-2005.

3,178,772. FINANCE MARYLAND, LLC, BALTIMORE, MD. SN 78-716,699. FILED P.R. 9-20-2005; AM. S.R. 10-6-2006.

FINANCE MARYLAND

THE MARK CONSISTS OF STANDARD CHARACTERS WITHOUT CLAIM TO ANY PARTICULAR FONT, STYLE, SIZE, OR COLOR.

FOR FINANCIAL SERVICES, NAMELY PERSONAL LOANS AND FINANCING SERVICES FOR MERCHANTS, INCLUDING FINANCING OF PURCHASES (U.S. CLS. 100, 101 AND 102).

FIRST USE 4-3-2002; IN COMMERCE 4-3-2002.

CLASS 36—(Continued).

3,178,820. RIMES TECHNOLOGIES CORPORATION, NEW YORK, NY. SN 78-872,140. FILED P.R. 4-28-2006; AM. S.R. 10-2-2006.

SMART FILES

THE MARK CONSISTS OF STANDARD CHARACTERS WITHOUT CLAIM TO ANY PARTICULAR FONT, STYLE, SIZE, OR COLOR.

NO CLAIM IS MADE TO THE EXCLUSIVE RIGHT TO USE "FILES", APART FROM THE MARK AS SHOWN.

FOR PROVIDING ONLINE DATABASES IN THE FIELD OF FINANCIAL INFORMATION FOR CLIENT TRACKING OF THE SET-UP, PRODUCTION AND DELIVERY OF FINANCIAL DATA FILES FROM MULTIPLE SERVICES (U.S. CLS. 100, 101 AND 102).

FIRST USE 11-1-2005; IN COMMERCE 11-1-2005.

3,178,823. SNYDER, STEVEN, GREENWOOD VILLAGE, CO. SN 78-876,016. FILED P.R. 5-3-2006; AM. S.R. 10-5-2006.

AMERICA'S BEST HOME BUYER

THE MARK CONSISTS OF STANDARD CHARACTERS WITHOUT CLAIM TO ANY PARTICULAR FONT, STYLE, SIZE, OR COLOR.

FOR REAL ESTATE INVESTMENT (U.S. CLS. 100, 101 AND 102).

FIRST USE 4-18-2006; IN COMMERCE 4-18-2006.

3,178,827. SALLIE MAE, INC., RESTON, VA. SN 78-911,427. FILED 6-19-2006.

**Global Health Education
Loan Program**

THE MARK CONSISTS OF STANDARD CHARACTERS WITHOUT CLAIM TO ANY PARTICULAR FONT, STYLE, SIZE, OR COLOR.

NO CLAIM IS MADE TO THE EXCLUSIVE RIGHT TO USE "HEALTH EDUCATION LOAN", APART FROM THE MARK AS SHOWN.

FOR FINANCIAL SERVICES, NAMELY, STUDENT LOANS (U.S. CLS. 100, 101 AND 102).

FIRST USE 2-1-2006; IN COMMERCE 4-1-2006.

CLASS 37—CONSTRUCTION AND REPAIR

CLASS 37—(Continued).

3,178,761. H.D. FRANCHISING SYSTEMS, LLC, MILFORD, OH. SN 78-704,880. FILED P.R. 8-31-2005; AM. S.R. 9-21-2006.

**REMODEL, IMPROVE, REPAIR
WITH THE PROFESSIONALS**

THE MARK CONSISTS OF STANDARD CHARACTERS WITHOUT CLAIM TO ANY PARTICULAR FONT, STYLE, SIZE, OR COLOR.

FOR HOUSE MAINTENANCE; REMODELING AND REPAIR, NAMELY, CARPENTRY, DRYWALL INSTALLATION AND REPAIR; ELECTRICAL CONTRACTING SERVICES; MASONRY; PAINTING; PLUMBING; ROOFING; AND WALL COVERING INSTALLATION (U.S. CLS. 100, 103 AND 106).

FIRST USE 11-15-2003; IN COMMERCE 11-15-2003.

CLASS 38—COMMUNICATION

3,178,769. ITC DELTACOM, INC., HUNTSVILLE, AL. SN 78-714,105. FILED 9-15-2005.

TELECOM SIMPLIFIED

THE MARK CONSISTS OF STANDARD CHARACTERS WITHOUT CLAIM TO ANY PARTICULAR FONT, STYLE, SIZE, OR COLOR.

NO CLAIM IS MADE TO THE EXCLUSIVE RIGHT TO USE "TELECOM", APART FROM THE MARK AS SHOWN.

FOR TELECOMMUNICATION SERVICES, NAMELY PROVIDING FRAME RELAY CONNECTIVITY SERVICES FOR DATA TRANSFER; LOCAL, LONG DISTANCE AND INTERNATIONAL TELEPHONE COMMUNICATIONS SERVICES; ISDN SERVICES; DSL SERVICES; PROVIDING ACCESS TO A GLOBAL COMPUTER NETWORK; AND CONSULTING SERVICES IN THE FIELD OF TELECOMMUNICATIONS (U.S. CLS. 100, 101 AND 104).

FIRST USE 8-30-2005; IN COMMERCE 8-30-2005.

3,178,779. CLOCK TOWER VENTURES LLC, OLD WESTBURY, NY. SN 78-725,833. FILED P.R. 10-4-2005; AM. S.R. 9-8-2006.

MOTHERS OF FRESHMEN

THE MARK CONSISTS OF STANDARD CHARACTERS WITHOUT CLAIM TO ANY PARTICULAR FONT, STYLE, SIZE, OR COLOR.

FOR PROVIDING ON-LINE CHAT ROOMS FOR TRANSMISSION OF MESSAGES AMONG COMPUTER USERS CONCERNING THEIR COLLEGE AGED CHILDREN (U.S. CLS. 100, 101 AND 104).

FIRST USE 3-20-2006; IN COMMERCE 3-20-2006.

CLASS 38—(Continued).

3,178,790. CLARITY COMMUNICATION ADVISORS, INC., SOUTHFIELD, MI. SN 78-734,874. FILED P.R. 10-17-2005; AM. S.R. 10-11-2006.

**BROADBAND VOICE FOR
BUSINESS**

THE MARK CONSISTS OF STANDARD CHARACTERS WITHOUT CLAIM TO ANY PARTICULAR FONT, STYLE, SIZE, OR COLOR.

FOR VOICE OVER INTERNET PROTOCOL (VOIP) SERVICES (U.S. CLS. 100, 101 AND 104).

FIRST USE 8-1-2005; IN COMMERCE 8-1-2005.

CLASS 39—TRANSPORTATION AND STORAGE

3,178,724. UNIWORLD RIVER CRUISES, INC., ENCINO, CA. SN 78-566,577. FILED P.R. 2-14-2005; AM. S.R. 9-28-2006.

**Grand River
Cruises**

THE MARK CONSISTS OF STANDARD CHARACTERS WITHOUT CLAIM TO ANY PARTICULAR FONT, STYLE, SIZE, OR COLOR.

NO CLAIM IS MADE TO THE EXCLUSIVE RIGHT TO USE "RIVER CRUISES", APART FROM THE MARK AS SHOWN.

FOR TRAVEL AGENCY SERVICES, MAKING RESERVATIONS AND BOOKINGS FOR TRANSPORTATION, INCLUDING RIVER CRUISES AND RELATED TRAVEL (U.S. CLS. 100 AND 105).

FIRST USE 1-1-2005; IN COMMERCE 1-1-2005.

CLASS 39—(Continued).

3,178,734. CAPITOL CORRIDOR JOINT POWERS AUTHORITY, OAKLAND, CA. SN 78-637,971. FILED P.R. 5-26-2005; AM. S.R. 9-12-2006.

CLASS 41—(Continued).

3,178,699. NATIONAL DANCE COUNCIL OF AMERICA, INC., PORT ST. LUCIE, FL. SN 78-407,727. FILED P.R. 4-26-2004; AM. S.R. 8-11-2006.

TRAIN TREKS

THE MARK CONSISTS OF STANDARD CHARACTERS WITHOUT CLAIM TO ANY PARTICULAR FONT, STYLE, SIZE, OR COLOR.

FOR CO-ORDINATING TRAVEL ARRANGEMENTS FOR GROUPS (U.S. CLS. 100 AND 105).

FIRST USE 2-1-2002; IN COMMERCE 2-1-2002.

World American- Style Championships

CLASS 41—EDUCATION AND ENTERTAINMENT

3,178,685. AMERICAN HIGH SCHOOL INTERNET MATHEMATICS COMPETITION, NASHVILLE, TN. SN 76-627,956. FILED P.R. 1-13-2005; AM. S.R. 9-27-2006.

THE MARK CONSISTS OF STANDARD CHARACTERS WITHOUT CLAIM TO ANY PARTICULAR FONT, STYLE, SIZE, OR COLOR.

NO CLAIM IS MADE TO THE EXCLUSIVE RIGHT TO USE AMERICAN-STYLE CHAMPIONSHIPS, APART FROM THE MARK AS SHOWN.

FOR ENTERTAINMENT IN THE NATURE OF COMPETITIONS IN THE FIELD OF DANCE (U.S. CLS. 100, 101 AND 107).

FIRST USE 9-3-2005; IN COMMERCE 9-3-2005.

ITEST

THE MARK CONSISTS OF STANDARD CHARACTERS WITHOUT CLAIM TO ANY PARTICULAR FONT, STYLE, SIZE, OR COLOR.

FOR EDUCATIONAL SERVICES, NAMELY, ORGANIZING AND CONDUCTING ANNUAL MATHEMATICS COMPETITIONS FOR STUDENTS AND TEAMS OF STUDENTS TO PROMOTE INCREASED INTEREST AND ACHIEVEMENT IN THE FIELD OF MATHEMATICS, CONDUCTED BY MEANS OF THE INTERNET (U.S. CLS. 100, 101 AND 107).

FIRST USE 3-21-2005; IN COMMERCE 3-21-2005.

3,178,717. WORK WITH KIDS, INC., SAINT PETERSBURG, FL. SN 78-558,967. FILED P.R. 2-2-2005; AM. S.R. 8-8-2006.

WORK WITH KIDS

3,178,693. RECORDING INDUSTRY ASSOCIATION OF AMERICA, INC., WASHINGTON, DC. SN 78-165,637. FILED P.R. 9-19-2002; AM. S.R. 9-15-2006.

M.U.S.I.C.

FOR EDUCATIONAL SERVICES, NAMELY, CONDUCTING PROGRAMS TO EDUCATE THE PUBLIC ABOUT THE IMPORTANCE OF PRESERVING COPYRIGHT IN THE DIGITAL AGE AND ENVIRONMENT OF DIGITAL ELECTRONIC COMMUNICATIONS (U.S. CLS. 100, 101 AND 107).

FIRST USE 4-12-2005; IN COMMERCE 4-12-2005.

THE MARK CONSISTS OF STANDARD CHARACTERS WITHOUT CLAIM TO ANY PARTICULAR FONT, STYLE, SIZE, OR COLOR.

FOR PROVIDING EDUCATIONAL AND PROFESSIONAL DEVELOPMENT INFORMATION THROUGH SEMINARS, CONFERENCES, EXHIBITIONS, WORKSHOPS, FORUMS AND SESSIONS IN THE FIELD OF PROFESSIONAL CAREER DEVELOPMENT; PROVIDING NEWSLETTERS IN THE FIELD OF PROFESSIONAL CAREER DEVELOPMENT VIA E-MAIL (U.S. CLS. 100, 101 AND 107).

FIRST USE 2-2-2005; IN COMMERCE 2-2-2005.

CLASS 41—(Continued).

3,178,741. INTERNATIONAL WOMEN'S FORUM, WASHINGTON, DC. SN 78-663,766. FILED P.R. 7-5-2005; AM. S.R. 10-16-2006.

Executive Development Roundtable

THE MARK CONSISTS OF STANDARD CHARACTERS WITHOUT CLAIM TO ANY PARTICULAR FONT, STYLE, SIZE, OR COLOR.

FOR TRAINING SERVICES IN THE FIELD OF EXECUTIVE MANAGEMENT (U.S. CLS. 100, 101 AND 107).
FIRST USE 9-30-2004; IN COMMERCE 9-30-2004.

3,178,791. JACOB ORTIZ, HUNTINGTON BEACH, CA. SN 78-735,714. FILED P.R. 10-18-2005; AM. S.R. 9-15-2006.

Ultimate Training Center

THE MARK CONSISTS OF STANDARD CHARACTERS WITHOUT CLAIM TO ANY PARTICULAR FONT, STYLE, SIZE, OR COLOR.

NO CLAIM IS MADE TO THE EXCLUSIVE RIGHT TO USE "TRAINING CENTER", APART FROM THE MARK AS SHOWN.

FOR PROVIDING FITNESS AND EXERCISE FACILITIES (U.S. CLS. 100, 101 AND 107).
FIRST USE 1-1-1999; IN COMMERCE 1-1-1999.

3,178,798. PRIME SITES, INC., LOS ANGELES, CA. SN 78-783,344. FILED P.R. 12-30-2005; AM. S.R. 7-31-2006.

AUDITIONS

THE MARK CONSISTS OF STANDARD CHARACTERS WITHOUT CLAIM TO ANY PARTICULAR FONT, STYLE, SIZE, OR COLOR.

FOR ONLINE DATABASE TALENT AGENCIES WHERE TALENT PROFILES GET MATCHED AND SUBMITTED TO CURRENT CASTINGS AND AUDITIONS (U.S. CLS. 100, 101 AND 107).
FIRST USE 4-30-1996; IN COMMERCE 4-30-1996.

CLASS 41—(Continued).

3,178,805. WAGREICH, JERRY, OSSINING, NY. SN 78-831,407. FILED P.R. 3-7-2006; AM. S.R. 9-6-2006.

~~Prestigious Entertainment~~

THE COLOR(S) BLUE, LIGHT PURPLE, AND GREY IS/ARE CLAIMED AS A FEATURE OF THE MARK.

THE MARK CONSISTS OF STYLIZED LETTERS IN BLUE WITH AN UNDERNEATH SHADOW OF THE LETTERS IN GREY AND A SOLID LINE RUNNING BEHIND THE LETTERS IN LIGHT PURPLE.

FOR ARRANGING FOR TICKET RESERVATIONS FOR SHOWS AND OTHER ENTERTAINMENT EVENTS; BOOKING OF ENTERTAINMENT HALLS; ENTERTAINMENT IN THE NATURE OF DANCE PERFORMANCES; ENTERTAINMENT IN THE NATURE OF LIVE PERFORMANCES BY MUSICIANS, DANCERS, DJ'S, ACTORS, COMEDIANS; ENTERTAINMENT IN THE NATURE OF VISUAL AND AUDIO PERFORMANCES, NAMELY, MUSICAL BAND, ROCK GROUP, GYMNAS-TIC, DANCE, AND BALLET PERFORMANCES; ENTERTAINMENT IN THE NATURE OF LIVE MUSIC GROUPS, RAPPERS, COMEDIANS, ACTORS, DANCERS; ENTERTAINMENT NAMELY, LIVE PERFORMANCES BY A MUSICAL BAND; ENTERTAINMENT SERVICES, NAMELY, PERSONAL APPEARANCES BY A MUSIC ARTIST, ACTOR, COMEDIAN; ENTERTAINMENT, NAMELY LIVE MUSIC CONCERTS (U.S. CLS. 100, 101 AND 107).

FIRST USE 11-22-2002; IN COMMERCE 3-1-2003.

3,178,808. DOME'S DAY PRODUCTIONS, LLC, BROOKLYN, NY. SN 78-835,525. FILED P.R. 3-13-2006; AM. S.R. 10-4-2006.

Domer

THE MARK CONSISTS OF STANDARD CHARACTERS WITHOUT CLAIM TO ANY PARTICULAR FONT, STYLE, SIZE, OR COLOR.

FOR ENTERTAINMENT, NAMELY LIVE PERFORMANCES BY MUSICAL BANDS (U.S. CLS. 100, 101 AND 107).

FIRST USE 12-1-2003; IN COMMERCE 12-1-2003.

CLASS 41—(Continued).

3,178,811. MARKET TRADERS INSTITUTE, INC., WINTER PARK, FL. SN 78-843,642. FILED P.R. 3-22-2006; AM. S.R. 10-3-2006.

THE ULTIMATE FOREX TRADERS
PACKAGE

THE MARK CONSISTS OF STANDARD CHARACTERS WITHOUT CLAIM TO ANY PARTICULAR FONT, STYLE, SIZE, OR COLOR.

FOR EDUCATIONAL PROGRAM, NAMELY A COMBINED HOME STUDY, ON-LINE TRAINING AND CLASSROOM TRAINING PROGRAM FOR TEACHING USE OF THE FOREIGN CURRENCY EXCHANGE FOR INVESTMENT PURPOSES (U.S. CLS. 100, 101 AND 107).
FIRST USE 8-14-2005; IN COMMERCE 8-14-2005.

3,178,818. DEVOY, JOSEPH P., LONG BEACH, CA. SN 78-868,694. FILED P.R. 4-25-2006; AM. S.R. 10-12-2006.

KNOWLEDGEMANAGER

THE MARK CONSISTS OF STANDARD CHARACTERS WITHOUT CLAIM TO ANY PARTICULAR FONT, STYLE, SIZE, OR COLOR.

FOR PROVIDING EDUCATIONAL SERVICES, NAMELY, CONDUCTING CLASSES, TRAINING AND COACHING SERVICES VIA GLOBAL COMPUTER COMMUNICATION NETWORKS IN THE FIELDS OF BUSINESS DEVELOPMENT AND IMPLEMENTATION, BUSINESS, BUSINESS OPERATIONS AND BUSINESS PROJECTS (U.S. CLS. 100, 101 AND 107).
FIRST USE 9-1-2005; IN COMMERCE 9-1-2005.

3,178,821. MCLAUGHLIN, ROBERT H., PHILADELPHIA, PA. SN 78-874,447. FILED 5-2-2006.

TURIYA MEDITATION

THE MARK CONSISTS OF STANDARD CHARACTERS WITHOUT CLAIM TO ANY PARTICULAR FONT, STYLE, SIZE, OR COLOR.

NO CLAIM IS MADE TO THE EXCLUSIVE RIGHT TO USE "MEDITATION", APART FROM THE MARK AS SHOWN.

FOR EDUCATIONAL SERVICES, NAMELY, CONDUCTING LECTURES ON MEDITATION TRAINING AND STRESS REDUCTION (U.S. CLS. 100, 101 AND 107).
FIRST USE 9-1-2005; IN COMMERCE 9-1-2005.

CLASS 41—(Continued).

3,178,825. GHANI MOGHADAM, SAEED, THORNHILL, CANADA. SN 78-876,480. FILED P.R. 5-4-2006; AM. S.R. 10-5-2006.

Persian Awards

THE MARK CONSISTS OF STANDARD CHARACTERS WITHOUT CLAIM TO ANY PARTICULAR FONT, STYLE, SIZE, OR COLOR.

FOR PROVIDING RECOGNITION AND INCENTIVES BY THE WAY OF AWARDS TO DEMONSTRATE EXCELLENCE IN THE FIELD OF ARTS AND SCIENCES (U.S. CLS. 100, 101 AND 107).
FIRST USE 11-1-2003; IN COMMERCE 11-1-2003.

CLASS 42—SCIENTIFIC, COMPUTER AND LEGAL SERVICES

3,178,680. ARBELLA MUTUAL INSURANCE COMPANY, DBA/ARBELLA INSURANCE GROUP, QUINCY, MA. SN 76-609,944. FILED P.R. 9-2-2004; AM. S.R. 3-9-2006.



FOR NON-DOWNLOADABLE SOFTWARE PROGRAM AVAILABLE ONLINE FOR USE BY INSURANCE AGENTS IN PROCESSING PROPERTY AND CASUALTY INSURANCE TRANSACTIONS (U.S. CLS. 100 AND 101).
FIRST USE 1-25-2006; IN COMMERCE 1-25-2006.

CLASS 42—(Continued).

3,178,727. COLLECTORS UNIVERSE, INC., NEWPORT BEACH, CA. SN 78-579,862. FILED P.R. 3-3-2005; AM. S.R. 10-9-2006.

RookieBall

THE MARK CONSISTS OF STANDARD CHARACTERS WITHOUT CLAIM TO ANY PARTICULAR FONT, STYLE, SIZE, OR COLOR.

FOR AUTHENTICATION AND GRADING SERVICES IN THE FIELD OF AUTOGRAPHED SPORTS MEMORABILIA, NAMELY AUTHENTICATION AND GRADING OF AUTOGRAPHED SPORTS BALLS (U.S. CLS. 100 AND 101).

FIRST USE 8-0-2005; IN COMMERCE 8-0-2005.

3,178,737. INGRESSOFT, LLC, ALISO VIEJO, CA. SN 78-650,922. FILED P.R. 6-15-2005; AM. S.R. 9-29-2006.

INGRESS MANAGER

THE MARK CONSISTS OF STANDARD CHARACTERS WITHOUT CLAIM TO ANY PARTICULAR FONT, STYLE, SIZE, OR COLOR.

FOR INTERNET SERVICE, NAMELY PROVIDING ONLINE NON-DOWNLOADABLE SOFTWARE FOR E-MAIL MANAGEMENT FEATURING BLOCKING JUNK E-MAIL, VIRUSES, SPYWARE AND TROJANS, AND FOR PROVIDING ARCHIVE, STORAGE, BACKUP AND RECOVERY OF E-MAIL MESSAGES (U.S. CLS. 100 AND 101).

FIRST USE 2-16-2006; IN COMMERCE 9-15-2006.

CLASS 42—(Continued).

3,178,742. TEXTILE/CLOTHING TECHNOLOGY CORPORATION, CARY, NC. SN 78-663,790. FILED P.R. 7-5-2005; AM. S.R. 3-21-2006.

SizeUSA

THE MARK CONSISTS OF STANDARD CHARACTERS WITHOUT CLAIM TO ANY PARTICULAR FONT, STYLE, SIZE, OR COLOR.

FOR MEDICAL RESEARCH PURPOSES, NAMELY NATIONAL SIZING SURVEY OF THE US POPULATION USING 3D BODY SCANNING TECHNOLOGY TO CORRELATE BODY MEASUREMENTS AND SHAPES TO HEALTH CONDITIONS (U.S. CLS. 100 AND 101).

FIRST USE 4-1-2002; IN COMMERCE 6-1-2002.

3,178,771. SERENA SOFTWARE, INC., SAN MATEO, CA. SN 78-714,194. FILED P.R. 9-15-2005; AM. S.R. 10-2-2006.

CHANGE GOVERNANCE

THE MARK CONSISTS OF STANDARD CHARACTERS WITHOUT CLAIM TO ANY PARTICULAR FONT, STYLE, SIZE, OR COLOR.

FOR COMPUTER SOFTWARE DESIGN FOR OTHERS; COMPUTER SOFTWARE CONSULTING SERVICES IN THE FIELD OF IMPLEMENTING AND MANAGING CHANGES THROUGHOUT AN ENTERPRISE, COMPANY, OR ORGANIZATION (U.S. CLS. 100 AND 101).

FIRST USE 9-15-2006; IN COMMERCE 9-15-2006.

3,178,781. DXCG, INC., BOSTON, MA. SN 78-728,367. FILED P.R. 10-6-2005; AM. S.R. 9-30-2006.

DM E\$TIMATOR

THE MARK CONSISTS OF STANDARD CHARACTERS WITHOUT CLAIM TO ANY PARTICULAR FONT, STYLE, SIZE, OR COLOR.

FOR PROVIDING TEMPORARY USE OF ONLINE, NON-DOWNLOADABLE SOFTWARE IN THE NATURE OF A DISEASE MANAGEMENT CALCULATOR THAT HELPS CLIENTS UNDERSTAND THEIR POPULATION'S HEALTH CARE NEEDS (U.S. CLS. 100 AND 101).

FIRST USE 10-31-2005; IN COMMERCE 10-31-2005.

CLASS 42—(Continued).

3,178,787. ADVANCED EDUCATION SYSTEMS, LLC, TIMONIUM, MD. SN 78-732,074. FILED P.R. 10-12-2005; AM. S.R. 9-8-2006.

CLASS 44—MEDICAL, BEAUTY AND AGRICULTURAL SERVICES

3,178,710. GOSHEN HEALTH SYSTEM, GOSHEN, IN. SN 78-524,584. FILED P.R. 11-30-2004; AM. S.R. 9-28-2006.

GOV REGISTRY

THE MARK CONSISTS OF STANDARD CHARACTERS WITHOUT CLAIM TO ANY PARTICULAR FONT, STYLE, SIZE, OR COLOR.

NO CLAIM IS MADE TO THE EXCLUSIVE RIGHT TO USE "REGISTRY", APART FROM THE MARK AS SHOWN, FOR PROVIDING ONLINE NON-DOWNLOADABLE SOFTWARE FOR ACCESSING, ORGANIZING, STORING AND MANAGING REGULATORY AND EDUCATIONAL REQUIREMENTS IN THE FIELD OF MORTGAGES, LOAN OFFICERS, INSURANCE AND REAL ESTATE (U.S. CLS. 100 AND 101).

FIRST USE 9-0-2005; IN COMMERCE 9-0-2005.

TEAM: BARIATRICS

THE MARK CONSISTS OF STANDARD CHARACTERS WITHOUT CLAIM TO ANY PARTICULAR FONT, STYLE, SIZE, OR COLOR.

FOR MEDICAL SERVICES AND COUNSELING, NAMELY COMPREHENSIVE MEDICAL MANAGEMENT SERVICES TO ASSIST PATIENTS WITH OBESITY ISSUES (U.S. CLS. 100 AND 101).

FIRST USE 2-4-2004; IN COMMERCE 2-4-2004.

3,178,801. AMERICAN COLLEGE OF EMERGENCY PHYSICIANS, IRVING, TX. SN 78-797,777. FILED P.R. 1-24-2006; AM. S.R. 9-27-2006.

ADVANCING EMERGENCY CARE

THE MARK CONSISTS OF STANDARD CHARACTERS WITHOUT CLAIM TO ANY PARTICULAR FONT, STYLE, SIZE, OR COLOR.

FOR ASSOCIATION SERVICES, NAMELY, PROMOTING THE INTERESTS OF PRACTITIONERS OF EMERGENCY MEDICINE (U.S. CLS. 100 AND 101).

FIRST USE 1-0-2006; IN COMMERCE 1-0-2006.

3,178,773. RESOLUTION HEALTH, INC., SAN JOSE, CA. SN 78-718,133. FILED P.R. 9-22-2005; AM. S.R. 10-2-2006.

CLASS 43—HOTEL AND RESTAURANT SERVICES

3,178,788. PIZZERIA UNO CORPORATION, WILMINGTON, DE. SN 78-732,592. FILED P.R. 10-13-2005; AM. S.R. 8-22-2006.

Direct-to-Provider**SNACK HOURS**

THE MARK CONSISTS OF STANDARD CHARACTERS WITHOUT CLAIM TO ANY PARTICULAR FONT, STYLE, SIZE, OR COLOR.

FOR CARRY-OUT RESTAURANTS; RESTAURANT SERVICES (U.S. CLS. 100 AND 101).

FIRST USE 9-30-2005; IN COMMERCE 9-30-2005.

THE MARK CONSISTS OF STANDARD CHARACTERS WITHOUT CLAIM TO ANY PARTICULAR FONT, STYLE, SIZE, OR COLOR.

FOR PROVIDING HEALTH INFORMATION, NAMELY, PROVIDING TO HEALTH CARE PROVIDER ORGANIZATIONS REPORTS FEATURING RESULTS OF AN ANALYSIS OF MEDICAL DATA, NAMELY, CLAIM DATA AND CONTAINING INFORMATION ABOUT THE MEDICAL CONDITION AND TREATMENT HISTORY OF INDIVIDUALS AND OPPORTUNITIES TO IMPROVE THE PATIENT'S HEALTH AND HEALTH CARE (U.S. CLS. 100 AND 101).

FIRST USE 9-0-2005; IN COMMERCE 1-0-2006.

CLASS 44—(Continued).

3,178,806. SERALY, MARK P., MCMURRAY, PA. SN 78-832,197. FILED P.R. 3-8-2006; AM. S.R. 10-9-2006.

SKIN ADVICE CENTER

THE MARK CONSISTS OF STANDARD CHARACTERS WITHOUT CLAIM TO ANY PARTICULAR FONT, STYLE, SIZE, OR COLOR.

NO CLAIM IS MADE TO THE EXCLUSIVE RIGHT TO USE "SKIN ADVICE", APART FROM THE MARK AS SHOWN.

FOR MEDICAL SERVICES RENDERED ON THE WORLD WIDE WEB PERMITTING INTERACTION BETWEEN PROSPECTIVE PATIENTS AND A DERMATOLOGIST PROVIDING INFORMATION ON DERMATOLOGICAL ISSUES, TREATMENT ALTERNATIVES, NEW MEDICINES AND THE LIKE (U.S. CLS. 100 AND 101).

FIRST USE 2-0-2006; IN COMMERCE 2-0-2006.

3,178,807. SERALY, MARK P., MCMURRAY, PA. SN 78-832,225. FILED P.R. 3-8-2006; AM. S.R. 10-9-2006.

DERMATOLOGY E-CONSULTATION

CLASS 44—(Continued).

THE MARK CONSISTS OF STANDARD CHARACTERS WITHOUT CLAIM TO ANY PARTICULAR FONT, STYLE, SIZE, OR COLOR.

NO CLAIM IS MADE TO THE EXCLUSIVE RIGHT TO USE "DERMATOLOGY", APART FROM THE MARK AS SHOWN.

FOR MEDICAL SERVICES RENDERED ON THE WORLD WIDE WEB ALLOWING INTERACTION BETWEEN EXISTING PATIENTS AND THE PHYSICIAN OUTSIDE OF REGULAR OFFICE VISITS AND REGULAR OFFICE HOURS TO OBTAIN ADVICE ON A SKIN, HAIR OR NAIL RELATED DISORDER, INITIATE A TREATMENT PLAN OR RECOMMENDATION WHILE WAITING FOR A FOLLOW-UP OFFICE APPOINTMENT OR OBTAIN PRESCRIPTION REFILLS FOR A STABLE CONDITION (U.S. CLS. 100 AND 101).

FIRST USE 2-0-2006; IN COMMERCE 2-0-2006.

3,178,814. POPMED, INC., BEVERLY, MA. SN 78-850,755. FILED P.R. 3-31-2006; AM. S.R. 10-5-2006.

POPMED

THE MARK CONSISTS OF STANDARD CHARACTERS WITHOUT CLAIM TO ANY PARTICULAR FONT, STYLE, SIZE, OR COLOR.

FOR PROVIDING ONLINE INFORMATION IN THE FIELDS OF HEALTH, NUTRITION, FITNESS EVALUATION AND HEALTH RELATED MATTERS (U.S. CLS. 100 AND 101).

FIRST USE 8-1-2006; IN COMMERCE 8-1-2006.

* * * * *

TRADEMARK REGISTRATIONS RENEWED

The designation "U.S. Cl." appearing in this section refers to the U.S. class in effect prior to Sep. 1, 1973 rather than the international class which applies to applications filed on or after that date. For adoption of international classification see notice in the OFFICIAL GAZETTE of Jun. 26, 1973 (911 O.G. TM 210).

28,711.	EDME. U.S. CL. 18. (INT. CL. 5). REG. 8-4-1896.	810,106.	BARBIE. U.S. CL. 22. (INT. CL. 28). REG. 6-21-1966.
52,807.	MISCELLANEOUS DESIGN. U.S. CL. 37. (INT. CL. 16). REG. 5-15-1906.	811,277.	TK (STYLIZED). U.S. CLS. 19 AND 31. (INT. CLS. 11 AND 12). REG. 7-19-1966.
53,463.	D. & P. (STYLIZED). U.S. CL. 46. (INT. CL. 30). REG. 6-5-1906.	811,280.	QUIET QUALITY. U.S. CL. 21. (INT. CL. 9). REG. 7-19-1966.
55,158.	MARLIN (STYLIZED). U.S. CL. 9. (INT. CL. 13). REG. 8-7-1906.	811,481.	JEAN DESPREZ. U.S. CL. 51. (INT. CL. 3). REG. 7-19-1966.
56,567.	TANNATE (STYLIZED). U.S. CL. 35. (INT. CL. 18). REG. 10-9-1906.	812,961.	SCHMETZ. U.S. CL. 23. (INT. CL. 7). REG. 8-16-1966.
207,165.	BEST UNIVERSAL (STYLIZED). U.S. CL. 25. (INT. CL. 6). REG. 12-22-1925.	813,206.	TOTE-A-MEAL. U.S. CL. 2. (INT. CL. 21). REG. 8-16-1966.
216,307.	SELSI. U.S. CL. 26. (INT. CL. 9). REG. 8-10-1926.	813,392.	ALMO. U.S. CL. 23. (INT. CL. 7). REG. 8-23-1966.
221,908.	AGERITE (STYLIZED). U.S. CL. 6. (INT. CL. 1). REG. 12-14-1926.	813,451.	TURBO. U.S. CL. 34. (INT. CL. 11). REG. 8-23-1966.
223,660.	SANI-FLAT AND DESIGN. U.S. CL. 16. (INT. CL. 2). REG. 2-8-1927.	813,726.	AGWAY. INT. CL. 1. (U.S. CL. 1). REG. 8-30-1966.
227,647.	COLGATE. U.S. CL. 51. (INT. CL. 1). REG. 5-10-1927.	813,792.	RIVER CEMENT AND DESIGN. U.S. CL. 12. (INT. CL. 19). REG. 8-30-1966.
338,058.	ROCKLATH (STYLIZED). U.S. CL. 12. (INT. CL. 19). REG. 8-25-1936.	813,819.	FITZ-ALL (STYLIZED). U.S. CL. 13. (INT. CL. 6). REG. 8-30-1966.
343,168.	ENDURANCE. U.S. CL. 46. (INT. CL. 31). REG. 2-9-1937.	813,862.	UNICON. U.S. CL. 21. (INT. CL. 9). REG. 8-30-1966.
421,958.	KELCOLOID. U.S. CL. 46. (INT. CLS. 29 AND 30). REG. 6-25-1946.	814,187.	SERVICE MEASURED NOT BY GOLD BUT BY THE GOLDEN RULE AND DESIGN. U.S. CL. 101. (INT. CLS. 35, 36, 38, 41 AND 42). REG. 8-30-1966.
422,975.	MORSE'S (STYLIZED). U.S. CL. 1. (INT. CL. 31). REG. 8-20-1946.	814,984.	ACTION OFFICE. U.S. CL. 32. (INT. CL. 20). REG. 9-13-1966.
427,951.	SLINKY JAMES (STYLIZED). U.S. CL. 22. (INT. CL. 28). REG. 3-4-1947.	816,464.	LEEGEN. U.S. CL. 6. (INT. CL. 1). REG. 10-11-1966.
622,415.	CREAMTEX (STYLIZED). U.S. CL. 46. (INT. CL. 29). REG. 2-28-1956.	817,721.	GALLUS (STYLIZED). U.S. CL. 23. (INT. CL. 7). REG. 11-1-1966.
622,416.	MELVO (STYLIZED). U.S. CL. 46. (INT. CL. 29). REG. 2-28-1956.	818,025.	POWR BRACKET AND DESIGN. U.S. CL. 21. (INT. CL. 9). REG. 11-1-1966.
626,834.	APPLETON (STYLIZED). U.S. CL. 21. (INT. CLS. 9 AND 11). REG. 5-15-1956.	818,647.	CHERISHED. U.S. CL. 28. (INT. CL. 14). REG. 11-15-1966.
630,866.	AUTOPOWER. U.S. CL. 26. (INT. CL. 7). REG. 7-17-1956.	820,603.	LITH-EASE. U.S. CL. 15. (INT. CL. 4). REG. 12-20-1966.
631,340.	BEVNAP (STYLIZED). U.S. CL. 37. (INT. CL. 16). REG. 7-24-1956.	823,663.	DELACORTE PRESS. U.S. CL. 38. (INT. CL. 16). REG. 2-7-1967.
631,657.	PLAST-O-RUNNER. U.S. CL. 20. (INT. CL. 27). REG. 7-31-1956.	828,315.	ARROW. U.S. CL. 49. (INT. CL. 33). REG. 5-2-1967.
632,655.	JEKTOLE. U.S. CL. 23. (INT. CLS. 7 AND 8). REG. 8-14-1956.	829,219.	YAGO. U.S. CL. 47. (INT. CL. 33). REG. 5-23-1967.
633,394.	TUPPERWARE (STYLIZED). U.S. CL. 2. (INT. CL. 21). REG. 8-28-1956.	830,686.	SIDRA ESCANCIADOR AND DESIGN. U.S. CL. 46. (INT. CL. 33). REG. 6-20-1967.
633,668.	THE AMERICAN ACADEMY OF PEDIATRICS AND DESIGN. U.S. CL. 38. (INT. CL. 16). REG. 8-28-1956.	832,393.	HESS. U.S. CL. 15. (INT. CL. 4). REG. 7-25-1967.
635,824.	LICON. U.S. CL. 21. (INT. CL. 9). REG. 10-16-1956.	1,010,106.	CRAGAR SS AND DESIGN. U.S. CL. 19. (INT. CL. 12). REG. 5-6-1975.
637,082.	FLEXA-GEAR. U.S. CL. 21. (INT. CL. 9). REG. 11-13-1956.	1,031,202.	REGO AND DESIGN. INT. CL. 6. (U.S. CL. 13). REG. 1-27-1976.
639,636.	PRECISOR. U.S. CL. 26. (INT. CL. 9). REG. 1-8-1957.	1,033,463.	SURCOL. INT. CL. 1. (U.S. CL. 1). REG. 2-17-1976.
641,461.	DURUG. U.S. CL. 42. (INT. CL. 27). REG. 2-12-1957.	1,034,100.	FURUSATO AND DESIGN. INT. CL. 42. (U.S. CL. 100). REG. 2-17-1976.
643,871.	MAXARET (STYLIZED). U.S. CL. 19. (INT. CL. 12). REG. 4-9-1957.	1,037,167.	ANDREA PFISTER (STYLIZED). INT. CLS. 3, 14, 18 AND 25. (U.S. CLS. 1, 2, 3, 4, 6, 22, 27, 28, 39, 41, 50, 51 AND 52). REG. 4-6-1976.
801,968.	SARATOGA. U.S. CL. 44. (INT. CL. 10). REG. 1-11-1966.	1,038,108.	RESTORIL. INT. CL. 5. (U.S. CL. 18). REG. 4-20-1976.
803,403.	ISOFORM. U.S. CL. 23. (INT. CL. 7). REG. 2-8-1966.	1,042,150.	N-R-G-FLOR. INT. CL. 9. (U.S. CL. 21). REG. 6-29-1976.
804,025.	MR. CHRISTMAS. U.S. CL. 50. (INT. CL. 28). REG. 2-15-1966.	1,044,430.	COLOR TILE. INT. CLS. 37 AND 42. (U.S. CLS. 101 AND 103). REG. 7-20-1976.
805,161.	ACCURIST. U.S. CL. 27. (INT. CL. 14). REG. 3-8-1966.	1,045,185.	SOLUSORB. INT. CL. 1. (U.S. CL. 6). REG. 8-3-1976.
807,470.	CETACORT (STYLIZED). U.S. CL. 18. (INT. CL. 5). REG. 4-26-1966.	1,045,284.	SAMM. INT. CL. 7. (U.S. CL. 23). REG. 8-3-1976.
807,592.	GOLD PREMIUM. U.S. CL. 46. (INT. CL. 29). REG. 4-26-1966.	1,045,329.	ROSCOE. INT. CL. 9. (U.S. CL. 26). REG. 8-3-1976.
		1,045,353.	CHICAGO AND DESIGN. INT. CL. 11. (U.S. CL. 34). REG. 8-3-1976.
		1,045,568.	FISH EXPO. INT. CL. 35. (U.S. CL. 101). REG. 8-3-1976.
		1,045,574.	EQUIFAX. INT. CL. 35. (U.S. CL. 101). REG. 8-3-1976.
		1,045,704.	NOVUS. INT. CL. 3. (U.S. CL. 4). REG. 8-10-1976.

- 1,045,955. VIVA. INT. CLS. 22 AND 26. (U.S. CLS. 1 AND 40). REG. 8-10-1976.
- 1,046,135. WALK THRU THE BIBLE. INT. CL. 41. (U.S. CL. 107). REG. 8-10-1976.
- 1,046,200. CHEMDI. INT. CL. 1. (U.S. CL. 6). REG. 8-17-1976.
- 1,046,237. AQUALITE. INT. CL. 5. (U.S. CL. 18). REG. 8-17-1976.
- 1,046,283. TRION. INT. CL. 9. (U.S. CL. 21). REG. 8-17-1976.
- 1,046,392. POSTURE III. INT. CL. 20. (U.S. CL. 32). REG. 8-17-1976.
- 1,046,402. TIARA AND DESIGN. INT. CL. 22. (U.S. CL. 1). REG. 8-17-1976.
- 1,046,406. MACK AND DESIGN. INT. CLS. 24 AND 25. (U.S. CLS. 39 AND 42). REG. 8-17-1976.
- 1,046,409. BED-SACK. INT. CL. 24. (U.S. CL. 42). REG. 8-17-1976.
- 1,046,416. MATTRESS SACK. INT. CL. 24. (U.S. CL. 42). REG. 8-17-1976.
- 1,046,622. PRIMO. INT. CL. 3. (U.S. CL. 6). REG. 8-24-1976.
- 1,046,998. AARP. INT. CLS. 36 AND 42. (U.S. CLS. 101 AND 102). REG. 8-24-1976.
- 1,047,005. AARP. INT. CLS. 39 AND 41. (U.S. CLS. 105 AND 107). REG. 8-24-1976.
- 1,047,351. VENETIAN. INT. CL. 34. (U.S. CL. 8). REG. 8-31-1976.
- 1,047,428. VISOLITE. INT. CL. 1. (U.S. CL. 6). REG. 9-7-1976.
- 1,047,685. LUCITE. INT. CL. 17. (U.S. CL. 1). REG. 9-7-1976.
- 1,047,788. QUENCH. INT. CL. 30. (U.S. CL. 46). REG. 9-7-1976.
- 1,048,286. MOBIL. INT. CL. 36. (U.S. CL. 102). REG. 9-14-1976.
- 1,048,417. JACLO. INT. CL. 6. (U.S. CL. 13). REG. 9-21-1976.
- 1,048,676. FIT & TRIM. INT. CL. 31. (U.S. CL. 46). REG. 9-21-1976.
- 1,048,884. KIWI AND DESIGN. INT. CL. 7. (U.S. CL. 23). REG. 9-28-1976.
- 1,049,575. ROCK FACE. INT. CL. 19. (U.S. CLS. 1, 12, 33 AND 50). REG. 10-5-1976.
- 1,050,153. ATARI. INT. CL. 28. (U.S. CL. 22). REG. 10-12-1976.
- 1,050,510. THE GLUTTON. INT. CL. 7. (U.S. CL. 23). REG. 10-19-1976.
- 1,052,601. MOBIL (STYLIZED). INT. CL. 36. (U.S. CL. 102). REG. 11-9-1976.
- 1,053,021. CALICO. INT. CL. 29. (U.S. CL. 46). REG. 11-16-1976.
- 1,054,182. ABOUT FACES. INT. CLS. 3 AND 16. (U.S. CLS. 1, 4, 6, 38, 50, 51 AND 52). REG. 12-14-1976.
- 1,056,206. TOMOE AME. INT. CL. 30. (U.S. CL. 46). REG. 1-11-1977.
- 1,056,413. CYTADREN. INT. CL. 5. (U.S. CL. 18). REG. 1-18-1977.
- 1,058,789. WAREMART. INT. CL. 42. (U.S. CL. 100). REG. 2-8-1977.
- 1,059,359. GEIGER. INT. CL. 25. (U.S. CL. 39). REG. 2-15-1977.
- 1,065,160. BMD. INT. CL. 5. (U.S. CL. 18). REG. 5-10-1977.
- 1,065,253. FLIGHT EAGLE. INT. CL. 12. (U.S. CL. 35). REG. 5-10-1977.
- 1,067,344. SALAD MATE. INT. CL. 29. (U.S. CL. 46). REG. 6-7-1977.
- 1,067,631. STUTZ. INT. CL. 12. (U.S. CL. 19). REG. 6-14-1977.
- 1,068,220. ICICLE. INT. CL. 29. (U.S. CL. 46). REG. 6-21-1977.
- 1,069,587. SLEEP-N-AIRE. U.S. CL. 32. (INT. CL. 20). REG. 7-12-1977.
- 1,069,662. PYROTELL. INT. CL. 1. (U.S. CL. 6). REG. 7-19-1977.
- 1,070,053. DEKS OLJE. INT. CL. 2. (U.S. CL. 16). REG. 7-26-1977.
- 1,331,648. ALUMI-THERM. INT. CL. 6. (U.S. CL. 14). REG. 4-23-1985.
- 1,354,241. MICHELLE'S DESIGNS AND DESIGN. INT. CL. 25. (U.S. CL. 39). REG. 8-13-1985.
- 1,357,365. CRYOLIFE. INT. CL. 42. (U.S. CLS. 100 AND 106). REG. 8-27-1985.
- 1,357,366. MISCELLANEOUS DESIGN. INT. CL. 42. (U.S. CLS. 100 AND 106). REG. 8-27-1985.
- 1,363,202. TURBO TREATER. INT. CL. 11. (U.S. CL. 34). REG. 10-1-1985.
- 1,365,278. MC2 (STYLIZED). INT. CLS. 9 AND 16 ONLY. (U.S. CLS. 2, 5, 21, 22, 23, 26, 29, 36, 37, 38 AND 50). REG. 10-15-1985.
- 1,369,008. MRI. INT. CL. 19. (U.S. CL. 12). REG. 11-5-1985.
- 1,369,009. MRI AND DESIGN. INT. CL. 19. (U.S. CLS. 1, 12, 33 AND 50). REG. 11-5-1985.
- 1,371,543. FRESHNESS YOU EXPECT (STYLIZED). INT. CL. 29. (U.S. CL. 46). REG. 11-19-1985.
- 1,372,887. TEX-PRO. INT. CL. 30. (U.S. CL. 46). REG. 11-26-1985.
- 1,374,870. NO EXCUSES (STYLIZED). INT. CL. 25. (U.S. CL. 39). REG. 12-10-1985.
- 1,374,918. PHILLIPS. INT. CLS. 29, 30 AND 32. (U.S. CLS. 45 AND 46). REG. 12-10-1985.
- 1,376,241. HOMEBANK 24. INT. CL. 36. (U.S. CL. 102). REG. 12-17-1985.
- 1,376,348. ISA INDEPENDENT SOFTBALL ASSOCIATION AND DESIGN. INT. CL. 41. (U.S. CLS. 100, 101 AND 107). REG. 12-17-1985.
- 1,376,883. BFGOODRICH. INT. CLS. 6, 8, 9, 11, 14, 16, 18, 20, 21, 24, 25, 26, 28 AND 34. (U.S. CLS. 1, 2, 3, 5, 8, 9, 13, 17, 21, 22, 23, 25, 26, 27, 28, 29, 32, 36, 37, 38, 39, 40, 41, 42 AND 50). REG. 1-7-1986.
- 1,377,964. SNOZZLE (STYLIZED). INT. CL. 9. (U.S. CLS. 19 AND 26). REG. 1-14-1986.
- 1,377,965. HK AND DESIGN. INT. CL. 9. (U.S. CLS. 21, 23, 26, 36 AND 38). REG. 1-14-1986.
- 1,378,795. MIDORI. INT. CL. 16 ONLY. (U.S. CLS. 2, 5, 22, 23, 29, 37, 38 AND 50). REG. 1-21-1986.
- 1,380,456. "T" CONE. INT. CL. 20. (U.S. CL. 13). REG. 1-28-1986.
- 1,381,134. KEPTEL AND DESIGN. INT. CL. 9. (U.S. CL. 21). REG. 2-4-1986.
- 1,381,367. HONOR ROLL. INT. CL. 16. (U.S. CL. 37). REG. 2-4-1986.
- 1,381,990. SHOUT IT OUT!. INT. CL. 3. (U.S. CL. 52). REG. 2-11-1986.
- 1,382,889. PRESHIPMENT PLANNING. INT. CL. 35. (U.S. CLS. 101 AND 105). REG. 2-11-1986.
- 1,383,460. ULTRA NATURALS. INT. CL. 25. (U.S. CL. 39). REG. 2-18-1986.
- 1,384,205. DIAMOND LAND AND DESIGN. INT. CL. 14. (U.S. CL. 28). REG. 2-25-1986.
- 1,384,226. AUTO & TRUCK USED PARTS LOCATOR THE NATIONS LEADING AUTO AND TRUCK USED PARTS MAGAZINE AND DESIGN. INT. CL. 16. (U.S. CL. 38). REG. 2-25-1986.
- 1,385,566. A WHOLE WORLD OF FLAVORS IN EVERY BITE. INT. CL. 42. (U.S. CL. 100). REG. 3-4-1986.
- 1,387,007. POLMOS (STYLIZED). INT. CL. 33. (U.S. CL. 49). REG. 3-18-1986.
- 1,387,566. MISCELLANEOUS DESIGN. INT. CL. 21. (U.S. CL. 13). REG. 3-25-1986.
- 1,392,704. INTERHEALTH. INT. CL. 42. (U.S. CL. 100). REG. 5-6-1986.
- 1,393,959. STRATOS. INT. CL. 12. (U.S. CL. 19). REG. 5-20-1986.
- 1,396,488. MISCELLANEOUS DESIGN. INT. CL. 8. (U.S. CL. 34). REG. 6-10-1986.
- 1,401,633. AWA. INT. CL. 41. (U.S. CL. 107). REG. 7-15-1986.
- 1,401,693. WONGS WOK AND DESIGN. INT. CL. 42. (U.S. CL. 100). REG. 7-15-1986.
- 1,401,757. MISCELLANEOUS DESIGN. INT. CL. 1. (U.S. CL. 1). REG. 7-22-1986.
- 1,402,102. PRO-PERFECT. INT. CL. 16. (U.S. CL. 29). REG. 7-22-1986.
- 1,402,123. BCC AND DESIGN. INT. CL. 16. (U.S. CL. 38). REG. 7-22-1986.
- 1,402,715. GRIP-MASK. INT. CL. 2. (U.S. CL. 16). REG. 7-29-1986.
- 1,402,717. DYE-LITE. INT. CL. 2. (U.S. CL. 6). REG. 7-29-1986.
- 1,402,985. UNI-GARD. INT. CL. 9. (U.S. CL. 26). REG. 7-29-1986.
- 1,403,009. MONOJECT. INT. CL. 10. (U.S. CL. 44). REG. 7-29-1986.
- 1,403,066. SCREAMING REBEL. INT. CL. 13. (U.S. CL. 9). REG. 7-29-1986.
- 1,403,134. POLYKIT. INT. CL. 17. (U.S. CL. 12). REG. 7-29-1986.
- 1,403,422. APCO AUTOMOBILE PROTECTION CORP. (STYLIZED). INT. CL. 36. (U.S. CL. 102). REG. 7-29-1986.
- 1,403,640. TUFTONE. INT. CL. 1. (U.S. CLS. 1, 5, 6, 10, 26 AND 46). REG. 8-5-1986.
- 1,403,699. FANTASY MAKERS. INT. CL. 3. (U.S. CLS. 1, 4, 6, 50, 51 AND 52). REG. 8-5-1986.
- 1,403,761. KMSS. INT. CL. 6. (U.S. CLS. 3 AND 13). REG. 8-5-1986.
- 1,403,855. CONDUCT-TITE!. INT. CL. 9. (U.S. CL. 21). REG. 8-5-1986.

- 1,403,870. DURALUX. INT. CL. 9. (U.S. CL. 26). REG. 8-5-1986.
- 1,403,877. PARADIGM. INT. CL. 9. (U.S. CL. 21). REG. 8-5-1986.
- 1,404,100. MISCELLANEOUS DESIGN. INT. CL. 23. (U.S. CL. 43). REG. 8-5-1986.
- 1,404,122. TEHEN. INT. CL. 25. (U.S. CLS. 22 AND 39). REG. 8-5-1986.
- 1,404,313. JOSE CUERVO. INT. CL. 32. (U.S. CL. 45). REG. 8-5-1986.
- 1,404,367. MERCURY AIRCRAFT AND DESIGN. INT. CL. 37. (U.S. CL. 103). REG. 8-5-1986.
- 1,404,443. ESCA. INT. CL. 42. (U.S. CLS. 100, 101 AND 103). REG. 8-5-1986.
- 1,404,498. TOTAL CHARGE. INT. CL. 9. (U.S. CL. 21). REG. 8-5-1986.
- 1,404,502. FIREBOX. INT. CL. 9. (U.S. CL. 38). REG. 8-5-1986.
- 1,404,633. MURZAN. INT. CL. 7. (U.S. CL. 23). REG. 8-12-1986.
- 1,404,677. COMPU-GARD. INT. CL. 9. (U.S. CLS. 26 AND 32). REG. 8-12-1986.
- 1,404,799. SARAMET. INT. CL. 11. (U.S. CL. 34). REG. 8-12-1986.
- 1,404,815. MOTIVE GEAR. INT. CL. 12. (U.S. CLS. 19 AND 23). REG. 8-12-1986.
- 1,404,833. ARWEN. INT. CL. 13. (U.S. CL. 9). REG. 8-12-1986.
- 1,404,868. EXPRESSIONS (STYLIZED). INT. CL. 16. (U.S. CLS. 37 AND 38). REG. 8-12-1986.
- 1,404,912. CBC. INT. CLS. 16 AND 40. (U.S. CLS. 37 AND 106). REG. 8-12-1986.
- 1,404,944. MISCELLANEOUS DESIGN. INT. CLS. 18, 25 AND 28. (U.S. CLS. 3, 22 AND 39). REG. 8-12-1986.
- 1,405,025. GRIPPER. INT. CL. 25. (U.S. CL. 39). REG. 8-12-1986.
- 1,405,027. WEE ONES. INT. CLS. 25 AND 26. (U.S. CLS. 39 AND 40). REG. 8-12-1986.
- 1,405,184. PARKWAY. INT. CL. 31. (U.S. CL. 1). REG. 8-12-1986.
- 1,405,285. KFI. INT. CL. 38. (U.S. CL. 104). REG. 8-12-1986.
- 1,405,384. COMMUNICATING FOR AGRICULTURE. U.S. CL. 200. REG. 8-12-1986.
- 1,405,639. IER. INT. CL. 9. (U.S. CL. 26). REG. 8-19-1986.
- 1,405,659. MISCELLANEOUS DESIGN. INT. CL. 10. (U.S. CLS. 26, 39 AND 44). REG. 8-19-1986.
- 1,405,677. BODYSOFT. INT. CL. 10. (U.S. CL. 44). REG. 8-19-1986.
- 1,405,797. IAPMO INTERNATIONAL ASSOCIATION OF PLUMBING & MECHANICAL OFFICIALS FOUNDED 1926 AND DESIGN. INT. CL. 16. (U.S. CLS. 2, 5, 22, 23, 29, 37, 38 AND 50). REG. 8-19-1986.
- 1,405,800. MISCELLANEOUS DESIGN. INT. CL. 16. (U.S. CLS. 2, 37 AND 38). REG. 8-19-1986.
- 1,405,891. ALMOST. INT. CL. 24. (U.S. CL. 42). REG. 8-19-1986.
- 1,405,977. MISCELLANEOUS DESIGN. INT. CL. 28. (U.S. CL. 22). REG. 8-19-1986.
- 1,406,108. T. ROWE PRICE GROWTH & INCOME FUND. INT. CL. 36. (U.S. CL. 102). REG. 8-19-1986.
- 1,406,109. T. ROWE PRICE NEW AMERICA GROWTH FUND. INT. CL. 36. (U.S. CL. 102). REG. 8-19-1986.
- 1,406,110. T. ROWE PRICE GROWTH STOCK FUND. INT. CL. 36. (U.S. CL. 102). REG. 8-19-1986.
- 1,406,111. T. ROWE PRICE SHORT-TERM BOND FUND. INT. CL. 36. (U.S. CL. 102). REG. 8-19-1986.
- 1,406,112. T. ROWE PRICE NEW ERA FUND. INT. CL. 36. (U.S. CLS. 100, 101 AND 102). REG. 8-19-1986.
- 1,406,114. T. ROWE PRICE NEW HORIZONS FUND. INT. CL. 36. (U.S. CL. 102). REG. 8-19-1986.
- 1,406,115. T. ROWE PRICE NEW INCOME FUND. INT. CL. 36. (U.S. CL. 102). REG. 8-19-1986.
- 1,406,116. T. ROWE PRICE HIGH YIELD FUND. INT. CL. 36. (U.S. CL. 102). REG. 8-19-1986.
- 1,406,456. WABBITAT. INT. CL. 6. (U.S. CL. 3). REG. 8-26-1986.
- 1,406,608. REVO (STYLIZED). INT. CL. 9. (U.S. CL. 26). REG. 8-26-1986.
- 1,406,623. VACCESS. INT. CL. 10. (U.S. CL. 44). REG. 8-26-1986.
- 1,406,783. K (STYLIZED). INT. CL. 23. (U.S. CL. 43). REG. 8-26-1986.
- 1,407,195. CA. U.S. CL. 200. REG. 8-26-1986.
- 1,407,362. MICRO-FIT. INT. CL. 6. (U.S. CL. 13). REG. 9-2-1986.
- 1,407,667. MISCELLANEOUS DESIGN. INT. CL. 16. (U.S. CL. 37). REG. 9-2-1986.
- 1,407,674. PANTONE MATCHING SYSTEM AND DESIGN. INT. CL. 16. (U.S. CL. 38). REG. 9-2-1986.
- 1,407,781. KANVAS BY KATIN AND DESIGN. INT. CL. 25. (U.S. CL. 39). REG. 9-2-1986.
- 1,408,227. UNISON (STYLIZED). INT. CL. 7. (U.S. CL. 23). REG. 9-9-1986.
- 1,408,242. HUMMINGBIRD. INT. CL. 9. (U.S. CL. 38). REG. 9-9-1986.
- 1,408,300. DNA AND DESIGN. INT. CL. 9. (U.S. CLS. 26 AND 38). REG. 9-9-1986.
- 1,408,411. EMG AND DESIGN. INT. CL. 15. (U.S. CLS. 21 AND 36). REG. 9-9-1986.
- 1,408,511. MISCELLANEOUS DESIGN. INT. CL. 18. (U.S. CL. 3). REG. 9-9-1986.
- 1,408,898. INLAND AND DESIGN. INT. CL. 36 ONLY. (U.S. CLS. 100, 101 AND 102). REG. 9-9-1986.
- 1,409,571. DYNACOIL. INT. CL. 25. (U.S. CL. 39). REG. 9-16-1986.
- 1,409,675. CELEBRATION. INT. CL. 29. (U.S. CL. 46). REG. 9-16-1986.
- 1,409,696. MISCELLANEOUS DESIGN. INT. CL. 30. (U.S. CL. 46). REG. 9-16-1986.
- 1,410,374. FARBERWARE. INT. CLS. 11 AND 21. (U.S. CLS. 2, 13 AND 21). REG. 9-23-1986.
- 1,410,925. MARKON. INT. CL. 42. (U.S. CL. 101). REG. 9-23-1986.
- 1,411,051. A-LOOK. INT. CL. 6. (U.S. CLS. 12 AND 14). REG. 9-30-1986.
- 1,411,327. A ALFAGRES AND DESIGN. INT. CL. 19. (U.S. CL. 12). REG. 9-30-1986.
- 1,411,429. BLUE DEVILS. INT. CL. 25. (U.S. CL. 39). REG. 9-30-1986.
- 1,411,498. BURNER. INT. CL. 28. (U.S. CL. 22). REG. 9-30-1986.
- 1,411,797. ROBERT'S OF CHARLESTON (STYLIZED). INT. CL. 42. (U.S. CL. 100). REG. 9-30-1986.
- 1,412,173. ULTRAFIL AND DESIGN. INT. CL. 10. (U.S. CL. 44). REG. 10-7-1986.
- 1,412,219. HOOT AND DESIGN. INT. CL. 11. (U.S. CL. 23). REG. 10-7-1986.
- 1,412,834. MAGNA-TAC. INT. CL. 1. (U.S. CL. 5). REG. 10-14-1986.
- 1,414,696. MELAGENINA. INT. CL. 5. (U.S. CL. 18). REG. 10-28-1986.
- 1,414,862. VASCUTEK. INT. CL. 10. (U.S. CL. 44). REG. 10-28-1986.
- 1,415,115. VINYLOC. INT. CL. 27. (U.S. CL. 42). REG. 10-28-1986.
- 1,416,161. MISCELLANEOUS DESIGN. INT. CL. 30. (U.S. CL. 46). REG. 11-4-1986.
- 1,416,513. OXYCOIL. INT. CL. 10. (U.S. CL. 44). REG. 11-11-1986.
- 1,416,939. MISCELLANEOUS DESIGN. INT. CL. 36. (U.S. CL. 102). REG. 11-11-1986.
- 1,417,097. BEACON AND DESIGN. INT. CL. 1. (U.S. CLS. 5 AND 6). REG. 11-18-1986.
- 1,417,220. BANANA PEELER. INT. CL. 8. (U.S. CL. 23). REG. 11-18-1986.
- 1,417,591. PRIMROSE. INT. CLS. 29 AND 30. (U.S. CL. 46). REG. 11-18-1986.
- 1,418,655. MCSHUTTLE. INT. CL. 39. (U.S. CL. 105). REG. 11-25-1986.
- 1,418,740. EXXON. INT. CL. 42. (U.S. CLS. 100, 102, 103 AND 105). REG. 11-25-1986.
- 1,419,053. UNISON (STYLIZED). INT. CL. 9. (U.S. CLS. 21 AND 23). REG. 12-2-1986.
- 1,419,704. REALCUT. INT. CL. 4. (U.S. CL. 15). REG. 12-9-1986.
- 1,421,001. STEIMATZKY (STYLIZED). INT. CL. 16. (U.S. CL. 38). REG. 12-16-1986.
- 1,421,002. S AND DESIGN. INT. CL. 16. (U.S. CL. 38). REG. 12-16-1986.
- 1,421,283. POUR'N BAKE. INT. CL. 29. (U.S. CL. 46). REG. 12-16-1986.
- 1,421,742. BRAKETEX. INT. CL. 7. (U.S. CL. 35). REG. 12-23-1986.
- 1,423,057. MISCELLANEOUS DESIGN. INT. CL. 29. (U.S. CL. 46). REG. 12-30-1986.
- 1,423,344. WRIGHT STATE. INT. CL. 41. (U.S. CL. 107). REG. 12-30-1986.

- 1,424,579. MBCI AND DESIGN. INT. CL. 6. (U.S. CL. 12). REG. 1-13-1987.
- 1,424,781. KNOFF. INT. CL. 16. (U.S. CL. 38). REG. 1-13-1987.
- 1,425,420. AUREOZOL. INT. CL. 5. (U.S. CLS. 18 AND 46). REG. 1-20-1987.
- 1,425,612. ZING EAR. INT. CL. 9. (U.S. CL. 21). REG. 1-20-1987.
- 1,426,319. DISPATCH. INT. CL. 9. (U.S. CLS. 21 AND 26). REG. 1-27-1987.
- 1,426,701. HENDRICKSON'S. INT. CL. 29. (U.S. CL. 46). REG. 1-27-1987.
- 1,426,917. READ NOW. INT. CL. 41. (U.S. CL. 107). REG. 1-27-1987.
- 1,427,402. AKAH AND DESIGN. INT. CLS. 13 AND 18. (U.S. CLS. 1, 2, 3, 9, 22 AND 41). REG. 2-3-1987.
- 1,429,146. MIGHTYBAND. INT. CL. 11. (U.S. CL. 34). REG. 2-17-1987.
- 1,430,003. LOVE AND DESIGN. INT. CL. 9. (U.S. CL. 36). REG. 2-24-1987.
- 1,432,273. ULTRACARE. INT. CL. 36. (U.S. CL. 102). REG. 3-10-1987.
- 1,433,101. TOPS. INT. CL. 29. (U.S. CL. 46). REG. 3-17-1987.
- 1,437,687. APS II. INT. CL. 5. (U.S. CL. 18). REG. 4-28-1987.
- 1,437,731. ZETA-PAK. INT. CL. 7. (U.S. CLS. 23 AND 31). REG. 4-28-1987.
- 1,438,824. HYDRO-FLOC. INT. CL. 1. (U.S. CL. 6). REG. 5-12-1987.
- 1,441,681. GAMBLIN ARTIST'S OIL COLORS MADE BY ROBERT GAMBLIN AND DESIGN. INT. CL. 2. (U.S. CL. 16). REG. 6-9-1987.
- 1,442,236. GYMBO. INT. CL. 28. (U.S. CLS. 22, 23, 38 AND 50). REG. 6-9-1987.
- 1,442,994. TIZIO. INT. CL. 11. (U.S. CL. 21). REG. 6-16-1987.
- 1,444,318. BOSCO. INT. CL. 30. (U.S. CL. 46). REG. 6-23-1987.
- 1,445,712. MASTER-BREW. INT. CL. 42. (U.S. CLS. 100 AND 101). REG. 6-30-1987.
- 1,447,819. HONEY GRAZE. INT. CL. 31. (U.S. CL. 1). REG. 7-14-1987.
- 1,447,856. INTERNATIONAL FANCY FOOD & CONFECTION SHOW. INT. CL. 35. (U.S. CL. 101). REG. 7-14-1987.
- 1,447,870. CALIPER. INT. CLS. 35 AND 42. (U.S. CLS. 100 AND 101). REG. 7-14-1987.
- 1,448,763. FINCH DELIGHT. INT. CL. 31. (U.S. CL. 46). REG. 7-21-1987.
- 1,619,579. SUBSTITUTE FINDER. INT. CL. 9. (U.S. CLS. 21, 23, 26, 36 AND 38). REG. 10-30-1990.
- 1,843,860. CBT. INT. CL. 36. (U.S. CL. 102). REG. 7-5-1994.
- 1,889,171. FIBRE SHIELD. INT. CL. 9. (U.S. CLS. 26 AND 39). REG. 4-11-1995.
- 1,895,944. SCANTECH. INT. CLS. 9, 37 AND 42. (U.S. CLS. 26, 100 AND 103). REG. 5-30-1995.
- 1,897,430. RAINBOWMATE (STYLIZED). INT. CL. 9. (U.S. CLS. 21 AND 23). REG. 6-6-1995.
- 1,901,544. HARVEST AND DESIGN. INT. CL. 9. (U.S. CLS. 21, 23, 26, 36 AND 38). REG. 6-27-1995.
- 1,901,653. GRASON-STADLER. INT. CL. 10. (U.S. CLS. 26, 39 AND 44). REG. 6-27-1995.
- 1,903,403. PROTECH. INT. CL. 9. (U.S. CLS. 21, 23, 26, 36 AND 38). REG. 7-4-1995.
- 1,905,065. MANKIND. INT. CL. 25. (U.S. CLS. 22 AND 39). REG. 7-11-1995.
- 1,908,224. CARMA. INT. CL. 9. (U.S. CL. 38). REG. 8-1-1995.
- 1,914,956. PRIME-A-FLEX. INT. CL. 19. (U.S. CL. 12). REG. 8-29-1995.
- 1,915,937. SYNPLUS. INT. CL. 4. (U.S. CL. 15). REG. 9-5-1995.
- 1,918,600. CARING AND SERVING SINCE 1883 AND DESIGN. INT. CL. 42. (U.S. CLS. 100 AND 101). REG. 9-12-1995.
- 1,924,189. GCSAA/CGCS AND DESIGN. INT. CL. 41. (U.S. CLS. 100, 101 AND 107). REG. 10-3-1995.
- 1,939,901. DIVE-ALERT. INT. CL. 28. (U.S. CLS. 22, 23, 38 AND 50). REG. 12-5-1995.
- 1,941,144. HAN FENG (STYLIZED). INT. CLS. 14 AND 25 ONLY. (U.S. CLS. 2, 22, 27, 28, 39 AND 50). REG. 12-12-1995.
- 1,941,980. DCX. INT. CL. 37. (U.S. CLS. 100, 103 AND 106). REG. 12-19-1995.
- 1,946,499. LOADFAST. INT. CL. 1. (U.S. CLS. 1, 5, 6, 10, 26 AND 46). REG. 1-9-1996.
- 1,946,838. NINE POINTS OF VIEW VIDEO SERIES. INT. CL. 9. (U.S. CLS. 21, 23, 26, 36 AND 38). REG. 1-9-1996.
- 1,949,347. VOICETOUCH. INT. CL. 38. (U.S. CLS. 100, 101 AND 104). REG. 1-16-1996.
- 1,950,350. MISCELLANEOUS DESIGN. INT. CL. 6. (U.S. CL. 2). REG. 1-23-1996.
- 1,951,143. MISCELLANEOUS DESIGN. INT. CL. 36. (U.S. CLS. 100, 101 AND 102). REG. 1-23-1996.
- 1,951,505. TURF SOAP. INT. CL. 3. (U.S. CLS. 1, 4, 6, 50, 51 AND 52). REG. 1-23-1996.
- 1,951,506. STOPITCH. INT. CL. 5. (U.S. CLS. 6, 18, 44, 46, 51 AND 52). REG. 1-23-1996.
- 1,951,643. CLECS. INT. CLS. 5, 40 AND 42 ONLY. (U.S. CLS. 6, 18, 44, 46, 51, 52, 100, 101, 103 AND 106 ONLY). REG. 1-23-1996.
- 1,954,018. SCOFIELD THE BEST EUROPEAN AND DESIGN. INT. CL. 25. (U.S. CL. 39). REG. 2-6-1996.
- 1,954,333. ENERGY WISER. INT. CL. 11. (U.S. CLS. 13, 21, 23, 31 AND 34). REG. 2-6-1996.
- 1,954,954. SHOWBATH. INT. CL. 3. (U.S. CLS. 1, 4, 6, 50, 51 AND 52). REG. 2-6-1996.
- 1,955,430. "PROUD TO BE THE ORIGINAL". INT. CL. 3. (U.S. CLS. 1, 4, 6, 50, 51 AND 52). REG. 2-6-1996.
- 1,955,434. OFFICE SELECT. INT. CLS. 9 AND 16 ONLY. (U.S. CLS. 2, 5, 21, 22, 23, 26, 29, 36, 37, 38 AND 50). REG. 2-6-1996.
- 1,956,334. MISCELLANEOUS DESIGN. INT. CL. 30. (U.S. CL. 46). REG. 2-13-1996.
- 1,957,247. PRONOX. INT. CLS. 1, 9 AND 11. (U.S. CLS. 6, 26 AND 34). REG. 2-20-1996.
- 1,957,997. REGIONS MANAGEMENT ACCOUNT. INT. CL. 36. (U.S. CLS. 100, 101 AND 102). REG. 2-20-1996.
- 1,958,183. PENN (STYLIZED). INT. CL. 28. (U.S. CLS. 22, 23, 38 AND 50). REG. 2-27-1996.
- 1,958,499. DRI-WEAVE. INT. CL. 5. (U.S. CLS. 6, 18, 44, 46, 51 AND 52). REG. 2-27-1996.
- 1,958,571. CHIEF & SQUEAK'S CATMANIA! "CELEBRATING THE CAT!". INT. CL. 28. (U.S. CLS. 22, 23, 38 AND 50). REG. 2-27-1996.
- 1,958,826. PRO SUMMIT. INT. CL. 41. (U.S. CLS. 100, 101 AND 107). REG. 2-27-1996.
- 1,966,343. VIROMED LABORATORIES. INT. CL. 42. (U.S. CLS. 100 AND 101). REG. 4-9-1996.
- 1,966,424. VISRAP. INT. CL. 9. (U.S. CLS. 21, 23, 26, 36 AND 38). REG. 4-9-1996.
- 1,966,965. MAGNET BROOM. INT. CL. 21. (U.S. CLS. 2, 13, 29, 30, 33, 40 AND 50). REG. 4-9-1996.
- 1,967,107. CALIFORNIA CAFE. INT. CL. 42. (U.S. CLS. 100 AND 101). REG. 4-9-1996.
- 1,967,521. SNAP-LOCK. INT. CL. 27. (U.S. CLS. 19, 20, 37, 42 AND 50). REG. 4-9-1996.
- 1,970,988. VINPLUS. INT. CL. 9. (U.S. CLS. 21, 23, 26, 36 AND 38). REG. 4-30-1996.
- 1,972,939. CHEETAH AND DESIGN. INT. CL. 7. (U.S. CLS. 13, 19, 21, 23, 31, 34 AND 35). REG. 5-7-1996.
- 1,977,116. MATSS. INT. CL. 42. (U.S. CLS. 100 AND 101). REG. 5-28-1996.
- 1,977,748. EXXON TRAVEL CLUB AND DESIGN. INT. CLS. 37 AND 42. (U.S. CLS. 100, 101, 103 AND 106). REG. 6-4-1996.
- 1,977,925. JADE. INT. CLS. 16 AND 28. (U.S. CLS. 2, 5, 22, 23, 29, 37, 38 AND 50). REG. 6-4-1996.
- 1,978,647. DIAMOND OFFSHORE AND DESIGN. INT. CL. 37. (U.S. CLS. 100 AND 103). REG. 6-4-1996.
- 1,979,814. MAXIM-200. INT. CL. 5. (U.S. CLS. 6, 18, 44, 46, 51 AND 52). REG. 6-11-1996.
- 1,979,895. UNCF AND DESIGN. INT. CL. 36. (U.S. CLS. 100, 101 AND 102). REG. 6-11-1996.
- 1,980,039. OAKLEY (STYLIZED). INT. CLS. 9 AND 25. (U.S. CLS. 21, 22, 23, 26, 36, 38 AND 39). REG. 6-11-1996.
- 1,980,947. MISCELLANEOUS DESIGN. INT. CL. 29. (U.S. CL. 46). REG. 6-18-1996.
- 1,981,381. TTC TOTAL TRAIN CONTROL AND DESIGN. INT. CL. 9 ONLY. (U.S. CLS. 21, 23, 26, 36 AND 38). REG. 6-18-1996.
- 1,981,511. INTELLIGENT SEARCH. INT. CL. 35. (U.S. CLS. 100, 101 AND 102). REG. 6-18-1996.
- 1,981,701. I.C.E. WHIP. INT. CL. 3. (U.S. CLS. 1, 4, 6, 50, 51 AND 52). REG. 6-18-1996.
- 1,981,769. SMART TIMER. INT. CL. 9. (U.S. CLS. 21, 23, 26, 36 AND 38). REG. 6-18-1996.
- 1,981,840. SWAG. INT. CL. 25. (U.S. CLS. 22 AND 39). REG. 6-25-1996.
- 1,982,172. VISTA WEB. INT. CL. 42. (U.S. CLS. 100 AND 101). REG. 6-25-1996.

- 1,984,028. CLEF RECORDS. INT. CL. 9. (U.S. CLS. 21, 23, 26, 36 AND 38). REG. 7-2-1996.
- 1,984,140. WATER WONDERS. INT. CL. 28. (U.S. CLS. 22, 23, 38 AND 50). REG. 7-2-1996.
- 1,984,501. O (STYLIZED). INT. CLS. 9 AND 25. (U.S. CLS. 21, 22, 23, 26, 36, 38 AND 39). REG. 7-2-1996.
- 1,984,791. BISHOP STREET FUNDS. INT. CL. 36. (U.S. CLS. 100, 101 AND 102). REG. 7-2-1996.
- 1,985,710. FLOWER LINK. INT. CL. 35. (U.S. CLS. 100, 101 AND 102). REG. 7-9-1996.
- 1,986,416. PH-DETECT. INT. CL. 5. (U.S. CLS. 6, 18, 44, 46, 51 AND 52). REG. 7-9-1996.
- 1,986,471. E LAND JUNIOR AND DESIGN. INT. CL. 25. (U.S. CL. 39). REG. 7-16-1996.
- 1,986,961. GEOVATOR. INT. CL. 28. (U.S. CLS. 22, 23, 38 AND 50). REG. 7-16-1996.
- 1,987,331. MERRELL 45° AND DESIGN. INT. CL. 25. (U.S. CLS. 22 AND 39). REG. 7-16-1996.
- 1,987,360. BETTER YOUR HOME SERIES AND DESIGN. INT. CL. 6. (U.S. CLS. 2, 12, 13, 14, 23, 25 AND 50). REG. 7-16-1996.
- 1,987,361. BETTER YOUR HOME. INT. CL. 6. (U.S. CLS. 2, 12, 13, 14, 23, 25 AND 50). REG. 7-16-1996.
- 1,987,420. SOFTCEL. INT. CL. 17. (U.S. CLS. 1, 5, 12, 13, 35 AND 50). REG. 7-16-1996.
- 1,987,807. VINCENT'S ORIGINAL SAUCE SINCE 1904 NYC MOTT ST. NYC HESTER ST. AND DESIGN. INT. CL. 30. (U.S. CL. 46). REG. 7-23-1996.
- 1,987,846. ALL AMERICAN GIRLS PROFESSIONAL BASEBALL LEAGUE. INT. CLS. 16 AND 25 ONLY. (U.S. CLS. 2, 5, 22, 23, 29, 37, 38, 39 AND 50). REG. 7-23-1996.
- 1,987,935. CEBE AND DESIGN. INT. CL. 28 ONLY. (U.S. CLS. 22, 23, 38 AND 50). REG. 7-23-1996.
- 1,988,128. MAC JACK. INT. CL. 7. (U.S. CLS. 13, 19, 21, 23, 31, 34 AND 35). REG. 7-23-1996.
- 1,988,193. CYCLEPLATE. INT. CL. 9. (U.S. CLS. 21, 23, 26, 36 AND 38). REG. 7-23-1996.
- 1,988,572. VELVET DOG. INT. CL. 42. (U.S. CLS. 100 AND 101). REG. 7-23-1996.
- 1,988,579. SOLAREX. INT. CL. 17. (U.S. CLS. 1, 5, 12, 13, 35 AND 50). REG. 7-23-1996.
- 1,989,049. XP-20. INT. CL. 5. (U.S. CLS. 6, 18, 44, 46, 51 AND 52). REG. 7-23-1996.
- 1,989,079. FLEET POWER. INT. CL. 9. (U.S. CLS. 21, 23, 26, 36 AND 38). REG. 7-23-1996.
- 1,989,101. ECOTEL. U.S. CL. B. REG. 7-23-1996.
- 1,989,102. ECOTEL AND DESIGN. U.S. CL. B. REG. 7-23-1996.
- 1,989,146. WHITEBLAST. INT. CL. 3. (U.S. CLS. 1, 4, 6, 50, 51 AND 52). REG. 7-23-1996.
- 1,989,255. GAMECASH. INT. CL. 36. (U.S. CLS. 100, 101 AND 102). REG. 7-23-1996.
- 1,990,202. POWER. INT. CL. 10. (U.S. CLS. 26, 39 AND 44). REG. 7-30-1996.
- 1,990,727. RESOLVE INC. REAL BUSINESS SOLUTIONS AND DESIGN. INT. CLS. 35 AND 36. (U.S. CLS. 100, 101 AND 102). REG. 8-6-1996.
- 1,990,811. BASTIEN. INT. CL. 25. (U.S. CLS. 22 AND 39). REG. 8-6-1996.
- 1,990,819. BLACK BART. INT. CL. 42. (U.S. CLS. 100 AND 101). REG. 8-6-1996.
- 1,990,838. MISCELLANEOUS DESIGN. INT. CL. 9 ONLY. (U.S. CLS. 21, 23, 26, 36 AND 38). REG. 8-6-1996.
- 1,990,969. PRESO. INT. CL. 9. (U.S. CLS. 21, 23, 26, 36 AND 38). REG. 8-6-1996.
- 1,991,125. ION COMPUTER SYSTEMS AND DESIGN. INT. CL. 42. (U.S. CLS. 100 AND 101). REG. 8-6-1996.
- 1,991,199. TIME IN A BOX. INT. CL. 9. (U.S. CLS. 21, 23, 26, 36 AND 38). REG. 8-6-1996.
- 1,991,399. 4135. INT. CL. 9. (U.S. CLS. 21, 23, 26, 36 AND 38). REG. 8-6-1996.
- 1,991,419. LOGOART. INT. CL. 14. (U.S. CLS. 2, 27, 28 AND 50). REG. 8-6-1996.
- 1,991,440. KIKO COMFORTABLE CLOTHING (STYLIZED). INT. CL. 25. (U.S. CLS. 22 AND 39). REG. 8-6-1996.
- 1,991,441. SANDBAND. INT. CL. 18. (U.S. CLS. 1, 2, 3, 22 AND 41). REG. 8-6-1996.
- 1,991,503. BIO-TITE. INT. CL. 10. (U.S. CLS. 26, 39 AND 44). REG. 8-6-1996.
- 1,991,571. MISCELLANEOUS DESIGN. INT. CL. 28. (U.S. CLS. 22, 23, 38 AND 50). REG. 8-6-1996.
- 1,991,581. SBARRO. INT. CL. 30 ONLY. (U.S. CL. 46). REG. 8-6-1996.
- 1,991,591. 200 MECHANICS (STYLIZED). INT. CL. 9. (U.S. CLS. 21, 23, 26, 36 AND 38). REG. 8-6-1996.
- 1,991,633. RELATIONSHIP-CENTERED CHILD CARE. INT. CL. 41. (U.S. CLS. 100, 101 AND 107). REG. 8-6-1996.
- 1,991,643. OCCUNOMIX. INT. CL. 9. (U.S. CLS. 21, 23, 26, 36 AND 38). REG. 8-6-1996.
- 1,991,674. FJ (STYLIZED). INT. CL. 14. (U.S. CLS. 2, 27, 28 AND 50). REG. 8-6-1996.
- 1,991,800. POWER WAVE. INT. CL. 9. (U.S. CLS. 21, 23, 26, 36 AND 38). REG. 8-6-1996.
- 1,991,834. PLATINUM AHOME HARVEST. INT. CL. 29. (U.S. CL. 46). REG. 8-6-1996.
- 1,991,938. PERSPECTIVES. INT. CL. 24. (U.S. CLS. 42 AND 50). REG. 8-6-1996.
- 1,991,992. M.A.T.H.I.S.. INT. CL. 42. (U.S. CLS. 100 AND 101). REG. 8-6-1996.
- 1,992,032. MISCELLANEOUS DESIGN. INT. CL. 16. (U.S. CLS. 2, 5, 22, 23, 29, 37, 38 AND 50). REG. 8-6-1996.
- 1,992,035. RHINO. INT. CL. 9. (U.S. CLS. 21, 23, 26, 36 AND 38). REG. 8-6-1996.
- 1,992,043. REBOUND. INT. CL. 32. (U.S. CLS. 45, 46 AND 48). REG. 8-6-1996.
- 1,992,098. FIRST RETIREMENT PLAN. INT. CL. 36. (U.S. CLS. 100, 101 AND 102). REG. 8-6-1996.
- 1,992,110. GRIT. INT. CL. 36. (U.S. CLS. 100, 101 AND 102). REG. 8-6-1996.
- 1,992,128. MISCELLANEOUS DESIGN. INT. CL. 29. (U.S. CL. 46). REG. 8-6-1996.
- 1,992,184. PRESSURERISER. INT. CL. 9. (U.S. CLS. 21, 23, 26, 36 AND 38). REG. 8-6-1996.
- 1,992,216. THE SCENT THAT SMOKES. INT. CL. 28. (U.S. CLS. 22, 23, 38 AND 50). REG. 8-6-1996.
- 1,992,276. SIGNAL. INT. CL. 5. (U.S. CLS. 6, 18, 44, 46, 51 AND 52). REG. 8-13-1996.
- 1,992,324. SANTANA. INT. CL. 25. (U.S. CLS. 22 AND 39). REG. 8-13-1996.
- 1,992,401. BROADWAY ANGEL AND DESIGN. INT. CL. 9. (U.S. CLS. 21, 23, 26, 36 AND 38). REG. 8-13-1996.
- 1,992,466. CRAFTEC. INT. CLS. 37 AND 42. (U.S. CLS. 100, 101, 103 AND 106). REG. 8-13-1996.
- 1,992,542. FIRM FOUNDATION PRESS. INT. CL. 16. (U.S. CLS. 2, 5, 22, 23, 29, 37, 38 AND 50). REG. 8-13-1996.
- 1,992,640. CHICAGO PUMP. INT. CL. 7. (U.S. CLS. 13, 19, 21, 23, 31, 34 AND 35). REG. 8-13-1996.
- 1,992,731. MISCELLANEOUS DESIGN. INT. CL. 20. (U.S. CLS. 2, 13, 22, 25, 32 AND 50). REG. 8-13-1996.
- 1,992,756. P LA PASTA DI GIULIO PAGANI MADE WITH 100% FIRST QUALITY DURUM SEMOLINA AND DESIGN. INT. CL. 30. (U.S. CL. 46). REG. 8-13-1996.
- 1,992,759. GG. INT. CLS. 9, 11 AND 12. (U.S. CLS. 13, 19, 21, 23, 26, 31, 34, 35, 36, 38 AND 44). REG. 8-13-1996.
- 1,992,781. ME, INC.. INT. CL. 41. (U.S. CLS. 100, 101 AND 107). REG. 8-13-1996.
- 1,992,874. E-Z UP WORLD'S FASTEST SHELTERS ORIGINAL SHADE AND DESIGN. INT. CL. 19. (U.S. CLS. 1, 12, 33 AND 50). REG. 8-13-1996.
- 1,992,947. MEGADAC. INT. CL. 9. (U.S. CLS. 21, 23, 26, 36 AND 38). REG. 8-13-1996.
- 1,992,948. MISCELLANEOUS DESIGN. INT. CLS. 9, 14, 16, 21, 24, 25 AND 28. (U.S. CLS. 2, 5, 13, 21, 22, 23, 26, 27, 28, 29, 30, 33, 36, 37, 38, 39, 40, 42 AND 50). REG. 8-13-1996.
- 1,992,953. COREMEDIA. INT. CLS. 9 AND 16. (U.S. CLS. 2, 5, 21, 22, 23, 26, 29, 36, 37, 38 AND 50). REG. 8-13-1996.
- 1,992,963. PROCOAT AND DESIGN. INT. CL. 1. (U.S. CLS. 1, 5, 6, 10, 26 AND 46). REG. 8-13-1996.
- 1,993,137. CLASSY. INT. CL. 20. (U.S. CLS. 2, 13, 22, 25, 32 AND 50). REG. 8-13-1996.
- 1,993,162. BUSINESSNORTH. INT. CL. 16. (U.S. CLS. 2, 5, 22, 23, 29, 37, 38 AND 50). REG. 8-13-1996.
- 1,993,182. NORTHERN HARDY. INT. CL. 31. (U.S. CLS. 1 AND 46). REG. 8-13-1996.
- 1,993,183. BLUE WONDER. INT. CL. 31. (U.S. CLS. 1 AND 46). REG. 8-13-1996.
- 1,993,359. SILVERSTONE. INT. CL. 7. (U.S. CLS. 13, 19, 21, 23, 31, 34 AND 35). REG. 8-13-1996.
- 1,993,398. VEGETARIAN BELL. INT. CL. 35. (U.S. CLS. 100, 101 AND 102). REG. 8-13-1996.

- 1,993,428. THE NAME TO TRUST IN RETIREMENT LIVING. INT. CL. 42. (U.S. CLS. 100 AND 101). REG. 8-13-1996.
- 1,993,448. MISCELLANEOUS DESIGN. INT. CL. 42. (U.S. CLS. 100 AND 101). REG. 8-13-1996.
- 1,993,450. MISCELLANEOUS DESIGN. INT. CL. 9. (U.S. CLS. 21, 23, 26, 36 AND 38). REG. 8-13-1996.
- 1,993,451. MISCELLANEOUS DESIGN. INT. CL. 37. (U.S. CLS. 100, 103 AND 106). REG. 8-13-1996.
- 1,993,452. MISCELLANEOUS DESIGN. INT. CL. 41. (U.S. CLS. 100, 101 AND 107). REG. 8-13-1996.
- 1,993,503. CABLECONTROL. INT. CL. 9. (U.S. CLS. 21, 23, 26, 36 AND 38). REG. 8-13-1996.
- 1,993,594. PULLBRITE. INT. CL. 40. (U.S. CLS. 100, 103 AND 106). REG. 8-13-1996.
- 1,993,654. TIOGA. INT. CL. 3. (U.S. CLS. 1, 4, 6, 50, 51 AND 52). REG. 8-13-1996.
- 1,993,731. EAT MORE, WEIGH LESS. INT. CL. 16. (U.S. CLS. 2, 5, 22, 23, 29, 37, 38 AND 50). REG. 8-13-1996.
- 1,993,884. HEALTHY HORIZONS. INT. CL. 5. (U.S. CLS. 6, 18, 44, 46, 51 AND 52). REG. 8-13-1996.
- 1,993,890. BRUNELLESICO. INT. CL. 33. (U.S. CLS. 47 AND 49). REG. 8-13-1996.
- 1,993,941. ACCELERATED REHABILITATION CENTERS AND DESIGN. INT. CL. 42. (U.S. CLS. 100 AND 101). REG. 8-13-1996.
- 1,993,943. WINCROSS. INT. CL. 9. (U.S. CLS. 21, 23, 26, 36 AND 38). REG. 8-13-1996.
- 1,993,948. MISCELLANEOUS DESIGN. INT. CL. 29. (U.S. CL. 46). REG. 8-13-1996.
- 1,994,029. EVER-LOCK. INT. CL. 1. (U.S. CLS. 1, 5, 6, 10, 26 AND 46). REG. 8-13-1996.
- 1,994,043. K'LYTE. INT. CLS. 22 AND 28. (U.S. CLS. 1, 2, 7, 19, 22, 23, 38, 42 AND 50). REG. 8-13-1996.
- 1,994,053. RAPID ROCK. INT. CL. 19. (U.S. CLS. 1, 12, 33 AND 50). REG. 8-13-1996.
- 1,994,074. SGIA AND DESIGN. INT. CL. 42. (U.S. CLS. 100 AND 101). REG. 8-13-1996.
- 1,994,102. PROM. INT. CL. 25. (U.S. CLS. 22 AND 39). REG. 8-13-1996.
- 1,994,196. SOUTHWATER. INT. CL. 39. (U.S. CLS. 100 AND 105). REG. 8-13-1996.
- 1,994,208. ENERGYACCESS. INT. CL. 9. (U.S. CLS. 21, 23, 26, 36 AND 38). REG. 8-13-1996.
- 1,994,215. CASHMALURE. INT. CL. 25. (U.S. CLS. 22 AND 39). REG. 8-13-1996.
- 1,994,283. MISCELLANEOUS DESIGN. INT. CL. 30. (U.S. CL. 46). REG. 8-20-1996.
- 1,994,447. VIERA AND DESIGN. INT. CLS. 36, 37 AND 42. (U.S. CLS. 100, 101, 102, 103 AND 106). REG. 8-20-1996.
- 1,994,448. VIERA. INT. CLS. 36, 37 AND 42. (U.S. CLS. 100, 101, 102, 103 AND 106). REG. 8-20-1996.
- 1,994,455. GOP TV REPUBLICAN NATIONAL COMMITTEE AND DESIGN. INT. CLS. 16, 38 AND 41. (U.S. CLS. 2, 5, 22, 23, 29, 37, 38, 50, 100, 101, 104 AND 107). REG. 8-20-1996.
- 1,994,555. SPECIAL EFFECTS. INT. CLS. 6 AND 20. (U.S. CLS. 2, 12, 13, 14, 22, 23, 25, 32 AND 50). REG. 8-20-1996.
- 1,994,624. LUKKI. INT. CL. 7. (U.S. CLS. 13, 19, 21, 23, 31, 34 AND 35). REG. 8-20-1996.
- 1,994,674. LE VOLTE AND DESIGN. INT. CL. 33. (U.S. CLS. 47 AND 49). REG. 8-20-1996.
- 1,994,686. BUSINESS ACCESS. INT. CL. 36. (U.S. CLS. 100, 101 AND 102). REG. 8-20-1996.
- 1,994,747. BLUE STAR. INT. CL. 5. (U.S. CLS. 6, 18, 44, 46, 51 AND 52). REG. 8-20-1996.
- 1,994,830. SMITH SECURITY CORPORATION AND DESIGN. INT. CL. 42. (U.S. CLS. 100 AND 101). REG. 8-20-1996.
- 1,994,940. MISCELLANEOUS DESIGN. INT. CL. 25 ONLY. (U.S. CLS. 22 AND 39). REG. 8-20-1996.
- 1,994,970. E-Z UP. INT. CL. 19. (U.S. CLS. 1, 12, 33 AND 50). REG. 8-20-1996.
- 1,995,026. EMJ. INT. CLS. 40 AND 42. (U.S. CLS. 100, 101, 103 AND 106). REG. 8-20-1996.
- 1,995,117. CABLEFAX DAILY. INT. CL. 16. (U.S. CLS. 2, 5, 22, 23, 29, 37, 38 AND 50). REG. 8-20-1996.
- 1,995,127. TOP OIL PRODUCTS COMPANY. INT. CL. 4. (U.S. CLS. 1, 6 AND 15). REG. 8-20-1996.
- 1,995,188. E FOUNT AND DESIGN. INT. CL. 11. (U.S. CLS. 13, 21, 23, 31 AND 34). REG. 8-20-1996.
- 1,995,265. SNAP INTO A SLIM JIM. INT. CL. 29. (U.S. CL. 46). REG. 8-20-1996.
- 1,995,272. THE CAT SITTER. INT. CL. 28. (U.S. CLS. 22, 23, 38 AND 50). REG. 8-20-1996.
- 1,995,504. EASTGUARD INSURANCE COMPANY. INT. CL. 36. (U.S. CLS. 100, 101 AND 102). REG. 8-20-1996.
- 1,995,577. TSB AND DESIGN. INT. CL. 36. (U.S. CLS. 100, 101 AND 102). REG. 8-20-1996.
- 1,995,584. HYBRIZAP. INT. CL. 1. (U.S. CLS. 1, 5, 6, 10, 26 AND 46). REG. 8-20-1996.
- 1,995,587. UNI-ZAP. INT. CL. 1. (U.S. CLS. 1, 5, 6, 10, 26 AND 46). REG. 8-20-1996.
- 1,995,593. THE PRESIDENTS OF THE UNITED STATES OF AMERICA. INT. CL. 41. (U.S. CLS. 100, 101 AND 107). REG. 8-20-1996.
- 1,995,651. SURE SEAL. INT. CL. 17. (U.S. CLS. 1, 5, 12, 13, 35 AND 50). REG. 8-20-1996.
- 1,995,699. ALPHALITE. INT. CL. 21. (U.S. CLS. 2, 13, 23, 29, 30, 33, 40 AND 50). REG. 8-20-1996.
- 1,995,768. WATER MAGIC. INT. CL. 3. (U.S. CLS. 1, 4, 6, 50, 51 AND 52). REG. 8-20-1996.
- 1,995,776. ALPHASORB. INT. CL. 21. (U.S. CLS. 2, 13, 23, 29, 30, 33, 40 AND 50). REG. 8-20-1996.
- 1,995,786. ALPHA. INT. CL. 21. (U.S. CLS. 2, 13, 23, 29, 30, 33, 40 AND 50). REG. 8-20-1996.
- 1,995,814. PILOT. INT. CL. 10. (U.S. CLS. 26, 39 AND 44). REG. 8-20-1996.
- 1,995,828. S (STYLIZED). INT. CL. 9. (U.S. CLS. 21, 23, 26, 36 AND 38). REG. 8-20-1996.
- 1,995,838. JUST FRESH. INT. CL. 42. (U.S. CLS. 100 AND 101). REG. 8-20-1996.
- 1,995,891. JERKY TREATS CHICKEN GRILLERS. INT. CL. 31. (U.S. CLS. 1 AND 46). REG. 8-20-1996.
- 1,996,010. J. MAC. INT. CL. 25. (U.S. CLS. 22 AND 39). REG. 8-20-1996.
- 1,996,106. ORBS. INT. CL. 9. (U.S. CLS. 21, 23, 26, 36 AND 38). REG. 8-20-1996.
- 1,996,123. SHURJOINT AND DESIGN. INT. CL. 6. (U.S. CLS. 2, 12, 13, 14, 23, 25 AND 50). REG. 8-20-1996.
- 1,996,200. BEN PAO. INT. CL. 42. (U.S. CLS. 100 AND 101). REG. 8-20-1996.
- 1,996,347. MISCELLANEOUS DESIGN. INT. CL. 16 ONLY. (U.S. CLS. 2, 5, 22, 23, 29, 37, 38 AND 50). REG. 8-27-1996.
- 1,996,456. WARD'S ENGINE AND VEHICLE TECHNOLOGY UPDATE. INT. CL. 16. (U.S. CLS. 2, 5, 22, 23, 29, 37, 38 AND 50). REG. 8-27-1996.
- 1,996,504. CARTEN. INT. CL. 9. (U.S. CLS. 21, 23, 26, 36 AND 38). REG. 8-27-1996.
- 1,996,522. PNEU-SA. INT. CL. 7. (U.S. CLS. 13, 19, 21, 23, 31, 34 AND 35). REG. 8-27-1996.
- 1,996,583. SHEN MIN. INT. CL. 5. (U.S. CLS. 6, 18, 44, 46, 51 AND 52). REG. 8-27-1996.
- 1,996,587. SCHUMASOIL. INT. CL. 1. (U.S. CLS. 1, 5, 6, 10, 26 AND 46). REG. 8-27-1996.
- 1,996,655. MISCELLANEOUS DESIGN. INT. CLS. 25, 29, 30 AND 42. (U.S. CLS. 22, 39, 46, 100 AND 101). REG. 8-27-1996.
- 1,996,657. VIP VIRTUAL INVENTORY PROGRAM AND DESIGN. INT. CL. 35. (U.S. CLS. 100, 101 AND 102). REG. 8-27-1996.
- 1,996,676. AMBASSADOR AND DESIGN. INT. CLS. 16, 26 AND 28. (U.S. CLS. 2, 5, 22, 23, 29, 37, 38, 39, 40, 42 AND 50). REG. 8-27-1996.
- 1,996,689. MELLO. INT. CL. 9. (U.S. CLS. 21, 23, 26, 36 AND 38). REG. 8-27-1996.
- 1,996,707. KAUAI TIMES. INT. CL. 16. (U.S. CLS. 2, 5, 22, 23, 29, 37, 38 AND 50). REG. 8-27-1996.
- 1,996,827. PREDATOR. INT. CL. 12. (U.S. CLS. 19, 21, 23, 31, 35 AND 44). REG. 8-27-1996.
- 1,996,858. ORIGINAL VOICES. INT. CL. 42. (U.S. CLS. 100 AND 101). REG. 8-27-1996.
- 1,996,908. PERMASEAL. INT. CL. 6. (U.S. CLS. 2, 12, 13, 14, 23, 25 AND 50). REG. 8-27-1996.
- 1,996,929. ADS. INT. CL. 5. (U.S. CLS. 6, 18, 44, 46, 51 AND 52). REG. 8-27-1996.
- 1,996,986. SPRINKLER WORLD. INT. CL. 11. (U.S. CLS. 13, 21, 23, 31 AND 34). REG. 8-27-1996.
- 1,997,003. REBOUND. INT. CL. 12. (U.S. CLS. 19, 21, 23, 31, 35 AND 44). REG. 8-27-1996.
- 1,997,126. ERGO-COMFORT. INT. CL. 9. (U.S. CLS. 21, 23, 26, 36 AND 38). REG. 8-27-1996.
- 1,997,215. OMNI. INT. CL. 9. (U.S. CLS. 21, 23, 26, 36 AND 38). REG. 8-27-1996.
- 1,997,343. RACERS. INT. CL. 36. (U.S. CLS. 100, 101 AND 102). REG. 8-27-1996.

- 1,997,375. TURBOSLOT. INT. CL. 28. (U.S. CLS. 22, 23, 38 AND 50). REG. 8-27-1996.
- 1,997,394. 3M (STYLIZED). INT. CL. 17. (U.S. CLS. 1, 5, 12, 13, 35 AND 50). REG. 8-27-1996.
- 1,997,410. VANGUARD TAX-MANAGED FUNDS. INT. CL. 36. (U.S. CLS. 100, 101 AND 102). REG. 8-27-1996.
- 1,997,619. FOWNES. INT. CL. 25. (U.S. CLS. 22 AND 39). REG. 8-27-1996.
- 1,997,697. COMPUTER RESELLER NEWS TEST CENTER. INT. CL. 16. (U.S. CLS. 2, 5, 22, 23, 29, 37, 38 AND 50). REG. 8-27-1996.
- 1,997,783. SAVE-ON-FOODS. INT. CL. 42. (U.S. CL. 101). REG. 9-3-1996.
- 1,998,009. K KINKELDER AND DESIGN. INT. CL. 7. (U.S. CLS. 13, 19, 21, 23, 31, 34 AND 35). REG. 9-3-1996.
- 1,998,264. LOOK 'N GOOD. INT. CL. 12. (U.S. CLS. 19, 21, 23, 31, 35 AND 44). REG. 9-3-1996.
- 1,998,269. MODERN CRAZE. INT. CL. 12. (U.S. CLS. 19, 21, 23, 31, 35 AND 44). REG. 9-3-1996.
- 1,998,457. GOOD FOR YOU IS ALL WE DO. INT. CL. 42. (U.S. CLS. 100 AND 101). REG. 9-3-1996.
- 1,998,474. LUTREL. INT. CL. 1. (U.S. CLS. 1, 5, 6, 10, 26 AND 46). REG. 9-3-1996.
- 1,998,482. SIGNATURE. INT. CLS. 37, 39 AND 42 ONLY. (U.S. CLS. 100, 101, 103, 105 AND 106). REG. 9-3-1996.
- 1,998,576. THE DRAITON CORPORATION, INC.. INT. CL. 35. (U.S. CLS. 100, 101 AND 102). REG. 9-3-1996.
- 1,998,766. INFORM. INT. CL. 9. (U.S. CLS. 21, 23, 26, 36 AND 38). REG. 9-3-1996.
- 1,999,090. SKIN SOLUTIONS. INT. CL. 42. (U.S. CLS. 100 AND 101). REG. 9-10-1996.
- 1,999,267. I (STYLIZED). INT. CL. 25. (U.S. CLS. 22 AND 39). REG. 9-10-1996.
- 1,999,621. MEDIAMARK REPORTER. INT. CL. 9. (U.S. CLS. 21, 23, 26, 36 AND 38). REG. 9-10-1996.
- 1,999,829. ERNIE BEAR. INT. CL. 9. (U.S. CLS. 21, 23, 26, 36 AND 38). REG. 9-10-1996.
- 1,999,872. MVP. INT. CL. 39. (U.S. CLS. 100 AND 105). REG. 9-10-1996.
- 2,000,052. HEAVEN'S UNOFFICIAL GREETINGS. INT. CL. 16. (U.S. CLS. 2, 5, 22, 23, 29, 37, 38 AND 50). REG. 9-10-1996.
- 2,000,097. MERIDIAN. INT. CL. 18. (U.S. CLS. 1, 2, 3, 22 AND 41). REG. 9-10-1996.
- 2,000,333. LONGMORN. INT. CL. 33. (U.S. CLS. 47 AND 49). REG. 9-10-1996.
- 2,000,613. PASSOA THE PASSION DRINK. INT. CL. 33. (U.S. CLS. 47 AND 49). REG. 9-17-1996.
- 2,000,629. MISCELLANEOUS DESIGN. INT. CL. 9. (U.S. CL. 26). REG. 9-17-1996.
- 2,000,996. PRIVACY WATCH. INT. CL. 42. (U.S. CLS. 100 AND 101). REG. 9-17-1996.
- 2,001,003. ENTERTAINMENT WEEKLY. INT. CL. 41. (U.S. CLS. 100, 101 AND 107). REG. 9-17-1996.
- 2,001,160. MISCELLANEOUS DESIGN. INT. CL. 37. (U.S. CLS. 100, 103 AND 106). REG. 9-17-1996.
- 2,001,425. SCROLL. INT. CL. 40. (U.S. CLS. 100, 103 AND 106). REG. 9-17-1996.
- 2,002,076. WELLPOINT PHARMACY MANAGEMENT. INT. CL. 35. (U.S. CL. 101). REG. 9-24-1996.
- 2,002,086. PRACTICAL HOMICIDE INVESTIGATION. INT. CL. 41. (U.S. CLS. 100, 101 AND 107). REG. 9-24-1996.
- 2,002,116. AUTOMATIC CLAIMS FILING PLUS. INT. CL. 36. (U.S. CLS. 100, 101 AND 102). REG. 9-24-1996.
- 2,002,344. KAMINOMOTO AND DESIGN. INT. CL. 3. (U.S. CLS. 1, 4, 6, 50, 51 AND 52). REG. 9-24-1996.
- 2,002,373. HAI AND DESIGN. INT. CL. 9. (U.S. CLS. 21, 23, 26, 36 AND 38). REG. 9-24-1996.
- 2,002,467. MECHLINE AND DESIGN. INT. CL. 11. (U.S. CLS. 13, 21, 23, 31 AND 34). REG. 9-24-1996.
- 2,002,491. MISCELLANEOUS DESIGN. INT. CLS. 5, 11, 24 AND 42. (U.S. CLS. 6, 13, 18, 21, 23, 31, 34, 42, 44, 46, 50, 51, 52, 100 AND 101). REG. 9-24-1996.
- 2,002,505. BOOKS ON DEMAND. INT. CL. 40. (U.S. CLS. 100, 103 AND 106). REG. 9-24-1996.
- 2,002,613. NATURVET. INT. CLS. 3 AND 5. (U.S. CLS. 1, 4, 6, 18, 44, 46, 50, 51 AND 52). REG. 9-24-1996.
- 2,002,652. MIHO (STYLIZED). INT. CL. 3. (U.S. CLS. 1, 4, 6, 50, 51 AND 52). REG. 9-24-1996.
- 2,002,654. OLD PLANTATION. INT. CL. 30. (U.S. CL. 46). REG. 9-24-1996.
- 2,002,728. VIANNE LANTERN. INT. CL. 11. (U.S. CLS. 13, 21, 23, 31 AND 34). REG. 9-24-1996.
- 2,002,843. ENERGY SENTRY. INT. CL. 9. (U.S. CLS. 21, 23, 26, 36 AND 38). REG. 9-24-1996.
- 2,002,960. SHIPPERPLUS. INT. CL. 9. (U.S. CLS. 21, 23, 26, 36 AND 38). REG. 9-24-1996.
- 2,002,973. MISCELLANEOUS DESIGN. INT. CL. 28. (U.S. CLS. 22, 23, 38 AND 50). REG. 9-24-1996.
- 2,002,996. PROPHECY. INT. CL. 9. (U.S. CLS. 21, 23, 26, 36 AND 38). REG. 9-24-1996.
- 2,003,036. EXISS. INT. CL. 12. (U.S. CLS. 19, 21, 23, 31, 35 AND 44). REG. 9-24-1996.
- 2,003,348. EDEN LANE. INT. CL. 42. (U.S. CLS. 100 AND 101). REG. 9-24-1996.
- 2,003,591. QWIK-BOLT. INT. CL. 6. (U.S. CLS. 2, 12, 13, 14, 23, 25 AND 50). REG. 9-24-1996.
- 2,003,617. ECOFORM. INT. CL. 19. (U.S. CLS. 1, 12, 33 AND 50). REG. 9-24-1996.
- 2,003,722. RESPONSECALL. INT. CLS. 16 AND 35. (U.S. CLS. 2, 5, 22, 23, 29, 37, 38, 50, 100, 101 AND 102). REG. 9-24-1996.
- 2,003,913. POWER LUBRICANTS. INT. CL. 4. (U.S. CLS. 1, 6 AND 15). REG. 10-1-1996.
- 2,004,406. MISSILE COMMAND. INT. CL. 28. (U.S. CLS. 22, 23, 38 AND 50). REG. 10-1-1996.
- 2,004,525. SELECTA. INT. CL. 8. (U.S. CLS. 23, 28 AND 44). REG. 10-1-1996.
- 2,004,909. THE STOCK MARKET. INT. CL. 42. (U.S. CLS. 100 AND 101). REG. 10-1-1996.
- 2,005,194. ROMANTIC HOMES. INT. CL. 16. (U.S. CLS. 2, 5, 22, 23, 29, 37, 38 AND 50). REG. 10-1-1996.
- 2,005,280. J. RAY MCDERMOTT M AND DESIGN. INT. CL. 35. (U.S. CLS. 100, 101 AND 102). REG. 10-1-1996.
- 2,005,935. M & M'S AND DESIGN. INT. CL. 30. (U.S. CL. 46). REG. 10-8-1996.
- 2,006,170. STREET ICE. INT. CL. 2. (U.S. CLS. 6, 11 AND 16). REG. 10-8-1996.
- 2,006,257. HANDY JUICER. INT. CL. 7. (U.S. CLS. 13, 19, 21, 23, 31, 34 AND 35). REG. 10-8-1996.
- 2,006,278. DEBACTEROL. INT. CL. 5. (U.S. CLS. 6, 18, 44, 46, 51 AND 52). REG. 10-8-1996.
- 2,006,336. THE HOMEBIZ INSPECTION TEAM. INT. CL. 42. (U.S. CLS. 100 AND 101). REG. 10-8-1996.
- 2,006,428. EAGLE COIN AND DESIGN. INT. CL. 29. (U.S. CL. 46). REG. 10-8-1996.
- 2,006,485. SOURCE. INT. CL. 1. (U.S. CLS. 1, 5, 6, 10, 26 AND 46). REG. 10-8-1996.
- 2,006,553. PERSONAL TOUCHES. INT. CL. 19. (U.S. CLS. 1, 12, 33 AND 50). REG. 10-8-1996.
- 2,006,591. CIRQUE DU SOLEIL. INT. CL. 9. (U.S. CLS. 21, 23, 26, 36 AND 38). REG. 10-8-1996.
- 2,006,845. CLARION. INT. CL. 4. (U.S. CLS. 1, 6 AND 15). REG. 10-8-1996.
- 2,007,626. METALOY. INT. CL. 36. (U.S. CLS. 100, 101 AND 102). REG. 10-15-1996.
- 2,007,780. COX COMMUNICATIONS (STYLIZED). INT. CLS. 38 AND 41. (U.S. CLS. 100, 101, 104 AND 107). REG. 10-15-1996.
- 2,008,521. ALLMED. INT. CLS. 24 AND 25. (U.S. CLS. 22, 39, 42 AND 50). REG. 10-15-1996.
- 2,008,812. CINN-A-QUICK. INT. CL. 30. (U.S. CL. 46). REG. 10-15-1996.
- 2,008,936. LASAR AND DESIGN. INT. CL. 7. (U.S. CLS. 13, 19, 21, 23, 31, 34 AND 35). REG. 10-15-1996.
- 2,009,089. CALORMATIC. INT. CL. 7. (U.S. CLS. 13, 19, 21, 23, 31, 34 AND 35). REG. 10-15-1996.
- 2,009,197. MARIGOLD (STYLIZED). INT. CL. 3. (U.S. CLS. 1, 4, 6, 50, 51 AND 52). REG. 10-15-1996.
- 2,009,577. SAIL CARIBBEAN. INT. CLS. 25 AND 39. (U.S. CLS. 22, 39, 100 AND 105). REG. 10-22-1996.
- 2,009,718. TREK & TRAIL AND DESIGN. INT. CLS. 39, 41 AND 42. (U.S. CLS. 100, 101, 105 AND 107). REG. 10-22-1996.
- 2,009,883. LINDY'S. INT. CL. 30. (U.S. CL. 46). REG. 10-22-1996.
- 2,010,566. PROACTION. INT. CL. 12. (U.S. CLS. 19, 21, 23, 31, 35 AND 44). REG. 10-22-1996.
- 2,010,708. E-MANUAL (STYLIZED). INT. CL. 9. (U.S. CLS. 21, 23, 26, 36 AND 38). REG. 10-22-1996.
- 2,010,856. ATLANTA HAWKS AND DESIGN. INT. CL. 41. (U.S. CLS. 100, 101 AND 107). REG. 10-22-1996.
- 2,010,857. ATLANTA HAWKS AND DESIGN. INT. CL. 25. (U.S. CLS. 22 AND 39). REG. 10-22-1996.
- 2,011,082. M. J. RAY MCDERMOTT AND DESIGN. INT. CL. 37. (U.S. CLS. 100, 103 AND 106). REG. 10-22-1996.

- 2,011,306. AROMA SPA. INT. CLS. 10 AND 11. (U.S. CLS. 13, 21, 23, 26, 31, 34, 39 AND 44). REG. 10-29-1996.
- 2,011,466. CYPRESS CORPORATE CENTER. INT. CL. 36 ONLY. (U.S. CLS. 100, 101 AND 102). REG. 10-29-1996.
- 2,011,542. MIRACLEBODY. INT. CL. 25. (U.S. CLS. 22 AND 39). REG. 10-29-1996.
- 2,011,826. DOVE PROMISES. INT. CL. 30. (U.S. CL. 46). REG. 10-29-1996.
- 2,012,483. SOF-MATT. INT. CL. 10. (U.S. CLS. 26, 39 AND 44). REG. 10-29-1996.
- 2,012,710. RUMPLEFOLK 9 10 11 12 1 2 3 AND DESIGN. INT. CL. 28. (U.S. CLS. 22, 23, 38 AND 50). REG. 10-29-1996.
- 2,013,159. BRIARGATE MEDIA. INT. CL. 35. (U.S. CLS. 100, 101 AND 102). REG. 11-5-1996.
- 2,013,332. WAW WINNING AT WORK AND DESIGN. INT. CL. 41. (U.S. CLS. 100, 101 AND 107). REG. 11-5-1996.
- 2,013,404. DIAMOND EXPRESS. INT. CL. 42. (U.S. CLS. 100 AND 101). REG. 11-5-1996.
- 2,013,871. MISCELLANEOUS DESIGN. INT. CL. 25. (U.S. CLS. 22 AND 39). REG. 11-5-1996.
- 2,014,150. RUDOLF LADERACH LADERACH CHOCOLATIER SUISSE AND DESIGN. INT. CL. 30. (U.S. CL. 46). REG. 11-5-1996.
- 2,014,934. GREEN MOUNTAIN. INT. CL. 13. (U.S. CLS. 2 AND 9). REG. 11-12-1996.
- 2,014,951. VODAVI AND DESIGN. INT. CL. 9. (U.S. CLS. 21, 23, 26, 36 AND 38). REG. 11-12-1996.
- 2,015,196. GENURA. INT. CL. 11. (U.S. CLS. 13, 21, 23, 31 AND 34). REG. 11-12-1996.
- 2,016,230. T TOUCH AND DESIGN. INT. CLS. 9, 16, 18, 31 AND 41 ONLY. (U.S. CLS. 1, 2, 3, 5, 21, 22, 23, 26, 29, 36, 37, 38, 41, 46, 50, 100, 101 AND 107). REG. 11-12-1996.
- 2,016,896. 1 DAY DENTURE SERVICE AND DESIGN. INT. CL. 37. (U.S. CLS. 100, 103 AND 106). REG. 11-19-1996.
- 2,017,080. BRENTHAVEN. INT. CLS. 9 AND 18. (U.S. CLS. 1, 2, 3, 21, 22, 23, 26, 36, 38 AND 41). REG. 11-19-1996.
- 2,017,251. ATHEY. INT. CL. 7. (U.S. CLS. 13, 19, 21, 23, 31, 34 AND 35). REG. 11-19-1996.
- 2,017,266. JUGS AND DESIGN. INT. CLS. 9, 25 AND 28. (U.S. CLS. 21, 22, 23, 26, 36, 38, 39 AND 50). REG. 11-19-1996.
- 2,018,047. TERRA D'ORO. INT. CL. 33. (U.S. CLS. 47 AND 49). REG. 11-19-1996.
- 2,018,698. NOTHING GETS LOST IN THE TRANSLATION. INT. CL. 42. (U.S. CLS. 100 AND 101). REG. 11-26-1996.
- 2,019,791. AARDVARK EYEWEAR AND DESIGN. INT. CL. 42. (U.S. CLS. 100 AND 101). REG. 11-26-1996.
- 2,019,836. CASUAL DAY. INT. CL. 25. (U.S. CLS. 22 AND 39). REG. 11-26-1996.
- 2,020,541. SCROLL. INT. CL. 24. (U.S. CLS. 42 AND 50). REG. 12-3-1996.
- 2,020,622. CHAMPION. INT. CL. 7. (U.S. CLS. 13, 19, 21, 23, 31, 34 AND 35). REG. 12-3-1996.
- 2,020,948. MANDOGUITAR. INT. CL. 15. (U.S. CLS. 2, 21 AND 36). REG. 12-3-1996.
- 2,021,211. HI POINT. INT. CL. 24. (U.S. CLS. 42 AND 50). REG. 12-3-1996.
- 2,021,369. SUGAR QUEEN. INT. CL. 31. (U.S. CLS. 1 AND 46). REG. 12-3-1996.
- 2,021,883. E.R. BRADLEY'S SALOON. INT. CL. 42. (U.S. CLS. 100 AND 101). REG. 12-10-1996.
- 2,021,996. SONOSCAN. INT. CLS. 41 AND 42. (U.S. CLS. 100, 101 AND 107). REG. 12-10-1996.
- 2,022,116. MISCELLANEOUS DESIGN. INT. CL. 9. (U.S. CLS. 21, 23, 26, 36 AND 38). REG. 12-10-1996.
- 2,023,482. ERO AND DESIGN. INT. CL. 9. (U.S. CLS. 21, 23, 26, 36 AND 38). REG. 12-17-1996.
- 2,023,711. RILEY'S (STYLIZED). INT. CL. 16. (U.S. CLS. 2, 5, 22, 23, 29, 37, 38 AND 50). REG. 12-17-1996.
- 2,023,979. WOODARD WEAVE. INT. CL. 27. (U.S. CLS. 19, 20, 37, 42 AND 50). REG. 12-17-1996.
- 2,024,253. ZYRTEC. INT. CL. 5. (U.S. CLS. 6, 18, 44, 46, 51 AND 52). REG. 12-17-1996.
- 2,024,388. CRYPTO-BOX. INT. CL. 9. (U.S. CLS. 21, 23, 26, 36 AND 38). REG. 12-17-1996.
- 2,024,472. TALON AND DESIGN. INT. CL. 7. (U.S. CLS. 13, 19, 21, 23, 31, 34 AND 35). REG. 12-17-1996.
- 2,024,506. COLDCARE. INT. CL. 16. (U.S. CLS. 2, 5, 22, 23, 29, 37, 38 AND 50). REG. 12-17-1996.
- 2,026,077. DE-TICKER. INT. CL. 10. (U.S. CLS. 26, 39 AND 44). REG. 12-24-1996.
- 2,026,507. NIKI (STYLIZED). INT. CL. 29. (U.S. CL. 46). REG. 12-31-1996.
- 2,026,548. BLACK DIAMOND BREWING COMPANY AND DESIGN. INT. CL. 42. (U.S. CLS. 100 AND 101). REG. 12-31-1996.
- 2,026,958. PYROPLATE. INT. CL. 9. (U.S. CLS. 21, 23, 26, 36 AND 38). REG. 12-31-1996.
- 2,027,707. 3V CAPS. INT. CL. 5. (U.S. CLS. 6, 18, 44, 46, 51 AND 52). REG. 12-31-1996.
- 2,027,796. CHEMSURE. INT. CL. 39 ONLY. (U.S. CLS. 100 AND 105 ONLY). REG. 12-31-1996.
- 2,028,924. MISCELLANEOUS DESIGN. INT. CL. 10. (U.S. CLS. 26, 39 AND 44). REG. 1-7-1997.
- 2,028,928. DONNA VINCI AND DESIGN. INT. CL. 25. (U.S. CLS. 22 AND 39). REG. 1-7-1997.
- 2,029,445. OSCAR NIGHT. INT. CL. 41. (U.S. CL. 107). REG. 1-14-1997.
- 2,029,603. TOUCAN SAM. INT. CL. 25. (U.S. CLS. 22 AND 39). REG. 1-14-1997.
- 2,030,795. OLD EUROPEAN BREWERY COMPANY. INT. CL. 32. (U.S. CLS. 45, 46 AND 48). REG. 1-14-1997.
- 2,030,831. OMNICEF. INT. CL. 5. (U.S. CLS. 6, 18, 44, 46, 51 AND 52). REG. 1-14-1997.
- 2,031,513. GET A GRIP AND DESIGN. INT. CL. 8. (U.S. CLS. 23, 28 AND 44). REG. 1-21-1997.
- 2,032,584. O2XYGEN (STYLIZED). INT. CL. 3. (U.S. CLS. 1, 4, 6, 50, 51 AND 52). REG. 1-21-1997.
- 2,033,315. WEBWORKS. INT. CL. 9. (U.S. CLS. 21, 23, 26, 36 AND 38). REG. 1-28-1997.
- 2,033,341. KIDS VOTING. INT. CL. 42. (U.S. CLS. 100 AND 101). REG. 1-28-1997.
- 2,034,509. CAM-TITE. INT. CL. 6. (U.S. CLS. 2, 12, 13, 14, 23, 25 AND 50). REG. 1-28-1997.
- 2,034,585. TECHNIQUE POUR HOMME. INT. CL. 3. (U.S. CLS. 1, 4, 6, 50, 51 AND 52). REG. 1-28-1997.
- 2,035,259. MY POOL PAL AND DESIGN. INT. CL. 25. (U.S. CLS. 22 AND 39). REG. 2-4-1997.
- 2,035,369. WHIRLAWAY. INT. CL. 3. (U.S. CLS. 1, 4, 6, 50, 51 AND 52). REG. 2-4-1997.
- 2,035,984. REMINGTON (STYLIZED). INT. CL. 3. (U.S. CLS. 1, 4, 6, 50, 51 AND 52). REG. 2-4-1997.
- 2,036,573. AAI A SUBSIDIARY OF UNITED INDUSTRIAL CORPORATION AND DESIGN. INT. CL. 9. (U.S. CLS. 21, 23, 26, 36 AND 38). REG. 2-11-1997.
- 2,037,281. LIFE'S A PARTY AND WE'RE CATERING IT. INT. CL. 42. (U.S. CLS. 100 AND 101). REG. 2-11-1997.
- 2,037,696. ZEPHYR. INT. CL. 9. (U.S. CLS. 21, 23, 26, 36 AND 38). REG. 2-11-1997.
- 2,037,719. QWICK KURB. INT. CL. 9. (U.S. CLS. 21, 23, 26, 36 AND 38). REG. 2-11-1997.
- 2,038,132. LA MARZOCCO. INT. CL. 11. (U.S. CLS. 13, 21, 23, 31 AND 34). REG. 2-18-1997.
- 2,040,247. MID-WEST STEEL BUILDING COMPANY. INT. CL. 42. (U.S. CLS. 100 AND 101). REG. 2-25-1997.
- 2,041,776. SONOSCAN. INT. CL. 9. (U.S. CLS. 21, 23, 26, 36 AND 38). REG. 3-4-1997.
- 2,041,954. HIGH RIDER. INT. CL. 7. (U.S. CLS. 13, 19, 21, 23, 31, 34 AND 35). REG. 3-4-1997.
- 2,042,766. SANDWICH SLICERS. INT. CL. 29. (U.S. CL. 46). REG. 3-11-1997.
- 2,043,085. C-SAM. INT. CL. 9. (U.S. CLS. 21, 23, 26, 36 AND 38). REG. 3-11-1997.
- 2,043,645. STOP & GLO. INT. CL. 1. (U.S. CLS. 1, 5, 6, 10, 26 AND 46). REG. 3-11-1997.
- 2,044,230. BORDERS. INT. CL. 38. (U.S. CLS. 100, 101 AND 104). REG. 3-11-1997.
- 2,044,703. HEART OF THE RAG. INT. CL. 21. (U.S. CLS. 2, 13, 23, 29, 30, 33, 40 AND 50). REG. 3-11-1997.
- 2,044,904. THE PEOPLE WHO MEASURE SUCCESS. INT. CL. 42 ONLY. (U.S. CLS. 100 AND 101). REG. 3-11-1997.
- 2,046,550. COLOSSAL CRUNCH. INT. CL. 30. (U.S. CL. 46). REG. 3-18-1997.
- 2,047,006. BIKE BASH. INT. CL. 41. (U.S. CLS. 100, 101 AND 107). REG. 3-25-1997.
- 2,048,243. SUN-J. INT. CL. 14. (U.S. CLS. 2, 27, 28 AND 50). REG. 3-25-1997.
- 2,049,528. HANDY-WALL. INT. CL. 19. (U.S. CLS. 1, 12, 33 AND 50). REG. 4-1-1997.

- 2,050,003. MELATONIN EXTRA. INT. CL. 5. (U.S. CLS. 6, 18, 44, 46, 51 AND 52). REG. 4-1-1997.
- 2,050,493. SOFTELEC AND DESIGN. INT. CL. 9. (U.S. CLS. 21, 23, 26, 36 AND 38). REG. 4-8-1997.
- 2,050,733. BIMBA AND DESIGN. INT. CL. 7. (U.S. CLS. 13, 19, 21, 23, 31, 34 AND 35). REG. 4-8-1997.
- 2,050,942. ACCESS. INT. CL. 10. (U.S. CLS. 26, 39 AND 44). REG. 4-8-1997.
- 2,051,017. OUR STOCK IS ALWAYS UP. INT. CL. 42. (U.S. CLS. 100 AND 101). REG. 4-8-1997.
- 2,053,861. HOLLYWOOD TRIMS AND DESIGN. INT. CLS. 23 AND 26. (U.S. CLS. 37, 39, 40, 42, 43 AND 50). REG. 4-22-1997.
- 2,055,583. VPLITE (STYLIZED). INT. CL. 9. (U.S. CLS. 21, 23, 26, 36 AND 38). REG. 4-22-1997.
- 2,057,269. COURTSTOR (STYLIZED). INT. CL. 9. (U.S. CLS. 21, 23, 26, 36 AND 38). REG. 4-29-1997.
- 2,057,883. ONELINERS. INT. CL. 16. (U.S. CLS. 2, 5, 22, 23, 29, 37, 38 AND 50). REG. 4-29-1997.
- 2,058,525. ALPHA AND DESIGN. INT. CLS. 8, 9, 11, 17 AND 20. (U.S. CLS. 2, 5, 12, 13, 21, 22, 23, 25, 31, 32, 34 AND 50). REG. 5-6-1997.
- 2,058,673. BRAHMA AND DESIGN. INT. CL. 7. (U.S. CLS. 13, 19, 21, 23, 31, 34 AND 35). REG. 5-6-1997.
- 2,059,780. BREAKFAST ZONE. INT. CL. 30. (U.S. CL. 46). REG. 5-6-1997.
- 2,060,794. CONTROLS INTERNATIONAL, INC.. INT. CL. 9. (U.S. CLS. 21, 23, 26, 36 AND 38). REG. 5-13-1997.
- 2,060,795. MISCELLANEOUS DESIGN. INT. CL. 9. (U.S. CLS. 21, 23, 26, 36 AND 38). REG. 5-13-1997.
- 2,061,444. SUNSHINE HORIZONS. INT. CL. 16. (U.S. CLS. 2, 5, 22, 23, 29, 37, 38 AND 50). REG. 5-13-1997.
- 2,061,487. LPZ. INT. CL. 7. (U.S. CLS. 13, 19, 21, 23, 31, 34 AND 35). REG. 5-13-1997.
- 2,063,701. COMVAX. INT. CL. 5. (U.S. CLS. 6, 18, 44, 46, 51 AND 52). REG. 5-20-1997.
- 2,064,854. KITAZAWA (STYLIZED). INT. CLS. 6 AND 7. (U.S. CLS. 2, 12, 13, 14, 19, 21, 23, 25, 31, 34, 35 AND 50). REG. 5-27-1997.
- 2,066,221. GENSLER INFORMATION SOLUTIONS. INT. CL. 9. (U.S. CLS. 21, 23, 26, 36 AND 38). REG. 6-3-1997.
- 2,066,886. AGRI-CREM. INT. CL. 29. (U.S. CL. 46). REG. 6-3-1997.
- 2,067,084. LEWISTON AND DESIGN. INT. CL. 34. (U.S. CLS. 2, 8, 9 AND 17). REG. 6-3-1997.
- 2,068,730. AGOURON. INT. CL. 5. (U.S. CLS. 6, 18, 44, 46, 51 AND 52). REG. 6-10-1997.
- 2,069,143. NATIONAL SPEAKERS BUREAU. INT. CL. 35. (U.S. CLS. 100, 101 AND 102). REG. 6-10-1997.
- 2,069,764. TECH PACK. INT. CL. 1. (U.S. CLS. 1, 5, 6, 10, 26 AND 46). REG. 6-10-1997.
- 2,070,004. FIRSTPRO. INT. CL. 35. (U.S. CLS. 100, 101 AND 102). REG. 6-10-1997.
- 2,071,545. SUCCESS IS IN THE BAG. INT. CL. 30. (U.S. CL. 46). REG. 6-17-1997.
- 2,071,617. VALLEY PAKT. INT. CL. 29. (U.S. CL. 46). REG. 6-17-1997.
- 2,071,663. CLOVERDALE ECOLOGIC THE LOGICAL ENVIRONMENTAL CHOICE. AND DESIGN. INT. CL. 2. (U.S. CLS. 6, 11 AND 16). REG. 6-17-1997.
- 2,072,297. SANDWICH STUFFERS. INT. CL. 29. (U.S. CL. 46). REG. 6-17-1997.
- 2,072,917. SUPREMO. INT. CL. 29. (U.S. CL. 46). REG. 6-24-1997.
- 2,073,266. MISCELLANEOUS DESIGN. INT. CL. 5. (U.S. CLS. 6, 18, 44, 46, 51 AND 52). REG. 6-24-1997.
- 2,075,352. MEN FOR THE CURE. INT. CL. 41. (U.S. CLS. 100, 101 AND 107). REG. 7-1-1997.
- 2,076,829. SCHWAB MONEY FUNDS-SWEEP INVESTMENTS. INT. CL. 36. (U.S. CLS. 100, 101 AND 102). REG. 7-8-1997.
- 2,077,185. CORUS. INT. CL. 36. (U.S. CLS. 100, 101 AND 102). REG. 7-8-1997.
- 2,077,385. PASSPORT. INT. CL. 31. (U.S. CLS. 1 AND 46). REG. 7-8-1997.
- 2,078,154. ARCADE. INT. CL. 40. (U.S. CLS. 100, 103 AND 106). REG. 7-8-1997.
- 2,078,696. HARLAND. INT. CL. 16. (U.S. CLS. 2, 5, 22, 23, 29, 37, 38 AND 50). REG. 7-15-1997.
- 2,078,705. SCRUNCHY APPLE FLOATS. INT. CL. 30. (U.S. CL. 46). REG. 7-15-1997.
- 2,079,387. ORDINARY WOMEN WITH EXTRAORDINARY SPIRIT. INT. CL. 41. (U.S. CLS. 100, 101 AND 107). REG. 7-15-1997.
- 2,081,060. ENDLESS OPTIONS. INT. CL. 25. (U.S. CLS. 22 AND 39). REG. 7-22-1997.
- 2,081,087. FRIENDS FOR THE CURE. INT. CL. 41. (U.S. CLS. 100, 101 AND 107). REG. 7-22-1997.
- 2,081,257. FRANCIS MARION UNIVERSITY 1970 AND DESIGN. INT. CL. 41. (U.S. CLS. 100, 101 AND 107). REG. 7-22-1997.
- 2,081,546. TRIM & TERRIFIC. INT. CL. 16. (U.S. CLS. 2, 5, 22, 23, 29, 37, 38 AND 50). REG. 7-22-1997.
- 2,082,682. CELAYA. INT. CL. 30. (U.S. CL. 46). REG. 7-29-1997.
- 2,082,706. MISCELLANEOUS DESIGN. INT. CL. 17. (U.S. CLS. 1, 5, 12, 13, 35 AND 50). REG. 7-29-1997.
- 2,083,502. PANTHER'S RUN. INT. CL. 41. (U.S. CLS. 100, 101 AND 107). REG. 7-29-1997.
- 2,083,621. METROPOLITAN HOMES AND DESIGN. INT. CL. 37. (U.S. CLS. 100, 103 AND 106). REG. 7-29-1997.
- 2,084,494. SHAVER LAKE. INT. CLS. 18 AND 25. (U.S. CLS. 1, 2, 3, 22, 39 AND 41). REG. 7-29-1997.
- 2,084,626. FROGHIDE. INT. CL. 9. (U.S. CLS. 21, 23, 26, 36 AND 38). REG. 7-29-1997.
- 2,085,805. FUNCOLAND (STYLIZED). INT. CL. 35. (U.S. CLS. 100, 101 AND 102). REG. 8-5-1997.
- 2,085,960. POWER STROKER. INT. CL. 1. (U.S. CLS. 1, 5, 6, 10, 26 AND 46). REG. 8-5-1997.
- 2,086,357. EASY OUT ROLLER SEATS. INT. CL. 12. (U.S. CLS. 19, 21, 23, 31, 35 AND 44). REG. 8-5-1997.
- 2,087,845. VIBLON. INT. CL. 17. (U.S. CLS. 1, 5, 12, 13, 35 AND 50). REG. 8-12-1997.
- 2,088,545. MATCH.COM. INT. CL. 42. (U.S. CLS. 100 AND 101). REG. 8-19-1997.
- 2,089,173. AMERICANA. INT. CL. 31. (U.S. CLS. 1 AND 46). REG. 8-19-1997.
- 2,089,220. BOSCO. INT. CL. 30. (U.S. CL. 46). REG. 8-19-1997.

* * * * *

TRADEMARK REGISTRATIONS CANCELED

The designation "U.S. Cl." appearing in this section refers to the U.S. class in effect prior to Sep. 1, 1973 rather than the international class which applies to applications filed on or after that date. For adoption of international classification see notice in the OFFICIAL GAZETTE of Jun. 26, 1973 (911 O.G. TM 210).

SECTION 7(D)

- 825,043. POLISH CHERRY CORDIAL WISNIAK PRODUCED AND BOTTLED IN POLAND POLINOS AND DESIGN. U.S. CL. 49. REG. 2-28-1967.
- 1,933,109. IRRESISTIBLES. INT. CL. 14. REG. 11-7-1995.
- 1,998,507. CITYSAC. INT. CL. 18. REG. 9-3-1996.
- 2,332,840. KRYPTO. INT. CL. 6. REG. 3-21-2000.
- 2,371,617. ALIAS. INT. CL. 9. REG. 7-25-2000.
- 2,379,295. LIN PAC PACKAGING SOLUTIONS. INT. CL. 16. REG. 8-22-2000.
- 2,650,907. X AND DESIGN. INT. CLS. 25, 28 AND 35. REG. 11-19-2002.
- 2,909,325. INDO-AMERICAN BUSINESS PAGESSTANDARD CHARACTER MARK INT. CL. 16. REG. 12-7-2004.
- 2,955,861. INDO-AMERICAN BUSINESS PAGESSTANDARD CHARACTER MARK INT. CL. 35. REG. 5-24-2005.
- 3,116,387. MICHIGAN'S MOST TRUSTED NAME IN HEALTHCARE STANDARD CHARACTER MARK INT. CL. 44. REG. 7-18-2006.
- 1,377,833. TENNGASCO. INT. CLS. 4 AND 39. REG. 1-14-1986.
- 1,377,844. LYMORACT. INT. CL. 5. REG. 1-14-1986.
- 1,377,853. TEL-E-VIAL. INT. CL. 5. REG. 1-14-1986.
- 1,377,856. TEL-E-AMP. INT. CL. 5. REG. 1-14-1986.
- 1,377,858. OPTIDERM. INT. CL. 5. REG. 1-14-1986.
- 1,377,863. ORION. INT. CL. 5. REG. 1-14-1986.
- 1,377,867. ANANXYL. INT. CL. 5. REG. 1-14-1986.
- 1,377,868. MARBACH MG MATIC. INT. CLS. 6 AND 7. REG. 1-14-1986.
- 1,377,872. TOWN & COUNTRY. INT. CL. 6. REG. 1-14-1986.
- 1,377,874. ULTRA-PACK. INT. CL. 6. REG. 1-14-1986.
- 1,377,876. VASCOMAX T-200. INT. CL. 6. REG. 1-14-1986.
- 1,377,877. VASCOMAX T-300. INT. CL. 6. REG. 1-14-1986.
- 1,377,883. C-SQUARE. INT. CL. 7. REG. 1-14-1986.
- 1,377,885. VACUMAT. INT. CL. 7. REG. 1-14-1986.
- 1,377,888. BIG CAM. INT. CL. 7. REG. 1-14-1986.
- 1,377,891. MICROJECTOR. INT. CL. 7. REG. 1-14-1986.
- 1,377,892. GYRO-VORTEX. INT. CL. 7. REG. 1-14-1986.
- 1,377,896. HEXA. INT. CL. 7. REG. 1-14-1986.
- 1,377,898. VOONER FLO. INT. CL. 7. REG. 1-14-1986.
- 1,377,903. THE STEEL COBRA. INT. CL. 8. REG. 1-14-1986.
- 1,377,904. KIYOGA. INT. CL. 8. REG. 1-14-1986.
- 1,377,913. SALON DESIGNS (STYLIZED). INT. CLS. 9 AND 11. REG. 1-14-1986.
- 1,377,915. MISCELLANEOUS DESIGN. INT. CL. 9. REG. 1-14-1986.
- 1,377,922. TELECLERK. INT. CL. 9. REG. 1-14-1986.
- 1,377,923. G (STYLIZED). INT. CLS. 9 AND 12. REG. 1-14-1986.
- 1,377,927. DATA SHIELD. INT. CL. 9. REG. 1-14-1986.
- 1,377,936. GASCOIL. INT. CLS. 9 AND 17. REG. 1-14-1986.
- 1,377,945. SELF TUNE AND DESIGN. INT. CL. 9. REG. 1-14-1986.
- 1,377,946. THE ENERGY SEQUENTIAL. INT. CL. 9. REG. 1-14-1986.
- 1,377,950. CANOVISION. INT. CL. 9. REG. 1-14-1986.
- 1,377,957. BANKRITE. INT. CL. 9. REG. 1-14-1986.
- 1,377,966. ORCHID. INT. CL. 9. REG. 1-14-1986.
- 1,377,970. HSI/CODER. INT. CL. 9. REG. 1-14-1986.
- 1,377,972. PACEMAKER AND DESIGN. INT. CL. 9. REG. 1-14-1986.
- 1,377,983. VERSIDL. INT. CL. 9. REG. 1-14-1986.
- 1,377,986. SCORBOX. INT. CL. 9. REG. 1-14-1986.
- 1,377,988. OKIFONT. INT. CL. 9. REG. 1-14-1986.
- 1,377,989. ESCROW EXEC. INT. CL. 9. REG. 1-14-1986.
- 1,377,993. MOBILIMB. INT. CL. 10. REG. 1-14-1986.
- 1,377,994. DALE ACTIVE LIFE. INT. CL. 10. REG. 1-14-1986.
- 1,377,996. NEPHROSS. INT. CL. 10. REG. 1-14-1986.
- 1,377,999. JOHNSON & JOHNSON AND DESIGN. INT. CL. 10. REG. 1-14-1986.
- 1,378,014. BIG CAM. INT. CL. 12. REG. 1-14-1986.
- 1,378,016. ELYSEE. INT. CL. 12. REG. 1-14-1986.
- 1,378,022. NICROCRAFT. INT. CL. 12. REG. 1-14-1986.
- 1,378,024. SC II. INT. CL. 12. REG. 1-14-1986.
- 1,378,026. XL PRO. INT. CL. 12. REG. 1-14-1986.
- 1,378,027. A LA CART (STYLIZED). INT. CL. 12. REG. 1-14-1986.
- 1,378,034. BON JOUR. INT. CLS. 14, 18 AND 25. REG. 1-14-1986.
- 1,378,036. PARAGON DIAMOND CO.. INT. CL. 14. REG. 1-14-1986.
- 1,378,037. IVORINA. INT. CL. 14. REG. 1-14-1986.

SECTION 8

- 48,928. MISCELLANEOUS DESIGN. U.S. CL. 23. REG. 1-16-1906.
- 802,463. IL MIGLIORE AND DESIGN. U.S. CL. 46. REG. 1-18-1966.
- 814,995. BARBIE. U.S. CL. 37. ONLY. REG. 9-13-1966.
- 1,023,313. BUNS. INT. CL. 25. REG. 10-21-1975.
- 1,364,823. CORBETT CANYON. INT. CL. 33. REG. 10-8-1985.
- 1,365,278. MC2 (STYLIZED). INT. CLS. 35 AND 42 ONLY. REG. 10-15-1985.
- 1,377,751. ENCO AND DESIGN. INT. CLS. 1 AND 9. REG. 1-14-1986.
- 1,377,758. POLYWOOD. INT. CL. 1. REG. 1-14-1986.
- 1,377,766. LIPOLINE. INT. CL. 1. REG. 1-14-1986.
- 1,377,767. P-500. INT. CL. 1. REG. 1-14-1986.
- 1,377,769. TANBASE. INT. CL. 1. REG. 1-14-1986.
- 1,377,774. TM - 97. INT. CL. 1. REG. 1-14-1986.
- 1,377,776. REPROLITE. INT. CL. 1. REG. 1-14-1986.
- 1,377,779. ORION. INT. CL. 1. REG. 1-14-1986.
- 1,377,784. TRU-FLEX AND DESIGN. INT. CL. 2. REG. 1-14-1986.
- 1,377,789. FOREVER KRYSTLE. INT. CL. 3. REG. 1-14-1986.
- 1,377,793. RESTORE. INT. CL. 3. REG. 1-14-1986.
- 1,377,794. QUICK DIP. INT. CL. 3. REG. 1-14-1986.
- 1,377,795. LOVE TOUCH. INT. CL. 3. REG. 1-14-1986.
- 1,377,796. CAMOMILD. INT. CL. 3. REG. 1-14-1986.
- 1,377,802. AE. INT. CL. 3. REG. 1-14-1986.
- 1,377,809. AMIREE. INT. CL. 3. REG. 1-14-1986.
- 1,377,814. MISCELLANEOUS DESIGN. INT. CL. 3. REG. 1-14-1986.
- 1,377,815. QUE SAIS-JE?. INT. CL. 3. REG. 1-14-1986.
- 1,377,816. COLONY. INT. CL. 3. REG. 1-14-1986.
- 1,377,821. COSMETIC ARTS. INT. CL. 3. REG. 1-14-1986.

- 1,378,038. FEDRA DESIGNS. AND DESIGN. INT. CL. 14. REG. 1-14-1986.
- 1,378,043. THE PEARL GAME. INT. CL. 14. REG. 1-14-1986.
- 1,378,054. RIFT. INT. CL. 16. REG. 1-14-1986.
- 1,378,057. SOURCE ONE (STYLIZED). INT. CL. 16. REG. 1-14-1986.
- 1,378,067. EUROCARE. INT. CL. 16. REG. 1-14-1986.
- 1,378,074. EZ-LABEL. INT. CL. 16. REG. 1-14-1986.
- 1,378,076. AMERICAN SOCIOLOGICAL REVIEW. INT. CL. 16. REG. 1-14-1986.
- 1,378,081. TAURUSGRAM. INT. CL. 16. REG. 1-14-1986.
- 1,378,088. BLIZSKIN. INT. CL. 17. REG. 1-14-1986.
- 1,378,091. RACING TAPE 200 MPH AND DESIGN. INT. CL. 17. REG. 1-14-1986.
- 1,378,092. TUF-BLEND. INT. CL. 17. REG. 1-14-1986.
- 1,378,094. QIK-PRO. INT. CL. 17. REG. 1-14-1986.
- 1,378,095. Z2. INT. CL. 17. REG. 1-14-1986.
- 1,378,096. Z1. INT. CL. 17. REG. 1-14-1986.
- 1,378,097. TRILON. INT. CL. 17. REG. 1-14-1986.
- 1,378,099. MAUI SURF CLUB AND DESIGN. INT. CL. 18. REG. 1-14-1986.
- 1,378,100. FRANCO VISCONTI AND DESIGN. INT. CLS. 18 AND 25. REG. 1-14-1986.
- 1,378,103. CONTEMPO. INT. CL. 18. REG. 1-14-1986.
- 1,378,110. JACQUELINE FERRAR (STYLIZED). INT. CL. 18. REG. 1-14-1986.
- 1,378,111. MICHAEL SCOTT. INT. CL. 18. REG. 1-14-1986.
- 1,378,132. PENTAFEEDER. INT. CL. 21. REG. 1-14-1986.
- 1,378,137. HELPMATE 3000. INT. CL. 22. REG. 1-14-1986.
- 1,378,138. NOLE DANS VILLAGE (STYLIZED). INT. CL. 23. REG. 1-14-1986.
- 1,378,140. DIE SCHLAFENDE GANS THE SLEEPING GOOSE AND DESIGN. INT. CL. 24. REG. 1-14-1986.
- 1,378,141. MISCELLANEOUS DESIGN. INT. CLS. 24 AND 25. REG. 1-14-1986.
- 1,378,142. THE FROG POND AND DESIGN. INT. CLS. 24 AND 25. REG. 1-14-1986.
- 1,378,145. INSPORT (STYLIZED). INT. CL. 24. REG. 1-14-1986.
- 1,378,149. WRIGLEY'S SPEARMINT AND DESIGN. INT. CL. 24. REG. 1-14-1986.
- 1,378,152. THE EDINBURGH WOOLLEN MILL. INT. CL. 25. REG. 1-14-1986.
- 1,378,153. ROLLINA. INT. CL. 25. REG. 1-14-1986.
- 1,378,154. POMPADOUR AND DESIGN. INT. CL. 25. REG. 1-14-1986.
- 1,378,155. CRICKET CLUB. INT. CL. 25. REG. 1-14-1986.
- 1,378,170. PENNSYLVANIA DUTCH TWEED. INT. CL. 25. REG. 1-14-1986.
- 1,378,173. H HAMILTON (STYLIZED). INT. CL. 25. REG. 1-14-1986.
- 1,378,179. TOUR TOUCH. INT. CL. 25. REG. 1-14-1986.
- 1,378,184. PIERRE FOLLENFANT AND DESIGN. INT. CL. 25. REG. 1-14-1986.
- 1,378,195. FROSTLINE AND DESIGN. INT. CL. 25. REG. 1-14-1986.
- 1,378,199. TOOTSIE ROLL TR AND DESIGN. INT. CL. 25. REG. 1-14-1986.
- 1,378,206. RIO BY STEPHEN MARDON. INT. CL. 25. REG. 1-14-1986.
- 1,378,209. KARIN MORGAN (STYLIZED). INT. CL. 25. REG. 1-14-1986.
- 1,378,221. BDP. INT. CL. 25. REG. 1-14-1986.
- 1,378,223. HEIR A'PARENT (STYLIZED). INT. CL. 25. REG. 1-14-1986.
- 1,378,224. H2NO PLUS (STYLIZED). INT. CL. 25. REG. 1-14-1986.
- 1,378,229. HARD TO REMEMBER...STEINWURTZEL STEINWURTZEL STEINWURTZEL EVEN HARDER TO FORGET! AND DESIGN. INT. CL. 25. REG. 1-14-1986.
- 1,378,238. OBION. INT. CL. 25. REG. 1-14-1986.
- 1,378,243. DONNA RICHARD. INT. CL. 25. REG. 1-14-1986.
- 1,378,244. DAVID. INT. CL. 25. REG. 1-14-1986.
- 1,378,247. POLO RALPH LAUREN AND DESIGN. INT. CL. 25. REG. 1-14-1986.
- 1,378,251. KNIPPER. INT. CL. 26. REG. 1-14-1986.
- 1,378,261. CONGOLEUM (STYLIZED). INT. CL. 27. REG. 1-14-1986.
- 1,378,262. CUSHIONFLOR. INT. CL. 27. REG. 1-14-1986.
- 1,378,269. ULTRAFLEX. INT. CL. 28. REG. 1-14-1986.
- 1,378,274. TYCOON FIN-NOR RODS SINCE 1933 AND DESIGN. INT. CL. 28. REG. 1-14-1986.
- 1,378,279. PIG PEOPLE. INT. CL. 28. REG. 1-14-1986.
- 1,378,287. MR. MURL. INT. CL. 28. REG. 1-14-1986.
- 1,378,294. MEADOW FRESH. INT. CL. 29. REG. 1-14-1986.
- 1,378,297. BELCOVER. INT. CL. 29. REG. 1-14-1986.
- 1,378,298. LIKE. INT. CL. 29. REG. 1-14-1986.
- 1,378,304. STA-BLAND (STYLIZED). INT. CL. 29. REG. 1-14-1986.
- 1,378,306. SAVOIR FAIRE AND DESIGN. INT. CLS. 29, 30 AND 32. REG. 1-14-1986.
- 1,378,307. DAN FRESH. INT. CL. 29. REG. 1-14-1986.
- 1,378,308. TRUFAIRE. INT. CL. 29. REG. 1-14-1986.
- 1,378,320. BOYER AND DESIGN. INT. CL. 30. REG. 1-14-1986.
- 1,378,330. ORIENTAL TONIGHT. INT. CL. 30. REG. 1-14-1986.
- 1,378,331. GOLD N GOOD. INT. CL. 30. REG. 1-14-1986.
- 1,378,336. DOCKTORX AND DESIGN. INT. CL. 31. REG. 1-14-1986.
- 1,378,344. RMS. INT. CL. 33. REG. 1-14-1986.
- 1,378,347. OZONA PRESIDENT. INT. CL. 34. REG. 1-14-1986.
- 1,378,348. ALSBO (STYLIZED). INT. CL. 34. REG. 1-14-1986.
- 1,378,350. DIAMONDBACK. INT. CL. 34. REG. 1-14-1986.
- 1,378,353. M AND DESIGN. INT. CLS. 35, 39, 41 AND 42. REG. 1-14-1986.
- 1,378,355. HI 2. INT. CL. 35. REG. 1-14-1986.
- 1,378,363. CONVERTALEASE. INT. CLS. 35 AND 42. REG. 1-14-1986.
- 1,378,371. COACT. INT. CL. 35. REG. 1-14-1986.
- 1,378,372. BUMPER TO BUMPER AND DESIGN. INT. CL. 35. REG. 1-14-1986.
- 1,378,373. COMPUTERLAND LEARNING CENTER (STYLIZED). INT. CL. 35. REG. 1-14-1986.
- 1,378,378. S AND DESIGN. INT. CLS. 35 AND 36. REG. 1-14-1986.
- 1,378,379. LENDING VISION TO INFORMATION. INT. CL. 35. REG. 1-14-1986.
- 1,378,387. PATIENT SEARCHLIGHT. INT. CL. 35. REG. 1-14-1986.
- 1,378,389. AMICUS. INT. CL. 35. REG. 1-14-1986.
- 1,378,390. PEACHTREE CREEK. INT. CL. 35. REG. 1-14-1986.
- 1,378,397. PREFERRED HEALTH NETWORK AND DESIGN. INT. CL. 36. REG. 1-14-1986.
- 1,378,401. RESOURCE. INT. CL. 36. REG. 1-14-1986.
- 1,378,404. QUICK CHECK. INT. CL. 36. REG. 1-14-1986.
- 1,378,405. MISCELLANEOUS DESIGN. INT. CL. 36. REG. 1-14-1986.
- 1,378,406. MANUFACTURERS HANOVER MH AND DESIGN. INT. CL. 36. REG. 1-14-1986.
- 1,378,410. STEPS. INT. CL. 36. REG. 1-14-1986.
- 1,378,411. MISCELLANEOUS DESIGN. INT. CL. 36. REG. 1-14-1986.
- 1,378,415. GT (STYLIZED). INT. CL. 36. REG. 1-14-1986.
- 1,378,424. PRIVACY IN PARADISE. INT. CL. 36. REG. 1-14-1986.
- 1,378,427. MEYER CUSTOMS BROKERS INC. AND DESIGN. INT. CL. 36. REG. 1-14-1986.
- 1,378,429. MISCELLANEOUS DESIGN. INT. CL. 36. REG. 1-14-1986.
- 1,378,430. RONALD MCDONALD CHILDREN'S CHARITIES. INT. CL. 36. REG. 1-14-1986.
- 1,378,437. S & L (STYLIZED). INT. CLS. 37 AND 42. REG. 1-14-1986.
- 1,378,438. PLASTICARD PLUS. INT. CL. 37. REG. 1-14-1986.
- 1,378,440. MODERN AIR CONDITIONING, INC. AND DESIGN. INT. CL. 37. REG. 1-14-1986.
- 1,378,441. MODERN AND DESIGN. INT. CL. 37. REG. 1-14-1986.
- 1,378,442. SILENT-KOTE. INT. CL. 37. REG. 1-14-1986.
- 1,378,467. KBIG. INT. CL. 38. REG. 1-14-1986.
- 1,378,468. SAS AND DESIGN. INT. CL. 39. REG. 1-14-1986.

- 1,378,469. HOME LIGHT AND DESIGN. INT. CL. 39. REG. 1-14-1986.
- 1,378,478. CWM TRANSPORTATION. INT. CL. 39. REG. 1-14-1986.
- 1,378,480. E-BEAM AND DESIGN. INT. CL. 40. REG. 1-14-1986.
- 1,378,490. MS. SENIOR CITIZEN PAGEANT. INT. CL. 41. REG. 1-14-1986.
- 1,378,494. DINGBATS. INT. CL. 41. REG. 1-14-1986.
- 1,378,496. FITNESS FUN WITH RONALD MCDONALD. INT. CL. 41. REG. 1-14-1986.
- 1,378,497. BRINGING A CITY TO ITS FEET AND DESIGN. INT. CL. 41. REG. 1-14-1986.
- 1,378,498. BUILDING BLOCKS OF LEARNING AND DESIGN. INT. CLS. 41 AND 42. REG. 1-14-1986.
- 1,378,501. PCC. INT. CL. 41. REG. 1-14-1986.
- 1,378,502. ENHANCED COMMUNICATIONS, INC. (STYLIZED). INT. CL. 41. REG. 1-14-1986.
- 1,378,503. EC ENHANCED COMMUNICATIONS, INC. (STYLIZED). INT. CL. 41. REG. 1-14-1986.
- 1,378,504. PRO-KIDS SHOW. INT. CL. 41. REG. 1-14-1986.
- 1,378,506. THE THIRD AGE CENTER. INT. CLS. 41 AND 42. REG. 1-14-1986.
- 1,378,514. KNOTT'S SCARY FARM HALLOWEEN HAUNT AND DESIGN. INT. CL. 41. REG. 1-14-1986.
- 1,378,521. AMERICA'S MEAT 'N POTATOES. INT. CL. 42. REG. 1-14-1986.
- 1,378,523. MISCELLANEOUS DESIGN. INT. CL. 42. REG. 1-14-1986.
- 1,378,529. MISCELLANEOUS DESIGN. INT. CL. 42. REG. 1-14-1986.
- 1,378,530. MIAMI RUG. INT. CL. 42. REG. 1-14-1986.
- 1,378,545. COPY DATA. INT. CL. 42. REG. 1-14-1986.
- 1,378,548. LESPORTSAC TRAVELSTORE. INT. CL. 42. REG. 1-14-1986.
- 1,378,556. DINGBATS. INT. CL. 42. REG. 1-14-1986.
- 1,378,561. HEALTHSCORE. INT. CL. 42. REG. 1-14-1986.
- 1,378,569. BENCONC. INT. CL. 42. REG. 1-14-1986.
- 1,378,573. AMERICAN PERFORMANCE PARTS WAREHOUSE (STYLIZED). INT. CL. 42. REG. 1-14-1986.
- 1,378,574. MISCELLANEOUS DESIGN. INT. CL. 42. REG. 1-14-1986.
- 1,378,587. IBT AND DESIGN. INT. CL. 42. REG. 1-14-1986.
- 1,378,590. PRO SPORTS MEDICINE AND DESIGN. INT. CL. 42. REG. 1-14-1986.
- 1,378,593. BEYOND BY MAIL. INT. CL. 42. REG. 1-14-1986.
- 1,378,599. CENTRAL PARK LODGE. INT. CL. 42. REG. 1-14-1986.
- 1,378,601. P.D. QUIX. INT. CL. 42. REG. 1-14-1986.
- 1,378,607. PACER SYSTEMS, INC. AND DESIGN. INT. CL. 42. REG. 1-14-1986.
- 1,378,609. U. S. TIME SERIES. INT. CL. 42. REG. 1-14-1986.
- 1,378,617. TELECARD. INT. CL. 42. REG. 1-14-1986.
- 1,378,623. THE G MARKETING COMPANY AND DESIGN. INT. CL. 42. REG. 1-14-1986.
- 1,378,627. THE OLIVE BRANCH AND DESIGN. INT. CL. 42. REG. 1-14-1986.
- 1,378,629. NO STOPPING THE TOPPING SUNDAE BAR. INT. CL. 42. REG. 1-14-1986.
- 1,378,630. BIRRAPORETTI'S. INT. CL. 42. REG. 1-14-1986.
- 1,378,631. MISCELLANEOUS DESIGN. U.S. CL. 200. REG. 1-14-1986.
- 1,378,632. NSF (STYLIZED). U.S. CL. A. REG. 1-14-1986.
- 1,378,639. BRITENER. INT. CL. 1. REG. 1-14-1986.
- 1,378,646. ULTRA-POWER. INT. CL. 3. REG. 1-14-1986.
- 1,378,649. THE FEELING OF NUTRITIONAL WELL BEING. INT. CL. 5. REG. 1-14-1986.
- 1,378,656. AUTOPHASE. INT. CL. 9. REG. 1-14-1986.
- 1,378,661. HALOGEN BRIGHT SPOT. INT. CL. 11. REG. 1-14-1986.
- 1,378,663. MISCELLANEOUS DESIGN. INT. CL. 16. REG. 1-14-1986.
- 1,378,677. HEALTHY. INT. CL. 30. REG. 1-14-1986.
- 1,378,681. CREATIVE CONSUMERS. INT. CL. 35. REG. 1-14-1986.
- 1,378,685. 99¢ VIDEO CLUB AND DESIGN. INT. CL. 41. REG. 1-14-1986.
- 1,378,686. USA. INT. CL. 42. REG. 1-14-1986.
- 1,378,795. MIDORI. INT. CLS. 6, 14, 18, 20, 21, 24, 25, 28 AND 34 ONLY. REG. 1-21-1986.
- 1,832,257. JOE COLLEGE. INT. CL. 25. REG. 4-19-1994.
- 1,874,794. WESTERN FARMS AND DESIGN. INT. CL. 30. REG. 1-17-1995.
- 1,932,465. KIDS AND DESIGN. INT. CL. 20 ONLY. REG. 11-7-1995.
- 1,941,144. HAN FENG (STYLIZED). INT. CLS. 21 AND 24 ONLY. REG. 12-12-1995.
- 1,947,821. ELAN. INT. CL. 18. REG. 1-16-1996.
- 1,947,832. PINEWOOD STUDIOS. INT. CLS. 9 AND 41. REG. 1-16-1996.
- 1,947,836. PROGRAM II CLEAR. INT. CL. 3. REG. 1-16-1996.
- 1,947,846. C AND DESIGN. INT. CLS. 12, 20 AND 42. REG. 1-16-1996.
- 1,947,858. ULTRAHIDE BREATHABLE SYNTHETIC LEATHER. INT. CL. 25. REG. 1-16-1996.
- 1,947,859. MISCELLANEOUS DESIGN. INT. CL. 32. REG. 1-16-1996.
- 1,947,866. THERAWRAP. INT. CL. 10. REG. 1-16-1996.
- 1,947,873. PERMA-BLOCK. INT. CL. 17. REG. 1-16-1996.
- 1,947,881. VORTEX. INT. CL. 7. REG. 1-16-1996.
- 1,947,886. QUICKELS. INT. CL. 10. REG. 1-16-1996.
- 1,947,887. QUICKELS AND DESIGN. INT. CL. 10. REG. 1-16-1996.
- 1,947,891. BUDDAH RECORDS. INT. CL. 9. REG. 1-16-1996.
- 1,947,908. FEEDMASTER. INT. CLS. 1 AND 31. REG. 1-16-1996.
- 1,947,911. CELEBRITY CHARITY CHAIR AUCTION. INT. CL. 36. REG. 1-16-1996.
- 1,947,921. ENVIROBRITE. INT. CL. 1. REG. 1-16-1996.
- 1,947,932. THE VALUE LEADER. INT. CL. 42. REG. 1-16-1996.
- 1,947,934. WINDOW OF ENTERPRISE AND DESIGN. INT. CL. 9. REG. 1-16-1996.
- 1,947,940. PUB CRAWL. INT. CL. 21. REG. 1-16-1996.
- 1,947,941. WINCHELL'S AND DESIGN. INT. CLS. 30 AND 42. REG. 1-16-1996.
- 1,947,943. RUB-R-PLAS. INT. CL. 1. REG. 1-16-1996.
- 1,947,952. SHRIMPROBE. INT. CL. 5. REG. 1-16-1996.
- 1,947,972. ORLANDO YOU NEVER OUTGROW IT AND DESIGN. INT. CL. 35. REG. 1-16-1996.
- 1,947,973. MISCELLANEOUS DESIGN. INT. CL. 29. REG. 1-16-1996.
- 1,947,979. ARMSTRONG DARLING AND DESIGN. INT. CLS. 7, 9 AND 11. REG. 1-16-1996.
- 1,947,980. DREAMING PRINCESS. INT. CL. 3. REG. 1-16-1996.
- 1,947,985. CHINTAI AND DESIGN. INT. CL. 36. REG. 1-16-1996.
- 1,947,986. MM MASTER MARK (STYLIZED). INT. CLS. 19 AND 20. REG. 1-16-1996.
- 1,947,993. THE PERFORMANCE SAILING SCHOOL. INT. CLS. 9 AND 41. REG. 1-16-1996.
- 1,948,019. PAINLESS 400. INT. CL. 5. REG. 1-16-1996.
- 1,948,020. BENTLEY BENTLEY COLLEGE AND DESIGN. INT. CL. 41. REG. 1-16-1996.
- 1,948,027. ROLAMECH. INT. CL. 16. REG. 1-16-1996.
- 1,948,028. RIDE AMERICA AND DESIGN. INT. CL. 42. REG. 1-16-1996.
- 1,948,031. TEQUILA MICO AND DESIGN. INT. CL. 33. REG. 1-16-1996.
- 1,948,033. ELUPATCH FUCUS. INT. CL. 5. REG. 1-16-1996.
- 1,948,094. INTERNATIONAL LIVING. INT. CL. 16. REG. 1-16-1996.
- 1,948,099. FULL SERVICE NETWORK AND DESIGN. INT. CL. 38. REG. 1-16-1996.
- 1,948,101. MISCELLANEOUS DESIGN. INT. CL. 42. REG. 1-16-1996.
- 1,948,102. LIFESTYLE MEDIA-RELATIONS REPORTER. INT. CL. 16. REG. 1-16-1996.
- 1,948,113. COAGSPIN. INT. CL. 10. REG. 1-16-1996.
- 1,948,117. WERK THOROUGHbred CONSULTANTS, INC. AND DESIGN. INT. CL. 42. REG. 1-16-1996.
- 1,948,119. L'INGLESINA BABY. INT. CLS. 12, 18 AND 20. REG. 1-16-1996.
- 1,948,132. SHOWCOTE. INT. CL. 3. REG. 1-16-1996.

- 1,948,138. HEARTCARE CORPORATION OF AMERICA AND DESIGN. INT. CLS. 10 AND 42. REG. 1-16-1996.
- 1,948,181. SUMMERHILL FARMING INC. AND DESIGN. INT. CL. 36. REG. 1-16-1996.
- 1,948,182. SUMMERHILL. INT. CL. 36. REG. 1-16-1996.
- 1,948,194. SITE BOSS. INT. CL. 11. REG. 1-16-1996.
- 1,948,198. STIPULA. INT. CL. 16. REG. 1-16-1996.
- 1,948,200. SACCO SAMBUCA AND DESIGN. INT. CL. 33. REG. 1-16-1996.
- 1,948,209. AMARTJIA. INT. CL. 3. REG. 1-16-1996.
- 1,948,232. V GRAND VICTORIA CASINO AND DESIGN. INT. CL. 25. REG. 1-16-1996.
- 1,948,234. EXECUCOMP. INT. CL. 36. REG. 1-16-1996.
- 1,948,238. MERRIMINTS. INT. CL. 30. REG. 1-16-1996.
- 1,948,241. PUER DOG AND DESIGN. INT. CL. 25. REG. 1-16-1996.
- 1,948,249. QUICK-CLAIM. INT. CL. 20. REG. 1-16-1996.
- 1,948,254. GEMLINK. INT. CL. 38. REG. 1-16-1996.
- 1,948,263. VITA ZETA. INT. CLS. 5 AND 10. REG. 1-16-1996.
- 1,948,265. K AND DESIGN. INT. CL. 7. REG. 1-16-1996.
- 1,948,274. KALLOY UNO U AND DESIGN. INT. CL. 12. REG. 1-16-1996.
- 1,948,280. MISCELLANEOUS DESIGN. INT. CL. 41. REG. 1-16-1996.
- 1,948,294. PRIME SOURCE. INT. CL. 5. REG. 1-16-1996.
- 1,948,308. THE MARITANA GRILLE. INT. CL. 42. REG. 1-16-1996.
- 1,948,317. GOD'S HALF HOUR. INT. CL. 41. REG. 1-16-1996.
- 1,948,321. AGTOPROF, INC. AND DESIGN. INT. CLS. 35 AND 42. REG. 1-16-1996.
- 1,948,322. BEYOND CONSULTING. INT. CL. 35. REG. 1-16-1996.
- 1,948,323. COLOR ME BEAUTIFUL. INT. CL. 16. REG. 1-16-1996.
- 1,948,326. TECHNICON IDEE. INT. CL. 9. REG. 1-16-1996.
- 1,948,334. BD ENGINE BRAKE AND DESIGN. INT. CLS. 7 AND 37. REG. 1-16-1996.
- 1,948,343. ARTSMART. INT. CL. 16. REG. 1-16-1996.
- 1,948,356. SPI. INT. CLS. 35 AND 41. REG. 1-16-1996.
- 1,948,375. HYDRO-NUTRITIVE. INT. CL. 3. REG. 1-16-1996.
- 1,948,383. MULTIMEDIA CD-ROM COMPATIBLE AND DESIGN. INT. CL. 9. REG. 1-16-1996.
- 1,948,391. K-O'D. INT. CL. 25. REG. 1-16-1996.
- 1,948,397. CARMAX. INT. CL. 37. REG. 1-16-1996.
- 1,948,400. MISCELLANEOUS DESIGN. INT. CL. 19. REG. 1-16-1996.
- 1,948,402. CREATIVE ALTERNATIVES, INC. AND DESIGN. INT. CLS. 41 AND 42. REG. 1-16-1996.
- 1,948,408. SWISS ESSENTIALS. INT. CL. 3. REG. 1-16-1996.
- 1,948,412. FINOVA CAPITAL CORPORATION. INT. CL. 36. REG. 1-16-1996.
- 1,948,420. MASTERTRAX. INT. CL. 42. REG. 1-16-1996.
- 1,948,425. METROPOLIS BBS. INT. CL. 42. REG. 1-16-1996.
- 1,948,430. PADOW'S AND DESIGN. INT. CLS. 29 AND 30. REG. 1-16-1996.
- 1,948,437. CONTAPOUR. INT. CL. 7. REG. 1-16-1996.
- 1,948,445. DSX. INT. CL. 11. REG. 1-16-1996.
- 1,948,447. THE BAND WAGON. INT. CL. 41. REG. 1-16-1996.
- 1,948,452. BEST/1-VISUALIZER. INT. CL. 9. REG. 1-16-1996.
- 1,948,454. CYCLONE AND DESIGN. INT. CL. 7. REG. 1-16-1996.
- 1,948,455. ALCC. INT. CL. 41. REG. 1-16-1996.
- 1,948,456. LIGHTWAVE. INT. CL. 9. REG. 1-16-1996.
- 1,948,465. JG AND DESIGN. INT. CL. 25. REG. 1-16-1996.
- 1,948,494. CIRCUITS & BUMPS, INC. USA 93 AND DESIGN. INT. CL. 42. REG. 1-16-1996.
- 1,948,508. ALLERFED. INT. CL. 5. REG. 1-16-1996.
- 1,948,512. WFO WATCH. INT. CL. 16. REG. 1-16-1996.
- 1,948,518. BREWERY HILL. INT. CL. 32. REG. 1-16-1996.
- 1,948,530. WONDERDOGS FRANK FOOTLONG KNOCK-WURST AND DESIGN. INT. CL. 29. REG. 1-16-1996.
- 1,948,539. WIDECAST AND DESIGN. INT. CL. 9. REG. 1-16-1996.
- 1,948,541. PRISM HOLIDAYS. INT. CL. 39. REG. 1-16-1996.
- 1,948,543. FLORE CAROLINA HERRERA. INT. CL. 3. REG. 1-16-1996.
- 1,948,544. SAFESEAL. INT. CL. 20. REG. 1-16-1996.
- 1,948,547. MISCELLANEOUS DESIGN. INT. CL. 29. REG. 1-16-1996.
- 1,948,568. SOURCE SERVICES. INT. CL. 35. REG. 1-16-1996.
- 1,948,580. TEK-SEAL. INT. CL. 19. REG. 1-16-1996.
- 1,948,584. PAR-B-Q. INT. CL. 21. REG. 1-16-1996.
- 1,948,590. AIR-STRIKE. INT. CL. 28. REG. 1-16-1996.
- 1,948,595. QUALITY YOU CAN SEE AND DESIGN. INT. CL. 30. REG. 1-16-1996.
- 1,948,605. AIDA GREY (STYLIZED). INT. CL. 42. REG. 1-16-1996.
- 1,948,619. SHELF.N.STORE. INT. CL. 21. REG. 1-16-1996.
- 1,948,622. NATIONAL GAS. INT. CL. 42. REG. 1-16-1996.
- 1,948,629. GOBBLE UP AND DESIGN. INT. CL. 29. REG. 1-16-1996.
- 1,948,634. ORANGE MANGO ZINGER. INT. CL. 30. REG. 1-16-1996.
- 1,948,639. CASCADE. INT. CL. 20. REG. 1-16-1996.
- 1,948,648. INNOVATIVE FOODS EXPO AND DESIGN. INT. CL. 35. REG. 1-16-1996.
- 1,948,649. SBF BOURSE DE PARIS AND DESIGN. INT. CLS. 16, 35 AND 36. REG. 1-16-1996.
- 1,948,655. COPYWORKS. INT. CL. 9. REG. 1-16-1996.
- 1,948,662. S STERLING PULP CHEMICALS (STYLIZED). INT. CL. 42. REG. 1-16-1996.
- 1,948,668. ICED GOLD. INT. CL. 30. REG. 1-16-1996.
- 1,948,689. HIDE THOSE WIRES QUICKLY, EASILY AND SAFELY WITH THE WIRE HIDER SYSTEM AND DESIGN. INT. CL. 19. REG. 1-16-1996.
- 1,948,696. VINA LAS LENAS. INT. CL. 33. REG. 1-16-1996.
- 1,948,698. OUTFOX PHONE FRAUD. INT. CL. 42. REG. 1-16-1996.
- 1,948,699. FREDDIE THE PHONE FRAUD FOX. INT. CL. 42. REG. 1-16-1996.
- 1,948,702. COTTAGE COMPUTERS. INT. CL. 42. REG. 1-16-1996.
- 1,948,710. HOTSILKS. INT. CL. 25. REG. 1-16-1996.
- 1,948,716. KODATEL. INT. CL. 9. REG. 1-16-1996.
- 1,948,721. POUDDRE MAJEUR. INT. CL. 3. REG. 1-16-1996.
- 1,948,735. THE CANDY COTTAGE COMPANY. INT. CL. 30. REG. 1-16-1996.
- 1,948,747. THE STAR SPANGLED BURGER. INT. CL. 30. REG. 1-16-1996.
- 1,948,755. I3 SYSTEM-ABD. INT. CL. 10. REG. 1-16-1996.
- 1,948,758. PARAVOIX. INT. CL. 9. REG. 1-16-1996.
- 1,948,761. THE 16 FL. OZ. POUND. INT. CL. 32. REG. 1-16-1996.
- 1,948,764. POWER HEAD. INT. CL. 28. REG. 1-16-1996.
- 1,948,770. NATIONAL AUBUBON SOCIETY NATURE ODYSSEYS. INT. CL. 39. REG. 1-16-1996.
- 1,948,783. GS GALLARD SCHLESINGER AND DESIGN. INT. CL. 35. REG. 1-16-1996.
- 1,948,793. M (STYLIZED). INT. CL. 42. REG. 1-16-1996.
- 1,948,811. GONZALES CHORIZO AND DESIGN. INT. CL. 29. REG. 1-16-1996.
- 1,948,812. S AND DESIGN. INT. CL. 36. REG. 1-16-1996.
- 1,948,814. SUMMASIGN. INT. CL. 9. REG. 1-16-1996.
- 1,948,824. TROPICAL EXPRESSIONS. INT. CL. 42. REG. 1-16-1996.
- 1,948,833. WHERE TECHNOLOGY AND SOLUTIONS MEET. INT. CL. 38. REG. 1-16-1996.
- 1,948,839. MISCELLANEOUS DESIGN. INT. CL. 32. REG. 1-16-1996.
- 1,948,847. THE VILLAGE CHRONICLE. INT. CL. 16. REG. 1-16-1996.
- 1,948,853. INNOVATION FOCUS. INT. CLS. 35, 41 AND 42. REG. 1-16-1996.
- 1,948,874. FLOW SUPPORT. INT. CL. 9. REG. 1-16-1996.
- 1,948,880. SPRING CREEK RANCH. INT. CL. 41. REG. 1-16-1996.
- 1,948,882. CHICK-FIL-A.M. AND DESIGN. INT. CLS. 29, 30, 32 AND 42. REG. 1-16-1996.
- 1,948,885. VALVACTIVE-FAX. INT. CL. 35. REG. 1-16-1996.
- 1,948,897. THINK AGAIN. INT. CL. 25. REG. 1-16-1996.
- 1,948,898. HEALTHY INVESTING. INT. CL. 36. REG. 1-16-1996.
- 1,948,902. TOUCHE (STYLIZED). INT. CL. 5. REG. 1-16-1996.
- 1,948,903. MIRROR IMAGE. INT. CL. 28. REG. 1-16-1996.

- 1,948,911. SINISTER AND DESIGN. INT. CL. 25. REG. 1-16-1996.
- 1,948,922. GUARDS. INT. CL. 10. REG. 1-16-1996.
- 1,948,932. OFFICEMAX AND DESIGN. INT. CLS. 16 AND 42. REG. 1-16-1996.
- 1,948,935. AT&T RESOURCES FOR NEW BUSINESS. INT. CL. 35. REG. 1-16-1996.
- 1,948,944. PARTNERS. INT. CL. 35. REG. 1-16-1996.
- 1,948,946. IMR. INT. CL. 35. REG. 1-16-1996.
- 1,948,947. ABC. INT. CL. 42. REG. 1-16-1996.
- 1,948,956. AIR-GUARD. INT. CL. 9. REG. 1-16-1996.
- 1,948,964. HOUGH AND DESIGN. INT. CLS. 7 AND 9. REG. 1-16-1996.
- 1,948,965. POP & WRAP DISPENSER AND DESIGN. INT. CL. 16. REG. 1-16-1996.
- 1,948,986. ECOPAWE. INT. CL. 1. REG. 1-16-1996.
- 1,948,987. MOTHER BUTLER. INT. CL. 30. REG. 1-16-1996.
- 1,948,988. THE CRAZY CRAB AND DESIGN. INT. CL. 42. REG. 1-16-1996.
- 1,948,989. MOTHER BUTLER AND DESIGN. INT. CL. 30. REG. 1-16-1996.
- 1,948,995. SCANNER. INT. CL. 16. REG. 1-16-1996.
- 1,949,003. LAU TECHNOLOGIES. INT. CL. 9. REG. 1-16-1996.
- 1,949,013. WILLIAN BRINKS HOFER GILSON & LIONE AND DESIGN. INT. CL. 42. REG. 1-16-1996.
- 1,949,020. CMB. INT. CL. 16. REG. 1-16-1996.
- 1,949,029. SUCCESS STORY. INT. CL. 42. REG. 1-16-1996.
- 1,949,036. YOU-ME SENSITIVELY AND DESIGN. INT. CL. 14. REG. 1-16-1996.
- 1,949,046. MAALOX. INT. CL. 5. REG. 1-16-1996.
- 1,949,049. FASHION PLATES. INT. CL. 42. REG. 1-16-1996.
- 1,949,062. SMITH & JONES. INT. CL. 25. REG. 1-16-1996.
- 1,949,067. CALGON AND DESIGN. INT. CL. 1. REG. 1-16-1996.
- 1,949,078. METIER. INT. CL. 20. REG. 1-16-1996.
- 1,949,099. MISCELLANEOUS DESIGN. INT. CL. 42. REG. 1-16-1996.
- 1,949,112. CATFISH "BITES". INT. CL. 28. REG. 1-16-1996.
- 1,949,119. BUSY BEE CANDLES. INT. CL. 4. REG. 1-16-1996.
- 1,949,126. ACCU-CASH. INT. CL. 42. REG. 1-16-1996.
- 1,949,127. MY BREW HEAVEN. INT. CL. 42. REG. 1-16-1996.
- 1,949,136. KW (STYLIZED). INT. CL. 14. REG. 1-16-1996.
- 1,949,146. JEWELL'S CLASSIC BOTTOMS. INT. CL. 25. REG. 1-16-1996.
- 1,949,158. SURGEON'S CHOICE. INT. CL. 10. REG. 1-16-1996.
- 1,949,159. AAMGA. U.S. CL. 200. REG. 1-16-1996.
- 1,949,165. SKY-COM. INT. CL. 9. REG. 1-16-1996.
- 1,949,168. LANDMARK. INT. CL. 37. REG. 1-16-1996.
- 1,949,184. KOREANA BLANKET AND DESIGN. INT. CL. 24. REG. 1-16-1996.
- 1,949,193. GARDENSOUTH. INT. CL. 42. REG. 1-16-1996.
- 1,949,194. YOUR FAMILY ENTERTAINMENT SOURCE!. INT. CLS. 41 AND 42. REG. 1-16-1996.
- 1,949,203. MODEM SAVER. INT. CL. 9. REG. 1-16-1996.
- 1,949,205. WHEN IT HAS TO BE PERFECT. INT. CL. 40. REG. 1-16-1996.
- 1,949,221. ADVENTURER. INT. CL. 16. REG. 1-16-1996.
- 1,949,229. DKNY. INT. CL. 25. REG. 1-16-1996.
- 1,949,235. LENSCHKE. INT. CL. 9. REG. 1-16-1996.
- 1,949,236. MOBILETEL AND DESIGN. INT. CL. 38. REG. 1-16-1996.
- 1,949,256. THE RAKE'S PROGRESS. INT. CL. 16. REG. 1-16-1996.
- 1,949,260. FEELS LIKE YOU (STYLIZED). INT. CL. 42. REG. 1-16-1996.
- 1,949,267. MAXTOUCH (STYLIZED). INT. CL. 28. REG. 1-16-1996.
- 1,949,287. CARDIETTE. INT. CL. 10. REG. 1-16-1996.
- 1,949,297. SENET. INT. CL. 9. REG. 1-16-1996.
- 1,949,300. TOP CONDITION. INT. CL. 31. REG. 1-16-1996.
- 1,949,302. TELE-SENTRY. INT. CL. 10. REG. 1-16-1996.
- 1,949,306. ANCESTORS AND DESCENDANTS. INT. CL. 9. REG. 1-16-1996.
- 1,949,310. CT/DATA SERVER. INT. CL. 9. REG. 1-16-1996.
- 1,949,312. CT. INT. CL. 9. REG. 1-16-1996.
- 1,949,317. STRATA STAR. INT. CL. 7. REG. 1-16-1996.
- 1,949,320. MAUI MONKEY. INT. CL. 16. REG. 1-16-1996.
- 1,949,326. PROTAIN XL. INT. CL. 5. REG. 1-16-1996.
- 1,949,337. OVICH PRONOUNCED OF EACH. INT. CL. 35. REG. 1-16-1996.
- 1,949,345. BREATHPATROL. INT. CL. 30. REG. 1-16-1996.
- 1,949,350. RIGHT TOUCH. INT. CL. 9. REG. 1-16-1996.
- 1,949,355. BOHEMIAN RASPBERRY. INT. CL. 33. REG. 1-16-1996.
- 1,949,356. THE QUIET WAR. INT. CL. 21. REG. 1-16-1996.
- 1,949,396. VENISON WORLD AND DESIGN. INT. CLS. 18, 20, 25 AND 29. REG. 1-16-1996.
- 1,949,398. TRAUMA RECORDS. INT. CL. 9. REG. 1-16-1996.
- 1,949,407. TRANSTEXAS. INT. CL. 4. REG. 1-16-1996.
- 1,949,414. FREESTAT. INT. CL. 1. REG. 1-16-1996.
- 1,949,432. RHOPLEX FASTRACK. INT. CL. 1. REG. 1-16-1996.
- 1,949,434. THE OHM COMPCASE MANAGER. INT. CL. 9. REG. 1-16-1996.
- 1,949,441. LIFESTYLES. INT. CL. 27. REG. 1-16-1996.
- 1,949,443. WE MAKE SEAFOOD EASY. INT. CLS. 29 AND 30. REG. 1-16-1996.
- 1,949,447. BXN. INT. CL. 31. REG. 1-16-1996.
- 1,949,449. VEROTIK. INT. CL. 16. REG. 1-16-1996.
- 1,949,460. TRUE PAGE. INT. CL. 9. REG. 1-16-1996.
- 1,949,468. ULTRASAVOUR. INT. CL. 30. REG. 1-16-1996.
- 1,949,469. P.J.W. P.J. WALSH U. S. A. AND DESIGN. INT. CL. 25. REG. 1-16-1996.
- 1,949,473. OONA. INT. CL. 25. REG. 1-16-1996.
- 1,949,478. RINGER. INT. CL. 30. REG. 1-16-1996.
- 1,949,482. MALE MENOPAUSAL SYNDROMES AND DESIGN. INT. CLS. 16, 21 AND 25. REG. 1-16-1996.
- 1,949,493. BEACHBOWL. INT. CL. 28. REG. 1-16-1996.
- 1,949,503. SQUID STRIPS. INT. CL. 28. REG. 1-16-1996.
- 1,949,506. CD GALLERY. INT. CL. 20. REG. 1-16-1996.
- 1,949,511. MISCELLANEOUS DESIGN. INT. CL. 36. REG. 1-16-1996.
- 1,949,519. HARTCO AMERICAN PRIDE. INT. CL. 19. REG. 1-16-1996.
- 1,949,526. MEDIFACTS AND DESIGN. INT. CL. 16. REG. 1-16-1996.
- 1,949,544. LIBERTY BOND SERVICES. INT. CL. 36. REG. 1-16-1996.
- 1,949,550. I KID-YOU-NOT. INT. CL. 16. REG. 1-16-1996.
- 1,949,561. SMITH FARMS AU NATURAL SODA. INT. CL. 32. REG. 1-16-1996.
- 1,949,569. PSYCHEDELIC SATELLITE NETWORK AND DESIGN. INT. CL. 41. REG. 1-16-1996.
- 1,949,571. SOOTHERS. INT. CL. 5. REG. 1-16-1996.
- 1,949,583. NATIONAL LABS - THE ORTHOPEDIC ADVANTAGE. INT. CL. 10. REG. 1-16-1996.
- 1,949,602. SNAP-2-IT. INT. CL. 9. REG. 1-16-1996.
- 1,949,610. MEWSMENTS. INT. CL. 28. REG. 1-16-1996.
- 1,949,615. INVEST IN EXPERIENCE. INT. CL. 36. REG. 1-16-1996.
- 1,949,619. HISTORICALLY BLACK COLLEGIATE COALITIONHBCC AND DESIGN. INT. CL. 42. REG. 1-16-1996.
- 1,949,620. MISCELLANEOUS DESIGN. INT. CL. 42. REG. 1-16-1996.
- 1,949,621. VINNY TESTA'S BAR RISTORANTE AND DESIGN. INT. CL. 42. REG. 1-16-1996.
- 1,949,625. STAR TREK: VOYAGER. INT. CL. 21. REG. 1-16-1996.
- 1,949,636. THE WORK NUMBER FOR EVERYONE. INT. CL. 35. REG. 1-16-1996.
- 1,949,650. GUARDIAN AND DESIGN. INT. CL. 1. REG. 1-16-1996.
- 1,949,652. MENTOR. INT. CL. 8. REG. 1-16-1996.
- 1,949,653. OCEAN TECHNOLOGY. INT. CL. 25. REG. 1-16-1996.
- 1,949,655. BOND TRAINING CAMP. INT. CL. 41. REG. 1-16-1996.
- 1,949,660. CLASSIC EQUINE COLLECTION AND DESIGN. INT. CLS. 10 AND 18. REG. 1-16-1996.
- 1,949,663. V3 (STYLIZED). INT. CL. 9. REG. 1-16-1996.
- 1,949,674. FANCY FRUITS. INT. CL. 9. REG. 1-16-1996.
- 1,949,675. KANGAROO. INT. CL. 9. REG. 1-16-1996.
- 1,949,685. FLAG GUARD. INT. CL. 1. REG. 1-16-1996.

- 1,949,699. COMFORTWORKS. INT. CL. 9. REG. 1-16-1996.
 1,949,706. ACCINTE. INT. CL. 25. REG. 1-16-1996.
 1,949,708. SCOTT-SOLID. INT. CL. 17. REG. 1-16-1996.
 1,949,709. SCOTT-PHENOLIC. INT. CL. 17. REG. 1-16-1996.
 1,949,716. DYNAMIC FINISHES. INT. CL. 27. REG. 1-16-1996.
 1,949,725. HOME INFORMATION SERVICES, INC.. INT. CL. 42. REG. 1-16-1996.
 1,949,726. RED PLANET. INT. CL. 25. REG. 1-16-1996.
 1,949,730. EARTHSHIELD AND DESIGN. INT. CL. 21. REG. 1-16-1996.
 1,949,734. BODACIOUS. INT. CL. 3. REG. 1-16-1996.
 1,949,737. OAKVILLE GRADE. INT. CL. 33. REG. 1-16-1996.
 1,949,742. SUPER SLEEVE SYSTEM. INT. CL. 17. REG. 1-16-1996.
 1,949,773. NORTH SHORE COMMUNITY BANK & TRUST COMPANY. INT. CL. 36. REG. 1-16-1996.
 1,949,775. MILL CREEK BREWERY & RESTAURANT. INT. CL. 42. REG. 1-16-1996.
 1,949,777. INSCRIPTIONTILE. INT. CL. 19. REG. 1-16-1996.
 1,949,787. CALIFORNIA COLDWATER CARROTS. INT. CL. 29. REG. 1-16-1996.
 1,949,792. ALLIANCE FOR REDESIGNING GOVERNMENT. INT. CL. 16. REG. 1-16-1996.
 1,949,804. NEW URBAN REGION. INT. CL. 41. REG. 1-16-1996.
 1,949,805. NEW URBAN REGION. INT. CL. 42. REG. 1-16-1996.
 1,949,809. MEDICAL SOFTWARE REVIEWS. INT. CL. 16. REG. 1-16-1996.
 1,949,817. FLOOR ART. INT. CL. 20. REG. 1-16-1996.
 1,951,643. CLECS. INT. CLS. 1 AND 32 ONLY. REG. 1-23-1996.
 1,981,381. TTC TOTAL TRAIN CONTROL AND DESIGN. INT. CL. 42 ONLY. REG. 6-18-1996.
 1,987,935. CEBE AND DESIGN. INT. CL. 9 ONLY. REG. 7-23-1996.
 1,991,581. SBARRO. INT. CL. 29 ONLY. REG. 8-6-1996.
 1,994,940. MISCELLANEOUS DESIGN. INT. CL. 24 ONLY. REG. 8-20-1996.
 1,998,482. SIGNATURE. INT. CL. 35 ONLY. REG. 9-3-1996.
 2,011,466. CYPRESS CORPORATE CENTER. INT. CL. 37 ONLY. REG. 10-29-1996.
 2,016,230. TTOUCH AND DESIGN. INT. CL. 3 ONLY. REG. 11-12-1996.
 2,025,368. X-DOT (STYLIZED). INT. CL. 36 ONLY. REG. 12-24-1996.
 2,027,796. CHEMSURE. INT. CL. 1 ONLY. REG. 12-31-1996.
 2,241,551. TELECHARGE. INT. CL. 36. REG. 4-27-1999.
 2,246,852. PROFESSIONAL COSMETICS. INT. CL. 16. REG. 5-18-1999.
 2,303,132. KNVB. INT. CLS. 3, 14, 21, 24, 26, 28 AND 30 ONLY. REG. 12-28-1999.
 2,308,128. MISCELLANEOUS DESIGN. INT. CL. 36. REG. 1-18-2000.
 2,308,131. COLORS FOR LEGS. INT. CL. 25. REG. 1-18-2000.
 2,308,132. KANEKA CRYSTALATE. INT. CL. 1. REG. 1-18-2000.
 2,308,135. MANZANAH CHAWAH. INT. CLS. 29 AND 30. REG. 1-18-2000.
 2,308,137. PLATINUM OBJECT TRACKER. INT. CL. 9. REG. 1-18-2000.
 2,308,139. G AND DESIGN. INT. CL. 25. REG. 1-18-2000.
 2,308,140. BODYBUZZZ SENSORY SHOWER GEL. INT. CL. 3. REG. 1-18-2000.
 2,308,141. CIRCON. INT. CLS. 9 AND 42. REG. 1-18-2000.
 2,308,143. BLACK SAND HAWAII. INT. CL. 25. REG. 1-18-2000.
 2,308,145. FOCUS. INT. CL. 11. REG. 1-18-2000.
 2,308,146. WEB ONE. INT. CL. 42. REG. 1-18-2000.
 2,308,147. L.A. BLUEGRASS. INT. CL. 25. REG. 1-18-2000.
 2,308,148. KAISER MICROMILLS. INT. CL. 42. REG. 1-18-2000.
 2,308,151. WINK.... WE DO IT IN THE BEDROOM. INT. CLS. 20 AND 24. REG. 1-18-2000.
 2,308,152. AMAIL. INT. CL. 42. REG. 1-18-2000.
 2,308,156. H2O SCREW (STYLIZED). INT. CL. 7. REG. 1-18-2000.
 2,308,157. AQUA SCREW. INT. CL. 7. REG. 1-18-2000.
 2,308,158. GOLDEN PRIDE. INT. CL. 32. REG. 1-18-2000.
 2,308,160. GEA FLOW COMPONENTS (STYLIZED). INT. CLS. 7 AND 9. REG. 1-18-2000.
 2,308,161. GHI DIAL 4 LESS AND DESIGN. INT. CLS. 16, 36 AND 38. REG. 1-18-2000.
 2,308,162. TALLAHASSEE TIGER SHARKS AND DESIGN. INT. CL. 25. REG. 1-18-2000.
 2,308,163. LIVEWIRES PERFORMANCE DISTRIBUTORS AND DESIGN. INT. CL. 7. REG. 1-18-2000.
 2,308,165. ROMANTICO BY INTIMO AND DESIGN. INT. CL. 25. REG. 1-18-2000.
 2,308,169. PCS EASYPHONE (STYLIZED). INT. CL. 36. REG. 1-18-2000.
 2,308,171. NCOMPASS. INT. CL. 9. REG. 1-18-2000.
 2,308,175. AGENCY OFFICE. INT. CL. 9. REG. 1-18-2000.
 2,308,178. EXTENDED TECHNOLOGIES AND DESIGN. INT. CLS. 9, 16, 41 AND 42. REG. 1-18-2000.
 2,308,181. PRICESSET (STYLIZED). INT. CL. 35. REG. 1-18-2000.
 2,308,182. JUMBO SPORTS AND DESIGN. INT. CL. 35. REG. 1-18-2000.
 2,308,186. TALENT. INT. CL. 10. REG. 1-18-2000.
 2,308,187. D (STYLIZED). INT. CL. 25. REG. 1-18-2000.
 2,308,188. HDS (STYLIZED). INT. CL. 9. REG. 1-18-2000.
 2,308,189. INDEPENDENT FILM CHANNEL. INT. CLS. 38 AND 41. REG. 1-18-2000.
 2,308,191. MEDISERVE. INT. CL. 42. REG. 1-18-2000.
 2,308,192. BIG POND. INT. CLS. 38, 41 AND 42. REG. 1-18-2000.
 2,308,194. UNIVERSAL FAD. INT. CL. 9. REG. 1-18-2000.
 2,308,196. SCANDISPLAY. INT. CLS. 9, 38 AND 42. REG. 1-18-2000.
 2,308,197. IMPACT. INT. CL. 9. REG. 1-18-2000.
 2,308,199. HEALTH ZONE. INT. CL. 42. REG. 1-18-2000.
 2,308,200. NORKAR TECHNOLOGIES INC. (STYLIZED). INT. CL. 9. REG. 1-18-2000.
 2,308,201. CADHEREX 9. INT. CL. 5. REG. 1-18-2000.
 2,308,202. ECADEX 9. INT. CL. 5. REG. 1-18-2000.
 2,308,203. MQ MOTORQUEST RELAX.HAVE FUN.YOU'RE HERE. (STYLIZED). INT. CLS. 35 AND 37. REG. 1-18-2000.
 2,308,205. RAHMA. INT. CL. 9. REG. 1-18-2000.
 2,308,208. HARD COPY IMAGING AND DESIGN. INT. CLS. 35 AND 42. REG. 1-18-2000.
 2,308,209. THE HARLEM NUTCRACKER. INT. CL. 41. REG. 1-18-2000.
 2,308,213. ULTRATROC. INT. CLS. 11, 37 AND 42. REG. 1-18-2000.
 2,308,214. POWER BANKING. INT. CL. 36. REG. 1-18-2000.
 2,308,219. SOUND MEX. INT. CL. 9. REG. 1-18-2000.
 2,308,220. SPEEDCHOICE. INT. CL. 38. REG. 1-18-2000.
 2,308,221. FLEET HOMEPEPK. INT. CLS. 35, 36 AND 39. REG. 1-18-2000.
 2,308,223. LIFECIRCLE. INT. CL. 41. REG. 1-18-2000.
 2,308,225. S SALCHAIN AND DESIGN. INT. CL. 7. REG. 1-18-2000.
 2,308,226. SPACEARK AND DESIGN. INT. CL. 35. REG. 1-18-2000.
 2,308,227. HR-COM. INT. CL. 9. REG. 1-18-2000.
 2,308,228. APARTMENT SEARCH AND DESIGN. INT. CL. 35. REG. 1-18-2000.
 2,308,231. LEGENDS. INT. CL. 16. REG. 1-18-2000.
 2,308,232. BUILDING MOLECULES INTO BUSINESS. INT. CLS. 40 AND 42. REG. 1-18-2000.
 2,308,235. FIRESET. INT. CLS. 7 AND 9. REG. 1-18-2000.
 2,308,236. BEACON HILL. INT. CL. 20. REG. 1-18-2000.
 2,308,237. WSP. INT. CLS. 2, 9, 17 AND 40. REG. 1-18-2000.
 2,308,238. RINALDO GAVELLO AND DESIGN. INT. CL. 14. REG. 1-18-2000.
 2,308,239. TIME BASE. INT. CLS. 9 AND 42. REG. 1-18-2000.
 2,308,240. THE TELCO REPORT. INT. CL. 16. REG. 1-18-2000.
 2,308,241. MODULAR POWER SYSTEMS AND DESIGN. INT. CL. 9. REG. 1-18-2000.
 2,308,242. WISE BUYS. INT. CL. 42. REG. 1-18-2000.
 2,308,243. SHOES THAT WORK. INT. CL. 25. REG. 1-18-2000.

- 2,308,245. FORENSIC AUDIO SLEUTH AND DESIGN. INT. CL. 9. REG. 1-18-2000.
- 2,308,246. MIGUEL'S JR. AND DESIGN. INT. CL. 42. REG. 1-18-2000.
- 2,308,248. SYSKONNECT. INT. CL. 9. REG. 1-18-2000.
- 2,308,250. ENIGMA. INT. CL. 12. REG. 1-18-2000.
- 2,308,255. RESUMEGENI (STYLIZED). INT. CL. 39. REG. 1-18-2000.
- 2,308,256. RISK ORIGINALITY VIRTUOSITY. INT. CL. 41. REG. 1-18-2000.
- 2,308,258. TELEFREE. INT. CL. 35. REG. 1-18-2000.
- 2,308,260. KONICA DOCUMENTS: ANY FORMAT ANYWHERE ANYTIME AND DESIGN. INT. CL. 9. REG. 1-18-2000.
- 2,308,261. ANDALUZA AND DESIGN. INT. CL. 34. REG. 1-18-2000.
- 2,308,262. BARYON. INT. CLS. 35 AND 36. REG. 1-18-2000.
- 2,308,263. TOGGLETHIS. INT. CL. 9. REG. 1-18-2000.
- 2,308,264. INDY + PLUS INTERNATIONAL. INT. CL. 36. REG. 1-18-2000.
- 2,308,265. EMBRACES ENHANCING MIND-BODY RELATIONSHIPS AND CREATIVELY EXPRESSING SPIRIT AND DESIGN. INT. CL. 42. REG. 1-18-2000.
- 2,308,266. ROCKET CHEF. INT. CL. 8. REG. 1-18-2000.
- 2,308,273. MISCELLANEOUS DESIGN. INT. CL. 33. REG. 1-18-2000.
- 2,308,280. LIBERTY DENTAL ALLIANCE, INC.. INT. CL. 35. REG. 1-18-2000.
- 2,308,282. SANCELLEA (STYLIZED). INT. CLS. 5, 10, 16, 24 AND 25. REG. 1-18-2000.
- 2,308,283. L' ESCARFE AND DESIGN. INT. CL. 25. REG. 1-18-2000.
- 2,308,284. INSPIRADO I D C 1998 IDC HAND PAINTED SEATTLE . USA MADE IN CHINA AND DESIGN. INT. CL. 35. REG. 1-18-2000.
- 2,308,285. METPRO.BIZ. INT. CL. 41. REG. 1-18-2000.
- 2,308,287. PLATINUM CHOICE LASER. INT. CL. 2. REG. 1-18-2000.
- 2,308,288. BECKER GROUP AND DESIGN. INT. CL. 40. REG. 1-18-2000.
- 2,308,292. ALL-STAR JR. INT. CL. 20. REG. 1-18-2000.
- 2,308,294. UNDER COVER MUSIC GROUP NY AND DESIGN. INT. CL. 9. REG. 1-18-2000.
- 2,308,298. COMPREHENSIVE HEALTH SOURCE AND DESIGN. INT. CL. 42. REG. 1-18-2000.
- 2,308,300. UPPET. INT. CL. 21. REG. 1-18-2000.
- 2,308,301. DIGITAL DISCOVERIES. INT. CL. 35. REG. 1-18-2000.
- 2,308,304. DAT DIAL. INT. CL. 38. REG. 1-18-2000.
- 2,308,305. O E CONEKSHUNN. INT. CL. 9. REG. 1-18-2000.
- 2,308,307. REED ELECTRIC CO.. INT. CL. 37. REG. 1-18-2000.
- 2,308,309. TELEGRINDING. INT. CL. 6. REG. 1-18-2000.
- 2,308,310. CANYON CREEK. INT. CLS. 29 AND 30. REG. 1-18-2000.
- 2,308,311. PCE ENGINEERING AND DESIGN. INT. CLS. 7 AND 19. REG. 1-18-2000.
- 2,308,314. ALGEBRA ASSISTANT. INT. CL. 9. REG. 1-18-2000.
- 2,308,315. AAA TRU-GAS. INT. CL. 39. REG. 1-18-2000.
- 2,308,317. QRS AND DESIGN. INT. CL. 9. REG. 1-18-2000.
- 2,308,318. FRENCHKUFF AND DESIGN. INT. CL. 25. REG. 1-18-2000.
- 2,308,321. CUSTOMER SERVICE CENTER OF F.N.B.,LLC AND DESIGN. INT. CL. 36. REG. 1-18-2000.
- 2,308,322. RANDONNEE. INT. CL. 25. REG. 1-18-2000.
- 2,308,323. 2001 WORLD POLICE & FIRE GAMES INDIANAPOLIS, USA AND DESIGN. INT. CLS. 35 AND 41. REG. 1-18-2000.
- 2,308,324. AMERICA'S MONEYLINE. INT. CL. 36. REG. 1-18-2000.
- 2,308,325. PESTERING THE STARS. INT. CL. 41. REG. 1-18-2000.
- 2,308,326. NO RUDE DUDES. INT. CL. 25. REG. 1-18-2000.
- 2,308,327. DLI. INT. CL. 9. REG. 1-18-2000.
- 2,308,329. SEA.LINER. INT. CL. 9. REG. 1-18-2000.
- 2,308,330. FASHION FLASH. INT. CL. 24. REG. 1-18-2000.
- 2,308,333. AMERICA'S DOCTOR. INT. CL. 42. REG. 1-18-2000.
- 2,308,338. BLUE PARADISE. INT. CL. 25. REG. 1-18-2000.
- 2,308,340. MISCELLANEOUS DESIGN. INT. CL. 9. REG. 1-18-2000.
- 2,308,341. PRO AND DESIGN. INT. CL. 9. REG. 1-18-2000.
- 2,308,342. ATLANTIC LUGGAGE CO. SINCE 1919 AND DESIGN. INT. CL. 18. REG. 1-18-2000.
- 2,308,343. DDLC AND DESIGN. INT. CLS. 9 AND 41. REG. 1-18-2000.
- 2,308,345. CNNNEWSSTAND. INT. CL. 41. REG. 1-18-2000.
- 2,308,347. MENASCO. INT. CLS. 7, 37 AND 42. REG. 1-18-2000.
- 2,308,348. DESKTOP COMMANDER. INT. CL. 9. REG. 1-18-2000.
- 2,308,350. PEACHES. N. CREAM AND DESIGN. INT. CL. 35. REG. 1-18-2000.
- 2,308,351. ORB ORB MASTER AND DESIGN. INT. CL. 9. REG. 1-18-2000.
- 2,308,352. THE ONE & ONLY AND DESIGN. INT. CL. 9. REG. 1-18-2000.
- 2,308,353. JUGGERNAUTICS. INT. CL. 42. REG. 1-18-2000.
- 2,308,354. MAGNEDIBLES AND DESIGN. INT. CL. 9. REG. 1-18-2000.
- 2,308,356. EASY WHEEL AND DESIGN. INT. CL. 12. REG. 1-18-2000.
- 2,308,357. WISDOM. INT. CL. 9. REG. 1-18-2000.
- 2,308,359. CRS/LAWRENCE SERVICE. INT. CL. 35. REG. 1-18-2000.
- 2,308,360. SNOW SPORT EXPRESS. INT. CL. 35. REG. 1-18-2000.
- 2,308,364. MISCELLANEOUS DESIGN. INT. CLS. 36 AND 42. REG. 1-18-2000.
- 2,308,365. POWAY DAYS THE TRADITION CONTINUES AND DESIGN. INT. CLS. 35 AND 41. REG. 1-18-2000.
- 2,308,366. WEB PLATINUM. INT. CL. 42. REG. 1-18-2000.
- 2,308,368. ONLINEPROMOTION.COM. INT. CL. 42. REG. 1-18-2000.
- 2,308,369. INVISTACONN. INT. CL. 9. REG. 1-18-2000.
- 2,308,372. MAGICOM MULTIMEDIA CORP.. INT. CL. 9. REG. 1-18-2000.
- 2,308,375. STRATEGY PRO. INT. CL. 9. REG. 1-18-2000.
- 2,308,376. OKKILUX AND DESIGN. INT. CL. 9. REG. 1-18-2000.
- 2,308,377. STRENGTH THROUGH PURITY AND DESIGN. INT. CL. 33. REG. 1-18-2000.
- 2,308,379. VACATIONSPOT.COM AND DESIGN. INT. CL. 42. REG. 1-18-2000.
- 2,308,382. CORE SOFT. INT. CL. 41. REG. 1-18-2000.
- 2,308,384. CORE SOFT AND DESIGN. INT. CL. 41. REG. 1-18-2000.
- 2,308,385. PULS. INT. CL. 9. REG. 1-18-2000.
- 2,308,388. RIGHTIME. INT. CL. 9. REG. 1-18-2000.
- 2,308,393. FPA MEDICAL GROUP. INT. CL. 35. REG. 1-18-2000.
- 2,308,395. EMERGE. INT. CL. 9. REG. 1-18-2000.
- 2,308,396. THE HORSE THAT LIVES IN YOUR HEART. INT. CL. 41. REG. 1-18-2000.
- 2,308,397. G AND DESIGN. INT. CL. 9. REG. 1-18-2000.
- 2,308,400. METRODE. INT. CL. 9. REG. 1-18-2000.
- 2,308,401. MASTER FINANCIAL INCORPORATED AND DESIGN. INT. CL. 36. REG. 1-18-2000.
- 2,308,402. INTERNETIVITY. INT. CL. 9. REG. 1-18-2000.
- 2,308,403. DBPROBE. INT. CL. 9. REG. 1-18-2000.
- 2,308,404. JETSTREAM. INT. CL. 9. REG. 1-18-2000.
- 2,308,405. P AND DESIGN. INT. CL. 9. REG. 1-18-2000.
- 2,308,415. AMERICAN ASSOCIATION OF HEALTH PLANS AND DESIGN. INT. CLS. 41 AND 42. REG. 1-18-2000.
- 2,308,417. BEST MAID COOKIE COMPANY AND DESIGN. INT. CL. 35. REG. 1-18-2000.
- 2,308,420. COYOTE (STYLIZED). INT. CL. 9. REG. 1-18-2000.
- 2,308,421. CYCLONE NEWSROUTER (STYLIZED). INT. CL. 9. REG. 1-18-2000.
- 2,308,423. FORSEON (STYLIZED). INT. CL. 9. REG. 1-18-2000.

- 2,308,425. EROL'S STORE. INT. CLS. 16, 35 AND 38. REG. 1-18-2000.
- 2,308,427. THERE'S A LITTLE KANSAS CITY IN ALL OF US. INT. CL. 39. REG. 1-18-2000.
- 2,308,428. FLYCODEC. INT. CL. 9. REG. 1-18-2000.
- 2,308,431. MEETINGNET AND DESIGN. INT. CL. 9. REG. 1-18-2000.
- 2,308,432. RMRS AND DESIGN. INT. CLS. 35, 37, 40 AND 42. REG. 1-18-2000.
- 2,308,433. MOOD SWING (STYLIZED). INT. CL. 9. REG. 1-18-2000.
- 2,308,435. TAU (STYLIZED). INT. CL. 19. REG. 1-18-2000.
- 2,308,436. HIGHWIND SOFTWARE. INT. CL. 9. REG. 1-18-2000.
- 2,308,437. THE ESSENCE OF NATURE CANDLE COLLECTION (STYLIZED). INT. CL. 4. REG. 1-18-2000.
- 2,308,438. AIRF/X. INT. CLS. 9 AND 41. REG. 1-18-2000.
- 2,308,439. CHANGING THE WAY THE WORLD SITS. INT. CL. 20. REG. 1-18-2000.
- 2,308,441. STAR PEOPLE. INT. CL. 9. REG. 1-18-2000.
- 2,308,443. NEW YORK NEW YORK LAS VEGAS AND DESIGN. INT. CL. 25. REG. 1-18-2000.
- 2,308,444. SELECT-IT. INT. CL. 9. REG. 1-18-2000.
- 2,308,445. P AND DESIGN. INT. CL. 9. REG. 1-18-2000.
- 2,308,446. TAEKWONDO 2000. INT. CL. 41. REG. 1-18-2000.
- 2,308,448. ENERGYTRAX. INT. CL. 42. REG. 1-18-2000.
- 2,308,452. EAR CONDITIONING AND DESIGN. INT. CLS. 9 AND 41. REG. 1-18-2000.
- 2,308,453. EAR CONDITIONING. INT. CLS. 9 AND 41. REG. 1-18-2000.
- 2,308,454. CAREVIEW. INT. CL. 9. REG. 1-18-2000.
- 2,308,457. BLUE RIBBON AND DESIGN. INT. CL. 29. REG. 1-18-2000.
- 2,308,459. MISCELLANEOUS DESIGN. INT. CL. 6. REG. 1-18-2000.
- 2,308,461. DA LINK WENT WEAR AND DESIGN. INT. CL. 25. REG. 1-18-2000.
- 2,308,463. LO ADVANTAGE ONLINE TACTICAL MARKETING. INT. CL. 9. REG. 1-18-2000.
- 2,308,464. SEE SYSTEMS. INT. CLS. 9 AND 35. REG. 1-18-2000.
- 2,308,465. BIG FOOT SOFT STEP GOLF SPIKES AND DESIGN. INT. CL. 25. REG. 1-18-2000.
- 2,308,466. THE ALTERNATIVE EDGE. INT. CLS. 19 AND 37. REG. 1-18-2000.
- 2,308,469. EISTOL. INT. CL. 30. REG. 1-18-2000.
- 2,308,471. POPPIN'S. INT. CL. 16. REG. 1-18-2000.
- 2,308,473. INNOVATIVE SYSTEMS FOR THE MANUFACTURED HOME. INT. CL. 19. REG. 1-18-2000.
- 2,308,476. BOW AND DESIGN. INT. CL. 41. REG. 1-18-2000.
- 2,308,477. SHERLOCK CURRENCY DETECTIVE. INT. CL. 9. REG. 1-18-2000.
- 2,308,478. FILMPROFIT (STYLIZED). INT. CL. 9. REG. 1-18-2000.
- 2,308,479. S THE STRAP SIGNATURE PLUS LTD. AND DESIGN. INT. CL. 18. REG. 1-18-2000.
- 2,308,481. DIRTY WATER'S WORST NIGHTMARE. INT. CL. 11. REG. 1-18-2000.
- 2,308,482. TOVEKO. INT. CL. 11. REG. 1-18-2000.
- 2,308,484. WAMBRAZE. INT. CL. 6. REG. 1-18-2000.
- 2,308,485. TXPRINT. INT. CL. 9. REG. 1-18-2000.
- 2,308,486. AMBIC BUILDING INSPECTION CONSULTANTS. INT. CL. 37. REG. 1-18-2000.
- 2,308,487. DURA-TECH. INT. CL. 7. REG. 1-18-2000.
- 2,308,488. NATIONAL WING OFF. INT. CL. 41. REG. 1-18-2000.
- 2,308,489. WE CAN DO THAT!. INT. CL. 9. REG. 1-18-2000.
- 2,308,494. EDD CHECKER. INT. CL. 9. REG. 1-18-2000.
- 2,308,496. CHARTSOURCE. INT. CL. 9. REG. 1-18-2000.
- 2,308,498. EDT CHECKER. INT. CL. 9. REG. 1-18-2000.
- 2,308,499. THE AUSTIN HOLT COMPANY. INT. CL. 35. REG. 1-18-2000.
- 2,308,500. DIESELTRONICS (STYLIZED). INT. CL. 41. REG. 1-18-2000.
- 2,308,501. MISCELLANEOUS DESIGN. INT. CL. 25. REG. 1-18-2000.
- 2,308,502. JIN KON AND DESIGN. INT. CL. 11. REG. 1-18-2000.
- 2,308,505. UPGRAGE. INT. CL. 9. REG. 1-18-2000.
- 2,308,510. ATTITUDE WATCH. INT. CL. 14. REG. 1-18-2000.
- 2,308,512. PICK A GAME UNIDESA MULTI-GAME TOUCH SCREEN AND DESIGN. INT. CL. 9. REG. 1-18-2000.
- 2,308,515. SICARO. INT. CLS. 9 AND 42. REG. 1-18-2000.
- 2,308,517. RASRAM. INT. CL. 42. REG. 1-18-2000.
- 2,308,524. CATCH THIS!. INT. CL. 25. REG. 1-18-2000.
- 2,308,526. DARFRESH. INT. CL. 7. REG. 1-18-2000.
- 2,308,530. FIVE STAR AND DESIGN. INT. CLS. 9 AND 35. REG. 1-18-2000.
- 2,308,531. FLOORPLAN. INT. CL. 9. REG. 1-18-2000.
- 2,308,532. STARLIGHT INTERNATIONAL. INT. CL. 35. REG. 1-18-2000.
- 2,308,536. HELLO AGAIN!. INT. CL. 41. REG. 1-18-2000.
- 2,308,538. MEN MEN'S ENTERTAINMENT NETWORK AND DESIGN. INT. CL. 41. REG. 1-18-2000.
- 2,308,541. MISCELLANEOUS DESIGN. INT. CL. 36. REG. 1-18-2000.
- 2,308,546. SURESTART. INT. CL. 41. REG. 1-18-2000.
- 2,308,548. SENSUS SOFTECH. INT. CL. 9. REG. 1-18-2000.
- 2,308,549. MAGNAFI AND DESIGN. INT. CL. 42. REG. 1-18-2000.
- 2,308,550. WHEN THE STATUS QUO IS NO LONGER AN OPTION. INT. CL. 35. REG. 1-18-2000.
- 2,308,552. THE BANC STOCK GROUP FUND AND DESIGN. INT. CL. 36. REG. 1-18-2000.
- 2,308,553. BANC STOCK FINANCIAL SERVICES AND DESIGN. INT. CL. 36. REG. 1-18-2000.
- 2,308,555. KAYNUS. INT. CL. 27. REG. 1-18-2000.
- 2,308,557. DEMO EXECUTIVE ROUNDTABLE. INT. CL. 35. REG. 1-18-2000.
- 2,308,558. JANE. INT. CL. 14. REG. 1-18-2000.
- 2,308,561. HARRIS BIOMEDICAL. INT. CL. 42. REG. 1-18-2000.
- 2,308,562. INSTY-BUILDING AND DESIGN. INT. CL. 19. REG. 1-18-2000.
- 2,308,563. QUADRAMED CORPORATION AND DESIGN. INT. CL. 9. REG. 1-18-2000.
- 2,308,566. KRAUTEK. INT. CLS. 9, 28, 41 AND 42. REG. 1-18-2000.
- 2,308,568. TEAM NOTRE DAME AND DESIGN. INT. CLS. 25 AND 41. REG. 1-18-2000.
- 2,308,569. LEWAN & ASSOCIATES OFFICE TECHNOLOGY. INT. CLS. 37 AND 42. REG. 1-18-2000.
- 2,308,572. NVG AND DESIGN. INT. CL. 12. REG. 1-18-2000.
- 2,308,573. CAFE FONDUTA. INT. CL. 42. REG. 1-18-2000.
- 2,308,574. SIN SIN. INT. CL. 14. REG. 1-18-2000.
- 2,308,575. SIN SIN. INT. CL. 18. REG. 1-18-2000.
- 2,308,576. ONCE UPON A TABLE. INT. CL. 42. REG. 1-18-2000.
- 2,308,577. TITLES UNLIMITED. INT. CL. 42. REG. 1-18-2000.
- 2,308,578. WWW.HPHOSP.ORG. INT. CL. 42. REG. 1-18-2000.
- 2,308,579. ALL OF THE PEOPLE ALL OF THE TIME. INT. CL. 41. REG. 1-18-2000.
- 2,308,580. ORR F.I.R.S.T. FACILITY INSPECTION REPORTING SYSTEM TECHNOLOGY 80034 79677 AND DESIGN. INT. CL. 9. REG. 1-18-2000.
- 2,308,582. RURAL ENERGY RESOURCES, L.L.C. AND DESIGN. INT. CL. 35. REG. 1-18-2000.
- 2,308,583. NAVION. INT. CLS. 12 AND 35. REG. 1-18-2000.
- 2,308,584. BRAND WALL. INT. CL. 20. REG. 1-18-2000.
- 2,308,591. M METROPOLITAN ENTERTAINMENT AND DESIGN. INT. CL. 41. REG. 1-18-2000.
- 2,308,592. ACT ADJACENT CHANNEL TECHNOLOGY AND DESIGN. INT. CL. 9. REG. 1-18-2000.
- 2,308,593. HR TODAY. INT. CL. 35. REG. 1-18-2000.
- 2,308,594. MAXCARE. INT. CL. 37. REG. 1-18-2000.
- 2,308,595. AUTO VALUE PROFESSIONAL REPAIR NETWORK AND DESIGN. INT. CL. 35. REG. 1-18-2000.
- 2,308,596. PARTS MASTER THE ULTIMATE REPLACEMENT PARTS ULTRA AND DESIGN. INT. CL. 7. REG. 1-18-2000.
- 2,308,597. 1-800-FAIRCALL. INT. CL. 38. REG. 1-18-2000.
- 2,308,598. AUTO VALUE PROFESSIONAL REPAIR NETWORK. INT. CL. 35. REG. 1-18-2000.

- 2,308,599. LADIES WHO LUNCH. INT. CL. 21. REG. 1-18-2000.
- 2,308,600. WHOLESOY. INT. CL. 29. REG. 1-18-2000.
- 2,308,601. TOPICS IN MEDICINE AND DESIGN. INT. CL. 41. REG. 1-18-2000.
- 2,308,605. SALCICCIA. INT. CL. 42. REG. 1-18-2000.
- 2,308,607. ROCK&ROLL.COM (STYLIZED). INT. CL. 35. REG. 1-18-2000.
- 2,308,609. KEY CONSUMER FINANCE. INT. CL. 36. REG. 1-18-2000.
- 2,308,611. COAST TO COAST GOLD. INT. CL. 41. REG. 1-18-2000.
- 2,308,614. THE NUTRITION PROCLAIMER. INT. CL. 9. REG. 1-18-2000.
- 2,308,615. HOLOPOD. INT. CL. 9. REG. 1-18-2000.
- 2,308,616. OPENTEACH. INT. CL. 9. REG. 1-18-2000.
- 2,308,619. ZAP AND DESIGN. INT. CL. 40. REG. 1-18-2000.
- 2,308,621. DECISION STRATEGIES/FAIRFAX INTERNATIONAL. INT. CLS. 35, 36 AND 42. REG. 1-18-2000.
- 2,308,622. BUSINESS BY THE BOOK. INT. CL. 9. REG. 1-18-2000.
- 2,308,627. RELIABILITY THROUGH INNOVATION. INT. CL. 38. REG. 1-18-2000.
- 2,308,628. INSIDE-OUT APPROACH. INT. CL. 41. REG. 1-18-2000.
- 2,308,629. GUTTER GEAR. INT. CL. 25. REG. 1-18-2000.
- 2,308,630. PARMA JOHNNY'S. INT. CL. 29. REG. 1-18-2000.
- 2,308,631. MISCELLANEOUS DESIGN. INT. CL. 29. REG. 1-18-2000.
- 2,308,633. EXI EXCELLENCE AND INNOVATION IN SOFTWARE ENGINEERING (STYLIZED). INT. CL. 42. REG. 1-18-2000.
- 2,308,634. MISCELLANEOUS DESIGN. INT. CLS. 21 AND 25. REG. 1-18-2000.
- 2,308,636. COLORADO PEAKS. INT. CL. 16. REG. 1-18-2000.
- 2,308,640. TELEVANTAGE. INT. CL. 9. REG. 1-18-2000.
- 2,308,641. REALSCAN. INT. CL. 9. REG. 1-18-2000.
- 2,308,642. CRANGUARD. INT. CL. 5. REG. 1-18-2000.
- 2,308,643. CANTERBURY. INT. CL. 37. REG. 1-18-2000.
- 2,308,644. COMPUSCOPE. INT. CL. 9. REG. 1-18-2000.
- 2,308,645. PORTRAITS NOW. INT. CL. 42. REG. 1-18-2000.
- 2,308,647. POST WINSTED. INT. CL. 36. REG. 1-18-2000.
- 2,308,648. POST TOWNLAKE. INT. CL. 36. REG. 1-18-2000.
- 2,308,650. EVERYDAY ELEGANCE. INT. CL. 41. REG. 1-18-2000.
- 2,308,652. GRANDCOTE. INT. CL. 16. REG. 1-18-2000.
- 2,308,653. GRANDMATTE. INT. CL. 16. REG. 1-18-2000.
- 2,308,654. GRANDLITE. INT. CL. 16. REG. 1-18-2000.
- 2,308,655. OAG ONLINE. INT. CL. 42. REG. 1-18-2000.
- 2,308,660. DUREX. INT. CL. 19. REG. 1-18-2000.
- 2,308,661. NOWTRADE. INT. CL. 35. REG. 1-18-2000.
- 2,308,662. PRINTOVATION AND DESIGN. INT. CL. 42. REG. 1-18-2000.
- 2,308,664. PRIDE '98. INT. CL. 16. REG. 1-18-2000.
- 2,308,667. FIREWOOD. INT. CL. 28. REG. 1-18-2000.
- 2,308,669. THE NEIGHBORHOOD CLEANERS. INT. CL. 37. REG. 1-18-2000.
- 2,308,670. STARACER. INT. CL. 9. REG. 1-18-2000.
- 2,308,672. PLUMMER AND DESIGN. INT. CL. 39. REG. 1-18-2000.
- 2,308,673. BRAINCAMP. INT. CL. 41. REG. 1-18-2000.
- 2,308,674. JUST LET ME PLAY. INT. CL. 25. REG. 1-18-2000.
- 2,308,677. FREE AIR FESTIVAL. INT. CL. 41. REG. 1-18-2000.
- 2,308,679. PICK A TIME, ANYTIME . . . THE MOVIE'S ABOUT TO BEGIN.. INT. CL. 38. REG. 1-18-2000.
- 2,308,681. WILKINSON CHUTES. INT. CL. 7. REG. 1-18-2000.
- 2,308,682. E-Z GRIP FRICTION DROPS. INT. CL. 1. REG. 1-18-2000.
- 2,308,687. STRIKER. INT. CL. 7. REG. 1-18-2000.
- 2,308,689. VDI VIRTUAL DOCUMENT INVENTORY (STYLIZED). INT. CL. 42. REG. 1-18-2000.
- 2,308,690. VDI VIRTUAL DOCUMENT INVENTORY (STYLIZED). INT. CL. 35. REG. 1-18-2000.
- 2,308,692. LUSTRE CLEAN AND DESIGN. INT. CL. 3. REG. 1-18-2000.
- 2,308,695. DECOY MIGRATION AND DESIGN. INT. CL. 33. REG. 1-18-2000.
- 2,308,696. AQUA*PERL. INT. CL. 11. REG. 1-18-2000.
- 2,308,700. VANTAGE. INT. CL. 39. REG. 1-18-2000.
- 2,308,702. WILLIAM RAVEIS REAL ESTATE SERVICES. INT. CL. 36. REG. 1-18-2000.
- 2,308,705. WILLIAM RAVEIS THE INNOVATORS. INT. CL. 36. REG. 1-18-2000.
- 2,308,706. GREAT LAKES BANK AND DESIGN. INT. CL. 36. REG. 1-18-2000.
- 2,308,707. VANTAGE. INT. CL. 38. REG. 1-18-2000.
- 2,308,708. SECOND NATIONAL BANK OF WARREN (STYLIZED). INT. CL. 36. REG. 1-18-2000.
- 2,308,710. VISUALE. INT. CL. 20. REG. 1-18-2000.
- 2,308,711. SALESEEKER. INT. CL. 42. REG. 1-18-2000.
- 2,308,712. WIZARD WEAVE. INT. CL. 25. REG. 1-18-2000.
- 2,308,714. LOAN OFFICER PLUS. INT. CL. 9. REG. 1-18-2000.
- 2,308,721. GEG. INT. CL. 35. REG. 1-18-2000.
- 2,308,722. ANNUITY WORKS. INT. CL. 9. REG. 1-18-2000.
- 2,308,724. T-ZOID SURE. INT. CL. 28. REG. 1-18-2000.
- 2,308,725. INHOUSE AND DESIGN. INT. CL. 35. REG. 1-18-2000.
- 2,308,726. BIOFIT. INT. CL. 42. REG. 1-18-2000.
- 2,308,727. IMS PRODUCTS AND DESIGN. INT. CL. 35. REG. 1-18-2000.
- 2,308,728. REXER-PARKES. INT. CL. 35. REG. 1-18-2000.
- 2,308,729. BRAIN FINGERPRINTING. INT. CL. 42. REG. 1-18-2000.
- 2,308,732. THE MOMMIES. INT. CL. 41. REG. 1-18-2000.
- 2,308,734. MULTI-FLO. INT. CL. 7. REG. 1-18-2000.
- 2,308,736. CTS REEVES. INT. CL. 9. REG. 1-18-2000.
- 2,308,737. SRG ON-LINE. INT. CL. 42. REG. 1-18-2000.
- 2,308,738. MISCELLANEOUS DESIGN. INT. CLS. 38, 39 AND 42. REG. 1-18-2000.
- 2,308,744. MEMBER DESKTOP AND DESIGN. INT. CL. 35. REG. 1-18-2000.
- 2,308,745. READ ONLY DESKTOP AND DESIGN. INT. CL. 35. REG. 1-18-2000.
- 2,308,746. INTERPLAS MOLDING. INT. CL. 40. REG. 1-18-2000.
- 2,308,747. SELL AND SAVE DISCOUNT REALTY WE SAVE YOU MONEY AND DESIGN. INT. CL. 36. REG. 1-18-2000.
- 2,308,749. SMG SPORTSMEDICINE MANAGEMENT GROUP AND DESIGN. INT. CLS. 35 AND 42. REG. 1-18-2000.
- 2,308,752. DUNWELL'S STEAK HOUSE AND DESIGN. INT. CL. 42. REG. 1-18-2000.
- 2,308,753. TRANSCASTS. INT. CL. 42. REG. 1-18-2000.
- 2,308,755. JOINT-LOC (STYLIZED). INT. CL. 17. REG. 1-18-2000.
- 2,308,758. CRUSARIS. INT. CLS. 9, 12, 16 AND 37. REG. 1-18-2000.
- 2,308,759. DIGARCCO (STYLIZED). INT. CL. 9. REG. 1-18-2000.
- 2,308,763. CRESCENT MOON GALLERIES. INT. CL. 16. REG. 1-18-2000.
- 2,308,765. SKI STRATEGIC KNOWLEDGE INDICATOR AND DESIGN. INT. CL. 16. REG. 1-18-2000.
- 2,308,767. CARMEN RECORDS. INT. CL. 9. REG. 1-18-2000.
- 2,308,769. BIG EDDIE RECORDS. INT. CL. 9. REG. 1-18-2000.
- 2,308,776. ARS AUTOMATION RESEARCH SYSTEMS, LIMITED AND DESIGN. INT. CLS. 9, 16, 36 AND 38. REG. 1-18-2000.
- 2,308,777. REDBACK ORIGINAL AUSTRALIAN ALE. INT. CL. 32. REG. 1-18-2000.
- 2,308,778. BUST CHARACTER AND DESIGN. INT. CL. 36. REG. 1-18-2000.
- 2,308,780. AMERI PAINTERS AND DESIGN. INT. CL. 37. REG. 1-18-2000.
- 2,308,781. PETER PAR. INT. CL. 25. REG. 1-18-2000.
- 2,308,783. PREMIER FINISH. INT. CL. 19. REG. 1-18-2000.
- 2,308,786. OPEN PANTRY. INT. CL. 35. REG. 1-18-2000.

- 2,308,787. URBAN UMBRELLA AND DESIGN. INT. CL. 18. REG. 1-18-2000.
- 2,308,790. KUSTOMKIDS. INT. CL. 28. REG. 1-18-2000.
- 2,308,794. CR AND DESIGN. INT. CL. 35. REG. 1-18-2000.
- 2,308,795. LARGELY LITERARY. INT. CLS. 9, 16 AND 21. REG. 1-18-2000.
- 2,308,797. SLI (STYLIZED). INT. CL. 9. REG. 1-18-2000.
- 2,308,799. CAMAGI. INT. CL. 14. REG. 1-18-2000.
- 2,308,800. U.S.A. AND DESIGN. INT. CL. 28. REG. 1-18-2000.
- 2,308,801. SIDEKICK PROFESSIONAL AND DESIGN. INT. CLS. 6, 9, 13 AND 21. REG. 1-18-2000.
- 2,308,804. XANDROX. INT. CL. 5. REG. 1-18-2000.
- 2,308,807. EVAN-PICONE SPORT. INT. CL. 25. REG. 1-18-2000.
- 2,308,808. TELESELECT. INT. CL. 35. REG. 1-18-2000.
- 2,308,811. XOREX. INT. CL. 6. REG. 1-18-2000.
- 2,308,812. WORK WIZARD. INT. CL. 20. REG. 1-18-2000.
- 2,308,814. EXOTE. INT. CL. 39. REG. 1-18-2000.
- 2,308,815. UNIVERSAL ELITE. INT. CL. 36. REG. 1-18-2000.
- 2,308,816. CAPITAL COMMUNICATIONS INCORPORATED AND DESIGN. INT. CL. 16. REG. 1-18-2000.
- 2,308,817. MISCELLANEOUS DESIGN. INT. CL. 14. REG. 1-18-2000.
- 2,308,819. WOMEN WANT ME DEER FEAR ME. INT. CL. 25. REG. 1-18-2000.
- 2,308,823. THE REWARD STEP. INT. CL. 16. REG. 1-18-2000.
- 2,308,826. FIREWATER. INT. CL. 41. REG. 1-18-2000.
- 2,308,827. LJX. INT. CL. 42. REG. 1-18-2000.
- 2,308,828. MAGIC TOUCH. INT. CL. 20. REG. 1-18-2000.
- 2,308,831. PRIQETRAC (STYLIZED). INT. CL. 35. REG. 1-18-2000.
- 2,308,833. PIONEER WATERS. INT. CL. 32. REG. 1-18-2000.
- 2,308,836. IDAHO SNEAKERS. INT. CL. 41. REG. 1-18-2000.
- 2,308,837. CUSTARD & MUSTARD AND DESIGN. INT. CL. 25. REG. 1-18-2000.
- 2,308,838. FIT FLEX. INT. CL. 9. REG. 1-18-2000.
- 2,308,839. OPENBANK AND DESIGN. INT. CL. 36. REG. 1-18-2000.
- 2,308,840. SANS SOUCIE ART GLASS STUDIOS (STYLIZED). INT. CL. 35. REG. 1-18-2000.
- 2,308,841. FINE IMPRESSIONS. INT. CL. 20. REG. 1-18-2000.
- 2,308,843. SAVINGSPLUS. INT. CLS. 35, 37 AND 39. REG. 1-18-2000.
- 2,308,844. THE ART OF PATIENT TRANSFER (APT). INT. CL. 41. REG. 1-18-2000.
- 2,308,846. MISCELLANEOUS DESIGN. INT. CL. 35. REG. 1-18-2000.
- 2,308,847. THE MAKEUP ZONE AND DESIGN. INT. CL. 35. REG. 1-18-2000.
- 2,308,848. THE ALIEN ZONE AND DESIGN. INT. CL. 35. REG. 1-18-2000.
- 2,308,849. THE FRIGHT ZONE AND DESIGN. INT. CL. 35. REG. 1-18-2000.
- 2,308,850. TOI TOI. INT. CL. 42. REG. 1-18-2000.
- 2,308,851. THANK VAN GOGH IT'S FRIDAY. INT. CLS. 35, 41 AND 42. REG. 1-18-2000.
- 2,308,853. NEWS CORP ONE. INT. CL. 35. REG. 1-18-2000.
- 2,308,857. LIGHT YEARS AWAY INC.. INT. CL. 14. REG. 1-18-2000.
- 2,308,858. EON RECORDS. INT. CL. 9. REG. 1-18-2000.
- 2,308,863. MISCELLANEOUS DESIGN. INT. CL. 11. REG. 1-18-2000.
- 2,308,867. CARPETAVER. INT. CL. 20. REG. 1-18-2000.
- 2,308,868. FIRSTPLUS RACING #13 AND DESIGN. INT. CL. 34. REG. 1-18-2000.
- 2,308,869. FIRSTPLUS RACING #13 AND DESIGN. INT. CL. 20. REG. 1-18-2000.
- 2,308,871. INNOVANCE PAINCARE CENTERS AND DESIGN. INT. CL. 35. REG. 1-18-2000.
- 2,308,873. BACHATA. INT. CL. 25. REG. 1-18-2000.
- 2,308,881. POWER SHOT. INT. CL. 28. REG. 1-18-2000.
- 2,308,886. MISCELLANEOUS DESIGN. INT. CL. 42. REG. 1-18-2000.
- 2,308,887. G AND DESIGN. INT. CL. 7. REG. 1-18-2000.
- 2,308,896. MISCELLANEOUS DESIGN. INT. CL. 21. REG. 1-18-2000.
- 2,308,897. HOLOSTORE INSTANT STORES. INT. CL. 35. REG. 1-18-2000.
- 2,308,902. POTTER'S OPTICAL. INT. CL. 35. REG. 1-18-2000.
- 2,308,909. PERFORMA BY MAYTAG. INT. CLS. 7 AND 11. REG. 1-18-2000.
- 2,308,910. VARI-MAX. INT. CL. 11. REG. 1-18-2000.
- 2,308,914. ENERGY + TIME. INT. CL. 36. REG. 1-18-2000.
- 2,308,915. MISCELLANEOUS DESIGN. INT. CL. 42. REG. 1-18-2000.
- 2,308,919. BEST TOTAL SOLUTION TO EMPLOYEE RELOCATION NEEDS WORLDWIDE. INT. CL. 35. REG. 1-18-2000.
- 2,308,920. RECLAIM SERVICE TECHNOLOGIES, INC.. INT. CL. 37. REG. 1-18-2000.
- 2,308,922. ADVENTURES IN HOSPITALITY CAREERS. INT. CL. 35. REG. 1-18-2000.
- 2,308,924. PASSPORT TO PROFITS AND DESIGN. INT. CL. 35. REG. 1-18-2000.
- 2,308,925. H. BEAUGART DESIGNS AND DESIGN. INT. CL. 21. REG. 1-18-2000.
- 2,308,927. COUNTY CONCRETE. INT. CLS. 19 AND 35. REG. 1-18-2000.
- 2,308,929. GRATITUDE. INT. CL. 9. REG. 1-18-2000.
- 2,308,930. CAMERA MOVERS. INT. CL. 9. REG. 1-18-2000.
- 2,308,932. I MANAGE AND DESIGN. INT. CL. 9. REG. 1-18-2000.
- 2,308,933. PROWESS. INT. CL. 9. REG. 1-18-2000.
- 2,308,934. MISCELLANEOUS DESIGN. INT. CL. 37. REG. 1-18-2000.
- 2,308,938. S-CONTROLLER. INT. CL. 9. REG. 1-18-2000.
- 2,308,942. SENTRY. INT. CL. 7. REG. 1-18-2000.
- 2,308,944. DOC'S. INT. CL. 9. REG. 1-18-2000.
- 2,308,945. ROTARY INTERNATIONAL AND DESIGN. INT. CL. 18. REG. 1-18-2000.
- 2,308,950. DAZEKE' AND DESIGN. INT. CL. 25. REG. 1-18-2000.
- 2,308,954. ACTIVTOX. INT. CL. 5. REG. 1-18-2000.
- 2,308,956. MISCELLANEOUS DESIGN. INT. CL. 5. REG. 1-18-2000.
- 2,308,958. GDNS. INT. CL. 42. REG. 1-18-2000.
- 2,308,959. TRADESHOW BUTLER. INT. CL. 35. REG. 1-18-2000.
- 2,308,962. ATTRIBUTE MAPPING. INT. CLS. 1 AND 3. REG. 1-18-2000.
- 2,308,963. ATX POWERFAX BROADCAST. INT. CL. 38. REG. 1-18-2000.
- 2,308,966. IEI. INT. CL. 41. REG. 1-18-2000.
- 2,308,967. MISCELLANEOUS DESIGN. INT. CLS. 35 AND 42. REG. 1-18-2000.
- 2,308,968. JETRESOURCES. INT. CL. 42. REG. 1-18-2000.
- 2,308,970. CHEAP THRILL. INT. CL. 18. REG. 1-18-2000.
- 2,308,971. PRAIRIEWEB INTERNET MARKETING AND DESIGN. INT. CL. 35. REG. 1-18-2000.
- 2,308,972. CUSTOM FENCE AND DESIGN. INT. CL. 37. REG. 1-18-2000.
- 2,308,974. IT'S NOT THE SAME OLD BUSINESS. INT. CL. 42. REG. 1-18-2000.
- 2,308,976. STAR PERFORMER. INT. CL. 7. REG. 1-18-2000.
- 2,308,979. SARACEN. INT. CL. 20. REG. 1-18-2000.
- 2,308,984. FASHION PRO. INT. CL. 7. REG. 1-18-2000.
- 2,308,990. WOLVERINE REALTY AND DESIGN. INT. CL. 36. REG. 1-18-2000.
- 2,308,991. COLORMATE XXL. INT. CL. 24. REG. 1-18-2000.
- 2,308,992. MISCELLANEOUS DESIGN. INT. CL. 41. REG. 1-18-2000.
- 2,308,994. FIRSTCHECK PLUS. INT. CL. 36. REG. 1-18-2000.
- 2,308,996. HARDPOINTS. INT. CL. 20. REG. 1-18-2000.
- 2,308,998. TRIPSAVER. INT. CL. 8. REG. 1-18-2000.
- 2,308,999. EASYCBT. INT. CL. 9. REG. 1-18-2000.
- 2,309,000. TRIPLE BONDING RECONSTRUCTOR. INT. CL. 3. REG. 1-18-2000.
- 2,309,001. EZ PROCLAIMER. INT. CL. 9. REG. 1-18-2000.
- 2,309,003. AMERICASDOCTOR.COM AND DESIGN. INT. CL. 42. REG. 1-18-2000.
- 2,309,006. PAPERVAN. INT. CL. 38. REG. 1-18-2000.
- 2,309,007. MISCELLANEOUS DESIGN. INT. CL. 39. REG. 1-18-2000.
- 2,309,008. SITE CERTAIN. INT. CL. 42. REG. 1-18-2000.

- 2,309,009. ROCKETS AND DESIGN. INT. CL. 9. REG. 1-18-2000.
- 2,309,012. COLORISSIMO. INT. CL. 3. REG. 1-18-2000.
- 2,309,013. KYP AND DESIGN. INT. CL. 25. REG. 1-18-2000.
- 2,309,015. GROSSLOGY AND DESIGN. INT. CL. 9. REG. 1-18-2000.
- 2,309,018. YOUR TEAM BEHIND THE SCENE. INT. CL. 37. REG. 1-18-2000.
- 2,309,020. P.E. R. K.. INT. CLS. 9 AND 35. REG. 1-18-2000.
- 2,309,023. WWW.DLJDIRECT.COM. INT. CL. 36. REG. 1-18-2000.
- 2,309,025. 615 MUSIC LIBRARY: MUSIC & SOUND FOR OUR WORLD. INT. CL. 9. REG. 1-18-2000.
- 2,309,026. FLUID-FACTORS. INT. CL. 5. REG. 1-18-2000.
- 2,309,028. WHOLE BUSINESS. INT. CL. 35. REG. 1-18-2000.
- 2,309,030. SIZE WITH STYLE. INT. CL. 41. REG. 1-18-2000.
- 2,309,031. FESTINA. IT'S ABOUT TIME. INT. CL. 14. REG. 1-18-2000.
- 2,309,034. DELICATY (STYLIZED). INT. CLS. 29 AND 30. REG. 1-18-2000.
- 2,309,035. LOCKS-FER-LOCKS. INT. CL. 26. REG. 1-18-2000.
- 2,309,036. FOCUS ON LIVING. INT. CL. 16. REG. 1-18-2000.
- 2,309,037. VISION 180. INT. CL. 8. REG. 1-18-2000.
- 2,309,039. UNIVERSAL HOME CINEMAS. INT. CL. 41. REG. 1-18-2000.
- 2,309,043. TUDOR ROSE. INT. CL. 21. REG. 1-18-2000.
- 2,309,044. ELEVATIONS. INT. CL. 25. REG. 1-18-2000.
- 2,309,047. BODHI. INT. CL. 41. REG. 1-18-2000.
- 2,309,052. A AND DESIGN. INT. CL. 35. REG. 1-18-2000.
- 2,309,053. ENERGYTARGET. INT. CL. 9. REG. 1-18-2000.
- 2,309,054. DRAG'N WAG'N. INT. CL. 41. REG. 1-18-2000.
- 2,309,055. RISE JEANS. INT. CL. 25. REG. 1-18-2000.
- 2,309,057. BELLSOUTH BEYOND PROTECTION PLAN. INT. CL. 36. REG. 1-18-2000.
- 2,309,058. MEANT2BE. INT. CL. 41. REG. 1-18-2000.
- 2,309,059. MOTO-SOXX. INT. CL. 25. REG. 1-18-2000.
- 2,309,064. RHODES (STYLIZED). INT. CL. 35. REG. 1-18-2000.
- 2,309,069. MISCELLANEOUS DESIGN. INT. CL. 41. REG. 1-18-2000.
- 2,309,071. LUMPASUGAR. INT. CL. 25. REG. 1-18-2000.
- 2,309,072. ARCHER CONSULTING AND DESIGN. INT. CLS. 35 AND 41. REG. 1-18-2000.
- 2,309,074. WB DAY SPA AND DESIGN. INT. CL. 42. REG. 1-18-2000.
- 2,309,075. POOLSIDE. INT. CL. 9. REG. 1-18-2000.
- 2,309,077. POSSIBILITIES IN MOTION. INT. CL. 20. REG. 1-18-2000.
- 2,309,078. REVOLUTION MOTION. INT. CL. 20. REG. 1-18-2000.
- 2,309,080. SAFE FOR USE WITH METAL UTENSILS SCRATCH RESISTANT NONSTICK LIFETIME WARRANTY AND DESIGN. INT. CL. 21. REG. 1-18-2000.
- 2,309,081. MOLOKO PLUS. INT. CLS. 9 AND 41. REG. 1-18-2000.
- 2,309,083. MUTUALENNIUM. INT. CL. 36. REG. 1-18-2000.
- 2,309,084. GEAR (STYLIZED). INT. CL. 27. REG. 1-18-2000.
- 2,309,085. GEAR (STYLIZED). INT. CL. 21. REG. 1-18-2000.
- 2,309,086. FLAT BED. INT. CL. 12. REG. 1-18-2000.
- 2,309,087. BUY THE BALL!. INT. CL. 35. REG. 1-18-2000.
- 2,309,088. MAIL KING AND DESIGN. INT. CL. 9. REG. 1-18-2000.
- 2,309,090. TALLICIN. INT. CL. 1. REG. 1-18-2000.
- 2,309,091. RID-O-FOAM. INT. CL. 1. REG. 1-18-2000.
- 2,309,092. INNORES. INT. CL. 1. REG. 1-18-2000.
- 2,309,093. MUDSLINGER. INT. CL. 7. REG. 1-18-2000.
- 2,309,095. BIFIDUS-SELECT DF. INT. CL. 5. REG. 1-18-2000.
- 2,309,097. LAPSTAND. INT. CL. 9. REG. 1-18-2000.
- 2,309,100. ROADMASTER BICYCLES R AND DESIGN. INT. CL. 12. REG. 1-18-2000.
- 2,309,103. MYTYPEARTIST. INT. CL. 9. REG. 1-18-2000.
- 2,309,106. MISCELLANEOUS DESIGN. INT. CL. 20. REG. 1-18-2000.
- 2,309,107. BIGGER IS NOT BETTER BETTER...IS BETTER!. INT. CLS. 35 AND 37. REG. 1-18-2000.
- 2,309,108. AUTOWORKX AND DESIGN. INT. CL. 37. REG. 1-18-2000.
- 2,309,112. PENDRAGON. INT. CL. 35. REG. 1-18-2000.
- 2,309,114. NODESTER. INT. CL. 9. REG. 1-18-2000.
- 2,309,117. CUSTOMAXX. INT. CL. 35. REG. 1-18-2000.
- 2,309,119. ALL BUSINESS. INT. CL. 42. REG. 1-18-2000.
- 2,309,120. AS COMFORTABLE AS IT GETS.. INT. CL. 20. REG. 1-18-2000.
- 2,309,121. LIP BOMB (STYLIZED). INT. CL. 3. REG. 1-18-2000.
- 2,309,122. FASTPLANET TECHNOLOGIES. INT. CL. 42. REG. 1-18-2000.
- 2,309,125. TELECON-401. INT. CL. 9. REG. 1-18-2000.
- 2,309,126. KALKIT. INT. CL. 9. REG. 1-18-2000.
- 2,309,127. CRSR. INT. CL. 9. REG. 1-18-2000.
- 2,309,129. REMCAL. INT. CL. 9. REG. 1-18-2000.
- 2,309,130. RTMEDITOR. INT. CL. 9. REG. 1-18-2000.
- 2,309,131. RTMNAVIGATOR. INT. CL. 9. REG. 1-18-2000.
- 2,309,132. MENTISOFT. INT. CL. 9. REG. 1-18-2000.
- 2,309,133. CATER EASE. INT. CL. 9. REG. 1-18-2000.
- 2,309,134. CHEMSENSOR. INT. CL. 9. REG. 1-18-2000.
- 2,309,136. SOUTHWESTERN INFORMATION PUBLISHING. INT. CL. 16. REG. 1-18-2000.
- 2,309,137. CAERE. INT. CL. 9. REG. 1-18-2000.
- 2,309,140. MEDIASPEAK CHORUS. INT. CL. 9. REG. 1-18-2000.
- 2,309,141. BIOLOBA. INT. CL. 5. REG. 1-18-2000.
- 2,309,142. MENSTRELAX. INT. CL. 5. REG. 1-18-2000.
- 2,309,143. KRUGER TYPE PINA COLADA AND DESIGN. INT. CL. 33. REG. 1-18-2000.
- 2,309,145. MISCELLANEOUS DESIGN. INT. CL. 42. REG. 1-18-2000.
- 2,309,150. A AND DESIGN. INT. CL. 36. REG. 1-18-2000.
- 2,309,151. CHICAGO SPIRIT AWARD. INT. CL. 41. REG. 1-18-2000.
- 2,309,152. EPSTEIN BECKER GREEN AND DESIGN. INT. CLS. 35 AND 42. REG. 1-18-2000.
- 2,309,154. ZWITCH. INT. CL. 9. REG. 1-18-2000.
- 2,309,156. SNOW BALM. INT. CL. 5. REG. 1-18-2000.
- 2,309,159. FACE TRUTH AND CLARITY ON ALCOHOL. INT. CLS. 9 AND 16. REG. 1-18-2000.
- 2,309,160. IMPACT. INT. CL. 25. REG. 1-18-2000.
- 2,309,162. LUCKY STARR. INT. CL. 41. REG. 1-18-2000.
- 2,309,164. PINN PRO. INT. CL. 36. REG. 1-18-2000.
- 2,309,165. MISCELLANEOUS DESIGN. INT. CLS. 9 AND 41. REG. 1-18-2000.
- 2,309,169. MISCELLANEOUS DESIGN. INT. CL. 3. REG. 1-18-2000.
- 2,309,171. HUDSON CITY PAPER AND DESIGN. INT. CL. 35. REG. 1-18-2000.
- 2,309,174. THESIS (STYLIZED). INT. CL. 9. REG. 1-18-2000.
- 2,309,175. THE AUCTION EXCHANGE AND DESIGN. INT. CL. 16. REG. 1-18-2000.
- 2,309,181. GECKO ELECTRONICS. INT. CL. 9. REG. 1-18-2000.
- 2,309,182. AUTOACCESS. INT. CL. 35. REG. 1-18-2000.
- 2,309,183. GOMEZWIRE. INT. CL. 42. REG. 1-18-2000.
- 2,309,187. RAYSCAN. INT. CL. 9. REG. 1-18-2000.
- 2,309,191. SAMFIL. INT. CL. 1. REG. 1-18-2000.
- 2,309,192. MANAGING APPROPRIATE ANTIBIOTIC UTILIZATION AND DESIGN. INT. CLS. 41 AND 42. REG. 1-18-2000.
- 2,309,193. QUALITY OF LIFE PRODUCTS. INT. CL. 10. REG. 1-18-2000.
- 2,309,194. GIRLS OF THE INTERNET. INT. CL. 9. REG. 1-18-2000.
- 2,309,196. GAZZUT. INT. CL. 12. REG. 1-18-2000.
- 2,309,198. MARKETBEAT (STYLIZED). INT. CL. 9. REG. 1-18-2000.
- 2,309,200. OSSO SHAPING THE BODY FROM WITHIN AND DESIGN. INT. CL. 32. REG. 1-18-2000.
- 2,309,202. SINCERE TRUST AND BELIEF IN PEOPLE. INT. CLS. 9, 16 AND 41. REG. 1-18-2000.
- 2,309,203. AMERICAN IMAGE. INT. CL. 42. REG. 1-18-2000.
- 2,309,205. I-FILE. INT. CL. 9. REG. 1-18-2000.
- 2,309,206. MASTERPIX. INT. CL. 16. REG. 1-18-2000.
- 2,309,207. FOUREX. INT. CL. 10. REG. 1-18-2000.
- 2,309,208. SDS SIERRA DIMENSIONAL SOUND. INT. CL. 9. REG. 1-18-2000.
- 2,309,210. PRECISEEYE. INT. CL. 42. REG. 1-18-2000.

- 2,309,212. U.C.P. INT. CL. 9. REG. 1-18-2000.
 2,309,213. DCC SOLUTIONS. INT. CL. 42. REG. 1-18-2000.
 2,309,215. DRIVER ED IN A BOX AND DESIGN. INT. CL. 16. REG. 1-18-2000.
 2,309,216. A DAY IN THE GARDEN. INT. CLS. 25 AND 41. REG. 1-18-2000.
 2,309,218. I V (STYLIZED). INT. CL. 28. REG. 1-18-2000.
 2,309,219. SCREEN PLAY VIDEO. INT. CL. 41. REG. 1-18-2000.
 2,309,220. TC AND DESIGN. INT. CLS. 9 AND 16. REG. 1-18-2000.
 2,309,222. VITAL IMAGE. INT. CL. 5. REG. 1-18-2000.
 2,309,223. WORDWAND. INT. CL. 9. REG. 1-18-2000.
 2,309,225. FASTMOVE AND DESIGN. INT. CL. 36. REG. 1-18-2000.
 2,309,229. CSB. INT. CL. 19. REG. 1-18-2000.
 2,309,230. NAWAB. INT. CL. 42. REG. 1-18-2000.
 2,309,236. COPEASE. INT. CL. 9. REG. 1-18-2000.
 2,309,237. SHOPAROUND. INT. CL. 20. REG. 1-18-2000.
 2,309,238. TELEREP. INT. CL. 35. REG. 1-18-2000.
 2,309,242. FASTCRYPT. INT. CL. 9. REG. 1-18-2000.
 2,309,243. SUPERCRYPT. INT. CL. 9. REG. 1-18-2000.
 2,309,245. THE FASTEST WAY TO GET IT DONE RIGHT. INT. CL. 40. REG. 1-18-2000.
 2,309,246. ICC INTERNATIONAL RED ALERT THE FASTEST WAY TO GET IT DONE RIGHT AND DESIGN. INT. CL. 40. REG. 1-18-2000.
 2,309,248. LABEAUX (STYLIZED). INT. CL. 25. REG. 1-18-2000.
 2,309,249. ORBZYU. INT. CL. 38. REG. 1-18-2000.
 2,309,250. ZAAPA. INT. CL. 9. REG. 1-18-2000.
 2,309,251. PROTECTAIR. INT. CL. 9. REG. 1-18-2000.
 2,309,252. VAL-PAK PREFERRED. INT. CL. 35. REG. 1-18-2000.
 2,309,254. BAKED PITA-SNAX THE HEALTHY ALTERNATIVE BAKED, ORIGINAL STYLE LOW IN CALORIES AND DESIGN. INT. CL. 30. REG. 1-18-2000.
 2,309,255. XTRALITE. INT. CL. 9. REG. 1-18-2000.
 2,309,259. AT-205 RE-SEAL. INT. CL. 1. REG. 1-18-2000.
 2,309,261. TIM. INT. CL. 35. REG. 1-18-2000.
 2,309,263. ULTRASCOPE (STYLIZED). INT. CL. 10. REG. 1-18-2000.
 2,309,265. ARDMORE FARMS AND DESIGN. INT. CL. 32. REG. 1-18-2000.
 2,309,267. TIM. INT. CL. 40. REG. 1-18-2000.
 2,309,270. TODDLEROCK. INT. CL. 20. REG. 1-18-2000.
 2,309,272. WEB AND FLOW. INT. CL. 35. REG. 1-18-2000.
 2,309,275. RTE 6701. INT. CL. 9. REG. 1-18-2000.
 2,309,279. FREEWAY UNIVERSITY. INT. CL. 9. REG. 1-18-2000.
 2,309,281. CAPOLLA. INT. CL. 5. REG. 1-18-2000.
 2,309,283. P.OOKIE RECORDS AND DESIGN. INT. CL. 9. REG. 1-18-2000.
 2,309,286. OUR RATES ARE LOW. NOT OUR STANDARDS. INT. CL. 42. REG. 1-18-2000.
 2,309,291. RETIREMENT EDGE REAL ESTATE AND DESIGN. INT. CL. 36. REG. 1-18-2000.
 2,309,292. CELESTIAL TOUCH. INT. CL. 3. REG. 1-18-2000.
 2,309,294. VITTS. INT. CLS. 35, 38 AND 42. REG. 1-18-2000.
 2,309,295. VENTO-BOX. INT. CL. 6. REG. 1-18-2000.
 2,309,299. HOME OF THE UNCLE JACK'S STEAKHOUSE EST. 1996 UJ WORLD FAMOUS KOBE STEAK AND DESIGN. INT. CL. 42. REG. 1-18-2000.
 2,309,301. APPLEBEE'S THE NEIGHBORHOOD FAVORITE AND DESIGN. INT. CL. 30. REG. 1-18-2000.
 2,309,304. THE FRENCH SCHOOL. INT. CL. 16. REG. 1-18-2000.
 2,309,306. PROXIMA. INT. CL. 12. REG. 1-18-2000.
 2,309,307. MISCELLANEOUS DESIGN. INT. CL. 42. REG. 1-18-2000.
 2,309,308. CAFE EXPRESS AND DESIGN. INT. CL. 42. REG. 1-18-2000.
 2,309,309. GET IT OFF. INT. CL. 3. REG. 1-18-2000.
 2,309,310. PORE MANAGEMENT. INT. CL. 3. REG. 1-18-2000.
 2,309,311. BENEATH THE SURFACE. INT. CL. 3. REG. 1-18-2000.
 2,309,313. WHIPPED CLEAN. INT. CL. 3. REG. 1-18-2000.
 2,309,315. SCENTSATIONAIL. INT. CL. 3. REG. 1-18-2000.
 2,309,316. TOTAL LAUNDRY CARE GIVE US YOUR LAUNDRY... WE'LL GIVE YOU MORE TIME. INT. CL. 37. REG. 1-18-2000.
 2,309,322. BOATMAN'S. INT. CL. 42. REG. 1-18-2000.
 2,309,324. JUSTIN'S MEAT COMPANY. INT. CL. 29. REG. 1-18-2000.
 2,309,325. SQUEEZE THE DAY. INT. CL. 42. REG. 1-18-2000.
 2,309,326. MISCELLANEOUS DESIGN. INT. CL. 42. REG. 1-18-2000.
 2,309,328. SUPERIOR NATURAL SPRING WATER AND DESIGN. INT. CL. 32. REG. 1-18-2000.
 2,309,330. XYLEMETER. INT. CL. 16. REG. 1-18-2000.
 2,309,331. ENDUST. INT. CL. 16. REG. 1-18-2000.
 2,309,339. A.D.A.M. THE ATOMIC D.N.A. (ENHANCED) ACTUALIZED MAN AND DESIGN. INT. CL. 28. REG. 1-18-2000.
 2,309,340. AROUND THE WORLD IN 80 MINUTES. INT. CL. 38. REG. 1-18-2000.
 2,309,343. PAPER KNOWLEDGE. INT. CL. 16. REG. 1-18-2000.
 2,309,344. BUTTERFLIES & BLOSSOMS. INT. CL. 16. REG. 1-18-2000.
 2,309,347. HOMEMADE GOURMET BITE ME! BISCUITS THE BISCUIT YOUR DOG WILL WANNA BITE BACK ! AND DESIGN. INT. CL. 31. REG. 1-18-2000.
 2,309,348. DON'T MISS YOUR LIFE. INT. CL. 41. REG. 1-18-2000.
 2,309,350. THE TERMITE MAN. INT. CL. 37. REG. 1-18-2000.
 2,309,360. AVAIL. INT. CL. 3. REG. 1-18-2000.
 2,309,362. VALU BLUE AND DESIGN. INT. CL. 3. REG. 1-18-2000.
 2,309,366. THEY'RE CHOCOLATEY GR-R-REAT!. INT. CL. 30. REG. 1-18-2000.
 2,309,367. LOOP KOOSH. INT. CL. 28. REG. 1-18-2000.
 2,309,370. WINDROSE. INT. CL. 33. REG. 1-18-2000.
 2,309,371. MEDDLIN' MELON. INT. CL. 29. REG. 1-18-2000.
 2,309,374. MISCELLANEOUS DESIGN. INT. CL. 30. REG. 1-18-2000.
 2,309,375. MISCELLANEOUS DESIGN. INT. CL. 30. REG. 1-18-2000.
 2,309,376. MISCELLANEOUS DESIGN. INT. CL. 36. REG. 1-18-2000.
 2,309,379. FIBER-MAGIC. INT. CL. 16. REG. 1-18-2000.
 2,309,381. BRISTOL ALASKAN. INT. CL. 29. REG. 1-18-2000.
 2,309,383. FOSSIL LIZARD. INT. CL. 28. REG. 1-18-2000.
 2,309,386. QUES OLE!. INT. CL. 29. REG. 1-18-2000.
 2,309,387. ROLL RITE. INT. CL. 28. REG. 1-18-2000.
 2,309,388. JUSATIONS. INT. CL. 32. REG. 1-18-2000.
 2,309,395. THE SPEAKER SUPPORT SPECIALISTS. INT. CL. 41. REG. 1-18-2000.
 2,309,396. HF & B. INT. CL. 36. REG. 1-18-2000.
 2,309,397. FORTUNE CATCHERS!. INT. CL. 28. REG. 1-18-2000.
 2,309,398. A DIFFERENT STAR IN CYBERSPACE. INT. CL. 38. REG. 1-18-2000.
 2,309,399. JOHN'S GRILLIN' SAUCE. INT. CL. 30. REG. 1-18-2000.
 2,309,400. BUILDING YOUR BRANCH OFFICE IN CYBERSPACE. INT. CL. 38. REG. 1-18-2000.
 2,309,401. SHOWCARD. INT. CL. 28. REG. 1-18-2000.
 2,309,402. VISTAGRAPH. INT. CL. 16. REG. 1-18-2000.
 2,309,403. NUTRASURGE (STYLIZED). INT. CL. 1. REG. 1-18-2000.
 2,309,410. FAST N' FRESH TA TANIMURA & ANTLE AND DESIGN. INT. CL. 31. REG. 1-18-2000.
 2,309,411. UNLESS. INT. CL. 3. REG. 1-18-2000.
 2,309,412. TITLETEALES. INT. CL. 35. REG. 1-18-2000.
 2,309,416. MONGI'S CASUAL GOURMET. INT. CL. 29. REG. 1-18-2000.
 2,309,417. MISCELLANEOUS DESIGN. INT. CL. 30. REG. 1-18-2000.
 2,309,418. DIGITALEVIDENCE. INT. CL. 42. REG. 1-18-2000.
 2,309,419. THE CAVIAR OF PASTA. INT. CL. 30. REG. 1-18-2000.
 2,309,420. PARLAY. INT. CL. 16. REG. 1-18-2000.

- 2,309,422. IMAGECARE. INT. CL. 37. REG. 1-18-2000.
 2,309,423. VIBRA-FIN (STYLIZED). INT. CL. 28. REG. 1-18-2000.
 2,309,426. JUMBALL ONE. INT. CL. 28. REG. 1-18-2000.
 2,309,427. SUPERCYCLE. INT. CL. 17. REG. 1-18-2000.
 2,309,429. KOZY KETTLE. INT. CL. 42. REG. 1-18-2000.
 2,309,430. KOZY KETTLE AND DESIGN. INT. CL. 42. REG. 1-18-2000.
 2,309,435. IF YOU LOVE PIZZA, WE LOVE YOU. INT. CL. 30. REG. 1-18-2000.
 2,309,437. SYDNEY. INT. CL. 31. REG. 1-18-2000.
 2,309,439. SALAD TIME TANIMURA & ANTLE AND DESIGN. INT. CL. 29. REG. 1-18-2000.
 2,309,441. KARU SPRINGS. INT. CL. 3. REG. 1-18-2000.
 2,309,442. KOALA BOUQUET. INT. CL. 3. REG. 1-18-2000.
 2,309,443. DREAMTIME. INT. CL. 3. REG. 1-18-2000.
 2,309,445. I-MERCHANT AND DESIGN. INT. CL. 16. REG. 1-18-2000.
 2,309,446. VERSAMAX. INT. CL. 28. REG. 1-18-2000.
 2,309,447. TASTE FRESH FROM OUR KITCHEN. INT. CL. 29. REG. 1-18-2000.
 2,309,448. LIGHTPLAY AND DESIGN. INT. CL. 16. REG. 1-18-2000.
 2,309,453. PROFESSIONAL ANSWERS. PERSONAL SOLUTIONS. INT. CL. 35. REG. 1-18-2000.
 2,309,454. TRADITION. INT. CL. 3. REG. 1-18-2000.
 2,309,459. SANFER'S AND DESIGN. INT. CL. 30. REG. 1-18-2000.
 2,309,462. MISCELLANEOUS DESIGN. INT. CLS. 37 AND 42. REG. 1-18-2000.
 2,309,463. 3- GRAIN PASTA AND DESIGN. INT. CL. 30. REG. 1-18-2000.
 2,309,464. AIR CHEESE. INT. CL. 29. REG. 1-18-2000.
 2,309,467. WE'VE GOT HAPPY FOOD DOWN TO A T AND DESIGN. INT. CL. 30. REG. 1-18-2000.
 2,309,469. JUNGLE MEALS. INT. CL. 29. REG. 1-18-2000.
 2,309,471. "NOT TOO BIG OR TOO SMALL, THE RIGHT SIZE BANK FOR YOU!". INT. CL. 36. REG. 1-18-2000.
 2,309,473. SEEDS & REWARDS. INT. CL. 16. REG. 1-18-2000.
 2,309,478. TOMMY B'S. INT. CL. 30. REG. 1-18-2000.
 2,309,479. BROWN, TODD & HEYBURN PLLC AND DESIGN. INT. CL. 42. REG. 1-18-2000.
 2,309,480. CHOCOLATE SUMMIT. INT. CL. 30. REG. 1-18-2000.
 2,309,481. JERUSALEM. INT. CL. 9. REG. 1-18-2000.
 2,309,482. TASTE TEMPTATIONS. INT. CL. 30. REG. 1-18-2000.
 2,309,489. AMORE'. INT. CL. 21. REG. 1-18-2000.
 2,309,492. ADVANCED SYSTEMS WORLD. INT. CL. 42. REG. 1-18-2000.
 2,309,493. THE BIG BAG. INT. CLS. 9, 16 AND 41. REG. 1-18-2000.
 2,309,494. VELANET. INT. CLS. 17, 19, 22 AND 24. REG. 1-18-2000.
 2,309,497. KATY CRUISER. INT. CL. 12. REG. 1-18-2000.
 2,309,499. INVINCIBLE. INT. CL. 19. REG. 1-18-2000.
 2,309,501. NEW LATITUDES. INT. CLS. 35 AND 41. REG. 1-18-2000.
 2,309,502. GLOVETTS. INT. CL. 21. REG. 1-18-2000.
 2,309,503. BLUE JEANS. INT. CL. 32. REG. 1-18-2000.
 2,309,506. PRCA SIERRA CIRCUIT FINALS RODEO AND DESIGN. INT. CL. 25. REG. 1-18-2000.
 2,309,508. THIN MAN PILLOW TEE AND DESIGN. INT. CL. 24. REG. 1-18-2000.
 2,309,512. WISE INVESTOR. INT. CL. 9. REG. 1-18-2000.
 2,309,513. NPB (STYLIZED). INT. CL. 10. REG. 1-18-2000.
 2,309,515. ASPRO. INT. CLS. 7 AND 40. REG. 1-18-2000.
 2,309,519. YOUNGER IMAGE. INT. CL. 9. REG. 1-18-2000.
 2,309,520. MISCELLANEOUS DESIGN. INT. CL. 25. REG. 1-18-2000.
 2,309,522. SCHOOL OF AMERICAN BALLET. INT. CL. 25. REG. 1-18-2000.
 2,309,523. MISCELLANEOUS DESIGN. INT. CL. 9. REG. 1-18-2000.
 2,309,525. CREATIVE CONNECTION. INT. CL. 16. REG. 1-18-2000.
 2,309,527. WHERE NORTH MEETS SOUTH. INT. CL. 35. REG. 1-18-2000.
 2,309,530. CFO VISION. INT. CLS. 9 AND 16. REG. 1-18-2000.
 2,309,531. STICKER EXPRESS. INT. CL. 16. REG. 1-18-2000.
 2,309,532. SMART BOX. INT. CLS. 9, 12 AND 20. REG. 1-18-2000.
 2,309,533. ZOOMARANG. INT. CL. 28. REG. 1-18-2000.
 2,309,534. TRAVELCOM. INT. CL. 12. REG. 1-18-2000.
 2,309,535. THE COMPUTER INSIDE. INT. CL. 9. REG. 1-18-2000.
 2,309,536. DURASEAL. INT. CL. 16. REG. 1-18-2000.
 2,309,538. THE MENTOR. INT. CL. 9. REG. 1-18-2000.
 2,309,542. EZ-TRAINER. INT. CL. 16. REG. 1-18-2000.
 2,309,543. PLEASANTREES AND DESIGN. INT. CL. 16. REG. 1-18-2000.
 2,309,544. INSIDE SOFTWARE. INT. CL. 9. REG. 1-18-2000.
 2,309,545. TRAVEL TRADE CONFERENCES. INT. CLS. 16 AND 35. REG. 1-18-2000.
 2,309,546. ELECTRONIC COMMERCE SERVICES AND DESIGN. INT. CLS. 39 AND 42. REG. 1-18-2000.
 2,309,547. ACTSEMINARS. INT. CL. 41. REG. 1-18-2000.
 2,309,549. VERTEX. INT. CLS. 9 AND 40. REG. 1-18-2000.
 2,309,550. MISCELLANEOUS DESIGN. INT. CL. 16. REG. 1-18-2000.
 2,309,551. AXIOS. INT. CL. 16. REG. 1-18-2000.
 2,309,553. APACHE. INT. CL. 12. REG. 1-18-2000.
 2,309,555. SOY CLOTHING AND DESIGN. INT. CL. 25. REG. 1-18-2000.
 2,309,556. TOP OF THE MARK AND DESIGN. INT. CLS. 21 AND 25. REG. 1-18-2000.
 2,309,557. FRENCH TOAST. THE LEADER IN SCHOOL UNIFORMS. INT. CL. 25. REG. 1-18-2000.
 2,309,559. CONTROL ASSURANCE & RISK DESIGN MAP. INT. CLS. 9 AND 16. REG. 1-18-2000.
 2,309,560. JAZZ. INT. CL. 29. REG. 1-18-2000.
 2,309,562. THE VOID. INT. CL. 25. REG. 1-18-2000.
 2,309,563. TENAYA. INT. CL. 42. REG. 1-18-2000.
 2,309,564. TERAVIEW. INT. CL. 9. REG. 1-18-2000.
 2,309,565. KILPATRICK'S. INT. CL. 30. REG. 1-18-2000.
 2,309,568. THE COMPANY THAT REINVENTED THE TELEPHONE. INT. CL. 9. REG. 1-18-2000.
 2,309,569. BOOTLEG. INT. CL. 9. REG. 1-18-2000.
 2,309,570. SUBSTATION. INT. CL. 41. REG. 1-18-2000.
 2,309,571. FLARE. INT. CL. 9. REG. 1-18-2000.
 2,309,575. KELLOGG'S COCOA FROSTED FLAKES. INT. CL. 30. REG. 1-18-2000.
 2,309,576. PERSHING ASSET MANAGEMENT. INT. CL. 36. REG. 1-18-2000.
 2,309,577. MY TUNES. INT. CLS. 35 AND 41. REG. 1-18-2000.
 2,309,580. J&K JIE KANG AND DESIGN. INT. CL. 9. REG. 1-18-2000.
 2,309,583. FLUORRX. INT. CLS. 1 AND 5. REG. 1-18-2000.
 2,309,584. FOU D'ELLE. INT. CL. 3. REG. 1-18-2000.
 2,309,585. MERLIN. INT. CLS. 20 AND 37. REG. 1-18-2000.
 2,309,588. LIVEWIRE OPINIONS ONLINE AND DESIGN. INT. CL. 35. REG. 1-18-2000.
 2,309,589. MEDART. INT. CL. 10. REG. 1-18-2000.
 2,309,591. MISCELLANEOUS DESIGN. INT. CL. 35. REG. 1-18-2000.
 2,309,593. GENEVE SUPREME. INT. CL. 14. REG. 1-18-2000.
 2,309,595. COLLECT THE WEST. INT. CL. 35. REG. 1-18-2000.
 2,309,596. PRP. INT. CL. 42. REG. 1-18-2000.
 2,309,599. CORAL SL. INT. CL. 9. REG. 1-18-2000.
 2,309,600. IT LEDGER. INT. CL. 35. REG. 1-18-2000.
 2,309,601. TRAINER'S EDGE. INT. CL. 9. REG. 1-18-2000.
 2,309,604. PLASTIQUE. INT. CL. 9. REG. 1-18-2000.
 2,309,605. IMAGING 501. INT. CL. 16. REG. 1-18-2000.
 2,309,606. ENTERPRISE CAREERS. INT. CL. 16. REG. 1-18-2000.
 2,309,607. SHARE TRAX. INT. CL. 35. REG. 1-18-2000.
 2,309,608. IDEA QUEST. INT. CL. 42. REG. 1-18-2000.
 2,309,609. JTM. INT. CL. 9. REG. 1-18-2000.
 2,309,610. GUSTY. INT. CL. 31. REG. 1-18-2000.
 2,309,611. FABERGE. INT. CL. 8. REG. 1-18-2000.
 2,309,612. UN MUNDO POR DELANTE. INT. CL. 36. REG. 1-18-2000.
 2,309,614. PEELEX. INT. CLS. 6 AND 20. REG. 1-18-2000.

- 2,309,615. PARAPPA THE RAPPER. INT. CL. 9. REG. 1-18-2000.
- 2,309,618. STAT-ATTACK. INT. CL. 42. REG. 1-18-2000.
- 2,309,621. COUGAR CALL. INT. CL. 36. REG. 1-18-2000.
- 2,309,622. SYMPOSIUM. INT. CL. 20. REG. 1-18-2000.
- 2,309,623. MISCELLANEOUS DESIGN. INT. CL. 36. REG. 1-18-2000.
- 2,309,625. BRIER HILL. INT. CL. 39. REG. 1-18-2000.
- 2,309,627. CHICO AND DESIGN. INT. CL. 31. REG. 1-18-2000.
- 2,309,628. NIKKEI. INT. CL. 8. REG. 1-18-2000.
- 2,309,629. ACCUMOULD. INT. CL. 30. REG. 1-18-2000.
- 2,309,630. CROPCOMMANDER AND DESIGN. INT. CL. 7. REG. 1-18-2000.
- 2,309,631. HANDIMID. INT. CL. 9. REG. 1-18-2000.
- 2,309,632. CHAMPIONSHIP SPORTS. INT. CL. 28. REG. 1-18-2000.
- 2,309,633. IN MIND AND DESIGN. INT. CL. 36. REG. 1-18-2000.
- 2,309,634. STATION TO STATION TRAVEL. INT. CL. 39. REG. 1-18-2000.
- 2,309,636. CRAFTS ETC! AND DESIGN. INT. CL. 35. REG. 1-18-2000.
- 2,309,638. MEDROVER. INT. CL. 9. REG. 1-18-2000.
- 2,309,639. WHERE CRAFTING BEGINS. INT. CL. 35. REG. 1-18-2000.
- 2,309,640. FIRST UNION FINANCIAL WORKSHOP. INT. CL. 41. REG. 1-18-2000.
- 2,309,641. FORSAKEN. INT. CL. 9. REG. 1-18-2000.
- 2,309,643. SELKIRK: MONTANA GROWN ALL NATURAL ANGUS BEEF.. INT. CLS. 29 AND 31. REG. 1-18-2000.
- 2,309,644. SELKIRK MONTANA GROWN ALL NATURAL ANGUSBEEF AND DESIGN. INT. CLS. 29 AND 31. REG. 1-18-2000.
- 2,309,646. COOLXTRAS. INT. CL. 9. REG. 1-18-2000.
- 2,309,648. CONTINUUM. INT. CL. 16. REG. 1-18-2000.
- 2,309,651. SMARTDOG.ORG AND DESIGN. INT. CL. 35. REG. 1-18-2000.
- 2,309,654. COMFORT POCKETS. INT. CL. 20. REG. 1-18-2000.
- 2,309,655. DSIC. INT. CLS. 35, 37 AND 42. REG. 1-18-2000.
- 2,309,656. VISTO BRIEFCASE. INT. CL. 42. REG. 1-18-2000.
- 2,309,657. PROLOOK. INT. CL. 16. REG. 1-18-2000.
- 2,309,662. CONXION. INT. CLS. 38 AND 42. REG. 1-18-2000.
- 2,309,663. LAKAYE MEHNDI STUDIO. INT. CL. 3. REG. 1-18-2000.
- 2,309,664. FACE GEAR. INT. CL. 3. REG. 1-18-2000.
- 2,309,665. GLASS APPEAL. INT. CL. 9. REG. 1-18-2000.
- 2,309,667. SAVE YOUR LIFE. SAVE YOUR STOMACH.. INT. CL. 5. REG. 1-18-2000.
- 2,309,668. SALON AKS. INT. CL. 3. REG. 1-18-2000.
- 2,309,670. TORQUELAB. INT. CL. 9. REG. 1-18-2000.
- 2,309,673. DATASURGE. INT. CL. 9. REG. 1-18-2000.
- 2,309,674. BIBLIONET. INT. CL. 38. REG. 1-18-2000.
- 2,309,675. MULTIOLOGIC. INT. CL. 9. REG. 1-18-2000.
- 2,309,676. G.A.I.N.. INT. CL. 42. REG. 1-18-2000.
- 2,309,679. ULTIMATUM RECORDS. INT. CL. 41. REG. 1-18-2000.
- 2,309,680. DC DIABETES CONTROL NETWORK AND DESIGN. INT. CL. 16. REG. 1-18-2000.
- 2,309,681. PATHPOINT. INT. CL. 9. REG. 1-18-2000.
- 2,309,682. ASPERIX. INT. CLS. 3 AND 5. REG. 1-18-2000.
- 2,309,684. SALONSCAPE. INT. CL. 9. REG. 1-18-2000.
- 2,309,685. GOLF IS COOL. INT. CLS. 9 AND 28. REG. 1-18-2000.
- 2,309,689. MISCELLANEOUS DESIGN. INT. CL. 11. REG. 1-18-2000.
- 2,309,690. PECAN HOUSE GRILL AND DESIGN. INT. CL. 42. REG. 1-18-2000.
- 2,309,692. MISCELLANEOUS DESIGN. INT. CL. 35. REG. 1-18-2000.
- 2,309,693. OPTIMUM CRYSTAL COLOR. INT. CL. 3. REG. 1-18-2000.
- 2,309,695. GARDEN LATTICE. INT. CL. 20. REG. 1-18-2000.
- 2,309,696. MISCELLANEOUS DESIGN. INT. CL. 5. REG. 1-18-2000.
- 2,309,697. HOT WHEELS 30 YEARS 1968-1998 AND DESIGN. INT. CL. 28. REG. 1-18-2000.
- 2,309,701. ICE RAYS. INT. CL. 16. REG. 1-18-2000.
- 2,309,702. CANEVAS. INT. CL. 16. REG. 1-18-2000.
- 2,309,707. LIBERTYLINK. INT. CL. 36. REG. 1-18-2000.
- 2,309,708. FURNITURE ZONE. INT. CL. 35. REG. 1-18-2000.
- 2,309,713. KID - RIGHT. INT. CL. 27. REG. 1-18-2000.
- 2,309,716. SHOW THE WORLD YOU CARE. INT. CL. 16. REG. 1-18-2000.
- 2,309,718. COLOR SYSTEM BY GO ON. INT. CL. 25. REG. 1-18-2000.
- 2,309,720. BEAU-TEMPS. INT. CL. 3. REG. 1-18-2000.
- 2,309,721. MISCELLANEOUS DESIGN. INT. CL. 42. REG. 1-18-2000.
- 2,309,722. TUBIT. INT. CL. 28. REG. 1-18-2000.
- 2,309,724. KEY2ACH. INT. CL. 36. REG. 1-18-2000.
- 2,309,726. SPORTS VYBE. INT. CL. 41. REG. 1-18-2000.
- 2,309,727. WELLSNET INFORMATION EXPRESS. INT. CL. 36. REG. 1-18-2000.
- 2,309,728. MIXX TV. INT. CL. 41. REG. 1-18-2000.
- 2,309,729. ANARCHY EYEWEAR AND DESIGN. INT. CL. 9. REG. 1-18-2000.
- 2,309,730. CARETAKERITIS. INT. CL. 41. REG. 1-18-2000.
- 2,309,731. LOVE NEW ORLEANS. INT. CL. 42. REG. 1-18-2000.
- 2,309,733. THE ITEM CORNOLDI AND DESIGN. INT. CL. 25. REG. 1-18-2000.
- 2,309,735. ONSIGHT (STYLIZED). INT. CL. 39. REG. 1-18-2000.
- 2,309,736. MIGHTY MAC. INT. CL. 30. REG. 1-18-2000.
- 2,309,737. PANORAMA. INT. CL. 16. REG. 1-18-2000.
- 2,309,742. BLUES POINT. INT. CL. 33. REG. 1-18-2000.
- 2,309,743. TO BE GOOD AND DESIGN. INT. CL. 9. REG. 1-18-2000.
- 2,309,744. 2K AND DESIGN. INT. CL. 35. REG. 1-18-2000.
- 2,309,745. 2KNOW. INT. CL. 9. REG. 1-18-2000.
- 2,309,746. NETVERIFY (STYLIZED). INT. CL. 9. REG. 1-18-2000.
- 2,309,751. UNILINE. INT. CL. 7. REG. 1-18-2000.
- 2,309,752. GET PUMPED. INT. CL. 9. REG. 1-18-2000.
- 2,309,754. STEELWORKS. INT. CL. 25. REG. 1-18-2000.
- 2,309,755. WOOF.MEOW.WHATEVER.. INT. CL. 16. REG. 1-18-2000.
- 2,309,757. CYCLEBYNET. INT. CL. 42. REG. 1-18-2000.
- 2,309,762. MISCELLANEOUS DESIGN. INT. CL. 25. REG. 1-18-2000.
- 2,309,765. SHARP LABEL. INT. CL. 16. REG. 1-18-2000.
- 2,309,771. BOXBOARD CONTAINERS INTERNATIONAL. INT. CL. 16. REG. 1-18-2000.
- 2,309,773. P.A.. INT. CL. 9. REG. 1-18-2000.
- 2,309,774. DANCING FROG DESIGNS AND DESIGN. INT. CLS. 24 AND 25. REG. 1-18-2000.
- 2,309,775. GIL TECHNOLOGIES. INT. CL. 9. REG. 1-18-2000.
- 2,309,776. CANYON. INT. CL. 16. REG. 1-18-2000.
- 2,309,782. INDUSTRIAL STRENGTH. INT. CL. 9. REG. 1-18-2000.
- 2,309,783. PERFORMANCE 21. INT. CL. 9. REG. 1-18-2000.
- 2,309,784. MINUTEMAN. INT. CL. 31. REG. 1-18-2000.
- 2,309,785. REFERENTIA. INT. CL. 9. REG. 1-18-2000.
- 2,309,786. I/B/E/S ACTIVE EXPRESS. INT. CL. 9. REG. 1-18-2000.
- 2,309,787. PICOSERVER. INT. CL. 9. REG. 1-18-2000.
- 2,309,788. MULTIGRAB. INT. CL. 7. REG. 1-18-2000.
- 2,309,790. GLONET LOGISTICS RESOURCES. INT. CL. 42. REG. 1-18-2000.
- 2,309,791. THE CHEATING GOURMET. INT. CL. 16. REG. 1-18-2000.
- 2,309,793. MAKES BRUSHING FUN. INT. CL. 21. REG. 1-18-2000.
- 2,309,794. DAYBREAK THE BIG PICTURE. INT. CL. 9. REG. 1-18-2000.
- 2,309,797. THE BANKS THAT CARE. INT. CL. 36. REG. 1-18-2000.
- 2,309,799. SOPHISTICATED SOLUTIONS SIMPLY APPLIED. INT. CL. 42. REG. 1-18-2000.
- 2,309,804. ROTO. INT. CL. 9. REG. 1-18-2000.
- 2,309,805. WESTERN UNION RAPIDVOICE AND DESIGN. INT. CL. 38. REG. 1-18-2000.

- 2,309,809. VERMONT BIKE & SKI AND DESIGN. INT. CL. 35. REG. 1-18-2000.
- 2,309,814. COMMANDER CRUISE. INT. CL. 28. REG. 1-18-2000.
- 2,309,815. ORE-IDA FRESH. INT. CL. 31. REG. 1-18-2000.
- 2,309,820. LT. TORCH. INT. CL. 28. REG. 1-18-2000.
- 2,309,823. UNISITE AND DESIGN. INT. CLS. 36, 37 AND 42. REG. 1-18-2000.
- 2,309,824. P.R.E. STROKE. INT. CL. 28. REG. 1-18-2000.
- 2,309,826. LIVING MILESTONES VIDEOS. INT. CL. 42. REG. 1-18-2000.
- 2,309,828. THE ORIGINAL HERB FINDER'S TURKEY RHUBARB. INT. CL. 5. REG. 1-18-2000.
- 2,309,829. MACS III. INT. CL. 9. REG. 1-18-2000.
- 2,309,832. VOLUMETRICS MEDICAL IMAGING. INT. CL. 10. REG. 1-18-2000.
- 2,309,833. THE ORGANIZERS. INT. CL. 9. REG. 1-18-2000.
- 2,309,839. INTELLIDECK. INT. CL. 9. REG. 1-18-2000.
- 2,309,840. ALL STAR. INT. CL. 42. REG. 1-18-2000.
- 2,309,841. LUCKY SAV-ON AMERICAN REWARDS. INT. CL. 36. REG. 1-18-2000.
- 2,309,843. MISCELLANEOUS DESIGN. INT. CL. 28. REG. 1-18-2000.
- 2,309,844. GELTRAC. INT. CL. 28. REG. 1-18-2000.
- 2,309,845. MEGATOW. INT. CL. 12. REG. 1-18-2000.
- 2,309,848. ROADWING. INT. CL. 12. REG. 1-18-2000.
- 2,309,850. IN & OUT CASH. INT. CL. 36. REG. 1-18-2000.
- 2,309,852. BEYOND GREENS. INT. CL. 5. REG. 1-18-2000.
- 2,309,853. FLORIDA FOOD FOR FIFTY STATES. INT. CL. 30. REG. 1-18-2000.
- 2,309,855. GANAS. INT. CL. 41. REG. 1-18-2000.
- 2,309,858. EXPRESS-IT. INT. CL. 16. REG. 1-18-2000.
- 2,309,860. WORLDTONE. INT. CL. 9. REG. 1-18-2000.
- 2,309,861. FRONTIER COMMUNICATIONS AND DESIGN. INT. CL. 42. REG. 1-18-2000.
- 2,309,862. FRONTIER COMMUNICATIONS AND DESIGN. INT. CL. 16. REG. 1-18-2000.
- 2,309,865. KOOL AND DESIGN. INT. CL. 34. REG. 1-18-2000.
- 2,309,867. MAXISPRO. INT. CL. 21. REG. 1-18-2000.
- 2,309,868. GALAXY. INT. CL. 9. REG. 1-18-2000.
- 2,309,869. SPECTRA DIGITAL. INT. CL. 9. REG. 1-18-2000.
- 2,309,870. VERSACOOOL. INT. CL. 4. REG. 1-18-2000.
- 2,309,873. PHISH STICK. INT. CL. 30. REG. 1-18-2000.
- 2,309,875. TEAM LOSER AND DESIGN. INT. CL. 25. REG. 1-18-2000.
- 2,309,876. UNICAPITAL. INT. CL. 35. REG. 1-18-2000.
- 2,309,881. SMOGHOUSE. INT. CL. 9. REG. 1-18-2000.
- 2,309,882. BRING ME HOME AND LET'S PLAY TODAY. INT. CL. 28. REG. 1-18-2000.
- 2,309,884. JUSTADDCOMMERCE. INT. CL. 9. REG. 1-18-2000.
- 2,309,885. WATERCOOLER. INT. CL. 35. REG. 1-18-2000.
- 2,309,888. BAETIS. INT. CLS. 36 AND 41. REG. 1-18-2000.
- 2,309,890. MEDIA-FIX. INT. CL. 2. REG. 1-18-2000.
- 2,309,891. TEAM KOOL GREEN AND DESIGN. INT. CL. 16. REG. 1-18-2000.
- 2,309,894. PACKAGING PLUS. INT. CL. 16. REG. 1-18-2000.
- 2,309,895. VERIDICOM. INT. CL. 9. REG. 1-18-2000.
- 2,309,896. COW SAVER. INT. CL. 7. REG. 1-18-2000.
- 2,309,897. CITY ROCKS. INT. CL. 9. REG. 1-18-2000.
- 2,309,902. VERSE A TILES. INT. CL. 9. REG. 1-18-2000.
- 2,309,903. SECRETS OF THE UNIVERSE. INT. CL. 16. REG. 1-18-2000.
- 2,309,905. NUTRI-CAPTIV. INT. CL. 3. REG. 1-18-2000.
- 2,309,906. APERIO. INT. CL. 35. REG. 1-18-2000.
- 2,309,908. CENTER COURT. INT. CL. 20. REG. 1-18-2000.
- 2,309,909. ARC AND DESIGN. INT. CL. 38. REG. 1-18-2000.
- 2,309,912. GLOSSTONES (STYLIZED). INT. CL. 3. REG. 1-18-2000.
- 2,309,914. UNITHERM. INT. CL. 9. REG. 1-18-2000.
- 2,309,916. MATADOR PHONECARD. INT. CL. 16. REG. 1-18-2000.
- 2,309,919. THE BASEBALL CARD. AND DESIGN. INT. CLS. 35 AND 36. REG. 1-18-2000.
- 2,309,920. ESSENTIA. INT. CL. 16. REG. 1-18-2000.
- 2,309,922. RAISING COMFORT TO A NEW DIMENSION. INT. CL. 20. REG. 1-18-2000.
- 2,309,924. ENDLESS SHIMMER AND DESIGN. INT. CL. 3. REG. 1-18-2000.
- 2,309,925. DINOLITES. INT. CL. 11. REG. 1-18-2000.
- 2,309,926. ASTRO AGENDA. INT. CL. 16. REG. 1-18-2000.
- 2,309,927. ROOT BEER RIOT. INT. CL. 32. REG. 1-18-2000.
- 2,309,929. DARWIN'S PATH. INT. CL. 33. REG. 1-18-2000.
- 2,309,930. SUPAROSSA RISTORANTE ITALIANO & PIZZERIA EST. 1957 AND DESIGN. INT. CL. 30. REG. 1-18-2000.
- 2,309,931. ADDITUDE THE HAPPY, HEALTHY LIFESTYLE MAGAZINE FOR PEOPLE WITH ADD AND DESIGN. INT. CL. 16. REG. 1-18-2000.
- 2,309,933. WHERE EVERYTHING'S COOKING. INT. CL. 35. REG. 1-18-2000.
- 2,309,934. VISION METALS. INT. CLS. 6 AND 40. REG. 1-18-2000.
- 2,309,936. SLIMLINE. INT. CL. 33. REG. 1-18-2000.
- 2,309,938. HP SELECT EXPRESS. INT. CL. 39. REG. 1-18-2000.
- 2,309,939. MUMM CUVÉE NAPA 21ST CENTURY CUVÉE AND DESIGN. INT. CL. 33. REG. 1-18-2000.
- 2,309,940. MUMM CUVÉE SPECIALE Y2K MUMM AND DESIGN. INT. CL. 33. REG. 1-18-2000.
- 2,309,941. COSMOS CONQUEROR. INT. CL. 28. REG. 1-18-2000.
- 2,309,942. PEEL IT AND DESIGN. INT. CL. 3. REG. 1-18-2000.
- 2,309,943. NU-SAFE C&D. INT. CL. 3. REG. 1-18-2000.
- 2,309,945. TRUE SHOTS. INT. CL. 28. REG. 1-18-2000.
- 2,309,946. RESTORE 4 AND DESIGN. INT. CL. 3. REG. 1-18-2000.
- 2,309,948. 2000 AND DESIGN. INT. CL. 14. REG. 1-18-2000.
- 2,309,953. EXECUTIVE ONE. INT. CL. 38. REG. 1-18-2000.
- 2,309,954. WATERCOLOURS FOR THE ART OF BATHING. INT. CL. 3. REG. 1-18-2000.
- 2,309,955. CINNA'WICH (STYLIZED). INT. CL. 30. REG. 1-18-2000.
- 2,309,957. SPOTFIRE DISCOVERY SERVER. INT. CL. 9. REG. 1-18-2000.
- 2,309,962. BUST A NUT. INT. CL. 30. REG. 1-18-2000.
- 2,309,964. THE COLOR OF BEAUTY. INT. CL. 3. REG. 1-18-2000.
- 2,309,965. CUSHIONTON. INT. CL. 20. REG. 1-18-2000.
- 2,309,968. SLIM JIM. INT. CL. 28. REG. 1-18-2000.
- 2,309,972. BOX-A-GIFT. INT. CL. 16. REG. 1-18-2000.
- 2,309,974. RMEN (STYLIZED). INT. CL. 3. REG. 1-18-2000.
- 2,309,975. SOUTHERN LIVING VACATIONS. INT. CL. 16. REG. 1-18-2000.
- 2,309,977. TENDADYNE. INT. CLS. 7 AND 29. REG. 1-18-2000.
- 2,309,978. SPECTAPIX. INT. CL. 9. REG. 1-18-2000.
- 2,309,980. HAIRSPRAY. INT. CL. 18. REG. 1-18-2000.
- 2,309,981. MISCELLANEOUS DESIGN. INT. CL. 9. REG. 1-18-2000.
- 2,309,982. NASCAR AND DESIGN. INT. CLS. 1, 4, 9 AND 12. REG. 1-18-2000.
- 2,309,983. SOLUS. INT. CL. 9. REG. 1-18-2000.
- 2,309,985. PRIME TIME COUNTRY. INT. CL. 41. REG. 1-18-2000.
- 2,309,987. TARKHUNA. INT. CL. 33. REG. 1-18-2000.
- 2,309,991. ADVISOR PRACTICES. INT. CL. 16. REG. 1-18-2000.
- 2,309,995. TIMED-RELEASE GLUCOSE BAR. INT. CL. 5. REG. 1-18-2000.
- 2,309,996. PARENTING PACKS. INT. CL. 16. REG. 1-18-2000.
- 2,309,997. BITE ME. INT. CL. 16. REG. 1-18-2000.
- 2,310,001. BLACKFOOT. INT. CL. 25. REG. 1-18-2000.
- 2,310,003. KEYLOC AND DESIGN. INT. CL. 6. REG. 1-18-2000.
- 2,310,005. SELECT ACCESS. INT. CL. 36. REG. 1-18-2000.
- 2,310,010. WATER SOUNDS. INT. CL. 11. REG. 1-18-2000.
- 2,310,012. OSHKOSH HUMIDOR. INT. CL. 34. REG. 1-18-2000.
- 2,310,013. LITTLE TAB. INT. CL. 16. REG. 1-18-2000.
- 2,310,018. GERM GEL. INT. CL. 5. REG. 1-18-2000.
- 2,310,019. CASH FAST. INT. CL. 36. REG. 1-18-2000.
- 2,310,021. MOTOR & SENSORY NEUROPATHY EVALUATR. INT. CL. 42. REG. 1-18-2000.

- 2,310,022. ENVIRONMENTAL LIQUID DISH SOAP. INT. CL. 3. REG. 1-18-2000.
- 2,310,023. ANTISEPTIC HERBAL HAND CLEANER. INT. CL. 3. REG. 1-18-2000.
- 2,310,024. VALUATION 2000 (STYLIZED). INT. CL. 41. REG. 1-18-2000.
- 2,310,025. LAND AND WATER TOYS. INT. CL. 28. REG. 1-18-2000.
- 2,310,027. ADVANCED CLEARING, INC.. INT. CL. 36. REG. 1-18-2000.
- 2,310,031. BRANDS FOR LESS. INT. CL. 35. REG. 1-18-2000.
- 2,310,032. AIR TREKS. INT. CL. 39. REG. 1-18-2000.
- 2,310,035. MAGIL CONSTRUCTION. INT. CL. 37. REG. 1-18-2000.
- 2,310,036. HALF/PINTS. INT. CL. 29. REG. 1-18-2000.
- 2,310,037. ATM WATCH. INT. CL. 9. REG. 1-18-2000.
- 2,310,038. USA US APPRAISAL INCORPORATED. INT. CL. 36. REG. 1-18-2000.
- 2,310,039. GLO PUZZLE. INT. CL. 28. REG. 1-18-2000.
- 2,310,040. TILE WAREHOUSE. INT. CL. 35. REG. 1-18-2000.
- 2,310,041. 440A FINE. INT. CL. 8. REG. 1-18-2000.
- 2,310,042. CHICAGO CARD COMPANY. INT. CL. 42. REG. 1-18-2000.
- 2,310,043. CHICAGO CARD COMPANY AND DESIGN. INT. CL. 42. REG. 1-18-2000.
- 2,310,045. FARM WAREHOUSE. INT. CL. 35. REG. 1-18-2000.
- 2,310,046. TRAVELSUPPLIES.COM. INT. CL. 35. REG. 1-18-2000.
- 2,310,047. FOS DAILY. INT. CL. 5. REG. 1-18-2000.
- 2,310,049. ENGEL BROTHERS MEDIA. INT. CL. 9. REG. 1-18-2000.
- 2,310,053. BACKSTORY. INT. CL. 41. REG. 1-18-2000.
- 2,310,054. BRADENTON.COM. INT. CL. 42. REG. 1-18-2000.
- 2,310,056. TRYON CENTER FOR VISUAL ART. INT. CLS. 41 AND 42. REG. 1-18-2000.
- 2,310,057. DESIGNER ROOMS. INT. CL. 35. REG. 1-18-2000.
- 2,310,062. DR. WOLFF. INT. CL. 28. REG. 1-18-2000.
- 2,310,064. SLURRY FRACTURE INJECTION. INT. CL. 37. REG. 1-18-2000.
- 2,310,065. DOMAINE DES VALERY. INT. CL. 33. REG. 1-18-2000.
- 2,310,066. ANALYTICAL TECHNOLOGY. INT. CL. 35. REG. 1-18-2000.
- 2,310,068. USA UNIVERSITY MANAGEMENT SERVICES. INT. CL. 35. REG. 1-18-2000.
- 2,310,069. SMARTLENS. INT. CLS. 9 AND 10. REG. 1-18-2000.
- 2,310,070. SUPER ROADSTERS. INT. CL. 28. REG. 1-18-2000.
- 2,310,072. 401 KOMICS. INT. CL. 16. REG. 1-18-2000.
- 2,310,074. THE GODLY BUSINESS WOMAN. INT. CL. 16. REG. 1-18-2000.
- 2,310,075. THE CHESTERFIELDS. INT. CL. 41. REG. 1-18-2000.
- 2,310,076. CUSTOM SEED WIZARD. INT. CL. 42. REG. 1-18-2000.
- 2,310,077. CORPORATE ID. INT. CL. 35. REG. 1-18-2000.
- 2,310,078. DISCOUNT ATLANTA. INT. CLS. 16 AND 36. REG. 1-18-2000.
- 2,310,079. THE LEADERSHIP DIAGNOSTIC REVIEW. INT. CLS. 16 AND 42. REG. 1-18-2000.
- 2,310,080. THE BEAN BAG TEAM MASCOTS. INT. CL. 28. REG. 1-18-2000.
- 2,310,081. ST. GALLEN. INT. CL. 29. REG. 1-18-2000.
- 2,310,082. THE LARGEST NEWSPAPER FOR KIDS IN THE WORLD!. INT. CL. 16. REG. 1-18-2000.
- 2,310,085. INTERNET SEMINAR NETWORK. INT. CL. 41. REG. 1-18-2000.
- 2,310,086. FINE DIARY. INT. CL. 16. REG. 1-18-2000.
- 2,310,087. NEW YORK CITY MARKETING & PROMOTIONS. INT. CL. 35. REG. 1-18-2000.
- 2,310,089. LIQUIDITY. INT. CL. 3. REG. 1-18-2000.
- 2,310,091. MISCELLANEOUS DESIGN. INT. CL. 10. REG. 1-18-2000.
- 2,310,092. SCREENINGS AND SCREAMINGS. INT. CL. 16. REG. 1-18-2000.
- 2,310,093. RACE AGAINST HUNGER. INT. CL. 36. REG. 1-18-2000.
- 2,310,094. WOBBLE STOPPER. INT. CL. 20. REG. 1-18-2000.
- 2,310,095. JABBY TOONS UNIVERSAL EDUTAINMENT AND DESIGN. INT. CL. 25. REG. 1-18-2000.
- 2,310,098. RALEIGH DESIGNER'S RESOURCE. INT. CL. 42. REG. 1-18-2000.
- 2,310,100. FIBER EXCHANGE. INT. CL. 16. REG. 1-18-2000.
- 2,310,101. INTERNATIONAL WHO'S WHO OF INFORMATION TECHNOLOGY. INT. CL. 16. REG. 1-18-2000.
- 2,310,102. CHILD MAGAZINE KIDS' BOOK CLUB. INT. CL. 16. REG. 1-18-2000.
- 2,310,103. CHILD MAGAZINE MOM'S BOOK CLUB. INT. CL. 16. REG. 1-18-2000.
- 2,310,105. SPECIALLY SELECTED. INT. CL. 29. REG. 1-18-2000.
- 2,310,108. HOUSEHOLD INSPECTION TEAM, INC.. INT. CL. 42. REG. 1-18-2000.
- 2,310,110. BERENGER. INT. CL. 18. REG. 1-18-2000.
- 2,315,041. SCHUR. INT. CL. 1 ONLY. REG. 2-1-2000.
- 2,319,887. ANOTHER FINE QUALITY GEARBOX TOY AND DESIGN. INT. CL. 28. REG. 2-15-2000.
- 2,320,575. MISCELLANEOUS DESIGN. INT. CL. 16. REG. 2-22-2000.
- 2,324,368. FOOT-O-RINGS. INT. CL. 29 ONLY. REG. 2-29-2000.
- 2,331,982. WP WESTERN PLAINS DEVELOPMENT CORP. AND DESIGN. INT. CL. 37. REG. 3-21-2000.
- 2,344,448. HERACELL (STYLIZED). INT. CL. 11 ONLY. REG. 4-25-2000.
- 2,369,074. PENNCARD. INT. CL. 16 ONLY. REG. 7-18-2000.
- 2,377,345. BIOTREASURES AND DESIGN. INT. CL. 35 ONLY. REG. 8-15-2000.
- 2,381,046. KIMBERLY-CLARK. INT. CLS. 3 AND 24 ONLY. REG. 8-29-2000.
- 2,381,674. KT ESSENTIALS. INT. CL. 20 ONLY. REG. 8-29-2000.
- 2,383,505. KNAPP & TULLY NATURE COLLECTION. INT. CL. 20 ONLY. REG. 9-5-2000.
- 2,397,008. SOFT-WEAR. INT. CL. 20 ONLY. REG. 10-24-2000.
- 2,407,374. E (STYLIZED). INT. CL. 18 ONLY. REG. 11-21-2000.
- 2,415,772. MISCELLANEOUS DESIGN. INT. CL. 5 ONLY. REG. 12-26-2000.
- 2,460,421. ICEBERG VENTURES. INT. CL. 35 ONLY. REG. 6-12-2001.

SECTION 18

- 637,794. TOM MOORE AND DESIGN. U.S. CL. 45. REG. 11-27-1956.
- 1,362,667. WELLPET. INT. CL. 42. REG. 9-24-1985.
- 1,436,658. ADEXCHANGE. (STYLIZED). INT. CL. 35. REG. 4-14-1987.
- 1,453,157. CADENCE (STYLIZED). INT. CL. 14. REG. 8-18-1987.
- 1,563,957. THE JEWELRY VAULT (STYLIZED). INT. CL. 42. REG. 10-31-1989.
- 2,009,862. EAGLE POSTAL CENTERS. INT. CL. 39. REG. 10-22-1996.
- 2,009,863. EAGLE POSTAL CENTERS AND DESIGN. INT. CL. 39. REG. 10-22-1996.
- 2,224,173. BARE BONE. INT. CL. 9. REG. 2-16-1999.
- 2,324,698. E B AND DESIGN. INT. CLS. 9 AND 42. REG. 2-29-2000.
- 2,353,774. CLEARWATER. INT. CL. 36. REG. 5-30-2000.
- 2,384,570. SMARTSHIP. INT. CL. 42. REG. 9-12-2000.
- 2,389,913. CHEF WEAR WORLD. INT. CL. 35. REG. 9-26-2000.
- 2,426,685. TOTALCOVER AND DESIGN. INT. CL. 42. REG. 2-6-2001.
- 2,445,710. GFG GIBRALTAR FINANCIAL GROUP, INC. AND DESIGN. INT. CLS. 35, 36, 39, 40 AND 42. REG. 4-24-2001.

- 2,463,519. TOXISORB. INT. CL. 1. REG. 6-26-2001.
 2,498,597. TRINITY RECORDS. INT. CL. 9. REG. 10-16-2001.
 2,504,439. AFADVANTAGECARE (STYLIZED). INT. CL. 36.
 REG. 11-6-2001.
 2,548,519. PEST PATROL. INT. CL. 9. REG. 3-12-2002.
 2,569,269. WEBFS.COM AND DESIGN. INT. CL. 39. REG. 5-
 14-2002.
 2,587,343. WEBFS.COM. INT. CL. 39. REG. 7-2-2002.
 2,601,880. MJDESIGNS CRAFTS, HOBBIES & HOME AND
 DESIGN. INT. CL. 35. REG. 7-30-2002.
 2,670,642. CAPPELLI. INT. CLS. 18 AND 25. REG. 12-31-2002.
 2,862,021. THE ULTIMATE SHOPPING RESORT. INT. CLS.
 35 AND 36. REG. 7-13-2004.
 2,874,628. ESSENTIAL MEDICAL SUPPLY, INC. AND DE-
 SIGN. INT. CL. 35. REG. 8-17-2004.
 2,888,987. REDNECK COUNTRY CLUB ORIGINALS. INT.
 CL. 25. REG. 9-28-2004.
 2,890,144. SACHA REPORT. INT. CL. 25. REG. 9-28-2004.
 2,894,193. DIAMOND ELITE PARTNER PROGRAM AND
 DESIGN. INT. CL. 39. REG. 10-19-2004.
 2,905,432. PRINCESS CHARLOTTE. INT. CL. 25. REG. 11-30-
 2004.
 2,937,208. SWEET PEARL. INT. CL. 3. REG. 4-5-2005.
 3,003,993. ANGRY PENGUIN STANDARD CHARACTER
 MARK INT. CL. 41. REG. 10-4-2005.
 3,088,986. SAVON SUPERIOR STANDARD CHARACTER
 MARK INT. CL. 3. REG. 5-2-2006.
-
- 2,919,151. "RAMMYS" STANDARD CHARACTER MARK
 INT. CL. 41. REG. 1-18-2005. RESTORED TO
 SN 78-358,801.
 3,009,915. MISCELLANEOUS DESIGN. INT. CL. 37. REG.
 11-1-2005. RESTORED TO SN 76-461,479.
 3,081,065. DAYTONA (STYLIZED). INT. CL. 12. REG. 4-18-
 2006. RESTORED TO SN 75-734,320.
 3,087,135. COPPER RIVER RANCH STANDARD CHARAC-
 TER MARK INT. CL. 37. REG. 5-2-2006. RE-
 STORED TO SN 76-977,891.
 3,108,616. GP STANDARD CHARACTER MARK INT. CL.
 34. REG. 6-27-2006. RESTORED TO SN 78-
 349,657.
 3,116,752. CIRCULATE STANDARD CHARACTER MARK
 INT. CL. 5. REG. 7-18-2006. RESTORED TO SN
 78-637,878.
 3,119,250. BELL DINI STANDARD CHARACTER MARK
 INT. CL. 25. REG. 7-25-2006. RESTORED TO
 SN 78-488,591.
 3,123,145. SALES RESULTS, INC. STANDARD CHARAC-
 TER MARK INT. CL. 41. REG. 8-1-2006. RE-
 STORED TO SN 78-642,082.
 3,139,851. MAUI SURF COMPANY STANDARD CHARAC-
 TER MARK INT. CL. 25. REG. 9-5-2006. RE-
 STORED TO SN 78-364,795.
 3,141,980. LEGEND OF THE BO JO BO WISHING DOLL
 (STYLIZED). INT. CL. 28. REG. 9-12-2006. RE-
 STORED TO SN 78-732,233.
 3,145,601. POLYSTAT STANDARD CHARACTER MARK
 INT. CL. 17. REG. 9-19-2006. RESTORED TO
 SN 78-781,261.

**INADVERTENTLY ISSUED REGISTRATION
 NUMBERS**

- 2,904,436. MISCELLANEOUS DESIGN. INT. CL. 44. REG.
 11-23-2004. RESTORED TO SN 76-547,978.

* * * * *

TRADEMARK REGISTRATIONS AMENDED, CORRECTED, ETC.

The designation "U.S. Cl." appearing in this section refers to the U.S. class in effect prior to Sep. 1, 1973 rather than the international class which applies to applications filed on or after that date. For adoption of international classification see notice in the OFFICIAL GAZETTE of Jun. 26, 1973 (911 O.G. TM 210).

Any change to the registration will be indicated at the bottom of each entry under ELEMENTS AMENDED, CORRECTED OR RESTRICTED. With the exception of changes to the goods and services, additions to the registration will appear in asterisks and deletions of the registration will appear in brackets. Elements which are only changed will be listed with no punctuation. As to the goods/services statement, amendments to the goods/services will appear in asterisks and deletions will appear in brackets. In addition if any change to the goods/services occurs, the element "Goods/Services" will be listed under ELEMENTS AMENDED, CORRECTED OR RESTRICTED.

1,410,822. REG. 9-23-1986. STOKELY-VAN CAMP, INC. (INDIANA CORPORATION) QUAKER TOWER, 321 NORTH CLARK STREET, CHICAGO, IL, 60610, SN 73-578,744. FILED 1-21-1986. PRINCIPAL REGISTER.



OWNER OF U.S. REG. NOS. 848,245, 888,352 AND 1,030,972.

NO CLAIM IS MADE TO THE EXCLUSIVE RIGHT TO USE "THIRST QUENCHER", APART FROM THE MARK AS SHOWN.

INT. CL. 32/U.S. CL. 45

FOR THIRST QUENCHING SOFT DRINK AND POWDER FOR MAKING THE SAME.

FIRST USE 0-0-1973; IN COMMERCE 0-0-1973.

ELEMENTS AMENDED
MARK

FOR PROMOTING AND FACILITATING TISSUE BANKING AND FOR ACCREDITING TISSUE BANKS. FIRST USE 9-1-1984; IN COMMERCE 9-1-1984.

ELEMENTS AMENDED
MARK

1,645,683. REG. 5-21-1991. DEL CONTE-FOX, TONI (UNITED STATES INDIVIDUAL), DBA ONCE UPON A TIME, 5409 BUFFALO CT, ANTIOCH, CA, 94509, SN 74-040,318. FILED P.R. 3-20-1990; AM. S.R. 3-11-1991. SUPPLEMENTAL REGISTER.

POTTY TRAIN

INT. CL. 11/U.S. CL. 13

FOR CHILD'S TRAINING TOILET.

FIRST USE 3-2-1990; IN COMMERCE 3-2-1990.

ELEMENTS CORRECTED
OWNER NAME

1,579,600. REG. 1-23-1990. AMERICAN ASSOCIATION OF TISSUE BANKS (MARYLAND CORPORATION) 1320 OLD CHAIN BRIDGE ROAD, SUITE 450, MCLEAN, VA, 22101, SN 73-804,449. FILED 6-2-1989. PRINCIPAL REGISTER.

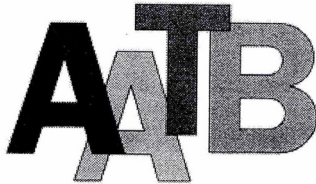

THE LINING IS A FEATURE OF THE MARK AND DOES NOT INDICATE COLOR.
INT. CL. 42/U.S. CL. 100

1,911,701. REG. 8-15-1995. FRESH INTELLECTUAL PROPERTIES INC. (DELAWARE CORPORATION) 103 FOULK ROAD, SUITE 202, WILMINGTON, DE, 19803, SN 74-474,796. FILED 12-30-1993. PRINCIPAL REGISTER.

JUST CALL OUR NAME

INT. CL. 35/U.S. CLS. 100, 101 AND 102

FOR RECEIVING ORDERS FOR FLOWERS AND FLORAL PRODUCTS AND TRANSMITTING THEM TO AND/OR CAUSING THEM TO BE FILLED BY PARTICIPATING * FLORISTS IN THE VICINITY OF THE RECIPIENT.

FIRST USE 11-6-1993; IN COMMERCE 11-6-1993.

ELEMENTS AMENDED
GOODS/SERVICES
ASSIGNMENT/NAME CHANGE
MARK

1,998,295. REG. 9-3-1996. FULLER BROS. INC. (OREGON CORPORATION) 11507 S.E. HWY. 212, P.O. BOX 280, CLACKAMAS, OR, 97015, SN 74-733,173. FILED 9-22-1995. PRINCIPAL REGISTER.

2,059,423. REG. 5-6-1997. ARES TRADING S.A. (SWITZERLAND CORPORATION) ZONE INDUSTRIELLE DE L'OURIETTAZ, CH-1170 AUBONNE, SWITZERLAND., SN 75-129,106. FILED 7-2-1996. PRINCIPAL REGISTER.

RIM LIFE

OWNER OF U.S. REG. NO. 1,141,454.
 NO CLAIM IS MADE TO THE EXCLUSIVE RIGHT TO USE "RIM", APART FROM THE MARK AS SHOWN.
 INT. CL. 1/U.S. CLS. 1
 FOR CHEMICAL COMPOSITION FOR DEPOSIT INSIDE TIRES TO INHIBIT AIR SEEPAGE.
 FIRST USE 1-10-1992; IN COMMERCE 1-10-1992.

ELEMENTS CORRECTED
 OWNER NAME

2,002,344. REG. 9-24-1996. KABUSHIKI KAISHA KAMINOMOTO HOMPO (JAPAN CORPORATION), DBA KAMINOMOTO CO., LTD., 3-25, 3-CHOME, KUMOCIBASHIDORI, CHUO-KU, KOBE-SHI, HYOGOKEN, JAPAN., SN 74-641,553. FILED 3-3-1995. PRINCIPAL REGISTER.

**KAMINO
 MOTO**

加美乃素

OWNER OF U.S. REG. NOS. 681,702, 1,006,802 AND 1,042,600.
 THE JAPANESE CHARACTERS IN THE MARK TRANSLITERATE TO "KAMINOTO"
 INT. CL. 3/U.S. CLS. 1, 4, 6, 50, 51 AND 52
 FOR HAIR AND SCALP CARE PREPARATIONS [AND SHAMPOO].
 FIRST USE 7-6-1976; IN COMMERCE 7-6-1976.

ELEMENTS AMENDED
 MARK

SERONO

THE MARK CONSISTS OF STANDARD CHARACTERS WITHOUT CLAIM TO ANY PARTICULAR FONT, STYLE, SIZE, OR COLOR.
 OWNER OF U.S. REG. NOS. 1,619,369, 1,805,748 AND OTHERS.
 INT. CL. 5/U.S. CLS. 6, 18, 44, 46, 51 AND 52
 FOR HOUSE MARK FOR A FULL LINE OF PHARMACEUTICAL PREPARATIONS FOR USE IN THE TREATMENT OF INFERTILITY AND/OR OVULATION INDUCTION, IMMUNOLOGY - [ONCOLOGY,] PEDIATRICS AND ENDOCRINOLOGY, AUTO IMMUNE DISEASES, GROWTH AND METABOLISM, DISEASES OF THE CENTRAL NERVOUS SYSTEM, CANCER, [CARDIOVASCULAR AND CIRCULATORY DISEASES,] VIRAL DISEASES, INFLAMMATORY AND [HEMATOLOGICAL DISORDERS, CALCIUM DISORDERS, ANTIVIRAL PREPARATIONS FOR OPHTHALMIC USE].
 FIRST USE 6-0-1976; IN COMMERCE 6-0-1976.

ELEMENTS AMENDED
 GOODS/SERVICES
 OWNER ADDRESS
 MARK

2,104,991. REG. 10-14-1997. CROSSTEX INTERNATIONAL, INC. (NEW YORK CORPORATION) 10 RANICK ROAD, HAUPPAUGE, NY, 11788, SN 75-132,497. FILED 7-11-1996. PRINCIPAL REGISTER.

SANI-ROLL

INT. CL. 10/U.S. CLS. 26, 39 AND 44
 FOR TUBES MADE OF PAPER AND/OR PLASTIC FOR THE PURPOSE OF STERILIZING MEDICAL INSTRUMENTS.
 FIRST USE 1-15-1990; IN COMMERCE 1-15-1990.

ELEMENTS CORRECTED
 OWNER NAME

2,110,530. REG. 11-4-1997. CROSSTEX INTERNATIONAL, INC. (NEW YORK CORPORATION) 10 RANICK ROAD, HAUPPAUGE, NY, 11788, SN 75-131,941. FILED 7-10-1996. PRINCIPAL REGISTER.

COMBO-TIP

INT. CL. 10/U.S. CLS. 26, 39 AND 44
 FOR DENTAL INSTRUMENTS, NAMELY, DISPOSABLE SOFT-TIP DENTAL EVACUATORS.
 FIRST USE 1-15-1991; IN COMMERCE 1-15-1991.

ELEMENTS CORRECTED
 OWNER NAME

NOV 28, 2006

U.S. PATENT AND TRADEMARK OFFICE

TM 1501

2,113,700. REG. 11-18-1997. CROSSTEX INTERNATIONAL, INC. (NEW YORK CORPORATION) 10 RANICK ROAD, HAUPPAUGE, NY, 11788, SN 75-132,494. FILED 7-11-1996. PRINCIPAL REGISTER.

HAPPYFEET

INT. CL. 16/U.S. CLS. 2, 5, 22, 23, 29, 37, 38 AND 50
FOR DISPOSABLE PODIATRY PATIENT TOWELS,
MADE OF PAPER.
FIRST USE 2-10-1995; IN COMMERCE 2-10-1995.

ELEMENTS CORRECTED
OWNER NAME

2,133,318. REG. 1-27-1998. CROSSTEX INTERNATIONAL, INC. (NEW YORK CORPORATION) 10 RANICK RD., HAUPPAUGE, NY, 11788, SN 75-126,896. FILED 6-28-1996. PRINCIPAL REGISTER.

MASKENOMICS

INT. CL. 10/U.S. CLS. 26, 39 AND 44
FOR DENTAL FACE MASKS.
FIRST USE 9-1-1996; IN COMMERCE 9-1-1996.

ELEMENTS CORRECTED
OWNER NAME

2,184,680. REG. 8-25-1998. FATA HUNTER, INC. (DELAWARE CORPORATION) 1040 IOWA AVENUE, RIVERSIDE, SUITE 100, CA, 92507, SN 75-148,644. FILED 8-12-1996. PRINCIPAL REGISTER.

SUPERCASTERPLUS

OWNER OF U.S. REG. NO. 1,459,827.
INT. CL. 7/U.S. CLS. 13, 19, 21, 23, 31, 34 AND 35
FOR METAL CASTING MACHINES.
FIRST USE 4-26-1998; IN COMMERCE 4-26-1998.

ELEMENTS CORRECTED
CITIZENSHIP

2,274,668. REG. 8-31-1999. SUN LIFE ASSURANCE COMPANY OF CANADA(US) (DELAWARE CORPORATION) ONE SUN LIFE EXECUTIVE PARK, WELLESLEY HILLS, MA, 02181, AND SUN LIFE ASSURANCE COMPANY (CANADA CORPORATION) 150 KING STREET WEST, SUITE 1400, TORONTO, CANADA, M5H 1J9, SN 74-322,798. FILED 10-16-1992. PRINCIPAL REGISTER.

SUN CAPITAL ADVISERS LLC.

OWNER OF U.S. REG. NO. 1,437,498.
NO CLAIM IS MADE TO THE EXCLUSIVE RIGHT TO
USE "CAPITAL ADVISERS LLC.", APART FROM THE
MARK AS SHOWN.
INT. CL. 36/U.S. CLS. 100, 101 AND 102

FOR [REAL ESTATE MANAGEMENT AND] INVESTMENT ADVISORY SERVICES.
FIRST USE 2-17-1998; IN COMMERCE 2-17-1998.

ELEMENTS AMENDED
MARK TYPE

2,283,077. REG. 10-5-1999. STARPLEX SCIENTIFIC INC. (CANADA CORPORATION) 50 STEINWAY BOULEVARD, ETOBICOKE, ONTARIO, CANADA, M9W 6Y3, SN 75-516,678. FILED 7-10-1998. PRINCIPAL REGISTER.

DIP N COUNT

SEC. 2(F).
INT. CL. 9/U.S. CLS. 21, 23, 26, 36 AND 38
FOR LABORATORY EQUIPMENT; NAMELY, A SLIDE AND CONTAINER FOR USE IN DETERMINING BACTERIA LEVELS IN URINE.
FIRST USE 10-2-1972; IN COMMERCE 4-25-1973.

ELEMENTS CORRECTED
OWNER NAME
OWNER ADDRESS
ENTITY

2,305,706. REG. 1-4-2000. USA RICE FEDERATION (TEXAS NON-PROFIT CORPORATION) 4301 N. FAIRFAX DRIVE, SUITE 425, ARLINGTON, VA, 22203, SN 75-530,298. FILED 8-4-1998. PRINCIPAL REGISTER.

USA RICE PRODUCERS' GROUP

NO CLAIM IS MADE TO THE EXCLUSIVE RIGHT TO
USE "GROUP", APART FROM THE MARK AS SHOWN.
SEC. 2(F).
INT. CL. 42/U.S. CLS. 100 AND 101
FOR ASSOCIATION SERVICES, NAMELY, PROMOTING THE INTERESTS OF RICE PRODUCERS IN THE PRODUCTION AND MARKETING OF RICE.
FIRST USE 2-0-1994; IN COMMERCE 2-0-1994.

ELEMENTS AMENDED
MARK

2,374,779. REG. 8-8-2000. SAFEHARBOR TECHNOLOGY CORPORATION (WASHINGTON CORPORATION) SATSOP DEVELOPMENT PARK, 150 TECHNOLOGY LANE BLDG. S-1, ELMA, WA, 98541, SN 75-672,224. FILED 3-31-1999. PRINCIPAL REGISTER.

SAFEHARBOR

INT. CL. 42/U.S. CLS. 100 AND 101

FOR TECHNICAL AND CUSTOMER SUPPORT SERVICES, NAMELY, TROUBLESHOOTING OF COMPUTER HARDWARE AND SOFTWARE PROBLEMS AND RESOLUTION OF CUSTOMER-RELATED ISSUES VIA THE GLOBAL COMPUTER NETWORK AND BY TELEPHONE.

FIRST USE 10-1-1998; IN COMMERCE 10-1-1998.

ELEMENTS AMENDED
MARK

2,385,617. REG. 9-12-2000. MASTER TEACHER, INC., THE (KANSAS CORPORATION) LEADERSHIP LANE, PO BOX 1207, MANHATTAN, KS. 665051207, SN 75-829,988. FILED 10-25-1999. PRINCIPAL REGISTER.

THE PROFESSOR IN THE CLASSROOM

INT. CL. 16/U.S. CLS. 2, 5, 22, 23, 29, 37, 38 AND 50
FOR PRINTED NEWSLETTERS FOR THE TEACHING PROFESSION TO ENHANCE CLASSROOM INSTRUCTION AND LEARNING AT THE COLLEGE AND UNIVERSITY LEVEL.

FIRST USE 9-0-1994; IN COMMERCE 9-0-1994.

ELEMENTS AMENDED
OWNER NAME

2,406,559. REG. 11-21-2000. FATA HUNTER, INC. (DELAWARE CORPORATION) 6147 RIVER CREST DRIVE, RIVERSIDE, CA, 92507, SN 75-254,873. FILED 3-10-1997. PRINCIPAL REGISTER.



NO CLAIM IS MADE TO THE EXCLUSIVE RIGHT TO USE "SYSTEM", APART FROM THE MARK AS SHOWN.
INT. CL. 9/U.S. CLS. 21, 23, 26, 36 AND 38

FOR INTEGRATED CONTROL SYSTEM FOR ALUMINUM COLD ROLLING MILLS COMPRISED OF ONE OR MORE OF THE FOLLOWING - COMPUTER HARDWARE, COMPUTER SOFTWARE, SENSORS, DIAGNOSIS AND OPERATOR INTERFACE TOOLS, MILL LOGICS, SPEED MASTER, LOAD CYLINDER POSITION/PRESSURE CONTROLS, GAUGEMETER CONTROLS, BENDING CONTROLS, COOLING SPAY CONTROLS, AUTOMATIC GAUGE CONTROL, AUTOMATIC FLATNESS CONTROL, PRIMARY DATA MANAGEMENT, PASS SCHEDULE MANAGEMENT, HISTORICAL DATA COLLECTION, REPORTS, MILL SET-UP CALCULATIONS, DATA LINK TO PRODUCTION COMPUTER AND ALARMS, SOLD AS A UNIT.

FIRST USE 3-1-2000; IN COMMERCE 3-1-2000.

ELEMENTS CORRECTED
CITIZENSHIP

2,459,640. REG. 6-12-2001. MELISSA DATA CORP. (CALIFORNIA CORPORATION) 22382 AVENIDA EMPRESA, SANTA RANCHO MARGARITA, CA, 92688, SN 76-035,650. FILED 4-26-2000. PRINCIPAL REGISTER.

LISTWARE

INT. CL. 9/U.S. CLS. 21, 23, 26, 36 AND 38
FOR SOFTWARE THAT ENABLES USERS TO FORMAT RECORDS AND PROCESS LISTS.
FIRST USE 10-0-1997; IN COMMERCE 3-0-1998.

ELEMENTS AMENDED
OWNER NAME

2,462,066. REG. 6-19-2001. PHE, INC. (NORTH CAROLINA CORPORATION) 302 MEADOWLANDS DRIVE, HILLSBOROUGH, NC, 27278, SN 75-430,409. FILED 2-5-1998. PRINCIPAL REGISTER.

ADAM & EVE

OWNER OF U.S. REG. NOS. 1,020,448, 1,959,674 AND OTHERS.

INT. CL. 35/U.S. CLS. 100, 101 AND 102
FOR VIDEO CLUB SERVICES.
FIRST USE 10-27-1997; IN COMMERCE 10-27-1997.

ELEMENTS CORRECTED
PRIOR U.S. REGS.

2,467,564. REG. 7-10-2001. MSC SOFTWARE CORPORATION (DELAWARE CORPORATION) 815 COLORADO BOULEVARD, LOS ANGELES, CA, 90041, SN 76-017,548. FILED 4-4-2000. PRINCIPAL REGISTER.



OWNER OF U.S. REG. NOS. 1,330,631, 1,597,282 AND OTHERS.

NO CLAIM IS MADE TO THE EXCLUSIVE RIGHT TO USE "SOFTWARE", APART FROM THE MARK AS SHOWN.
THE MARK CONSISTS OF A HIGHLY ARTISTIC SCRIPT "X" BETWEEN "MSC" AND "SOFTWARE".

INT. CL. 9/U.S. CLS. 21, 23, 26, 36 AND 38
FOR COMPUTER PROGRAMS FOR ENGINEERING ANALYSIS OF STRUCTURES WITH VIRTUAL MODELS FOR COMPLETE STRUCTURAL, THERMAL, NON-LINEAR, DYNAMIC OR OTHER ANALYSIS.
FIRST USE 6-0-1999; IN COMMERCE 6-0-1999.

ELEMENTS AMENDED
MARK

2,490,837. REG. 9-18-2001. NATIONAL GYPSUM PROPERTIES, LLC (DELAWARE LIMITED LIABILITY CORPORATION) 2001 REXFORD ROAD, CHARLOTTE, NC, 28211, SN 76-160,744. FILED 11-7-2000. PRINCIPAL REGISTER.

2,706,098. REG. 4-15-2003. BS BIOMETRIC SYSTEMS GMBH (FED REP GERMANY LTD LIAB CO) ROCHUSSTRASSE 216, 53123 BONN, FED REP GERMANY., SN 76-210,273. FILED 2-14-2001. PRINCIPAL REGISTER.

PERMABASE FLEX

biowrite

OWNER OF U.S. REG. NO. 2,420,018.
INT. CL. 19/U.S. CLS. 1, 12, 33 AND 50
FOR BUILDING MATERIALS, NAMELY CEMENT BOARDS.
FIRST USE 3-19-1999; IN COMMERCE 3-19-1999.

ELEMENTS AMENDED
MARK

2,506,257. REG. 11-13-2001. SANKYO PHARMA, INC. (DELAWARE CORPORATION) TWO HILTON COURT, PARSIPPANY, NJ, 07054, SN 76-136,581. FILED 9-28-2000. PRINCIPAL REGISTER.

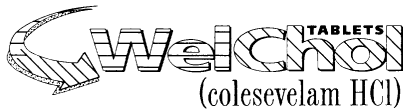

NO CLAIM IS MADE TO THE EXCLUSIVE RIGHT TO USE "TABLETS AND "COLESEVELAM HCL", APART FROM THE MARK AS SHOWN.

THE DRAWING IS LINED FOR THE COLOR(S) BLUE AND GREEN.

THE MARK CONSISTS OF A CURVING ARROW WITH THE BLUE ARROW TAIL DISSOLVING INTO THE GREEN ARROWHEAD POINTING TO THE BLUE LETTERING "WEL" FOLLOWING BY THE GREEN LETTERING "CHOL".

INT. CL. 5/U.S. CLS. 6, 18, 44, 46, 51 AND 52
FOR PHARMACEUTICAL PREPARATIONS, NAMELY, A NON-SYSTEMIC LIPID-LOWERING AGENT TO LOWER LOW-DENSITY LIPOPROTEIN CHOLESTEROL IN PATIENTS WITH PRIMARY HYPERCHOLESTEROLEMIA.
FIRST USE 7-1-2000; IN COMMERCE 7-1-2000.

ELEMENTS CORRECTED
CITIZENSHIP

PRIORITY CLAIMED UNDER SEC. 44(D) ON FED REP GERMANY APPLICATION NO. 30063698.9, FILED 8-24-2000, REG. NO. 30063698, DATED 6-8-2001, EXPIRES 8-31-2010.
INT. CL. 9/U.S. CLS. 21, 23, 26, 36 AND 38

FOR DATA PROCESSING EQUIPMENT, NAMELY, COMPUTER MONITORS, COMPUTER KEYBOARDS, COMPUTER TERMINALS, COMPUTER INTERFACE BOARDS, COMPUTER LASER PRINTERS, COMPUTER OPERATING SYSTEMS, COMPUTER MODEMS, COMPUTER MOUSE AND MOUSE PADS, COMPUTERS, AND SIGNATURE PADS; DATA PROCESSING PROGRAMS, NAMELY, COMPUTER SOFTWARE FOR GATHERING, COMPILING, CATEGORIZING, STORING, REFRESHING, UPDATING, AND PROCESSING ELECTRONIC DATA TO CREATE DATABASES FOR USE IN VALIDATING SIGNATURES IDENTIFYING INDIVIDUALS, COMMUNICATIONS AND SECURITY, COMPUTER SOFTWARE FOR SEARCHING AND RETRIEVING DATA FROM DATABASES FOR USE IN VALIDATING SIGNATURES IDENTIFYING INDIVIDUALS, COMMUNICATIONS AND SECURITY, COMPUTER SOFTWARE FOR GENERATING REPORTS FROM COMPUTER DATABASES, AND COMPUTER SOFTWARE FOR ANALYZING SIGNATURES AND IDENTIFYING INDIVIDUALS AND VERIFYING IDENTITY; MEASURING APPARATUSES FOR USE IN VALIDATING SIGNATURES IDENTIFYING INDIVIDUALS, COMMUNICATIONS AND SECURITY, NAMELY, MEASURING CIRCUITS FOR SIGNATURES.

FIRST USE ; IN COMMERCE .
INT. CL. 38/U.S. CLS. 100, 101 AND 104

FOR PROVIDING TELECOMMUNICATIONS CONNECTIONS TO A GLOBAL COMPUTER NETWORK, TELECOMMUNICATIONS SERVICES, NAMELY, LOCAL AND LONG DISTANCE TRANSMISSION OF VOICE, PERSONAL COMMUNICATION SERVICES, DATA, GRAPHICS BY MEANS OF TELEPHONE, TELEGRAPHIC, CABLE AND SATELLITE TRANSMISSIONS, PERSONAL COMMUNICATION SERVICES, AND TELECOMMUNICATION GATEWAY SERVICES.

FIRST USE ; IN COMMERCE .
INT. CL. 41/U.S. CLS. 100, 101 AND 107

FOR EDUCATIONAL SERVICES, NAMELY ORGANIZING INSTRUCTIONAL CLASSES, SEMINARS AND CONGRESSES IN THE FIELD OF COMPUTERS AND COMPUTER SOFTWARE FOR IDENTIFICATION OF INDIVIDUALS VERIFYING SIGNATURES AND VERIFYING IDENTITIES.

FIRST USE ; IN COMMERCE .
INT. CL. 42/U.S. CLS. 100 AND 101
FOR COMPUTER PROGRAMMING FOR OTHERS.
FIRST USE ; IN COMMERCE .

ELEMENTS CORRECTED
FOREIGN REG. DATE

2,721,958. REG. 6-3-2003. DELAWARE CAPITAL FORMATION, INC. (DELAWARE CORPORATION) 1403 FOULK ROAD SUITE 102, WILMINGTON, DE, 19803, SN 76-121,998. FILED 9-5-2000. PRINCIPAL REGISTER.

2,752,176. REG. 8-19-2003. SIDVIM, INC. (ILLINOIS CORPORATION) 1525 EAST 53RD STREET, STE. 1003, CHICAGO, IL, 60622, SN 76-399,541. FILED 4-24-2002. PRINCIPAL REGISTER.

RPA PROCESS TECHNOLOGIES

NO CLAIM IS MADE TO THE EXCLUSIVE RIGHT TO USE "PROCESS TECHNOLOGIES", APART FROM THE MARK AS SHOWN.

INT. CL. 7/U.S. CLS. 13, 19, 21, 23, 31, 34 AND 35
 FOR MACHINERY FOR PROCESSING INDUSTRIAL FLUID STREAMS AND INDUSTRIAL PRODUCTS, * NAMELY, TURN-KEY SYSTEMS * COMPRISED OF MIXERS, FILTRATION AND SEPARATION UNITS, FLUID CONDUITS, FLOW CONTROL DEVICES, VALVES, AND [PARTS THEREFOR; MIXERS, BLENDERS, AND BOTH SOLID/SOLID AND SOLID/LIQUID BLENDING AND OF INTERMEDIATE AND FINAL PRODUCTS AND PARTS THEREFOR; NAMELY, MACHINES FOR REMOVING MATERIALS FROM LIQUID STATE PRODUCTS AND PARTS THEREFOR; NAMELY, MACHINES FOR INJECTING MATERIAL INTO INDUSTRIAL PROCESS STREAMS AND INDUSTRIAL PRODUCTS AND PARTS THEREFOR; FOR PUMPING INDUSTRIAL FLUID STREAMS AND PARTS THEREFOR] * ORIFICES FOR PROCESSING INDUSTRIAL PROCESS STREAMS AND PARTS THEREFOR; MIXERS AND BLENDERS FOR BOTH SOLID/SOLID AND SOLID/LIQUID BLENDING OF INTERMEDIATE AND FINAL PRODUCTS AND PARTS THEREFOR *.

FIRST USE 1-31-2002; IN COMMERCE 1-31-2002.
 INT. CL. 11/U.S. CLS. 13, 21, 23, 31 AND 34
 FOR EQUIPMENT AND MEDIA, NAMELY, FILTERING UNITS FOR LIQUID/SOLID SEPARATION FOR THE PURPOSE OF CLARIFYING, THICKENING, DEWATERING, FILTERING, POLISHING, PRE-TREATING AND RECYCLING SOLIDS AND LIQUIDS FROM INLET, PROCESS INTERSTAGE OR EFFLUENT STREAMS FOR INDUSTRIAL AND MUNICIPAL PROCESS STREAMS AND PARTS THEREFOR.

FIRST USE 1-31-2002; IN COMMERCE 1-31-2002.

ELEMENTS CORRECTED
 GOODS/SERVICES

2,751,634. REG. 8-19-2003. SPEED PART RP AB (SWEDEN CORPORATION) KROKSLÄTTIS FABRIKER 30, 431 37 MÖLNDAL, SWEDEN., SN 75-981,889. FILED 3-8-1999. PRINCIPAL REGISTER.

SPEED PART

OWNER OF SWEDEN REG. NO. 331069, DATED 4-23-1999, EXPIRES 4-23-2009.

INT. CL. 9/U.S. CLS. 21, 23, 26, 36 AND 38
 FOR COMPUTER CONTROLLED INFRARED RADIATION APPARATUS USED IN CONNECTION WITH RAPID PROTOTYPING AND FREE FORM FABRICATION FOR THE PRODUCTION OF OBJECTS BY MELTING POWDER.

FIRST USE : IN COMMERCE .

ELEMENTS CORRECTED
 OWNER NAME
 OWNER ADDRESS
 ENTITY



NO CLAIM IS MADE TO THE EXCLUSIVE RIGHT TO USE "THE CHICAGO CENTER FOR ADVANCED DENTISTRY", APART FROM THE MARK AS SHOWN.

THE MARK CONSISTS OF DRAWINGS OF HIGHRISE BUILDINGS AND SKYSCRAPPER DEPICTING THE CHICAGO SKYLINE, ENCIRCLED IN AN OVAL WITH THE WORDS "THE CHICAGO CENTER FOR ADVANCED DENTISTRY".

INT. CL. 41/U.S. CLS. 100, 101 AND 107
 FOR EDUCATION SERVICES, NAMELY, POSTGRADUATE COURSES IN ADVANCED DENTISTRY.
 FIRST USE 1-5-1997; IN COMMERCE 1-5-1997.

ELEMENTS CORRECTED
 DESCRIPTION OF MARK

2,805,725. REG. 1-13-2004. TRIFUS N.A. LLC (ILLINOIS LTD LIAB CO) 200 WEST ADAMS, 22ND FLOOR, CHICAGO, IL, 60606, SN 78-080,802. FILED 8-23-2001. PRINCIPAL REGISTER.

TRIFUS

INT. CL. 41/U.S. CLS. 100, 101 AND 107
 FOR EDUCATIONAL SERVICES, NAMELY CONDUCTING CLASSES, COURSES, SEMINARS, AND WORKSHOPS LIVE AND OR BY MEANS OF ELECTRONIC COMMUNICATIONS NETWORKS, DEVELOPMENT OF EDUCATIONAL MATERIALS FOR OTHERS, ALL IN THE FIELDS OF BUSINESS MANAGEMENT, ORGANIZATIONAL MANAGEMENT, LEADERSHIP, BUSINESS OPERATIONS, BUSINESS SKILLS, MANUFACTURING, PRODUCTIVITY, EFFICIENCY, NEGOTIATION, SALES, MARKETING, HUMAN RESOURCES, ACCOUNTING, FINANCE, COMPUTERS, COMPUTING OR HIGH TECHNOLOGY, AND EVALUATION OF THE PROGRESS OF PARTICIPANTS IN THE FOREGOING ACTIVITIES.

FIRST USE 7-0-2001; IN COMMERCE 7-0-2001.
 INT. CL. 42/U.S. CLS. 100 AND 101
 FOR COMPUTER SOFTWARE DESIGN FOR OTHERS; COMPUTER SOFTWARE CONSULTING.
 FIRST USE 7-0-2001; IN COMMERCE 7-0-2001.

ELEMENTS AMENDED
 ENTITY

2,807,001. REG. 1-20-2004. MANHATTAN SKYLINE MANAGEMENT CORP. (NEW YORK CORPORATION) C/O THE ZUCKER ORGANIZATION, 101 WEST 55TH STREET, NEW YORK, NY, 10019, SN 76-238,357. FILED 4-9-2001. PRINCIPAL REGISTER.

MANHATTAN SKYLINE MANAGEMENT CORP.

NO CLAIM IS MADE TO THE EXCLUSIVE RIGHT TO USE "MANHATTAN" AND "MANAGEMENT CORPORATION", APART FROM THE MARK AS SHOWN.
INT. CL. 35/U.S. CLS. 100, 101 AND 102

FOR OPERATION OF COMMERCIAL AND RESIDENTIAL PROPERTY FOR OTHERS, NAMELY, CONDOMINIUMS, APARTMENTS, PARKING GARAGES AND GENERAL RETAIL SPACE; COOPERATIVE REAL ESTATE MARKETING.

FIRST USE 0-0-1983; IN COMMERCE 0-0-1983.
INT. CL. 36/U.S. CLS. 100, 101 AND 102

FOR REAL ESTATE SERVICES, NAMELY, THE LISTING, LEASING, AND MANAGEMENT OF COMMERCIAL AND RESIDENTIAL PROPERTY, NAMELY, CONDOMINIUMS, APARTMENTS, PARKING GARAGES AND GENERAL RETAIL SPACE; REAL ESTATE BROKERAGE.

FIRST USE 0-0-1983; IN COMMERCE 0-0-1983.

ELEMENTS CORRECTED
MARK

2,843,339. REG. 5-18-2004. ALOYS F. DORNBRACHT GMBH & CO. KG (FED REP GERMANY CORPORATION) KOBINGSER MUHLE 6, D-58640 ISERLOHN, FED REP GERMANY., SN 75-906,304. FILED 1-31-2000. PRINCIPAL REGISTER.

DORN BRACHT

PRIORITY CLAIMED UNDER SEC. 44(D) ON ERP CMNTY TM OFC APPLICATION NO. 829572, FILED 5-20-1999.

INT. CL. 9/U.S. CLS. 21, 23, 26, 36 AND 38

FOR THERMOSTATS WITH AND WITHOUT REGULATORS.

FIRST USE 12-31-1950; IN COMMERCE 12-31-1978.

INT. CL. 11/U.S. CLS. 13, 21, 23, 31 AND 34

FOR SANITARY FITTINGS OF METAL AND PLASTIC FOR TOILET, BATHROOM AND KITCHEN NAMELY, FAUCETS, TAPS, STOPS, MIXERS FOR REGULATING FLOW, DISTRIBUTION AND TEMPERATURE OF WATER, SHOWER HEADS, SETS COMPRISING SHOWER HEADS AND PARTS AND FIXTURES THEREFOR, SETS COMPRISING HANDHELD SHOWER HEADS AND PARTS AND FIXTURES THEREFOR; SPRAYERS FOR SINKS AND PARTS AND FIXTURES THEREFOR; BATH AND SHOWER FIXTURE SETS COMPRISING, SHOWER HEADS, FAUCETS, VALVES, HOSES AND PARTS AND FIXTURES THEREFOR; SETS FOR BATH AND SHOWER COMPRISING, SHOWER HEADS, FAUCETS, AND PARTS AND FIXTURES THEREFOR, RISERS, WATER DIVERTERS, PLUMBING FITTINGS, NAMELY, VALVES.

FIRST USE 12-31-1950; IN COMMERCE 12-31-1978.

INT. CL. 20/U.S. CLS. 2, 13, 22, 25, 32 AND 50

FOR FURNITURE, NAMELY, BATHROOM VANITIES AND HARDWARE SOLD AS A UNIT THEREWITH, MIRRORS, FRAMES; WALL CONSOLES, ACCESSORY STANDS, MIRROR CABINETS, SHELVES, STOOLS, CHAIRS, BENCHES; SHOWER CURTAIN RODS.

FIRST USE 12-31-1950; IN COMMERCE 12-31-1986.

INT. CL. 21/U.S. CLS. 2, 13, 23, 29, 30, 33, 40 AND 50

FOR HOUSEHOLD AND KITCHEN ITEMS, NAMELY, SOAP DISHES, TOWEL DISPENSERS, HOUSEHOLD CLEANING BRUSHES, HOUSEHOLD CLEANING UTENSILS, NAMELY, MOPS, BROOMS AND STEEL WOOL; PAPER TOWEL HOLDERS; SOAP DISHES, TOILET BRUSH HOLDERS, TOILET PAPER HOLDERS, BATHROOM DISPENSERS FOR LOTION AND SOAP, RINSING CUPS FOR BRUSHING TEETH, HOLDERS FOR RINSING CUPS AND SETS THEREOF; TOWEL HOOKS, TOWEL BARS, TOWEL RINGS, TOWEL CONTAINERS, BATH RACKS.

FIRST USE 12-31-1950; IN COMMERCE 12-31-1986.

ELEMENTS CORRECTED
FOREIGN COUNTRY OF ORIGIN

2,846,978. REG. 5-25-2004. VOTIVO, LTD. (WASHINGTON CORPORATION) 3450 4TH AVENUE S., SEATTLE, WA, 98134, SN 76-475,235. FILED P.R. 12-16-2002; AM. S.R. 1-23-2004. SUPPLEMENTAL REGISTER.

FREESIA & TIGER LILY

INT. CL. 3/U.S. CLS. 1, 4, 6, 50, 51 AND 52

FOR SCENTED SKIN SOAP, SCENTED ROOM [PRAY] * SPRAY *, SCENTED BODY SPRAY AND INCENSE.
FIRST USE 5-1-2000; IN COMMERCE 5-1-2000.

ELEMENTS CORRECTED
GOODS/SERVICES

2,877,523. REG. 8-24-2004. HOLDEN LLC (ILLINOIS LTD LIAB CO), DBA HOLDEN INTERNATIONAL, 20 EXECUTIVE COURT, SUITE 1, SOUTH BARRINGTON, IL, 60010, SN 78-284,281. FILED 8-7-2003. PRINCIPAL REGISTER.

HOLDEN International

NO CLAIM IS MADE TO THE EXCLUSIVE RIGHT TO USE "INTERNATIONAL", APART FROM THE MARK AS SHOWN.

SEC. 2(F).

INT. CL. 9/U.S. CLS. 21, 23, 26, 36 AND 38

FOR COMPUTER SOFTWARE FOR MANAGING AND TRAINING PEOPLE IN SALES FORCE EFFECTIVENESS, AND, FOR PREPARING AND EVALUATING SALES CAMPAIGN STRATEGIES AND TACTICS.

FIRST USE 11-1-1991; IN COMMERCE 11-1-1991.

INT. CL. 16/U.S. CLS. 2, 5, 22, 23, 29, 37, 38 AND 50

FOR PRINTED MATTER, NAMELY, MARKETING AND SALES ASSESSMENT SURVEYS, QUESTIONNAIRES, AND PRINTED INSTRUCTIONAL EDUCATIONAL AND TEACHING MATERIAL USED IN CONNECTION WITH SALES CONSULTING AND TRAINING.

FIRST USE 6-1-1987; IN COMMERCE 6-1-1987.

INT. CL. 35/U.S. CLS. 100, 101 AND 102

FOR SALES TECHNIQUE CONSULTATION.

FIRST USE 6-1-1987; IN COMMERCE 6-1-1987.

INT. CL. 41/U.S. CLS. 100, 101 AND 107

FOR EDUCATION SERVICES, NAMELY, PROVIDING SEMINARS AND COURSES ON THE SUBJECT OF SALES TECHNIQUES.

FIRST USE 12-1-1979; IN COMMERCE 12-1-1979.

ELEMENTS CORRECTED
DBA/AKA
OWNER NAME

2,879,208. REG. 8-31-2004. GREEN MOUNTAIN COMMUNICATIONS, INC. (NEW HAMPSHIRE CORPORATION) 16 LEHNER STREET, WOLFEBORO FALLS, NH, 03896, SN 78-212,297. FILED 2-7-2003. PRINCIPAL REGISTER.

GREEN MOUNTAIN COMMUNICATIONS

NO CLAIM IS MADE TO THE EXCLUSIVE RIGHT TO USE "COMMUNICATIONS", APART FROM THE MARK AS SHOWN.

INT. CL. 36/U.S. CLS. 100, 101 AND 102

FOR REAL ESTATE SERVICES, NAMELY, ACQUISITION, MANAGEMENT AND LEASING OF ANTENNA SITES FOR USE IN THE WIRELESS COMMUNICATIONS FIELD.

FIRST USE 3-0-1995; IN COMMERCE 6-0-2002.

INT. CL. 37/U.S. CLS. 100, 103 AND 106

FOR CONSTRUCTION, CONSTRUCTION PLANNING, INSTALLATIONS AND MAINTENANCE OF WIRELESS COMMUNICATIONS PLATFORMS, TOWERS AND EQUIPMENT FOR USE IN THE WIRELESS COMMUNICATIONS FIELD.

FIRST USE 3-0-1995; IN COMMERCE 3-14-1995.

INT. CL. 42/U.S. CLS. 100 AND 101

FOR DESIGNING WIRELESS COMMUNICATIONS SYSTEMS FOR USE IN THE WIRELESS COMMUNICATIONS FIELD.

FIRST USE 3-0-1995; IN COMMERCE 4-0-2002.

ELEMENTS CORRECTED
DATE OF FIRST USE IN COMMERCE

2,882,225. REG. 9-7-2004. SYSMEX CORPORATION (JAPAN CORPORATION) 1-5-1, WAKINOHAMA-KAIGANDORI, CHUO-KU, KOBE, JAPAN., SN 76-302,711. FILED 8-21-2001. PRINCIPAL REGISTER.

POCH-PACK

INT. CL. 5/U.S. CLS. 6, 18, 44, 46, 51 AND 52

FOR DIAGNOSTIC CHEMICAL REAGENTS FOR CLINICAL MEDICAL OR CLINICAL DIAGNOSTIC USE; [MEDICAL DIAGNOSTIC USE;] MEDICAL DIAGNOSTIC REAGENTS AND DIAGNOSTIC PREPARATIONS, NAMELY IN VITRO AND IN VIVO TESTING REAGENTS, DILUENTS, LYING REAGENTS, STANDARD AND CONTROL SOLUTIONS FOR APPARATUS FOR CLINICAL TESTS, STANDARD AND CONTROL PARTICLES FOR APPARATUS FOR CLINICAL TESTS, REAGENTS AND CONTROL SOLUTIONS FOR [BOOK] * BLOOD * ANALYSIS, REAGENTS FOR RETICULOCYTE ANALYSIS, REAGENTS FOR BLOOD COAGULATION TESTING, REAGENTS AND CONTROL MATERIALS FOR URINALYSIS TESTING, AND REAGENTS, DILUENTS AND CONTROL MATERIALS FOR IMMUNOASSAY.

FIRST USE 3-1-2002; IN COMMERCE 2-16-2004.

ELEMENTS CORRECTED
GOODS/SERVICES

2,902,628. REG. 11-16-2004. SCIENCE APPLICATIONS INTERNATIONAL CORPORATION (DELAWARE CORPORATION) 10260 CAMPUS POINT DRIVE, SAN DIEGO, CA, 92121, SN 76-306,423. FILED 8-29-2001. PRINCIPAL REGISTER.



INT. CL. 35/U.S. CLS. 100, 101 AND 102

FOR MANAGEMENT CONSULTING SERVICES IN THE FIELD OF SUPPLY CHAIN MANAGEMENT; BUSINESS PROCESS CONSULTING; AND BUSINESS CONSULTING SERVICES IN THE FIELD OF KNOWLEDGE MANAGEMENT AND INFORMATION TECHNOLOGY.

FIRST USE 1-0-1985; IN COMMERCE 1-0-1985.

INT. CL. 40/U.S. CLS. 100, 103 AND 106

FOR ENVIRONMENTAL REMEDIATION SERVICES, NAMELY, SOIL, WASTE AND/OR WATER TREATMENT SERVICES.

FIRST USE 1-0-1985; IN COMMERCE 1-0-1985.

INT. CL. 41/U.S. CLS. 100, 101 AND 107

FOR COMPUTER EDUCATION TRAINING; TECHNICAL TRAINING IN THE FIELDS OF TROUBLESHOOTING OF COMPUTER HARDWARE AND SOFTWARE PROBLEMS, MONITORING OF NETWORK SYSTEMS, AND PROVIDING BACK-UP COMPUTER PROGRAMS AND FACILITIES; EDUCATIONAL SERVICES, NAMELY, CONDUCTING CLASSES, CONFERENCES, SEMINARS, WORKSHOPS IN THE FIELD OF SECURITY TRAINING AND ENVIRONMENTAL AND REGULATORY COMPLIANCE SUPPORT.

FIRST USE 1-0-1985; IN COMMERCE 1-0-1985.

INT. CL. 42/U.S. CLS. 100 AND 101

FOR BASIC AND APPLIED RESEARCH SERVICES IN THE FIELDS OF HEALTH, TELECOMMUNICATIONS, NATIONAL SECURITY, ENVIRONMENT, SPACE, TRANSPORTATION, LAW ENFORCEMENT, AND FINANCIAL SERVICES; COMPUTER SYSTEMS INTEGRATION SERVICES; COMPUTER SYSTEMS ENGINEERING SERVICES; COMPUTER AND TELECOMMUNICATIONS NETWORK DESIGN FOR OTHERS AND INTEGRATION SERVICES; ENGINEERING SERVICES; ENGINEERING SERVICES IN THE FIELD OF ENVIRONMENTAL REMEDIATION; TECHNICAL ENGINEERING AND CONSULTING SUPPORT SERVICES; BUSINESS AND TECHNICAL SUPPORT SERVICES, NAMELY, DEVELOPING TECHNOLOGIES FOR OTHERS IN THE FIELDS OF ARTIFICIAL INTELLIGENCE, SPECTRAL IMAGING, INSPECTIONS TECHNOLOGIES, WEATHER FORECASTING, SOFTWARE DEVELOPMENT, DATA SOURCE INTEGRATION, MODELING AND SIMULATION TECHNOLOGY, BIOMEDICAL RESEARCH, CONTACT CENTERS IN THE NATURE OF NETWORK SYSTEMS FOR SUPPORTING CUSTOMER INTERACTIONS VIA MULTIPLE CHANNELS AND MULTIPLE MEDIA, CUSTOMER RELATIONSHIP MANAGEMENT, DATA MINING AND DATA WAREHOUSING, DISTRIBUTED ENTERPRISE MANAGEMENT, ENERGY, ENTERPRISE RESOURCE PLANNING, THE ENVIRONMENT, ECOMMERCE SOLUTIONS, FINANCIAL SERVICES, HEALTH CARE, IMAGING, INFORMATION TECHNOLOGY, KNOWLEDGE MANAGEMENT, MARITIME MARKETS, IT OUTSOURCING, SUPPLY CHAIN MANAGEMENT, TELECOMMUNICATION, TRANSPORTATION, WIRELESS PRODUCTS AND SERVICES, AVIATION AND UNMANNED VEHICLES, COMPUTER HARDWARE, SAFETY AND SECURITY AND TRANSPORTATION, COMPUTER NETWORK DESIGN AND APPLICATION DEVELOPMENT FOR OTHERS, IMPLEMENTING NETWORK WEB PAGES FOR OTHERS, AND TRAINING IN THE AFORESAID AREAS; INTEGRATION OF COMPUTER SYSTEMS AND NETWORKS FOR OTHERS; COMPUTER SOFTWARE DESIGN AND DEVELOPMENT SERVICES FOR OTHERS; ADVANCED RESEARCH AND DEVELOPMENT SERVICES FOR OTHERS IN THE FIELDS OF HEALTH, TELECOMMUNICATIONS, NATIONAL SECURITY, ENERGY, ENVIRONMENT, SPACE, TRANSPORTATION, LAW ENFORCEMENT, AND FINANCIAL SERVICES; INFORMATION SYSTEMS

AND WEBSITE SECURITY SERVICES; COMPUTER HARDWARE DEVELOPMENT SERVICES; REGISTRATION, TRANSFER, AND ACCOUNT MANAGEMENT SERVICES OF DOMAIN NAMES FOR IDENTIFICATION OF USERS ON A GLOBAL COMPUTER NETWORK; DATA MANAGEMENT IN THE FIELDS OF HEALTH, TELECOMMUNICATIONS, NATIONAL SECURITY, ENERGY, ENVIRONMENT, SPACE, TRANSPORTATION, LAW ENFORCEMENT, AND FINANCIAL SERVICES; COMPUTER PROJECT AND PROGRAM MANAGEMENT; NEW PRODUCT DEVELOPMENT SERVICES FOR OTHERS; TESTING AND DESIGN OF NEW PRODUCTS DEVELOPMENT SERVICES FOR OTHERS; TESTING AND DESIGN OF NEW PRODUCTS FOR OTHERS, AND POLICY DEVELOPMENT FOR OTHERS IN THE FIELDS OF HEALTH, TELECOMMUNICATIONS, NATIONAL SECURITY, ENERGY, ENVIRONMENT, SPACE, TRANSPORTATION, LAW ENFORCEMENT, AND FINANCIAL SERVICES; ELECTRONIC COMMERCE SERVICES, NAMELY, DATA ENCRYPTION SERVICES, NAMELY, TROUBLESHOOTING OF COMPUTER HARDWARE AND SOFTWARE PROBLEMS, MONITORING OF NETWORK SYSTEMS, AND PROVIDING BACK-UP COMPUTER PROGRAMS AND FACILITIES.

FIRST USE 1-0-1985; IN COMMERCE 1-0-1985.

ELEMENTS AMENDED
MARK



2,902,846, REG. 11-16-2004. DLC LABORATORIES, INC (CALIFORNIA CORPORATION) 7008 MARCELLE STREET, PARAMOUNT, CA, 90723, SN 76-521,637. FILED 6-11-2003. PRINCIPAL REGISTER.

DE LA CRUZ

THE ENGLISH TRANSLATION OF DE LA CRUZ IS "OF THE CROSS".

INT. CL. 3/U.S. CLS. 1, 4, 6, 50, 51 AND 52

FOR COSMETICS, NAMELY, SKIN MOISTURIZING AND BASE CREAMS, WRINKLE CONTROL CREAMS, SKIN SOFTENING PREPARATIONS, SKIN EMOLLIENTS, AND REDUCING CREAMS THAT STIMULATE PERSPIRATION; AND HAIR CARE PREPARATIONS.

FIRST USE 0-0-1995; IN COMMERCE 0-0-1995.

INT. CL. 5/U.S. CLS. 6, 18, 44, 46, 51 AND 52

FOR HEALTH AIDS, NAMELY, DIETARY SUPPLEMENTS, DIETARY SUPPLEMENTS CONTAINING VITAMINS, DIETARY SUPPLEMENTS TO PROMOTE RESPIRATORY HEALTH, EYE DROPS, ANTI-ACID DIGESTIVE AIDS, LAXATIVES, ANTI-FLATULENT AND ANTI-COLIC PREPARATIONS, THROAT LOZENGES, TOPICAL ANTI-INFECTIVE PREPARATIONS, TOPICAL PAIN RELIEVERS, TOPICAL ANTI-ACNE PREPARATIONS, CAMPHORATED TOPICAL SALVES, OINTMENTS FOR THE RELIEF OF NASAL CONGESTION, COUGHING AND MINOR MUSCULAR ACHES AND PAINS, AND INSECTICIDES FOR USE ON HUMAN BEINGS.

FIRST USE 0-0-1965; IN COMMERCE 0-0-1965.

ELEMENTS CORRECTED
OWNER NAME
OWNER ADDRESS
CITIZENSHIP
ENTITY

2,907,610, REG. 12-7-2004. ERNST MARKS GMBH & CO. KG (FED REP GERMANY KG) 45442 MÜLHEIM AN DER RUHR, FED REP GERMANY., SN 76-473,793. FILED 12-3-2002. PRINCIPAL REGISTER.



THE MARK CONSISTS OF THE COLOR ROSE USED OVER THE ENTIRE SURFACE OF THE GOODS. THE MATTER SHOWN IN THE DRAWING IN BROKEN LINES SERVES ONLY TO SHOW THE POSITIONING OF THE MARK AND NO CLAIM IS MADE TO IT.

SEC. 2(F).

INT. CL. 16/U.S. CLS. 2, 5, 22, 23, 29, 37, 38 AND 50

FOR [TEN] * SEVEN * THOUSANDTHS OF AN INCH THICKNESS PAPER UNDERLAY SHEETS FOR OFFSET PRINTING MACHINES.

FIRST USE 1-27-1983; IN COMMERCE 1-27-1983.

ELEMENTS CORRECTED
GOODS/SERVICES



2,955,115, REG. 5-24-2005. SWEET CONCESSIONS, INC. (NEW YORK CORPORATION) 1650 BROADWAY SUITE 305, NEW YORK, NY, 10019, SN 78-417,847. FILED 5-13-2004. PRINCIPAL REGISTER.

SWEET CONCESSIONS

THE MARK CONSISTS OF STANDARD CHARACTERS WITHOUT CLAIM TO ANY PARTICULAR FONT, STYLE, SIZE, OR COLOR.

SEC. 2(F).

INT. CL. 35/U.S. CLS. 100, 101 AND 102

FOR CONCESSION STANDS FEATURING FOOD.

FIRST USE 4-0-1989; IN COMMERCE 4-0-1989.

ELEMENTS CORRECTED
OWNER NAME



2,957,802, REG. 5-31-2005. MILLIMAN, INC. (WASHINGTON CORPORATION) 1301 FIFTH AVENUE, SUITE 3800, SEATTLE, WA, 98101, SN 76-550,060. FILED 10-9-2003. PRINCIPAL REGISTER.

L.A.M.P.

INT. CL. 36/U.S. CLS. 100, 101 AND 102

FOR INSURANCE ACTUARIAL SERVICES, NAMELY, INVESTMENT MANAGEMENT AND LIABILITY ASSET MANAGEMENT SERVICES.
FIRST USE 9-1-2004; IN COMMERCE 9-1-2004.

ELEMENTS CORRECTED
OWNER NAME
CITIZENSHIP

2,964,883. REG. 7-5-2005. AZIENDA VINICOLA FALESCO S.R.L. (ITALY LTD LIAB JT ST CO) VIA SAN DOMENICO SAVIO 28, FRAZIONE MONTERUBIAGLIO, CASTEL VISCARDO, TERNI, ITALY, 05014, SN 78-186,003. FILED 11-18-2002. PRINCIPAL REGISTER.

MONTIANO

PRIORITY CLAIMED UNDER SEC. 44(D) ON ITALY APPLICATION NO. TO2002C03286, FILED 11-8-2002.
INT. CL. 33/U.S. CLS. 47 AND 49
FOR WINES.
FIRST USE 0-0-1995; IN COMMERCE 0-0-1995.

ELEMENTS AMENDED
FOREIGN APPLICATION NO.

2,969,168. REG. 7-19-2005. OTTO BOCK HEALTHCARE GMBH (FED REP GERMANY LTD LIAB CO) MAX-NADER-STRASSE 15, 37115 DUDERSTADT, FED REP GERMANY, SN 76-492,810. FILED 2-26-2003. PRINCIPAL REGISTER.



PRIORITY CLAIMED UNDER SEC. 44(D) ON FED REP GERMANY APPLICATION NO. 30242585.3/1, FILED 8-30-2002, REG. NO. 30242585, DATED 2-28-2003, EXPIRES 8-31-2012.

OWNER OF U.S. REG. NOS. 1,621,793 AND 1,774,149.
"OTTO BOCK" IS THE NAME OF A DECEASED INDIVIDUAL.

INT. CL. 1/U.S. CLS. 1

FOR (BASED ON USE IN COMMERCE) CHEMICAL PREPARATIONS FOR USE IN MANUAL ORTHOPEDIC PRODUCTS, NAMELY, UNPROCESSED ARTIFICIAL RESINS, RAW AND SYNTHETIC RESINS FOR USE IN MANUFACTURE OF MEDICAL AND SURGICAL DEVICES, ADHESIVES FOR USE IN THE MANUFACTURE OF MEDICAL AND SURGICAL DEVICES; CHEMICALS FOR USE IN THE MANUFACTURE OF MEDICAL AND SURGICAL DEVICES FOR THE MEDICAL, ORTHOPEDIC AND COSMETIC FIELDS.

FIRST USE 11-30-1973; IN COMMERCE 11-30-1973.

INT. CL. 3/U.S. CLS. 1, 4, 6, 50, 51 AND 52

FOR (BASED ON USE IN COMMERCE) BLEACHING PREPARATIONS AND OTHER SUBSTANCES, NAMELY, CLEANSING LOTION FOR SKIN, PROSTHESIS, ORTHOSIS AND LINER FOR LAUNDRY USE; CLEANING, POLISHING, SCOURING AND GENERAL PURPOSE CLEANING, POLISHING, AND ABRASIVE LIQUIDS AND POWDERS, SOAPS, PERFUMERY, ESSENTIAL OILS FOR SKINCARE; COSMETICS, HAIR LOTIONS, DENTIFRICES.

FIRST USE 12-31-1974; IN COMMERCE 4-10-2001.

INT. CL. 5/U.S. CLS. 6, 18, 44, 46, 51 AND 52

FOR (BASED ON USE IN COMMERCE) MEDICAL PLASTERS AND SURGICAL AND WOUND DRESSINGS.
FIRST USE 12-31-1974; IN COMMERCE 9-9-1977.

INT. CL. 9/U.S. CLS. 21, 23, 26, 36 AND 38

FOR CONTROLLING APPARATUS FOR ARTIFICIAL LIMBS; ELECTRICAL CONTROLLERS FOR ARTIFICIAL LIMBS; ELECTRICAL APPARATUS AND INSTRUMENTS THAT SENSE PRESSURE AND BODY POTENTIAL AND MEASURE UNITS OF PRESSURE, BODY POTENTIAL AND POSITIONING FOR ARTIFICIAL LIMBS; SOFTWARE FOR ADJUSTMENT OF ARTIFICIAL LIMBS.

FIRST USE ; IN COMMERCE .

INT. CL. 10/U.S. CLS. 26, 39 AND 44

FOR (BASED ON USE IN COMMERCE) SURGICAL AND MEDICAL INSTRUMENTS AND EQUIPMENT, NAMELY, ARTIFICIAL JOINTS; ORTHOPEDIC ARTICLES, NAMELY, ORTHOPEDIC BELTS, BRACES, FOOTWEAR, JOINT IMPLANTS, SOLES, SUPPORT BANDAGES, SUPPORTS, PADDINGS AND SPLINTS; WHEELED STRETCHERS, CANES FOR MEDICAL PURPOSES AND CRUTCHES; PHYSICAL EXERCISE APPARATUS FOR MEDICAL PURPOSES; ELECTRIC AND NON-ELECTRIC MASSAGE APPARATUS; CUSHIONS FOR MEDICAL PURPOSES AND PADS FOR PREVENTING PRESSURE SORES OF PATIENT BODIES.

FIRST USE 1-1-1965; IN COMMERCE 1-1-1965.

INT. CL. 12/U.S. CLS. 19, 21, 23, 31, 35 AND 44

FOR (BASED ON USE IN COMMERCE) APPARATUS FOR LOCOMOTION BY LAND, AIR OR WATER, NAMELY, WHEEL CHAIRS AND PUSHCHAIRS; SEATS FOR CHILDREN FOR WHEEL CHAIRS AND PUSHCHAIRS; HEAD-RESTS AND SUPPORT CUSHIONS FOR WHEEL CHAIRS AND PUSHCHAIRS.

FIRST USE 12-31-1974; IN COMMERCE 10-31-1988.

INT. CL. 17/U.S. CLS. 1, 5, 12, 13, 35 AND 50

FOR (BASED ON USE IN COMMERCE) SEMI-PROCESSED RESINS AND PLASTICS IN PELLET AND BLOCK FORM OR AS GEL FOR USE IN THE MANUFACTURE OF UPHOLSTERY MATERIAL OR COVERS IN THE FURNITURE INDUSTRY; SEMI-PROCESSED RESINS AND PLASTICS IN PELLET AND BLOCK FORM OR AS GEL FOR USE IN THE MANUFACTURE OF SHOCK ABSORBING MATERIAL AS WELL AS FOR PRESSURE DISTRIBUTION PURPOSES IN THE GOLF, TENNIS, FOOTBALL, SOCCER, FIELD HOCKEY, MOTOR SPORT AND CYCLING SPORTS ARTICLE INDUSTRY; SEMI-PROCESSED RESINS AND PLASTICS IN PELLET AND BLOCK FORM OR AS GEL FOR USE IN THE MANUFACTURE OF SHOCK ABSORBING MATERIAL IN THE SHOE INDUSTRY; SEMI-PROCESSED RESINS AND PLASTICS IN PELLET AND BLOCK FORM OR AS GEL FOR USE IN THE MANUFACTURE OF MOTOR VEHICLE PARTS, DASHBOARDS, SIDE COVERINGS, ARM SUPPORTS AND SEATS; SEMI-PROCESSED RESINS AND PLASTICS IN PELLET AND BLOCK FORM OR AS GEL FOR USE IN THE MANUFACTURE OF UPHOLSTERY MATERIAL AND FOR THE IMPROVEMENT OF THE SOFT TOUCH AS WELL AS FOR SHOCK ABSORBING PURPOSES IN THE AUTOMOBILE INDUSTRY; SEMI-PROCESSED SYNTHETIC RESINS AND PLASTICS IN PELLET AND BLOCK FORM OR AS GEL FOR USE IN THE MANUFACTURE OF ORTHOPEDIC ARTICLES, NAMELY, TRUSSES, ORTHOPEDIC HARNESSSES, ORTHOPEDIC BELTS, ORTHOPEDIC BRACES, ABDOMINAL BANDAGES, TRUSS PADS FOR ORTHESES, PADS FOR ORTHESES AND ORTHOPEDIC SHOES, ARCH SUPPORTS, SOLES, HEELS, HEEL WEDGES, SHOES TIPS AND INLAYS, SEALING, PACKING AND INSULATING MATERIALS, ORTHOPEDIC WALKING, STANDING, LYING AND SUPPORTING APPLIANCES, ARTIFICIAL FEET, LEGS, ARMS, HANDS AND PARTS THEREOF, CUSHIONS FOR MEDICAL PURPOSES AND SUPPORTING TREATMENT OF PRESSURE COMPLAINTS AND DECUBITUS OF SICK PERSONS, PROPHYLAXIS OF DECUBITUS, PATIENT SUBSTRATUMS, MATTRESSES FOR MEDICAL PURPOSES, VARICOSE VEIN STOCKINGS, SHOCK ABSORBER FOR ORTHOPEDIC AND MEDICAL PURPOSES; SEMI-PROCESSED SYNTHETIC RESINS AND PLASTICS FOR USE IN THE ORTHOPEDIC INDUSTRY AND CLINICAL MEDICAL FIELD; SEMI-PROCESSED PLASTIC, NAMELY, PADDING INLAYS AND COVERS FOR ORTHOPEDIC AND MEDICAL PURPOSES; AND PLASTIC FILM FOR USE IN THE ORTHOPEDIC AND MEDICAL FIELD.

FIRST USE 1-1-1965; IN COMMERCE 1-1-1965.

INT. CL. 24/U.S. CLS. 42 AND 50

FOR (BASED ON USE IN COMMERCE) WOOLEN FABRIC, HOUSEHOLD LINEN, TABLE LINEN, BED LINEN, MATTRESS COVERS, CLOTH FABRIC-GAUZE, SANITARY FLANNEL, FACE TOWELS OF TEXTILE, JUTE FABRIC, WOOLEN CLOTH.

FIRST USE 12-31-1974; IN COMMERCE 12-31-1998.

INT. CL. 25/U.S. CLS. 22 AND 39

FOR POST-MASTECTOMY CLOTHING, NAMELY, CAMISOLES, T-SHIRTS, SHIRTS, NIGHT GOWNS, SWIMWEAR, BODY SUITS AND BRASSIERES .

FIRST USE ; IN COMMERCE .

INT. CL. 28/U.S. CLS. 22, 23, 38 AND 50

FOR GYMNASTIC APPARATUS, NAMELY, GYMNASTIC HORIZONTAL BARS AND GYMNASTIC TRAINING STOOLS; SPORTING GOODS FOR THE HANDICAPPED, NAMELY, TREADMILLS.

FIRST USE ; IN COMMERCE .

INT. CL. 37/U.S. CLS. 100, 103 AND 106

FOR REPAIR AND MAINTENANCE OF MECHANICAL, ELECTRIC AND ELECTRONIC APPARATUS AND INSTRUMENTS FOR MEDICAL AND ORTHOPEDIC PURPOSES.

FIRST USE ; IN COMMERCE .

INT. CL. 42/U.S. CLS. 100 AND 101

FOR CUSTOM DESIGNING OF PROSTHESES, ORTHOPEDIC DEVICES, BANDAGES AND SHOES FOR OTHERS.

FIRST USE ; IN COMMERCE .

ELEMENTS CORRECTED
NAME/PORTRAIT DESCRIPTION OR CONSENT

2,984,995. REG. 8-16-2005. ARMON LIMITED (ANTIGUA & BARBUDA CORPORATION) ITM MANAGEMENT NV, 9 RUE VERDAINE, GENEVA 3, SWITZERLAND, 1211, SN 78-282,794. FILED 8-4-2003. PRINCIPAL REGISTER.

MACLAREN GLOBAL

INT. CL. 12/U.S. CLS. 19, 21, 23, 31, 35 AND 44

FOR BABY CARRIAGES; PERAMBULATORS INCORPORATING CARRY COTS; PERAMBULATORS; PUSH-CHAIRS; COVERS FOR BABY CARRIAGES AND BABY STROLLERS; PARTS FOR ALL THE AFORESAID GOODS, INCLUDING IN- [CHAIR] * CAR * SEATS WHICH ARE ATTACHABLE TO PUSHCHAIRS.

FIRST USE 7-27-2001; IN COMMERCE 7-27-2001.

ELEMENTS CORRECTED
GOODS/SERVICES

3,038,688. REG. 1-10-2006. MISTRAL S.P.A. (ITALY CORPORATION) VIA F. SANTI NO. 11, MONCALIERI, ITALY, I10024, SN 76-195,812. FILED 1-18-2001. PRINCIPAL REGISTER.



PRIORITY CLAIMED UNDER SEC. 44(D) ON BENELUX APPLICATION NO. 976139, FILED 10-23-2000, REG. NO. 0674464, DATED 10-23-2000, EXPIRES 10-23-2010.

INT. CL. 3/U.S. CLS. 1, 4, 6, 50, 51 AND 52

FOR EAU DE COLOGNE, TOILET WATER, PERFUMES.

FIRST USE ; IN COMMERCE .

INT. CL. 18/U.S. CLS. 1, 2, 3, 22 AND 41

FOR TRUNKS, SUITCASES, HANDBAGS, TRAVEL BAGS, RUCKSACKS, SMALL RUCKSACKS, SHOPPING BAGS NAMELY LEATHER BAGS, SPORT BAGS, BIG SPORT BAGS, BEACH BAGS, WALLETS, KEY CASES (LEATHERWEAR), BAGS NAMELY WAIST-PACKS, COSMETIC CASES SOLD EMPTY.

FIRST USE ; IN COMMERCE .

INT. CL. 25/U.S. CLS. 22 AND 39

FOR CLOTHING, NAMELY FROCKS, SKIRTS, JACKETS, TROUSERS, JEANS, SHIRTS, CHEMISETTES, KNITWEAR NAMELY KNITTED PANTS, KNITTED JACKETS AND KNITTED PULLOVERS, SINGLETTS, SWEATERS, PULLOVERS, COATS, COTTON COATS, SUITS, WAISTCOATS, OVERCOATS, SUSPENDERS FOR TROUSERS, WATERPROOF CLOTHING NAMELY RAINCOATS AND WETSUITS, HATS AND BERETS, SHAWLS, SASHES FOR WEAR, BELTS, UNDERWEAR, SCARVES, NECKTIES, PETTICOATS, OVERALLS, DRESSING GOWNS, NIGHTGOWNS, PAJAMAS, FOOTWEAR, SHOES, FOOTBALL SHOES, SNEAKERS, WOODEN BOOTS, SANDALS.

FIRST USE ; IN COMMERCE .

ELEMENTS CORRECTED

ENTITY
OWNER NAME
OWNER ADDRESS
CITIZENSHIP

3,052,322. REG. 1-31-2006. UNIVERSITY GAMES CORPORATION (CALIFORNIA CORPORATION) 2030 HARRISON STREET, SAN FRANCISCO, CA, 94110, SN 76-596,963. FILED 6-14-2004. PRINCIPAL REGISTER.

SOCCER LOCKER

THE MARK CONSISTS OF STANDARD CHARACTERS WITHOUT CLAIM TO ANY PARTICULAR FONT, STYLE, SIZE, OR COLOR.

NO CLAIM IS MADE TO THE EXCLUSIVE RIGHT TO USE SOCCER, APART FROM THE MARK AS SHOWN.

INT. CL. 16/U.S. CLS. 2, 5, 22, 23, 29, 37, 38 AND 50

FOR EDUCATIONAL BOOKS FOR USE BY CHILDREN WITH MANIPULATIVE GAMES, PUZZLES AND COMPONENTS FOR EDUCATIONAL ACTIVITIES INCLUDED IN A DURABLE CONTAINER AFFIXED TO THE BOX.

FIRST USE 5-21-2004; IN COMMERCE 5-21-2004.

INT. CL. 28/U.S. CLS. 22, 23, 38 AND 50

FOR EDUCATIONAL GAMES FOR USE BY CHILDREN, NAMELY, MANIPULATIVE GAMES, PUZZLES AND GAME COMPONENTS FOR EDUCATIONAL ACTIVITIES INCLUDED IN A DURABLE CONTAINER AFFIXED TO A BOOK.

FIRST USE 5-21-2004; IN COMMERCE 5-21-2004.

ELEMENTS CORRECTED

OWNER NAME
OWNER ADDRESS
CITIZENSHIP
ENTITY

3,061,200. REG. 2-21-2006. FRED MEYER STORES, INC. (OHIO CORPORATION) P.O. BOX 42121, 3800 S.E. 22ND AVENUE, PORTLAND, OR, 97242, SN 78-439,058. FILED 6-22-2004. PRINCIPAL REGISTER.

TURFKING

THE MARK CONSISTS OF STANDARD CHARACTERS WITHOUT CLAIM TO ANY PARTICULAR FONT, STYLE, SIZE, OR COLOR.

OWNER OF U.S. REG. NO. 1,920,541.
INT. CL. 31/U.S. CLS. 1 AND 46
FOR GRASS SEED.
FIRST USE 1-31-2005; IN COMMERCE 1-31-2005.

ELEMENTS CORRECTED
MARK

FOR COMPONENTS OF DIGITAL TELECOMMUNICATION NETWORKS, NAMELY, DIGITAL PRIVATE BRANCH EXCHANGE AND INPUT AND OUTPUT INTERFACES; TELEPHONES FOR USE ON THE INTERNET; COMPUTER HARDWARE, NAMELY, MEDIA GATEWAY FOR LINKING DIFFERENT TELECOMMUNICATION NETWORKS; COMMUNICATION SERVERS FOR CALL CENTERS; MULTIPLEXERS; [DEMULTIPIEXERS;] * DEMULTIPLXERS * TELECOMMUNICATION NETWORKS CONTROLLERS AND MANAGERS; COMPUTER WORKSTATIONS COMPRISING MAIN-FRAME COMPUTERS AND MODEMS, COMPUTER SCREENS, RADIOTELEPHONY SETS; COMMUNICATION SERVERS; DIGITAL RADIO SWITCHES; CONTROL, APPLICATION AND MANAGEMENT SOFTWARE FOR DIGITAL PRIVATE BRANCH EXCHANGE NAMELY UTILITY SOFTWARE FOR MANAGING SOFTWARE TOOLS FOR DIGITAL PRIVATE BRANCH EXCHANGE OF TELECOMMUNICATION NETWORKS, OFFICE APPLICATION SOFTWARE FOR MANAGING TELECOMMUNICATION FUNCTIONS FROM A USER'S COMPUTER IN A TELECOMMUNICATION NETWORK, APPLICATION OPERATING SOFTWARE FOR MANAGING DIGITAL PRIVATE BRANCH EXCHANGES IN A TELECOMMUNICATION NETWORK; DIGITAL COMPUTER TERMINALS; FIXED OR MOVABLE DIGITAL BASE STATIONS; PORTABLE TERMINALS, NAMELY PERSONAL RADIO TERMINALS, PERSONAL DATA COMPUTER TERMINALS, FOR COMMUNICATION, TRANSMISSION, RECEPTION OF VOICE, IMAGE, AND DATA AND MANAGEMENT OF TELECOMMUNICATION NETWORKS; INTERNETWORK GATEWAYS NAMELY ROUTERS, INTERFACE AND INTERCONNECTION COMPUTERS UNITS FOR TRANSFER BETWEEN TELECOMMUNICATION NETWORKS; COMPUTER HARDWARE; USER'S INTERFACES, NAMELY UTILITY SOFTWARE FOR ACCESS TO TELECOMMUNICATION NETWORKS IN INTERNET PROTOCOL MODE; CONTROL, APPLICATION AND MANAGEMENT SOFTWARE FOR WIRE, OPTICAL FIBER, RADIO OR SATELLITE TELECOMMUNICATION AND RADIOCOMMUNICATION NETWORKS USED FOR RELAYING COMMUNICATIONS BETWEEN TELECOMMUNICATION NETWORKS; SOFTWARE FOR MANAGING, DESIGNING, CONFIGURING, AND PROTECTING LOCAL OR REMOTE NETWORKS FOR COMMUNICATION OF VOICE, IMAGE, DATA AND MULTIMEDIA; COMPUTER HARDWARE AND SOFTWARE FOR PROTECTING ACCESS TO COMPUTER NETWORKS AND INTERNET PROTOCOL MODE NETWORKS; ENCIIPHERING AND DECIPHERING SOFTWARE USED FOR VOICE, IMAGE AND DATA; SOFTWARE FOR DESIGNING, MANAGING, SECURING ACCESS TO COMPUTER NETWORKS AND INTERNET PROTOCOL MODE NETWORKS.

FIRST USE ; IN COMMERCE .

3,069,658. REG. 3-21-2006. EADS TELECOM (FRANCE SOCIETE PAR ACTIONS SIMPLIFIEE) RUE JEAN-PIERRE TIMBAUD, BATIMENT JEAN-PIERRE TIMBAUD, 78180 MONTIGNY LE BRETONNEUX, FRANCE., SN 76-484,269. FILED 1-22-2003. PRINCIPAL REGISTER.

CONNEXITY

PRIORITY CLAIMED UNDER SEC. 44(D) ON FRANCE APPLICATION NO. 023178534, FILED 8-6-2002, REG. NO. 023178534, DATED 8-6-2002, EXPIRES 8-6-2012.
INT. CL. 9/U.S. CLS. 21, 23, 26, 36 AND 38

INT. CL. 42/U.S. CLS. 100 AND 101

FOR RESEARCH, DEVELOPMENT AND ADAPTATION OF TELECOMMUNICATION NETWORKS AND OF RADIO COMMUNICATION NETWORKS; DESIGNING AND UPDATING SOFTWARE FOR OTHERS FOR MANAGEMENT, DESIGN, CONFIGURATION AND PROTECTION OF LOCAL OR REMOTE NETWORK FOR COMMUNICATION OF VOICE, IMAGE, DATA AND MULTIMEDIA; DESIGNING AND UPDATING SOFTWARE FOR OTHERS FOR DESIGNING, MANAGING, SECURING ACCESS TO COMPUTER NETWORKS AND TO INTERNET PROTOCOL MODE NETWORKS.

FIRST USE ; IN COMMERCE .

ELEMENTS CORRECTED
GOODS/SERVICES

3,075,179. REG. 4-4-2006. EVERSAFE CORPORATION (OHIO CORPORATION) P.O. BOX 746, MARIETTA, OH, 457500746, SN 76-590,486. FILED 5-5-2004. PRINCIPAL REGISTER.

3,081,783. REG. 4-18-2006. REALITY S.R.L. (ITALY CORPORATION) VIA L. DA VINCI, 14, SARONNO, ITALY, 21047, SN 78-468,769. FILED 8-17-2004. PRINCIPAL REGISTER.

VICTOR

BASILE

THE MARK CONSISTS OF STANDARD CHARACTERS WITHOUT CLAIM TO ANY PARTICULAR FONT, STYLE, SIZE, OR COLOR.

INT. CL. 6/U.S. CLS. 2, 12, 13, 14, 23, 25 AND 50 FOR METAL SAFES AND METAL LOCKS. FIRST USE 12-0-1885; IN COMMERCE 12-0-1885.

ELEMENTS CORRECTED
DATE OF FIRST USE
DATE OF FIRST USE IN COMMERCE

THE MARK CONSISTS OF STANDARD CHARACTERS WITHOUT CLAIM TO ANY PARTICULAR FONT, STYLE, SIZE, OR COLOR.

OWNER OF ITALY REG. NO. 840372, DATED 3-22-2001, EXPIRES 5-10-2008.

OWNER OF U.S. REG. NO. 2,212,230. SEC. 2(F).

INT. CL. 3/U.S. CLS. 1, 4, 6, 50, 51 AND 52

FOR PERFUMES, TOILET SOAPS; ESSENTIAL OILS FOR PERSONAL USE; COSMETICS, NAMELY DEODORANTS FOR PERSONAL USE; CREAMS, LOTIONS AND OILS FOR THE FACE AND THE BODY; CLEANSING MILKS, CREAMS AND OILS; MAKE-UP CREAMS; BEAUTY MASKS; MAKEUP REMOVERS; EYE SHADOWS; LIPSTICKS; MASCARA; ROUGE; CRAYONS FOR THE EYES AND THE LIPS; POWDERS; CREAMS, OILS AND LOTIONS FOR SUNTANNING AND AFTER SUN EXPOSURE; PRE- AND AFTER SHAVE CREAMS AND LOTIONS; TALCUM POWDERS; SALTS, FOAM AND OIL BATH; CREAMS AND LOTION AFTER-BATH; SHAMPOOS; DEPILATORY PREPARATIONS; NAIL POLISHES; HAIR LOTIONS; AND DENTIFRICES.

INT. CL. 9/U.S. CLS. 21, 23, 26, 36 AND 38 FOR SPECTACLES.

ELEMENTS CORRECTED
FOREIGN REG. EXPIRATION DATE

3,075,750. REG. 4-4-2006. THERAFLAX USA, INC. (NEW YORK CORPORATION) #25-B, 77 WEST 24TH STREET, NEW YORK, NY, 10010, SN 78-448,747. FILED 7-9-2004. PRINCIPAL REGISTER.

Theraflax

3,084,353. REG. 4-25-2006. EASYGROUP IP LICENSING LIMITED (UNITED KINGDOM CORPORATION) THE ROTUNDA, 42-43 GLOUCESTER CRESCENT, CAMDEN, LONDON NW1 7DL, ENGLAND., SN 78-007,247. FILED 5-8-2000. PRINCIPAL REGISTER.

EASYRENTACAR

THE MARK CONSISTS OF STANDARD CHARACTERS WITHOUT CLAIM TO ANY PARTICULAR FONT, STYLE, SIZE, OR COLOR.

INT. CL. 5/U.S. CLS. 6, 18, 44, 46, 51 AND 52 FOR [NUTRITIONAL SUPPLEMENT CONSISTING OF A BLEND OF FLAX OIL, BORAGE OIL AND BLACK CUMIN OIL] * NUTRITIONAL SUPPLEMENT USED TO TREAT THE SKIN DISEASE PSORIASIS CONSISTING OF A BLEND OF FLAX OIL, BORAGE OIL AND BLACK CUMIN OIL* FIRST USE 1-1-2000; IN COMMERCE 1-1-2000.

ELEMENTS AMENDED
GOODS/SERVICES
MARK

OWNER OF ERPN CMNTY TM OFC REG. NO. 001261502, DATED 7-30-1999, EXPIRES 7-30-2009.

INT. CL. 39/U.S. CLS. 100 AND 105

FOR TRANSPORTATION SERVICES, NAMELY, RENTAL OF CARS, BICYCLES AND SCOOTERS.

FIRST USE ; IN COMMERCE .

ELEMENTS CORRECTED
ASSIGNMENT/NAME CHANGE
OWNER ADDRESS

3,089,372. REG. 5-9-2006. AREVA T&D SA (FRANCE SOCIETE ANONYME) 1 PLACE DE LA COUPOLE, TOUR AREVA, 92084 PARIS LA DEFENSE CEDEX, FRANCE., SN 78-192,969. FILED 12-10-2002. PRINCIPAL REGISTER.

3,091,949. REG. 5-16-2006. CHOI HEONG YUEN - MACAU LIMITED (MACAU CORPORATION) 209 AVENIDA DE ALMEIDA RIBEIRO, MACAU, CHINA., SN 76-613,290. FILED 9-22-2004. PRINCIPAL REGISTER.

FLEXIDIS

PRIORITY CLAIMED UNDER SEC. 44(D) ON FRANCE APPLICATION NO. 023168616, FILED 6-11-2002, REG. NO. 023168616, DATED 6-11-2002, EXPIRES 6-11-2012.



CHOI HEONG YUEN BAKERY
M A C A U

INT. CL. 9/U.S. CLS. 21, 23, 26, 36 AND 38

FOR CIRCUIT BREAKERS, DISCONNECTING CIRCUIT-BREAKER, CIRCUIT-SWITCHERS, LOAD BREAK SWITCHES, ELECTRIC SWITCHES, DISCONNECTOR SWITCHES, ELECTRICAL CONTACTORS, ELECTRICAL FUSES, ELECTRICAL DISCONNECTORS, ELECTRICAL MOTOR CONTROLLER, EARTHING SWITCH, SURGE ARRESTOR, LIGHTNING ARRESTOR, TRANSFORMER USED IN DISTRIBUTION AND TRANSMISSION OF LOW, MEDIUM AND HIGH VOLTAGE ELECTRICAL ENERGY; SWITCHBOARD, SWITCH PANEL, CONTROL BOARDS; ELECTRICAL SUBSTATION, PREFABRICATED SUBSTATION, AND PAD MOUNTED SUBSTATION COMPRISED OF CIRCUIT BREAKERS, DISCONNECTING CIRCUIT-BREAKER, CIRCUIT-SWITCHERS, LOAD BREAK SWITCHES, ELECTRIC SWITCHES, DISCONNECTOR SWITCHES, ELECTRICAL CONTACTORS, ELECTRICAL FUSES, ELECTRICAL DISCONNECTORS, ELECTRICAL MOTOR CONTROLLER, EARTHING SWITCH, SURGE ARRESTOR, LIGHTNING ARRESTOR, TRANSFORMER; POLE TOP MOUNTED EQUIPMENT AND RING MAIN UNIT, NAMELY RECLOSERS, CIRCUIT-BREAKERS, SECTIONALIZERS, LOAD BREAK SWITCHES, DISCONNECTORS, ELECTRICAL FUSES, TRANSFORMERS, LIGHTNING ARRESTORS, SURGE ARRESTORS, USED FOR THE TRANSMISSION AND DISTRIBUTION OF LOW, MEDIUM AND HIGH VOLTAGE ELECTRICAL ENERGY; ELECTRIC AND ELECTRONIC DEVICES OF CONTROL, NAMELY, SWITCHGEAR USED IN THE REMOTE OPERATION OF ELECTRICITY DISTRIBUTION, SWITCHGEAR USED IN MONITORING AND CONTROLLING OF ELECTRICITY DISTRIBUTION, ELECTRIC AND ELECTRONIC PROTECTION RELAYS.

FIRST USE ; IN COMMERCE .

ELEMENTS CORRECTED
CITIZENSHIP
OWNER NAME
OWNER ADDRESS
ENTITY

OWNER OF U.S. REG. NOS. 2,252,867 AND 2,436,788.
NO CLAIM IS MADE TO THE EXCLUSIVE RIGHT TO USE "BAKERY" AND "MACAU," AND THE CHINESE IDEOGRAMS TRANSLITERATED AS "BING JIA" AND "MACAU," APART FROM THE MARK AS SHOWN.

IN ENGLISH, THESE SAME CHARACTERS TRANSLATE, IN MUTUAL ORDER, TO (1) "CHEW" (2) "FRAGRANT AROMA" (3) "GARDEN PARK" (4)-(5) "BAKERY" AND (6) "MACAU."

THE SIX CHINESE IDEOGRAMS IN THE MARK TRANSLITERATE, FROM THE UPPER TO LOWER RIGHT SIDE OF THE MARK, TO "CHOI HEONG YUEN," AND, FROM THE UPPER TO LOWER LEFT SIDE OF THE MARK, TO "BING JIA MACAU."

INT. CL. 30/U.S. CL. 46

FOR PASTRIES AND CONFECTIONERY, NAMELY, COOKIES, CAKES, CANDIES, CRACKERS, BISCUITS, EGG ROLLS, MOON CAKES, CAKES MADE WITH ALMONDS AND OTHER CONFECTIONERY, BREAD AND BUNS, AND SPRING ROLLS.

FIRST USE 11-0-1998; IN COMMERCE 11-0-1998.

ELEMENTS CORRECTED
CITIZENSHIP

3,092,280. REG. 5-16-2006. THE SUNRIDER CORPORATION (UTAH CORPORATION), DBA SUNRIDER INTERNATIONAL, 1625 ABALONE AVENUE, TORRANCE, CA, 90501, SN 78-435,071. FILED 6-14-2004. PRINCIPAL REGISTER.

FOR MANUALLY-OPERATED, TRIGGER PUMP SPRAYERS.
FIRST USE 5-31-1996; IN COMMERCE 5-31-1996.

ELEMENTS CORRECTED
LINING/STIPPLING STATEMENT

HERB CAL

THE MARK CONSISTS OF STANDARD CHARACTERS WITHOUT CLAIM TO ANY PARTICULAR FONT, STYLE, SIZE, OR COLOR.

NO CLAIM IS MADE TO THE EXCLUSIVE RIGHT TO USE HERB, APART FROM THE MARK AS SHOWN.

SEC. 2(F).
INT. CL. 5/U.S. CLS. 6, 18, 44, 46, 51 AND 52
FOR [NUTRITIONAL] * NUTRITIONAL * SUPPLEMENTS.
FIRST USE 1-0-1999; IN COMMERCE 1-0-1999.

ELEMENTS CORRECTED
GOODS/SERVICES

3,094,692. REG. 5-23-2006. SAINT-GOBAIN CALMAR INC. (DELAWARE CORPORATION) 333 SOUTH TURNBULL CANYON ROAD, CITY OF INDUSTRY, CA, 91745, SN 76-615,144. FILED 10-8-2004. PRINCIPAL REGISTER.

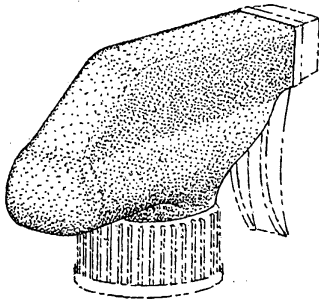

THE STIPPLING SHOWN IN THE DRAWING IS NOT A FEATURE OF THE MARK AND IS NOT INTENDED TO INDICATE COLOR.

THE MARK CONSISTS OF THE PICTORIAL REPRESENTATION OF A SHROUD COVER OF A MANUALLY-OPERATED, TRIGGER PUMP SPRAYER. THE DOTTED OUTLINE OF THE TRIGGER SPRAYER IS NOT PART OF THE MARK, BUT IS MERELY INTENDED TO SHOW THE POSITION OF THE MARK ON THE GOODS.

SEC. 2(F).
INT. CL. 8/U.S. CLS. 23, 28 AND 44

3,113,752. REG. 7-11-2006. TECNO ALARM S.N.C. DI TRUCCHI LUCIANO ENEGRO GIOVANNI (ITALY CORPORATION) STRADA DEL CASCINOTTO, 139/54, TURIN, ITALY, 10156, SN 78-464,227. FILED 8-9-2004. PRINCIPAL REGISTER.

Tecnoalarm

OWNER OF ITALY REG. NO. 480695, DATED 5-26-1987, RENEWED AS REG. NO. 00792242, DATED 10-25-1999, EXPIRES 2-27-2007.

THE MARK CONSISTS OF THE LETTER O IN THE CENTER OF THE MARK AS A SOLID CIRCLE CONTAINING A CHEVRON OR ARROW SHAPE POINTING UPWARD AND TOWARDS THE RIGHT.

INT. CL. 9/U.S. CLS. 21, 23, 26, 36 AND 38
FOR MICROWAVE FREQUENCY DETECTORS; OUTSIDE MICROWAVE FREQUENCY BARRIERS COMPRISING MICROWAVE RECEIVER AND MICROWAVE TRANSMITTER; ELECTRONIC LOCKS AND CONTROLS; TELEPHONE TRANSMITTERS; POINT TO POINT TRANSMITTERS-RECEIVERS; OUTSIDE AND INSIDE SELF-PROTECTED ELECTRONIC SIRENS; POWER SUPPLIES FOR [BATTERY] * BATTERY * CHARGERS; ELECTRIC CABLES, BATTERIES AND PARTS THEREFOR; INFRARED DETECTORS; ELECTRONIC BURGLAR AND FIRE CONTROL PANELS.
FIRST USE ; IN COMMERCE .

ELEMENTS CORRECTED
GOODS/SERVICES

3,114,525. REG. 7-11-2006. ONEIDA INDIAN NATION OF NEW YORK (NEW YORK UNITED STATES FEDERALLY RECOGNIZED SOVEREIGN INDIAN NATION), AKA THE ONEIDA INDIAN NATION OF NEW YORK, THE ONEIDA INDIAN NATION, ONEIDA INDIAN NATION, THE ONEIDA NATION, OR ONEIDA NATION, BOX 1, ROUTE 5, VERNON, NY, 13476, SN 76-249,525. FILED 5-2-2001. PRINCIPAL REGISTER.

OII

INT. CL. 9/U.S. CLS. 21, 23, 26, 36 AND 38
FOR GAMING MACHINES; COMPUTER HARDWARE FOR GAMING MACHINES; COMPUTER SOFTWARE FOR OPERATING GAMING MACHINES.
FIRST USE 5-1-2002; IN COMMERCE 5-1-2002.

ELEMENTS CORRECTED
ENTITY

3,118,632. REG. 7-25-2006. BUILD-A-BEAR RETAIL MANAGEMENT (DELAWARE CORPORATION) 1954 INNERBELT BUSINESS CENTER DRIVE, ST. LOUIS, MO, 63114, SN 76-423,447. FILED 6-20-2002. PRINCIPAL REGISTER.

CREATE-A-BEAR

INT. CL. 28/U.S. CLS. 22, 23, 38 AND 50
FOR PLUSH TOY BEARS.
FIRST USE 6-10-2002; IN COMMERCE 6-10-2002.

ELEMENTS CORRECTED
ASSIGNMENT/NAME CHANGE

FOR COMPUTER [HARDWARE] AND SOFTWARE FOR USE IN BUSINESS MANAGEMENT TO COLLECT, PROCESS, [DISTRIBUTE, ANALYZE,] AND VISUALIZE BUSINESS INFORMATION, INCLUDING, BUT NOT LIMITED TO, BUSINESS INTELLIGENCE, DATA VISUALIZATION, DATA WAREHOUSING, AND DATA MINING.

FIRST USE 11-0-2003; IN COMMERCE 11-0-2003.

ELEMENTS CORRECTED
GOODS/SERVICES

3,120,237. REG. 7-25-2006. RIVERS END ENTERPRISES, INC. (NORTH CAROLINA CORPORATION) 4836 DRUMMOND DRIVE, WILMINGTON, NC, 28409, SN 78-683,375. FILED 8-2-2005. PRINCIPAL REGISTER.

3,122,926. REG. 8-1-2006. THINKWELL CORPORATION (DELAWARE CORPORATION) 2810 SOUTH FIRST STREET, AUSTIN, TX, 78704, SN 78-560,818. FILED 2-4-2005. PRINCIPAL REGISTER.

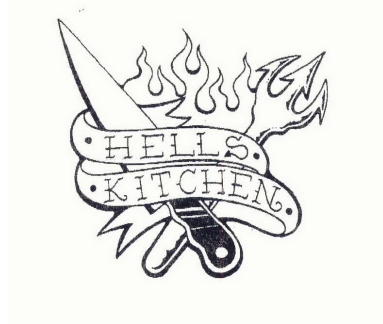

NO CLAIM IS MADE TO THE EXCLUSIVE RIGHT TO USE "HELL'S KITCHEN", APART FROM THE MARK AS SHOWN.

INT. CL. 43/U.S. CLS. 100 AND 101
FOR RESTAURANT SERVICES.
FIRST USE 5-1-2005; IN COMMERCE 5-1-2005.

ELEMENTS CORRECTED
OWNER NAME

3,121,580. REG. 7-25-2006. VISUAL SCIENCES, LLC (DELAWARE LTD LIAB CO) 1616 ANDERSON ROAD, MCLEAN, VA, 22102, SN 78-391,693. FILED 3-26-2004. PRINCIPAL REGISTER.

VISUAL GEOGRAPHY

THE MARK CONSISTS OF STANDARD CHARACTERS WITHOUT CLAIM TO ANY PARTICULAR FONT, STYLE, SIZE, OR COLOR.

OWNER OF U.S. REG. NOS. 2,835,021, 2,835,022 AND OTHERS.
INT. CL. 9/U.S. CLS. 21, 23, 26, 36 AND 38

THINKWELL

THE MARK CONSISTS OF STANDARD CHARACTERS WITHOUT CLAIM TO ANY PARTICULAR FONT, STYLE, SIZE, OR COLOR.

OWNER OF U.S. REG. NO. 2,676,394.
INT. CL. 9/U.S. CLS. 21, 23, 26, 36 AND 38

FOR COMPUTER SOFTWARE PROVIDING SECONDARY AND HIGHER LEVEL EDUCATION TEXTBOOKS RECORDED AS MULTIMEDIA COURSES ON CD-ROM AND DVDS.

FIRST USE 9-0-1999; IN COMMERCE 9-0-1999.

INT. CL. 41/U.S. CLS. 100, 101 AND 107

FOR EDUCATIONAL SERVICES, NAMELY, PROVIDING SECONDARY AND HIGHER LEVEL EDUCATION MULTIMEDIA COURSES THROUGH A WORLDWIDE GLOBAL COMPUTER NETWORK; ELECTRONIC AND PRINTED TEXTBOOK PUBLISHING SERVICES; EDUCATIONAL TESTING; EDUCATIONAL COURSE MONITORING, NAMELY, TRACKING STUDENT PERFORMANCE VIA GRADEBOOK APPLICATIONS * AND FACILITATING STUDENT/PROFESSOR COMMUNICATIONS THROUGH A WORLDWIDE GLOBAL COMPUTER NETWORK *.

FIRST USE 9-0-1999; IN COMMERCE 9-0-1999.

ELEMENTS CORRECTED
GOODS/SERVICES

3,123,966. REG. 8-1-2006. DISNEY ENTERPRISES, INC. (DELAWARE CORPORATION) 500 SOUTH BUENA VISTA STREET, BURBANK, CA, 91521. SN 76-506,419. FILED 4-14-2003. PRINCIPAL REGISTER.

3,129,835. REG. 8-15-2006. POPE ASSOCIATES INC. (MINNESOTA CORPORATION) 1255 ENERGY PARK DRIVE, ST. PAUL, MN, 55108, SN 78-714,608. FILED 9-16-2005. PRINCIPAL REGISTER.



PRIORITY CLAIMED UNDER SEC. 44(D) ON BRAZIL APPLICATION NO. 824.945.603, FILED 10-16-2002. INT. CL. 18/U.S. CLS. 1, 2, 3, 22 AND 41

FOR SPORTS BAGS, [BABY CARRIERS WORN ON THE BODY,] KNAPSACKS, MULTI-USE SPORTS BAGS, BEACH BAGS, BOOK BAGS, DIAPER BAGS, CAMPING BAGS, GYM BAGS, SHOPPING BAGS, WALLETS, FANNY PACKS; WAIST PACKS, SHOULDER BAGS, BELT POUCHES, PURSES, TRAVEL BAGS, TOILETRY BAGS, HANDBAGS, [CANES]

FIRST USE 6-0-2003; IN COMMERCE 6-0-2003.

ELEMENTS CORRECTED
GOODS/SERVICES

NO CLAIM IS MADE TO THE EXCLUSIVE RIGHT TO USE "ARCHITECTS", APART FROM THE MARK AS SHOWN.

THE COLOR(S) PURPLE AND WHITE IS/ARE CLAIMED AS A FEATURE OF THE MARK.

THE MARK CONSISTS OF THE POPE ARCHITECTS MARK IN WHITE LETTERS POSITIONED WITHIN A PURPLE SQUARE DESIGN.

INT. CL. 42/U.S. CLS. 100 AND 101
FOR ARCHITECTURE AND INTERIOR DESIGN SERVICES.

FIRST USE 0-0-1974; IN COMMERCE 0-0-1974.

ELEMENTS CORRECTED
DATE OF FIRST USE
DATE OF FIRST USE IN COMMERCE

3,129,834. REG. 8-15-2006. POPE ASSOCIATES INC. (MINNESOTA CORPORATION) 1255 ENERGY PARK DRIVE, ST. PAUL, MN, 55108, SN 78-714,599. FILED 9-16-2005. PRINCIPAL REGISTER.

3,129,839. REG. 8-15-2006. POPE ASSOCIATES INC. (MINNESOTA CORPORATION) 1255 ENERGY PARK DRIVE, ST. PAUL, MN, 55108, SN 78-714,680. FILED 9-16-2005. PRINCIPAL REGISTER.

POPE ARCHITECTS

POPE

THE MARK CONSISTS OF STANDARD CHARACTERS WITHOUT CLAIM TO ANY PARTICULAR FONT, STYLE, SIZE, OR COLOR.

NO CLAIM IS MADE TO THE EXCLUSIVE RIGHT TO USE "ARCHITECTS", APART FROM THE MARK AS SHOWN.

INT. CL. 42/U.S. CLS. 100 AND 101
FOR ARCHITECTURE AND INTERIOR DESIGN SERVICES .

FIRST USE 7-20-2005, THE MARK WAS FIRST USED ANYWHERE IN A FORM OTHER THAN THAT SOUGHT TO BE REGISTERED ON 00/00/1974.; IN COMMERCE 7-20-2005, THE MARK WAS FIRST USED IN COMMERCE IN A FORM OTHER THAN THAT SOUGHT TO BE REGISTERED ON 00/00/1974..

ELEMENTS CORRECTED
USE IN ANOTHER FORM STATEMENT

THE MARK CONSISTS OF STANDARD CHARACTERS WITHOUT CLAIM TO ANY PARTICULAR FONT, STYLE, SIZE, OR COLOR.

INT. CL. 42/U.S. CLS. 100 AND 101
FOR ARCHITECTURE AND INTERIOR DESIGN SERVICES.

FIRST USE 10-0-1999, THE MARK WAS FIRST USED ANYWHERE IN A DIFFERENT FORM OTHER THAN THAT SOUGHT TO BE REGISTERED ON 00/00/1974.; IN COMMERCE 10-0-1999, THE MARK WAS FIRST USED IN COMMERCE IN A DIFFERENT FORM OTHER THAN THAT SOUGHT TO BE REGISTERED ON 00/00/1974..

ELEMENTS CORRECTED
USE IN ANOTHER FORM STATEMENT

3,134,600. REG. 8-29-2006. DUNDEE CORPORATION (CANADA CORPORATION) SCOTIA PLAZA 40 KING STREET WEST, TORONTO, ONTARIO, CANADA, M5H 4A9, SN 76-371,689. FILED 2-15-2002. PRINCIPAL REGISTER.

3,134,964. REG. 8-29-2006. J.C. BAMFORD EXCAVATORS LIMITED (UNITED KINGDOM LIMITED CORPORATION) ROCESTER, UTTOXETER, STAFFORDSHIRE, UNITED KINGDOM, ST14 5JP, SN 78-483,016. FILED 9-14-2004. PRINCIPAL REGISTER.

DYNAMIC EQUITY HEDGE FUND

LEAN FARMING

PRIORITY CLAIMED UNDER SEC. 44(D) ON CANADA APPLICATION NO. 1127562, FILED 1-15-2002, REG. NO. TMA643874, DATED 7-7-2005, EXPIRES 7-7-2020.
 NO CLAIM IS MADE TO THE EXCLUSIVE RIGHT TO USE "EQUITY HEDGE FUND", APART FROM THE MARK AS SHOWN.
 INT. CL. 36/U.S. CLS. 100, 101 AND 102
 FOR MANAGING MUTUAL FUNDS.

THE MARK CONSISTS OF STANDARD CHARACTERS WITHOUT CLAIM TO ANY PARTICULAR FONT, STYLE, SIZE, OR COLOR.
 PRIORITY CLAIMED UNDER SEC. 44(D) ON ERP CMNTY TM OFC APPLICATION NO. 003713955, FILED 3-16-2004, REG. NO. 003713955, DATED 8-30-2005, EXPIRES 3-16-2014.
 NO CLAIM IS MADE TO THE EXCLUSIVE RIGHT TO USE FARMING, APART FROM THE MARK AS SHOWN.
 INT. CL. 7/U.S. CLS. 13, 19, 21, 23, 31, 34 AND 35
 FOR POWER OPERATED MACHINES AND APPARATUS ALL FOR THE DIGGING, EXCAVATING, MECHANICAL HANDLING, LIFTING, LOADING AND TRANSPORTING OF EARTH, MINERALS, CROPS AND OF THE LIKE MATERIALS; PARTS AND FITTINGS FOR ALL OF THE AFORESAID GOODS.
 INT. CL. 12/U.S. CLS. 19, 21, 23, 31, 35 AND 44
 FOR AGRICULTURAL VEHICLES NAMELY TRACTORS, TRAILERS FOR TRACTORS, AND STRUCTURAL PARTS [THREEFOR] * THEREFORE *.
 FIRST USE ; IN COMMERCE .

ELEMENTS CORRECTED
 OWNER ADDRESS

ELEMENTS CORRECTED
 GOODS/SERVICES
 FOREIGN APPLICATION NO.

3,134,601. REG. 8-29-2006. DUNDEE CORPORATION (CANADA CORPORATION) SCOTIA PLAZA 40 KING STREET WEST, TORONTO, ONTARIO, CANADA, M5H 4A9, SN 76-371,747. FILED 2-15-2002. PRINCIPAL REGISTER.

3,136,164. REG. 8-29-2006. DEPARTMENT OF THE ARMY (UNITED STATES GOVERNMENT AGENCY) JALS-IP, OFFICE OF THE JUDGE ADVOCATE GENERAL DA 901 N. STUART ST., STE 700, ARLINGTON, VA, 222031837, SN 76-472,300. FILED 11-20-2002. PRINCIPAL REGISTER.

DYNAMIC GLOBAL REAL ESTATE FUND



PRIORITY CLAIMED UNDER SEC. 44(D) ON CANADA APPLICATION NO. 1127440, FILED 1-14-2002, REG. NO. TMA638466, DATED 4-27-2005, EXPIRES 4-27-2020.
 NO CLAIM IS MADE TO THE EXCLUSIVE RIGHT TO USE "GLOBAL REAL ESTATE FUND", APART FROM THE MARK AS SHOWN.
 INT. CL. 36/U.S. CLS. 100, 101 AND 102
 FOR MANAGING MUTUAL FUNDS.

INT. CL. 25/U.S. CLS. 22 AND 39

ELEMENTS CORRECTED
 OWNER ADDRESS

NOV 28, 2006

U.S. PATENT AND TRADEMARK OFFICE

TM 1517

FOR CLOTHING, NAMELY, SWEATSHIRTS, T-SHIRTS, SHIRTS, SHORTS, SPORT CAPS, COVER-UPS, BOOTS, SHOES, SANDALS, SWEATPANTS, JACKETS, AND HATS.
FIRST USE 5-0-2003; IN COMMERCE 5-0-2003.

ELEMENTS CORRECTED
GOODS/SERVICES

* * * * *

TRADEMARK REGISTRATIONS—NEW CERTIFICATES

New Certificates issued under section 7(d) of the Trademark Act of 1946 for the unexpired term of the original registrations.

2,270,325. SUMERSET HOUSEBOATS. INT. CLS. 12, 35 AND
37. SUMERSET MARINE, INC., SOMERSET, KY. REG. 8- 17-1999. NEW CERT. SEC. 7(D) TO REGISTRANT.

* * * * *

INDEX OF REGISTRANTS

NOV 28, 2006

(Registered; Renewed; Canceled; Amended, Corrected, etc.; New Certificates; 12c Publications.)

The designation "U.S. Cl." appearing in this section refers to the U.S. class in effect prior to Sep. 1, 1973 rather than the international class which applies to applications filed on or after that date. For adoption of international classification see notice in the OFFICIAL GAZETTE of Jun. 26, 1973 (911 O.G. TM 210).

#1 ONLINE PROMOTION, INC., PORT HOPE, ONTARIO LIA 3VA, CANADA:
2,308,368, CANC. INT. CL. 42.
"FLOAREA SOARELUI" S.A., REPUBLIC MOLDOVA:
3,177,298, PUB. 5-23-2006. INT. CL. 29.
"STS HOLDING GROUP" OOD, BULGARIA:
3,177,222, PUB. 9-12-2006. MULTIPLE CLASS, INT. CLS. 3, 8 AND 21.
A & H SPORTSWEAR CO., INC., STOCKERTOWN, PA:
2,011,542. REN. 10-25-06. INT. CL. 25.
3,177,370, INT. CL. 25.
A DANCER'S DREAM, INC., MARBLEHEAD, MA:
3,177,537, INT. CL. 41.
A LA CART, INC., HARRISBURG, NC:
1,378,027, CANC. INT. CL. 12.
A S N WARE INC., NEW YORK, NY:
2,309,980, CANC. INT. CL. 18.
A SOAPY PUPPY INC., ALPHARETTA, GA:
3,176,716, PUB. 9-12-2006. INT. CL. 44.
A. H. CASTING SERVICES LIMITED, BURLINGTON, ONTARIO, CANADA:
2,309,515, CANC. MULTIPLE CLASS, INT. CLS. 7 AND 40.
A. LOACKER S.P.A. A.G., BOLZANO, ITALY:
3,177,342, INT. CL. 30.
A. SCHULMAN, INC., AKRON, OH:
3,145,601, CANC. IIRN. RESTORED TO S.N. 78-781,261.
A. STUDIO S.R.L., FIRENZE, ITALY:
3,177,010, PUB. 9-12-2006. INT. CL. 20.
A. TRACTENBERG WIPERS AND TESTILES, INC., PAW-TUCKET, RI:
1,378,099, CANC. INT. CL. 18.
A.F. SALCICCIA, INC., CAMPBELL, CA:
2,308,605, CANC. INT. CL. 42.
A.L.S. INDUSTRIES, INC., TORRANCE, CA:
2,308,930, CANC. INT. CL. 9.
A&A GLOBAL INDUSTRIES, INC., COCKEYSVILLE, MD:
3,177,460, INT. CL. 30.
AAA MID-ATLANTIC, INC., PHILADELPHIA, PA:
2,894,193, CANC. INT. CL. 39.
AAI CORPORATION, HUNT VALLEY, MD:
2,036,573. REN. 10-25-06. INT. CL. 9.
AARDVARK EYEWEAR INC., CHICAGO, IL:
2,019,791. REN. 10-26-06. INT. CL. 42.
AARP, WASHINGTON, DC:
1,046,998. REN. 10-24-06. MULTIPLE CLASS, INT. CLS. 36 AND 42.
1,047,005. REN. 10-23-06. MULTIPLE CLASS, INT. CLS. 39 AND 41.
AB COLLAR INTERNATIONAL, INC., SAN DIEGO, CA:
3,178,731, INT. CL. 28.
AB INITIO SOFTWARE CORPORATION, LEXINGTON, MA:
3,177,613, INT. CL. 9.
AB&I, OAKLAND, CA:
3,178,439, INT. CL. 6.
ABA.ECOM A SUBSIDIARY OF THE AMERICAN BANKERS ASSOCIATION, WASHINGTON, DC:
2,309,008, CANC. INT. CL. 42.
ABBOTT & COBB, INC., TREVOSE, PA:
3,177,572, INT. CL. 31.
3,177,579, INT. CL. 31.
ABBOTT VASCULAR INC., REDWOOD CITY, CA:
3,176,827, PUB. 9-12-2006. INT. CL. 10.
ABC BEVERAGE CORP., DARIEN, IL:
3,176,588, PUB. 9-12-2006. INT. CL. 32.
ABDO DEVELOPMENT, LLC, WASHINGTON, DC:
3,176,349, PUB. 9-12-2006. MULTIPLE CLASS, INT. CLS. 35, 36 AND 37.
ABERCROMBIE & FITCH TRADING CO., NEW ALBANY, OH:
3,177,690, INT. CL. 25.
ABITBOUL, LUCIANO, SAN DIEGO, CA:
3,175,984, PUB. 9-12-2006. INT. CL. 25.
ABLECO FINANCE LLC, NEW YORK, NY:
3,177,348, INT. CL. 25.
ABN AMRO MANAGEMENT SERVICES LIMITED, LONDON, UNITED KINGDOM:
3,175,992, PUB. 9-12-2006. INT. CL. 36.
ABROMOVITZ, JAIME, PHOENIX, AZ:
3,177,766, INT. CL. 16.
ABRW ASSOCIATES, INC., SAN DIEGO, CA:
3,177,463, INT. CL. 42.
ABSOLUTE INVESTMENT ADVISERS LLC, HINGHAM, MA:
3,178,000, INT. CL. 36.
ABSOLUTE MEDIA, INC., SANTA CLARA, CA:
3,175,774, PUB. 9-28-2004. MULTIPLE CLASS, INT. CLS. 40, 41 AND 42.
AC NIELSEN (US), INC., SCHAUMBURG, IL:
3,177,985, INT. CL. 42.
ACADEMY OF MOTION PICTURE ARTS AND SCIENCES, BEVERLY HILLS, CA:
2,029,445. REN. 10-25-06. INT. CL. 41.
ACADENTAL, INC., MISSION, KS:
3,176,830, PUB. 9-12-2006. INT. CL. 10.
ACCELERATED REHABILITATION CENTERS, LTD., CHICAGO, IL:
1,993,941. REN. 10-21-06. INT. CL. 42.
ACCESS GROUP, INC., WILMINGTON, DE, LAW ACCESS, INC., WILMINGTON, DE:
1,994,686. REN. 10-24-06. INT. CL. 36.
ACCESS INTELLIGENCE LLC, ROCKVILLE, MD:
1,995,117. REN. 10-26-06. INT. CL. 16.
ACCESS OVERSEAS, INC., NEW YORK, NY:
2,308,787, CANC. INT. CL. 18.
ACCLAIM ENTERTAINMENT, INC., GLEN COVE, NY:
2,309,641, CANC. INT. CL. 9.
ACCLARENT, INC., MENLO PARK, CA:
3,176,146, PUB. 9-12-2006. INT. CL. 10.
ACCOUNTING SYSTEMS COMPANY, INC., FAYETTEVILLE, GA:
1,378,057, CANC. INT. CL. 16.
ACCSYS, INC., TAMPA, FL:
3,178,066, MULTIPLE CLASS, INT. CLS. 9 AND 42.
ACCURAY, INC., SUNNYVALE, CA:
3,177,967, INT. CL. 9.
ACE IDEAS, LLC, ATLANTA, GA:
3,176,147, PUB. 9-12-2006. INT. CL. 41.
ACE LIMITED, HAMILTON BM 08, BERMUDA:
3,177,329, INT. CL. 36.
ACE PRODUCTS ENTERPRISES, INC., FAIRFILED, NJ:
1,377,972, CANC. INT. CL. 9.

- ACEITUNO, JAVIER MIGUEL, 24049 VERDELLO (BG), ITALY:
3,177,326, INT. CL. 42.
- ACHIEVEGLOBAL, INC., TAMPA, FL:
2,309,601, CANC. INT. CL. 9.
- ACME ROYALTY COMPANY, L.P., FORT WORTH, TARRANT COUNTY, TX:
2,310,040, CANC. INT. CL. 35.
- ACME TACKLE COMPANY, PROVIDENCE, RI:
2,309,968, CANC. INT. CL. 28.
- ACME-MONACO CORPORATION, NEW BRITAIN, CT:
3,175,923, PUB. 9-12-2006. MULTIPLE CLASS, INT. CLS. 6 AND 10.
3,175,934, PUB. 9-12-2006. MULTIPLE CLASS, INT. CLS. 6 AND 10.
- ACORN MEDIA GROUP INC., SILVER SPRING, MD:
3,178,608, INT. CL. 35.
- ACRODYNE INDUSTRIES, INC., BLUE BELL, PA:
2,308,592, CANC. INT. CL. 9.
- ACRONIS INC., SOUTH SAN FRANCISCO, CA:
3,176,517, PUB. 9-12-2006. INT. CL. 9.
- ACTIFY, INC., SAN FRANCISCO, CA:
3,178,474, INT. CL. 9.
- ACTION CONSULTING GROUP, LLC, CHICAGO, IL:
3,176,338, PUB. 9-12-2006. INT. CL. 41.
- ACTIONAID, UNITED KINGDOM:
3,177,218, PUB. 9-12-2006. MULTIPLE CLASS, INT. CLS. 9, 16, 35, 36 AND 41.
- ACTIVITY (AUSTRALIA) PTY LTD., FREMONT, CA:
3,178,485, INT. CL. 9.
- ACTIX USA, INC., ATLANTA, GA:
2,426,685, CANC. INT. CL. 42.
- ACUSHNET COMPANY, FAIRHAVEN, MA:
3,176,825, PUB. 9-12-2006. INT. CL. 25.
- ADAMS, TERRY MARA, WEST LOS ANGELES, CA:
2,308,265, CANC. INT. CL. 42.
- ADCO HOLDINGS, INC., MARIETTA, GA:
2,308,850, CANC. INT. CL. 42.
- ADD AN ACCENT, INC., WOODINVILLE, WA AND GALBRETH-MASIKER, JESSICA, WATERTOWN, OH:
3,176,651, PUB. 9-12-2006. INT. CL. 20.
- ADDIE'S STUDIO 1 ON 1, INC., SAN DIEGO, CA:
3,178,031, INT. CL. 41.
- ADDISON WESLEY LONGMAN, INC., READING, MA:
2,309,015, CANC. INT. CL. 9.
- ADEXCHANGE, INC., SAN FRANCISCO, CA:
1,436,658, CANC. INT. CL. 35.
- ADMIRALTY ISLAND FISHERIES, INC., SEATTLE, WA, DBA AQUA STAR:
3,178,047, INT. CL. 29.
- ADNOVUM INFORMATIK AG, SWITZERLAND:
3,177,266, PUB. 9-12-2006. MULTIPLE CLASS, INT. CLS. 9, 16, 35, 38, 41 AND 42.
- ADONIS HEALTHCARE SYSTEMS, L.L.C., ALLENHURST, NJ:
2,308,199, CANC. INT. CL. 42.
- ADRIAN EDUARDO GARCIA, BUENOS AIRES, ARGENTINA AND HECTOR OSCAR NUÑEZ, BUENOS AIRES, ARGENTINA AND ERNESTO JULIO BALDASSARE, BUENOS AIRES, ARGENTINA AND EDUARDO ENRIQUE ISOARDI, BUENOS AIRES, ARGENTINA:
3,175,981, PUB. 9-12-2006. INT. CL. 31.
- ADVANCE INTERNET, INC., NEWARK, NJ:
2,309,731, CANC. INT. CL. 42.
- ADVANCE MAGAZINE PUBLISHERS INC., NEW YORK, NY:
2,310,092, CANC. INT. CL. 16.
- ADVANCE MERCHANDISING COMPANY, INC., ROANOKE, VA:
3,176,010, PUB. 10-11-2005. INT. CL. 35.
3,176,011, PUB. 10-18-2005. INT. CL. 35.
3,176,012, PUB. 10-18-2005. INT. CL. 35.
3,176,013, PUB. 10-11-2005. INT. CL. 35.
3,176,014, PUB. 10-11-2005. INT. CL. 35.
3,176,314, PUB. 9-12-2006. INT. CL. 7.
3,176,368, PUB. 2-28-2006. INT. CL. 35.
3,178,382, MULTIPLE CLASS, INT. CLS. 21 AND 24.
3,178,493, MULTIPLE CLASS, INT. CLS. 21 AND 24.
- ADVANCED ACOUSTICAL CONCEPTS, INC., DAYTON, OH:
2,309,638, CANC. INT. CL. 9.
- ADVANCED BIOTECHNOLOGIES LIMITED, EPSOM, SURREY, UNITED KINGDOM:
1,988,193, REN. 10-23-06. INT. CL. 9.
- ADVANCED EDI & BARCODING CORP, PENSACOLA, FL:
2,309,006, CANC. INT. CL. 38.
- ADVANCED EDUCATION SYSTEMS, LLC, LUTHERVILLE, MD:
3,178,715, INT. CL. 36.
- ADVANCED EDUCATION SYSTEMS, LLC, TIMONIUM, MD:
3,178,787, INT. CL. 42.
- ADVANCED IMAGING SPECIALISTS, LTD., PARADISE VALLEY, AZ:
2,904,436, CANC. IIRN. RESTORED TO S.N. 76-547,978.
- ADVANCED MONITORS CORP., SAN DIEGO, CA:
3,178,281, INT. CL. 10.
- ADVANCING WOMEN IN AUTOMOTIVE RETAIL ENTERPRISES, LTD., TAMPA, FL:
3,177,032, PUB. 9-12-2006. INT. CL. 35.
- ADVANTAGE SOFTWARE COMPANY, INC., THE, PASADENA, CA:
3,176,127, PUB. 9-12-2006. INT. CL. 42.
- ADVANTAGE WORKERS COMPENSATION INSURANCE COMPANY, SALT LAKE CITY, UT:
3,176,558, PUB. 9-12-2006. INT. CL. 36.
- AEC TECHNOLOGIES PLC, OXFORDSHIRE OX11 0RA, UNITED KINGDOM:
2,309,618, CANC. INT. CL. 42.
- AELMINGS, LLC, RALEIGH, NC:
3,176,624, PUB. 9-12-2006. MULTIPLE CLASS, INT. CLS. 35 AND 41.
- AERIELLE, INC., MOUNTAIN VIEW, CA:
3,177,808, INT. CL. 9.
- AERODYNE ALLOYS, LLC, SOUTH WINDSOR, CT:
3,176,166, PUB. 9-12-2006. INT. CL. 6.
- AFFINEGY LLC, AUSTIN, TX:
3,177,978, INT. CL. 9.
- AFFINITY MARKETING PARTNERS, LLC, ENGLEWOOD CLIFFS, NJ:
3,175,986, PUB. 9-12-2006. MULTIPLE CLASS, INT. CLS. 9 AND 38.
- AFL TELECOMMUNICATIONS LLC, DUNCAN, SC:
1,381,134, REN. 10-20-06. INT. CL. 9.
- AFRISEC, LLC, ASHBURN, VA:
3,178,225, INT. CL. 36.
- AGCO CORPORATION, DULUTH, GA:
3,176,611, PUB. 9-12-2006. INT. CL. 36.
- AGEOPTIONS, INC., OAK PARK, IL:
3,177,815, MULTIPLE CLASS, INT. CLS. 36, 43 AND 45.
- AGORA INDUSTRIES, INC., EAGLE, ID:
3,178,755, INT. CL. 9.
- AGORA, INC, BALTIMORE, MD:
1,948,094, CANC. INT. CL. 16.
- AGOURON PHARMACEUTICALS, INC., SAN DIEGO, CA:
2,068,730, REN. 10-26-06. INT. CL. 5.
2,073,266, REN. 10-26-06. INT. CL. 5.
- AGROTAIN INTERNATIONAL, LLC, ST. LOUIS, MO:
3,176,656, PUB. 9-12-2006. INT. CL. 1.
- AGTOPROF, INC., TYLER, TX:
1,948,321, CANC. MULTIPLE CLASS, INT. CLS. 35 AND 42.
- AHOME ACUICOLA S.A. DE C.V., LOS MOCHIS, SINALOA, MEXICO:
1,991,834, REN. 10-25-06. INT. CL. 29.
- AHRENS AGRICULTURAL INDUSTRIES, INC., GRINNELL, IA:
1,995,188, REN. 10-26-06. INT. CL. 11.
- AIR GRECO, INC., LAWRENCEVILLE, GA, DBA WINGS AIR:
3,175,902, PUB. 9-12-2006. INT. CL. 39.
3,175,903, PUB. 9-12-2006. INT. CL. 39.
- AIRMAKEUP, INC., MARGATE, NJ:
3,178,216, INT. CL. 3.
- AIRSENSE ANALYTICS GMBH, FED REP GERMANY:
3,177,288, PUB. 9-12-2006. MULTIPLE CLASS, INT. CLS. 9

- AND 42.
- AIRTREKS, SAN FRANCISCO, CA:
2,310,032, CANC. INT. CL. 39.
- AIRWAY INDUSTRIES, INC., ELLWOOD CITY, PA:
2,308,342, CANC. INT. CL. 18.
- AK STEEL CORPORATION, MIDDLETOWN, OH, ARMCO
INC., MIDDLETOWN, OH:
1,331,648, REN. 10-26-06. INT. CL. 6.
- AK-SAR-BEN/CALGARY HOCKEY, INC., OMAHA, NE:
3,176,531, PUB. 9-12-2006. INT. CL. 41.
3,176,532, PUB. 9-12-2006. INT. CL. 6.
3,176,536, PUB. 9-12-2006. INT. CL. 21.
3,176,537, PUB. 9-12-2006. INT. CL. 24.
3,176,538, PUB. 9-12-2006. INT. CL. 25.
3,176,539, PUB. 9-12-2006. INT. CL. 28.
- AKER KVAERNER CANADA INC., VANCOUVER, BC,
CANADA:
1,404,799, REN. 10-21-06. INT. CL. 11.
- AKI, INC., NEW YORK, NY, ARCADE, INC., CHATTANOOGA,
TN:
2,078,154, REN. 10-26-06. INT. CL. 40.
- AKZO NOBEL COATINGS INC., LOUISVILLE, KY, AKZO
COATINGS AMERICA INC., TROY, MI:
1,402,715, REN. 10-22-06. INT. CL. 2.
- AKZO NOBEL COATINGS INTERNATIONAL B.V., ARNHEM,
NETHERLANDS, SIKKENS B.V., SASSENHEIM,
NETHERLANDS:
1,403,134, REN. 10-22-06. INT. CL. 17.
- AL JAZEERA SATELLITE CHANNEL, DOHA, QATAR:
3,177,346, MULTIPLE CLASS, INT. CLS. 35 AND 41.
- ALADDIN LABEL, INC., WAUKESHA, WI:
1,378,074, CANC. INT. CL. 16.
- ALAMO GROUP INC., SEGUIN, TX:
2,058,673, REN. 10-26-06. INT. CL. 7.
- ALAN R. GRODIN, D.D.S., P.L.C., CLAWSON, MI:
3,176,289, PUB. 9-12-2006. INT. CL. 44.
- ALASKA AIRLINES, INC., SEATTLE, WA:
1,999,872, REN. 10-26-06. INT. CL. 39.
- ALBAUGH, INC., ANKENY, IA:
3,177,582, INT. CL. 5.
- ALBERTSON'S, INC., BOISE, ID:
3,177,770, MULTIPLE CLASS, INT. CLS. 3, 5, 8, 10, 21
AND 25.
- ALBION LABORATORIES, INC., CLEARFIELD, UT:
3,176,511, PUB. 9-12-2006. MULTIPLE CLASS, INT. CLS. 5
AND 31.
- ALBRECHT KIND GMBH, D-51645 GUMMERSBACH-HUN-
STIG, FED REP GERMANY, ALBRECHT KIND GMBH &
CO., GUMMERSBACH, FED REP GERMANY:
1,427,402, REN. 10-23-06. MULTIPLE CLASS, INT. CLS.
13 AND 18.
- ALCRAFT, INC., PAWTUCKET, RI:
2,309,776, CANC. INT. CL. 16.
- ALDI INC., BATAVIA, IL:
1,067,344, REN. 10-22-06. INT. CL. 29.
- ALEEDA GRACE, LTD., CRESSKILL, NJ:
2,309,964, CANC. INT. CL. 3.
- ALEXANDER DENNIS LIMITED, EDINBURGH, UNITED
KINGDOM:
3,177,654, INT. CL. 12.
- ALEXANDER, KENNETH J, LANCASTER, PA:
2,310,072, CANC. INT. CL. 16.
- ALEXANDRA BALLET COMPANY, INC., CHESTERFIELD,
MO:
3,176,284, PUB. 9-12-2006. INT. CL. 41.
- ALFAGRES S.A., BOGOTA, COLOMBIA:
1,411,327, REN. 10-26-06. INT. CL. 19.
- ALFRED KÄRCHER GMBH & CO. KG, FED REP GER-
MANY:
3,177,280, PUB. 9-12-2006. MULTIPLE CLASS, INT. CLS.
1, 3, 5, 6, 7, 9, 11, 12, 20, 21, 22, 37 AND 42.
- ALL AMERICAN GIRLS PROFESSIONAL BASEBALL LEA-
GUE PLAYERS ASSOCIATION, INC., ROCKFORD, MI:
1,987,846, REN. 10-26-06. MULTIPLE CLASS, INT. CLS.
16 AND 25.
- ALL AMERICAN PET COMPANY, INC., BEVERLY HILLS,
CA:
3,177,465, INT. CL. 31.
- ALL AMERICAN SPECIALTY RESTAURANTS, INC., PORT-
LAND, OR:
3,177,013, PUB. 9-12-2006. INT. CL. 30.
- ALL PRO EXERCISE PRODUCTS, INC., LONGBOAT KEY,
FL:
3,177,349, INT. CL. 28.
- ALLEGIANCE BENEFIT PLAN MANAGEMENT, INC.,
MISSOULA, MT:
3,177,561, INT. CL. 35.
- ALLEGIANCE CORPORATION, MCGAW PARK, IL:
3,178,231, INT. CL. 35.
3,178,262, INT. CL. 10.
- ALLEGRA HICKS DESIGNS LIMITED, LONDON SW3 4QS,
UNITED KINGDOM:
3,177,361, INT. CL. 25.
- ALLEGRO MFG. INC., COMMERCE, CA:
3,175,868, PUB. 9-12-2006. INT. CL. 18.
- ALLEGRO MULTIMEDIA, INC., SEFFNER, FL:
3,176,372, PUB. 9-12-2006. INT. CL. 9.
- ALLEN PRODUCTS COMPANY, INC., SIGNAL HILL, CA:
3,175,989, PUB. 9-12-2006. INT. CL. 6.
- ALLEN, REX, NOVATO, CA:
3,175,864, PUB. 9-12-2006. INT. CL. 41.
- ALLERGY ASTHMA TECHNOLOGY, LTD., MORTON
GROVE, IL:
2,002,491, REN. 10-20-06. MULTIPLE CLASS, INT. CLS. 5,
11, 24 AND 42.
- ALLIANCE FLOORING, INC., CHATTANOOGA, TN, COL-
OR TILE OF COLORADO, INC., DENVER, CO:
1,044,430, REN. 10-26-06. MULTIPLE CLASS, INT. CLS.
37 AND 42.
- ALLIANCE MEDICAL, INC., RUSSELLVILLE, MO:
2,008,521, REN. 10-26-06. MULTIPLE CLASS, INT. CLS.
24 AND 25.
- ALLIANCE STORE, LTD., THE, JOSHUA TREE, CA:
3,177,444, INT. CL. 37.
- ALLIANCE TRADING, INC., COVINGTON, LA:
3,177,149, PUB. 9-12-2006. INT. CL. 1.
- ALLIANT TECHSYSTEMS INC., EDINA, MN:
3,177,933, INT. CL. 41.
- ALLIED ELECTRONICS INC., FORT WORTH, TX:
3,176,893, PUB. 9-12-2006. INT. CL. 9.
- ALLIED ENTERPRISES, INC., NORFOLK, VA:
1,377,802, CANC. INT. CL. 3.
- ALLIED LOMAR, INC., BURLINGAME, CA:
3,176,241, PUB. 9-12-2006. INT. CL. 33.
- ALM PROPERTIES, INC., NEW YORK, NY:
3,177,433, INT. CL. 16.
- ALMACENES SANFER, S.A. DE C.V., COL. ANAHUAC,
11360, MEXICO:
2,309,459, CANC. INT. CL. 30.
- ALMO MANIFOLD & TOOL CO., EAST TAWAS, MI:
813,392, REN. 10-25-06. U.S. CL. 23 (INT. CL. 7).
- ALOIS POSCHL GMBH & CO KG, LANDSHUT, FED REP
GERMANY:
1,378,347, CANC. INT. CL. 34.
- ALOYS F. DORNBRACHT GMBH & CO. KG, D-58640
ISERLOHN, FED REP GERMANY:
2,843,339, COR. MULTIPLE CLASS, INT. CLS. 9, 11, 20
AND 21.
- ALPER'S JOBBING, LLC, SAN ANTONIO, TX:
3,178,804, INT. CL. 35.
- ALPHA CORPORATION OF TENNESSEE, COLLIERVILLE,
TN:
2,309,775, CANC. INT. CL. 9.
- ALPHA INTERNATIONAL, INC., CEDAR RAPIDS, IA:
2,319,887, CANC. INT. CL. 28.
- ALPHA RETAIL TECHNOLOGY, INC., CALABASAS, CA:
3,178,301, INT. CL. 9.
- ALPHA SYSTEMS LAB, INC., IRVINE, CA:
2,310,037, CANC. INT. CL. 9.
- ALPHARMA INC., FORT LEE, NJ, A. L. LABORATORIES,
INC., ENGLEWOOD CLIFFS, NJ:
1,065,160, REN. 10-26-06. INT. CL. 5.
- ALPHARMA INC., FORT LEE, NJ:
1,425,420, REN. 10-26-06. INT. CL. 5.

- ALPINE MEADOWS SKI CORPORATION, TAHOE CITY, CA:
3,177,005, PUB. 9-12-2006. INT. CL. 41.
- ALPINE MORTGAGE CORPORATION, WARREN, MI:
3,178,752, INT. CL. 36.
- ALPINE VALLEY WATER COMPANY, CINCINNATI, OH:
3,175,877, PUB. 9-12-2006. MULTIPLE CLASS, INT. CLS. 32 AND 39.
- ALPS SOUTH CORPORATION, ST. PETERSBURG, FL:
3,176,090, PUB. 9-12-2006. INT. CL. 10.
- ALSONS CORPORATION, HILLSDALE, MI:
3,178,091, INT. CL. 11.
- ALTA ENTERPRISES, INC., MEAD, WA:
3,178,486, INT. CL. 37.
- ALTERNA HOLDINGS CORPORATION, LOS ANGELES, CA:
3,178,809, INT. CL. 3.
- ALTERNATIVE CONSTRUCTION COMPANY, INC., MELBOURNE, FL:
3,176,184, PUB. 1-10-2006. INT. CL. 17.
- ALTERNATIVE EDGE, L.L.C., THE, GLENDALE, AZ:
2,308,466, CANC. MULTIPLE CLASS, INT. CLS. 19 AND 37.
- ALTERNATIVE INVESTMENT RESEARCH AND TECHNOLOGIES LLC, NEW YORK, NY:
3,178,709, INT. CL. 36.
- ALTITUDE PRODUCTS, LLC, LONGMONT, CO:
3,178,452, INT. CL. 18.
- ALTO DEVELOPMENT CORPORATION, FARMINGDALE, NJ:
3,176,731, PUB. 9-12-2006. INT. CL. 10.
- ALTUS PHARMACEUTICALS INC., CAMBRIDGE, MA, VERTEX PHARMACEUTICALS INCORPORATED, CAMBRIDGE, MA:
1,951,643, REN. 10-20-06. MULTIPLE CLASS, INT. CLS. 5, 40 AND 42.
- ALUMA USA INC., SANTA ROSA, CA:
3,176,900, PUB. 9-12-2006. INT. CL. 14.
- ALUMNI SPORTS ENTERPRISES, LLC, NEW YORK, NY:
3,177,046, PUB. 9-12-2006. INT. CL. 41.
- ALUSUISSE LONZA CANADA INC., ETOBICOKE, ONTARIO, CANADA:
2,309,614, CANC. MULTIPLE CLASS, INT. CLS. 6 AND 20.
- AMALIE AOC, LTD, TAMPA, FL, WITCO CORPORATION, GREENWICH, CT:
1,915,937, REN. 10-26-06. INT. CL. 4.
- AMANO CORPORATION, YOKOHAMA-SHI, KANAGAWA-KEN, JAPAN:
2,308,227, CANC. INT. CL. 9.
- AMC, INC., ATLANTA, GA:
3,177,542, INT. CL. 35.
- AMDEN CORPORATION, IRVINE, CA:
3,177,784, INT. CL. 21.
- AMDIAN ENTERPRISES LLC, WASHINGTON, DC:
3,176,647, PUB. 9-12-2006. INT. CL. 35.
- AMERICA'S DOCTOR, INC., OWINGS MILLS, MD:
2,308,333, CANC. INT. CL. 42.
2,309,003, CANC. INT. CL. 42.
- AMERICA'S DRIVE-IN CORP., WICHITA, KS:
1,948,101, CANC. INT. CL. 42.
- AMERICA'S MONEYLINE, INC., INNSBROOK (GLEN ALLEN), VA:
2,308,324, CANC. INT. CL. 36.
- AMERICAN ACADEMY OF HOSPITALITY SCIENCES, INC., NEW YORK, NY:
3,178,571, INT. CL. 35.
- AMERICAN ACADEMY OF PEDIATRICS, ELK GROVE VILLAGE, IL:
633,668, REN. 10-25-06. U.S. CL. 38 (INT. CL. 16).
- AMERICAN ASSOCIATION OF HEALTH PLANS, INC., WASHINGTON, DC:
2,308,415, CANC. MULTIPLE CLASS, INT. CLS. 41 AND 42.
- AMERICAN ASSOCIATION OF HOMES AND SERVICES FOR THE AGING, WASHINGTON, DC:
3,178,076, INT. CL. 35.
- AMERICAN ASSOCIATION OF MANAGING GENERAL AGENTS, OVERLAND PARK, KS:
1,949,159, CANC. U.S. CL. 200.
- AMERICAN ASSOCIATION OF TISSUE BANKS, MCLEAN, VA:
1,579,600, AM. INT. CL. 42.
- AMERICAN BANKERS ASSOCIATION, WASHINGTON, DC:
3,176,834, PUB. 9-12-2006. INT. CL. 16.
- AMERICAN BROADCASTING COMPANIES, INC., BURBANK, CA:
3,177,998, INT. CL. 41.
- AMERICAN CANCER SOCIETY, INC., ATLANTA, GA:
3,178,012, INT. CL. 35.
- AMERICAN COLLEGE OF EMERGENCY PHYSICIANS, IRVING, TX:
3,178,801, INT. CL. 42.
- AMERICAN COMMAND PERFORMANCE, LLC, GROSSE POINTE SHORES, MI:
3,178,322, INT. CL. 41.
- AMERICAN DAIRY QUEEN CORPORATION, EDINA, MN:
2,309,480, CANC. INT. CL. 30.
3,178,168, INT. CL. 43.
- AMERICAN DIABETES ASSOCIATION, INC., ALEXANDRIA, VA:
2,309,596, CANC. INT. CL. 42.
- AMERICAN EXPRESS COMPANY, NEW YORK, NY:
2,309,036, CANC. INT. CL. 16.
- AMERICAN FIBERTEK, INC., SOMERSET, NJ:
3,176,061, PUB. 9-12-2006. INT. CL. 9.
- AMERICAN FIDELITY ASSURANCE COMPANY, OKLAHOMA CITY, OK:
2,504,439, CANC. INT. CL. 36.
- AMERICAN FRIENDS OF YAGDIL TORAH INC., FAR ROCKAWAY, NY:
2,308,555, CANC. INT. CL. 27.
- AMERICAN FUTURE SYSTEMS, INC., MALVERN, PA:
3,175,833, PUB. 9-12-2006. INT. CL. 41.
- AMERICAN GREASE STICK COMPANY, MUSKEGON HEIGHTS, MI:
820,603, REN. 10-25-06. U.S. CL. 15 (INT. CL. 4).
- AMERICAN HIGH SCHOOL INTERNET MATHEMATICS COMPETITION, NASHVILLE, TN:
3,178,685, INT. CL. 41.
- AMERICAN INSTITUTE OF TOXICOLOGY, INC., INDIANAPOLIS, IN:
3,175,928, PUB. 9-12-2006. INT. CL. 42.
3,175,929, PUB. 9-12-2006. INT. CL. 44.
- AMERICAN INTERNATIONAL GROUP, INC., NEW YORK, NY:
3,177,140, PUB. 9-12-2006. MULTIPLE CLASS, INT. CLS. 35 AND 36.
3,177,141, PUB. 9-12-2006. INT. CL. 36.
3,178,035, INT. CL. 36.
- AMERICAN ITALIAN PASTA COMPANY, KANSAS CITY, MO:
3,177,106, PUB. 9-12-2006. INT. CL. 30.
- AMERICAN LANGUAGE COMMUNICATION CENTER, INC., NEW YORK, NY:
1,948,455, CANC. INT. CL. 41.
- AMERICAN MAP CORPORATION, MASBETH, NY:
1,949,550, CANC. INT. CL. 16.
- AMERICAN MARINE HOLDINGS, INC., SARASOTA, FL:
3,081,065, CANC. IIRN. RESTORED TO S.N. 75-734,320.
- AMERICAN MARINE INC., LACROSSE, WI:
3,176,971, PUB. 9-12-2006. MULTIPLE CLASS, INT. CLS. 35 AND 39.
- AMERICAN MOVIE CLASSICS COMPANY, WOODBURY, NY:
2,308,650, CANC. INT. CL. 41.
2,310,053, CANC. INT. CL. 41.
- AMERICAN NATIONAL STANDARDS INSTITUTE, INCORPORATED, NEW YORK, NY AND AMERICAN SOCIETY FOR QUALITY, MILWAUKEE, WI:
3,175,870, PUB. 9-12-2006. U.S. CL. B.
- AMERICAN PERFORMANCE PARTS WAREHOUSE, INC., ATLANTA, GA:
1,378,573, CANC. INT. CL. 42.

AMERICAN POP CORN COMPANY, SIOUX CITY, IA:
3,176,562, PUB. 9-12-2006. INT. CL. 30.

AMERICAN POSTER INSTITUTE, SAN FRANCISCO, CA:
3,177,104, PUB. 9-12-2006. INT. CL. 41.

AMERICAN PROMOTIONAL EVENTS, INC., FLORENCE, AL:
1,403,066. REN. 10-26-06. INT. CL. 13.

AMERICAN PUBLIC LIFE INSURANCE COMPANY, OKLAHOMA CITY, OK:
3,175,904, PUB. 9-12-2006. INT. CL. 36.

AMERICAN REPUBLIC INSURANCE COMPANY, DES MOINES, IA:
1,416,939. REN. 10-24-06. INT. CL. 36.
1,432,273. REN. 10-24-06. INT. CL. 36.

AMERICAN RESIDENTIAL SERVICES, L.L.C., MEMPHIS, TN:
2,309,018, CANC. INT. CL. 37.

AMERICAN SOCIAL HEALTH ASSOCIATION, DURHAM, NC:
3,176,226, PUB. 9-12-2006. INT. CL. 44.

AMERICAN SOCIETY FOR MICROBIOLOGY, WASHINGTON, DC:
2,309,721, CANC. INT. CL. 42.

AMERICAN SOCIETY OF APPRAISERS, HERNDON, VA:
2,310,024, CANC. INT. CL. 41.

AMERICAN SOCIETY OF CLINICAL ONCOLOGY, ALEXANDRIA, VA:
3,178,719, INT. CL. 16.

AMERICAN SOCIOLOGICAL ASSOCIATION, WASHINGTON, DC:
1,378,076, CANC. INT. CL. 16.

AMERICAN SPINE CENTER, LTD., BELEVILLE, IL:
3,177,830, MULTIPLE CLASS, INT. CLS. 10 AND 44.

AMERICAN SPORTING GOODS CORPORATION, IRVINE, CA:
3,177,538, INT. CL. 25.

AMERICAN SPORTS BUILDERS ASSOCIATION, ELLICOTT CITY, MD:
3,178,095, INT. CL. 35.

AMERICAN SPORTS LICENSING, INC., WILMINGTON, DE:
3,176,422, PUB. 9-12-2006. MULTIPLE CLASS, INT. CLS. 25 AND 28.
3,176,690, PUB. 9-12-2006. INT. CL. 25.

AMERICAN STERILIZER COMPANY, ERIE, PA:
1,046,200. REN. 10-26-06. INT. CL. 1.

AMERICAN STORES COMPANY, SALT LAKE CITY, UT:
2,309,841, CANC. INT. CL. 36.

AMERICAN TACK & HARDWARE CO., INC., MONSEY, NY:
2,309,833, CANC. INT. CL. 9.

AMERICAN TECHNOLOGY SERVICES, INC., FALLS CHURCH, VA:
2,309,544, CANC. INT. CL. 9.

AMERICATEL CORPORATION, MIAMI, FL:
3,177,745, INT. CL. 38.

AMERIFACTORS FINANCIAL GROUP, INC., CELEBRATION, FL:
3,176,112, PUB. 9-12-2006. INT. CL. 16.

AMERIPAINTERS, INC., NORTHFIELD, MN:
2,308,780, CANC. INT. CL. 37.

AMERIQUEST MORTGAGE COMPANY, ORANGE, CA:
3,175,860, PUB. 9-12-2006. INT. CL. 36.

AMERITRADE IP COMPANY, INC., OMAHA, NE:
2,310,027, CANC. INT. CL. 36.

AMETEK, INC., PAOLI, PA:
3,176,247, PUB. 9-12-2006. MULTIPLE CLASS, INT. CLS. 7 AND 9.

AMETHYST INVESTMENT GROUP, INC., CHICAGO, IL:
2,309,693, CANC. INT. CL. 3.

AMICUS, INC., MEDIA, PA:
1,378,389, CANC. INT. CL. 35.

AMINO FOOD TECHNOLOGIES, INC., MILPITAS, CA:
2,309,281, CANC. INT. CL. 5.

AMINO UP CHEMICAL CO., LTD., HOKKAIDO, JAPAN:
3,177,670, MULTIPLE CLASS, INT. CLS. 5 AND 32.

AMITY LEATHER PRODUCTS CO., WEST BEND, WI:
1,378,103, CANC. INT. CL. 18.

AMOREPACIFIC CORPORATION, SEOUL, REPUBLIC OF KOREA:
3,177,406, INT. CL. 3.

AMPHIOXUS CELL TECHNOLOGIES, INC., HOUSTON, TX:
2,308,954, CANC. INT. CL. 5.

AMPLEXO USA, INC, MIDVALE, UT:
3,176,447, PUB. 9-12-2006. INT. CL. 32.

AMPLIMED CORPORATION, TUCSON, AZ:
3,176,683, PUB. 9-12-2006. INT. CL. 42.

AMRION, INC., BOULDER, CO:
2,310,047, CANC. INT. CL. 5.

AMT PTY LTD, CAMP HILL QLD 4152, AUSTRALIA:
3,177,294, PUB. 9-12-2006. MULTIPLE CLASS, INT. CLS. 5 AND 44.

AMX LLC, ELMHURST, IL:
3,177,403, INT. CL. 9.

AN COFEE DISTRIBUTOR INC., NEW YORK, NY:
3,178,232, INT. CL. 30.

ANALYTICAL BIO-CHEMISTRY LABORATORIES, INC., COLUMBIA, MO:
1,948,947, CANC. INT. CL. 42.

ANALYTICAL GROUP, THE, CHICAGO, IL:
1,993,943. REN. 10-24-06. INT. CL. 9.

ANCHOR DISTRIBUTORS, NEW KENSINGTON, PA:
3,178,475, INT. CL. 35.

ANDALUZA INTERNATIONAL LTD., BAYSIDE, NY:
2,308,261, CANC. INT. CL. 34.

ANDERS, ERIN C., KANSAS CITY, MO:
3,177,559, INT. CL. 25.

ANDERSON, BENJAMIN L., NEW YORK, NY:
3,178,135, INT. CL. 35.

ANDERSON, JOSEPH M., SANBORN, NY:
2,067,084. REN. 10-24-06. INT. CL. 34.

ANDIN INTERNATIONAL INC., NEW YORK, NY:
2,309,948, CANC. INT. CL. 14.
3,177,918, INT. CL. 14.

ANDRE JACOBS, HOLLIS, NY:
3,176,364, PUB. 9-12-2006. INT. CL. 28.

ANDREWS, JAMES K. II, LAGUNA BEACH, CA:
2,308,677, CANC. INT. CL. 41.

ANGEL STREET ENTERPRISES, INC., RICHMOND, IL:
3,177,730, INT. CL. 16.

ANGELETTIE, DERIC, NEW YORK, NY:
2,309,165, CANC. MULTIPLE CLASS, INT. CLS. 9 AND 41.

ANITA JACOBSON AND DEBORAH BUCK PARTNERSHIP, THE, LONG BEACH, NY:
2,309,791, CANC. INT. CL. 16.

ANITEC IMAGE CORPORATION, BINGHAMPTON, NY:
1,377,776, CANC. INT. CL. 1.

ANSELL HEALTHCARE PRODUCTS LLC, RED BANK, NJ:
3,178,293, INT. CL. 10.

ANSELL LIMITED, RICHMOND, AUSTRALIA:
3,178,292, INT. CL. 10.

ANSELL PROTECTIE PRODUCTS, INC., COSHOCTON, OH, GOLDEN NEEDLES KNITTING & GLOVE, CO., INC., WILKESBORO, NC:
1,889,171. REN. 10-25-06. INT. CL. 9.

ANTHONY, CRYSTAL, DETROIT, MI:
3,175,896, PUB. 9-12-2006. INT. CL. 41.

ANTICHI PELLETTIERE S.P.A., CAVRIAGO, ITALY, CREAZIONI ANDREA PFISTER ITALIANA, VIGEVANO (PAVIA), ITALY:
1,037,167. REN. 10-20-06. MULTIPLE CLASS, INT. CLS. 3, 14, 18 AND 25.

ANTIOCH COMPANY, THE, YELLOW SPRINGS, OH:
2,308,795, CANC. MULTIPLE CLASS, INT. CLS. 9, 16 AND 21.

ANTLER LIMITED, BURY, UNITED KINGDOM:
3,176,520, PUB. 9-12-2006. INT. CL. 18.

ANTOINETTE G. GIUGLIANO, P.C., LYNNFIELD, MA:
3,178,379, INT. CL. 42.

ANTON/BAUER, INC., SHELTON, CT:
3,177,822, INT. CL. 9.

ANTONIOUS, ANTHONY J., SARASOTA, FL:
1,948,764, CANC. INT. CL. 28.

ANVIL KNITWEAR, INC., NEW YORK, NY:
2,308,712, CANC. INT. CL. 25.

- AP PARTS MANUFACTURING COMPANY, TOLEDO, OH:
1,378,623, CANC. INT. CL. 42.
- AP&G CO., INC., BROOKLYN, NY:
3,177,517, MULTIPLE CLASS, INT. CLS. 5 AND 21.
- APC GROUP, INCORPORATED, FAIRBANKS, AK:
3,175,995, PUB. 9-12-2006. INT. CL. 9.
- APERIO, INC., NATICK, MA:
2,309,906, CANC. INT. CL. 35.
- APIBIO, 38054 GRENOBLE CEDEX 9, FRANCE:
3,175,944, PUB. 9-13-2005. INT. CL. 9.
- APON RECORD COMPANY, INC., LONG ISLAND CITY, NY:
1,430,003, REN. 10-24-06. INT. CL. 9.
- APPAREL CONCEPTS INTERNATIONAL, INC, NEW YORK, NY:
2,309,248, CANC. INT. CL. 25.
- APPLE EXPRESS COURIER LTD., MISSISSAUGA, ONTARIO, CANADA:
3,177,400, MULTIPLE CLASS, INT. CLS. 35, 37 AND 39.
- APPLEBEE'S INTERNATIONAL, INC., OVERLAND PARK, KS:
2,309,301, CANC. INT. CL. 30.
- APPLETON ELECTRIC LLC, ROSEMOUNT, IL, APPLETON ELECTRIC COMPANY, CHICAGO, IL:
626,834, REN. 10-25-06. U.S. CL. 21 (INT. CLS. 9 AND 11).
- APPLICA CONSUMER PRODUCTS, INC., MIRAMAR, FL:
1,377,913, CANC. MULTIPLE CLASS, INT. CLS. 9 AND 11.
- APPLICA CONSUMER PRODUCTS, INC., MIRAMAR, FL, BLACK & DECKER CORPORATION, THE, TOWSON, MD:
2,006,257, REN. 10-25-06. INT. CL. 7.
- APPLICA CONSUMER PRODUCTS, INC., MIRAMAR, FL:
3,176,052, PUB. 9-12-2006. MULTIPLE CLASS, INT. CLS. 11, 20 AND 21.
- APPLIED CONCEPTS, INC., COLORADO SPRINGS, CO:
3,178,592, INT. CL. 8.
- APPLIED INDUSTRIAL TECHNOLOGIES, INC., CLEVELAND, OH:
2,310,045, CANC. INT. CL. 35.
- APPLIED SYSTEMS, INC., UNIVERSITY PARK, IL:
3,176,431, PUB. 9-12-2006. INT. CL. 9.
- AQUARIUS RAGS, LLC, LOS ANGELES, CA:
3,178,662, INT. CL. 25.
3,178,663, INT. CL. 25.
- AQUASTAR POOL PRODUCTS, INC., SAN DIEGO, CA:
3,176,634, PUB. 9-12-2006. INT. CL. 11.
- ARABIAN HORSE REGISTRY OF AMERICA, INC., DENVER, CO:
2,308,396, CANC. INT. CL. 41.
- ARAI, KYLE K., KAHULUI, HI:
3,178,023, INT. CL. 25.
- ARAMARK CORPORATION, PHILADELPHIA, PA:
3,177,380, MULTIPLE CLASS, INT. CLS. 16, 25 AND 43.
- ARBELLA MUTUAL INSURANCE COMPANY, QUINCY, MA, DBA/ARBELLA INSURANCE GROUP:
3,178,680, INT. CL. 42.
- ARBONNE INTERNATIONAL, INC., IRVINE, CA:
1,377,809, CANC. INT. CL. 3.
- ARCH ALUMINUM & GLASS CO., INC., TAMARAC, FL:
3,175,880, PUB. 9-12-2006. INT. CL. 40.
- ARCHER CONSULTING, INC., GLOUCESTER, MA:
2,309,072, CANC. MULTIPLE CLASS, INT. CLS. 35 AND 41.
- ARCHER DANIELS MIDLAND COMPANY, DECATUR, IL:
3,178,384, INT. CL. 29.
- ARCHER-DANIELS-MIDLAND COMPANY, DECATUR, IL:
3,178,347, INT. CL. 30.
- ARCHITECTS ABROAD, INC., SAN FRANCISCO, CA:
2,309,735, CANC. INT. CL. 39.
- ARCHON PAINTBALL, INC., GREENVILLE, SC:
3,178,044, INT. CL. 28.
- ARCOM DIGITAL, LLC, SYRACUSE, NY:
3,178,310, INT. CL. 9.
- ARDMORE FARMS, INC., AKRON, OH:
2,309,265, CANC. INT. CL. 32.
3,176,767, PUB. 9-12-2006. INT. CL. 32.
- AREA 51 INC., EAST RUTHERFORD, NJ:
3,177,110, PUB. 9-12-2006. INT. CL. 35.
- ARENA FOOTBALL LEAGUE, LLC, NEW YORK, NY:
3,177,514, INT. CL. 41.
- ARES TRADING S.A., CH-1170 AUBONNE, SWITZERLAND:
2,059,423, AM. INT. CL. 5.
- ARETE 3 LTD., TINLEY PARK, IL:
3,176,695, PUB. 9-12-2006. MULTIPLE CLASS, INT. CLS. 37 AND 42.
3,176,696, PUB. 9-12-2006. MULTIPLE CLASS, INT. CLS. 37 AND 42.
- AREVA T&D SA, 92084 PARIS LA DEFENSE CEDEX, FRANCE:
3,089,372, COR. INT. CL. 9.
- AREVA T&D, INC., PHILADELPHIA, PA:
1,404,443, REN. 10-23-06. INT. CL. 42.
- ARICO, LARRY L., JULIAN, CA AND ARICO, JOAN F., JULIAN, CA:
2,309,997, CANC. INT. CL. 16.
- ARISTA INTERACTIVE, LLC, HAUPPAUGE, NY:
2,308,944, CANC. INT. CL. 9.
- ARISTON DI BIGNOTTI GIANLUCA & C. S.N.C., ITALY:
3,177,235, PUB. 9-12-2006. INT. CL. 21.
- ARITZIA, LP, VANCOUVER, B.C., CANADA:
3,175,775, PUB. 2-21-2006. INT. CL. 25.
- ARMILLATOX LIMITED, DERBYSHIRE, DE55 6HL, UNITED KINGDOM:
3,176,594, PUB. 9-12-2006. INT. CL. 19.
- ARMON LIMITED, GENEVA 3, SWITZERLAND:
2,984,995, COR. INT. CL. 12.
- ARMSTRONG HARDWOOD FLOORING COMPANY, LANCASTER, PA:
1,949,519, CANC. INT. CL. 19.
- ARONSON FURNITURE COMPANY, CHICAGO, IL:
3,178,616, INT. CL. 35.
- ARPANET SRL, I-20123 MILANO, ITALY:
3,177,312, PUB. 9-12-2006. INT. CL. 38.
- ARRIBA VISTA, INC., SUNOL, CA:
3,176,325, PUB. 9-12-2006. INT. CL. 41.
- ARRISCRAFT INTERNATIONAL LIMITED PARTNERSHIP, CAMBRIDGE, ONTARIO, CANADA:
3,176,274, PUB. 9-12-2006. MULTIPLE CLASS, INT. CLS. 19 AND 40.
- ARSENAL DIGITAL SOLUTIONS USA, INC., CARY, NC:
3,177,179, PUB. 9-12-2006. MULTIPLE CLASS, INT. CLS. 39 AND 42.
- ARTEMIDE S.P.A., MILANO, ITALY:
1,442,994, REN. 10-24-06. INT. CL. 11.
- ARTEMIS ALLIANCE, INC., ST. PAUL, MN:
2,309,052, CANC. INT. CL. 35.
- ARTHROCARE CORPORATION, SUNNYVALE, CA:
3,178,016, INT. CL. 10.
- ARTIFICIAL INTELLIGENCE NETWORKS, INC., IRVINE, CA:
3,176,973, PUB. 9-12-2006. INT. CL. 42.
- ARTISOFT, INC., CAMBRIDGE, MA:
2,308,640, CANC. INT. CL. 9.
- ARTISTRY MARKETING CONCEPTS, LLC, DALLAS, TX:
3,176,034, PUB. 9-12-2006. INT. CL. 35.
- ARTMARK-CHICAGO, LTD., CHICAGO, IL:
2,309,882, CANC. INT. CL. 28.
- ARYSTA LIFESCIENCE NORTH AMERICA CORPORATION, CARY, NC:
3,178,029, INT. CL. 5.
- AS-BUILT TECHNOLOGIES, LLC., SEATTLE, WA:
2,309,210, CANC. INT. CL. 42.
- ASAH MEDICO A/S, DK-2650 HVIDOVRE, DENMARK:
2,309,589, CANC. INT. CL. 10.
- ASAP DISTRIBUTING CO., HUNTLEY, IL:
2,308,630, CANC. INT. CL. 29.
- ASCEND MEDIA, LLC, OVERLAND PARK, KS:
3,177,519, INT. CL. 9.
- ASCENSION TECHNOLOGY CORPORATION, BURLINGTON, VT:
3,177,073, PUB. 9-12-2006. INT. CL. 9.
3,177,075, PUB. 9-12-2006. INT. CL. 9.
- ASCO GROUP LIMITED, FREEPORT, BAHAMAS:
1,409,571, REN. 10-22-06. INT. CL. 25.

ASCOT, LLC, BALTIMORE, MD:
3,178,102, INT. CL. 25.

ASH GROVE CEMENT COMPANY, OVERLAND PARK, KS:
3,177,816, INT. CL. 19.

ASHANTI S.R.L., ITALY:
3,177,268, PUB. 9-12-2006. MULTIPLE CLASS, INT. CLS. 8 AND 21.

ASHLAND LICENSING AND INTELLECTUAL PROPERTY LLC, DUBLIN, OH:
3,176,760, PUB. 9-12-2006. INT. CL. 37.

ASHLEY, TODD, LOS ANGELES, CA, DBA FIREWATER:
2,308,826, CANC. INT. CL. 41.

ASHOK, ARORA K., VIRGINIA BEACH, VA:
2,309,230, CANC. INT. CL. 42.

ASIA PACIFIC FUEL CELL TECHNOLOGIES, LTD., CHUNAN, MIAOLI, TAIWAN:
3,177,506, MULTIPLE CLASS, INT. CLS. 7, 9 AND 42.

ASIAN VENTURES, INC., AUGUSTA, GA:
3,178,255, INT. CL. 12.

ASICS CORPORATION, CHUO-KU, KOBE 650-8555, JAPAN:
3,175,920, PUB. 9-12-2006. INT. CL. 25.
3,175,921, PUB. 9-12-2006. INT. CL. 25.
3,175,922, PUB. 9-12-2006. INT. CL. 25.

ASK BEAUTY, LTD., NEW YORK, NY:
2,309,668, CANC. INT. CL. 3.

ASPECT SOFTWARE, INC., WESTFORD, MA:
3,178,375, MULTIPLE CLASS, INT. CLS. 9 AND 35.

ASSAF, VITTORIO, NEW YORK, NY AND GRANATO, FABIO, NEW YORK, NY:
3,177,743, INT. CL. 43.

ASSISI ANIMAL CLINICS OF VIRGINIA, INC., ROANOKE, VA:
3,178,030, INT. CL. 39.

ASSOCIATES OF CAPE COD, INC., EAST FALMOUTH, MA:
2,026,958, REN. 10-26-06. INT. CL. 9.

ASSOCIATES OF CAPE COD, INCORPORATED, EAST FALMOUTH, MA:
1,069,662, REN. 10-26-06. INT. CL. 1.

ASSURED ACCEPTANCE CORPORATION, OAKDALE, MN:
3,176,312, PUB. 9-12-2006. INT. CL. 35.

ASTELLAS PHARMA INC, TOKYO, JAPAN, WARNER-LAMBERT COMPANY, MORRIS PLAINS, NJ:
2,030,831, REN. 10-23-06. INT. CL. 5.

ASTERES INC., SAN DIEGO, CA:
3,178,306, INT. CL. 9.

ASWAD, NAJLA R., LOUISVILLE, KY:
3,176,839, PUB. 9-12-2006. INT. CL. 30.

AT&T CORP., NEW YORK, NY:
1,948,935, CANC. INT. CL. 35.
2,309,612, CANC. INT. CL. 36.

AT&T WIRELESS SERVICES, INC., REDMOND, WA, MCCAW CELLULAR COMMUNICATIONS, INC., KIRKLAND, WA:
1,949,347, REN. 10-20-06. INT. CL. 38.

ATARI INTERACTIVE, INC., NEW YORK, NY, ATARI, INC., LOS GATOS, CA:
1,050,153, REN. 10-24-06. INT. CL. 28.

ATARI INTERACTIVE, INC., NEW YORK, NY, ATARI CORPORATION, SUNNYVALE, CA:
2,004,406, REN. 10-23-06. INT. CL. 28.

ATEECO, INC., SHENANDOAH, PA:
2,309,467, CANC. INT. CL. 30.

ATHLETICS INCORPORATED, OMAHA, NE:
2,308,749, CANC. MULTIPLE CLASS, INT. CLS. 35 AND 42.

ATLANTA HAWKS, L.P., ATLANTA, GA:
2,010,856, REN. 10-26-06. INT. CL. 41.
2,010,857, REN. 10-26-06. INT. CL. 25.

ATLANTA NATIONAL LEAGUE BASEBALL CLUB, INC., ATLANTA, GA:
2,308,350, CANC. INT. CL. 35.

ATLANTIC RICHFIELD COMPANY, LOS ANGELES, CA:
2,309,692, CANC. INT. CL. 35.

ATLAS ALCHEM PLASTICS, INC., CAPE GIRARDEAU, MO, DBA SPARTECH PLASTICS:
1,988,579, REN. 10-22-06. INT. CL. 17.

ATMEL CORPORATION, SAN JOSE, CA:
3,177,780, INT. CL. 9.

ATRIUM MEDICAL CORPORATION, HUDSON, NH:
3,177,866, INT. CL. 10.

ATRONIC INTERNATIONAL GMBH, LÜBBECKE, FED REP GERMANY:
3,176,079, PUB. 9-12-2006. MULTIPLE CLASS, INT. CLS. 9 AND 28.
3,176,129, PUB. 9-12-2006. MULTIPLE CLASS, INT. CLS. 9 AND 28.

ATTACHMENT TECHNOLOGIES, INC., CEDAR RAPIDS, IA:
3,178,224, INT. CL. 7.

ATTITUDE MEASUREMENT CORPORATION, SOUTHAMPTON, PA:
2,003,722, REN. 10-26-06. MULTIPLE CLASS, INT. CLS. 16 AND 35.

ATX TELECOMMUNICATON SERVICES, LTD., BALA CYNWYD, PA:
2,308,963, CANC. INT. CL. 38.

AU-LITE LIGHTING INC., HSIN CHU HSIEN, TAIWAN:
3,176,088, PUB. 9-12-2006. INT. CL. 11.

AUBURN UNIVERSITY, AUBURN, AL:
3,176,448, PUB. 9-12-2006. INT. CL. 29.

AURORA INNOVATIONS INC., EUGENE, OR:
3,178,138, INT. CL. 1.

AUSTRALIAN BEAUTY SOLUTIONS PTY LTD, AUSTRALIA:
3,177,227, PUB. 9-12-2006. INT. CL. 8.

AUSTUS INVESTMENTS PTY LTD, GLADSTONE PARK VIC 3043, AUSTRALIA:
3,177,193, PUB. 9-12-2006. MULTIPLE CLASS, INT. CLS. 9 AND 25.

AUTHENTIC OZARKS, INC., CHEROKEE VILLAGE, AR:
3,178,554, INT. CL. 20.

AUTO EUROPE, LLC, PORTLAND, ME:
3,176,876, PUB. 9-12-2006. INT. CL. 42.

AUTO VALUE ASSOCIATES, INC., SAN ANTONIO, TX:
2,308,595, CANC. INT. CL. 35.
2,308,596, CANC. INT. CL. 7.
2,308,598, CANC. INT. CL. 35.

AUTOMATED DATA SOLUTIONS, LLC, FLORENCE, KY:
3,177,532, INT. CL. 42.

AUTOMATIC TRANSMISSION PARTS, INC., MORTON GROVE, IL:
2,309,259, CANC. INT. CL. 1.

AUTOMATION RESEARCH SYSTEMS, LIMITED, ALEXANDRIA, VA:
2,308,776, CANC. MULTIPLE CLASS, INT. CLS. 9, 16, 36 AND 38.

AUTONET USA, INC, PHOENIX, AZ:
3,176,614, PUB. 9-12-2006. INT. CL. 42.

AUTOWORKX, INC., NEENAH, WI:
2,309,108, CANC. INT. CL. 37.

AVACUS CORPORATION, SANTA MONICA, CA:
3,177,435, INT. CL. 35.

AVEDA CORPORATION, MINNEAPOLIS, MN:
3,178,579, INT. CL. 3.

AVERY DENNISON CORPORATION, PASADENA, CA:
3,175,796, PUB. 9-12-2006. INT. CL. 16.

AVIATION SALES COMPANY, MIAMI, FL:
2,309,261, CANC. INT. CL. 35.
2,309,267, CANC. INT. CL. 40.

AVID TECHNOLOGY, INC., TEWKSBURY, MA:
3,178,240, INT. CL. 9.

AVON PLASTICS, INC., ALBANY, MN, DBA MASTER MARK PLASTIC PRODUCTS:
1,947,986, CANC. MULTIPLE CLASS, INT. CLS. 19 AND 20.

AVON PRODUCTS, INC., NEW YORK, NY:
3,178,448, INT. CL. 3.

AWARDS AND RECOGNITION ASSOCIATION, INC., GLENVIEW, IL:
3,176,570, PUB. 9-12-2006. INT. CL. 35.

AXIOS CORPORATION, SEATTLE, WA:
2,309,550, CANC. INT. CL. 16.
2,309,551, CANC. INT. CL. 16.

- AXIS DENTAL CORPORATION, IRVING, TX:
3,175,906, PUB. 9-12-2006. INT. CL. 10.
- AXIUM HEALTHCARE PHARMACY, INC., LAKE MARY, FL:
3,178,156, INT. CL. 44.
- AYNEHCHI, SHAHRAM, TUSTIN, CA:
3,176,465, PUB. 9-12-2006. INT. CL. 12.
- AZIENDA VINICOLA FALESCO S.R.L., CASTEL VISCARDO, TERNI, ITALY:
2,964,883, AM. INT. CL. 33.
- AZOTIC COATING TECHNOLOGY, INC., ROCHESTER, MN:
3,178,558, INT. CL. 14.
- AZTEC FINANCE CORPORATION, PORT LOUIS, MAURITIUS:
2,937,208, CANC. INT. CL. 3.
- B & D SPECIALTY CONCEPTS, INC., SHAKER HEIGHTS, OH:
3,178,496, INT. CL. 28.
- B & P COMPANY, INC., DAYTON, OH:
3,176,291, PUB. 9-12-2006. INT. CL. 3.
- B CLEAR, INC., SAN DIEGO, CA:
3,175,999, PUB. 9-12-2006. INT. CL. 5.
- BABYDISH, INC., SHERMAN OAKS, CA:
3,176,861, PUB. 9-12-2006. INT. CL. 18.
3,176,862, PUB. 9-12-2006. INT. CL. 18.
- BACKHAUSEN INTERIOR TEXTILES GMBH, A-3945 HOHENEICH, AUSTRIA:
3,177,296, PUB. 9-12-2006. MULTIPLE CLASS, INT. CLS. 14, 16, 18, 21, 24, 25 AND 27.
- BACKUPANDBURN LLC, NORTHVILLE, MI:
3,176,637, PUB. 9-12-2006. INT. CL. 9.
- BAETIS, INC., OKLAHOMA CITY, OK:
2,309,888, CANC. MULTIPLE CLASS, INT. CLS. 36 AND 41.
- BAGEL BAGEL FRANCHISE SYSTEMS, INC., TAMPA, FL:
3,176,044, PUB. 9-12-2006. INT. CL. 43.
- BAHARI ENTERPRISES INC., GREENPORT, NY:
3,177,710, INT. CL. 31.
- BAILEY, CHARLES, OKEECHOBEE, FL:
2,309,896, CANC. INT. CL. 7.
- BAILEY, WAYNE E., FREDERICKSBURG, VA:
3,178,528, INT. CL. 19.
- BAKER MANUFACTURING COMPANY, INC., PINEVILLE, LA:
1,949,078, CANC. INT. CL. 20.
- BALLARD, STEVE R., MANHATTAN, KS:
3,178,819, INT. CL. 25.
- BAMBERGER KALIKO GMBH, 96052 BAMBERG, FED REP GERMANY:
3,177,366, INT. CL. 24.
- BANC STOCK FINANCIAL SERVICES, INC., COLUMBUS, OH:
2,308,553, CANC. INT. CL. 36.
- BANC STOCK GROUP, INC., THE, COLUMBUS, OH:
2,308,552, CANC. INT. CL. 36.
- BAND-IT-IDEX, INC., DENVER, CO:
3,178,283, INT. CL. 6.
- BANDIT BREWING COMPANY, PAHRUMP, NV:
2,308,833, CANC. INT. CL. 32.
- BANGKOK BROADCASTING & TV CO., LTD., BANGKOK, THAILAND:
3,176,451, PUB. 9-12-2006. MULTIPLE CLASS, INT. CLS. 9, 38 AND 41.
- BANK OF AMERICA CORPORATION, CHARLOTTE, NC:
2,308,221, CANC. MULTIPLE CLASS, INT. CLS. 35, 36 AND 39.
- BANK OF AMERICA, N.A., CHARLOTTE, NC:
2,309,542, CANC. INT. CL. 16.
- BANKAMERICA CORPORATION, SAN FRANCISCO, CA:
1,378,631, CANC. U.S. CL. 200.
- BANKS, JAMES MATTHEW, JR., INDIANAPOLIS, IN:
3,175,907, PUB. 9-12-2006. INT. CL. 16.
- BAPA FINE FOODS, LLC, FULTON, MD:
3,176,618, PUB. 9-12-2006. INT. CL. 29.
- BAPE CO., LTD., JAPAN:
3,177,270, PUB. 9-12-2006. INT. CL. 25.
- BARCLAYS BANK PLC, LONDON, UNITED KINGDOM:
3,178,587, INT. CL. 36.
3,178,640, INT. CL. 36.
3,178,641, INT. CL. 36.
- BARFLY DEVELOPMENT TEAM, LLC, NEW YORK, NY:
3,177,086, PUB. 9-12-2006. INT. CL. 41.
- BARKING IRONS, LTD., NEW YORK, NY:
3,176,336, PUB. 9-12-2006. INT. CL. 25.
- BARNES & NOBLE, INC., NEW YORK, NY:
3,178,149, INT. CL. 16.
- BARNES, RUTH, ST. LOUIS PARK, MN:
3,175,871, PUB. 9-12-2006. INT. CL. 21.
- BARNET PRODUCTS CORP., ENGLEWOOD CLIFFS, NJ:
3,176,813, PUB. 9-12-2006. INT. CL. 4.
- BARNETT, KEVIN, PERRIS, CA:
2,309,350, CANC. INT. CL. 37.
- BARRACUDA HOLDINGS LIMITED, BATH BA1 5BD, UNITED KINGDOM:
3,175,848, PUB. 9-12-2006. MULTIPLE CLASS, INT. CLS. 35 AND 42.
- BARRETT, PATRICK, HOUSTON, TX:
2,309,215, CANC. INT. CL. 16.
- BARRETT, RON W, SAN DIEGO, CA AND BARRETT, BARBARA, SAN DIEGO, CA:
3,176,600, PUB. 9-12-2006. INT. CL. 9.
- BARRETT, THOMAS MICHAEL, LK. HIAWATHA, NJ:
2,309,478, CANC. INT. CL. 30.
- BARROWS, JENNIFER T, AVON, CT:
3,178,308, INT. CL. 42.
- BARRY'S BOOTCAMP LLC, HIDDEN HILLS, CA:
3,178,015, INT. CL. 41.
- BARTLESON, LINDA JEANNE, FLOWERY BRANCH, GA:
1,995,272, REN. 10-24-06. INT. CL. 28.
- BARTON BRANDS, LTD., CHICAGO, IL:
3,177,166, PUB. 9-12-2006. INT. CL. 33.
3,177,167, PUB. 9-12-2006. INT. CL. 33.
3,177,168, PUB. 9-12-2006. INT. CL. 33.
3,177,169, PUB. 9-12-2006. INT. CL. 33.
3,177,170, PUB. 9-12-2006. INT. CL. 33.
3,177,171, PUB. 9-12-2006. INT. CL. 33.
3,177,172, PUB. 9-12-2006. INT. CL. 33.
3,177,173, PUB. 9-12-2006. INT. CL. 33.
3,177,174, PUB. 9-12-2006. INT. CL. 33.
3,178,115, INT. CL. 33.
- BARTON, MARY, FORT PIERCE, FL:
3,178,712, INT. CL. 25.
- BASF AKTIENGESELLSCHAFT, LUDWIGSHAFEN, FED REP GERMANY:
1,377,766, CANC. INT. CL. 1.
- BATISTE, LIONEL, RIVERDALE, GA:
3,176,718, PUB. 9-12-2006. INT. CL. 45.
- BATTAT INCORPORATED, PLATTSBURGH, NY:
3,178,274, INT. CL. 16.
3,178,391, INT. CL. 28.
- BAUMBICH, CHARLENE ANN, GLENN ELLYN, IL:
2,309,348, CANC. INT. CL. 41.
- BAUMEISTER AUDIO VIDEO INTERIORS, INCORPORATED, NILES, IL, DBA BAUMEISTER ELECTRONIC ARCHITECTS:
3,178,572, INT. CL. 37.
- BAUMÜLLER ANLAGEN-SYSTEMTECHNIK GMBH & CO., FED REP GERMANY:
3,177,220, PUB. 9-12-2006. INT. CL. 9.
- BAUSCH & LOMB INCORPORATED, ROCHESTER, NY:
2,309,665, CANC. INT. CL. 9.
- BAYER AKTIENGESELLSCHAFT, LEVERKUSEN, FED REP GERMANY, ARCO CHEMICAL COMPANY, NEW-TOWN SQUARE, PA:
1,987,420, REN. 10-24-06. INT. CL. 17.
- BAYER AKTIENGESELLSCHAFT, LEVERKUSEN-BAYER-WERK, FED REP GERMANY:
3,178,392, INT. CL. 1.
- BAYER CROPSCIENCE LP, RESEARCH TRIANGLE PARK, NC:
1,378,639, CANC. INT. CL. 1.
- BAYERISCHE MOTOREN WERKE AKTIENGESELLSCHAFT, FED REP GERMANY:
3,177,310, PUB. 9-12-2006. INT. CL. 12.

BAYLOR UNIVERSITY, WACO, TX:
 2,308,634, CANC. MULTIPLE CLASS, INT. CLS. 21 AND 25.
 BAYUK, DIANE W, HELENA, MT:
 3,178,279, INT. CL. 16.
 BAYVIEW FINANCIAL, L.P., CORAL GABLES, FL:
 3,176,794, PUB. 9-12-2006. INT. CL. 36.
 BCI SYSTEMS, INCORPORATED, KINNELON, NJ:
 2,309,538, CANC. INT. CL. 9.
 BD ENGINE BRAKE INC., BRITISH COLUMBIA, CANADA:
 1,948,334, CANC. MULTIPLE CLASS, INT. CLS. 7 AND 37.
 BE AWESOME, INC., SOUTHLAKE, TX:
 3,178,212, INT. CL. 25.
 BEACON CHEMICAL CO., INC., MOUNT VERNON, NY:
 1,412,834, REN. 10-26-06. INT. CL. 1.
 1,417,097, REN. 10-26-06. INT. CL. 1.
 BEANS & MACHINES INC., PROVINCETOWN, MA:
 3,176,720, PUB. 9-12-2006. INT. CL. 43.
 BEATREME FOODS, INC., BELOIT, WI TO KERRY INC., BELOIT, WI:
 1,949,468, CANC. INT. CL. 30.
 BEAUTY ESSENCE, INC., NEW YORK, NY:
 3,176,730, PUB. 9-12-2006. INT. CL. 26.
 BECHRIS, INC., SEATTLE, WA:
 3,176,057, PUB. 9-12-2006. INT. CL. 20.
 BECHT ENGINEERING CO., INC., LIBERTY CORNER, NJ:
 3,175,861, PUB. 9-12-2006. INT. CL. 42.
 BECKER GROUP, INC., STERLING HEIGHTS, MI:
 2,308,288, CANC. INT. CL. 40.
 BECKETT PUBLICATIONS, INC., DALLAS, TX:
 2,309,657, CANC. INT. CL. 16.
 BECTON, MILFORD GLENDALE, SEAFORD, DE:
 2,309,508, CANC. INT. CL. 24.
 BEDFORD ACQUISITION CORP., TORONTO, CANADA:
 2,309,632, CANC. INT. CL. 28.
 BEE-GEE SHOE CORP., THE, DAYTON, OH TO SHOE SHOW, INC., CONCORD, NC:
 1,949,706, CANC. INT. CL. 25.
 BEIT T'SHUVAH, HCKENSACK, NJ:
 3,177,565, INT. CL. 14.
 BELA BROADCASTING, LLC, MIAMI, FL:
 3,176,282, PUB. 9-12-2006. INT. CL. 41.
 BELCORP OF AMERICA INC., MIAMI, FL:
 3,108,616, CANC. IIRN. RESTORED TO S.N. 78-349,657.
 BELDEN TECHNOLOGIES, INC, ST. LOUIS, MO, ALPHA WIRE CORPORATION, ELIZABETH, NJ:
 2,058,525, REN. 10-24-06. MULTIPLE CLASS, INT. CLS. 8, 9, 11, 17 AND 20.
 BELL ATLANTIC NETWORK SERVICES, INC., ARLINGTON, VA TO BELL ATLANTIC NETWORK SERVICES, INC., ARLINGTON, VA:
 1,948,698, CANC. INT. CL. 42.
 BELL ATLANTIC NETWORK SERVICES, INC., ARLINGTON, VA TO VERIZON SERVICES CORP., ARLINGTON, VA:
 1,948,699, CANC. INT. CL. 42.
 BELL KNITTING, LOS ANGELES, CA:
 3,176,672, PUB. 9-12-2006. INT. CL. 24.
 BELL SPORTS, INC., IRVING, TX:
 3,177,964, INT. CL. 11.
 3,177,965, MULTIPLE CLASS, INT. CLS. 12 AND 28.
 BELLO MACHRE, INC., PASADENA, MD:
 3,176,027, PUB. 9-12-2006. INT. CL. 43.
 BELL SOUTH INTELLECTUAL PROPERTY CORPORATION, WILMINGTON, DE:
 2,308,364, CANC. MULTIPLE CLASS, INT. CLS. 36 AND 42.
 2,309,057, CANC. INT. CL. 36.
 3,177,729, INT. CL. 38.
 BELRHITI, LARBI, LONGUEIL, QUEBEC, CANADA:
 3,176,726, PUB. 9-12-2006. INT. CL. 41.
 BEMCO ASSOCIATES, INC., DES PLAINES, IL:
 1,046,392, REN. 10-26-06. INT. CL. 20.
 BEN & JERRY'S HOMEMADE, INC., VERMONT, VT:
 3,177,901, INT. CL. 30.
 BENCONE, INC., WESTWOOD, NJ:
 1,378,569, CANC. INT. CL. 42.
 BENEFIT PLANS ADMINISTRATIVE SERVICES, INC., UTICA, NY:
 3,176,461, PUB. 9-12-2006. INT. CL. 36.
 BENETTON GROUP S.P.A., 31050 PONZANO VENETO (TREVISO), ITALY:
 2,308,131, CANC. INT. CL. 25.
 BENGTON, BRADLEY P, GRAND RAPIDS, MI:
 3,176,265, PUB. 9-12-2006. INT. CL. 19.
 BENTLEY COLLEGE, WALTHAM, MA:
 1,948,020, CANC. INT. CL. 41.
 BENTLEY LINGERIE, INC., JERSEY CITY, NJ:
 1,832,257, CANC. INT. CL. 25.
 BENTZ WHALEY FLESSNER, INC., MINNEAPOLIS, MN:
 2,308,808, CANC. INT. CL. 35.
 BENZUR, ISAAC, MYRTLE BEACH, SC:
 2,309,291, CANC. INT. CL. 36.
 BERG EQUIPMENT & SCAFFOLDING CO., INC., TACOMA, WA:
 2,041,954, REN. 10-26-06. INT. CL. 7.
 BERGER, SCOTT A., DENVER, CO:
 3,177,809, INT. CL. 37.
 BERGMAN, JOHN, SCOTTSDALE, AZ:
 3,177,884, INT. CL. 36.
 BERKLINE CORPORATION, THE, MORRISTOWN, TN:
 2,309,120, CANC. INT. CL. 20.
 BERNARD FOOD INDUSTRIES, INC., EVANSTON, IL:
 1,372,887, REN. 10-26-06. INT. CL. 30.
 BERNHARDT APPARATEBAU GMBH U. CO., 2000 WEDEL, FED REP GERMANY:
 1,995,828, REN. 10-26-06. INT. CL. 9.
 BERRY, DONALD J., FLOWER MOUND, TX, DBA YRLIC:
 3,177,818, INT. CL. 9.
 BERU AKTIENGESELLSCHAFT, LUDWIGSBURG, GERMAN DEM REP:
 1,993,359, REN. 10-26-06. INT. CL. 7.
 BEST BUY ENTERPRISE SERVICES, INC., RICHFIELD, MN:
 3,178,660, INT. CL. 16.
 BEST LOCK CORPORATION, INDIANAPOLIS, IN:
 207,165, REN. 10-23-06. U.S. CL. 25 (INT. CL. 6).
 BETA PHARMACEUTICAL INC, WESTON, FL:
 3,178,421, INT. CL. 5.
 BETA S.N.C. DI SALVADORI RENZO & C., 50015 IMPRUNETA, FLORENCE, ITALY TO STIPULA FIRENZE S.R.L., 50142 FIRENZE, ITALY:
 1,948,198, CANC. INT. CL. 16.
 BETZOLD BERG INVESTMENT MANAGEMENT, INC., ITASCA, IL:
 1,949,655, CANC. INT. CL. 41.
 BEVERAGE MARKETING USA, INC., LARCHMONT, NY:
 1,948,839, CANC. INT. CL. 32.
 BGS SYSTEMS, INC., WALTHAM, MA TO BMC SOFTWARE, INC., HOUSTON, TX:
 1,948,452, CANC. INT. CL. 9.
 BHA GROUP, INC., KANSAS CITY, MO:
 1,047,428, REN. 10-23-06. INT. CL. 1.
 BIAGIO'S GOURMET FOODS, INC., ELK GROVE VILLAGE, IL:
 2,309,930, CANC. INT. CL. 30.
 BIEDERLACK G.M.B.H. & CO. K.G., CUMBERLAND, MD:
 1,378,140, CANC. INT. CL. 24.
 BIG FOOT GOLF, LTD., LOUISVILLE, KY:
 2,308,465, CANC. INT. CL. 25.
 BIG HEADS MANAGEMENT, INC., RICHBORO, PA:
 3,176,155, PUB. 9-12-2006. INT. CL. 43.
 BIG HEN GROUP I, LLC, PALO ALTO, CA:
 3,176,775, PUB. 9-12-2006. INT. CL. 41.
 BIG HORSE INCORPORATED, SAN FRANCISCO, CA:
 2,308,478, CANC. INT. CL. 9.
 BIG M, INC., TOTOWA, NJ:
 1,378,209, CANC. INT. CL. 25.
 BIG PIG INC., BALDWIN, NY:
 2,308,992, CANC. INT. CL. 41.
 BIG TEN PRODUCTIONS INC., HOUSTON, TX:
 2,309,203, CANC. INT. CL. 42.

- BIG TIME PRODUCTS, L.L.C., ROME, GA:
3,177,825, INT. CL. 9.
3,178,514, MULTIPLE CLASS, INT. CLS. 9, 21 AND 25.
3,178,515, INT. CL. 9.
- BIGFISH IMPORTS LLC, OAK HARBOR, WA:
3,177,890, INT. CL. 24.
- BIKETRIP.COM INCORPORATED, ANDOVER, MN:
3,178,420, INT. CL. 41.
- BILCE TEKSTIL SANAYI VE DIS TICARET ANONIM SIRKETI, TURKEY:
3,177,272, PUB. 9-12-2006. INT. CL. 25.
- BILL COBB PRODUCTIONS, INC., INDIALANTIC, FL:
3,176,321, PUB. 9-12-2006. INT. CL. 25.
- BILLINGS, ROGER E., GALLATIN, MO, DBA BILLINGS INTELLECTUAL PROPERTIES:
1,948,539, CANC. INT. CL. 9.
- BIMBA MANUFACTURING COMPANY, MONEE, IL:
2,050,733, REN. 10-24-06. INT. CL. 7.
- BINNEY & SMITH PROPERTIES, INC., EASTON, PA:
3,177,981, INT. CL. 16.
3,177,982, INT. CL. 28.
- BIO SAN LABORATORIES, INC., DERRY, NH:
3,177,385, INT. CL. 5.
3,177,386, INT. CL. 5.
3,177,387, INT. CL. 5.
- BIO-ORGANIC CATALYST, INC., COSTA MESA, CA:
3,177,798, INT. CL. 1.
- BIO-ORTHOTICS INTERNATIONAL, INC., PLANO, TX:
2,028,924, REN. 10-25-06. INT. CL. 10.
- BIOMET MANUFACTURING CORP., WARSAW, IN:
3,176,481, PUB. 9-12-2006. INT. CL. 41.
- BIOMIMETIC THERAPEUTICS, INC., FRANKLIN, TN:
3,177,388, INT. CL. 5.
- BIONICHE LIFE SCIENCES INC., BELLEVILLE, ONTARIO, CANADA:
3,176,023, PUB. 9-12-2006. INT. CL. 5.
- BIOSTIM, L.L.C., SAN ANTONIO, TX:
3,175,900, PUB. 9-12-2006. INT. CL. 3.
- BIOSYN, INC., HARAHAN, LA:
3,176,428, PUB. 9-12-2006. INT. CL. 42.
- BIO THERM, MONACO, MONACO:
1,948,375, CANC. INT. CL. 3.
- BIOTREASURES, INC., PRESCOTT VALLEY, AZ:
2,377,345, CANC. INT. CL. 35.
- BIRD PRODUCTS CORPORATION, PALM SPRINGS, CA:
1,948,874, CANC. INT. CL. 9.
- BIRKHEAD, MARK WILLIAM, MARINA DEL REY, CA:
3,176,053, PUB. 9-12-2006. INT. CL. 41.
- BIRMINGHAM ATHLETIC CLUB LLC, LEXINGTON, KY:
3,176,158, PUB. 9-12-2006. INT. CL. 44.
- BIRRAPORETTI'S RESTAURANTS SERVICE, INC., HOUSTON, TX:
1,378,630, CANC. INT. CL. 42.
- BITE ME! BISCUITS, INC., FRANKLIN, MA:
2,309,347, CANC. INT. CL. 31.
- BIZNIK LLC, SEATTLE, WA:
3,176,811, PUB. 9-12-2006. INT. CL. 35.
- BIZZOCO, DENNIS L., CHATTANOOGA, TN:
1,992,542, REN. 10-20-06. INT. CL. 16.
- BÉQUET CONFECTIONS, BOZEMAN, MT:
3,176,512, PUB. 9-12-2006. INT. CL. 30.
- BJN FOODS INC., SELDEN, NY:
2,309,429, CANC. INT. CL. 42.
- BJN FOODS, INC., SELDEN, NY:
2,309,430, CANC. INT. CL. 42.
- BKI HOLDING CORPORATION, WILMINGTON, DE:
3,177,423, INT. CL. 17.
- BLACK & DECKER CORPORATION, THE, TOWSON, MD:
1,948,454, CANC. INT. CL. 7.
- BLACK DIAMOND BREWING COMPANY, INC., CONCORD, CA:
2,026,548, REN. 10-26-06. INT. CL. 42.
- BLACKPOWDER PRODUCTS, INC., NORCROSS, GA:
3,178,179, INT. CL. 13.
- BLACKSTONE MEDICAL, INC., SPRINGFIELD, MA:
3,177,831, INT. CL. 10.
- BLACKTALON INDUSTRIES, INC., NAPA, CA:
3,177,118, PUB. 9-12-2006. INT. CL. 41.
- BLADDER CANCER ADVOCACY NETWORK, BETHESDA, MD:
3,176,597, PUB. 9-12-2006. INT. CL. 35.
- BLADE-TECH INDUSTRIES, INC., LAKEWOOD, WA:
3,178,729, INT. CL. 8.
- BLAKE-CALVERT, COLLEEN, ARLINGTON, TX:
3,176,070, PUB. 9-12-2006. INT. CL. 36.
- BLAKLEY, MARK, SAN CLEMENTE, CA:
3,176,770, PUB. 9-12-2006. INT. CL. 45.
- BLANDIN PAPER COMPANY, GRAND RAPIDS, MN:
2,308,652, CANC. INT. CL. 16.
2,308,653, CANC. INT. CL. 16.
2,308,654, CANC. INT. CL. 16.
- BLASER SWISSLUBE AG, SWITZERLAND:
3,177,238, PUB. 9-12-2006. MULTIPLE CLASS, INT. CLS. 1 AND 4.
- BLISS WORLD LLC, NEW YORK, NY:
3,178,166, INT. CL. 3.
- BLISTEX INC., OAK BROOK, IL:
3,178,653, INT. CL. 5.
3,178,654, INT. CL. 5.
- BLOCK SALES AND DISTRIBUTING, INC., PARK CITY, UT:
1,949,482, CANC. MULTIPLE CLASS, INT. CLS. 16, 21 AND 25.
- BLOGWIRE HUNGARY SZELLEMI ALKOTÁST CORPORATION, BUDAPEST, HUNGARY:
3,177,176, PUB. 9-12-2006. INT. CL. 41.
- BLOOMBERG L.P., NEW YORK, NY:
3,177,119, PUB. 9-12-2006. INT. CL. 36.
- BLUE CIRCLE INDUSTRIES PUBLIC LIMITED COMPANY, LONDON, W1V 1PX, ENGLAND:
1,948,400, CANC. INT. CL. 19.
- BLUE COAST PRODUCTIONS, LLC, BROADVIEW HEIGHTS, OH:
3,176,477, PUB. 9-12-2006. INT. CL. 41.
- BLUE CROSS AND BLUE SHIELD OF MICHIGAN, DETROIT, MI:
3,116,387, CANC. INT. CL. 44.
- BLUE SKY INSPIRATIONS, LLC, MINNEAPOLIS, MN:
3,176,879, PUB. 9-12-2006. MULTIPLE CLASS, INT. CLS. 41 AND 45.
3,176,888, PUB. 9-12-2006. MULTIPLE CLASS, INT. CLS. 41 AND 45.
- BLUEPOINTE PROPERTY GROUP LLC, MOON TOWNSHIP, PA:
3,176,644, PUB. 9-12-2006. INT. CL. 36.
- BMA DATA PROCESSING, INC., SALT LAKE CITY, UT:
1,377,957, CANC. INT. CL. 9.
- BMRB INTERNATIONAL LIMITED, EALING, LONDON W5 5SU, ENGLAND:
2,308,181, CANC. INT. CL. 35.
- BOARD OF TRADE OF THE CITY OF CHICAGO, CHICAGO, IL:
1,843,860, REN. 10-23-06. INT. CL. 36.
- BOARD OF TRUSTEES OF FORDHAM UNIVERSITY, NEW YORK, NY:
1,378,506, CANC. MULTIPLE CLASS, INT. CLS. 41 AND 42.
- BOARDBUG LIMITED, LONDON, UNITED KINGDOM:
3,175,975, PUB. 1-24-2006. MULTIPLE CLASS, INT. CLS. 9, 38 AND 42.
- BOATMAN'S COFFEE, INC, MT. VERNON, WA:
2,309,322, CANC. INT. CL. 42.
- BOATMAN'S COFFEE, INC., MT. VERNON, WA:
2,309,326, CANC. INT. CL. 42.
- BOATRRIGHT, FAYE J., HOBOKEN, NJ:
3,177,975, INT. CL. 16.
- BOAZ AND RUTH, INC., RICHMOND, VA:
3,176,048, PUB. 9-12-2006. INT. CL. 41.
- BODEK & RHODES, PHILADELPHIA, PA:
3,178,002, MULTIPLE CLASS, INT. CLS. 24 AND 25.
- BODY POD LIMITED, YEOVIL, SOMERSET, UNITED KINGDOM:
3,176,546, PUB. 7-4-2006. INT. CL. 28.
- BOEHRINGER INGELHEIM VETMEDICA GMBH, D-55216 INGELHEIM AM RHEIN, FED REP GERMANY:
2,308,956, CANC. INT. CL. 5.

BOHAN GROUP LLC, SAN FRANCISCO, CA:
3,177,362, INT. CL. 36.

BOISE CASCADE OFFICE PRODUCTS CORPORATION,
ITASCA, IL:
2,308,287, CANC. INT. CL. 2.
2,309,885, CANC. INT. CL. 35.

BOLT PETERS, INC., SAN FRANCISCO, CA:
3,176,398, PUB. 9-12-2006. MULTIPLE CLASS, INT. CLS. 9
AND 42.

BOMBARDIER RECREATIONAL PRODUCTS INC., VAL-
COURT, QUEBEC, CANADA:
3,177,684, INT. CL. 12.

BOMBARDIER TRANSPORTATION GMBH, BERLIN, FED
REP GERMANY:
2,308,758, CANC. MULTIPLE CLASS, INT. CLS. 9, 12, 16
AND 37.

BON JOUR INTERNATIONAL, LTD., NEW YORK, NY:
1,378,034, CANC. MULTIPLE CLASS, INT. CLS. 14, 18
AND 25.

BOND, JARRELL L., LOUISVILLE, KY:
2,309,307, CANC. INT. CL. 42.

BONE-A-FIDE FITNESS, LLC, RIDGEFIELD, CT:
3,178,751, INT. CL. 28.

BONIDE PRODUCTS, INC., ORISKANY, NY:
3,176,976, PUB. 9-12-2006. INT. CL. 5.
3,177,154, PUB. 9-12-2006. INT. CL. 5.

BONNEVILLE INTERNATIONAL CORPORATION, SALT
LAKE CITY, UT:
1,378,467, CANC. INT. CL. 38.

BOOK WHOLESALERS, INC., LEXINGTON, KY:
2,309,412, CANC. INT. CL. 35.

BOOK-OF-THE-MONTH-CLUB, INC., NEW YORK, NY:
3,176,966, PUB. 9-12-2006. INT. CL. 16.

BOOKETTE SOFTWARE COMPANY, MONTEREY, CA:
3,176,958, PUB. 9-12-2006. INT. CL. 41.
3,176,959, PUB. 9-12-2006. INT. CL. 41.

BOOKSPAN, GARDEN CITY, NY:
3,177,107, PUB. 9-12-2006. MULTIPLE CLASS, INT. CLS.
35, 39 AND 41.

BOONE BELL, INC., LAKEWOOD, OH:
2,309,664, CANC. INT. CL. 3.

BOOSALIS, CHRIS NICHOLAS, MODESTO, CA:
3,176,598, PUB. 9-12-2006. INT. CL. 41.

BOOTLEG PRODUCTIONS, L.C., ST. LOUIS, MO:
2,309,569, CANC. INT. CL. 9.

BORDERS PROPERTIES, INC., ANN ARBOR, MI:
1,996,858, REN. 10-26-06. INT. CL. 42.

BORDERS PROPERTIES, INC., ANN ARBOR, MI, BORDERS
PROPERTIES, INC., ANN ARBOR, MI:
2,044,230, REN. 10-26-06. INT. CL. 38.

BORDONE, RICHARD BRYCE, FAYETTEVILLE, NC:
3,176,744, PUB. 9-12-2006. INT. CL. 41.

BORGES USA, INC., FRESNO, CA:
3,177,109, PUB. 9-12-2006. MULTIPLE CLASS, INT. CLS.
29 AND 30.

BORYUNG MEDIENCE CO., LTD., CHONGRO-KU, SEOUL,
REPUBLIC OF KOREA:
3,178,317, INT. CL. 3.

BOSCO PRODUCTS, INC., TOWACO, NJ:
1,444,318, REN. 10-25-06. INT. CL. 30.
2,089,220, REN. 10-25-06. INT. CL. 30.

BOTTLENOTES, INC., PALO ALTO, CA:
3,178,451, INT. CL. 35.

BOUNTIFUL WIFI LLC, BOUNTIFUL, UT:
3,176,979, PUB. 9-12-2006. INT. CL. 9.

BOYD FLOTATION, INC., MARYLAND HEIGHTS, MO:
3,178,311, INT. CL. 20.
3,178,312, INT. CL. 24.
3,178,313, INT. CL. 20.

BOYER BROS., INC., ALTOONA, PA:
1,378,320, CANC. INT. CL. 30.

BPG PROPERTIES, LTD., YARDLEY, PA:
3,178,403, INT. CL. 36.
3,178,404, INT. CL. 36.

BRADFORD FEDERAL SAVINGS BANK, BALTIMORE,
MD:
2,309,471, CANC. INT. CL. 36.

BRADLEY, AIDAN, SANTA BARBARA, CA:
3,176,235, PUB. 9-12-2006. INT. CL. 16.

BRAGG, JOAN, VERO BEACH, FL:
3,176,895, PUB. 9-12-2006. INT. CL. 28.
3,176,896, PUB. 9-12-2006. INT. CL. 28.

BRAINBENCH, INC., CHANTILLY, VA:
3,176,525, PUB. 9-12-2006. INT. CL. 35.

BRANDRUD FURNITURE INC., AUBURN, WA:
3,177,925, INT. CL. 20.

BRANDS4LESS LLC, PLEASANTVILLE, NY:
2,310,031, CANC. INT. CL. 35.

BRANOVAN, DANIEL I., BRONX, NY:
2,308,915, CANC. INT. CL. 42.

BRANT, STACIE L., SPRING, TX:
3,178,521, INT. CL. 25.

BRAR, HARINDER SINGH, SNOHOMISH, WA:
2,909,325, CANC. INT. CL. 16.
2,955,861, CANC. INT. CL. 35.

BRASSEUR, INC., LOS ANGELES, CA:
2,028,928, REN. 10-25-06. INT. CL. 25.

BRAVO COMPANY, WOODBURY, NY:
2,308,189, CANC. MULTIPLE CLASS, INT. CLS. 38 AND
41.

BRAYDEN AUTOMATION CORPORATION, LOVELAND,
CO:
1,994,208, REN. 10-25-06. INT. CL. 9.
2,002,843, REN. 10-25-06. INT. CL. 9.

BREAKING PLATEAUS, LLC, HOLBROOK, NY:
3,176,810, PUB. 9-12-2006. INT. CL. 41.

BREAKMANX.COM, INC., LAWRENCE, KS:
3,176,360, PUB. 9-12-2006. INT. CL. 41.

BREAKTHROUGH LEARNING, INC., MORGAN HILL, CA:
3,177,762, MULTIPLE CLASS, INT. CLS. 9 AND 41.

BREATHPATROL INC., WATERLOO, ONTARIO, CANADA
TO BREATHPATROL INC., WATERLOO, ONTARIO,
CANADA:
1,949,345, CANC. INT. CL. 30.

BRESLIN, DANIEL V., PHILADELPHIA, PA:
3,177,360, INT. CL. 16.

BRESNAN, DANIEL, WASHINGTON, CT:
3,178,782, INT. CL. 15.

BRICK PACKAGING, LLC, TRAVERSE CITY, MI:
3,178,460, INT. CL. 16.

BRIDGESTONE CORPORATION, TOKYO, JAPAN:
3,175,794, PUB. 5-30-2006. MULTIPLE CLASS, INT. CLS.
7, 9, 11, 12, 17, 18, 19, 20, 24, 25, 27, 28 AND 37.

BRIGHTHOME FURNITURE MANUFACTURING, MAN-
CHESTER, NH:
3,176,439, PUB. 9-12-2006. INT. CL. 20.

BRINKER INTERNATIONAL HOLDINGS, L.P., DALLAS,
TX:
3,177,186, PUB. 9-12-2006. INT. CL. 43.

BRINTON, WILLIAM W., SONOMA, CA:
3,178,186, INT. CL. 33.

BRIO CORPORATION, GERMANTOWN, WI:
2,310,025, CANC. INT. CL. 28.

BRISTOL ALASKAN, WASILLA, AK, DBA BRISTOL ALAS-
KAN:
2,309,381, CANC. INT. CL. 29.

BRISTOL-MYERS SQUIBB COMPANY, NEW YORK, NY:
3,177,610, INT. CL. 35.

BRITOS, PETER, HONOLULU, HI, DBA BLACK SAND
HAWAII CLOTHING COMPANY:
2,308,143, CANC. INT. CL. 25.

BRIZOT, JEAN-YVES, 38120 LE FONTANIL CORNILLON,
FRANCE:
2,308,814, CANC. INT. CL. 39.
2,308,817, CANC. INT. CL. 14.

BROOKSBURR, INC, ATLANTA, GA, DBA DIGITALEVI-
DENCE:
2,309,418, CANC. INT. CL. 42.

BROWN & BIGELOW, INC., ST. PAUL, MN:
2,310,039, CANC. INT. CL. 28.

BROWN & WILLIAMSON TOBACCO CORPORATION,
LOUISVILLE, KY:
2,309,891, CANC. INT. CL. 16.

- BROWN, CHARLOTTE, POINT PIPER NSW 2027, AUSTRALIA:
2,905,432, CANC. INT. CL. 25.
- BROWN, HOWARD T., VENTURA, CA:
3,177,608, INT. CL. 18.
- BROWN, KEITH M, PLANO, TX:
3,178,795, MULTIPLE CLASS, INT. CLS. 8 AND 26.
- BROWN, ROBERT A., JR., GREENVILLE, SC:
1,377,844, CANC. INT. CL. 5.
- BROWN, TODD & HEYBURN PLLC, LOUISVILLE, KY:
2,309,479, CANC. INT. CL. 42.
- BRUCE KIRBY, INC., ROWAYTON, CT:
3,178,738, INT. CL. 12.
- BRUCHER, JONATHAN, ORANGE, CA:
3,177,050, PUB. 9-12-2006. MULTIPLE CLASS, INT. CLS. 25 AND 40.
- BRUKER DALTONIK GMBH, D-28359 BREMEN, FED REP GERMANY:
3,175,811, PUB. 9-12-2006. INT. CL. 9.
- BRUNNER, BARBARA, PUNTA GORDA, FL:
3,175,773, PUB. 9-12-2006. INT. CL. 3.
- BRUNSWICK CORPORATION, LAKE FOREST, IL:
2,309,100, CANC. INT. CL. 12.
- BRYCE FAMILY ENTERPRISES, INC., BASYE, VA:
2,309,462, CANC. MULTIPLE CLASS, INT. CLS. 37 AND 42.
- BS BIOMETRIC SYSTEMS GMBH, 53123 BONN, FED REP GERMANY:
2,706,098, COR. MULTIPLE CLASS, INT. CLS. 9, 38, 41 AND 42.
- BSH BOSCH UND SIEMENS HAUSGERATE GMBH, MUNICH, FED REP GERMANY:
3,176,167, PUB. 7-4-2006. INT. CL. 9.
3,176,180, PUB. 7-11-2006. INT. CL. 7.
- BTB INTERNATIONAL MANUFACTURING CORPORATION, TEMPLE, TX:
3,178,299, INT. CL. 16.
- BUCK KNIVES, INC., EL CAJON, CA:
1,949,652, CANC. INT. CL. 8.
- BUCK, JAMES K., VERO BEACH, FL:
2,309,824, CANC. INT. CL. 28.
- BUDDY MORROW PRODUCTIONS, MAITLAND, FL:
3,178,208, INT. CL. 41.
- BUDOKON, INC., WOODLAND HILLS, CA:
3,178,372, INT. CL. 16.
- BUILDING BLOCKS OF LEARNING, RANDOLPH, NJ:
1,378,498, CANC. MULTIPLE CLASS, INT. CLS. 41 AND 42.
- BUILDING CENTER, INC., THE, PINEVILLE, NC:
3,176,106, PUB. 9-12-2006. INT. CL. 35.
- BUILDING INSPECTION CONSULTANTS, INC., ROBBINSVILLE, NJ:
2,308,486, CANC. INT. CL. 37.
- BUILDING RESEARCH SYSTEMS, INC., EDMOND, OK:
3,175,806, PUB. 9-12-2006. INT. CL. 35.
- BUKO LIMITED, GLENROTHES, FIFE KY6 2SE, UNITED KINGDOM:
2,309,532, CANC. MULTIPLE CLASS, INT. CLS. 9, 12 AND 20.
- BULBRITE INDUSTRIES, INC., MOONACHIE, NJ:
1,954,333, REN. 10-24-06. INT. CL. 11.
- BULLOCK COMMUNICATIONS GROUP, INC., EDMONT, PA:
2,308,711, CANC. INT. CL. 42.
- BULLTEK REGISTRATION SERVICES LTD, RUNNING SPRINGS, CA:
3,176,478, PUB. 9-12-2006. INT. CL. 42.
- BULOVA WATCH COMPANY, INC., WOODSIDE, NY:
805,161, REN. 10-23-06. U.S. CL. 27 (INT. CL. 14).
- BUMPER TO BUMPER PROGRAM, INC., FORT WORTH, TX:
1,378,372, CANC. INT. CL. 35.
- BUNCOMBE COUNTY TOURISM DEVELOPMENT AUTHORITY, ASHEVILLE, NC:
3,176,567, PUB. 9-12-2006. INT. CL. 35.
- BUNGE OILS, INC., ST. LOUIS, MO, BUNGE EDIBLE OIL CORPORATION, KANKAKEE, IL:
1,421,283, REN. 10-25-06. INT. CL. 29.
- BUNNELL, DANIELLE D, SANTA MONICA, CA:
3,176,260, PUB. 9-12-2006. INT. CL. 25.
- BUNNY CORNWALL, PORT ANGELES, WA:
3,177,439, INT. CL. 25.
- BUNZL DISTRIBUTION USA, INC., ST. LOUIS, MO:
1,948,294, CANC. INT. CL. 5.
- BURKARD, EUGENE R., SAN DIEGO, CA:
1,023,313, CANC. INT. CL. 25.
- BURNS LONDON LTD., SURREY, ENGLAND:
3,176,561, PUB. 9-12-2006. INT. CL. 15.
- BURNS, STANTON I., ANTIOCH, CA:
3,177,914, INT. CL. 25.
- BUROSITZMOBELFABRIK FRIEDRICH-W. DAUPHIN GMBH & CO., D-91238 OFFENHAUSEN, FED REP GERMANY:
1,992,731, REN. 10-26-06. INT. CL. 20.
- BURTON CORPORATION, THE, BURLINGTON, VT:
3,176,196, PUB. 9-12-2006. INT. CL. 41.
- BURTON MEDICAL PRODUCTS CORPORATION, VAN NUYS, CA:
1,378,661, CANC. INT. CL. 11.
- BURTON, CHARLES V., EXCELSIOR, MN:
3,177,512, INT. CL. 44.
- BURZILLO, BARBARA, RIO RANCHO, NM:
3,175,865, PUB. 9-12-2006. INT. CL. 14.
- BURZYNSKI, STANISLAW R., HOUSTON, TX:
3,177,785, INT. CL. 5.
- BUSINESS INFORMATION DEVELOPMENT & MANAGEMENT CORPORATION, NEW YORK, NY:
2,308,329, CANC. INT. CL. 9.
- BUSINESS SIGNATURES CORPORATION, REDWOOD CITY, CA:
3,177,970, INT. CL. 9.
- BUSY BEE CANDLES LTD., LEONA, TX:
1,949,119, CANC. INT. CL. 4.
- C & N DEVELOPMENT CO., WEST LINN, OR:
3,177,440, INT. CL. 6.
- C GROUP, INC., THE, PRESCOTT, AZ:
3,175,980, PUB. 9-12-2006. INT. CL. 5.
- C. R. BARD, INC., MURRAY HILL, NJ:
3,177,676, INT. CL. 10.
- C. W. ALLEN GROUP, LLC, THE, BIRMINGHAM, AL:
3,178,690, INT. CL. 16.
- C.A.I., INC., GEORGETOWN, MA:
3,176,759, PUB. 9-12-2006. INT. CL. 2.
- C.F.G. NETWORK - S.R.L., SAN GIOVANNI TEATINO (CH), ITALY:
2,309,013, CANC. INT. CL. 25.
- C.H. ROBINSON INTERNATIONAL, INC., EDEN PRAIRIE, MN:
1,378,427, CANC. INT. CL. 36.
- C.S. LEWIS (PTE.) LTD., BEACH CENTRE, SINGAPORE:
3,177,587, MULTIPLE CLASS, INT. CLS. 9 AND 16.
3,177,590, MULTIPLE CLASS, INT. CLS. 9 AND 16.
- C&C ADMINISTRATION, LLC, BROOKFIELD, WI:
1,401,693, REN. 10-25-06. INT. CL. 42.
- CABLE NEWS NETWORK, INC., ATLANTA, GA:
2,308,345, CANC. INT. CL. 41.
- CADBURY ADAMS USA LLC, PARSIPPANY, NJ:
3,178,396, INT. CL. 30.
- CADLOCK, INC., APPLE CREEK, OH:
3,176,907, PUB. 9-12-2006. INT. CL. 9.
- CAERE CORPORATION, LOS GATOS, CA TO SCANSOFT, INC., PEABODY, MA:
1,949,460, CANC. INT. CL. 9.
- CAERE CORPORATION, LOS GATOS, CA:
2,309,137, CANC. INT. CL. 9.
- CAESARS WORLD, INC., LAS VEGAS, NV:
3,178,188, MULTIPLE CLASS, INT. CLS. 35, 36 AND 43.
- CAFE BELMONDO, LLC, TAMPA, FL:
3,177,786, INT. CL. 30.
- CAFE SOLMAR, LLC, SEATTLE, WA:
3,176,277, PUB. 9-12-2006. INT. CL. 43.
3,176,278, PUB. 9-12-2006. INT. CL. 30.
- CAFE DAMASCO S/A, CURITIBAL, BRAZIL:
3,176,142, PUB. 9-12-2006. INT. CL. 30.
- CALEDONIA COMPANY, INC., STEVENS, PA:
1,378,170, CANC. INT. CL. 25.

CALEEN CANTRELL DDS, PA, FRISCO, TX:
 3,177,454, INT. CL. 44.
 CALGON CORPORATION, NAPERVILLE, IL:
 1,949,067, CANC. INT. CL. 1.
 CALIENES, RICHARD J., MIAMI, FL:
 3,176,968, PUB. 9-12-2006. INT. CL. 9.
 CALIFORNIA ALMOND GROWERS EXCHANGE, SACRAMENTO, CA:
 1,409,675. REN. 10-25-06. INT. CL. 29.
 CALIFORNIA COSTUME COLLECTIONS, INC., LOS ANGELES, CA:
 3,176,251, PUB. 9-12-2006. INT. CL. 25.
 CALIFORNIA FRAGRANCE COMPANY, INC., HUNTINGTON STATION, NY:
 3,177,917, INT. CL. 4.
 CALIFORNIA PRODUCTS CORPORATION, ANDOVER, MA:
 2,006,170. REN. 10-26-06. INT. CL. 2.
 CALIPER CORPORATION, PRINCETON, NJ:
 1,447,870. REN. 10-26-06. MULTIPLE CLASS, INT. CLS. 35 AND 42.
 2,044,904. REN. 10-25-06. INT. CL. 42.
 CALKAIN REALTY ADVISORS, INC., RESTON, VA:
 3,178,181, INT. CL. 36.
 CALLAWAY GOLF COMPANY, CARLSBAD, CA:
 1,991,571. REN. 10-26-06. INT. CL. 28.
 CAMBO ENTERPRISES INVESTMENTS LIMITED, TORTOLA, BR. VIRGIN ISLANDS:
 3,177,343, INT. CL. 25.
 CAMICO MUTUAL INSURANCE COMPANY, REDWOOD CITY, CA:
 3,176,484, PUB. 9-12-2006. INT. CL. 36.
 CAMILLUS CUTLERY COMPANY, CAMILLUS, NY:
 48,928, CANC. U.S. CL. 23.
 CAMP COMPANY OF ST. PETERSBURG, ST. PETERSBURG, FL:
 3,177,062, PUB. 9-12-2006. INT. CL. 9.
 CAMPBELL, CHRIS F., PHOENIX, AZ:
 3,176,509, PUB. 9-12-2006. INT. CL. 41.
 CAMPBELL, J. SCOTT, GOLDEN, CO:
 3,177,857, INT. CL. 16.
 CAMPBELL, SUSAN, ROCKPORT, MA:
 3,178,167, INT. CL. 28.
 CAMPBELL'S FRESH, L.L.C., GRAFTON, ND:
 3,178,007, INT. CL. 43.
 CAMPI'S PIZZA, INC., FORT CHARLOTTE, FL:
 3,176,503, PUB. 9-12-2006. MULTIPLE CLASS, INT. CLS. 30 AND 43.
 CAMPUS MARKETING SERVICES, LLC, FRAMINGHAM, MA:
 3,178,242, INT. CL. 16.
 CANADA METAL COMPANY LIMITED, THE, TORONTO, ONTARIO, CANADA TO CANADA METAL (EASTERN) LIMITED, ST. LEONARD, QUEBEC, CANADA:
 1,947,921, CANC. INT. CL. 1.
 CANANDAIGUA BRANDS, INC., FAIRPORT, NY:
 2,309,936, CANC. INT. CL. 33.
 CANCER RESEARCH AND PREVENTION FOUNDATION, ALEXANDRIA, VA:
 3,176,848, PUB. 9-12-2006. INT. CL. 36.
 CANDITO, PATRICIA, NAPLES, FL:
 3,176,714, PUB. 9-12-2006. MULTIPLE CLASS, INT. CLS. 36 AND 45.
 CANDY COTTAGE COMPANY, INC., THE, HUNTINGDON VALLEY, PA:
 1,948,735, CANC. INT. CL. 30.
 CANNED INTERACTIVE, INC., BURBANK, CA, DBA THE CANNERY:
 3,178,501, INT. CL. 9.
 3,178,502, INT. CL. 9.
 CANON KABUSHIKI KAISHA, OHTA-KU, TOKYO, JAPAN:
 1,377,950, CANC. INT. CL. 9.
 CANTINA DOS AMIGOS, INC., STUART, FL:
 3,176,664, PUB. 9-12-2006. INT. CL. 43.
 CANTU ELLEBY, MARGARITA, GARZA GARCIA, MEXICO:
 3,178,484, INT. CL. 25.
 CANYON COUNTRY PLAZA, L.P., LOS ANGELES, CA:
 3,176,468, PUB. 9-12-2006. INT. CL. 36.
 CANYON CREEK SOUP COMPANY LTD., EDMONTON T6E 5G2, ALBERTA, CANADA:
 2,308,310, CANC. MULTIPLE CLASS, INT. CLS. 29 AND 30.
 CAPEL, INCORPORATED, TROY, NC:
 3,176,073, PUB. 9-12-2006. INT. CL. 27.
 CAPEULEU, SOCIEDAD ANONIMA, GUATEMALA, GUATEMALA:
 3,175,801, PUB. 9-12-2006. INT. CL. 30.
 CAPEWELL COMPONENTS COMPANY, LLC, CROMWELL, CT:
 1,417,220. REN. 10-23-06. INT. CL. 8.
 CAPITAL COMMUNICATIONS INDUSTRIES, INC., OLYMPIA, WA:
 3,176,454, PUB. 9-12-2006. MULTIPLE CLASS, INT. CLS. 9, 11, 35, 37, 40 AND 42.
 CAPITAL MERCURY APPAREL, LTD., NEW YORK, NY:
 3,177,479, INT. CL. 25.
 CAPITAL PACIFIC, LLC, LAKE OSWEGO, OR:
 3,176,892, PUB. 9-12-2006. INT. CL. 36.
 CAPITAL SAFETY GROUP EMEA, CARROS, FRANCE:
 3,178,211, INT. CL. 9.
 CAPITALSOUTH BANCORP, BIRMINGHAM, AL:
 3,176,592, PUB. 9-12-2006. INT. CL. 36.
 CAPITOL CORRIDOR JOINT POWERS AUTHORITY, OAKLAND, CA:
 3,178,734, INT. CL. 39.
 CAPPEL NORROW LIMITED, MILTON KEYNES, UNITED KINGDOM AND DOVEMART LIMITED, TARPORLEY, UNITED KINGDOM:
 3,175,993, PUB. 9-12-2006. INT. CL. 21.
 CAPPELLI STRAWORLD, INC., MIAMI, FL:
 2,670,642, CANC. MULTIPLE CLASS, INT. CLS. 18 AND 25.
 CAPSTAR RADIO OPERATING COMPANY, SAN ANTONIO, TX, KFI, INC., LOS ANGELES, CA, DBA KFI:
 1,405,285. REN. 10-26-06. INT. CL. 38.
 CAPSTONE ADVISORS LLC, SCOTTSDALE, AZ:
 3,178,591, INT. CL. 36.
 CARBONE, AMY, CHICAGO, IL:
 3,176,870, PUB. 9-12-2006. INT. CL. 28.
 CARDIOCOMMAND, INC., TAMPA, FL:
 3,178,004, INT. CL. 10.
 CARDO SYSTEMS, INC., PITTSBURGH, PA:
 3,176,248, PUB. 9-12-2006. INT. CL. 9.
 CARDON VENTURES, LLC, PHOENIX, AZ:
 3,176,807, PUB. 9-12-2006. INT. CL. 9.
 CARDONE INDUSTRIES, INC., PHILADELPHIA, PA:
 3,177,455, MULTIPLE CLASS, INT. CLS. 9 AND 12.
 CARE DIAGNOSTICA PRODUKTIONS-UND VERTRIEBSGESELLSCHAFT M.B.H., MOLLERSDORF, AUSTRIA:
 3,176,039, PUB. 9-12-2006. INT. CL. 5.
 CAREFIRST OF MARYLAND INC., OWINGS MILLS, MD, DBA CAREFIRST BLUE CROSS BLUE SHIELD:
 3,177,513, MULTIPLE CLASS, INT. CLS. 16, 35, 36 AND 41.
 CAREPLANET, INC., HONOLULU, HI:
 3,178,104, MULTIPLE CLASS, INT. CLS. 9 AND 35.
 CARGILL, INCORPORATED, WAYZATA, MN:
 2,309,629, CANC. INT. CL. 30.
 3,177,663, INT. CL. 30.
 3,177,944, INT. CL. 30.
 3,178,323, INT. CL. 30.
 CARL JIMUKI KABUSHIKI KAISHA, TOKYO, JAPAN, TA CARL MANUFACTURING CO., LTD.:
 3,176,426, PUB. 6-6-2006. INT. CL. 8.
 CARLING TECHNOLOGIES, INC., PLAINVILLE, CT:
 3,176,452, PUB. 9-12-2006. INT. CL. 9.
 CARMEL, INC., NOVATO, CA:
 1,377,796, CANC. INT. CL. 3.
 CARMEL SUNSET GROUP, LLC, LAS VEGAS, NV:
 3,177,578, INT. CL. 32.
 CAROLE ACCESSORIES, LOS ANGELES, CA:
 3,176,040, PUB. 9-12-2006. INT. CL. 14.
 CAROLINA HERRERA, LTD., NEW YORK, NY:
 1,948,543, CANC. INT. CL. 3.

- CAROLINA HOSIERY, INC., TIMMONSVILLE, SC:
3,176,817, PUB. 9-12-2006. INT. CL. 25.
- CARPET CO-OP OF AMERICA ASSOCIATION, MARYLAND HEIGHTS, MO:
2,309,499, CANC. INT. CL. 19.
- CARPETMAX, L.P., KENNESAW, GA:
2,308,594, CANC. INT. CL. 37.
- CARRIAGE HOUSE VIOLINS, INC., BOSTON, MA:
3,176,298, PUB. 9-12-2006. INT. CL. 35.
- CARRIER CORPORATION, SYRACUSE, NY:
1,949,699, CANC. INT. CL. 9.
- CARVALHO, JEFFREY A., EAST HARTFORD, CT:
2,308,753, CANC. INT. CL. 42.
- CARVER COMMUNICATION, INC., VAN NUYS, CA:
2,246,852, CANC. INT. CL. 16.
- CARVER'S CLASSIC MEAT PRODUCTS, INC., PAXTON, IL:
1,947,973, CANC. INT. CL. 29.
- CASCADE ENGINEERING INC., GRAND RAPIDS, MI:
1,947,846, CANC. MULTIPLE CLASS, INT. CLS. 12, 20 AND 42.
- CASEBIER COMPANIES, INC., HURST, TX:
1,949,526, CANC. INT. CL. 16.
- CASINO DATA SYSTEMS, LAS VEGAS, NV:
1,990,819, REN. 10-23-06. INT. CL. 42.
- CATCO HF., KRINGLAN 7, 103 REYKJAVIK, ICELAND:
2,308,377, CANC. INT. CL. 33.
- CAVANAUGH, ROBERT M., MORGANTON, NC:
3,178,243, INT. CL. 42.
- CAYMAN SHORES DEVELOPMENT LIMITED, GRAND CAYMAN, CAYMAN ISLANDS:
3,176,521, PUB. 6-6-2006. INT. CL. 35.
- CBK STYLES, INC., UNION CITY, TN:
3,178,774, INT. CL. 35.
- CBS BROADCASTING INC., NEW YORK, NY:
3,178,229, INT. CL. 9.
- CCL CUSTOM MANUFACTURING, INC., ROSEMONT, IL:
2,309,943, CANC. INT. CL. 3.
- CDOC, LLC, GORDONSVILLE, VA:
3,177,381, MULTIPLE CLASS, INT. CLS. 7 AND 12.
- CDRE TM CORP., MISSION VIEJO, CA:
3,178,618, INT. CL. 36.
- CEBE, MOREZ 39400, FRANCE, CEBE INTERNATIONAL SA, 39400 MOREZ, FRANCE:
1,987,935, REN. 10-20-06. INT. CL. 28.
- CEBE INTERNATIONAL SA, 39400 MOREZ, FRANCE TO CEBE, MOREZ 39400, FRANCE:
1,987,935, CANC. INT. CL. 9.
- CECORR, INC., INDIANAPOLIS, IN:
1,949,020, CANC. INT. CL. 16.
- CELESTIAL SEASONINGS, INC., BOULDER, CO:
1,948,634, CANC. INT. CL. 30.
- CELTICS LIMITED PARTNERSHIP, BOSTON, MA:
2,309,752, CANC. INT. CL. 9.
- CENTENNIAL COMMUNICATIONS CORP., WALL, NJ:
3,177,644, INT. CL. 38.
- CENTERPOINT ENERGY FIELD SERVICES, INC., SHREVEPORT, LA:
3,176,889, PUB. 9-12-2006. INT. CL. 9.
- CENTRAL BANCOMPANY, JEFFERSON CITY, MO:
1,378,429, CANC. INT. CL. 36.
- CENTRAL PARK LODGES INC., ORLANDO, FL:
1,378,599, CANC. INT. CL. 42.
- CENTREVILLE SAVINGS BANK, WEST WARWICK, RI:
1,376,241, REN. 10-25-06. INT. CL. 36.
- CENTRIX, INC., SHELTON, CT:
2,050,942, REN. 10-23-06. INT. CL. 10.
- CENTURY CORPORATION, 222-22, NAE-DONG, KYUNG-KI-DO, REPUBLIC OF KOREA:
2,308,156, CANC. INT. CL. 7.
2,308,157, CANC. INT. CL. 7.
- CERAMICA SANT'AGOSTINO - S.P.A., ITALY:
3,177,249, PUB. 9-12-2006. INT. CL. 19.
- CEREAL INGREDIENTS, INC., LEAVENWORTH, KS:
2,008,812, REN. 10-26-06. INT. CL. 30.
- CERES, INC., THOUSAND OAKS, CA:
3,177,709, INT. CL. 9.
- CERNER CORPORATION, KANSAS CITY, MO:
3,178,018, INT. CL. 9.
- CERTIKIN INTERNATIONAL LIMITED, OXFORDSHIRE, UNITED KINGDOM:
2,011,306, REN. 10-26-06. MULTIPLE CLASS, INT. CLS. 10 AND 11.
- CERUS CORPORATION, CONCORD, CA:
3,177,365, INT. CL. 44.
- CHAD THERAPEUTICS, INC., CHATSWORTH, CA:
1,416,513, REN. 10-20-06. INT. CL. 10.
- CHAD W. MOODY P.C., OKLAHOMA CITY, OK:
3,176,832, PUB. 9-12-2006. INT. CL. 42.
- CHAF ENTERPRISES, INC., MIAMI, FL:
3,175,809, PUB. 9-12-2006. INT. CL. 41.
- CHAMPION INDUSTRIES, INC., WINSTON-SALEM, NC:
2,020,622, REN. 10-26-06. INT. CL. 7.
- CHAMPION POWER EQUIPMENT, INC., SANTA FE SPRINGS, CA:
3,178,197, INT. CL. 7.
- CHANEL, INC., NEW YORK, NY:
2,034,585, REN. 10-26-06. INT. CL. 3.
- CHANG, JONATHAN, SAN JOSE, CA:
3,178,036, INT. CL. 16.
- CHANNELLOCK, INC., MEADVILLE, PA:
2,031,513, REN. 10-24-06. INT. CL. 8.
- CHARLES J. DINATALE TOMDAN INC, WILLIAMSVILLE, NY:
3,176,821, PUB. 9-12-2006. INT. CL. 25.
- CHARLES SCHWAB & CO., INC., SAN FRANCISCO, CA:
2,076,829, REN. 10-23-06. INT. CL. 36.
2,309,991, CANC. INT. CL. 16.
- CHARLESTON'S LANDSHARKS INC., ISLE OF PALMS, SC:
3,178,586, INT. CL. 36.
- CHART HOUSE, INC., THE, MUSCATINE, IA:
3,176,462, PUB. 9-12-2006. INT. CL. 43.
- CHARTER FUND, INC., BROOMFIELD, CO:
3,176,729, PUB. 9-12-2006. INT. CL. 36.
- CHECK POINT SOFTWARE TECHNOLOGIES LTD., RAMAT GAN, ISRAEL:
3,178,191, INT. CL. 9.
- CHECKRITE, LTD., ENGLEWOOD, CO:
1,378,404, CANC. INT. CL. 36.
- CHECKSITE MEDICAL, INC, EUREKA, MO:
3,178,071, INT. CL. 10.
- CHEFLINE U.S.A. INC., HAYWARD, CA:
2,309,489, CANC. INT. CL. 21.
- CHELSEA INDUSTRIES, INC., PEABODY, MA:
3,178,338, INT. CL. 21.
- CHEMICAL DYNAMICS, INC., RUSTON, LA:
1,378,646, CANC. INT. CL. 3.
- CHEMICAL WASTE MANAGEMENT, INC., OAK BROOK, IL:
1,378,478, CANC. INT. CL. 39.
- CHENG KUANG PRECISION INDUSTRIAL CO., LTD., TAINAN HSIEN, TAIWAN:
1,948,758, CANC. INT. CL. 9.
- CHENG SHIN RUBBER USA, INC., SUWANEE, GA:
3,177,938, INT. CL. 12.
- CHEQUEMATE INTERNATIONAL, INC., SALT LAKE CITY, UT:
2,241,551, CANC. INT. CL. 36.
- CHEROKEE SANFORD GROUP, LLC, SANFORD, NC:
2,309,229, CANC. INT. CL. 19.
- CHERPAS, JOHN, WEST HOLLYWOOD, CA AND DELKESKAMP, KELLIE, WEST HOLLYWOOD, CA:
3,176,908, PUB. 9-12-2006. INT. CL. 25.
- CHEVRON CORPORATION, SAN RAMON, CA:
3,178,364, MULTIPLE CLASS, INT. CLS. 40 AND 42.
- CHEVRON INTELLECTUAL PROPERTY INC., SAN RAMON, CA:
3,177,162, PUB. 9-12-2006. INT. CL. 35.
3,177,164, PUB. 9-12-2006. INT. CL. 30.
- CHEVRON PHILLIPS CHEMICAL COMPANY LP, THE WOODLANDS, TX:
2,082,706, REN. 10-26-06. INT. CL. 17.
- CHICA, INC., SAN FERNANDO, CA:
3,177,399, INT. CL. 25.
- CHICAGO BRIDGE & IRON COMPANY, PLAINFIELD, IL:
3,175,792, PUB. 9-12-2006. MULTIPLE CLASS, INT. CLS. 6, 37, 40 AND 42.

CHICAGO LOCK COMPANY, PLEASANT PRAIRIE, WI:
2,310,003, CANC. INT. CL. 6.

CHICAGO MERCANTILE EXCHANGE, CHICAGO, IL:
1,378,054, CANC. INT. CL. 16.

CHICAGO STYLE PIZZERIA, BLOOMINGTON, IL:
3,176,866, PUB. 9-12-2006. INT. CL. 43.

CHICK-FIL-A, INC., ATLANTA, GA:
1,948,882, CANC. MULTIPLE CLASS, INT. CLS. 29, 30, 32 AND 42.

CHIH AN INTERNATIONAL, INC., CITY OF INDUSTRY, CA:
3,177,755, INT. CL. 28.

CHILDCAREGROUP, DALLAS, TX:
1,991,633, REN. 10-21-06. INT. CL. 41.

CHILDERS, SUZANNE M, LAS VEGAS, NV:
3,176,449, PUB. 9-12-2006. INT. CL. 41.

CHILDREN WITH HAIR LOSS, INC., ROCKWOOD, MI:
3,176,122, PUB. 9-12-2006. INT. CL. 36.

CHILDREN'S HOSPITAL & RESEARCH CENTER OAKLAND, OAKLAND, CA:
3,178,607, INT. CL. 44.

CHILDREN'S HOSPITAL MEDICAL CENTER, CINCINNATI, OH:
3,176,440, PUB. 9-12-2006. MULTIPLE CLASS, INT. CLS. 35 AND 41.

CHILDREN'S TELEVISION WORKSHOP, NEW YORK, NY:
2,309,493, CANC. MULTIPLE CLASS, INT. CLS. 9, 16 AND 41.

CHILDSAFENET, INC., FAIRFAX STATION, VA:
3,176,084, PUB. 9-12-2006. MULTIPLE CLASS, INT. CLS. 41 AND 45.

CHINA TRADE & RESEARCH, INC., EL MONTE, CA:
1,949,473, CANC. INT. CL. 25.

CHINA UNIONPAY CO., LTD., SHANGHAI, CHINA:
3,177,758, MULTIPLE CLASS, INT. CLS. 9 AND 36.

CHINAMERICA SERVICES, INC., VANCOUVER, B.C. V6K 3A9, CANADA:
2,309,093, CANC. INT. CL. 7.

CHIQUITA BRANDS, INC., CINCINNATI, OH:
2,309,627, CANC. INT. CL. 31.
2,309,784, CANC. INT. CL. 31.

CHITTENDEN TRUST COMPANY, BURLINGTON, VT:
3,178,205, INT. CL. 36.

CHIU, CHUAN YAO, ARCADIA, CA:
3,176,307, PUB. 9-12-2006. INT. CL. 25.

CHOCOLADEFABRIKEN LINDT & SPRÜNGLI AG, SWITZERLAND:
3,177,259, PUB. 9-12-2006. INT. CL. 30.

CHOI HEONG YUEN - MACAU LIMITED, MACAU, CHINA:
3,091,949, COR. INT. CL. 30.

CHOI, HOON S, ELK GROVE VILLAGE, IL:
3,177,066, PUB. 9-12-2006. INT. CL. 32.

CHOI, YUN JUN, SEOUL, REPUBLIC OF KOREA:
3,178,041, INT. CL. 25.

CHOICE HOTELS INTERNATIONAL, INC., SILVER SPRING, MD:
2,309,286, CANC. INT. CL. 42.

CHOUNG SOO FOOD INDUSTRIAL COMPANY, LTD., KYONGGI-DO, REPUBLIC OF KOREA:
1,416,161, REN. 10-26-06. INT. CL. 30.

CHRIS H LEBOUTILLIER, REDMOND, WA:
3,176,891, PUB. 9-12-2006. INT. CL. 40.

CHRISMUKKAH.COM, LIVINGSTON, MT:
3,176,097, PUB. 9-12-2006. INT. CL. 16.
3,176,098, PUB. 9-12-2006. INT. CL. 45.
3,176,099, PUB. 9-12-2006. INT. CL. 35.

CHRISTIAN DIOR COUTURE, FRANCE:
3,177,208, PUB. 9-12-2006. INT. CL. 25.

CHRISTIAN FINANCIAL CONCEPTS, INC., GAINESVILLE, GA:
2,308,622, CANC. INT. CL. 9.

CHRISTINE'S KITCHEN LLC, WASHINGTON, DC:
3,177,474, INT. CL. 35.

CHRISTY, JOSEPH, TEMPE, AZ AND CHRISTY, MARTHA, TEMPE, AZ:
3,177,125, PUB. 9-12-2006. INT. CL. 5.

CHRONOLOGIE, LLC, WEST NEW YORK, NJ:
3,177,459, INT. CL. 25.

CHS INC., INNER GROVE HEIGHTS, MN:
1,448,763, REN. 10-26-06. INT. CL. 31.

CHUCK, EMIL, DURHAM, NC:
3,176,550, PUB. 9-12-2006. INT. CL. 41.

CHUNKY MONKEY PRODUCTIONS, LLC, PORT ST. LUCIE, FL:
3,178,096, INT. CL. 9.

CHURCH & DWIGHT COMPANY, GREEN RIVER, WY:
3,177,806, MULTIPLE CLASS, INT. CLS. 1 AND 3.

CHURCHILL AND CARR LIMITED, ST. HELIER, JERSEY:
3,177,915, INT. CL. 33.

CIBA SPECIALTY CHEMICALS CORPORATION, TARRYTOWN, NY:
3,178,108, INT. CL. 1.

CIBA SPECIALTY CHEMICALS WATER TREATMENTS LIMITED, WEST YORKSHIRE, ENGLAND:
1,033,463, REN. 10-23-06. INT. CL. 1.

CIGARS INTERNATIONAL INC., BATH, PA:
3,176,835, PUB. 9-12-2006. INT. CL. 34.
3,176,836, PUB. 9-12-2006. INT. CL. 34.
3,176,841, PUB. 9-12-2006. INT. CL. 34.

CIGNA INTELLECTUAL PROPERTY, INC., CLAYMONT, DE:
3,178,597, INT. CL. 44.

CIMA SOFTWARE CORPORATION, VERONA, PA:
3,176,673, PUB. 9-12-2006. INT. CL. 9.

CINCINNATI ART MUSEUM, CINCINNATI, OH:
2,308,851, CANC. MULTIPLE CLASS, INT. CLS. 35, 41 AND 42.

CIPHER INTEGRATIONS, INC., LAKELAND, FL:
3,178,085, INT. CL. 42.

CIPS FENCE CO., INC., YONKERS, NY:
3,176,559, PUB. 9-12-2006. MULTIPLE CLASS, INT. CLS. 37 AND 40.

CIRCON TECHNOLOGY CORPORATION, DELTA, BRITISH COLUMBIA, CANADA:
2,308,141, CANC. MULTIPLE CLASS, INT. CLS. 9 AND 42.

CIRCUIT CITY STORES WEST COAST, INC., WALNUT, CA TO CARMAX AUTO SUPERSTORES WEST COAST, INC., WALNUT, CA:
1,948,397, CANC. INT. CL. 37.

CIRCUITS & BUMPS, INC., MARIETTA, GA:
1,948,494, CANC. INT. CL. 42.

CIRCULATORY CENTERS OF AMERICA, LLC, PITTSBURGH, PA:
3,175,892, PUB. 9-12-2006. INT. CL. 44.

CITATION COMPANIES, L.L.C., BIRMINGHAM, AL:
2,310,080, CANC. INT. CL. 28.

CITGO PETROLEUM CORPORATION, HOUSTON, OK, CITGO PETROLEUM CORPORATION, HOUSTON, OK:
2,003,913, REN. 10-26-06. INT. CL. 4.

CITGO PETROLEUM CORPORATION, HOUSTON, TX:
2,006,845, REN. 10-26-06. INT. CL. 4.

CITIGROUP INC., NEW YORK, NY:
3,176,239, PUB. 9-12-2006. MULTIPLE CLASS, INT. CLS. 35 AND 36.

CITIZEN PUBLISHING COMPANY OF WISCONSIN, INC., BEAVER DAM, WI TO CONLEY PUBLISHING GROUP, LTD., BEAVER DAM, WI:
1,948,655, CANC. INT. CL. 9.

CITIZENS BANK OF PENNSYLVANIA, PHILADELPHIA, PA:
1,378,440, CANC. INT. CL. 37.
1,378,441, CANC. INT. CL. 37.

CITR PTY LTD, MILTON, QUEENSLAND 4064, AUSTRALIA:
2,308,351, CANC. INT. CL. 9.

CITY OF HOMESTEAD, HOMESTEAD, FL:
3,178,269, INT. CL. 35.

CITY OF PALMDALE, PALMDALE, CA:
3,178,600, INT. CL. 41.

CITY OF PASADENA, PASADENA, CA:
3,177,372, MULTIPLE CLASS, INT. CLS. 25, 35 AND 41.

CITY OF SCOTTSDALE, SCOTTSDALE, AZ:
3,175,875, PUB. 9-12-2006. INT. CL. 35.

- CITY OF WEST PALM BEACH, WEST PALM BEACH, FL:
3,176,778, PUB. 9-12-2006. MULTIPLE CLASS, INT. CLS. 16, 24, 25 AND 41.
- CITYON SYSTEMS, INC., PLANO, TX:
3,176,622, PUB. 9-12-2006. INT. CL. 42.
- CITYVIEW PUBLISHING, INC., KNOXVILLE, TN:
3,175,763, PUB. 9-12-2006. INT. CL. 16.
- CIVICCARDS, INC., PITTSBURGH, PA:
3,178,180, INT. CL. 16.
- CLARIA CORPORATION, REDWOOD CITY, CA:
3,176,125, PUB. 9-12-2006. INT. CL. 9.
- CLARITY COMMUNICATION ADVISORS, INC., SOUTH-FIELD, MI:
3,178,790, INT. CL. 38.
- CLASSIC ROPE MANUFACTURING, INC., GRANBURY, TX:
1,949,660, CANC. MULTIPLE CLASS, INT. CLS. 10 AND 18.
- CLASSY ETC., INC, CHANDLER, AZ:
1,993,137, REN. 10-26-06. INT. CL. 20.
- CLASSY KID, INC., SUMMERLIN, NV:
3,176,443, PUB. 9-12-2006. INT. CL. 24.
- CLEARPOINT FINANCIAL SOLUTIONS, INC., RICHMOND, VA:
3,177,588, INT. CL. 36.
- CLEARWATER INVESTMENT MANAGEMENT LTD., GEORGE TOWN, GRAND CAYMAN, CAYMAN ISLANDS:
2,353,774, CANC. INT. CL. 36.
- CLEO INC, MEMPHIS, TN:
2,309,972, CANC. INT. CL. 16.
- CLEVELAND INDIANS BASEBALL COMPANY LIMITED PARTNERSHIP, WESTLAKE, OH:
3,175,752, PUB. 9-12-2006. INT. CL. 25.
- CLIFF WAGNER, FARMINGDALE, NY:
2,445,710, CANC. MULTIPLE CLASS, INT. CLS. 35, 36, 39, 40 AND 42.
- CLK FACTOR, INC., KIRKLAND, WA:
2,309,858, CANC. INT. CL. 16.
- CLOCK TOWER VENTURES LLC, OLD WESTBURY, NY:
3,178,779, INT. CL. 38.
- CLOPAY BUILDING PRODUCTS COMPANY, INC., CINCINNATI, OH:
2,308,235, CANC. MULTIPLE CLASS, INT. CLS. 7 AND 9.
- CLOPAY BUILDING PRODUCTS R&D COMPANY, INC., MASON, OH, DBA CLOPAY BUILDING PRODUCTS COMPANY, INC.:
3,176,445, PUB. 9-12-2006. INT. CL. 6.
- CLOUD NINE, WESTMINSTER, CA:
3,176,928, PUB. 9-12-2006. INT. CL. 35.
- CLOUDBURST GOLF PARTNERS, L.P., COPPEROPOLIS, CA:
2,309,069, CANC. INT. CL. 41.
- CLOVERDALE PAINT INC., SURREY, B.C., CANADA:
2,071,663, REN. 10-25-06. INT. CL. 2.
- CLS UK INTERMEDIATE HOLDINGS LTD, LONDON, UNITED KINGDOM:
3,175,983, PUB. 1-10-2006. MULTIPLE CLASS, INT. CLS. 9, 36, 38 AND 42.
- CLUBHOUSE SPORTS CORPORATION, PARKER, CO:
3,176,233, PUB. 9-12-2006. INT. CL. 43.
3,176,234, PUB. 9-12-2006. INT. CL. 43.
- CMP ENTERTAINMENT MEDIA, INC., NEW YORK, NY:
3,176,394, PUB. 9-12-2006. INT. CL. 16.
3,176,552, PUB. 9-12-2006. INT. CL. 41.
- CMP MEDIA LLC, MANHASSET, NY, CMP PUBLICATIONS, INC., MANHASSET, NY:
1,997,697, REN. 10-24-06. INT. CL. 16.
- CMP MEDIA LLC, MANHASSET, NY:
3,176,333, PUB. 9-12-2006. INT. CL. 42.
3,176,658, PUB. 9-12-2006. INT. CL. 9.
- COBBE, ELLEN, WALNUT CREEK, CA:
3,176,499, PUB. 9-12-2006. INT. CL. 9.
- COCHRANE, ANDRINA M., LAHAINA, HI, DBA MAUI MONKEY:
1,949,320, CANC. INT. CL. 16.
- CODE BLUE PRODUCTIONS LLC, CHANHASSEN, MN:
3,176,114, PUB. 9-12-2006. INT. CL. 16.
- CODESCO DESIGN UND DATENSYSTEMS GMBH, 22113 OSTSTEINBEK, FED REP GERMANY:
2,308,178, CANC. MULTIPLE CLASS, INT. CLS. 9, 16, 41 AND 42.
- CODEXIS, INC., REDWOOD CITY, CA FROM MAXYGEN, INC., REDWOOD CITY, CA:
3,177,355, MULTIPLE CLASS, INT. CLS. 1, 40 AND 42.
- COIN DATA, LLC, NORCROSS, GA:
3,178,302, INT. CL. 9.
- COINTREAU, 49124 SAINT-BARTHELEMY-D'ANGOUE, FRANCE:
2,000,613, REN. 10-25-06. INT. CL. 33.
- COLANTOTTE INTERNATIONAL, INC., CARLSBAD, CA:
3,176,540, PUB. 9-12-2006. INT. CL. 10.
- COLD ICE CORPORATION, OAKLAND, CA:
1,947,866, CANC. INT. CL. 10.
- COLD SPRING GRANITE COMPANY, COLD SPRING, MN:
3,178,228, INT. CL. 6.
- COLDWATER CREEK INC., SANDPOINT, ID:
3,177,920, INT. CL. 35.
- COLEMAN COMPANY, INC., THE, WICHITA, KS:
2,308,145, CANC. INT. CL. 11.
- COLGATE-PALMOLIVE COMPANY, NEW YORK, NY, COLGATE & COMPANY, JERSEY CITY, NJ:
227,647, REN. 10-25-06. U.S. CL. 51 (INT. CL. 1).
- COLGATE-PALMOLIVE COMPANY, NEW YORK, NY:
3,177,669, INT. CL. 3.
- COLLECTORS UNIVERSE, INC., NEWPORT BEACH, CA:
3,176,078, PUB. 9-12-2006. INT. CL. 42.
3,178,727, INT. CL. 42.
- COLLEGE NANNIES & TUTORS DEVELOPMENT, INC., WAYZATA, MN:
3,176,953, PUB. 9-12-2006. INT. CL. 35.
3,176,955, PUB. 9-12-2006. INT. CL. 35.
- COLLINS, MARVA N., HILTON HEAD ISLAND, SC:
3,177,122, PUB. 9-12-2006. INT. CL. 41.
- COLOMBY, DONNA, LOS ANGELES, CA:
3,176,894, PUB. 9-12-2006. INT. CL. 16.
- COLONIAL LIFE & ACCIDENT INSURANCE COMPANY, COLUMBIA, SC:
3,177,491, MULTIPLE CLASS, INT. CLS. 35, 36 AND 42.
- COLONIAL TAX COMPLIANCE CO., ROSWELL, GA:
3,178,154, INT. CL. 35.
- COLOPLAST A/S, DK-3050 HUMLEBAEK, DENMARK:
2,309,696, CANC. INT. CL. 5.
- COLOPLAST A/S, DENMARK:
3,177,207, PUB. 9-12-2006. INT. CL. 10.
- COLOR ME BEAUTIFUL, INC., CHANTILLY, VA:
1,948,323, CANC. INT. CL. 16.
- COLORADO NATURE RANCH, L.P., ORLANDO, FL:
3,177,704, INT. CL. 43.
- COLORECTAL CANCER COALITION, INC., WASHINGTON, DC:
3,176,724, PUB. 9-12-2006. INT. CL. 35.
- COLOSA, CORAL GABLES, FL:
3,176,498, PUB. 9-12-2006. MULTIPLE CLASS, INT. CLS. 9 AND 42.
- COLTEC INDUSTRIES INC., CHARLOTTE, NC:
2,308,347, CANC. MULTIPLE CLASS, INT. CLS. 7, 37 AND 42.
3,176,698, PUB. 9-12-2006. INT. CL. 7.
- COLTENE/WHALEDENT, INC., CUYAHOGA FALLS, OH:
1,412,173, REN. 10-26-06. INT. CL. 10.
- COLUMBIA INSURANCE COMPANY, OMAHA, NE:
223,660, REN. 10-23-06. U.S. CL. 16 (INT. CL. 2).
- COMBISEP, INC., AMES, IA:
3,176,472, PUB. 9-12-2006. INT. CL. 9.
- COMEDY PARTNERS, NEW YORK, NY:
3,176,677, PUB. 9-12-2006. INT. CL. 41.
- COMMERCE BANCORP, INC., CHERRY HILL, NJ:
3,177,453, INT. CL. 36.
- COMMISSARIAT A L'ENERGIE ATOMIQUE, PARIS, FRANCE:
3,175,987, PUB. 9-12-2006. MULTIPLE CLASS, INT. CLS. 5, 42 AND 44.
- COMMSCOPE, INC. OF NORTH CAROLINA, HICKORY, NC:
2,308,505, CANC. INT. CL. 9.

COMMUNICATING FOR AGRICULTURE AND THE SELF-EMPLOYED, INC., FERGUS FALLS, MN:
 1,405,384. REN. 10-26-06. U.S. CL. 200.
 1,407,195. REN. 10-26-06. U.S. CL. 200.

COMMUNITY CENTRAL BANK, MOUNT CLEMENS, MI:
 3,178,370. INT. CL. 36.

COMMUNITY HEALTH AND COUNSELING SERVICES, BANGOR, ME:
 1,918,600. REN. 10-25-06. INT. CL. 42.

COMMUNITY HEALTH PLAN OF WASHINGTON, SEATTLE, WA:
 2,309,623. CANC. INT. CL. 36.

COMPACT POWER, INC., FORT MILL, SC:
 3,178,316. INT. CL. 7.

COMPTOIR NOUVEAU DE LA PARFUMERIE, FRANCE:
 3,177,212. PUB. 9-12-2006. INT. CL. 3.

COMPTON HOUSE PUBLISHING LIMITED, UNITED KINGDOM:
 3,177,299. PUB. 9-12-2006. MULTIPLE CLASS, INT. CLS. 9, 16, 35 AND 41.

COMPU-GUARD, INC., SWANSEA, MA, P.G.L. INDUSTRIES, INC., SEEKONK, MA:
 1,404,677. REN. 10-24-06. INT. CL. 9.

COMPUTER ASSOCIATES INTERNATIONAL, INC., ISLANDIA, NY:
 1,045,329. REN. 10-25-06. INT. CL. 9.

COMPUTER HISTORY MUSEUM, MOUNTAIN VIEW, CA:
 3,177,823. INT. CL. 41.

COMPUTER SCIENCES CORPORATION, EL SEGUNDO, CA:
 3,178,250. INT. CL. 42.
 3,178,534. INT. CL. 9.
 3,178,550. INT. CL. 9.

COMPUTIZE, INC., HOUSTON, TX:
 2,308,794. CANC. INT. CL. 35.

CONAGRA BRANDS, INC., OMAHA, NE:
 3,175,863. PUB. 9-12-2006. MULTIPLE CLASS, INT. CLS. 29 AND 30.
 3,177,551. INT. CL. 30.

CONAGRA FOODS PACKAGED FOODS COMPANY, INC., OMAHA, NE:
 1,378,294. CANC. INT. CL. 29.
 3,177,477. INT. CL. 30.

CONAIR CORPORATION, STAMFORD, CT:
 3,176,276. PUB. 9-12-2006. INT. CL. 11.
 3,178,566. INT. CL. 11.

CONCEPTUAL SYSTEMS, INC., SILVER SPRING, MD:
 2,309,783. CANC. INT. CL. 9.

CONCRETE STONE & TILE CORP., BRANCHVILLE, NJ:
 3,176,500. PUB. 9-12-2006. INT. CL. 19.

CONERGY AG, FED REP GERMANY:
 3,177,242. PUB. 9-12-2006. MULTIPLE CLASS, INT. CLS. 6, 9, 11, 37, 38, 40 AND 42.

CONESTOGA LOG CABINS, INC., LEBANON, PA:
 3,177,100. PUB. 9-12-2006. INT. CL. 19.
 3,177,175. PUB. 9-12-2006. INT. CL. 19.

CONFISEUR LADERACH AG, 8755 ENNENDA, SWITZERLAND:
 2,014,150. REN. 10-22-06. INT. CL. 30.

CONFLUENT SURGICAL, INC., WALTHAM, MA:
 3,178,173. INT. CL. 10.
 3,178,376. INT. CL. 5.

CONGOLEUM CORPORATION, KEARNY, NJ:
 1,378,261. CANC. INT. CL. 27.

CONGOLEUM CORPORATION, MERCERVILLE, NJ:
 1,378,262. CANC. INT. CL. 27.

CONGRESS FINANCIAL CORPORATION (FLORIDA), AS AGENT, FORT LAUDERDALE, FL:
 1,378,238. CANC. INT. CL. 25.

CONIGLIO, FRANK STEPHEN, WEST PALM BEACH, FL:
 2,021,883. REN. 10-25-06. INT. CL. 42.

CONN-WELD INDUSTRIES, INC., PRINCETON, WV:
 3,175,828. PUB. 9-12-2006. INT. CL. 7.

CONOCOPHILLIPS COMPANY, HOUSTON, TX:
 3,176,763. PUB. 9-12-2006. INT. CL. 4.
 3,176,768. PUB. 9-12-2006. INT. CL. 37.
 3,177,151. PUB. 9-12-2006. INT. CL. 37.

CONOPCO, INC., GREENWICH, CT:
 3,177,973. INT. CL. 3.

CONOR MEDSYSTEMS, INC., MENLO PARK, CA:
 3,177,695. INT. CL. 10.

CONSORTIUM FOR GRADUATE STUDY IN MANAGEMENT, ST. LOUIS, MO:
 3,176,295. PUB. 9-12-2006. MULTIPLE CLASS, INT. CLS. 35, 36 AND 41.

CONSTANTINO RIERA MUNIZ, S.A., VILLAVICIOSA, ASTURIAS, SPAIN:
 830,686. REN. 10-21-06. U.S. CL. 46 (INT. CL. 33).

CONSTRUCTIVE GROUP LLC, LOS ANGELES, CA:
 3,176,747. PUB. 9-12-2006. INT. CL. 25.

CONTEMPL8 T-SHIRTS, MINNEAPOLIS, MN:
 3,176,844. PUB. 9-12-2006. MULTIPLE CLASS, INT. CLS. 25 AND 40.

CONTEX A/S, ALLEROED, DENMARK:
 3,176,359. PUB. 9-12-2006. INT. CL. 9.

CONTI, KURT G., SOUTH PLAINFIELD, NJ:
 3,176,165. PUB. 9-12-2006. MULTIPLE CLASS, INT. CLS. 37, 39, 40 AND 42.

CONTINENTAL DATALABEL, INC., ELGIN, IL:
 2,309,765. CANC. INT. CL. 16.

CONTINENTOIL, INC., TORTOLA, BR. VIRGIN ISLANDS:
 3,175,780. PUB. 2-28-2006. MULTIPLE CLASS, INT. CLS. 4 AND 35.

CONTINUOUS COMPUTING CORPORATION, SAN DIEGO, CA:
 3,176,116. PUB. 9-12-2006. INT. CL. 9.

CONTINUUM INTERNATIONAL PUBLISHING GROUP LTD., THE, LONDON SE1 7NX, GREAT BRITAIN:
 3,177,344. MULTIPLE CLASS, INT. CLS. 9, 16 AND 41.

CONTROLS INTERNATIONAL, INC., DALLAS, TX:
 2,060,794. REN. 10-24-06. INT. CL. 9.
 2,060,795. REN. 10-24-06. INT. CL. 9.

CONVERGENT MEDIA NETWORK LTD., VICTORIA, CANADA:
 3,178,140. INT. CL. 9.

CONXION CORP., SAN CLARA, CA:
 2,309,662. CANC. MULTIPLE CLASS, INT. CLS. 38 AND 42.

COOK, CRAIG, GAINESVILLE, GA:
 1,949,127. CANC. INT. CL. 42.

COOK, JEAN C., KIRKLAND, WA:
 3,177,753. INT. CL. 25.

COOKIE CHIX GOURMET COOKIE COMPANY, LLC, MEDINA, OH:
 3,176,269. PUB. 9-12-2006. INT. CL. 30.

COOL SPRINGS MUSIC GROUP, LLC, FRANKLIN, TN:
 3,178,350. INT. CL. 9.

COOPER & COMPANY, INC., CINCINNATI, OH:
 2,310,110. CANC. INT. CL. 18.

COOPER TECHNOLOGIES COMPANY, HOUSTON, TX, B-LINE SYSTEMS, INC., HIGHLAND, IL:
 2,003,591. REN. 10-24-06. INT. CL. 6.

COOPER, BARRY P. W., LOUISVILLE, CO:
 3,176,436. PUB. 9-12-2006. INT. CL. 30.

COORS GLOBAL PROPERTIES, INC., LAKEWOOD, CO:
 1,948,761. CANC. INT. CL. 32.
 3,178,721. INT. CL. 32.

COPPER RIVER COUNTRY CLUB, FRESNO, CA:
 3,087,135. CANC. IIRN. RESTORED TO S.N. 76-977,891.

COPY CAT USA, L.L.C., CHESTERFIELD, MO:
 3,178,529. INT. CL. 39.
 3,178,530. INT. CL. 38.
 3,178,531. INT. CL. 35.

COPY DATA GROUP, INC., VIRGINIA BEACH, VA:
 1,378,545. CANC. INT. CL. 42.

CORBETT, CRAIG ALLEN, COLLINS, GA:
 3,178,581. INT. CL. 28.

CORBIS CORPORATION, SEATTLE, WA:
 3,178,257. MULTIPLE CLASS, INT. CLS. 9, 16 AND 42.
 3,178,259. MULTIPLE CLASS, INT. CLS. 9, 16 AND 42.

CORE COMPANIES, THE, PORTLAND, OR, CORE COMPANIES, THE, PORTLAND, OR:
 1,992,953. REN. 10-20-06. MULTIPLE CLASS, INT. CLS. 9 AND 16.

- CORE SOFT CORPORATION, ATLANTA, GA:
2,308,382, CANC. INT. CL. 41.
2,308,384, CANC. INT. CL. 41.
- COREX TECHNOLOGIES AND SOLUTIONS INC., MILTON, ONTARIO, CANADA:
3,176,419, PUB. 9-12-2006. MULTIPLE CLASS, INT. CLS. 35 AND 42.
- CORGI CLASSICS LIMITED, LEICESTER, UNITED KINGDOM:
3,178,290, INT. CL. 28.
- CORNELL, HEIDI, LOS ANGELES, CA AND ZIONS, BRADLEY, LOS ANGELES, CA:
3,176,403, PUB. 9-12-2006. INT. CL. 25.
- CORNERSTONE BUILDING ANALYSIS, INC., KISSIMMEE, FL:
3,176,613, PUB. 9-12-2006. INT. CL. 37.
- CORNING INCORPORATED, CORNING, NY:
1,377,927, CANC. INT. CL. 9.
- CORONITI, SAM, PHOENIXVILLE, PA:
3,176,749, PUB. 9-12-2006. INT. CL. 39.
- CORPORATE ENTERTAINMENT SPECIALISTS, INC., TREASURE ISLAND, FL:
3,176,268, PUB. 9-12-2006. INT. CL. 35.
- CORPORATE EXPRESS, INC., BROOMFIELD, CO:
3,176,856, PUB. 9-12-2006. INT. CL. 35.
- CORPORATE MEDIA PARTNERS, LOS ANGELES, CA, DBA AMERICAST:
2,308,679, CANC. INT. CL. 38.
- CORPORATE SYNERGIES GROUP, INC., MT. LAUREL, NJ:
3,175,919, PUB. 9-12-2006. INT. CL. 36.
- CORPUS CHRISTI HOCKEY CLUB, INC., CORPUS CHRISTI, TX:
2,309,701, CANC. INT. CL. 16.
- CORRAL AT BRECKENRIDGE HOMEOWNERS ASSOCIATION, THE, BRECKENRIDGE, CO:
3,176,688, PUB. 9-12-2006. INT. CL. 35.
- CORRIGAN, BRUCE, KNOXVILLE, TN:
3,177,059, PUB. 9-12-2006. INT. CL. 41.
- CORROSION ENGINEERING, INC., MESA, AZ:
1,995,651, REN. 10-21-06. INT. CL. 17.
- CORUS BANKSHARES, INC., CHICAGO, IL:
2,077,185, REN. 10-26-06. INT. CL. 36.
- COSENTINO SIGNATURE ENTERPRISES LTD LLC, YOUNTVILLE, CA:
3,176,533, PUB. 9-12-2006. INT. CL. 33.
3,176,534, PUB. 9-12-2006. INT. CL. 33.
- COSMEDIC R & D, INC., ROCKLIN, CA:
3,177,516, MULTIPLE CLASS, INT. CLS. 8 AND 10.
- COSTCO WHOLESALE CORPORATION, ISSAQUAH, WA:
3,178,169, MULTIPLE CLASS, INT. CLS. 39 AND 43.
- COTA, ANGELICA, SOUTH GATE, CA:
3,177,705, MULTIPLE CLASS, INT. CLS. 18 AND 25.
- COTTON & ELSE, INC., LAUDERDALE LAKES, FL:
3,176,446, PUB. 9-12-2006. INT. CL. 25.
- COUNTY MATERIALS CORPORATION, MARATHON, WI:
2,308,927, CANC. MULTIPLE CLASS, INT. CLS. 19 AND 35.
- COURTNEY-FISKE, PHILIPPA, SAN FRANCISCO, CA, DBA MEANT2BE AND FISKE, ROBERT, SAN FRANCISCO, CA:
2,309,058, CANC. INT. CL. 41.
- COURTROOM TELEVISION NETWORK LLC, NEW YORK, NY:
3,178,260, MULTIPLE CLASS, INT. CLS. 9, 38, 41 AND 42.
- COVENANT MINISTRIES INTERNATIONAL, MARYLAND HEIGHTS, MO:
2,309,547, CANC. INT. CL. 41.
- COX ACQUISITION CORP., BEVERLY, MA:
2,308,489, CANC. INT. CL. 9.
- COX COMMUNICATIONS, INC., ATLANTA, GA:
2,007,780, REN. 10-25-06. MULTIPLE CLASS, INT. CLS. 38 AND 41.
- CR LICENSE, LLC, TUCSON, AZ:
3,178,365, INT. CL. 45.
3,178,367, INT. CL. 41.
- CRA INTERNATIONAL, INC., BOSTON, MA:
3,177,923, MULTIPLE CLASS, INT. CLS. 35, 36 AND 42.
- CRAFTEC INC., CHARLOTTESVILLE, VA:
1,992,466, REN. 10-22-06. MULTIPLE CLASS, INT. CLS. 37 AND 42.
- CRAFTS, ETC., LTD., OKLAHOMA CITY, OK:
2,309,636, CANC. INT. CL. 35.
2,309,639, CANC. INT. CL. 35.
- CRAGAR INDUSTRIES, INC., PHOENIX, AZ, CRAGAR INDUSTRIES, INC., COMPTON, CA:
1,010,106, REN. 10-26-06. U.S. CL. 19 (INT. CL. 12).
- CRANE CO., STAMFORD, CT:
1,045,353, REN. 10-22-06. INT. CL. 11.
- CREATE MAGIC, INC., SANTA FE SPRINGS, CA:
3,176,067, PUB. 9-12-2006. MULTIPLE CLASS, INT. CLS. 9 AND 11.
- CREATIVE ALTERNATIVES, INCORPORATED, TURLOCK, CA:
1,948,402, CANC. MULTIPLE CLASS, INT. CLS. 41 AND 42.
- CREATIVE ASSOCIATES INTERNATIONAL, INC., WASHINGTON, DC:
3,177,536, INT. CL. 16.
- CREATIVE BEVERAGE COMPANY, EVANSVILLE, IN TO FIRE FIGHTER'S FOODS, LLC, CHRISNEY, IN:
1,949,561, CANC. INT. CL. 32.
- CREATIVE HEALTHCARE SOLUTIONS, LLC, WESTERVILLE, OH:
3,176,842, PUB. 9-12-2006. INT. CL. 41.
- CREATIVE POINT, INC., FREMONT, CA TO MEAD CORPORATION, THE, DAYTON, OH:
1,948,383, CANC. INT. CL. 9.
- CRI 2000, L.P., SAN DIEGO, CA:
3,178,254, INT. CL. 16.
- CROSS COUNTRY PAPER PRODUCTS, CORP., HAUPAUGE, NY:
2,104,991, COR. INT. CL. 10.
2,110,530, COR. INT. CL. 10.
2,113,700, COR. INT. CL. 16.
2,133,318, COR. INT. CL. 10.
- CROSSFIRE AUSTRALIA PTY LTD, BRAIDWOOD, AUSTRALIA:
3,177,723, INT. CL. 18.
3,177,724, INT. CL. 18.
- CROSSMAN, MARY E., ATLANTA, GA:
2,309,604, CANC. INT. CL. 9.
- CROWN CRAFTS, INC., ATLANTA, GA:
2,308,330, CANC. INT. CL. 24.
- CROWN POLY, INC., HUNTINGTON PARK, CA:
3,178,103, INT. CL. 16.
- CRS, INC., WILLIAMSPORT, PA:
1,619,579, REN. 10-26-06. INT. CL. 9.
- CRYOCOR, INC., SAN DIEGO, CA:
3,177,838, INT. CL. 10.
- CRYOLIFE, INC., KENNESAW, GA:
1,357,365, REN. 10-25-06. INT. CL. 42.
1,357,366, REN. 10-25-06. INT. CL. 42.
- CRYOVAC, INC., ELMWOOD PARK, NJ:
2,308,526, CANC. INT. CL. 7.
- CSG INTERACTIVE, LLC, TUSTIN, CA:
2,308,831, CANC. INT. CL. 35.
- CSH-INGRE LLC, MISSISSAUGA, CANADA:
1,993,428, REN. 10-26-06. INT. CL. 42.
- CTI PAPER GROUP, INC., SUN PRAIRIE, WI:
3,178,061, INT. CL. 16.
- CTS CORPORATION, ELKHART, IN:
2,308,736, CANC. INT. CL. 9.
- CULLANDER, HELEN J., BERKELEY, CA, AKA HELEN PALMER:
1,946,838, REN. 10-26-06. INT. CL. 9.
- CULLIMORE AND RING TECHNOLOGIES, INC., LITTLETON, CO:
3,178,399, INT. CL. 9.
- CULLMAN VENTURES, INC., NEW YORK, NY:
2,310,086, CANC. INT. CL. 16.
- CUMMINS ENGINE COMPANY, INC., COLUMBUS, IN:
1,377,888, CANC. INT. CL. 7.
1,378,014, CANC. INT. CL. 12.
- CUNEO CELLARS, LLC, CARLTON, OR:
3,176,735, PUB. 9-12-2006. INT. CL. 33.

CUPID FOUNDATIONS, INC., NEW YORK, NY:
3,177,156, PUB. 9-12-2006. INT. CL. 25.

CUREMARK, LLC, YONKERS, NY:
3,177,029, PUB. 9-12-2006. INT. CL. 42.

CURRY IN THE BOX LLC, MADISON, WI:
3,176,943, PUB. 9-12-2006. INT. CL. 43.

CUSTOM ACCOMMODATIONS, INC., BRISTOL, TN:
3,176,091, PUB. 9-12-2006. INT. CL. 43.

CUSTOM COMMERCIAL DRY CLEANERS, INC., HAYWARD, CA:
3,178,542, MULTIPLE CLASS, INT. CLS. 35 AND 37.

CUSTOM CRAFT VANS, INC., MILWAUKEE, WI:
2,309,845, CANC. INT. CL. 12.

CUSTOM FENCE COMPANY INC., KAYSVILLE, UT:
2,308,972, CANC. INT. CL. 37.

CYCLEBYNET, INC., LOS GATOS, CA:
2,309,757, CANC. INT. CL. 42.

CYCLONE PRINTING, INC., NORTH PLAINFIELD, NJ:
3,176,006, PUB. 9-12-2006. INT. CL. 11.

CYPRESS LAND COMPANY, LONG BEACH, CA:
2,011,466, REN. 10-25-06. INT. CL. 36.
2,011,466, CANC. INT. CL. 37.

CYVEX TECHNOLOGIES, INC., IRVINE, CA:
2,309,141, CANC. INT. CL. 5.

CZ-USA, KANSAS CITY, KS:
3,178,380, INT. CL. 13.

D & Lyla, LLC, NEW YORK, NY:
3,177,826, MULTIPLE CLASS, INT. CLS. 18 AND 20.

D. A. KREUTER ASSOCIATES, INC., CONSHOHOCKEN, PA, AKA DAK ASSOCIATES:
1,981,511, REN. 10-26-06. INT. CL. 35.

D. BLACKMON-BAILEY, INC., LOS ANGELES, CA:
2,309,726, CANC. INT. CL. 41.

D.L.I., INC., BEAVERTON, OR:
3,176,189, PUB. 9-12-2006. MULTIPLE CLASS, INT. CLS. 6 AND 37.

D&M SALES, INC., MEDWAY, MA:
3,175,785, PUB. 9-12-2006. INT. CL. 11.

DA VINCI GOURMET, LTD., SEATTLE, WA:
2,309,482, CANC. INT. CL. 30.

DADE BEHRING INC., DEERFIELD, IL:
3,177,142, PUB. 9-12-2006. INT. CL. 9.

DAIDO KOGYO CO., LTD., KAGA, ISHIKAWA PREF., JAPAN:
3,176,137, PUB. 9-12-2006. INT. CL. 7.

DAIEI, INC., THE, CHUO-KU, KOBE-SHI, JAPAN:
1,378,153, CANC. INT. CL. 25.

DAIMLER CHRYSLER CORPORATION, AUBURN HILLS, MI, CHRYSLER CORPORATION, AUBURN HILLS, MI:
2,086,357, REN. 10-23-06. INT. CL. 12.

DAIRY FRESH PRODUCTS CO., ONTARIO, CA:
2,310,081, CANC. INT. CL. 29.

DAISY BRAND, LP, DALLAS, TX:
1,378,298, CANC. INT. CL. 29.

DAIWA SEIKO, INC., HIGASHIKURUME-CITY, TOKYO, JAPAN:
3,177,430, INT. CL. 28.

DALBANI CORPORATION, MIAMI, FL:
2,308,205, CANC. INT. CL. 9.

DALE MEDICAL PRODUCTS, INC., PLAINVILLE, MA:
1,377,994, CANC. INT. CL. 10.

DALO FRANCHISING INC., NEW YORK, NY:
2,308,573, CANC. INT. CL. 42.

DALY, CARSON, NEW YORK, NY AND RIFKIND, JONATHAN, NEW YORK, NY:
3,178,671, INT. CL. 9.

DAMAC PRODUCTS INC., LA MIRANDA, CA:
1,993,503, REN. 10-24-06. INT. CL. 9.

DAN DOOLEY LIMITED, NEW YORK, NY:
3,175,788, PUB. 9-12-2006. INT. CL. 39.

DAN TRADE, INC., PASADENA, CA:
1,378,307, CANC. INT. CL. 29.

DAN-DEE INTERNATIONAL, LTD., JERSEY CITY, NJ:
3,177,685, INT. CL. 20.
3,177,935, MULTIPLE CLASS, INT. CLS. 20 AND 28.

DANCE USA, INC., LAS VEGAS, NV:
3,176,474, PUB. 9-12-2006. INT. CL. 41.

DANCEKIDZ, LLC, HADDONFIELD, NJ:
3,176,797, PUB. 9-12-2006. INT. CL. 41.

DANCING SANDWICH ENTERPRISES, INC., ANN ARBOR, MI:
3,177,098, PUB. 9-12-2006. INT. CL. 30.
3,177,099, PUB. 9-12-2006. INT. CL. 30.

DANIEL, COLONNESE, CAMBRIDGE, MA:
3,177,812, INT. CL. 38.

DANIEL, CORNOLDI, HARTSDALE, NY:
2,309,733, CANC. INT. CL. 25.

DANIS, PAUL O., BOYLSTON, MA, DBA EASTWOODS CONSULTING:
3,178,634, INT. CL. 35.

DANNON COMPANY, INC., THE, WHITE PLAINS, NY:
3,178,670, INT. CL. 29.

DANNY ZECK FORD LINCOLN MERCURY CORP., LEAVENWORTH, KS:
3,176,324, PUB. 9-12-2006. INT. CL. 35.

DANNY, JENNIFER A., STEVENSON RANCH, CA:
3,177,571, INT. CL. 16.

DANZIG, GLENN, LOS ANGELES, CA:
1,949,449, CANC. INT. CL. 16.

DARON WORLDWIDE TRADING INC., FAIRFIELD, NJ:
3,178,150, INT. CL. 28.

DART INDUSTRIES INC., ORLANDO, FL, TUPPER CORPORATION, NORTH SMITHFIELD, RI:
633,394, REN. 10-25-06. U.S. CL. 2 (INT. CL. 21).

DARY N.V., 8900 IEPEP, BELGIUM:
2,309,034, CANC. MULTIPLE CLASS, INT. CLS. 29 AND 30.

DATA COMMUNICATIONS CORPORATION, MEMPHIS, TN:
2,309,213, CANC. INT. CL. 42.

DATA SOURCE ONE, INC., TAMPA, FL:
1,377,989, CANC. INT. CL. 9.

DAUCOURT MARTIN IMPORTS, LLC, DALLAS, TX:
3,177,900, INT. CL. 33.

DAUKSZA, LEONARD, PASADENA, CA:
3,176,913, PUB. 9-12-2006. INT. CL. 42.

DAVE & BUSTER'S I, L.P., DALLAS, TX:
3,176,873, PUB. 9-12-2006. INT. CL. 33.

DAVID N. BROWN, INC., SEATTLE, WA, DBA FOX PLUMBING AND HEATING:
3,178,464, INT. CL. 37.

DAVID, INC., NEW YORK, NY:
1,378,244, CANC. INT. CL. 25.

DAVIS, JOHN H., EUGENE, OR:
3,175,887, PUB. 9-12-2006. INT. CL. 28.

DAVIS, ROBERT J, CAVE CREEK, AZ:
3,175,925, PUB. 9-12-2006. INT. CL. 37.

DAVIS, STEVEN MEARL, MEMPHIS, TN, DBA PERFORMANCE DISTRIBUTORS INC.:
2,308,163, CANC. INT. CL. 7.

DAWSON, RICHARD A., CANNONSBURG, MI, DBA DEER QUEST LTD.:
1,992,216, REN. 10-26-06. INT. CL. 28.

DAY, THOM, JEFFERSON CITY, MO:
2,309,497, CANC. INT. CL. 12.

DAYHOFF, LLC, CLEARWATER, FL:
3,176,113, PUB. 9-12-2006. INT. CL. 30.

DAYSRING CARDS, INC., SILOAM SPRINGS, AR, DAVID C. COOK PUBLISHING CO., SILOAM SPRINGS, AR, DBA DAYSRING CARDS:
2,000,052, REN. 10-26-06. INT. CL. 16.

DAYSTAR TECHNOLOGIES, HALFMOON, NY:
3,178,218, INT. CL. 9.

DAYSTAR TECHNOLOGIES INC., HALFMOON, NY:
3,178,524, INT. CL. 9.

DAYTON PROGRESS CORPORATION, DAYTON, OH, DAYTON PERFORATORS, INC., DAYTON, OH:
632,655, REN. 10-20-06. U.S. CL. 23 (INT. CLS. 7 AND 8).

DBD, INC., WILMINGTON, DE:
3,175,879, PUB. 9-12-2006. MULTIPLE CLASS, INT. CLS. 18, 25, 26 AND 35.

DBOT5, LLC, MERIDIAN, ID:
3,176,675, PUB. 9-12-2006. MULTIPLE CLASS, INT. CLS. 25 AND 28.

- DC COMICS, NEW YORK, NY:
3,178,454, INT. CL. 41.
- DC LICENSING LLC, GREENWICH, CT:
3,177,569, INT. CL. 25.
- DE VERENIGING: KONINKLIJKE NEDERLANDSCHE
VOETBALBOND, 3707 HX ZEIST, NETHERLANDS:
2,303,132, CANC. MULTIPLE CLASS, INT. CLS. 3, 14, 21,
24, 26, 28 AND 30.
- DEAD RED CORPORATION, UNIVERSITY PLACE, WA:
3,178,383, INT. CL. 32.
- DEAN COOPERATIVE BANK, FRANKLIN, MA:
3,176,609, PUB. 9-12-2006. INT. CL. 36.
3,176,610, PUB. 9-12-2006. INT. CL. 42.
- DEARBORN FEDERAL CREDIT UNION, DEARBORN, MI:
2,308,778, CANC. INT. CL. 36.
- DEBOURGH MANUFACTURING COMPANY, MINNEAPOLIS,
MN:
1,377,872, CANC. INT. CL. 6.
- DECISION STRATEGIES/FAIRFAX INTERNATIONAL,
LLC, FALLS CHURCH, VA:
2,308,621, CANC. MULTIPLE CLASS, INT. CLS. 35, 36
AND 42.
- DECISIVE ENVIRONMENT, LLC, SALT LAKE CITY, UT:
3,175,998, PUB. 9-12-2006. MULTIPLE CLASS, INT. CLS.
35, 36, 41 AND 42.
- DECO LAV, INC., DEERFIELD BEACH, FL:
3,176,545, PUB. 9-12-2006. MULTIPLE CLASS, INT. CLS.
11, 20 AND 21.
- DEEP SOUTH HOLDING, L.P., IRVING, TX:
3,176,496, PUB. 9-12-2006. MULTIPLE CLASS, INT. CLS.
35 AND 36.
3,176,497, PUB. 9-12-2006. MULTIPLE CLASS, INT. CLS.
35 AND 36.
- DEERE & COMPANY, MOLINE, IL:
1,948,420, CANC. INT. CL. 42.
- DEGUSSA AKTIENGESELLSCHAFT, FRANKFURT/MAIN,
FED REP GERMANY:
2,309,682, CANC. MULTIPLE CLASS, INT. CLS. 3 AND 5.
- DEGUSSA BUILDING SYSTEMS, INC., SHAKOPEE, MN:
3,178,033, INT. CL. 19.
- DEGUSSA CORPORATION, PARSIPPANY, NJ:
3,177,438, MULTIPLE CLASS, INT. CLS. 2 AND 16.
- DEICHMANN+CO LTD, TSUEN WAN, HONG KONG:
3,176,960, PUB. 9-12-2006. INT. CL. 26.
- DEITZ, SUSAN, NEW YORK, NY:
3,176,082, PUB. 9-12-2006. MULTIPLE CLASS, INT. CLS.
41 AND 45.
- DEL CONTE-FOX, TONI, LIVERMORE, CA, DBA ONCE
UPON A TIME:
1,645,683, COR. INT. CL. 11.
- DEL MONTE CORPORATION, SAN FRANCISCO, CA,
STAR-KIST FOODS, INC., NEWPORT, KY:
1,995,891, REN. 10-26-06. INT. CL. 31.
- DEL PHARMACEUTICALS, INC., UNIONDALE, NY:
3,176,711, PUB. 9-12-2006. INT. CL. 5.
- DEL VALLE, CATHERINE J., COSTA MESA, CA:
3,178,478, INT. CL. 18.
- DELAWARE CAPITAL FORMATION, INC., WILMINGTON,
DE:
2,721,958, COR. MULTIPLE CLASS, INT. CLS. 7 AND 11.
3,176,323, PUB. 9-12-2006. INT. CL. 9.
3,178,469, INT. CL. 9.
3,178,754, INT. CL. 7.
- DELICIOUS BRANDS, LLC, DALLAS, TX:
3,178,119, INT. CL. 3.
- DELLA LUXA, LLC, AUBURNDALE, MA:
3,177,864, MULTIPLE CLASS, INT. CLS. 40 AND 42.
- DELORME PUBLISHING COMPANY, INC., YARMOUTH,
ME:
2,309,983, CANC. INT. CL. 9.
- DELTA EDUCATION, LLC, NASHUA, NH:
3,052,322, COR. MULTIPLE CLASS, INT. CLS. 16 AND
28.
- DELTEK SYSTEMS, INC., HERDON, VA:
3,175,850, PUB. 9-12-2006. INT. CL. 9.
- DELUXE ENTERPRISE OPERATIONS, INC., SHOREVIEW,
MN, STEEWE ENTERPRISES INCORPORATED, NEW-
PORT BEACH, CA, DBA EXPRESSIONS:
1,404,868, REN. 10-25-06. INT. CL. 16.
- DEMCO, INC., MADISON, WI:
3,177,146, PUB. 9-12-2006. INT. CL. 17.
- DEMELLO, CHANI C., SEAL BEACH, CA:
3,178,110, INT. CL. 25.
- DEN-MAT CORPORATION, SANTA MARIA, CA:
3,176,884, PUB. 9-12-2006. INT. CL. 40.
3,177,044, PUB. 9-12-2006. INT. CL. 35.
- DENNCO, INC., SALEM, NH:
3,178,539, INT. CL. 28.
- DENNY'S, INC., SPARTANBURG, SC TO DFO, INC.,
SPARTANBURG, SC:
1,948,747, CANC. INT. CL. 30.
- DENNY'S, INC., SPARTANBURG, SC TO EDWARDS FINE
FOODS, INC., NORCROSS, GA:
1,948,987, CANC. INT. CL. 30.
1,948,989, CANC. INT. CL. 30.
- DEPARTMENT OF THE ARMY, ARLINGTON, VA:
3,136,164, COR. INT. CL. 25.
3,177,133, PUB. 9-12-2006. INT. CL. 17.
- DEPARTMENT OF THE INTERIOR, WASHINGTON, DC:
3,175,869, PUB. 9-12-2006. MULTIPLE CLASS, INT. CLS.
8, 14, 16, 18, 25 AND 41.
- DEPOSIT GUARANTY NATIONAL BANK, JACKSON, MS:
1,378,438, CANC. INT. CL. 37.
- DEPUY, INC., WARSAW, IN:
3,177,842, INT. CL. 10.
- DERMADOCTOR.COM, INC., KANSAS CITY, MO:
3,177,627, INT. CL. 3.
- DERMOPTICA INC., WASHINGTON, DC:
3,176,686, PUB. 9-12-2006. INT. CL. 20.
3,176,687, PUB. 9-12-2006. INT. CL. 20.
- DES CHAMPS LABORATORIES, INC., NATURAL BRIDGE
STATION, VA:
2,308,910, CANC. INT. CL. 11.
- DESIGNING WOMEN'S WEIGHT LOSS, INC., PRESCOTT
VALLEY, AZ:
3,176,580, PUB. 9-12-2006. INT. CL. 41.
- DESILVESTRO, HANS, HOWICK, AUCKLAND, NEW
ZEALAND:
3,178,492, INT. CL. 35.
- DESILVIO, LOUIS F., COLLINSVILLE, OK:
3,177,143, PUB. 9-12-2006. INT. CL. 9.
- DEUTSCHE TELEKOM AG, BONN, FED REP GERMANY:
3,175,956, PUB. 9-12-2006. INT. CL. 35.
3,176,412, PUB. 5-23-2006. INT. CL. 16.
- DEVOY, JOSEPH P., LONG BEACH, CA:
3,178,818, INT. CL. 41.
- DEXTER-RUSSELL, INC., SOUTHBRIDGE, MA:
3,178,649, INT. CL. 8.
- DIAGEO NORTH AMERICA, INC., NORWALK, CT:
3,177,813, INT. CL. 33.
3,178,155, INT. CL. 33.
3,178,253, INT. CL. 33.
3,178,487, INT. CL. 33.
- DIAGXOTICS, INC., WILTON, CT:
1,947,952, CANC. INT. CL. 5.
- DIAL BRANDS, INC., SCOTTSDALE, AZ:
3,177,907, INT. CL. 3.
3,178,557, INT. CL. 3.
- DIALOGIC COMMUNICATIONS CORPORATION, FRANK-
LIN, TN:
1,377,922, CANC. INT. CL. 9.
- DIAMOND EXPRESS CORP., LOS ANGELES, CA:
2,013,404, REN. 10-24-06. INT. CL. 42.
- DIAMOND OFFSHORE DRILLING, INC., HOUSTON, TX,
DIAMOND OFFSHORE DRILLING, INC., HOUSTON, TX:
1,978,647, REN. 10-20-06. INT. CL. 37.
- DIAMOND SHINE, INC., WICKLIFFE, OH:
3,175,911, PUB. 9-12-2006. INT. CL. 3.
- DIAMOND, AUDREY, WEST PALM BEACH, FL:
3,177,509, INT. CL. 16.
- DIAMOND, WAYNE, GLENSIDE, PA:
1,993,884, REN. 10-25-06. INT. CL. 5.

DIC ENTERTAINMENT CORPORATION, BURBANK, CA:
3,177,586, INT. CL. 28.

DICTAPHONE CORPORATION, STRATFORD, CT:
2,308,546, CANC. INT. CL. 41.

DIEBOLD, INCORPORATED, NORTH CANTON, OH:
3,175,959, PUB. 9-12-2006. INT. CL. 9.
3,175,960, PUB. 9-12-2006. INT. CL. 9.
3,175,961, PUB. 9-12-2006. INT. CL. 9.

DIESEL SPA, MOLVENA 36060, ITALY:
2,308,187, CANC. INT. CL. 25.

DIETER TIEN, FED REP GERMANY:
3,177,240, PUB. 9-12-2006. MULTIPLE CLASS, INT. CLS.
3, 5, 11, 20, 21 AND 24.

DIGARCCO, LLC, BAILEY, CO:
2,308,759, CANC. INT. CL. 9.

DIGEO, INC., KIRKLAND, WA FROM DIGEO BROAD-
BAND, INC., KIRKLAND, WA:
3,177,331, INT. CL. 35.

DIGIRAY CORPORATION, DANVILLE, CA:
3,175,846, PUB. 9-12-2006. MULTIPLE CLASS, INT. CLS. 9
AND 10.

DIGISETTE, LLC, NEW VERNON, NJ:
3,177,951, INT. CL. 11.

DIGITAL DIRECTORY, L.L.C., KNOXVILLE, TN:
2,308,301, CANC. INT. CL. 35.

DIGITAL ORIGIN, INC., MOUNTAIN VIEW, CA:
2,309,804, CANC. INT. CL. 9.

DIGITAL SYSTEMS INTERNATIONAL CORPORATION,
ARLINGTON, VA:
2,309,655, CANC. MULTIPLE CLASS, INT. CLS. 35, 37
AND 42.

DIGITAL SRL, MILAN, ITALY:
3,177,711, INT. CL. 9.

DIGITGLOBAL COMMUNICATIONS, INC., KEW GAR-
DENS, NY:
3,176,355, PUB. 9-12-2006. INT. CL. 16.

DIMENSION FABRICATORS, INC., SCHENECTADY, NY:
3,176,563, PUB. 9-12-2006. INT. CL. 6.

DINO DE LAURENTIIS COMPANY, BEVERLY HILLS, CA:
2,308,343, CANC. MULTIPLE CLASS, INT. CLS. 9 AND
41.

DINTENFASS SUBTLE, SUSAN, BERKELEY, CA:
2,308,536, CANC. INT. CL. 41.

DIOPTICS MEDICAL PRODUCTS, INC., SAN LUIS OBISPO,
CA:
3,178,655, INT. CL. 9.

DIPIPPO, PHILIP, A., OAKLAND, CA AND PAOLINO,
KEITH, J., OAKLAND, CA:
3,177,647, INT. CL. 9.

DIRECT SUPPLY, INC., MILWAUKEE, WI:
3,178,749, MULTIPLE CLASS, INT. CLS. 35 AND 42.

DIRECT SURPLUS SALES, INC., OROVILLE, CA:
3,176,255, PUB. 9-12-2006. MULTIPLE CLASS, INT. CLS. 6
AND 39.

DIRTT ENVIRONMENTAL SOLUTIONS LTD., CALGARY,
ALBERTA, CANADA:
3,176,427, PUB. 9-12-2006. INT. CL. 42.

DISCOVERY RESEARCH GROUP OF UTAH, INC., SALT
LAKE CITY, UT:
3,178,094, INT. CL. 42.

DISGUISE, INC., POWAY, CA:
3,178,628, INT. CL. 25.

DISKLESSWORKSTATIONS.COM, LLC, BIRMINGHAM,
MI:
3,175,951, PUB. 9-12-2006. INT. CL. 9.

DISNEY ENTERPRISES, INC., BURBANK, CA:
3,123,966, COR. INT. CL. 18.
3,176,258, PUB. 9-12-2006. INT. CL. 41.
3,177,672, INT. CL. 14.
3,178,664, INT. CL. 28.

DISTINCTIVE COMPONENTS LTD., BALDWIN, MD:
3,178,043, INT. CL. 31.

DIVERSIFIED BUSINESS COMMUNICATIONS, PORT-
LAND, ME, NATIONAL FISHERMAN EXPOSITIONS,
INC., CAMDEN, ME:
1,045,568, REN. 10-20-06. INT. CL. 35.

DIVERSIFIED COMMUNICATIONS, PORTLAND, ME:
1,948,648, CANC. INT. CL. 35.

DIVICOM INC., MILPITAS, CA:
2,309,571, CANC. INT. CL. 9.

DIVINSA LLC, FOX ISLAND, WA:
3,176,348, PUB. 9-12-2006. INT. CL. 9.

DIXON TICONDEROGA COMPANY, VERO BEACH, FL:
1,381,367, REN. 10-23-06. INT. CL. 16.

DIXON, BERNARD WAYNE JR., CHAPEL HILL, NC:
3,178,567, MULTIPLE CLASS, INT. CLS. 16 AND 25.

DIXON, CHARLES, NORTH ARLINGTON, NJ:
3,176,710, PUB. 9-12-2006. INT. CL. 16.

DLC ENTERPRISES, INC., PARAMOUNT, CA:
2,902,846, COR. MULTIPLE CLASS, INT. CLS. 3 AND 5.

DLJ LONG TERM INVESTMENT CORPORATION, CHICA-
GO, IL:
2,309,023, CANC. INT. CL. 36.

DMB LADERA LLC, SAN JUAN CAPISTRANO, CA:
3,177,655, MULTIPLE CLASS, INT. CLS. 36 AND 37.

DMG WORLD MEDIA (USA) INC., TORONTO, CANADA:
2,309,175, CANC. INT. CL. 16.

DNA PARKS & RESORTS AT YOSEMITE, INC., YOSEMITE,
CA:
1,408,511, REN. 10-25-06. INT. CL. 18.

DNASTAR, INC., MADISON, WI:
1,408,300, REN. 10-26-06. INT. CL. 9.

DNC PARKS & RESORTS AT YOSEMITE, INC., YOSEMITE,
CA:
1,405,800, REN. 10-26-06. INT. CL. 16.

DOBSON CELLULAR SYSTEMS, INC., OKLAHOMA CITY,
OK:
3,178,195, INT. CL. 36.

DOCKTOR PET CENTERS, INC., WILMINGTON, MA:
1,378,336, CANC. INT. CL. 31.

DOCTER OPTICS GMBH, DE-07806 NEUSTADT/ORLA-
MOLBITZ, FED REP GERMANY:
3,175,797, PUB. 9-12-2006. MULTIPLE CLASS, INT. CLS.
9, 21, 40 AND 42.

DODGE, KAREN, HIGHLAND VILLAGE, TX:
3,175,953, PUB. 9-12-2006. INT. CL. 16.

DODO CORP, SEOUL 135-120, REPUBLIC OF KOREA:
2,309,720, CANC. INT. CL. 3.

DOINK, INC., CORAL GABLES, FL:
3,176,615, PUB. 9-12-2006. INT. CL. 42.

DOLPHIN, PATRICK, CHERRY HILL, NJ:
3,175,764, PUB. 9-12-2006. INT. CL. 25.

DOME'S DAY PRODUCTIONS, LLC, BROOKLYN, NY:
3,178,808, INT. CL. 41.

DON PARRIS INC., BROOKLYN, NY:
3,175,844, PUB. 9-12-2006. INT. CL. 25.

DONALD BYRD DANCE FOUNDATION, INC., THE,
BROOKLYN, NY:
2,308,209, CANC. INT. CL. 41.

DONALD L. BUETTNER, INC., FORT WAYNE, IN, DBA
MIGHTY RIVER PRODUCTIONS:
3,175,884, PUB. 9-12-2006. INT. CL. 41.

DONGWON F&B CO., LTD., SEOUL, REPUBLIC OF KOR-
EA:
3,178,126, INT. CL. 30.

DONNA MIROS, INC., CRANFORD, NJ:
3,178,142, INT. CL. 30.
3,178,143, INT. CL. 35.

DOO, RODNEY, AIEA, HI:
2,308,338, CANC. INT. CL. 25.

DOOSAN TRAINING & TECHNOLOGY CENTER COR-
PORATION, YONGIN-CITY, KYONGGL-DO, REPUBLIC
OF KOREA:
2,308,469, CANC. INT. CL. 30.

DORCHESTER CAPITAL MANAGEMENT COMPANY,
HOUSTON, TX:
3,177,469, INT. CL. 35.

DORIS HOSIERY MILLS LTD., MONTREAL, QUEBEC,
CANADA:
3,176,168, PUB. 9-12-2006. INT. CL. 25.

DORNER MFG. CORP., HARTLAND, WI:
2,061,487, REN. 10-24-06. INT. CL. 7.

DOUGLAS AUTOTECH CORPORATION, BRONSON, MI:
3,178,414, INT. CL. 12.

- DOUGLAS D. BEHREND, A U.S. CITIZEN, AS TRUSTEE OF THE DOUGLAS AND AIDA BEHREND FAMILY TRUST, LOS ANGELES, CA TO DOUGLAS AND AIDA BEHREND FAMILY TRUST, THE, LOS ANGELES, CA:
1,948,605, CANC. INT. CL. 42.
- DR. REGENOLD GMBH INTERNATIONAL REGULATORY AFFAIRS, FED REP GERMANY:
3,177,201, PUB. 9-12-2006. MULTIPLE CLASS, INT. CLS. 35, 38 AND 42.
- DR. NIKOS M. LINARDAKIS, M.D., P.C., SALT LAKE CITY, UT:
3,178,321, INT. CL. 5.
- DR. WOLFF SPORTS & PREVENTION GMBH, D-59757 ARNSBERG, FED REP GERMANY:
2,310,062, CANC. INT. CL. 28.
- DRAITON CORPORATIONS, INC., THE, ST. MARTIN-VILLE, LA:
1,998,576, REN. 10-26-06. INT. CL. 35.
- DRAMATIC CHANGE PTY LTD, SYDNEY, NSW, AUSTRALIA:
3,177,855, INT. CL. 41.
- DRAZGA, EDWARD A., MEDFORD, NJ:
2,035,369, REN. 10-26-06. INT. CL. 3.
- DREAM MERCHANT COMPANY KFT., THE, BUDAPEST, HUNGARY, CREATIONS MEANDRES INC., MONTREAL, QUEBEC, H2L 2R3, CANADA:
2,006,591, REN. 10-26-06. INT. CL. 9.
- DREAM STAGE ENTERTAINMENT, INC., TOKYO, JAPAN:
3,176,185, PUB. 9-12-2006. INT. CL. 25.
- DREAMWELL, LTD., LAS VEGAS, NV:
3,177,497, INT. CL. 35.
- DREAMWOOD DESIGNS, INC., ALPHARETTA, GA:
3,176,502, PUB. 9-12-2006. INT. CL. 35.
- DREXEL HERITAGE FURNITURE INDUSTRIES, INC., HIGH POINT, NC:
3,177,718, MULTIPLE CLASS, INT. CLS. 20, 27 AND 35.
- DROPPING DAYLIGHT, LLC, NASHVILLE, TN:
3,178,084, INT. CL. 9.
- DSI TOYS, INC., HOUSTON, TX:
2,309,814, CANC. INT. CL. 28.
2,309,820, CANC. INT. CL. 28.
- DU BOIS, WENDY, LIVERMORE, CA:
3,177,889, MULTIPLE CLASS, INT. CLS. 9 AND 16.
- DUELL, DAVID L., EVANSVILLE, IN:
2,309,054, CANC. INT. CL. 41.
- DUFREY INTERNATIONAL AG (DUFREY INTERNATIONAL SA), (DUFREY INTERNATIONAL LTD), BASEL, SWITZERLAND:
3,177,211, PUB. 9-12-2006. INT. CL. 35.
3,177,233, PUB. 9-12-2006. INT. CL. 35.
- DUKE UNIVERSITY, DURHAM, NC:
1,411,429, REN. 10-26-06. INT. CL. 25.
- DUNCAN AVIATION, INC., LINCOLN, NE:
2,308,968, CANC. INT. CL. 42.
- DUNDEE CORPORATION, TORONTO, ONTARIO, CANADA:
3,134,600, COR. INT. CL. 36.
3,134,601, COR. INT. CL. 36.
3,178,675, INT. CL. 36.
3,178,676, INT. CL. 36.
- DUNLOP HOLDINGS LIMITED, LONGON SW1P 2PL, ENGLAND, DUNLOP RUBBER COMPANY LIMITED, EDINGTON, BIRMINGHAM 24, ENGLAND:
643,871, REN. 10-25-06. U.S. CL. 19 (INT. CL. 12).
- DUNLOP MAXFLI SPORTS CORPORATION, GREENVILLE, SC:
2,308,881, CANC. INT. CL. 28.
- DUNLOP SLAZENGER CORPORATION, GREENVILLE, SC TO DUNLOP MAXFLI SPORTS CORPORATION, GREENVILLE, SC:
1,949,267, CANC. INT. CL. 28.
- DUPRE ENTERPRISES, INC., BERKELEY HEIGHTS, NJ:
1,948,702, CANC. INT. CL. 42.
- DURACOTE CORPORATION, RAVENNA, OH:
641,461, REN. 10-26-06. U.S. CL. 42 (INT. CL. 27).
- DURST CORPORATION, INC., CRANFORD, NJ, JACLO, INC., BROOKLYN, NY:
1,048,417, REN. 10-26-06. INT. CL. 6.
- DURVET, INC., BLUE SPRINGS, MO:
3,176,245, PUB. 9-12-2006. INT. CL. 16.
- DUTY FREE AMERICAS, INC., HOLLYWOOD, FL:
3,176,948, PUB. 9-12-2006. INT. CL. 35.
- DWYER INSTRUMENTS, INC., MICHIGAN CITY, IN, TAYLOR INSTRUMENT COMPANIES, ROCHESTER 1, NY:
639,636, REN. 10-24-06. U.S. CL. 26 (INT. CL. 9).
- DXCG, INC., BOSTON, MA:
3,178,781, INT. CL. 42.
- DYNACRAFT BSC, INC., SAN RAFAEL, CA:
1,997,003, REN. 10-25-06. INT. CL. 12.
1,998,264, REN. 10-24-06. INT. CL. 12.
1,998,269, REN. 10-24-06. INT. CL. 12.
- DYNAMIC GRAPHICS, INC., ALAMEDA, CA:
2,000,629, REN. 10-26-06. INT. CL. 9.
- DYNAMIC SYSTEM ELECTRONICS CORP., SAN CHUNG CITY, TAIPEI HSIEN, TAIWAN:
3,177,418, INT. CL. 9.
- DYNAMICS RESEARCH CORPORATION, WILMINGTON, MA:
1,378,656, CANC. INT. CL. 9.
- DYRDAHL, LINKE, SEATTLE, WA:
3,177,870, INT. CL. 28.
- E & H RESTORATION L.L.C., DAVENPORT, IA:
3,175,952, PUB. 9-12-2006. INT. CL. 37.
- E. & J. GALLO WINERY, MODESTO, CA:
3,177,686, INT. CL. 33.
- E. LAND LTD., SEOUL, REPUBLIC OF KOREA, SCOFIELD CO., LTD., SEOUL, REPUBLIC OF KOREA:
1,954,018, REN. 10-20-06. INT. CL. 25.
- E. LAND LTD., SEOUL, REPUBLIC OF KOREA, E.LAND CO., LTD., SEOUL, REPUBLIC OF KOREA:
1,986,471, REN. 10-20-06. INT. CL. 25.
- E. REMY MARTIN & CO, 16100 COGNAC, FRANCE:
3,176,450, PUB. 9-12-2006. INT. CL. 33.
- E.G. HILL COMPANY, INC., RICHMOND, IN:
3,177,814, INT. CL. 31.
- E.N.K. PRODUCTIONS, LTD., NEW YORK, NY, DBA ENK INTERNATIONAL:
3,176,957, PUB. 9-12-2006. INT. CL. 35.
- E.R. SQUIBB & SONS, L.L.C., PRINCETON, NJ:
3,177,751, INT. CL. 10.
- E.T. PRODUCTS COMPANY, INC., BREMEN, IN:
2,085,960, REN. 10-20-06. INT. CL. 1.
- E*TRADE FINANCIAL CORPORATION, NEW YORK, NY:
3,178,125, INT. CL. 36.
- E-BEAM SERVICES, INC.:
1,378,480, CANC. INT. CL. 40.
- EADS TELECOM, 78180 MONTIGNY LE BRETONNEUX, FRANCE:
3,069,658, COR. MULTIPLE CLASS, INT. CLS. 9 AND 42.
- EAGLE POSTAL CENTERS, INC., DALLAS, TX:
2,009,862, CANC. INT. CL. 39.
2,009,863, CANC. INT. CL. 39.
- EAGLE WEST TOWER CRANE INC., ABBOTSFORD, CANADA:
3,176,138, PUB. 9-12-2006. INT. CL. 7.
- EARLE M. JORGENSEN COMPANY, LYNWOOD, CA:
1,995,026, REN. 10-25-06. MULTIPLE CLASS, INT. CLS. 40 AND 42.
- EARTHGRAINS COMPANY, THE, ST. LOUIS, MO:
2,309,565, CANC. INT. CL. 30.
- EARTHSHELL CONTAINER CORPORATION, SANTA BARBARA, CA TO EARTHSHELL CORPORATION, SANTA BARBARA, CA:
1,949,730, CANC. INT. CL. 21.
- EAST END MERLOT ALLIANCE INC., CUTCHOGUE, NY:
3,178,470, INT. CL. 33.
- EASTERN CASE CO., INC., MASPEETH, NY:
1,378,111, CANC. INT. CL. 18.
- EASTERN COMPANY, THE, NAUGATUCK, CT, DBA DOING BUSINESS AS EBERHARD MANUFACTURING COMPANY:
2,034,509, REN. 10-26-06. INT. CL. 6.
- EASTERN NEW ENGLAND HYDRAULICS, INC., BEDFORD, NH:
2,308,934, CANC. INT. CL. 37.

EASTMAN KODAK COMPANY, ROCHESTER, NY:
1,948,716, CANC. INT. CL. 9.

EASTMAN, RICHARD, MORRISTOWN, NJ AND ASPEN,
JEAN, MORRISTOWN, NJ:
2,309,340, CANC. INT. CL. 38.

EASY GARDENER PRODUCTS, LTD., WACO, TX, WEATH-
ERLY CONSUMER PRODUCTS, INC., LEXINGTON, KY:
1,989,049, REN. 10-24-06. INT. CL. 5.

EASYGROUP IP LICENSING LIMITED, CAMDEN, LON-
DON NW1 7DL, ENGLAND TO EASY GROUP LIMITED,
ST. HELIER, JERSEY, CHANNEL ISLANDS:
3,084,353, COR. INT. CL. 39.

EAT WELL BE WELL FOODS, INC., HOOD RIVER, OR:
3,177,726, MULTIPLE CLASS, INT. CLS. 29 AND 30.

EATON CORPORATION, CLEVELAND, OH:
3,178,134, INT. CL. 9.

EBB AND FLOW CORP, WEXFORD, PA:
2,309,272, CANC. INT. CL. 35.

EBSO INDUSTRIES, INC., BIRMINGHAM, AL, GREEN
MOUNTAIN RIFLE BARREL CO., INC., CENTER CON-
WAY, NH:
2,014,934, REN. 10-26-06. INT. CL. 13.

ECAPITAL FINANCIAL CORP., SANTA MONICA, CA:
3,177,350, INT. CL. 35.

ECHELON GOLF, INC., CITY OF INDUSTRY, CA TO
TECHEDGE CORP, BALDWIN PARK, CA:
1,948,590, CANC. INT. CL. 28.

ECI TELECOM LTD., PETACH TIKVA 49517, ISRAEL:
3,177,447, INT. CL. 9.

ECKERD COLLEGE, INC., ST. PETERSBURG, FL:
3,176,222, PUB. 9-12-2006. INT. CL. 41.

ECLECTIC INVESTMENTS, INC., NEWPORT BEACH, CA:
3,177,687, INT. CL. 9.

ECOLAB INC., ST. PAUL, MN:
3,178,562, INT. CL. 3.

ECOLE DE BUDO RAJI INTERNATIONAL, PORTLAND,
OR:
3,178,298, INT. CL. 41.

ECOLOGY SOLUTIONS, INC., NORTH HOLLYWOOD, CA:
2,308,140, CANC. INT. CL. 3.

ECOMETRY CORPORATION, DELRAY BEACH, FL:
2,309,829, CANC. INT. CL. 9.

ECONOPHONE INC., BROOKLYN, NY TO BELL, WILFRED
SAMUEL, BOWIE, MD:
1,948,254, CANC. INT. CL. 38.

ECONTINUUM LLC, MINNEAPOLIS, MN:
3,178,297, INT. CL. 42.

ECOPAWE, INC., GRANVILLE, OH:
1,948,986, CANC. INT. CL. 1.

ECOSCAPE SOLUTIONS GROUP, INC., HUNTERSVILLE,
NC:
3,176,381, PUB. 9-12-2006. INT. CL. 44.

ECOVAC SERVICES, WOODSTOCK, GA:
3,178,303, INT. CL. 37.

ECP CORPORATION, AVON, OH:
2,308,405, CANC. INT. CL. 9.

ED & F MAN HOLDINGS LIMITED, LONDON, UNITED
KINGDOM:
3,176,201, PUB. 9-12-2006. INT. CL. 36.

EDAN PRODUCTS, INC., LOS ANGELES, CA:
1,948,391, CANC. INT. CL. 25.

EDINBURGH WOOLLEN MILL LTD., THE, DUMFRIES-
SHIRE, SCOTLAND:
1,378,152, CANC. INT. CL. 25.

EDME LIMITED, ESSEX, ENGLAND, ENGLISH DIASTASIC
MALT EXTRACT COMPANY, THE, MISTLEY, ESSEX,
ENGLAND:
28,711, REN. 10-26-06. U.S. CL. 18 (INT. CL. 5).

EDUCATIONAL CREDIT MANAGEMENT CORPORATION,
ST. PAUL, MN:
3,178,073, INT. CL. 36.

EDWARD M. LIVINGSTON, P.A., NAPLES, FL:
3,176,885, PUB. 9-12-2006. INT. CL. 42.

EDWARDS INVESTMENTS LTD., LETHBRIDGE, ALBER-
TA, CANADA:
1,947,881, CANC. INT. CL. 7.

EARMONY.COM, INC., PASADENA, CA:
3,175,967, PUB. 9-12-2006. INT. CL. 45.

EIGHTH FLOOR PROMOTIONS, LLC, CELINA, OH:
3,175,908, PUB. 9-12-2006. INT. CL. 35.

EISENBERG, RONALD P., WOODCLIFF LAKE, NJ:
2,309,933, CANC. INT. CL. 35.

EITELJORG MUSEUM OF AMERICAN INDIANS AND
WESTERN ART, INC., INDIANAPOLIS, IN:
3,178,336, MULTIPLE CLASS, INT. CLS. 35, 36 AND 41.

EK SUCCESS, LTD., CLIFTON, NJ:
3,178,256, INT. CL. 16.
3,178,353, INT. CL. 16.

EKAF INDUSTRIA NAZIONALE DEL CAFFÈ SPA, ITALY:
3,177,190, PUB. 9-12-2006. INT. CL. 30.

EL DORADO HOSPITAL, TUCSON, AZ:
3,176,257, PUB. 9-12-2006. INT. CL. 44.

ELA MEDICAL, 92120 MONTROUGE, FRANCE:
2,308,186, CANC. INT. CL. 10.

ELBEE PTY LTD, SYDNEY, AUSTRALIA:
3,176,204, PUB. 9-12-2006. MULTIPLE CLASS, INT. CLS. 9
AND 20.

ELDERTREE, LLC, STERLING, VA:
3,176,591, PUB. 9-12-2006. INT. CL. 43.

ELECTRONIC CONCEPT, INC., THE, MIAMI, FL:
1,378,593, CANC. INT. CL. 42.

ELECTRONIC MUSIC FOUNDATION, LTD., ALBANY, NY:
3,177,112, PUB. 9-12-2006. INT. CL. 41.

ELGIN RIVERBOAT RESORT, CHICAGO, IL:
1,948,232, CANC. INT. CL. 25.

ELI RESEARCH, INC., DURHAM, NC:
1,402,123, REN. 10-22-06. INT. CL. 16.

ELIBI INC., NEW YORK, NY:
3,175,957, PUB. 9-12-2006. MULTIPLE CLASS, INT. CLS.
18 AND 35.

ELITE FENCE PRODUCTS, INC., HARRISON TOWNSHIP,
MI, GIBRALTAR NATIONAL CORPORATION, DETROIT,
MI:
1,994,053, REN. 10-24-06. INT. CL. 19.

ELITE GROUP, INC., HOUSTON, TX:
3,176,028, PUB. 10-25-2005. MULTIPLE CLASS, INT. CLS.
35 AND 39.

ELLIOTT CHEMICALS LIMITED, PUKEKOHE, AUCK-
LAND, NEW ZEALAND:
3,176,026, PUB. 9-12-2006. INT. CL. 1.

ELLIOTT, STEPHEN B., ALLEN, TX:
3,176,665, PUB. 9-12-2006. INT. CL. 41.

EMC CORPORATION, MOUNTAIN VIEW, CA:
2,309,236, CANC. INT. CL. 9.

EMECO INDUSTRIES, INC., HANOVER, PA:
3,178,686, INT. CL. 20.

EMEH, INC., LEBANON, NJ:
3,175,958, PUB. 9-12-2006. MULTIPLE CLASS, INT. CLS.
6, 11, 17, 19, 20, 22, 27 AND 35.

EMERALD WAVE MEDIA, SANTA MARIA, CA:
3,175,889, PUB. 9-12-2006. INT. CL. 16.

EMERGENCY DENTAL CARE, LLC, OREM, UT:
3,176,766, PUB. 9-12-2006. INT. CL. 44.

EMERGENCY ID SYSTEMS, LLC, POWELL, OH:
3,178,402, INT. CL. 10.

EMERGENCY MEDICAL ASSOCIATES OF NEW JERSEY,
LIVINGSTON, NJ:
3,176,919, PUB. 9-12-2006. INT. CL. 44.

EMERSON RADIO CORP., PARSIPPANY, NJ:
3,177,888, INT. CL. 9.

EMG, INC., SANTA ROSA, CA:
1,408,411, REN. 10-26-06. INT. CL. 15.

EMI (IP) LIMITED, LONDON W8 5SW, UNITED KINGDOM:
1,901,544, REN. 10-26-06. INT. CL. 9.
1,992,401, REN. 10-21-06. INT. CL. 9.

EMI GROUP CANADA INC., MISSISSAUGA, ONTARIO,
CANADA, TA EMI MUSIC CANADA:
2,308,452, CANC. MULTIPLE CLASS, INT. CLS. 9 AND
41.
2,308,453, CANC. MULTIPLE CLASS, INT. CLS. 9 AND
41.

EMMIS RADIO, LLC, INDIANAPOLIS, IN:
3,178,337, INT. CL. 41.

EMPIRE WINERIES, LLC, NEW PORT RICHEY, FL:
3,176,460, PUB. 9-12-2006. INT. CL. 33.

- EMPIRICAL LABORATORIES, LLC, DAYTONA BEACH, FL:
3,178,417, INT. CL. 42.
- EMPLOYER OF CHOICE, INC., GREENSBORO, NC:
3,175,954, PUB. 9-12-2006. U.S. CL. B.
- EMPRESA EXPORTADORA E IMPORTADORA DE PRODUCTOS MEDICOS, HABANA VIEJA, CUBA, TA MEDICUBA:
1,414,696, REN. 10-23-06. INT. CL. 5.
- EMPRESA NACIONAL DE INFORMATICA AUTOMATIZACION Y CONTROL, C.A. - ENIAC, C.A., CARACAS, VENEZUELA:
3,178,295, INT. CL. 42.
- EMSIBETH S.P.A., ITALY:
3,177,309, PUB. 9-12-2006. INT. CL. 3.
- ENCAD, INC., SAN DIEGO, CA:
2,308,485, CANC. INT. CL. 9.
- ENDOR HANDELS GMBH, 85716 UNTERSCHLEISSHEIM, FED REP GERMANY:
2,308,566, CANC. MULTIPLE CLASS, INT. CLS. 9, 28, 41 AND 42.
- ENDSTAR, INC., NEW YORK, NY:
3,177,015, PUB. 9-12-2006. INT. CL. 20.
3,177,017, PUB. 9-12-2006. INT. CL. 20.
- ENERGY INDUSTRIES, HONOLULU, HI:
3,178,190, INT. CL. 35.
- ENERGY SYSTEMS & SERVICE CORP., PEEKSKILL, NY:
1,377,946, CANC. INT. CL. 9.
- ENET HOLDING, INC., PRINCETON, NJ:
2,308,425, CANC. MULTIPLE CLASS, INT. CLS. 16, 35 AND 38.
- ENGEL BROTHERS MEDIA, INC., NEW YORK, NY:
2,310,049, CANC. INT. CL. 9.
- ENGINEERED CONTROLS INTERNATIONAL, INC., ELON COLLEGE, NC, REGO DIV. OF GOLCONDA CORPORATION, INC., CHICAGO, IL:
1,031,202, REN. 10-25-06. INT. CL. 6.
- ENGLAND, KAREN ANN, PENSACOLA BEACH, FL AND ENGLAND, ROBERT L., PENSACOLA BEACH, FL:
3,177,550, INT. CL. 25.
- ENHANCED COMMUNICATIONS, INC., MOUNTAINSIDE, NJ:
1,378,502, CANC. INT. CL. 41.
- ENHANCED COMMUNICATIONS, INC., MURRAY HILL, NJ:
1,378,503, CANC. INT. CL. 41.
- ENIGMATEC CORPORATION LIMITED, LONDON, UNITED KINGDOM:
3,176,045, PUB. 5-30-2006. MULTIPLE CLASS, INT. CLS. 9, 38 AND 42.
- ENOFORUM - COMÉRCIO E EXPORTAÇÃO DE VINHOS, S.A., PORTUGAL:
3,177,224, PUB. 9-12-2006. INT. CL. 33.
- ENTERPRISE WEB SOLUTIONS, INC., BOCA RATON, FL:
3,176,038, PUB. 9-12-2006. INT. CL. 42.
- ENTERTAINMENT CONTENT, INC., LOS ANGELES, CA:
3,176,208, PUB. 9-12-2006. INT. CL. 41.
- ENTERTAINMENT PROPERTIES, LLC, NEW YORK, NY:
3,176,786, PUB. 9-12-2006. INT. CL. 41.
3,176,787, PUB. 9-12-2006. INT. CL. 41.
3,176,788, PUB. 9-12-2006. INT. CL. 41.
3,176,789, PUB. 9-12-2006. INT. CL. 41.
3,176,790, PUB. 9-12-2006. INT. CL. 41.
- ENTERTAINMENT PUBLICATIONS, INC., TROY, MI:
3,178,762, MULTIPLE CLASS, INT. CLS. 16 AND 35.
- ENTERTAINMENT WEEKLY INC., NEW YORK, NY:
2,001,003, REN. 10-25-06. INT. CL. 41.
- ENVIRONMENTAL INFORMATION SYSTEMS, CORP., LAS VEGAS, NV:
2,308,494, CANC. INT. CL. 9.
2,308,498, CANC. INT. CL. 9.
- ENVIROTEK CORPORATION, SANTA ANA, CA:
3,176,105, PUB. 9-12-2006. INT. CL. 3.
- ENVOY GLOBAL, INC., NEW YORK, NY:
3,176,854, PUB. 9-12-2006. INT. CL. 44.
- EON RECORDS, PORTLAND, OR:
2,308,858, CANC. INT. CL. 9.
- EPCOS AG, FED REP GERMANY:
3,177,256, PUB. 9-12-2006. INT. CL. 9.
- EPIEN MEDICAL, INC., MINNETONKA, MN:
2,006,278, REN. 10-26-06. INT. CL. 5.
- EPIMED INTERNATIONAL, JOHNSTOWN, NY:
3,177,671, INT. CL. 10.
- EPROJECT, INC., SEATTLE, WA:
3,176,095, PUB. 9-12-2006. INT. CL. 42.
- EPSTEIN BECKER & GREEN, P.C., NEW YORK, NY:
2,309,152, CANC. MULTIPLE CLASS, INT. CLS. 35 AND 42.
- EQUIFAX INC., ATLANTA, GA, EQUIFAX INC., ATLANTA, GA:
1,045,574, REN. 10-20-06. INT. CL. 35.
- EQUITYTHINK, LLC, FOUNTAIN HILLS, AZ:
3,176,769, PUB. 9-12-2006. MULTIPLE CLASS, INT. CLS. 35 AND 43.
- ER MARKS, INC., WEST CHESTER, PA:
3,177,645, INT. CL. 14.
- ERBAY MAGAZACILIK VE TICARET ANONIM SIRKETI, TURKEY:
3,177,263, PUB. 9-12-2006. MULTIPLE CLASS, INT. CLS. 18 AND 25.
- ERNST & YOUNG ELECTRONIC PUBLISHING SERVICES INC., TORONTO, ONTARIO, CANADA:
3,175,769, PUB. 1-17-2006. MULTIPLE CLASS, INT. CLS. 35, 36 AND 42.
- ERNST MARKS GMBH & CO. KG, 45442 MÜLHEIM AN DER RUHR, FED REP GERMANY:
2,907,610, COR. INT. CL. 16.
- ERO, INC., RIVIERA BEACH, FL:
2,023,482, REN. 10-26-06. INT. CL. 9.
- ERVIN, NORMAN DAYLE J.R., SAN CLEMENTE, CA:
3,175,968, PUB. 9-12-2006. INT. CL. 28.
- ESCORT INC., WEST CHESTER, OH:
3,178,684, INT. CL. 9.
- ESPERANZA CAPITAL PARTNERS LLC, CARBONDALE, CO:
3,176,206, PUB. 9-12-2006. MULTIPLE CLASS, INT. CLS. 35 AND 36.
3,176,209, PUB. 9-12-2006. MULTIPLE CLASS, INT. CLS. 35 AND 36.
- ESPINOZA, DAVID C., CHANDLER, AZ:
3,176,216, PUB. 9-12-2006. INT. CL. 43.
- ESRUBAR, L.P., SAN ANTONIO, TX:
3,177,738, INT. CL. 5.
- ESSENTIAL MEDICAL SUPPLY, INC., WINTER PARK, FL:
2,874,628, CANC. INT. CL. 35.
- ESSENTIAL NUTRACEUTICALS, LLC, BIRMINGHAM, AL:
3,178,796, INT. CL. 5.
- ESSENTIAL PRODUCTS, INC., LAS VEGAS, NV:
3,178,816, INT. CL. 2.
- ESSEX ENTERTAINMENT, INC., ENGLEWOOD CLIFFS, NJ TO BMG MUSIC, NEW YORK, NY:
1,947,891, CANC. INT. CL. 9.
- ESSILOR INTERNATIONAL (COMPAGNIE GENERALE D'OPTIQUE), FRANCE:
3,177,248, PUB. 9-12-2006. INT. CL. 9.
3,177,306, PUB. 9-12-2006. INT. CL. 9.
- ESTELLE COSMETICS, INC., SCOTTSDALE, AZ:
1,948,408, CANC. INT. CL. 3.
- ESTEVE, ANTONIO, TARRYTOWN, NY:
3,003,993, CANC. INT. CL. 41.
- ETCO ENTERPRISES, L.L.C., GIRARD, KS:
1,380,456, REN. 10-23-06. INT. CL. 20.
- ETS PERSYN- RIMA SARL, FRANCE:
3,177,216, PUB. 9-12-2006. INT. CL. 1.
- EUROBEST FOOD INDUSTRIES, INC., TUALATIN, OR:
1,417,591, REN. 10-22-06. MULTIPLE CLASS, INT. CLS. 29 AND 30.
- EURONEXT PARIS SA, PARIS, FRANCE:
1,948,649, CANC. MULTIPLE CLASS, INT. CLS. 16, 35 AND 36.
- EUROPEAN BEVERAGE COMPANY, INC., CHATSWORTH, CA TO DIDELOW, PATRICIA, CHATSWORTH, CA:
1,948,696, CANC. INT. CL. 33.

EUROPEAN TOUCH HOLDINGS, INC., MILWAUKEE, WI:
3,176,442, PUB. 9-12-2006. INT. CL. 11.
3,178,677, INT. CL. 11.

EVE LOM COMPLEXIONS CO LTD, UNITED KINGDOM:
3,177,258, PUB. 9-12-2006. INT. CL. 3.

EVENFLO COMPANY, INC., VANDALIA, OH:
3,177,740, INT. CL. 21.

EVENT ENGINEERING INC, CHICAGO, IL:
3,175,947, PUB. 9-12-2006. INT. CL. 35.

EVERBRIGHT DIAMOND COMPANY, LEXINGTON, NC:
1,378,036, CANC. INT. CL. 14.

EVERDRIVE, INC., MIDLOTHIAN, VA:
3,177,665, INT. CL. 35.

EVEREADY BATTERY COMPANY, INC., ST. LOUIS, MO:
3,176,936, PUB. 9-12-2006. INT. CL. 9.

EVEREST EQUIPMENT INC., HALIFAX, NOVA SCOTIA,
CANADA:
3,177,715, MULTIPLE CLASS, INT. CLS. 7 AND 37.

EVERGREEN INTERNATIONAL GROUP, LLC, LOS AN-
GELES, CA:
3,178,025, INT. CL. 25.

EVERGREEN MARKETING GROUP, INC., EVERGREEN,
CO:
3,176,121, PUB. 9-12-2006. INT. CL. 35.

EVERMAY SOCIETY, WASHINGTON, DC:
3,175,899, PUB. 9-12-2006. INT. CL. 41.

EVERSAFE CORPORATION, MARIETTA, OH:
3,075,179, COR. INT. CL. 6.

EVERYONE'S A CHEF, INC., CEDAR FALLS, IA:
3,178,223, INT. CL. 43.

EVO, INC., YOUNTVILLE, CA:
3,177,546, INT. CL. 33.

EVRAIFF, GLORIA M, POLLOCK PINES, CA AND EV-
RAIFF, DAVID, POLLOCK PINES, CA:
3,177,105, PUB. 9-12-2006. INT. CL. 36.

EWOK EXCHANGE, INC., SAN FRANCISCO, CA:
3,176,530, PUB. 9-12-2006. MULTIPLE CLASS, INT. CLS.
35 AND 36.

EXAMINETICS, INC., OVERLAND PARK, KS:
3,176,510, PUB. 9-12-2006. INT. CL. 44.

EXCELLON AUTOMATION COMPANY, TORRANCE, CA:
2,309,751, CANC. INT. CL. 7.

EXCELTA CORPORATION, BUELLTON, CA:
2,004,525, REN. 10-21-06. INT. CL. 8.

EXCITE USA, LP, CARROLTON, TX:
1,984,140, REN. 10-26-06. INT. CL. 28.

EXECUTIVE AIR SUPPORT, INC., PLANO, TX:
3,176,047, PUB. 9-12-2006. MULTIPLE CLASS, INT. CLS.
37 AND 39.

EXI CORP., ROSEVILLE, MN:
2,308,633, CANC. INT. CL. 42.

EXOMOS FZCO, DUBAI, UNITED ARAB EMIR.:
3,176,493, PUB. 9-12-2006. INT. CL. 12.

EXPANSION JOINT SYSTEMS, INC., SANTEE, CA:
3,176,560, PUB. 9-12-2006. INT. CL. 6.

EXPERIENCE HENDRIX, L.L.C., TUKWILA, WA:
2,498,597, CANC. INT. CL. 9.

EXPRESS PLUMBERS, VICTORIA, MN:
3,176,875, PUB. 9-12-2006. INT. CL. 37.

EXPRESS SCRIPTS, INC., MARYLAND HEIGHTS, MO:
3,176,944, PUB. 9-12-2006. INT. CL. 44.

EXXON MOBIL CORPORATION, IRVING, TX:
1,418,740, REN. 10-25-06. INT. CL. 42.

EXXON MOBIL CORPORATION, IRVING, TX, EXXON
CORPORATION, IRVING, TX:
1,977,748, REN. 10-25-06. MULTIPLE CLASS, INT. CLS.
37 AND 42.

EXXONMOBIL OIL CORPORATION, IRVING, TX:
1,048,286, REN. 10-20-06. INT. CL. 36.
1,052,601, REN. 10-23-06. INT. CL. 36.

EZ CLONE ENTERPRISES INC., ROCKLIN, CA:
3,176,632, PUB. 9-12-2006. INT. CL. 21.

E2INTERACTIVE, INC. D/B/A E2INTERACTIVE, INC.,
ATLANTA, GA:
2,308,161, CANC. MULTIPLE CLASS, INT. CLS. 16, 36
AND 38.
2,310,078, CANC. MULTIPLE CLASS, INT. CLS. 16 AND
36.

F & F FOODS, INC., CHICAGO, IL, F & F FOODS, INC.,
CHICAGO, IL:
1,950,350, REN. 10-26-06. INT. CL. 6.

F.F.F. ENTERPRISES, INC., TEMECULA, CA:
1,996,657, REN. 10-26-06. INT. CL. 35.

F.N.B. CORPORATION, HERMITAGE, PA:
2,308,321, CANC. INT. CL. 36.

FABRIC EDITIONS LLC, GREENVILLE, SC, FORMERLY
FE ACQUISITION LLC:
3,177,804, INT. CL. 28.

FABRIC TENT, MIAMI, FL:
3,178,106, INT. CL. 24.

FABRICAS EUROPEAS DE RODAMIENTOS S.A., ZARA-
GOZA, SPAIN:
3,176,218, PUB. 9-12-2006. INT. CL. 7.

FACES ENTERPRISES TOWSON LTD., TOWSON, MD,
FACES LIMITED, PIKESVILLE, MD:
1,054,182, REN. 10-20-06. MULTIPLE CLASS, INT. CLS. 3
AND 16.

FAIR HILL PRECISION, LLC, HARRISONBURG, VA:
3,178,194, INT. CL. 8.

FAIR MARKET, INC., WENTZVILLE, MO:
3,178,610, INT. CL. 35.

FAIR VIEW PACKING COMPANY, INC., HOLLISTER, CA
TO TRI-VALLEY GROWERS, SAN FRANCISCO, CA:
802,463, CANC. U.S. CL. 46.

FAIRCALL CORPORATION, DELRAY BEACH, FL:
2,308,597, CANC. INT. CL. 38.

FAIRHAVEN GROUP, INC., THE, BELLINGHAM, WA:
2,017,080, REN. 10-20-06. MULTIPLE CLASS, INT. CLS. 9
AND 18.

FAIRMONT ORTHOPEDICS & SPORTS MEDICINE, P.A.,
FAIRMONT, MN, DBA CENTER FOR SPECIALTY CARE:
3,176,572, PUB. 9-12-2006. INT. CL. 44.

FAIRWAY LAWNS, INC., LITTLE ROCK, AR:
3,178,543, INT. CL. 1.

FAMIGLIA-DEBARTOLO, LLC, WHITE PLAINS, NY:
3,177,480, INT. CL. 30.

FANIMATION, INC., ZIONSVILLE, IN:
3,177,485, INT. CL. 11.
3,177,486, INT. CL. 11.
3,177,487, INT. CL. 11.

FANY AMERICA, INC., MIAMI, FL:
2,308,530, CANC. MULTIPLE CLASS, INT. CLS. 9 AND
35.

FARADAY TECHNOLOGY, INC., CLAYTON, OH:
3,178,757, INT. CL. 7.

FARBWARE LICENSING COMPANY LLC, NEEDHAM,
MA, KIDDE CONSUMER DURABLES CORP., BALA
CYNWYD, PA:
1,410,374, REN. 10-25-06. MULTIPLE CLASS, INT. CLS.
11 AND 21.

FARNAM COMPANIES, INC., PHOENIX, AZ:
3,178,003, MULTIPLE CLASS, INT. CLS. 5 AND 31.

FARR FINANCIAL INC., SAN JOSE, CA:
3,176,178, PUB. 9-12-2006. INT. CL. 36.

FARWELL, LAWRENCE ASHLEY, FAIRFIELD, IA:
2,308,729, CANC. INT. CL. 42.

FASHION SPIRITS, LLP, LONDON, UNITED KINGDOM:
3,178,432, INT. CL. 33.

FASTWEL INC, BROOKLYN, NY:
3,176,494, PUB. 9-12-2006. INT. CL. 9.

FATA HUNTER, INC., RIVERSIDE, CA:
2,184,680, COR. INT. CL. 7.
2,406,559, COR. INT. CL. 9.

FAYTECH, LTD., LOWELL, MI:
2,309,722, CANC. INT. CL. 28.

FC INDUSTRIES, LLC, SMYRNA, GA:
3,176,124, PUB. 9-12-2006. INT. CL. 11.

FEARLESS ENTERTAINMENT, INC., NEW YORK, NY:
3,177,144, PUB. 9-12-2006. INT. CL. 41.

FEDERAL CARTRIDGE COMPANY, ANOKA, MN:
3,178,657, INT. CL. 25.

FEDERAL RESERVE BANK OF KANSAS CITY, KANSAS
CITY, MO:
3,176,626, PUB. 9-12-2006. INT. CL. 36.

FEDERICO MONTI, ITALY:
3,177,274, PUB. 9-12-2006. INT. CL. 25.

- FEDRA DESIGNS, INC., PROVIDENCE, RI:
1,378,038, CANC. INT. CL. 14.
- FEDRA DESIGNS, LTD., PROVIDENCE, RI:
1,378,037, CANC. INT. CL. 14.
- FEMME ARSENAL THC LLC, SOUTH RIVER, NJ:
2,309,121, CANC. INT. CL. 3.
- FENG, HAN, NEW YORK, NY:
1,941,144, REN. 10-23-06. MULTIPLE CLASS, INT. CLS. 14 AND 25.
1,941,144, CANC. MULTIPLE CLASS, INT. CLS. 21 AND 24.
- FENWAY MOTOR HOTEL, INC., BOSTON, MA:
2,308,752, CANC. INT. CL. 42.
- FERD. SCHMETZ GMBH, 5120 HERZOGENRATH, FED REP GERMANY, FIRMA FERDINAND BERNARD SCHMETZ, HERZOGENRATH, FED REP GERMANY:
812,961, REN. 10-24-06. U.S. CL. 23 (INT. CL. 7).
- FERGUSON ENTERPRISES, INC., NEWPORT NEWS, VA, FERGUSON ENTERPRISES, INC., NEWPORT NEWS, VA:
2,004,909, REN. 10-23-06. INT. CL. 42.
2,051,017, REN. 10-23-06. INT. CL. 42.
- FERNANDES, ANDRE LUIZ MACHADO, LAKE FOREST, CA:
3,176,985, PUB. 9-12-2006. INT. CL. 41.
- FERRARI S.P.A., 41100 MODENA, ITALY:
3,177,694, MULTIPLE CLASS, INT. CLS. 12 AND 28.
- FERRATE TREATMENT TECHNOLOGIES, LLC, ORLANDO, FL:
3,176,263, PUB. 9-12-2006. MULTIPLE CLASS, INT. CLS. 7, 11 AND 37.
- FERROXDURE S.A., EVREUX CEDEX, FRANCE:
3,176,404, PUB. 9-12-2006. INT. CL. 9.
- FESTINA, S.A., 08015 BARCELONA, SPAIN:
2,309,031, CANC. INT. CL. 14.
- FETCO INTERNATIONAL, INC., RANDOLPH, MA:
2,308,236, CANC. INT. CL. 20.
- FFTOOLBOX.COM LLC, FAIRFAX, VA:
3,178,538, INT. CL. 41.
- FI ENTERPRISES LLC, SNYDER, TX:
3,176,617, PUB. 9-12-2006. INT. CL. 30.
- FI-FABRY INDUSTRIES, INC., GREEN BAY, WI:
3,175,972, PUB. 9-12-2006. INT. CL. 25.
- FIBER NETWORK SOLUTIONS INC., COLUMBUS, OH:
2,308,627, CANC. INT. CL. 38.
- FIBERLIGHT, LLC, ALPHARETTA, GA:
3,176,303, PUB. 9-12-2006. INT. CL. 38.
- FIBEST, LTD., HACHIOJI CITY, TOKYO 192-0046, JAPAN:
3,177,436, INT. CL. 9.
- FIBRE-CRAFT MATERIALS CORPORATION, NILES, IL:
3,178,318, INT. CL. 16.
- FILENE RESEARCH INSTITUTE, INC., MADISON, WI:
3,176,228, PUB. 9-12-2006. INT. CL. 35.
- FINANCE MARYLAND, LLC, BALTIMORE, MD:
3,178,772, INT. CL. 36.
- FINANCIAL SOLUTIONS PARTNERS, LLC, NEW YORK, NY:
3,177,891, INT. CL. 36.
- FINANCIERE CONTRAST S.A.S., ROQUEFORT LES PINS, FRANCE:
3,176,771, PUB. 9-12-2006. MULTIPLE CLASS, INT. CLS. 3, 9 AND 14.
- FINE IMPRESSIONS, INC., DOTHAN, AL:
2,308,841, CANC. INT. CL. 20.
- FINE JEWELLERY (INDIA) LTD., SEEPZ-SEZ, ANDHERI (EAST) MUMBAI, INDIA:
1,991,674, REN. 10-24-06. INT. CL. 14.
- FINLEY PRODUCTS INC., LANCASTER, PA:
3,177,351, INT. CL. 35.
- FINLEY, SANDRA, FLOSSMOOR, IL:
2,308,579, CANC. INT. CL. 41.
- FINOVA CAPITAL CORPORATION, SCOTTSDALE, AZ TO FINOVA CAPITAL CORPORATION, SCOTTSDALE, AZ:
1,948,412, CANC. INT. CL. 36.
- FIORE, ANTHONY R., LONG VALLEY, NJ:
3,177,909, INT. CL. 25.
- FIRE MOUNTAIN CORPORATION, YERMO, CA:
2,308,226, CANC. INT. CL. 35.
- FIREBRAND MEDIA, INC., LONDON, KY:
3,178,800, MULTIPLE CLASS, INT. CLS. 9 AND 16.
- FIREFISH DESIGNS, LTD, NEW ALBANY, OH:
3,176,860, PUB. 9-12-2006. INT. CL. 18.
- FIRMENICH SA, GENEVE, SWITZERLAND:
1,377,758, CANC. INT. CL. 1.
- FIRMENICH SA, SWITZERLAND:
3,177,217, PUB. 9-12-2006. MULTIPLE CLASS, INT. CLS. 1 AND 30.
- FIRST AID ONLY, INC., VANCOUVER, WA:
3,177,591, MULTIPLE CLASS, INT. CLS. 5 AND 10.
- FIRST AMERICAN COMMERCIAL BANCORP, INC., CHICAGO, IL:
3,178,309, INT. CL. 36.
- FIRST AMERICAN NATIONAL BANK, NASHVILLE, TN:
2,310,005, CANC. INT. CL. 36.
- FIRST BAPTIST CHURCH, ROANOKE, VA:
1,948,317, CANC. INT. CL. 41.
- FIRST CHICAGO NBD INVESTMENT SERVICES, INC., CHICAGO, IL:
1,948,898, CANC. INT. CL. 36.
- FIRST CHOICE EDUCATION GROUP, LLC, WALTHAM, MA:
3,178,588, INT. CL. 16.
- FIRST COMMUNITY BANK OF EAST TENNESSEE, ROGERSVILLE, TN:
3,178,397, INT. CL. 36.
- FIRST FINANCIAL MANAGEMENT CORPORATION, ATLANTA, GA:
2,309,805, CANC. INT. CL. 38.
- FIRST HAWAIIAN BANK, HONOLULU, HI:
1,984,791, REN. 10-23-06. INT. CL. 36.
- FIRST JULIAN CORPORATION, BROOKLINE, MA TO BUCA, INC., MINNEAPOLIS, MN:
1,949,620, CANC. INT. CL. 42.
- FIRST JULIAN CORPORATION, NEEDHAM, MA:
1,949,621, CANC. INT. CL. 42.
- FIRST MISSISSIPPI CORPORATION, JACKSON, MS:
1,378,529, CANC. INT. CL. 42.
- FIRST NATIONAL BANK OF OMAHA, OMAHA, NE:
1,992,098, REN. 10-23-06. INT. CL. 36.
- FIRST TRUST PORTFOLIOS L.P., LISLE, IL:
1,992,110, REN. 10-23-06. INT. CL. 36.
- FIRST UNION CORPORATION, CHARLOTTE, NC:
2,309,640, CANC. INT. CL. 41.
- FIRST YEARS INC., THE, STOUGHTON, MA:
3,177,369, INT. CL. 8.
- FIRST 5 CONTRA COSTA CHILDREN AND FAMILIES COMMISSION, MARTINEZ, CA:
3,177,522, INT. CL. 41.
- FIRSTPLUS FINANCIAL GROUP, INC., DALLAS, TX:
2,308,868, CANC. INT. CL. 34.
2,308,869, CANC. INT. CL. 20.
- FIRSTPRO, INC, ATLANTA, GA:
2,070,004, REN. 10-23-06. INT. CL. 35.
- FIRSTTRUST SAVINGS BANK, PHILADELPHIA, PA:
2,308,994, CANC. INT. CL. 36.
- FISCHER PHARMACEUTICALS LTD., TEL AVIV, ISRAEL:
3,177,552, INT. CL. 5.
3,177,553, INT. CL. 5.
- FISCHER PHARMACEUTICALS LTD., TEL-AVIV, ISRAEL:
3,178,577, INT. CL. 3.
- FISH WINDOW CLEANING SERVICES, INC., MANCHESTER, MO:
3,176,523, PUB. 9-12-2006. INT. CL. 3.
- FISHER, CASEY, LAYTON, UT:
3,177,555, INT. CL. 35.
- FISKARS BRANDS, INC., MADISON, WI:
3,178,050, INT. CL. 11.
- FITBUG, LTD., LONDON NW1 8LH, UNITED KINGDOM:
3,178,665, MULTIPLE CLASS, INT. CLS. 9, 41 AND 44.
- FITNESS LABS NUTRITION CORPORATION, TORRANCE, CA:
3,178,648, INT. CL. 5.
- FIVE STAR FULFILLMENT SERVICES, INC., LAYTON, UT:
2,310,022, CANC. INT. CL. 3.
2,310,023, CANC. INT. CL. 3.

FIVE STAR MANUFACTURING LLC, YOUNGSVILLE, NC;
ATHEY PRODUCTS CORPORATION, RALEIGH, NC:
2,017,251. REN. 10-25-06. INT. CL. 7.

FIVE STAR REAL ESTATE, LLC, GRAND RAPIDS, MI:
3,176,458, PUB. 9-12-2006. INT. CL. 36.

FLEMINGTON FUR COMPANY, LLC, FLEMINGTON, NJ:
3,178,252, INT. CL. 25.

FLEX-O-GLASS, INC., CHICAGO, IL, DOING BUSINESS AS
WARP BROTHERS:
631,657. REN. 10-24-06. U.S. CL. 20 (INT. CL. 27).

FLEXIBLE SOLUTIONS INTERNATIONAL INC., VICTORIA,
BC, CANADA:
3,177,769, INT. CL. 11.

FLICK, STEVE A., KINGSVILLE, MO:
3,177,974, INT. CL. 31.

FLIGHTSAFETY DEVELOPMENT CORP., LAS VEGAS, NV:
3,176,951, PUB. 9-12-2006. INT. CL. 41.

FLIRT INC., LOS ANGELES, CA:
3,119,250, CANC. IIRN. RESTORED TO S.N. 78-488,591.

FLO-OINCS, TARZANA, CA:
3,178,090, INT. CL. 9.

FLOMATIC CORPORATION, GLENS FALLS, NY:
1,948,885, CANC. INT. CL. 35.

FLOOD COMPANY, THE, HUDSON, OH:
1,070,053. REN. 10-26-06. INT. CL. 2.

FLORA MANUFACTURING & DISTRIBUTING LTD., BUR-
NABY, B.C. V5J 5B9, CANADA:
2,309,852, CANC. INT. CL. 5.

FLORAN TECHNOLOGIES, INC., OKLAHOMA CITY, OK:
3,178,040, INT. CL. 5.

FLORIDA FOOD & BEVERAGE CO., ORLANDO, FL:
2,309,853, CANC. INT. CL. 30.

FLOUROWARE, INC., CHASKA, MN:
1,948,639, CANC. INT. CL. 20.

FLOWERS, INC. BALLOONS, BOGART, GA:
2,308,925, CANC. INT. CL. 21.

FLOYD, JAMES CHRISTOPHER, DALLAS, TX:
3,177,573, INT. CL. 36.

FLUENT, RESEDA, CA:
3,176,880, PUB. 9-12-2006. INT. CL. 35.
3,176,881, PUB. 9-12-2006. INT. CL. 35.

FLUIDART TECHNOLOGY, LLC, OKLAHOMA CITY, OK:
3,178,244, INT. CL. 11.

FLUORRX, INC., CARMEL, IN:
2,309,583, CANC. MULTIPLE CLASS, INT. CLS. 1 AND 5.

FLYER, GARY, BRONX, NY AND FLYER, SUSAN, BRONX,
NY:
3,178,320, INT. CL. 20.

FMC CORPORATION, PHILADELPHIA, PA:
2,309,630, CANC. INT. CL. 7.

FMR CORP., BOSTON, MA:
3,178,589, INT. CL. 36.

FMS FUTURE MEDICAL SYSTEM, MEYRIN-GENEVA,
SWITZERLAND:
3,177,728, INT. CL. 10.

FOCUS MEDIA, INC., MARINA DEL REY, CA:
3,176,694, PUB. 9-12-2006. INT. CL. 41.

FOCUS ON THE FAMILY, COLORADO SPRINGS, CO:
2,013,159. REN. 10-25-06. INT. CL. 35.
3,177,160, PUB. 9-12-2006. INT. CL. 16.
3,177,648, INT. CL. 14.
3,178,086, INT. CL. 41.

FOCUS ST. LOUIS, ST. LOUIS, MO:
3,176,479, PUB. 9-12-2006. MULTIPLE CLASS, INT. CLS.
36 AND 41.

FOLLENFANT, PIERRE, LA ROCHELLE, FRANCE:
1,378,184, CANC. INT. CL. 25.

FONA INTERNATIONAL INC., GENEVA, IL:
3,176,383, PUB. 9-12-2006. MULTIPLE CLASS, INT. CLS.
16 AND 41.

FONEGEAR, LLC, TROY, MI:
3,178,553, INT. CL. 9.

FOOD INVESTMENTS LIMITED, LONDON, UNITED
KINGDOM:
3,177,911, INT. CL. 40.

FOOD SERVICES MANAGEMENT ASSOCIATES, PITTS-
BURGH, PA:
1,378,494, CANC. INT. CL. 41.
1,378,556, CANC. INT. CL. 42.

FORBES, DAVID C., AUSTIN, TX:
2,309,193, CANC. INT. CL. 10.

FORBO INTERNATIONAL S.A., 8193 EGLISAU, SWITZER-
LAND, REICHHOLD CHEMICALS, INC., DURHAM, NC:
1,994,029. REN. 10-26-06. INT. CL. 1.

FORD MOTOR COMPANY, DEARBORN, MI:
1,403,422. REN. 10-25-06. INT. CL. 36.
3,177,953, INT. CL. 35.

FOREVER OF PA, INC., ALTOONA, PA:
2,308,488, CANC. INT. CL. 41.

FORMAT DYNAMICS LLC, DENVER, CO:
3,176,020, PUB. 9-12-2006. INT. CL. 42.

FORSEON CORPORATION, RIVERSIDE, CA:
2,308,423, CANC. INT. CL. 9.

FORSYTHE COSMETIC GROUP, LTD.:
1,377,821, CANC. INT. CL. 3.

FORT JAMES OPERATING COMPANY, ATLANTA, GA,
FORT HOWARD PAPER COMPANY, GREEN BAY, WI:
631,340. REN. 10-25-06. U.S. CL. 37 (INT. CL. 16).

FORTRESS STAFFING GROUP, LLC, DENVER, CO:
3,176,236, PUB. 9-12-2006. INT. CL. 35.

FOSTER POULTRY FARMS, LIVINGSTON, CA, DBA FOS-
TER FARMS:
3,177,623, INT. CL. 29.

FOUR QUADRANTS, LLC, EDMOND, OK:
3,177,803, INT. CL. 35.

FOWNES BROTHERS & CO., INC., NEW YORK, NY:
1,994,215. REN. 10-25-06. INT. CL. 25.

FOWNES BROTHERS & CO., INCORPORATED, NEW
YORK, NY:
1,383,460. REN. 10-25-06. INT. CL. 25.
1,997,619. REN. 10-25-06. INT. CL. 25.

FOX'S PIZZA DEN, INC., PITTSBURGH, PA:
1,996,655. REN. 10-20-06. MULTIPLE CLASS, INT. CLS.
25, 29, 30 AND 42.

FPA MEDICAL MANAGEMENT, INC., SAN DIEGO, CA:
2,308,393, CANC. INT. CL. 35.

FPL ENERGY SERVICES, INC., JUNO BEACH, FL:
2,309,007, CANC. INT. CL. 39.

FRAKER ASSOCIATES LTD., CARMEL, IN:
2,309,869, CANC. INT. CL. 9.

FRAKES, R ERIC, VACAVILLE, CA:
3,177,601, INT. CL. 43.

FRANCHISE ADVANTAGE LLC, SOUTHURY, CT:
3,176,358, PUB. 9-12-2006. INT. CL. 41.

FRANCIS MARION UNIVERSITY, FLORENCE, SC:
2,081,257. REN. 10-20-06. INT. CL. 41.

FRANKLIN COVEY CO., SALT LAKE CITY, UT:
2,308,628, CANC. INT. CL. 41.

FRANKLIN GROUP, INC., THE, NASHVILLE, TN:
2,308,611, CANC. INT. CL. 41.

FRANKLIN RESOURCES, INC., SAN MATEO, CA:
1,949,615, CANC. INT. CL. 36.

FRED MEYER STORES, INC., PORTLAND, OR:
3,061,200, COR. INT. CL. 31.

FRED S. MEYER ASSOCIATES, INC., MINNEAPOLIS, MN,
DBA IDEAS TO GO, INC.:
1,378,681, CANC. INT. CL. 35.

FREDERICK GOLDMAN, INC, NEW YORK, NY, FRED
SELTZER CORPORATION, LINCOLNWOOD, IL:
818,647. REN. 10-26-06. U.S. CL. 28 (INT. CL. 14).

FREEDOM TEXTILE CHEMICALS CO., CHARLOTTE, NC
TO PMD HOLDINGS CORPORATION, CLEVELAND, OH:
1,949,414, CANC. INT. CL. 1.

FREEMAN MANUFACTURING & SUPPLY COMPANY,
THE, CLEVELAND, OH:
1,378,092, CANC. INT. CL. 17.

FREIBERGER, BENJIE, SIERRA MADRE, CA:
3,176,652, PUB. 9-12-2006. INT. CL. 9.

FREIGHTDATA 2000 LTD, BILLERICAY, ESSEX CM12 OBT,
UNITED KINGDOM:
3,177,320, PUB. 9-12-2006. INT. CL. 9.

FREMONT BANK, FREMONT, CA:
3,176,625, PUB. 9-12-2006. INT. CL. 36.

- FRESENER, SCOTT MICHAEL, MESA, AZ:
3,176,772, PUB. 9-12-2006. INT. CL. 38.
- FRESENIUS KABI AG, FED REP GERMANY:
3,177,322, PUB. 9-12-2006. INT. CL. 10.
- FRESENIUS MEDICAL CARE HOLDINGS, INC., LEXINGTON, MA:
3,178,519, INT. CL. 42.
- FRESH JIVE MANUFACTURING, INC., LOS ANGELES, CA:
3,178,324, INT. CL. 25.
- FRESHLINE MACHINES PTY LTD, AUSTRALIA:
3,177,245, PUB. 9-12-2006. INT. CL. 7.
- FRICKE, LAWRENCE R., JR., LISLE, IL:
3,176,608, PUB. 9-12-2006. INT. CL. 5.
- FRIEDMAN'S INC., SAVANNAH, GA TO FRIEDMAN'S MANAGEMENT CORP., SAVANNAH, GA:
1,947,932, CANC. INT. CL. 42.
- FRIENDLY SYSTEMS, INC., IRVING, TX:
1,948,902, CANC. INT. CL. 5.
- FRIES, ALEXANDER E., SARATOGA, CA AND HEIM, JIM, SARATOGA, CA:
3,178,736, INT. CL. 32.
- FRITZ STUDER AG, SWITZERLAND:
3,177,200, PUB. 9-12-2006. MULTIPLE CLASS, INT. CLS. 7, 8, 37 AND 42.
- FROG POND-KIDS, INC., THE, ATLANTA, GA:
1,378,141, CANC. MULTIPLE CLASS, INT. CLS. 24 AND 25.
1,378,142, CANC. MULTIPLE CLASS, INT. CLS. 24 AND 25.
- FROGTOWN CELLARS, LLLP, DAHLONEGA, GA:
3,176,002, PUB. 9-12-2006. INT. CL. 33.
- FROMAGERIES BEL-LA VACHE QUI RIT, PARIS, FRANCE:
1,378,297, CANC. INT. CL. 29.
- FRONTIER CORPORATION, ROCHESTER, NY:
2,309,861, CANC. INT. CL. 42.
2,309,862, CANC. INT. CL. 16.
- FROSTLINE U.S.A., INC., GRAND JUNCTION, CO:
1,378,145, CANC. INT. CL. 24.
1,378,195, CANC. INT. CL. 25.
- FRUIT OF THE EARTH, INC., IRVING, TX:
3,177,691, INT. CL. 3.
- FS CONCEPTS, INC., ANAHEIM, CA:
2,308,223, CANC. INT. CL. 41.
- FSI FONTS UND SOFTWARE GMBH, 10961 BERLIN, FED REP GERMANY:
2,309,174, CANC. INT. CL. 9.
- FU LYING HAO INDUSTRIAL CO., LTD., TAICHUNG HSIEN, TAIWAN:
2,308,502, CANC. INT. CL. 11.
- FUEL MANAGERS, INCORPORATED, TULSA, OK:
3,178,017, INT. CL. 35.
- FUJI PHOTO FILM U.S.A., INC., VALHALLA, NY:
3,177,748, INT. CL. 9.
3,177,749, INT. CL. 9.
- FUJIKIN OF AMERICA, INC., SANTA CLARA, CA:
1,996,504, REN. 10-26-06. INT. CL. 9.
- FUJINON CORPORATION, SAITAMA-KEN, JAPAN:
1,405,659, REN. 10-24-06. INT. CL. 10.
- FULL SERVICE COMPUTING CORPORATION, PITTSBURGH, PA:
1,948,099, CANC. INT. CL. 38.
- FULLER BROS. INC., CLACKAMAS, OR:
1,998,295, COR. INT. CL. 1.
- FULLER SMITH & TURNER PLC, CHISWICK, LONDON W4 2QB, ENGLAND:
2,308,158, CANC. INT. CL. 32.
- FUNDAMENTAL LABOR STRATEGIES, INC., NEW HOPE, PA:
3,177,079, PUB. 9-12-2006. INT. CL. 42.
3,177,136, PUB. 9-12-2006. MULTIPLE CLASS, INT. CLS. 16, 35, 41 AND 42.
- FUNDING EXCHANGE LLC, THE, CHICAGO, IL:
3,178,583, INT. CL. 36.
- FURNITURE ZONE, INC., GLENVIEW, IL:
2,309,708, CANC. INT. CL. 35.
- FUSAN MACHINERY CO., LTD., CHANG HUA HSIEN, TAIWAN:
3,176,483, PUB. 9-12-2006. INT. CL. 11.
- FUTURE PRODUCTS CORPORATION, GAINESVILLE, GA:
2,035,259, REN. 10-26-06. INT. CL. 25.
- FUTURE TECHNOLOGIES INC., BAY CITY, MI:
3,176,635, PUB. 9-12-2006. INT. CL. 9.
- FW DISPOSAL, L.L.C., MARYLAND HEIGHTS, MO:
3,177,040, PUB. 9-12-2006. INT. CL. 37.
- FWU KUANG ENTERPRISES CO., LTD., TAINAN HSIEN, TAIWAN:
3,177,750, INT. CL. 6.
- FX NETWORKS, LLC, LOS ANGELES, CA:
2,308,325, CANC. INT. CL. 41.
- G. H. MUMM & CIE, SOCIETE VINICOLE DE CHAMPAGNE SUCCESSEUR S.A., 51053 REIMS CEDEX, FRANCE:
2,309,939, CANC. INT. CL. 33.
2,309,940, CANC. INT. CL. 33.
- G.F. SRL, ITALY:
3,177,261, PUB. 9-12-2006. INT. CL. 10.
- G.H.C. GROUP, L.L.C., LAREDO, TX:
1,994,747, REN. 10-21-06. INT. CL. 5.
- G.T. MANAGEMENT LIMITED, LONDON, ENGLAND:
1,378,415, CANC. INT. CL. 36.
- GA MODEFINE S.A., MENDRISIO, SWITZERLAND:
3,178,006, INT. CL. 3.
- GADDIS, LEE, LAKE STEVENS, WA:
2,308,510, CANC. INT. CL. 14.
- GAGE APPLIED SCIENCES INC., LACHINE, QUEBEC, CANADA:
2,308,644, CANC. INT. CL. 9.
- GALE GROUP, INC., THE, FARMINGTON HILLS, MI:
1,378,609, CANC. INT. CL. 42.
- GALERIE LAKAYE, LOS ANGELES, CA:
2,309,663, CANC. INT. CL. 3.
- GALICKI & RISSIN, LLC, FORT LEE, NJ:
3,178,305, INT. CL. 14.
- GALLAGHER BENEFIT SERVICES, INC., ITASCA, IL:
3,176,391, PUB. 9-12-2006. INT. CL. 36.
- GALLARD SCHLESINGER INDUSTRIES, INC., GARDEN CITY, NY:
1,948,783, CANC. INT. CL. 35.
- GALLO, MARC, 80804 MUNCHEN, FED REP GERMANY:
3,175,778, PUB. 6-21-2005. MULTIPLE CLASS, INT. CLS. 25 AND 35.
- GALLUS FERD. RÜESCH AG, 9016 ST. GALLEN, SWITZERLAND:
817,721, REN. 10-24-06. U.S. CL. 23 (INT. CL. 7).
- GAMBLIN HOLDINGS, LLC, PORTLAND, OR:
1,441,681, REN. 10-26-06. INT. CL. 2.
- GAME ARTS CO., LTD, TOKYO, JAPAN:
3,176,489, PUB. 9-12-2006. INT. CL. 9.
- GAME FINANCIAL CORPORATION, ST. PETERSBURG, FL:
1,989,255, REN. 10-26-06. INT. CL. 36.
- GAMESTOP, INC., GRAPEVINE, TX, FUNCO, INC., MINNEAPOLIS, MN:
2,085,805, REN. 10-24-06. INT. CL. 35.
- GAMETEC INC., ALPHARETTA, GA TO INTERNATIONAL GAMCO, INC., OMAHA, NE:
1,949,126, CANC. INT. CL. 42.
- GAMING PARTNERS INTERNATIONAL CORPORATION, LAS VEGAS, NV:
3,176,646, PUB. 9-12-2006. INT. CL. 35.
- GARBINA, B-2018 ANTWERP, BELGIUM:
1,384,205, REN. 10-20-06. INT. CL. 14.
- GARDEN GOURMET FINE FOODS INC., RICHMOND, BRITISH COLUMBIA, CANADA:
2,308,135, CANC. MULTIPLE CLASS, INT. CLS. 29 AND 30.
- GARLOCK SEALING TECHNOLOGIES LLC, PARAGOULD, AR:
2,087,845, REN. 10-26-06. INT. CL. 17.
- GARMIN LTD., 103 SOUTH CHURCH STREET, GEORGE TOWN, CAYMAN ISLANDS:
3,178,008, INT. CL. 9.
- GARMON CORPORATION, TEMECULA, CA:
2,002,613, REN. 10-26-06. MULTIPLE CLASS, INT. CLS. 3

- AND 5.
- GARMON CORPORATION, THE, TEMECULA, CA,
GREENTREE LABORATORIES, INC., TUSTIN, CA:
1,951,506. REN. 10-26-06. INT. CL. 5.
- GARY ANDREW MYERS, CHANDLER, AZ:
3,176,021, PUB. 9-12-2006. INT. CL. 25.
- GATEWAY CHURCH., SOUTHLAKE, TX:
3,175,856, PUB. 9-12-2006. MULTIPLE CLASS, INT. CLS. 9
AND 16.
- GAUGHEN HOLDINGS LLC, OXNARD, CA:
3,178,642, INT. CL. 2.
- GAUTHIER, CAROLE, NEW YORK, NY:
3,178,794, MULTIPLE CLASS, INT. CLS. 41, 42 AND 44.
- GAYMAR INDUSTRIES, INC., ORCHARD PARK, NY:
2,012,483. REN. 10-20-06. INT. CL. 10.
- GE BETZ, INC., TREVISO, PA, W. R. GRACE & CO.-CONN.,
NEW YORK, NY:
2,027,796. REN. 10-25-06. INT. CL. 39.
- GE HEALTHCARE BIO-SCIENCES AB, UPPSALA, SWE-
DEN, PHARMACIA BIOTECH AB, UPPSALA, SWEDEN:
2,006,485. REN. 10-23-06. INT. CL. 1.
- GE OSMONICS, INC., MINNETONKA, MN:
2,309,134, CANC. INT. CL. 9.
- GEA LUFTKUEHLER HOLDING GMBH, FED REP GER-
MANY:
2,308,160, CANC. MULTIPLE CLASS, INT. CLS. 7 AND 9.
- GEA LYOPHIL GMBH, COLOGNE, FED REP GERMANY:
3,177,828, INT. CL. 7.
- GEAR HOLDINGS, INC., NEW YORK, NY:
2,309,084, CANC. INT. CL. 27.
2,309,085, CANC. INT. CL. 21.
- GECKO ELECTRONIQUE INC., QUEBEC CITY, PROVINCE
OF QUEBEC, CANADA:
2,309,181, CANC. INT. CL. 9.
- GEERLINGS & WADE, INC., CANTON, MA:
3,176,921, PUB. 9-12-2006. MULTIPLE CLASS, INT. CLS.
16 AND 35.
- GEIGER GMBH, 6134 VOMP, AUSTRIA, GEIGER & CO.,
SCHWAZ/VOMP (TIROL), AUSTRIA:
1,059,359. REN. 10-23-06. INT. CL. 25.
- GEMINI ELETTRONICA S.L.R., BODIO LOMNAGO (VAR-
ESE), ITALY:
1,377,923, CANC. MULTIPLE CLASS, INT. CLS. 9 AND
12.
- GEMINI FASHIONS OF CANADA LTD., WINNIPEG, MAN-
ITOBA, CANADA:
2,308,322, CANC. INT. CL. 25.
- GEMÜSESAFT GMBH, FED REP GERMANY:
3,177,287, PUB. 9-12-2006. MULTIPLE CLASS, INT. CLS.
5, 29, 30 AND 32.
- GEN-X SPORTS INC., TORONTO, ONTARIO, M6A 2W1,
CANADA:
2,650,907, CANC. MULTIPLE CLASS, INT. CLS. 25, 28
AND 35.
- GENCORP INC., FAIRLAWN, OH TO OMNOVA SERVICES,
INC., FAIRLAWN, OH:
1,949,716, CANC. INT. CL. 27.
- GENDERM CORPORATION, SCOTTSDALE, AZ:
1,377,858, CANC. INT. CL. 5.
- GENDEX CORPORATION, DES PLAINES, IL:
3,177,067, PUB. 9-12-2006. INT. CL. 10.
3,177,068, PUB. 9-12-2006. INT. CL. 10.
- GENERAL AMPLIFIER, INC., CARSON CITY, NV:
3,175,916, PUB. 9-12-2006. INT. CL. 9.
- GENERAL CABLE TECHNOLOGIES CORPORATION,
HIGHLAND HEIGHTS, KY, ANACONDA WIRE AND
CABLE COMPANY, NEW YORK, NY:
813,862. REN. 10-25-06. U.S. CL. 21 (INT. CL. 9).
- GENERAL CABLE TECHNOLOGIES CORPORATION,
HIGHLAND HEIGHTS, KY, GENERAL CABLE INDUS-
TRIES, INC., HIGHLAND HEIGHTS, KY:
2,084,626. REN. 10-25-06. INT. CL. 9.
- GENERAL ELECTRIC COMPANY, SCHENECTADY, NY:
818,025. REN. 10-25-06. U.S. CL. 21 (INT. CL. 9).
2,015,196. REN. 10-26-06. INT. CL. 11.
3,177,630, INT. CL. 1.
3,177,631, INT. CL. 7.
3,178,241, INT. CL. 9.
3,178,503, INT. CL. 35.
3,178,504, INT. CL. 6.
3,178,513, INT. CL. 6.
- GENERAL HOUSEWARES CORP., TERRE HAUTE, IN:
2,310,041, CANC. INT. CL. 8.
- GENERAL MOTIVATION COMPANY, INC., GRAND RA-
PIDS, MI:
3,175,917, PUB. 9-12-2006. INT. CL. 35.
- GENERAL MOTORS ACCEPTANCE CORPORATION, DE-
TROIT, MI:
3,175,979, PUB. 9-12-2006. INT. CL. 35.
- GENESEARSEARCH, INC., BOZEMAN, MT:
3,178,204, INT. CL. 9.
- GENESEE BIOMEDICAL, INC., DENVER, CO:
3,177,984, INT. CL. 10.
- GENESIS INTERNATIONAL MARKETING CORP, MIAMI,
FL, DESPREZ, JEAN, NEUILLY-SUR-SEINE, SEINE,
FRANCE:
811,481. REN. 10-26-06. U.S. CL. 51 (INT. CL. 3).
- GENETIC APPLICATIONS LLC, SAN DIEGO, CA:
3,177,852, INT. CL. 1.
- GENEXUS INTERNATIONAL, INC., INGLEWOOD, CA:
3,177,502, INT. CL. 25.
- GENIUS PRODUCTS, INC., SOLANA BEACH, CA:
3,175,824, PUB. 9-12-2006. MULTIPLE CLASS, INT. CLS.
9, 16, 25 AND 28.
3,175,825, PUB. 9-12-2006. MULTIPLE CLASS, INT. CLS.
9, 16, 25 AND 28.
- GENMAR IP LLC, MINNEAPOLIS, MN, STRATOS BOATS,
INC., OLD HICKORY, TN:
1,393,959. REN. 10-20-06. INT. CL. 12.
- GEORG FISCHER GIESSEREIANLAGEN AG, CH-8201
SCHAFFHAUSEN, SWITZERLAND:
1,948,437, CANC. INT. CL. 7.
- GEORGE E. FAILING COMPANY, THE, ENID, OK:
1,949,317, CANC. INT. CL. 7.
- GEORGIA ORIGINALS, INC., WATKINSVILLE, GA:
3,176,997, PUB. 9-12-2006. INT. CL. 35.
- GERARDO CESARI S.P.A. IN SHORT FORM "G.C. S.P.A."
OR "S.C. S.P.A.", QUINZANO D'OGGIO (BRESCIA),
ITALY, SALVALAI ALESSANDRO & C. S.P.A., BRESCIA,
ITALY:
1,993,890. REN. 10-23-06. INT. CL. 33.
- GERHARD KLEMM MASCHINENFABRIK, POSTFACH
170361, FED REP GERMANY TO KLEMM SIEBDRUCK-
MASCHINEN GMBH, BIELEFELD, FED REP GERMANY:
1,948,265, CANC. INT. CL. 7.
- GERONIMO PRODUCTIONS, INC., MIAMI, FL:
3,176,506, PUB. 9-12-2006. INT. CL. 8.
3,176,547, PUB. 9-12-2006. INT. CL. 28.
3,176,548, PUB. 9-12-2006. INT. CL. 13.
3,176,956, PUB. 9-12-2006. INT. CL. 27.
- GESTION PIERRE-DEUX INC., ST. EMILE, QUEBEC G3E
1N6, CANADA, CHAUSSURES HENRI-PIERRE INC., ST-
EMILE, QUEBEC, CANADA:
1,990,811. REN. 10-21-06. INT. CL. 25.
- GET THE DOOR, DARDENNE PRAIRIE, MO:
3,175,866, PUB. 9-12-2006. INT. CL. 37.
- GFI HOLDINGS, INC., OMAHA, NE:
1,995,265. REN. 10-20-06. INT. CL. 29.
- GHANI MOGHADAM, SAEED, THORNHILL, CANADA:
3,178,825, INT. CL. 41.
- GHETTO STREET FUNK MUSIC, INC., JONESBORO, GA:
2,309,773, CANC. INT. CL. 9.
- GHIASS, QUMARS, COSTA MESA, CA:
2,308,437, CANC. INT. CL. 4.
- GIBRALTER PUBLISHING, INC., JACKSONVILLE, NC:
2,310,101, CANC. INT. CL. 16.
- GIBSON GREETINGS, INC., CINCINNATI, OH:
2,309,755, CANC. INT. CL. 16.
- GIBSON GUITAR CORP., NASHVILLE, TN:
3,175,839, PUB. 9-12-2006. INT. CL. 15.

- GIFT CERTIFICATE CENTER, INC., MINNEAPOLIS, MN:
3,178,573, INT. CL. 35.
- GIFT FOR LIFE BLOCK WALK, HOUSTON, TX:
3,177,364, INT. CL. 35.
- GIFT PARTNERS, L.P.1, BAINBRIDGE ISLAND, WA:
2,309,595, CANC. INT. CL. 35.
- GIGA-BIKE INC., VICTORIA, BRITISH COLUMBIA, CANADA:
3,176,370, PUB. 9-12-2006. INT. CL. 9.
- GILLY PROMOTIONS OF FLORIDA, INC., NEW SMYRNA BEACH, FL:
2,047,006, REN. 10-24-06. INT. CL. 41.
- GILSTER-MARY LEE CORPORATION, CHESTER, IL, JASPER FOODS, INC., JASPER, MO:
2,059,780, REN. 10-24-06. INT. CL. 30.
- GILSTON, SAMUEL M., WASHINGTON, DC, DBA GILSTON COMMUNICATIONS GROUP:
1,948,512, CANC. INT. CL. 16.
- GIORGETTI, PHILIP, LEWISTON, ME:
3,176,335, PUB. 9-12-2006. INT. CL. 25.
- GIORGIFRED COMPANY, WILMINGTON, DE:
3,178,349, INT. CL. 31.
- GIUNTA, CHRISTOPHER, BROOKLYN, NY:
3,177,069, PUB. 9-12-2006. INT. CL. 16.
3,177,081, PUB. 9-12-2006. INT. CL. 41.
- GLAXO GROUP LIMITED, GREENFORD, MIDDLESEX, UNITED KINGDOM:
3,176,077, PUB. 9-12-2006. INT. CL. 5.
3,176,413, PUB. 9-12-2006. INT. CL. 5.
3,176,415, PUB. 9-12-2006. INT. CL. 5.
3,176,416, PUB. 9-12-2006. INT. CL. 5.
3,176,417, PUB. 9-12-2006. INT. CL. 5.
- GLEASON CUTTING TOOLS CORPORATION, ROCHESTER, NY, BARBER-COLMAN COMPANY, ROCKFORD, IL:
803,403, REN. 10-26-06. U.S. CL. 23 (INT. CL. 7).
- GLEASON WORKS, THE, ROCHESTER, NY:
3,178,626, INT. CL. 7.
- GLEN GRANT WHISKY COMPANY LIMITED, PAISLEY, UNITED KINGDOM:
2,000,333, REN. 10-25-06. INT. CL. 33.
- GLENMORE DISTILLERIES COMPANY, LOUISVILLE, KY TO THE WINE GROUP, LLC, RIPON, CA:
1,364,823, CANC. INT. CL. 33.
- GLICK, LAWRENCE S., CRANSTON, RI:
3,176,643, PUB. 9-12-2006. INT. CL. 37.
- GLOBAL DEVELOPMENT CONSULTING CORPERATION, CHATSWORTH, CA:
3,177,620, INT. CL. 1.
- GLOBAL DOMAIN NAME SERVICES, INC., NEW YORK, NY:
2,308,958, CANC. INT. CL. 42.
- GLOBAL EMPLOYER'S NETWORK, INC., DALLAS, TX:
2,308,255, CANC. INT. CL. 39.
- GLOBAL ENTERPRISE GROUP, INC., OMAHA, NE:
2,308,721, CANC. INT. CL. 35.
- GLOBAL GAMING LEAGUE, INC., BURBANK, CA:
3,177,651, INT. CL. 41.
- GLOBAL HOME PRODUCTS LLC C/O CERBERUS CAPITAL MANAGEMENT, L.P., NEW YORK, NY:
2,309,080, CANC. INT. CL. 21.
- GLOBAL POLYMER INDUSTRIES, INC., ARLINGTON, SD:
3,177,960, INT. CL. 12.
- GLOBAL TECHNOLOGIES GROUP, INC., ARLINGTON, VA:
2,309,242, CANC. INT. CL. 9.
2,309,243, CANC. INT. CL. 9.
- GLOBAL TRADING ANALYTICS LLC, JERSEY CITY, NJ:
3,176,266, PUB. 9-12-2006. INT. CL. 36.
- GLORY FOODS, INC., COLUMBUS, OH:
3,175,799, PUB. 9-12-2006. INT. CL. 29.
- GMB, INC., KING, NC:
1,378,350, CANC. INT. CL. 34.
2,309,865, CANC. INT. CL. 34.
- GN STORE NORD A/S, DK-1016 COPENHAGEN K., DENMARK:
3,175,771, PUB. 5-30-2006. MULTIPLE CLASS, INT. CLS. 9, 10 AND 38.
- GNJ VENTURES, LLP, MISSOULA, MT:
3,176,707, PUB. 9-12-2006. INT. CL. 12.
- GO FISH CO., LTD., PORTLAND, OR:
2,308,819, CANC. INT. CL. 25.
- GO ON USA, LTD., NEW YORK, NY:
2,309,718, CANC. INT. CL. 25.
- GOD'S WORD TO THE NATIONS BIBLE SOCIETY, CLEVELAND, OH:
1,992,032, REN. 10-26-06. INT. CL. 16.
- GOERLICH'S, INC., GOLDSBORO, NC:
3,175,898, PUB. 9-12-2006. INT. CL. 7.
- GOLD KIST INC., ATLANTA, GA TO SOUTHERN STATES COOPERATIVE, INCORPORATED, RICHMOND, VA:
1,949,193, CANC. INT. CL. 42.
- GOLDEN PALACE LIMITED, ST. JOHN'S, ANTIGUA & BARBUDA:
3,176,719, PUB. 9-12-2006. INT. CL. 41.
- GOLDEN PLAINS SOFTWARE, LLC., LAS VEGAS, NV:
3,176,571, PUB. 9-12-2006. INT. CL. 35.
- GOLDEN WHISK, LLC, SOUTH SAN FRANCISCO, CA:
2,309,419, CANC. INT. CL. 30.
- GOLDIE, ROY L., JR., LITTLETON, CO:
3,178,151, INT. CL. 10.
- GOLDIE'S COFFEE HOUSE, INC., CARY, IL:
3,177,126, PUB. 9-12-2006. INT. CL. 30.
- GOLDMAX INDUSTRIES, INC., CITY OF INDUSTRY, CA:
3,178,681, INT. CL. 21.
- GOLDRIVER ORCHARDS, INC., OAKDALE, CA:
3,176,705, PUB. 9-12-2006. INT. CL. 31.
- GOLDSMITH SEEDS, INC., GILROY, CA:
2,089,173, REN. 10-26-06. INT. CL. 31.
- GOLF COURSE SUPERINTENDENTS OF AMERICA, LAWRENCE, KS:
1,924,189, REN. 10-21-06. INT. CL. 41.
- GOLF FOR CAUSE, L.L.C., TEMPE, AZ:
3,176,750, PUB. 9-12-2006. MULTIPLE CLASS, INT. CLS. 35 AND 41.
- GOMEZ ADVISORS, INC., CONCORD, MA:
2,309,183, CANC. INT. CL. 42.
- GONGGA FOOD SDN BHD, IPOH, PERAK, MALAYSIA:
3,177,961, INT. CL. 30.
- GONZALES, MARY L., MORGAN HILL, CA:
2,012,710, REN. 10-25-06. INT. CL. 28.
- GOOD, RICHARD W., NEW HOLLAND, PA:
3,177,871, INT. CL. 9.
- GOODRICH ACTUATION SYSTEMS, LE MESNIL AMELOT, FRANCE:
1,045,284, REN. 10-26-06. INT. CL. 7.
- GOODY'S MS, LP, KNOXVILLE, TN:
1,949,260, CANC. INT. CL. 42.
- GOODYEAR TIRE & RUBBER COMPANY, THE, AKRON, OH:
1,065,253, REN. 10-20-06. INT. CL. 12.
3,178,080, INT. CL. 6.
- GORDON FOOD SERVICE, INC., GRAND RAPIDS, MI:
3,176,102, PUB. 9-12-2006. INT. CL. 35.
- GORDON, ANTHONY DEWAYNE, INDEPENDENCE, MO:
2,310,095, CANC. INT. CL. 25.
- GOSHEN HEALTH SYSTEM, GOSHEN, IN:
3,178,710, INT. CL. 44.
- GOTTSCHALKS INC., FRESNO, CA:
2,084,494, REN. 10-23-06. MULTIPLE CLASS, INT. CLS. 18 AND 25.
- GOURMET GURU, INC., BRONX, NY:
3,177,363, INT. CL. 30.
- GOVE, THOMAS P., JR., CHELMSFORD, MA:
3,176,063, PUB. 9-12-2006. MULTIPLE CLASS, INT. CLS. 9 AND 35.
- GOVERNMENT COUNSELLING LTD., SPRINGFIELD, VA:
1,378,081, CANC. INT. CL. 16.
- GOYKHMANN, ELLIOT, NEW YORK, NY:
3,176,612, PUB. 9-12-2006. INT. CL. 9.
- GPA ACQUISITION COMPANY, INC., CHICAGO, IL:
3,177,379, INT. CL. 17.
- GPM & KLM, INC., PANAMA CITY, FL:
3,176,101, PUB. 9-12-2006. INT. CL. 37.
- GPSHOPPER, LLC, NEW YORK, NY:
3,178,455, INT. CL. 9.

- GRACIE'S CORPORATION, THE, NEEDHAM, MA:
1,378,677, CANC. INT. CL. 30.
- GRACO INC., MINNEAPOLIS, MN, CONTROLLED PRES-
SURE SYSTEMS, INC., HOUSTON, TX:
1,050,510, REN. 10-25-06. INT. CL. 7.
- GRAHAM CHEESE CORPORATION, ELNORA, IN:
1,053,021, REN. 10-26-06. INT. CL. 29.
- GRAHAM WEBB INTERNATIONAL, CARLSBAD, MN:
1,949,734, CANC. INT. CL. 3.
- GRAHAM WEBB INTERNATIONAL, CARLSBAD, CA:
2,310,089, CANC. INT. CL. 3.
- GRAND ELK, LLC, RADNOR, PA FROM CARIBOU RE-
SORT LLC, RADNOR, PA:
3,177,589, MULTIPLE CLASS, INT. CLS. 18, 21, 35, 39, 41
AND 42.
- GRAND GENERAL ACCESSORIES MANUFACTURING,
RANCHO DOMINGUEZ, CA:
1,992,759, REN. 10-23-06. MULTIPLE CLASS, INT. CLS. 9,
11 AND 12.
- GRAND STREAM ENTERPRISE, INC., PARKLAND, FL:
3,176,815, PUB. 9-12-2006. INT. CL. 3.
- GRAND TETON HOLDINGS, INC., JACKSON, WY:
3,178,054, INT. CL. 35.
- GRANDE CHEESE COMPANY, BROWNSVILLE, WI:
1,949,478, CANC. INT. CL. 30.
- GRANDIN PROPERTIES, INC., CINCINNATI, OH:
2,309,527, CANC. INT. CL. 35.
- GRANITE EQUINE MASSAGE, NASHUA, NH:
3,176,765, PUB. 9-12-2006. INT. CL. 44.
- GRAPHICWORX DESIGN LLC, OSHKOSH, WI:
3,176,031, PUB. 9-12-2006. INT. CL. 28.
- GRAVYMASTER, INC., BRANFORD, CT, KNICKERBOCK-
ER CHOCOLATE COMPANY, NEW YORK, NY:
53,463, REN. 10-23-06. U.S. CL. 46 (INT. CL. 30).
- GRAY, M, SACRAMENTO, CA:
3,176,535, PUB. 9-12-2006. INT. CL. 16.
- GREAT AMERICAN DAYS, INC., ATLANTA, GA:
3,176,818, PUB. 9-12-2006. INT. CL. 35.
- GREAT AMERICAN INSURANCE COMPANY, CINCINNA-
TI, OH:
1,948,812, CANC. INT. CL. 36.
- GREAT AMERICAN PRODUCTS, DESTIN, FL:
3,177,568, INT. CL. 5.
- GREAT EASTERN RESINS INDUSTRIAL CO., LTD., TAI-
CHUNG, TAIWAN:
1,401,757, REN. 10-20-06. INT. CL. 1.
- GREAT LAKES CRUISING CLUB, CHICAGO, IL:
3,176,395, PUB. 9-12-2006. INT. CL. 16.
- GREATLAND CORPORATION, GRAND RAPIDS, MI, DBA
NELCO SOLUTIONS:
3,176,993, PUB. 9-12-2006. INT. CL. 35.
- GREEN DESIGN FURNITURE COMPANY, PORTLAND,
ME:
3,178,049, INT. CL. 20.
- GREEN GARDEN FOOD PRODUCTS, INC., KENT, WA:
3,177,102, PUB. 9-12-2006. MULTIPLE CLASS, INT. CLS.
29 AND 30.
- GREEN MOUNTAIN COMMUNICATIONS, INC., WOLFE-
BORO FALLS, NH:
2,879,208, COR. MULTIPLE CLASS, INT. CLS. 36, 37
AND 42.
- GREEN WHITE CHECKER, LLC, TORRANCE, CA:
3,176,984, PUB. 9-12-2006. INT. CL. 25.
- GREENE, STUART EVAN, LARKSPUR, CA:
3,176,736, PUB. 9-12-2006. INT. CL. 5.
- GREENFIELD ONLINE, INC., WILTON, CT:
3,177,543, INT. CL. 35.
- GREENWALD, LARRY, SARASOTA, FL AND GREEN-
WALD, SHELLEY, SARASOTA, FL, DBA RECOGNITION
RESOURCES:
1,949,777, CANC. INT. CL. 19.
- GREGORY TRAINING ASSOCIATES, INC., WESTMOUNT,
QUEBEC, CANADA:
2,308,463, CANC. INT. CL. 9.
- GRIDER, ARTHUR P., HOUSTON, TX:
2,309,112, CANC. INT. CL. 35.
- GRIFFIN BACAL INC., NEW YORK, NY:
2,309,588, CANC. INT. CL. 35.
- GRIGGER, ROSALIND R., NEW CASTLE, DE AND DAVIS,
DAVITA Q., NEW CASTLE, DE:
3,178,768, MULTIPLE CLASS, INT. CLS. 25 AND 35.
- GRIMA, JUAN BERNAD, ELCHE (ALICANTE), SPAIN AND
MARTINEZ, TOMAS AZNAR, ELCHE (ALICANTE),
SPAIN:
3,176,305, PUB. 9-12-2006. INT. CL. 25.
- GRO-POWER, INC., CHINO, CA:
1,996,929, REN. 10-23-06. INT. CL. 5.
- GROUP FITNESS USA, LLC, GAITHERSBURG, MD:
3,178,518, INT. CL. 41.
- GROUP:LILI DESIGNS INC., COTATI, CA:
3,177,354, MULTIPLE CLASS, INT. CLS. 3 AND 4.
- GROUPEX FINANCIAL CORPORATION, LA MIRADA, CA:
3,177,629, INT. CL. 39.
- GRUBER, JACK, GREAT NECK, NY:
3,177,741, INT. CL. 10.
- GRUMA CORPORATION, IRVING, TX:
3,178,582, INT. CL. 30.
- GRUNDL ENTERPRISES, INC., LITTLE ROCK, AR:
1,947,934, CANC. INT. CL. 9.
- GRUPO KALTEX, S.A. DE C.V., NAUCALPAN DE JUAREZ,
MEXICO:
2,381,674, CANC. INT. CL. 20.
2,383,505, CANC. INT. CL. 20.
- GSF-FORSCHUNGSZENTRUM FUR UMWELT UND GE-
SUNDHEIT GMBH, 85764 OBERSCHLEISSHEIM, FED
REP GERMANY:
2,308,201, CANC. INT. CL. 5.
2,308,202, CANC. INT. CL. 5.
- GUANGDONG CANNERY GUANGZHOU, YUANCUN,
GUANGZHOU, GUANGDONG, CHINA:
2,006,428, REN. 10-26-06. INT. CL. 29.
- GUARD FINANCIAL GROUP, INC., WILKES-BARRE, PA:
1,995,504, REN. 10-25-06. INT. CL. 36.
- GUARDS CORPORATION, ANNAPOLIS JUNCTION, MD:
1,948,922, CANC. INT. CL. 10.
- GUARDSMARK, LLC, MEMPHIS, TN:
3,177,719, INT. CL. 41.
- GUERRIERI GROUP, LLC, THE, NILES, IL:
3,176,171, PUB. 9-12-2006. INT. CL. 21.
3,176,172, PUB. 9-12-2006. INT. CL. 21.
- GUIDE SERIES, INC., TAMPA, FL:
2,308,182, CANC. INT. CL. 35.
- GUILLERMO RAMIREZ ORDOÑEZ, MEXICO, D.F., MEX-
ICO:
3,176,261, PUB. 9-12-2006. INT. CL. 43.
- GUITTARD CHOCOLATE COMPANY, BURLINGAME, CA:
3,176,270, PUB. 9-12-2006. INT. CL. 30.
- GULF SECURITY TECHNOLOGY CO., LTD., CHINA:
3,177,267, PUB. 9-12-2006. INT. CL. 9.
- GULRICH, KATHLEEN, NEW YORK, NY:
3,175,970, PUB. 9-12-2006. INT. CL. 41.
- GURAL LLC, PETALUMA, CA:
1,378,424, CANC. INT. CL. 36.
- GURULE, JACK, VAN NUYS, CA:
3,176,700, PUB. 9-12-2006. INT. CL. 28.
- GUTKOWSKI, THADDEUS EDWARD, LINDEN, NJ:
2,309,843, CANC. INT. CL. 28.
- GUTTER GEAR CORPORATION, WILTON, CT:
2,308,629, CANC. INT. CL. 25.
- GUY ANDERSON WINES LTD., SHERBORNE, UNITED
KINGDOM:
3,177,742, INT. CL. 33.
- GUY, STEPHEN L., SIMI VALLEY, CA:
3,177,077, PUB. 9-12-2006. INT. CL. 42.
- GUZZLER MANUFACTURING, INC., STREATOR, AL:
1,996,827, REN. 10-26-06. INT. CL. 12.
- GYM POSSIBLE, INC., BARNSTEAD, NH:
3,177,507, INT. CL. 41.
- GYM-MARK, INC., SAN FRANCISCO, CA, GYMBOREE
CORPORATION, THE, BURLINGAME, CA:
1,442,236, REN. 10-24-06. INT. CL. 28.
- G2 SWITCHWORKS CORP., CHICAGO, IL:
3,177,976, MULTIPLE CLASS, INT. CLS. 39 AND 43.
- GÜTERMANN & CO. AG, SWITZERLAND:
3,177,269, PUB. 9-12-2006. INT. CL. 23.

- H.D. FRANCHISING SYSTEMS, LLC, MILFORD, OH:
3,178,761, INT. CL. 37.
- HAGGAR WOMEN'S WEAR, LTD., DALLAS, TX:
3,176,814, PUB. 9-12-2006. INT. CL. 25.
- HAILEY B. INC., COLD SPRING HARBOR, NY:
3,178,288, MULTIPLE CLASS, INT. CLS. 35 AND 41.
3,178,289, INT. CL. 41.
- HAI, INC., PORTLAND, OR:
3,176,354, PUB. 9-12-2006. INT. CL. 4.
- HALFORDS LIMITED, WORCESTERSHIRE, UNITED KINGDOM:
3,178,713, MULTIPLE CLASS, INT. CLS. 7, 8, 9 AND 27.
- HALLIBURTON ENERGY SERVICES, INC., CARROLLTON, TX:
3,177,181, PUB. 9-12-2006. INT. CL. 13.
3,178,636, INT. CL. 1.
3,178,643, INT. CL. 13.
- HALLMARK CARDS, INCORPORATED, KANSAS CITY, MO:
1,996,676. REN. 10-26-06. MULTIPLE CLASS, INT. CLS. 16, 26 AND 28.
- HALLMARK LICENSING, INC., KANSAS CITY, MO:
1,378,617, CANC. INT. CL. 42.
3,178,632, INT. CL. 35.
3,178,633, INT. CL. 35.
- HALLOWEEN ZONE, LLC, THE, DURHAM, NC:
2,308,847, CANC. INT. CL. 35.
- HALLOWEEN ZONE, LLC, THE, DURHAM, OH:
2,308,848, CANC. INT. CL. 35.
- HALLOWEEN ZONE, LLC, THE, DURHAM, NC:
2,308,849, CANC. INT. CL. 35.
- HALO INNOVATIONS, INC., PLYMOUTH, MN:
3,176,761, PUB. 9-12-2006. INT. CL. 25.
- HAMANAKA CO., LTD., UKYO-KU, KYOTO-SHI, JAPAN:
1,378,138, CANC. INT. CL. 23.
- HAMEED, FAROOK I, BROOKLYN, NY:
2,309,055, CANC. INT. CL. 25.
- HAMILTON CO., LTD., CHIYODAKU, TOKYO, JAPAN:
1,378,173, CANC. INT. CL. 25.
- HAMILTON COUNTY PARK DISTRICT, CINCINNATI, OH:
3,176,702, PUB. 9-12-2006. INT. CL. 41.
- HANCOCK, DANIEL W., CULVER CITY, CA AND HANCOCK, KAREN L., CULVER CITY, CA TO HANCOCK, DANIEL W., CULVER CITY, CA AND HANCOCK, KAREN L., CULVER CITY, CA:
1,949,306, CANC. INT. CL. 9.
- HAND HELD PRODUCTS, INC., SKANEATELES FALLS, NY:
3,178,117, MULTIPLE CLASS, INT. CLS. 9, 37 AND 42.
- HANDY CHEMICALS LIMITED, CANDIAC, QUEBEC, CANADA:
3,176,438, PUB. 9-12-2006. INT. CL. 1.
- HANDY-STONE CORPORATION, OAKDALE, MN:
2,049,528. REN. 10-24-06. INT. CL. 19.
- HANGZHOU SUS AUTOMOBILE PARTS MANUFACTURE CO., LTD., ZHEJIANG, CHINA:
3,177,682, INT. CL. 12.
- HANKY PANKY, LTD., NEW YORK, NY:
3,176,982, PUB. 9-12-2006. INT. CL. 25.
- HANSSEM CO., LTD., KYUNGKI-DO, REPUBLIC OF KOREA:
3,177,934, INT. CL. 20.
- HARBERT MANAGEMENT CORPORATION, BIRMINGHAM, AL:
2,309,376, CANC. INT. CL. 36.
- HARCHUCK CONSTRUCTION INC., APOLLO, PA:
3,176,655, PUB. 9-12-2006. INT. CL. 37.
- HARCO LABORATORIES, INC., BRANFORD, CT:
3,178,435, INT. CL. 9.
- HARD COPY PRINTING, INC., NEW YORK, NY:
2,308,208, CANC. MULTIPLE CLASS, INT. CLS. 35 AND 42.
- HARDNETT, ADRIAN, F, FT. WASHINGTON, MD:
3,176,911, PUB. 9-12-2006. INT. CL. 25.
- HARMAN INTERNATIONAL INDUSTRIES, INCORPORATED, NORTHRIDGE, CA:
1,377,965. REN. 10-25-06. INT. CL. 9.
- HARMLESS JUNK, INC., DUNWOODY, GA:
3,177,417, MULTIPLE CLASS, INT. CLS. 9, 16, 18, 20 AND 41.
- HARMONY BALL COMPANY, COLUMBUS, OH:
3,176,604, PUB. 9-12-2006. MULTIPLE CLASS, INT. CLS. 16 AND 20.
- HARMONY FOODS CORPORATION, SANTA CRUZ, CA:
2,309,374, CANC. INT. CL. 30.
2,309,375, CANC. INT. CL. 30.
- HARMONY FOODS CORPORATION, FISHERS, IN:
3,176,924, PUB. 9-12-2006. MULTIPLE CLASS, INT. CLS. 29 AND 30.
- HARRAH'S LICENSE COMPANY, LLC, LAS VEGAS, NV:
3,177,080, PUB. 9-12-2006. INT. CL. 41.
3,177,082, PUB. 9-12-2006. INT. CL. 41.
3,177,127, PUB. 9-12-2006. INT. CL. 41.
3,177,129, PUB. 9-12-2006. INT. CL. 41.
- HARRIS BIOMEDICAL LLC, SEATTLE, WA:
2,308,561, CANC. INT. CL. 42.
- HARRIS, BOB, INVERNESS, CA, DBA DANCING FROG DESIGNS:
2,309,774, CANC. MULTIPLE CLASS, INT. CLS. 24 AND 25.
- HARTFORD FIRE INSURANCE COMPANY, HARTFORD, CT:
2,309,396, CANC. INT. CL. 36.
- HARTMANN STUDIOS INCORPORATED, RICHMOND, CA:
3,176,183, PUB. 9-12-2006. MULTIPLE CLASS, INT. CLS. 35, 40, 41, 42 AND 44.
- HARVEY, TIMOTHY JOHN, TEMECULA, CA:
3,177,019, PUB. 9-12-2006. INT. CL. 9.
- HARVEYS INDUSTRIES, INC., SANTA ANA, CA:
3,178,436, INT. CL. 18.
- HARVILL, JANE, WILSONVILLE, IL:
3,177,054, PUB. 9-12-2006. INT. CL. 35.
- HARWARD IRRIGATION SYSTEMS, INC., SPRINGVILLE, UT:
1,996,986. REN. 10-25-06. INT. CL. 11.
- HASBRO, INC., PAWTUCKET, RI:
3,177,471, INT. CL. 28.
- HASCO I.A. LIMITED, RENO, NV:
3,176,032, PUB. 9-12-2006. INT. CL. 41.
- HASCO INTERNATIONAL, INC., ST. CHARLES, MO:
2,309,840, CANC. INT. CL. 42.
- HAWKEYE BANCORPORATION, DES MOINES, IA:
1,378,378, CANC. MULTIPLE CLASS, INT. CLS. 35 AND 36.
- HAWTHORNE, JAMES, MEXICO, MO:
1,948,447, CANC. INT. CL. 41.
- HAYES, TIMOTHY, EAST HAMPTON, NY:
3,178,330, INT. CL. 41.
- HAZEN, STERLING GRANT, ROSELLE, IL:
1,949,569, CANC. INT. CL. 41.
- HDS COSMETICS LAB, INC., YONKERS, NY:
3,175,843, PUB. 9-12-2006. MULTIPLE CLASS, INT. CLS. 3 AND 5.
- HE ONE INDUSTRY CO., LTD., TAICHUNG CITY, TAIWAN:
3,176,746, PUB. 9-12-2006. INT. CL. 28.
- HEAD, DAVID T., TRUMBULL, CT:
3,178,576, INT. CL. 18.
- HEADROOM, BOZEMAN, MT:
3,178,237, MULTIPLE CLASS, INT. CLS. 9 AND 18.
- HEADWEAR, LLC, CHARLOTTE, NC:
3,178,802, INT. CL. 10.
- HEALTH AND WELLNESS PARTNERS L.L.C., RAMSEY, NJ:
3,178,541, INT. CL. 41.
- HEALTH CARE CONCEPTS, INC., AUSTIN, TX:
3,176,994, PUB. 9-12-2006. INT. CL. 35.
- HEALTH DATA SCIENCES CORPORATION, SAN BERNARDINO, CA:
2,308,188, CANC. INT. CL. 9.
- HEALTH FITNESS CORPORATION, MINNEAPOLIS, MN:
3,177,706, MULTIPLE CLASS, INT. CLS. 35, 41 AND 44.
- HEALTH INSIGHTS, INC., BATON ROUGE, LA:
1,378,355, CANC. INT. CL. 35.

HEALTHCARE COMPUTING PUBLICATIONS INC., BROOKLYN, NY TO THE MEDICAL LETTER INC., NEW ROCHELLE, NY:
1,949,809, CANC. INT. CL. 16.

HEALTHDYNE INFORMATION ENTERPRISES, INC., MARIETTA, GA:
2,308,395, CANC. INT. CL. 9.

HEALTHCON AG, 4051 BASLE, SWITZERLAND:
1,378,067, CANC. INT. CL. 16.

HEALTHPOINT, LTD., SAN ANTONIO, TX, TEXAS PHARMACAL COMPANY, SAN ANTONIO, TX:
807,470. REN. 10-25-06. U.S. CL. 18 (INT. CL. 5).

HEALTHPROLINK, INC., BELLEVUE, WA:
3,178,645, INT. CL. 42.

HEALTHSCORE, INC., BOULDER, CO:
1,378,561, CANC. INT. CL. 42.

HEALTHSPRING COMMUNICATIONS, INC., NEW YORK, NY:
2,308,664, CANC. INT. CL. 16.

HEALTHY DIRECTIONS LLC, POTOMAC, MD:
3,116,752, CANC. IIRN. RESTORED TO S.N. 78-637,878.
3,178,537, INT. CL. 5.

HEALTHY HABITS, LLC, SCOTTSDALE, AZ:
3,176,601, PUB. 9-12-2006. MULTIPLE CLASS, INT. CLS. 3 AND 5.

HEALTHY PLANET, INC., ORINDA, CA:
2,309,716, CANC. INT. CL. 16.

HEARST COMMUNICATIONS, INC., NEW YORK, NY:
3,176,294, PUB. 9-12-2006. INT. CL. 16.

HEART-CARE CORPORATION OF AMERICA, INC., TRENTON, NJ:
1,948,138, CANC. MULTIPLE CLASS, INT. CLS. 10 AND 42.

HEARTLAND, PAULA R., SANTA MONICA, CA:
3,177,095, PUB. 9-12-2006. INT. CL. 9.

HEALTHY WATERS ENTERPRISE, LLC, SAN FRANCISCO, CA:
2,309,200, CANC. INT. CL. 32.

HEB GROCERY COMPANY, L.P., SAN ANTONIO, TX:
3,177,895, INT. CL. 5.

HEBBLETHWAITE, SUSAN, MONTREAL, QUEBEC, CANADA:
3,178,739, INT. CL. 28.

HEERTLAND INTERMODAL, INC., DALLES, TX:
2,309,654, CANC. INT. CL. 20.

HEIDENREICH, BARBARA, AUSTIN, TX:
3,176,086, PUB. 9-12-2006. INT. CL. 41.

HELENA HOLDING COMPANY, WILMINGTON, DE:
3,177,794, INT. CL. 1.
3,178,574, INT. CL. 1.

HELLENIC INTERACTIVE, INC., ELMWOOD PARK, IL:
3,177,979, MULTIPLE CLASS, INT. CLS. 9, 35, 38, 41 AND 42.

HELLMANN WORLDWIDE LOGISTICS GMBH & CO. KG, 49090 OSNABRÜCK, FED REP GERMANY:
3,177,244, PUB. 9-12-2006. INT. CL. 39.

HEMPEL A/S, DENMARK:
3,177,303, PUB. 9-12-2006. INT. CL. 2.

HENDERSON, MARLENE, SAN FRANCISCO, CA:
2,309,044, CANC. INT. CL. 25.

HENDRICKSON'S, INC., ST. CHARLES, MO, HENDRICKSON, VICTOR C., ST. LOUIS, MO, DBA HENDRICKSON'S UNIQUE DRESSING:
1,426,701. REN. 10-20-06. INT. CL. 29.

HENGSTONE HOLDINGS, INC., GEORGETOWN, ONTARIO, CANADA:
3,178,307, INT. CL. 9.

HENKEL KGAA, DUESSELDORF, FED REP GERMANY:
3,178,280, INT. CL. 3.

HENKEL KOMMANDITGESELLSCHAFT AUF AKTIEN, DUESSELDORF D-40191, FED REP GERMANY:
1,378,091, CANC. INT. CL. 17.

HEPWORTH, JOHN, MONTREAL, CANADA:
3,177,041, PUB. 9-12-2006. INT. CL. 41.

HERALD INTERACTIVE INC., BOSTON, MA:
2,308,593, CANC. INT. CL. 35.

HERB FINDER, INC., THE, ST. GEORGE, UT:
2,309,828, CANC. INT. CL. 5.

HERB'S HERBS INC., PAHOA, HI:
3,176,583, PUB. 9-12-2006. INT. CL. 5.

HERBALUXX CORP., CORAL GABLES, FL:
3,176,296, PUB. 9-12-2006. INT. CL. 5.

HERCULES OFFSHORE, INC., HOUSTON, TX:
3,176,662, PUB. 9-12-2006. INT. CL. 39.

HERCULES VAN LINES INC., LOS ANGELES, CA:
3,177,055, PUB. 9-12-2006. MULTIPLE CLASS, INT. CLS. 35 AND 39.

HERITAGE PRESERVATION CORPORATION, SPARTANBURG, SC, R.R. DONNELLEY & SONS COMPANY, CHICAGO, IL:
1,996,347. REN. 10-25-06. INT. CL. 16.

HERLITZ, KLAUS, DR., 10117 BERLIN, FED REP GERMANY:
3,177,284, PUB. 9-12-2006. MULTIPLE CLASS, INT. CLS. 16, 25 AND 28.

HERMAN MILLER INC., ZEELAND, MI:
2,308,584, CANC. INT. CL. 20.

HERMAN MILLER, INC., ZEELAND, MI, HERMAN MILLER, INC., ZEELAND, MI:
814,984. REN. 10-26-06. U.S. CL. 32 (INT. CL. 20).

HERMAN MILLER, INC., ZEELAND, MI:
1,991,938. REN. 10-25-06. INT. CL. 24.

HERNANDEZ, ALFONSO P, JERSEY CITY, NJ AND MALONY, ERIC, JERSEY CITY, NJ:
3,177,737, INT. CL. 33.

HERR HOLDINGS, INC., WILMINGTON, DE:
3,177,158, PUB. 9-12-2006. INT. CL. 29.

HERRIN, MARK, DALLAS, TX:
2,309,453, CANC. INT. CL. 35.

HESS CORPORATION, NEW YORK, NY, HESS OIL & CHEMICAL CORPORATION, PERTH AMBOY, NJ:
832,393. REN. 10-26-06. U.S. CL. 15 (INT. CL. 4).

HESSERT, THOMAS, HADDONFIELD, NJ:
3,176,616, PUB. 7-25-2006. INT. CL. 25.

HEWLETT-PACKARD COMPANY, PALO ALTO, CA:
2,309,938, CANC. INT. CL. 39.

HICKS, VERONICA, IRVINE, CA:
3,177,747, INT. CL. 36.

HIGH GEAR USA, INC., FLETCHER, NC:
3,176,816, PUB. 9-12-2006. INT. CL. 9.

HIGHER AIM, INC., FRESNO, CA:
3,176,980, PUB. 9-12-2006. INT. CL. 35.

HIGHLAND PARK HOSPITAL, HIGHLAND PARK, IL:
2,308,578, CANC. INT. CL. 42.

HIGHPOINT SOFTWARE SYSTEMS, LLC, WAUKESHA, WI:
3,177,725, INT. CL. 9.

HIGHWIND SOFTWARE, INC., MARLBORO, MA:
2,308,421, CANC. INT. CL. 9.

HIGHWIND SOFTWARE, INC., MARLBOROUGH, MA:
2,308,436, CANC. INT. CL. 9.

HILL ENTERPRISES, INC., GAITHERSBURG, MD:
2,309,422, CANC. INT. CL. 37.

HILL-ROM SERVICES, INC., BATESVILLE, IN:
3,178,377, INT. CL. 10.

HILLMAN THOMPSON, CHICAGO, IL:
3,176,954, PUB. 9-12-2006. INT. CL. 44.

HILLYARD ENTERPRISES, INC., ST. JOSEPH, MO:
3,178,428, INT. CL. 21.

HILSINGER COMPANY, THE, PLAINVILLE, MA:
3,176,602, PUB. 9-12-2006. INT. CL. 9.

HIRSCHKOP, JON DAVID, SAN RAFAEL, CA:
3,176,033, PUB. 9-12-2006. MULTIPLE CLASS, INT. CLS. 29 AND 30.

HIRSH INDUSTRIES, INC., DES MOINES, IA:
3,177,556, INT. CL. 20.

HIRSHBERG FOUNDATION FOR PANCREATIC CANCER RESEARCH, LOS ANGELES, CA:
3,176,092, PUB. 9-12-2006. MULTIPLE CLASS, INT. CLS. 14 AND 36.

HISTORIC LEMP BREWERY, LLC., ST. LOUIS, MO:
3,175,835, PUB. 9-12-2006. INT. CL. 37.

HITCHCOCK, DALLAS W., MALIBU, CA:
3,178,743, INT. CL. 20.
3,178,744, INT. CL. 20.

HNTB CORPORATION, KANSAS CITY, MO:
3,177,940, MULTIPLE CLASS, INT. CLS. 38 AND 39.

- HOBBY PRODUCTS INTERNATIONAL, INC., FOOTHILL RANCH, CA:
3,178,001, INT. CL. 28.
- HOECHST CELANESE CORPORATION, SOMMERSVILLE, NJ:
1,377,751, CANC. MULTIPLE CLASS, INT. CLS. 1 AND 9.
- HOFFMANN-LA ROCHE INC., NUTLEY, NJ:
1,377,853, CANC. INT. CL. 5.
1,377,856, CANC. INT. CL. 5.
- HOIST FITNESS SYSTEMS, INC., SAN DIEGO, CA:
3,176,310, PUB. 9-12-2006. INT. CL. 28.
- HOLDEN LLC, HOFFMAN ESTATES, IL, DBA HOLDEN INTERNATIONAL:
2,877,523, COR. MULTIPLE CLASS, INT. CLS. 9, 16, 35 AND 41.
- HOLLINGER, DARREL R., LAKE SAINT LOUIS, MO AND PICKETT, PATT H., LAKE SAINT LOUIS, MO:
3,177,057, PUB. 9-12-2006. INT. CL. 41.
- HOLLINGSWORTH, CRAIG, LEUCADIA, CA:
3,176,223, PUB. 9-12-2006. INT. CL. 28.
- HOLLY B. CLEGG, INC., BATON ROUGE, LA:
2,081,546, REN. 10-23-06. INT. CL. 16.
- HOLMES, JOHN F., WHITING, IA, DBA JOHN HOLMES PUBLISHING COMPANY:
1,384,226, REN. 10-25-06. INT. CL. 16.
- HOLSTED MARKETING INC., NEW YORK, NY:
2,309,905, CANC. INT. CL. 3.
- HOLT INTERNATIONAL, LLC, KINGSTON, OH:
2,308,682, CANC. INT. CL. 1.
- HOME ACCOUNT NETWORK, INC., CHARLESTON, SC:
2,309,609, CANC. INT. CL. 9.
- HOME AUTOMATION, INC. NEW ORLEANS, LA:
2,002,373, REN. 10-25-06. INT. CL. 9.
- HOME DECOR PRODUCTS, INC., EDISON, NJ:
3,178,088, INT. CL. 35.
- HOME INFORMATION SERVICES, INC., NEW YORK, NY:
1,949,725, CANC. INT. CL. 42.
- HOME REBUILDERS, INC., THE, ATLANTA, GA:
3,177,037, PUB. 9-12-2006. INT. CL. 37.
3,177,038, PUB. 9-12-2006. INT. CL. 37.
3,177,039, PUB. 9-12-2006. INT. CL. 37.
- HOMEGOODS, INC., FRAMINGHAM, MA:
3,178,650, INT. CL. 24.
- HOMELAND VINYL PRODUCTS, INC., BIRMINGHAM, AL:
3,178,674, INT. CL. 19.
- HOMER TLC, INC., CLAYMONT, DE:
3,178,039, INT. CL. 11.
3,178,672, INT. CL. 19.
- HOMETEAM INSPECTION SERVICE, INC., THE, MILFORD, OH:
2,006,336, REN. 10-23-06. INT. CL. 42.
- HOMETOWN ALLIANCE INSURANCE AGENCY, LLC, TAUNTON, MA:
3,176,910, PUB. 9-12-2006. INT. CL. 36.
- HONEYCUTT, RHODNEY, HICKORY, NC:
3,176,279, PUB. 9-12-2006. MULTIPLE CLASS, INT. CLS. 21 AND 25.
- HONEYWELL INTERNATIONAL INC., MORRISTOWN, NJ:
3,177,886, INT. CL. 35.
3,178,137, INT. CL. 7.
- HONICK, CRAIG A., BAINBRIDGE ISLAND, WA AND PRECISION REPORTS, INC., BAINBRIDGE ISLAND, WA:
3,177,074, PUB. 9-12-2006. INT. CL. 35.
- HONORA LTD., NEW YORK, NY:
1,378,043, CANC. INT. CL. 14.
- HOODIAFAST INC., BROOKLYN, NY:
3,175,862, PUB. 9-12-2006. INT. CL. 5.
- HOOT AEROBIC SYSTEMS, INC., LAKE CHARLES, LA:
1,412,219, REN. 10-26-06. INT. CL. 11.
- HORIZON BUSINESS CONCEPTS, INC., BROKEN ARROW, OK:
3,177,034, PUB. 9-12-2006. INT. CL. 42.
- HORIZON BUSINESS SERVICES INC., NAPLES, FL:
2,309,133, CANC. INT. CL. 9.
- HORNY TOAD ACTIVEWEAR, INC., SANTA BARBARA, CA:
1,994,940, REN. 10-24-06. INT. CL. 25.
1,994,940, CANC. INT. CL. 24.
- HOSILYK, RODNEY E., FOUNTAIN VALLEY, CA TO IGO CORPORATION, RENO, NV:
1,949,203, CANC. INT. CL. 9.
- HOSPIRA, INC., LAKE FOREST, IL:
1,046,237, REN. 10-25-06. INT. CL. 5.
- HOST COMMUNICATIONS, INC., LEXINGTON, KY:
1,949,619, CANC. INT. CL. 42.
- HOT STUFF FOODS, LLC, SIOUX FALLS, SD:
3,178,165, MULTIPLE CLASS, INT. CLS. 29, 30, 35 AND 43.
3,178,172, MULTIPLE CLASS, INT. CLS. 29, 30, 35 AND 43.
3,178,533, INT. CL. 30.
- HOTELS.COM, L.P., DALLAS, TX:
2,308,379, CANC. INT. CL. 42.
- HOUGH INTERNATIONAL, INC., ALBERTVILLE, AL:
1,948,964, CANC. MULTIPLE CLASS, INT. CLS. 7 AND 9.
- HOUSE OF BLUES BRANDS CORP., HOLLYWOOD, CA:
3,178,268, INT. CL. 41.
- HOUSE OF CURMUDGEON GAMES, INC., ELFRIDA, AZ:
1,378,287, CANC. INT. CL. 28.
- HOUSEHOLD INSPECTION TEAM, INC., SKOKIE, IL:
2,310,108, CANC. INT. CL. 42.
- HOUSTON MUSEUM OF NATURAL SCIENCE, HOUSTON, TX:
1,986,961, REN. 10-22-06. INT. CL. 28.
- HOWMEDICA OSTEONICS CORP., MAHWAH, NJ:
3,176,134, PUB. 9-12-2006. INT. CL. 10.
- HQM, LTD., WILMINGTON, DE:
2,310,105, CANC. INT. CL. 29.
- HR FIRST CONTACT, L.L.C., DALLAS, TX:
3,176,975, PUB. 9-12-2006. INT. CL. 45.
- HRH MARKETING, INC, CLEARWATER, FL:
2,309,416, CANC. INT. CL. 29.
- HRM OUTSOURCING, INC., SAINT LOUIS, MO:
3,177,404, INT. CL. 35.
- HUDSON CITY PAPER COMPANY, INC., LANDOVER, MD:
2,309,171, CANC. INT. CL. 35.
- HUDSONVILLE CREAMERY AND ICE CREAM COMPANY, THE, BURNIPS, MI:
2,309,736, CANC. INT. CL. 30.
- HUFFY CORPORATION, MIAMISBURG, OH:
2,309,086, CANC. INT. CL. 12.
- HUGHES BROTHERS INC, SEWARD, NE:
3,177,903, INT. CL. 17.
- HUHTAMAKI FINANCE B.V., HOOFDDORP, NETHERLANDS:
3,176,366, PUB. 9-12-2006. MULTIPLE CLASS, INT. CLS. 16, 20 AND 21.
- HUMANTEKNIK AB, S-117 43 STOCKHOLM, SWEDEN TO QUICKELS SYSTEMS AB, 126 30 HAGERSTEN, SWEDEN:
1,947,886, CANC. INT. CL. 10.
- HUMANTEKNIK AB, S-117 43 STOCKHOLM, SWEDEN TO QUICKELS SYSTEMS AB, 123 30 HAGERSTEN, SWEDEN:
1,947,887, CANC. INT. CL. 10.
- HUNTER DOUGLAS, INC., UPPER SADDLE RIVER, NJ:
2,308,710, CANC. INT. CL. 20.
- HUNTING WORLD LLC, RENO, NV:
3,176,009, PUB. 9-12-2006. INT. CL. 34.
- HUNTSMAN FILM PRODUCTS CORP., SALT LAKE CITY, UT TO PLIANT CORPORATION, SALT LAKE CITY, UT:
1,947,873, CANC. INT. CL. 17.
- HURRICANE POWER, INC., MIAMI, FL:
3,175,823, PUB. 9-12-2006. MULTIPLE CLASS, INT. CLS. 7 AND 12.
- HURST, JOHN W., WAYNE, PA:
2,309,081, CANC. MULTIPLE CLASS, INT. CLS. 9 AND 41.
- HUSBANDS, JOSEPH WHITTLE, WEDOWEE, AL:
3,176,915, PUB. 9-12-2006. INT. CL. 9.
- HUTH, ALLEN, J, ENGLEWOOD, CO:
3,176,143, PUB. 9-12-2006. MULTIPLE CLASS, INT. CLS. 9, 16 AND 41.

HVS LICENSING, LLC, ROSLYN HEIGHTS, NY, HVS LICENSING CORP., ROSLYN HEIGHTS, NY:
1,989,101. REN. 10-22-06. U.S. CL. B.
1,989,102. REN. 10-22-06. U.S. CL. B.

HYDRATION TECHNOLOGIES, INC., ALBANY, OR:
3,176,193. PUB. 9-12-2006. INT. CL. 11.

HYDRODYNE, INC., HATO REY, PUERTO RICO:
2,309,977. CANC. MULTIPLE CLASS, INT. CLS. 7 AND 29.

HYPERVISTA TECHNOLOGIES, LLC, HERNDON, VA:
3,176,833. PUB. 9-12-2006. INT. CL. 42.

HYUNDAI MOTOR AMERICA, FOUNTAIN VALLEY, CA:
3,178,164. INT. CL. 12.

I.D.M. IMMUNO-DESIGNED MOLECULES, FRANCE:
3,177,316. PUB. 9-12-2006. INT. CL. 5.

I.E.R. (SOCIETE ANONYME A DIRECTOIRE ET CONSEIL DE SURVEILLANCE), 92150 SURESNES, FRANCE:
1,405,639. REN. 10-25-06. INT. CL. 9.

I.O.A. HOLDINGS, LLC, LEHI, UT:
3,176,297. PUB. 9-12-2006. INT. CL. 37.

I.P. HOLDINGS, INC., GRAND PRAIRIE, TX:
3,177,564. INT. CL. 7.

I.S. STUDIO INC., EDIF. FUDO 3 A, MACAO:
3,177,389. MULTIPLE CLASS, INT. CLS. 24 AND 27.

I-BEHAVIOR, INC., HARRISON, NY:
3,176,337. PUB. 9-12-2006. INT. CL. 35.

I-LIGN LIMITED, WELLINGTON, NEW ZEALAND:
3,176,432. PUB. 9-12-2006. MULTIPLE CLASS, INT. CLS. 9 AND 42.

I-SAFE AMERICA, INC., CARLSBAD, CA:
3,178,440. INT. CL. 35.

I/B/E/S INTERNATIONAL, INC., NEW YORK, NY:
2,309,786. CANC. INT. CL. 9.

IBACOS, INC., PITTSBURGH, PA:
3,178,829. MULTIPLE CLASS, INT. CLS. 9, 16, 37 AND 42.

ICA CO., LTD., SEOUL, REPUBLIC OF KOREA:
3,178,078. INT. CL. 32.

ICEBERG VENTURES, LLC, LOUISVILLE, KY:
2,460,421. CANC. INT. CL. 35.

ICICLE INC., NEW YORK, NY:
3,175,776. PUB. 9-12-2006. INT. CL. 25.

ICICLE SEAFOODS, INC., SEATTLE, WA, PETERSBURG FISHERIES, INC., PETERSBURG, AK:
1,068,220. REN. 10-26-06. INT. CL. 29.

ICVERIFY, INC., RESTON, VA:
2,309,746. CANC. INT. CL. 9.

IDEAL VALUE, LLC, CHARLOTTE, NC:
3,178,052. INT. CL. 36.

IDEATIONS DESIGN INC., SEATTLE, WA:
1,939,901. REN. 10-24-06. INT. CL. 28.

IFMG-IP, LLC, RICHMOND, VA:
3,176,952. PUB. 9-12-2006. MULTIPLE CLASS, INT. CLS. 36 AND 42.

IFRACTAL LLC, PHILADELPHIA, PA:
3,176,582. PUB. 9-12-2006. INT. CL. 35.

IGLHAUT, CURT, BALTIMORE, MD:
3,176,923. PUB. 9-12-2006. INT. CL. 21.

IGT, RENO, NV:
1,949,297. CANC. INT. CL. 9.
3,177,696. INT. CL. 9.
3,177,735. INT. CL. 9.
3,177,736. INT. CL. 9.
3,177,832. INT. CL. 9.

IGT - NORTH AMERICA, RENO, NV:
1,949,674. CANC. INT. CL. 9.
1,949,675. CANC. INT. CL. 9.

II-VI INCORPORATED, SAXONBURG, PA:
3,177,744. INT. CL. 1.

ILLINOIS ALLIANCE FOR ARTS EDUCATION, CHICAGO, IL:
1,948,343. CANC. INT. CL. 16.

ILLINOIS TOOL WORKS, GLENVIEW, IL, TEXWIPE COMPANY, THE, UPPER SADDLE RIVER, NJ:
1,995,776. REN. 10-24-06. INT. CL. 21.

ILLINOIS TOOL WORKS INC., GLENVIEW, IL, ILLINOIS TOOL WORKS, CHICAGO, IL:
635,824. REN. 10-26-06. U.S. CL. 21 (INT. CL. 9).

ILLINOIS TOOL WORKS INC., GLENVIEW, IL, TEXWIPE COMPANY, THE, UPPER SADDLE RIVER, NJ:
1,995,699. REN. 10-24-06. INT. CL. 21.
1,995,786. REN. 10-24-06. INT. CL. 21.

ILLINOIS TOOL WORKS INC., GLENVIEW, IL:
2,309,870. CANC. INT. CL. 4.

IMAGE COMICS, INC., BERKELEY, CA:
1,999,267. REN. 10-26-06. INT. CL. 25.

IMAGE ONLINE DESIGN, INC., SAN LUIS OBISPO, CA:
3,177,334. MULTIPLE CLASS, INT. CLS. 9, 18, 21 AND 35.

IMAGINATIONS!, INC., OREM, UT:
3,175,770. PUB. 9-12-2006. INT. CL. 16.

IMAGINE GLOBAL LLC, CLEARWATER, FL:
3,177,083. PUB. 9-12-2006. INT. CL. 30.

IMERYS PIGMENTS, INC., ROSWELL, GA:
3,178,395. INT. CL. 1.

IMPACT CONTAINMENT SYSTEMS, INC., LAKE ZURICH, IL:
3,177,525. INT. CL. 19.

IMPERATIVES, LLC, MINNETONKA, MN:
3,176,573. PUB. 9-12-2006. INT. CL. 35.
3,177,155. PUB. 9-12-2006. INT. CL. 35.

IMPULSE GLOBAL PARTNERS ENTERPRISES LLC, UNION CITY, NJ:
3,176,148. PUB. 9-12-2006. MULTIPLE CLASS, INT. CLS. 39 AND 41.

IMPULSE WEAR, INC., BLACKLICK, OH:
2,003,348. REN. 10-25-06. INT. CL. 42.

IMPULSION GOLF, INC., ZEPHYRHILLS, FL:
3,177,468. INT. CL. 28.

IMS PRODUCTS, INC., RIVERSIDE, CA:
2,308,727. CANC. INT. CL. 35.

IN & OUT CASH, FALLON, NV:
2,309,850. CANC. INT. CL. 36.

IN HOUSE PRODUCTIONS, CO., MINNEAPOLIS, MN:
2,308,725. CANC. INT. CL. 35.

IN WIN DEVELOPMENT, INC., TAOYUAN HSIEN, TAIWAN:
2,309,591. CANC. INT. CL. 35.

IN-STORE MEDIA SYSTEMS, INC., AURORA, CO:
2,309,607. CANC. INT. CL. 35.

IN-YER-HAIR, INC., BROOKLYN PARK, MN:
2,309,035. CANC. INT. CL. 26.

INAMED MEDICAL PRODUCTS CORPORATION, SANTA BARBARA, CA:
3,176,568. PUB. 9-12-2006. INT. CL. 10.

INCANTO GROUP S.R.L., ITALY:
3,177,239. PUB. 9-12-2006. MULTIPLE CLASS, INT. CLS. 20 AND 24.

INCHORD COMMUNICATIONS, INC., WESTERVILLE, OH:
3,176,421. PUB. 9-12-2006. MULTIPLE CLASS, INT. CLS. 35, 41 AND 42.

INCISIVE SURGICAL, INC., MINNETONKA, MN:
3,177,377. INT. CL. 35.

INCREDEDIDAD MEDIA LLC, DENVER, CO:
3,176,396. PUB. 9-12-2006. INT. CL. 41.

INDEFINITE DESIGNS INC., CAPITOL HEIGHTS, MD:
2,308,461. CANC. INT. CL. 25.

INDEKA GROUP, THE, OAKVILLE, ONTARIO, GREB INTERNATIONAL AND COMPANY, LIMITED PARTNERSHIP/SOCIETE EN COMMANDITE GREB INTERNATIONAL, ACTON VALE, QUEBEC, JOH 1A0, CANADA:
1,992,324. REN. 10-23-06. INT. CL. 25.

INDEPENDENT INK, INC., GARDENA, CA:
2,309,315. CANC. INT. CL. 3.

INDEPENDENT SOFTBALL ASSOCIATION INC. D/B/A ISA INC., WINTER HAVEN, FL:
1,376,348. REN. 10-26-06. INT. CL. 41.

INDEXICA LTD., TORONTO, ONTARIO, CANADA:
3,177,401. INT. CL. 12.

INDUSTRIAL BEARING & TRANSMISSION CO., INC., SHAWNEE MISSION, KS:
1,378,587. CANC. INT. CL. 42.

INDUSTRIAL COMMUTATOR CORPORATION, MARYVILLE, TN:
2,309,245. CANC. INT. CL. 40.
2,309,246. CANC. INT. CL. 40.

- INDUSTRIAL ENERGY APPLICATIONS, INC., CEDAR RAPIDS, IA:
2,308,448, CANC. INT. CL. 42.
- INDUSTRIAL MANAGEMENT COUNCIL, ROCHESTER, NY:
2,309,651, CANC. INT. CL. 35.
- INDUSTRIAL STRENGTH CORPORATION, RICHMOND, CA:
2,309,782, CANC. INT. CL. 9.
- INERGY PROPANE, LLC, KANSAS CITY, MO:
2,308,315, CANC. INT. CL. 39.
- INFICON GMBH, BAD RAGAZ, SWITZERLAND:
3,176,480, PUB. 9-12-2006. INT. CL. 9.
- INFO PLUS ACCOUNTING, P.C., YPSILANTI, MI:
3,178,385, INT. CL. 9.
- INFORMATION ACCESS TECHNOLOGIES, INC., BERKELEY, CA:
2,308,897, CANC. INT. CL. 35.
- INFORMATIQUE GRAPHISME ENERGETIQUE - I.G.E., 31770 COLOMIERS, FRANCE:
3,175,795, PUB. 9-12-2006. MULTIPLE CLASS, INT. CLS. 9 AND 42.
- INFOSPACE, INC., BELLEVUE, WA:
3,175,994, PUB. 9-27-2005. INT. CL. 38.
- INFOUSA, INC., OMAHA, NE:
3,176,697, PUB. 9-12-2006. INT. CL. 35.
- INFRASAFE, INC., ORLANDO, FL:
1,993,448, REN. 10-21-06. INT. CL. 42.
1,993,450, REN. 10-21-06. INT. CL. 9.
1,993,451, REN. 10-21-06. INT. CL. 37.
1,993,452, REN. 10-21-06. INT. CL. 41.
- ING NORTH AMERICA INSURANCE CORPORATION, ATLANTA, GA:
3,176,018, PUB. 9-12-2006. INT. CL. 36.
- INGENIATRICES TECNOLOGIAS, S.L., NEW YORK, NY:
3,178,265, MULTIPLE CLASS, INT. CLS. 9 AND 42.
- INGLEBURNE WINE COMPANY PTY LTD, SOUTH AUSTRALIA, AUSTRALIA:
3,177,773, INT. CL. 33.
- INGRAM ENTERPRISES, INC., SPRINGFIELD, MO:
3,178,200, INT. CL. 13.
- INGRESSOFT, LLC, ALISO VIEJO, CA:
3,178,737, INT. CL. 42.
- INILEX, INC., CHANDLER, AZ:
3,176,640, PUB. 9-12-2006. MULTIPLE CLASS, INT. CLS. 35 AND 45.
- INLAND REAL ESTATE GROUP, INC., THE, OAK BROOK, IL:
1,408,898, REN. 10-25-06. INT. CL. 36.
- INN AT ST. JOHN'S, LLC, BLOOMFIELD HILLS, MI:
3,178,315, INT. CL. 43.
- INN FOODS INC., WATSONVILLE, CA:
2,071,617, REN. 10-25-06. INT. CL. 29.
- INN FOODS, INC., WATSONVILLE, CA, S-P SALES CO., INC., SAN FRANCISCO, CA:
807,592, REN. 10-25-06. U.S. CL. 46 (INT. CL. 29).
- INNERCOOL THERAPIES, INC., SAN DIEGO, CA:
3,177,611, INT. CL. 9.
- INNERWORK COMPANY, THE, CHESTER SPRINGS, PA:
2,309,028, CANC. INT. CL. 35.
- INNOVANCE PAINCARE CENTERS, LLC, LOUISVILLE, KY:
2,308,871, CANC. INT. CL. 35.
- INNOVATIVE ADHESIVES COMPANY, KANSAS CITY, MO:
3,177,660, INT. CL. 1.
- INNOVATIVE EDGE, LLC, THE, SAN FRANCISCO, CA:
3,176,654, PUB. 9-12-2006. INT. CL. 41.
3,177,134, PUB. 9-12-2006. INT. CL. 41.
- INNOVATIVE HYGIENE PRODUCTS, INC., WAITE PARK, MN:
3,175,946, PUB. 5-25-2004. MULTIPLE CLASS, INT. CLS. 16 AND 21.
- INNOVATIVE IMAGING INC., SACRAMENTO, CA:
1,948,755, CANC. INT. CL. 10.
- INNOVATIVE POLYMER SOLUTIONS, INC., VALRICO, FL:
3,176,645, PUB. 9-12-2006. INT. CL. 17.
- INNOVATIVE TECHNOLOGIES CORPORATION OF AMERICA, INC, DADE CITY, FL:
3,176,374, PUB. 9-12-2006. INT. CL. 5.
- INNOVENT INC., DANBURY, CT:
2,309,218, CANC. INT. CL. 28.
- INSIGHTS INCORPORATED, BOSTON, MA, DBA ADVANTAGE PUBLICATIONS:
2,309,512, CANC. INT. CL. 9.
- INSOLVENCY SERVICES GROUP, INC., TARZANA, CA:
2,320,575, CANC. INT. CL. 16.
- INSPIRADO DESIGNS CORPORATION, KENT, WA:
2,308,284, CANC. INT. CL. 35.
- INSTITUT ESTHEDERM, FRANCE:
3,177,202, PUB. 9-12-2006. INT. CL. 3.
- INSTITUTE FOR EDUCATION AND THE ARTS, WASHINGTON, DC:
3,176,119, PUB. 9-12-2006. INT. CL. 41.
- INSTITUTE FOR TREND RESEARCH, INC., CONCORD, NH:
3,175,810, PUB. 9-12-2006. MULTIPLE CLASS, INT. CLS. 16 AND 41.
- INSTITUTE OF MANAGEMENT RESOURCES, WESTLAKE VILLAGE, CA TO PROUDFOOT CONSULTING COMPANY, WEST PALM BEACH, FL:
1,948,946, CANC. INT. CL. 35.
- INSTREET ENTERPRISES, INC., CHINO, CA:
3,176,120, PUB. 9-12-2006. MULTIPLE CLASS, INT. CLS. 3, 11, 21 AND 37.
- INTEC, INC., MIAMI, FL:
3,178,720, INT. CL. 9.
- INTECOM, DALLAS, TX:
2,309,799, CANC. INT. CL. 42.
- INTEGRATED BUSINESS SOLUTIONS, NEWTOWN, CT:
3,176,840, PUB. 9-12-2006. INT. CL. 3.
- INTEGRATED RECOVERY PRODUCTS, INC., COSTA MESA, CA:
3,177,505, INT. CL. 10.
- INTEGRIS GLOBAL, L.P., IRVING, TX:
3,178,201, INT. CL. 5.
- INTEL CORPORATION, SANTA CLARA, CA:
2,309,535, CANC. INT. CL. 9.
- INTERACCESS CO., CHICAGO, IL:
2,308,366, CANC. INT. CL. 42.
- INTERACTIVE COMPUTING SERVICES, INCORPORATED, DENVER, CO:
1,377,983, CANC. INT. CL. 9.
- INTERACTIVE SOLUTIONS, INC., SARASOTA, FL:
2,309,130, CANC. INT. CL. 9.
2,309,131, CANC. INT. CL. 9.
2,309,132, CANC. INT. CL. 9.
- INTERCALL, INC., CHICAGO, IL:
1,948,833, CANC. INT. CL. 38.
- INTERCEPT, INC., JACKSONVILLE, FL:
3,177,983, INT. CL. 9.
- INTERNATIONAL ASSOCIATION OF PLUMBING AND MECHANICAL OFFICIALS, ONTARIO, CA:
1,405,797, REN. 10-26-06. INT. CL. 16.
- INTERNATIONAL BEAUTY PRODUCTS, INC., EAST RUTHERFORD, NJ:
2,309,867, CANC. INT. CL. 21.
- INTERNATIONAL BRAND LICENSING AG, CH-7250 KLOSTERS, SWITZERLAND:
1,404,944, REN. 10-20-06. MULTIPLE CLASS, INT. CLS. 18, 25 AND 28.
- INTERNATIONAL BUSINESS MACHINES CORPORATION, ARMONK, NY:
1,949,310, CANC. INT. CL. 9.
1,949,312, CANC. INT. CL. 9.
3,177,996, MULTIPLE CLASS, INT. CLS. 16, 35 AND 41.
- INTERNATIONAL COMPLIANCE PROFESSIONALS ASSOCIATION, SPRINGETOWN, TX:
3,176,543, PUB. 9-12-2006. MULTIPLE CLASS, INT. CLS. 35 AND 42.
- INTERNATIONAL COMPUTER WORKS, INC., TEMPLE TERRACE, FL:
3,176,544, PUB. 9-12-2006. INT. CL. 9.

- INTERNATIONAL DATA GROUP, INC., FRAMINGHAM, MA:
2,308,557, CANC. INT. CL. 35.
2,309,492, CANC. INT. CL. 42.
2,309,606, CANC. INT. CL. 16.
- INTERNATIONAL DIRECT GROUP INC., NEW YORK, NY:
3,177,411, INT. CL. 25.
- INTERNATIONAL E-Z UP, INC., RIVERSIDE, CA:
1,992,874, REN. 10-20-06. INT. CL. 19.
1,994,970, REN. 10-20-06. INT. CL. 19.
- INTERNATIONAL FLAVORS & FRAGRANCES INC., NEW YORK, NY:
2,308,962, CANC. MULTIPLE CLASS, INT. CLS. 1 AND 3.
- INTERNATIONAL FURUSATO, INC., HONOLULU, HI, FURUSATO HAWAII, LTD., HONOLULU, HI:
1,034,100, REN. 10-25-06. INT. CL. 42.
- INTERNATIONAL MASTERS PUBLISHERS AB, 80 MALMO, SWEDEN:
2,309,903, CANC. INT. CL. 16.
- INTERNATIONAL MEDICAL GROUP, INC., INDIANAPOLIS, IN:
2,308,264, CANC. INT. CL. 36.
- INTERNATIONAL METROLOGY SYSTEMS, LTD., EDINBURGH, SCOTLAND, UNITED KINGDOM:
2,308,197, CANC. INT. CL. 9.
- INTERNATIONAL MICROCOMPUTER SOFTWARE, INC., SAN RAFAEL, CA:
2,308,531, CANC. INT. CL. 9.
- INTERNATIONAL NETWORKS, LLC, CENTENNIAL, CO:
3,176,109, PUB. 9-12-2006. MULTIPLE CLASS, INT. CLS. 38 AND 41.
- INTERNATIONAL ORDER OF THE GOLDEN RULE, BRIDGETON, MO, INTERNATIONAL ORDER OF THE GOLDEN RULE INC., SPRINGFIELD, IL:
814,187, REN. 10-26-06. U.S. CL. 101 (INT. CLS. 35, 36, 38, 41 AND 42).
- INTERNATIONAL PAPER COMPANY, STAMFORD, CT:
2,309,737, CANC. INT. CL. 16.
- INTERNATIONAL SOFTWARE SYSTEMS SOLUTIONS, INC., BOYNTON BEACH, FL:
3,176,701, PUB. 9-12-2006. INT. CL. 9.
- INTERNATIONAL SWAPS AND DERIVATIVES ASSOCIATION, INC., NEW YORK, NY:
3,176,508, PUB. 9-12-2006. MULTIPLE CLASS, INT. CLS. 9, 16, 35, 36 AND 41.
- INTERNATIONAL TAEKWONDO ALLIANCE, INC., PENSACOLA, FL:
3,175,914, PUB. 9-12-2006. INT. CL. 41.
3,175,935, PUB. 9-12-2006. INT. CL. 41.
- INTERNATIONAL WOMEN'S FORUM, WASHINGTON, DC:
3,178,741, INT. CL. 41.
- INTERNETIVITY INC., OTTAWA, ONTARIO, CANADA:
2,308,402, CANC. INT. CL. 9.
2,308,403, CANC. INT. CL. 9.
- INTEROCEAN SYSTEMS, INC., SAN DIEGO, CA:
3,176,804, PUB. 9-12-2006. INT. CL. 9.
3,176,805, PUB. 9-12-2006. INT. CL. 9.
- INTERSTATE BATTERY SYSTEM INTERNATIONAL, INC., DALLAS, TX:
3,177,425, INT. CL. 9.
- INTERSTATE HOTELS CORPORATION, PITTSBURGH, PA TO INTERSTATE HOTELS, LLC, PITTSBURGH, PA:
1,948,308, CANC. INT. CL. 42.
- INTIMO, INC., NEW YORK, NY:
2,308,165, CANC. INT. CL. 25.
- INVERSIONES CIFCO S.A., LAS CONDES, CHILE:
3,177,952, INT. CL. 35.
- INVIVO CORPORATION, ORLANDO, FL:
3,178,707, MULTIPLE CLASS, INT. CLS. 9, 10 AND 42.
- ION COMPUTER SYSTEMS, INC., HAUPPAUGE, NY:
1,991,125, REN. 10-25-06. INT. CL. 42.
- IOSTUDIO, LLC, NASHVILLE, TN:
3,177,456, MULTIPLE CLASS, INT. CLS. 16, 41 AND 42.
- IPSEN INDUSTRIES INTERNATIONAL GMBH, 47533 KLEVE, FED REP GERMANY:
1,957,247, REN. 10-26-06. MULTIPLE CLASS, INT. CLS. 1, 9 AND 11.
- IPSEN INTERNATIONAL, INC., CHERRY VALLEY, IL, ABAR IPSEN INDUSTRIES, FEASTERVILLE, PA:
1,363,202, REN. 10-25-06. INT. CL. 11.
- ISLAM, MOHAMMAD R, DIX HILLS, NY:
3,178,718, MULTIPLE CLASS, INT. CLS. 9 AND 36.
- ISLIPMEDIA NETWORK, INC., PITTSBURGH, PA:
2,309,140, CANC. INT. CL. 9.
- ISNESIX, INC., SAN DIEGO, CA:
3,176,249, PUB. 9-12-2006. INT. CL. 44.
- ISOTIS ORTHOBIOLOGICS, INC., IRVINE, CA:
3,176,224, PUB. 9-12-2006. MULTIPLE CLASS, INT. CLS. 5 AND 10.
3,177,788, INT. CL. 10.
3,177,789, INT. CL. 10.
- ISP CAPITAL, INC., WILMINGTON, DE, KELCO COMPANY, SAN DIEGO, CA:
421,958, REN. 10-23-06. U.S. CL. 46 (INT. CLS. 29 AND 30).
- ISTANBUL GIDA TURIZM SANAYI VE TICARET ANONIM SIRKETI, TURKEY:
3,177,198, PUB. 9-12-2006. MULTIPLE CLASS, INT. CLS. 32 AND 33.
- IT'S ALL ABOUT IMAGE INC., MAGNOLIA, AZ:
2,309,222, CANC. INT. CL. 5.
- ITC DELTACOM, INC., HUNTSVILLE, AL:
3,178,769, INT. CL. 38.
- ITHRIVE HEALTH, LLC, BETHESDA, MD:
3,177,734, MULTIPLE CLASS, INT. CLS. 3, 5, 35 AND 44.
- ITOCHU CORPORATION, CHUO-KU, OSAKA, JAPAN:
3,176,455, PUB. 9-12-2006. INT. CL. 12.
3,176,456, PUB. 9-12-2006. INT. CL. 12.
- ITOCHU INTERNATIONAL INC., NEW YORK, NY:
3,176,897, PUB. 9-12-2006. INT. CL. 16.
- ITOYS INC., TORONTO, CANADA:
3,176,059, PUB. 9-12-2006. INT. CL. 28.
- IVOCLEAR VIVADENT, INC., AMHERST, NY:
3,176,684, PUB. 9-12-2006. INT. CL. 10.
- IVOX, INC. ATLANTA, GA:
3,177,949, INT. CL. 35.
- IVT SOFTWARE TECHNOLOGY INC., CHINA:
3,177,282, PUB. 9-12-2006. INT. CL. 9.
- IVX ANIMAL HEALTH, INC., ST. JOSEPH, MO:
1,979,814, REN. 10-24-06. INT. CL. 5.
- IVX ANIMAL HEALTH, INC., ST. JOSEPHS, MO:
2,027,707, REN. 10-25-06. INT. CL. 5.
- J & B INC., BILLINGS, MT:
3,176,319, PUB. 9-12-2006. INT. CL. 30.
- J JARGON CO., WINTER PARK, FL:
3,176,773, PUB. 9-12-2006. INT. CL. 20.
- J P WALLS, INC., LEXINGTON, NC:
3,175,755, PUB. 9-12-2006. INT. CL. 19.
- J WORLD, INC., NEWPORT, RI:
1,947,993, CANC. MULTIPLE CLASS, INT. CLS. 9 AND 41.
- J. & P. COATS, LIMITED, GLASGOW, SCOTLAND:
3,178,517, INT. CL. 23.
- J. C. PENNEY COMPANY, INC., NEW YORK, NY:
1,378,110, CANC. INT. CL. 18.
- J. E. RHOADS & SONS, INC., BRANCHBURG, NJ, J. E. RHOADS & SONS, PHILADELPHIA, PA:
56,567, REN. 10-20-06. U.S. CL. 35 (INT. CL. 18).
- J. FRANK SCHMIDT & SON CO., BORING, OR:
1,405,184, REN. 10-26-06. INT. CL. 31.
- J. K. SIMMONS ENTERPRISE, L.L.C., COMMERCE TOWNSHIP, MI:
3,177,617, INT. CL. 20.
- J. KINDERMAN & SONS, INC., PHILADELPHIA, PA:
3,178,776, INT. CL. 11.
- J. M. HUBER CORPORATION, EDISON, NJ:
2,309,191, CANC. INT. CL. 1.
- J.A. WOOLLAM CO. INC., LINCOLN, NE:
3,177,574, INT. CL. 9.
- J.C. BAMFORD EXCAVATORS LIMITED, STAFFORDSHIRE, UNITED KINGDOM:
3,134,964, COR. MULTIPLE CLASS, INT. CLS. 7 AND 12.
- J.L. CLARK, INC., ROCKFORD, IL:
3,178,042, INT. CL. 20.
- J&B SAUSAGE COMPANY, INC., WAELDER, TX:
1,948,811, CANC. INT. CL. 29.

- J&J INDUSTRIES, INC., DALTON, GA:
1,415,115. REN. 10-24-06. INT. CL. 27.
- JACHIMEK, WILLIAM G, PHOENIX, AZ:
3,176,564. PUB. 9-12-2006. INT. CL. 36.
- JACKSON, DALE, WHITEWRIGHT, TX:
2,309,324. CANC. INT. CL. 29.
- JACKSON, KATHY, CASSELBERRY, FL:
2,310,074. CANC. INT. CL. 16.
- JACKSON, WILLIAM E. JR., SUNRISE, FL:
3,177,717. INT. CL. 25.
- JACOB ORTIZ, HUNTINGTON BEACH, CA:
3,178,791. INT. CL. 41.
- JACQUES BERNIER, INC., PEEKSKILL, NY:
1,377,795. CANC. INT. CL. 3.
- JADE EXPRESS, INC., LOS ANGELES, CA:
3,177,408. INT. CL. 35.
- JAKKS PACIFIC (HK), LTD., MALIBU, CA:
1,949,165. CANC. INT. CL. 9.
- JAKKS PACIFIC, INC., MALIBU, CA:
3,178,646. INT. CL. 16.
3,178,647. INT. CL. 16.
3,178,697. INT. CL. 9.
- JALIMA COFEE LLC, BRADENTON, FL:
3,178,294. INT. CL. 30.
- JAMBA JUICE COMPANY, SAN FRANCISCO, CA:
3,178,393. INT. CL. 9.
3,178,394. INT. CL. 9.
- JAMES HARDIE RESEARCH PTY LIMITED, CAMELLIA,
NEW SOUTH WALES 2142, AUSTRALIA:
2,308,783. CANC. INT. CL. 19.
- JAMES P. LITCHKO, KENSINGTON, MD:
3,177,787. INT. CL. 16.
- JAMES S BENNETT, PHOENIX, AZ:
3,176,877. PUB. 9-12-2006. INT. CL. 41.
- JANG, YOUNG, LOS ANGELES, CA:
3,178,026. INT. CL. 41.
- JANSSEN INTERNATIONAL LTD., BEAMSVILLE, CANA-
DA:
3,176,529. PUB. 9-12-2006. MULTIPLE CLASS, INT. CLS.
20 AND 35.
- JAQUES, EBER, SAN ANSELMO, CA:
3,178,328. INT. CL. 43.
- JARROW FORMULAS, INC., LOS ANGELES, CA:
3,178,408. INT. CL. 5.
3,178,413. INT. CL. 5.
- JAVAFLOW, LLC, PEARL RIVER, LA:
3,175,837. PUB. 9-12-2006. INT. CL. 11.
- JAVITS, ERIC M. JR., NEW YORK, NY:
3,177,347. INT. CL. 25.
- JB PRIMETIME MEDICAL SUPPLY, INC., HOUSTON, TX:
3,176,838. PUB. 9-12-2006. INT. CL. 5.
- JEAN PATOU, INC., SOMERSET, NJ:
1,377,815. CANC. INT. CL. 3.
1,377,816. CANC. INT. CL. 3.
- JEAN-JACQUES FRADKOFF, DELRAY BEACH, FL:
3,177,228. PUB. 9-12-2006. MULTIPLE CLASS, INT. CLS.
14 AND 37.
- JECKLE, MILAN, SPOKANE, WA:
3,177,821. INT. CL. 28.
- JELIQUE PRODUCTS INC, ODESSA, FL:
3,176,177. PUB. 9-12-2006. INT. CL. 3.
- JENN FENG INDUSTRIAL CO., LTD., PING CHANG CITY,
TAOYUAN HSIEN, TAIWAN:
2,024,472. REN. 10-24-06. INT. CL. 7.
- JENZABAR, INC., CAMBRIDGE, MA:
2,308,967. CANC. MULTIPLE CLASS, INT. CLS. 35 AND
42.
- JERRY HUFFMAN CUSTOM BUILDERS, LLC, PLANO, TX:
3,009,915. CANC. IIRN. RESTORED TO S.N. 76-461,479.
- JESSTALK SPEAKING SERVICES LLC, LAS VEGAS, NV:
3,176,015. PUB. 9-12-2006. INT. CL. 41.
- JET SET AG, SWITZERLAND:
3,177,195. PUB. 9-12-2006. MULTIPLE CLASS, INT. CLS.
18, 25 AND 28.
- JEWELL'S CLASSIC BOTTOMS, INC., EL PASO, TX:
1,949,146. CANC. INT. CL. 25.
- JF FRANCHISE SYSTEMS, LLC, CHARLOTTE, NC:
1,995,838. REN. 10-26-06. INT. CL. 42.
- JFC TEMPS, INC., CAMP HILL, PA:
3,178,230. INT. CL. 35.
- JIANGSU SHUANGDENG DIANYUAN; YOUXIAN GONG-
SI, CHINA:
3,177,321. PUB. 9-12-2006. INT. CL. 9.
- JIFFY INTERNATIONALS AS, N-4610 KIRSTIANSAND,
NORWAY, FERRY-MORSE SEED CO., THE, DETROIT,
MI:
422,975. REN. 10-26-06. U.S. CL. 1 (INT. CL. 31).
- JILL R. PAYNE, P.C., HOUSTON, TX:
3,176,386. PUB. 9-12-2006. INT. CL. 10.
- JIMENEZ PEREZ, JERONIMO, SPAIN:
3,177,314. PUB. 9-12-2006. MULTIPLE CLASS, INT. CLS.
18, 25 AND 39.
- JJM FINANCIAL STRATEGIES, INC., NEWTOWN, PA:
3,176,901. PUB. 9-12-2006. INT. CL. 36.
- JMB INSURANCE AGENCY, INC., CHICAGO, IL:
3,176,016. PUB. 9-12-2006. INT. CL. 36.
- JMJ ASSOCIATES, LLC, AUSTIN, TX:
3,178,815. MULTIPLE CLASS, INT. CLS. 35 AND 41.
- JOBJOINER.COM, LLC, BOYERTOWN, PA:
3,178,532. INT. CL. 35.
- JOHN A. RUSHING & ASSOCIATES INC., PALATINE, IL:
3,175,883. PUB. 9-12-2006. INT. CL. 18.
- JOHN H. HARLAND COMPANY, DECATUR, GA:
2,057,883. REN. 10-24-06. INT. CL. 16.
2,078,696. REN. 10-24-06. INT. CL. 16.
- JOHN HENRY COMPANY, THE, LANSING, MI:
2,309,894. CANC. INT. CL. 16.
- JOHN RYAN COMPANY, MINNEAPOLIS, MN:
2,309,585. CANC. MULTIPLE CLASS, INT. CLS. 20 AND
37.
- JOHN WHITMAN AND ASSOCIATES, INC., HUNTINGDON
VALLEY, PA, DBA THE WHITMAN GROUP:
2,309,501. CANC. MULTIPLE CLASS, INT. CLS. 35 AND
41.
- JOHNSON & HIGGINS, NEW YORK, NY:
1,378,501. CANC. INT. CL. 41.
- JOHNSON & JOHNSON, NEW BRUNSWICK, NJ:
1,377,999. CANC. INT. CL. 10.
1,378,371. CANC. INT. CL. 35.
- JOHNSON FILTRATION SYSTEMS INC., NEW BRIGHTON,
MN:
1,377,874. CANC. INT. CL. 6.
- JOHNSON INTERNATIONAL, INC., RACINE, WI:
2,308,214. CANC. INT. CL. 36.
- JOHNSON WINDOW FILMS, INC., CARSON, CA:
3,176,555. PUB. 9-12-2006. INT. CL. 17.
- JOHNSON, KAREN LEIGH, COLUMBUS, GA:
3,176,917. PUB. 9-12-2006. INT. CL. 16.
- JOHNSON, LEE, LAKE ELMO, MN:
3,177,962. INT. CL. 21.
- JOHNSON DIVERSEY, INC., STURTEVANT, WI:
2,309,454. CANC. INT. CL. 3.
- JOHNSTON COCA-COLA BOTTLING GROUP, INC., EA-
GAN, MN:
637,794. CANC. U.S. CL. 45.
- JOINT-STOCK COMPANY (JSC) KUPYANSK MILK CAN-
NING COMBINAT, UA-63702 KUPYANSK, KHARKOV
REG., UKRAINE:
3,177,250. PUB. 9-12-2006. INT. CL. 29.
- JON HOLMLUND NURSEY, LLC, BORING, OR, HOLM-
LUND, JOHN, BORING, OR, DBA JOHN HOLMLUND
NURSERY:
2,021,369. REN. 10-20-06. INT. CL. 31.
- JONES INVESTMENT CO., INC., WILMINGTON, DE:
2,308,807. CANC. INT. CL. 25.
- JONES, JEFF A., FRANKLIN, TN:
3,176,620. PUB. 9-12-2006. INT. CL. 35.
- JONES, LANCE, ST. CLOUD, FL:
3,176,578. PUB. 9-12-2006. INT. CL. 37.
- JORDAN, J. ALAN, BATON ROUGE, LA:
3,176,871. PUB. 9-12-2006. INT. CL. 42.
- JORDAN, NATASHA, PALM BAY, FL:
3,176,855. PUB. 9-12-2006. INT. CL. 42.
- JOSE MANUEL FERNANDEZ ARZA, SPAIN:
3,177,196. PUB. 9-12-2006. MULTIPLE CLASS, INT. CLS. 9
AND 25.

JOSEPH & FEISS COMPANY, THE, CLEVELAND, OH:
1,378,155, CANC. INT. CL. 25.

JOSIE GROUP, LLC, COLTS NECK, NJ:
3,177,759, MULTIPLE CLASS, INT. CLS. 16, 25 AND 41.

JOSWICK, PAUL GARRETT, MILWAUKEE, WI:
3,178,463, INT. CL. 16.

JOY OF THE GAME, INC., THE, DEERFIELD, IL:
1,948,465, CANC. INT. CL. 25.

JOYSTICK, INC., LOS ANGELES, CA:
3,175,874, PUB. 9-12-2006. INT. CL. 25.

JRL ENTERPRISES, INC., NEW ORLEANS, LA:
3,176,190, PUB. 9-12-2006. INT. CL. 41.

JUGGERNAUTICS, LLC, ATLANTA, GA:
2,308,353, CANC. INT. CL. 42.

JUGS, INC., TUALATIN, OR:
2,017,266, REN. 10-26-06. MULTIPLE CLASS, INT. CLS. 9,
25 AND 28.

JUICE WORLD INTERNATIONAL, INC., ARROYO
GRANDE, CA:
2,309,325, CANC. INT. CL. 42.

JUICEHEADS, INC., SAN BERNARDINO, CA:
3,178,689, INT. CL. 32.

JULIE A. MARELLA, LLC, MONROE, CT, DBA MARELLA
PROMOTION MARKETING:
3,176,425, PUB. 9-12-2006. INT. CL. 35.

JUNE, RICKY G., NAPLES, FL:
3,178,694, INT. CL. 25.

JUPITERMEDIA CORPORATION, DARIEN, CT:
3,176,505, PUB. 9-12-2006. MULTIPLE CLASS, INT. CLS. 9
AND 35.

JUST FOR TONIGHT, INC., BEVERLY HILLS, CA:
3,176,828, PUB. 9-12-2006. INT. CL. 45.

JUST SO GIFTED, WILLISTON PARK, NY:
3,176,304, PUB. 9-12-2006. INT. CL. 35.

JUST WHEELS & TIRES CO., BREA, CA:
3,177,101, PUB. 9-12-2006. INT. CL. 12.
3,177,147, PUB. 9-12-2006. INT. CL. 12.

JUSTCLICKIT.NET, LLC, HANOVER, NH:
3,177,466, MULTIPLE CLASS, INT. CLS. 9 AND 39.
3,177,467, MULTIPLE CLASS, INT. CLS. 9 AND 39.

JUSTICE SYSTEMS, INC., ALBUQUERQUE, NM:
3,175,858, PUB. 9-12-2006. MULTIPLE CLASS, INT. CLS. 9
AND 35.

JUSTICEWORKS YOUTHCARE, INC., PITTSBURGH, PA:
3,176,473, PUB. 9-12-2006. INT. CL. 45.

JUSUNG ENGINEERING CO., LTD., GYEONGGI-DO, RE-
PUBLIC OF KOREA:
3,177,987, INT. CL. 7.

JUUL INC., BEVERLY HILLS, CA:
3,176,322, PUB. 9-12-2006. INT. CL. 25.

JUXTOPIA, LLC, ALEXANDRIA, VA:
3,176,657, PUB. 7-25-2006. INT. CL. 41.

K & M ASSOCIATES L.P., PROVIDENCE, RI:
1,933,109, CANC. INT. CL. 14.

K. HANSOTIA & CO., INC., MIAMI, FL:
3,178,459, INT. CL. 34.

KABA BENZING GMBH, FED REP GERMANY:
3,177,289, PUB. 9-12-2006. INT. CL. 9.

KABUSHIKI KAISHA FAST RETAILING, JAPAN:
3,177,307, PUB. 9-12-2006. MULTIPLE CLASS, INT. CLS.
18 AND 25.

KABUSHIKI KAISHA KAMINOMOTO HOMPO, KOBE-SHI,
HYOGO-KEN, JAPAN, DBA KAMINOMOTO CO., LTD.:
2,002,344, REN. 10-25-06. INT. CL. 3.
2,002,344, AM. INT. CL. 3.

KABUSHIKI KAISHA KITZ, CHIBA-SHI, CHIBA-KEN, JA-
PAN, DBA KITZ CORPORATION:
2,064,854, REN. 10-24-06. MULTIPLE CLASS, INT. CLS. 6
AND 7.

KABUSHIKI KAISHA KOBE FUGETSUDO, KOBE, JAPAN:
1,409,696, REN. 10-23-06. INT. CL. 30.

KABUSHIKI KAISHA NIKKEN SOHONSHA, GIFU-KEN,
JAPAN, AKA NIKKEN SOHONSHA CORPORATION:
2,002,652, REN. 10-25-06. INT. CL. 3.
2,009,197, REN. 10-25-06. INT. CL. 3.

KAFFIE, GOODMAN & ASSOCIATES, INC., CORPUS
CHRISTI, TX:
2,309,083, CANC. INT. CL. 36.

KAISER ALUMINUM FABRICATED PRODUCTS, LLC,
FOOTHILL RANCH, CA:
2,308,148, CANC. INT. CL. 42.
3,178,357, INT. CL. 6.

KALCORP ENTERPRISES, INC., COLLEGE STATION, TX:
3,177,683, INT. CL. 35.

KALLOY INDUSTRIAL CO., LTD., TAICHUNG, TAIWAN:
1,948,274, CANC. INT. CL. 12.

KALMON, TOPAZ, NEW YORK, NY:
2,308,837, CANC. INT. CL. 25.

KALSEC, INC., KALAMAZOO, MI:
3,175,838, PUB. 9-12-2006. MULTIPLE CLASS, INT. CLS. 2
AND 30.

KALTENBACH & VOIGT GMBH & CO. KG, D-88400
BIBERACH, FED REP GERMANY, FORMERLY KAL-
TENBACH & VOIGT GMBH & CO.:
3,175,782, PUB. 12-21-2004. INT. CL. 10.

KAM INDUSTRIES, LTD., KENOSHA, WI, INRYCO, INC.,
MILWAUKEE, WI:
1,042,150, REN. 10-25-06. INT. CL. 9.

KAMINSTEIN IMPORTS, INC., BLAUVELT, NY:
1,966,965, REN. 10-20-06. INT. CL. 21.

KAMKHAGI, DAVID, HOUSTON, TX:
2,308,799, CANC. INT. CL. 14.

KANAN ENTERPRISES, INC., SOLON, OH, DBA KING NUT
COMPANY:
3,176,367, PUB. 9-12-2006. MULTIPLE CLASS, INT. CLS.
29, 30 AND 31.

KANEGAFUCHI KAGAKU KOGYO KABUSHIKI KAISHA,
OSAKA, JAPAN, DBA KANEKA CORPORATION:
1,045,955, REN. 10-26-06. MULTIPLE CLASS, INT. CLS.
22 AND 26.

KANEGAFUCHI KAGAKU KOGYO KABUSHIKI KAISHA,
KITAKU, OSAKA, JAPAN, DBA KANEKA CORPORA-
TION:
1,046,402, REN. 10-20-06. INT. CL. 22.

KANEGAFUCHI KAGAKU KOGYO KABUSHIKI KAISHA,
KITA-KU, OSAKA-SHI, JAPAN, TA KANEKA CORPORA-
TION:
2,308,132, CANC. INT. CL. 1.

KANSAS CITY POWER & LIGHT, KANSAS CITY, MO:
2,308,427, CANC. INT. CL. 39.

KANSAS CITY POWER & LIGHT COMPANY, KANSAS
CITY, MO:
3,176,202, PUB. 9-12-2006. INT. CL. 39.

KANSAS FOOD BANK WAREHOUSE, INC., WICHITA, KS:
2,310,093, CANC. INT. CL. 36.

KANVAS BY KATIN, INC., SURFSIDE, CA:
1,407,781, REN. 10-26-06. INT. CL. 25.

KAO KABUSHIKI KAISHA, CHUO-KU, TOKYO, JAPAN,
TA KAO CORPORATION:
1,403,640, REN. 10-20-06. INT. CL. 1.

KAO KABUSHIKI KAISHA, CHUO-KU, TOKYO, JAPAN,
TA KAO CORPORATION:
3,176,262, PUB. 9-12-2006. INT. CL. 3.
3,178,342, INT. CL. 3.
3,178,343, INT. CL. 3.
3,178,344, INT. CL. 3.
3,178,345, INT. CL. 3.

KAO KABUSHIKI KAISHA, CHUO-KU, TOKYO, JAPAN,
TA KAO CORPORATION:
3,178,346, INT. CL. 3.

KAORI MAYUMI AND RISA KATO PARTNERSHIP, THE,
RICHMOND, CA:
2,309,926, CANC. INT. CL. 16.

KAPLAN, ELI H., BROOKLYN, NY:
3,177,580, INT. CL. 9.

KARAN, DONNA, NEW YORK, NY TO GABRIELLE
STUDIO, INC., NEW YORK, NY:
1,949,229, CANC. INT. CL. 25.

KARAS, RENEE, WHITE PLAINS, NY:
2,013,332, REN. 10-26-06. INT. CL. 41.

KARE DISTRIBUTION, INC., NEW YORK, NY:
3,178,522, MULTIPLE CLASS, INT. CLS. 16 AND 38.

KARL MARBACH GMBH & CO., HEILBRONN, FED REP
GERMANY:
1,377,868, CANC. MULTIPLE CLASS, INT. CLS. 6 AND 7.

- KARLSHAMNS USA INC., COLUMBUS, OH:
1,378,304, CANC. INT. CL. 29.
- KARMIC NICHE INCORPORATED, LOS ANGELES, CA:
2,308,970, CANC. INT. CL. 18.
- KAROB CORPORATION, SHOREWOOD, WI:
3,178,163, INT. CL. 19.
- KARSTEN MANUFACTURING CORPORATION, PHOENIX, AZ:
3,175,971, PUB. 9-12-2006. INT. CL. 28.
3,177,633, INT. CL. 27.
3,177,636, INT. CL. 25.
3,177,637, INT. CL. 25.
3,177,707, INT. CL. 28.
- KATHMANDU LIMITED, HEATHCOTE, CHRISTCHURCH, NEW ZEALAND:
3,176,356, PUB. 9-12-2006. INT. CL. 24.
- KATIN, JOE J., PARKER, TX:
3,177,713, MULTIPLE CLASS, INT. CLS. 29 AND 30.
- KAUAI PUBLISHING CO., LIHUE, KAUAI, HI:
1,996,707, REN. 10-24-06. INT. CL. 16.
- KAWAHARA NURSERY, INC., MORGAN HILL, CA:
3,178,786, INT. CL. 31.
- KAYTEE PRODUCTS INCORPORATED, CHILTON, WI:
3,178,613, INT. CL. 31.
- KAZI, ANWAR R., HONOLULU, HI:
3,177,657, INT. CL. 35.
- KBS PRODUCTIONS, INC., BROOMFIELD, CO:
2,079,387, REN. 10-25-06. INT. CL. 41.
- KBWEST INC, MOORPARK, CA:
3,178,817, INT. CL. 3.
- KEE TECHNOLOGIES PTY LTD, AUSTRALIA:
3,177,253, PUB. 9-12-2006. INT. CL. 9.
- KEEPITLOCAL.COM, ST. PAUL, MN:
3,175,888, PUB. 9-12-2006. MULTIPLE CLASS, INT. CLS. 35, 36 AND 42.
- KEITH COLE AND LILIAN CHIANG, CENTRAL, HONG KONG, TA DEACONS:
3,176,541, PUB. 9-12-2006. INT. CL. 42.
- KELLOGG COMPANY, BATTLE CREEK, MI:
2,309,366, CANC. INT. CL. 30.
2,309,575, CANC. INT. CL. 30.
- KELLOGG NORTH AMERICA COMPANY, BATTLE CREEK, MI:
2,029,603, REN. 10-23-06. INT. CL. 25.
- KELLY WATERS, INC., BOSTON, MA:
1,949,136, CANC. INT. CL. 14.
- KELLY, DANIEL M, PALM DESSERT, CA:
2,003,617, REN. 10-24-06. INT. CL. 19.
- KELLY, GRACE, LAS VEGAS, NV:
3,177,544, INT. CL. 25.
3,177,545, INT. CL. 25.
- KELLYTOY(USA), INC., LOS ANGELES, CA:
3,176,302, PUB. 9-12-2006. INT. CL. 28.
- KEMIRA CHEMICALS, INC., KENNESAW, GA, APPLIED RESEARCH INC., PORTLAND, OR:
1,946,499, REN. 10-26-06. INT. CL. 1.
- KEMPER SECURITIES GROUP, INC., DENVER, CO:
1,378,410, CANC. INT. CL. 36.
- KEMPS LLC, MINNEAPOLIS, MN:
2,310,036, CANC. INT. CL. 29.
- KEMSLEY, SANDRA G., BLOOMFIELD HILLS, MI:
3,178,409, INT. CL. 42.
- KENDRO LABORATORY PRODUCTS GMBH, LANGENSELBOLD, FED REP GERMANY TO THERMO ELECTRON LED GMBH, LANGENSELBOLD, FED REP GERMANY:
2,344,448, CANC. INT. CL. 11.
- KENECK VENTURES INC., LANGLEY, BRITISH COLUMBIA, CANADA:
3,175,829, PUB. 9-12-2006. MULTIPLE CLASS, INT. CLS. 9 AND 36.
- KERAKOLL S.P.A., ITALY:
3,177,265, PUB. 9-12-2006. INT. CL. 1.
- KESTREL, INC., CONCORD, CA, DBA WEB ONE:
2,308,146, CANC. INT. CL. 42.
- KETTLE CUISINE, INC., SOMERVILLE, MA:
2,309,447, CANC. INT. CL. 29.
- KEVIN A. MCCOY AND EFREN TERAN, ALBUQUERQUE, NM:
3,177,752, INT. CL. 30.
- KEYCORP, CLEVELAND, OH:
2,308,609, CANC. INT. CL. 36.
2,309,724, CANC. INT. CL. 36.
- KEYSTONE FRUIT MARKETING INC., GREENCASTLE, PA:
2,077,385, REN. 10-20-06. INT. CL. 31.
- KHANH HOA SALANGANES NEST COMPANY, NHA TRANG CITY, KHANH HOA PROVINCE, VIETNAM:
3,177,065, PUB. 9-12-2006. INT. CL. 32.
- KHER, RAGHAV, SAMMAMISH, WA:
3,177,768, INT. CL. 41.
- KIDDE FIRE FIGHTING, INC., EXTON, PA:
3,176,286, PUB. 9-12-2006. INT. CL. 17.
- KIDS VOTING USA, INC., TEMPE, AZ:
2,033,341, REN. 10-26-06. INT. CL. 42.
- KIK-WEAR, INC., LOS ANGELES, CA:
3,177,325, INT. CL. 25.
- KIKKOMAN CORPORATION, CHIBA, JAPAN:
1,423,057, REN. 10-20-06. INT. CL. 29.
- KIKO COMFORTABLE CLOTHING LLC, HIALIAH, FL:
1,991,440, REN. 10-23-06. INT. CL. 25.
- KILCULLEN, CHRIS, DALLAS, TX:
2,309,690, CANC. INT. CL. 42.
- KILEY SALES, INCORPORATED, MICHIGAN CITY, IN:
3,176,318, PUB. 9-12-2006. INT. CL. 24.
- KILLER BAITS, INC., SACRAMENTO, CA:
3,176,154, PUB. 9-12-2006. INT. CL. 11.
- KIMBER IP, LLC, YONKERS, NY:
3,177,496, INT. CL. 13.
- KIMBERLY-CLARK WORLDWIDE, INC., NEENAH, WI:
2,024,506, REN. 10-20-06. INT. CL. 16.
2,381,046, CANC. MULTIPLE CLASS, INT. CLS. 3 AND 24.
- KIND, ERIC, NEW YORK, NY AND SADOWSKY, DEREK, NEW YORK, NY:
3,178,332, INT. CL. 16.
- KINETIC TECHNOLOGIES LLC, LEXINGTON, KY:
3,176,574, PUB. 9-12-2006. INT. CL. 5.
- KINETICO INCORPORATED, NEWBURY, OH:
3,175,901, PUB. 9-12-2006. INT. CL. 30.
- KING FISH MEDIA, LLC, SALEM, MA:
3,176,182, PUB. 9-12-2006. MULTIPLE CLASS, INT. CLS. 35, 38 AND 42.
- KING LUCKY FOOD INDUSTRIAL CORP., TAIPEI, TAIWAN, TAIWAN:
1,947,859, CANC. INT. CL. 32.
- KING OF KINGS, INC., MIAMI, FL:
3,178,386, INT. CL. 9.
- KING, DOUGLAS S., BEAVER DAM, KY:
3,176,024, PUB. 9-12-2006. INT. CL. 41.
- KINGSTATE CORP., NEW YORK, NY:
3,178,227, INT. CL. 28.
3,178,356, INT. CL. 28.
- KINKELDER B.V., 6905 DL ZEVENAAR, NETHERLANDS:
1,998,009, REN. 10-23-06. INT. CL. 7.
- KIRIN BEER KABUSHIKI KAISHA, CHUO-KU, TOKYO, JAPAN, TA KIRIN BREWERY CO., LTD.:
3,177,668, INT. CL. 31.
- KIRK, JOHN, BOWLING GREEN, KY AND KIRK, DONNA, BOWLING GREEN, KY:
2,309,399, CANC. INT. CL. 30.
- KISS CATALOG, LTD., PINE BROOK, NJ:
3,175,974, PUB. 9-12-2006. INT. CL. 28.
- KIWI CODERS CORPORATION, WHEELING, IL:
1,048,884, REN. 10-20-06. INT. CL. 7.
- KJB ENTERPRISES, INC., KANSAS CITY, MO:
1,949,775, CANC. INT. CL. 42.
- KLAUSSNER CORPORATE SERVICES, INC., ASHEBORO, NC:
2,309,077, CANC. INT. CL. 20.
2,309,078, CANC. INT. CL. 20.
- KLEENCO PRODUCTS, INCORPORATED, KENT, WA:
1,948,132, CANC. INT. CL. 3.
- KLEIN TOOLS, INC., SKOKIE, IL:
2,308,998, CANC. INT. CL. 8.

KLEINS NATURALS, LTD., BROOKLYN, NY:
3,175,849, PUB. 9-12-2006. INT. CL. 31.

KLEMENT SAUSAGE COMPANY, MILWAUKEE, WI:
3,175,932, PUB. 9-12-2006. INT. CL. 29.

KMART OF MICHIGAN, INC., HOFFMAN ESTATES, IL,
KMART PROPERTIES, INC., TROY, MI:
1,955,434. REN. 10-26-06. MULTIPLE CLASS, INT. CLS. 9
AND 16.

KMC ACQUISITION CORP., LAKEWOOD, CO:
3,177,834, INT. CL. 25.
3,177,896, INT. CL. 25.

KN LTD., SAN RAFAEL, CA:
3,178,131, INT. CL. 16.

KNEPP INCORPORATED, AUSTIN, TX:
3,176,149, PUB. 9-12-2006. MULTIPLE CLASS, INT. CLS.
37 AND 40.

KNOBBE, MARTENS, OLSON & BEAR, LLP, IRVINE, CA:
3,178,136, MULTIPLE CLASS, INT. CLS. 41 AND 42.

KNOTT'S BERRY FARM, BUENA PARK, CA:
1,378,514, CANC. INT. CL. 41.

KNOWLEDGE BASED CONSULTING, INC, SAN FRANCIS-
CO, CA:
3,178,512, INT. CL. 33.
3,178,656, INT. CL. 33.

KOBAYASHI PHARMACEUTICAL CO., LTD., OSAKA,
JAPAN:
3,177,693, MULTIPLE CLASS, INT. CLS. 11 AND 21.

KOCH KONSTRUKTIVE MEMBRANEN GMBH & CO. KG,
D-83253 RIMSTING/CHIEMSEE, FED REP GERMANY:
2,309,494, CANC. MULTIPLE CLASS, INT. CLS. 17, 19, 22
AND 24.

KOCKELMAN, STEVEN, J, HONOLULU, HI:
3,177,698, MULTIPLE CLASS, INT. CLS. 25 AND 41.

KOHL'S ILLINOIS, INC., AURORA, IL:
3,177,452, INT. CL. 20.
3,178,207, MULTIPLE CLASS, INT. CLS. 4, 20, 21, 24 AND
27.

KOHLER, MARK, SABINAL, TX:
3,176,847, PUB. 9-12-2006. INT. CL. 25.

KONAMI GAMING, INC., LAS VEGAS, NV:
3,178,235, INT. CL. 9.

KONICA MINOLTA BUSINESS SOLUTIONS U.S.A., INC.,
WINDSOR, CT:
2,308,260, CANC. INT. CL. 9.

KONINKLIJKE COOYMANS B.V., HERTOGENBOSCH,
NETHERLANDS:
2,309,987, CANC. INT. CL. 33.

KOOLATRON, INC., BRIDGETOWN, BARBADOS:
2,548,519, CANC. INT. CL. 9.

KOONICHI INCORPORATED, FRESH MEADOWS, NY:
3,177,490, MULTIPLE CLASS, INT. CLS. 5 AND 9.

KOPINGS INDUSTRI-PLAST AB, 731 50 KOPING, SWEDEN:
2,308,300, CANC. INT. CL. 21.

KORG U.S.A., INC., MELVILLE, NY:
3,177,521, MULTIPLE CLASS, INT. CLS. 18 AND 25.

KPMG LLP, NEW YORK, NY:
3,176,075, PUB. 9-12-2006. MULTIPLE CLASS, INT. CLS.
36 AND 41.

KR U.S.A., INC., SACRAMENTO, CA:
2,310,054, CANC. INT. CL. 42.

KRAFT FOODS HOLDINGS, INC., NORTHFIELD, IL,
KRAFT FOODS, INC., NORTHFIELD, IL:
1,956,334. REN. 10-24-06. INT. CL. 30.

KRAFT FOODS HOLDINGS, INC., NORTHFIELD, IL:
3,177,844, INT. CL. 30.

KROGER CO. OF MICHIGAN, THE, LIVONIA, MI:
2,309,464, CANC. INT. CL. 29.

KRUEGER INTERNATIONAL, INC., GREEN BAY, WI:
3,177,336, INT. CL. 20.

KRUGER GMBH & CO. KG, 51469 BERGISCH GLADBACH,
FED REP GERMANY:
2,309,143, CANC. INT. CL. 33.

KRUSE, ROBERT L., CHICAGO, KS:
3,176,264, PUB. 9-12-2006. INT. CL. 36.

KSI SWISS, INC., LOUISVILLE, CO:
3,175,803, PUB. 9-12-2006. INT. CL. 35.

KUKA SCHWEISSANLAGEN GMBH, 86165 AUGSBURG,
FED REP GERMANY:
3,177,203, PUB. 9-12-2006. MULTIPLE CLASS, INT. CLS.
6, 7 AND 9.

KUMKANG SHOE CO., LTD., INCHEON, REPUBLIC OF
KOREA:
3,176,507, PUB. 9-12-2006. INT. CL. 25.

KUPKA, JOHN CHARLES, JR., MONTOUR, IA:
2,309,631, CANC. INT. CL. 9.

KURARAY CO., LTD., OKAYAMA PREFECTURE, JAPAN:
3,177,481, INT. CL. 5.
3,177,482, INT. CL. 5.
3,177,674, INT. CL. 25.

KURASHIKI BOSEKI KABUSHIKI KAISHA, KURASHIKI-
SHI, OKAYAMA-KEN, JAPAN, DBA KURABO INDUS-
TRIES LTD.:
1,406,783. REN. 10-22-06. INT. CL. 23.

KUSTOMKIDS, LLC, CALABASAS, CA:
2,308,790, CANC. INT. CL. 28.

KVP FALCON PLASTIC BELTING, INC., RANCHO COR-
DOVA, CA:
3,177,384, INT. CL. 7.

KWEE, KWANG MING, MONTEREY PARK, CA:
3,178,355, INT. CL. 8.

KWIKBINDER.COM, LLC, TIGARD, OR:
3,176,230, PUB. 9-12-2006. INT. CL. 36.

L. PAUL BRAYTON, LTD., HIGH POINT, NC, DBA BRAY-
TON TEXTILE COLLECTION, BRAYTON INTERNA-
TIONAL COLLECTION, HIGH POINT, NC:
1,405,891. REN. 10-26-06. INT. CL. 24.

L.A. DANCEFORCE, INC., LOS ANGELES, CA:
3,176,347, PUB. 9-12-2006. MULTIPLE CLASS, INT. CLS.
25 AND 41.

L&P PROPERTY MANAGEMENT COMPANY, SOUTH
GATE, CA:
3,176,035, PUB. 9-12-2006. MULTIPLE CLASS, INT. CLS. 6
AND 20.

L-BAR-T BISON RANCH, LLC, FOREST GROVE, OR:
3,176,925, PUB. 9-12-2006. INT. CL. 29.

L'HEUREUX, LARRY, SAN MARCOS, CA AND HARRI-
SON, JOHN, SAN MARCOS, CA:
3,176,464, PUB. 9-12-2006. INT. CL. 36.

L'INGLESINA BABY S.P.A., 36077 ALTAVILLA VICENTINA,
ITALY:
1,948,119, CANC. MULTIPLE CLASS, INT. CLS. 12, 18
AND 20.

L'OREAL USA CREATIVE, INC., NEW YORK, NY:
3,178,639, INT. CL. 3.

LA CASITA MEXICANA, INC., BELL, CA:
3,176,886, PUB. 9-12-2006. INT. CL. 43.

LA MARZOCCO INTERNATIONAL, L.L.C., SEATTLE, WA:
2,038,132. REN. 10-25-06. INT. CL. 11.

LA TERRE, LLC, NEWPORT BEACH, CA:
3,178,221, INT. CL. 29.

LA VISION GMBH, GOTTINGEN, FED REP GERMANY:
3,176,791, PUB. 9-12-2006. INT. CL. 9.
3,176,793, PUB. 9-12-2006. INT. CL. 9.

LABORATORIOS VIJOSA, S.A. DE C.V., ANTIGUO CUSCA-
TLAN, LA LIBERTAD, EL SALVADOR:
3,176,110, PUB. 6-27-2006. INT. CL. 5.

LABRO GUIDETTI, INC., SAUSALITO, CA, DBA SAVOIR
FAIRE:
2,309,304, CANC. INT. CL. 16.

LADD FURNITURE, INC., GREENSBORO, NC:
2,309,908, CANC. INT. CL. 20.

LAGACI INC, DANIA, FL:
3,176,899, PUB. 9-12-2006. INT. CL. 25.
3,176,902, PUB. 9-12-2006. INT. CL. 25.

LAJUANDA L. MOODY AND LINDA D. HARRIS PART-
NERSHIP, THE, BRIDGEPORT, CT:
2,308,950, CANC. INT. CL. 25.

LAKE REGION ELECTRIC COOPERATIVE, INC., HUL-
BERT, OK:
3,177,827, INT. CL. 39.

LAMSON OIL COMPANY, ROCKFORD, IL:
1,419,704. REN. 10-23-06. INT. CL. 4.

- LANCE MFG. LLC, CHARLOTTE, NC:
2,309,417, CANC. INT. CL. 30.
3,175,939, PUB. 9-12-2006. INT. CL. 30.
- LANCOME PARFUMS ET BEAUTE & CIE, 75008 PARIS, FRANCE:
1,948,721, CANC. INT. CL. 3.
- LAND O'LAKES, INC., ARDEN HILLS, MN:
2,309,386, CANC. INT. CL. 29.
- LANDESANSTALT FÜR MEDIEN ANSTALT DES ÖFFENTLICHEN RECHTS, FED REP GERMANY:
3,177,204, PUB. 9-12-2006. MULTIPLE CLASS, INT. CLS. 35, 38 AND 41.
- LANDMARK TOWER CORPORATION, FORT WORTH, TX:
1,949,168, CANC. INT. CL. 37.
- LANDO, RON, SAN FRANCISCO, CA:
2,309,075, CANC. INT. CL. 9.
- LANE, FRANK L., ATLANTA, GA, DBA PEACHTREE CREEK GROUP:
1,378,390, CANC. INT. CL. 35.
- LAPINSKI, TAMARA LEIGH, LONDON, UNITED KINGDOM:
3,176,679, PUB. 9-12-2006. INT. CL. 25.
- LAPSTAND, INC., CINCINNATI, OH:
2,309,097, CANC. INT. CL. 9.
- LARSSON, RALF, 435 33 MOLNLYCKE, SWEDEN:
2,751,634, COR. INT. CL. 9.
- LASALLE NATIONAL BANK, CHICAGO, IL:
2,309,945, CANC. INT. CL. 28.
- LASKO HOLDINGS, INC., WILMINGTON, DE:
3,178,234, INT. CL. 11.
- LAU TECHNOLOGIES, LITTLETON, MA:
1,949,003, CANC. INT. CL. 9.
- LAUFEN INTERNATIONAL, INC., TULSA, OK:
2,006,553, REN. 10-24-06. INT. CL. 19.
- LAUVER, CARL L., MORRISVILLE, PA:
3,178,361, INT. CL. 25.
- LAVA VINE LLC, CALISTOGA, CA:
3,178,398, INT. CL. 33.
- LAVISION GMBH, GOTTINGEN, FED REP GERMANY:
3,176,795, PUB. 9-12-2006. INT. CL. 9.
- LAW.COM, L.L.C., MESA, AZ:
2,308,886, CANC. INT. CL. 42.
- LAWRENCE SERVICE CO., PLYMOUTH, MN:
2,308,359, CANC. INT. CL. 35.
- LDM GROUP, LLC, ST. LOUIS, MO:
3,178,258, INT. CL. 44.
- LDR MEDICAL USA, INC., AUSTIN, TX:
3,178,068, INT. CL. 10.
- LDR MEDICAL, S.A.S., 10430 ROSIERES PRES TROYES, FRANCE:
3,178,069, INT. CL. 10.
- LDS TEST AND MEASUREMENT LLC, MIDDLETON, WI:
1,992,947, REN. 10-20-06. INT. CL. 9.
- LE SPORTSAC, INC., NEW YORK, NY:
1,378,548, CANC. INT. CL. 42.
1,998,507, CANC. INT. CL. 18.
- LEACH COMPANY, INC., OSHKOSH, WI:
1,378,024, CANC. INT. CL. 12.
- LEADER NEWS GROUP, LLC, LYNDHURST, NJ:
3,176,826, PUB. 9-12-2006. INT. CL. 41.
- LEADERSHIP DYNAMICS RESOURCES, INC., SAN JUAN CAPISTRANO, CA:
2,310,079, CANC. MULTIPLE CLASS, INT. CLS. 16 AND 42.
- LEARNINGSMITH, INC., CAMBRIDGE, MA:
2,308,242, CANC. INT. CL. 42.
- LEATHERMAN TOOL GROUP, INC., PORTLAND, OR:
3,177,625, INT. CL. 14.
- LEE ADAMS-NORTH, ADENA, OH:
3,178,239, INT. CL. 16.
- LEE KUM KEE COMPANY LIMITED, TAI PO, NEW TERRITORIES, HONG KONG:
3,177,503, INT. CL. 30.
- LEE'S SANDWICHES INTERNATIONAL INC., SAN JOSE, CA:
3,177,995, INT. CL. 43.
- LEFT POINT MARKETING GROUP, INC., ONTARIO, CA:
2,309,169, CANC. INT. CL. 3.
- LEGACY INTERNATIONAL, ALBUQUERQUE, NM:
3,177,395, INT. CL. 1.
- LEGEND LIMITED, BALTIMORE, MD:
3,175,910, PUB. 9-12-2006. INT. CL. 32.
- LEGI INTERNATIONAL S.R.L., ITALY:
3,177,285, PUB. 9-12-2006. MULTIPLE CLASS, INT. CLS. 16 AND 21.
- LEHMAN BROTHERS INC., NEW YORK, NY:
1,997,343, REN. 10-25-06. INT. CL. 36.
- LEI, CHARLES, ALHAMBRA, CA AND CHUANG, JOHN, ALHAMBRA, CA:
3,176,424, PUB. 9-12-2006. INT. CL. 11.
- LEIB, HOWARD D., NEW YORK, NY:
2,308,673, CANC. INT. CL. 41.
- LEICA INC., DEPEW, NY TO LEICA MICROSYSTEMS, INC, DEPEW, NY:
1,949,235, CANC. INT. CL. 9.
- LEMO MASCHINENBAU GMBH, FED REP GERMANY:
3,177,213, PUB. 9-12-2006. INT. CL. 7.
- LENG-D'OR, S.A., 08755 CASTELLBISBAL, BARCELONA, SPAIN:
3,175,786, PUB. 9-20-2005. MULTIPLE CLASS, INT. CLS. 29 AND 30.
- LEO, MATTHEW R., SEDONA, AZ:
3,176,874, PUB. 9-12-2006. INT. CL. 35.
- LEONARD IVANS AND KENNETH C. GERWIT, WESTON, FL:
2,308,781, CANC. INT. CL. 25.
- LEONARD, MACALUSO, TARPON SPRINGS, FL AND BARBARA, MACALUSO, TARPON SPRINGS, FL:
3,176,382, PUB. 9-12-2006. MULTIPLE CLASS, INT. CLS. 29 AND 30.
- LES PARFUMS DE ROSINE SOCIÉTÉ À RESPONSABILITÉ LIMITÉE, F-60350 MARTIMONT CROUTOY, FRANCE:
3,177,194, PUB. 9-12-2006. INT. CL. 3.
- LESIEUR, FRANCE:
3,177,317, PUB. 9-12-2006. INT. CL. 29.
- LESLIE'S POOLMART, INC., PHOENIX, AZ:
3,177,030, PUB. 9-12-2006. INT. CL. 1.
- LESNICK, STEVE, NEW YORK, NY:
3,176,916, PUB. 9-12-2006. INT. CL. 41.
- LETO, MARIA J., ALBUQUERQUE, NM:
1,948,965, CANC. INT. CL. 16.
- LETTUCE ENTERTAIN YOU ENTERPRISES, INC, CHICAGO, IL:
3,178,019, INT. CL. 43.
- LETTUCE ENTERTAIN YOU ENTERPRISES, INC., CHICAGO, IL:
1,996,200, REN. 10-20-06. INT. CL. 42.
- LEVIN CAPITAL STRATEGIES, LP, NEW YORK, NY:
3,178,764, INT. CL. 36.
- LEVAD, INCORPORATED, CHATSWORTH, CA:
3,178,540, INT. CL. 3.
- LEWAN & ASSOCIATES, INC., DENVER, CO:
2,308,569, CANC. MULTIPLE CLASS, INT. CLS. 37 AND 42.
- LEXYL TRAVEL TECHNOLOGIES, INC., SAN DIEGO, CA:
3,176,328, PUB. 9-12-2006. INT. CL. 43.
- LFI EXPRESS, INC., NEWARK, DE:
3,176,253, PUB. 9-12-2006. MULTIPLE CLASS, INT. CLS. 35, 37, 39 AND 42.
- LG CHEM. LTD., YOUNGDUNGPO-GU, SEOUL, REPUBLIC OF KOREA, LUCKY LTD., YONGDUNGPO-GU, SEOUL 150-721, REPUBLIC OF KOREA:
1,998,474, REN. 10-26-06. INT. CL. 1.
- LHASA OMS, INC., WEYMOUTH, MA:
3,176,579, PUB. 9-12-2006. INT. CL. 3.
- LIAONING SG INDUSTRY GROUP CO., LTD., SHENYANG, CHINA:
3,176,942, PUB. 9-12-2006. INT. CL. 12.
- LIBBE, DUANE, LAS VEGAS, NV:
2,308,959, CANC. INT. CL. 35.
- LIBERTY BANK, MIDDLETOWN, CT:
2,309,707, CANC. INT. CL. 36.
- LIBERTY COUNTY DEVELOPMENT AUTHORITY, HINESVILLE, GA:
3,176,739, PUB. 9-12-2006. INT. CL. 35.
3,176,740, PUB. 9-12-2006. INT. CL. 35.

LIBERTY DENTAL ALLIANCE, INC., NASHVILLE, TN:
2,308,280, CANC. INT. CL. 35.

LIBERTY MUTUAL INSURANCE COMPANY, BOSTON,
MA, DBA LIBERTY MUTUAL GROUP:
1,949,544, CANC. INT. CL. 36.

LIBERTY MUTUAL INSURANCE COMPANY, BOSTON,
MA:
3,176,072, PUB. 9-12-2006. INT. CL. 36.

LIBERTY USA, INC., WEST MIFFLIN, PA:
3,176,986, PUB. 9-12-2006. INT. CL. 30.

LIBERTYVILLE BANK & TRUST COMPANY, LIBERTY-
VILLE, IL:
3,176,937, PUB. 9-12-2006. INT. CL. 36.

LIBERTYVILLE SADDLE SHOP, INC., LIBERTYVILLE, IL:
1,403,761. REN. 10-20-06. INT. CL. 6.
1,991,441. REN. 10-20-06. INT. CL. 18.
2,000,097. REN. 10-20-06. INT. CL. 18.

LIBURDI ENGINEERING LIMITED, DUNDAS, ONTARIO
L9H 7K4, CANADA:
3,175,816, PUB. 9-12-2006. MULTIPLE CLASS, INT. CLS.
7, 9 AND 37.

LIFE SCAPES INCORPORATED, CHESTER SPRINGS, PA:
3,177,954, MULTIPLE CLASS, INT. CLS. 16, 41 AND 44.

LIFE SCIENCE PRODUCTS, INCORPORATED, THORN-
TON, CO:
3,176,055, PUB. 9-12-2006. INT. CL. 35.

LIFESAFE LLC, INDIANAPOLIS, IN:
3,177,534, INT. CL. 16.

LIFESPRING RESOURCES, INC., LAFAYETTE, CO:
3,178,082, INT. CL. 9.

LIGHT IMPACT (U.K) LIMITED, UNITED KINGDOM:
3,177,243, PUB. 9-12-2006. MULTIPLE CLASS, INT. CLS.
3, 4, 11 AND 21.

LIGHT INDEX INVESTMENT COMPANY, INC., TACOMA,
WA:
2,308,541, CANC. INT. CL. 36.

LIGHT YEARS AWAY INC., CHANDLER, AZ:
2,308,857, CANC. INT. CL. 14.

LIGHTBRIDGE, INC., BURLINGTON, MA:
2,371,617, CANC. INT. CL. 9.

LIGHTECH ELECTRONIC INDUSTRIES LTD., LOD, IS-
RAEL:
3,178,415, INT. CL. 9.

LIGHTEDGE SOLUTIONS, INC., DES MOINES, IA:
3,177,428, MULTIPLE CLASS, INT. CLS. 35, 38, 39 AND
42.

LIGHTLIFE FOODS, INC., GREENFIELD, MA TO CONA-
GRA BRANDS, INC., OMAHA, NE:
1,948,530, CANC. INT. CL. 29.

LIGHTNING MARKETING GROUP, LLC, HOLLYWOOD,
FL:
3,178,072, INT. CL. 35.

LIGI INC., MISSISSAUGA, ONTARIO:
1,377,794, CANC. INT. CL. 3.

LIKEMINDS PRESS, INC., POWAY, CA:
3,177,056, PUB. 9-12-2006. MULTIPLE CLASS, INT. CLS.
16 AND 25.

LIMACORP LLC, CINCINNATI, OH:
3,177,858, INT. CL. 9.

LIMITED EDITIONS (PROPRIETARY) LIMITED, MID-
RAND, GAUTENG, SOUTH AFRICA, TA GLOMAIL:
2,309,628, CANC. INT. CL. 8.

LIMITED TOO, INC., COLUMBUS, OH:
2,309,924, CANC. INT. CL. 3.
2,309,942, CANC. INT. CL. 3.

LIN PAC, INC., MARIETTA, GA:
2,379,295, CANC. INT. CL. 16.

LIN, GERARD, LOS GATOS, CA:
3,177,022, PUB. 9-12-2006. INT. CL. 35.
3,177,023, PUB. 9-12-2006. INT. CL. 35.
3,177,024, PUB. 9-12-2006. INT. CL. 35.
3,177,025, PUB. 9-12-2006. INT. CL. 42.
3,177,026, PUB. 9-12-2006. INT. CL. 42.
3,177,027, PUB. 9-12-2006. INT. CL. 35.

LIN, XUANDONG, TEMPLE CITY, CA:
3,175,804, PUB. 9-12-2006. INT. CL. 11.

LINCARE LICENSING INC., CLEARWATER, FL:
3,175,978, PUB. 9-12-2006. INT. CL. 44.

LINCOLN GLOBAL, INC., MONTEREY PARK, CA, LIN-
COLN ELECTRIC COMPANY, THE, CLEVELAND, OH:
1,991,800. REN. 10-26-06. INT. CL. 9.

LINCOLN, JIMY, SMYRNA, GA:
2,308,674, CANC. INT. CL. 25.

LINDSTROM & MCKENNEY, INC., CHESTERFIELD, MO:
3,177,464, INT. CL. 35.

LINDY PROMOTIONS INC., BETHESDA, MD:
1,947,940, CANC. INT. CL. 21.

LINK SNACKS, INC., MINONG, WI:
3,178,206, INT. CL. 25.

LINK 51 LIMITED, TELFORD, SHROPSHIRE, TF7 4LN,
ENGLAND:
1,377,883, CANC. INT. CL. 7.

LINSPIRE, INC., SAN DIEGO, CA:
3,176,492, PUB. 5-23-2006. INT. CL. 9.

LINX CORP., GREAT FALLS, VA:
2,309,379, CANC. INT. CL. 16.

LION INC., THE, WILKES-BARRE, PA TO LION BREWERY,
INC., THE, WILKES-BARRE, PA:
1,948,518, CANC. INT. CL. 32.

LION, INC., SEATTLE, WA:
2,308,714, CANC. INT. CL. 9.

LIONBRIDGE TECHNOLOGIES, INC., WALTHAM, MA:
3,178,354, INT. CL. 41.

LIPKKE, LIZABETH, MERCER ISLAND, WA, DBA LIZA-
BETH PIG PRODUCTIONS:
1,378,279, CANC. INT. CL. 28.

LIQUID ASSETS, INC., DENVER, CO:
3,175,859, PUB. 9-12-2006. INT. CL. 32.

LIQUILITE, LLC, ARLINGTON HEIGHTS, IL:
3,177,429, INT. CL. 21.

LIQUOR BARN # 3, LLC., LEXINGTON, KY:
3,177,570, INT. CL. 33.

LISA FRANK, INC., TUCSON, AZ:
2,309,344, CANC. INT. CL. 16.

LIST INDUSTRIES INC., DEERFIELD BEACH, FL:
2,308,292, CANC. INT. CL. 20.

LISTENING PARTNERS, LLC, AUSTIN, TX:
3,176,723, PUB. 9-12-2006. INT. CL. 36.

LITTLE GIANT PUMP COMPANY, OKLAHOMA CITY, OK:
2,309,689, CANC. INT. CL. 11.

LITTLE SKOOKUM SHELLFISH GROWERS, LLC, SHEL-
TON, WA:
3,175,821, PUB. 9-12-2006. INT. CL. 31.

LITTLE THINGS, LLC, ENCINO, CA:
3,176,549, PUB. 9-12-2006. INT. CL. 3.

LMT ENTERPRISES, LLC, KANSAS CITY, MO:
3,177,495, INT. CL. 9.

LO, WAYNE C., CAMPBELL, CA:
3,178,249, INT. CL. 9.

LOBAR, INC., OAK PARK, MI:
2,309,890, CANC. INT. CL. 2.

LOCALVIEWFINDER COM LLC, FLEMINGTON, NJ:
3,176,619, PUB. 9-12-2006. INT. CL. 41.

LOCKE, SHEILA, REDMOND, WA AND HOANG, TUAN-
HAI, REDMOND, WA:
3,177,850, INT. CL. 30.

LOGGERHEAD CLUB & MARINA, LTD., JUNO BEACH,
FL:
3,175,937, PUB. 9-12-2006. MULTIPLE CLASS, INT. CLS.
25, 35, 39, 41 AND 43.

LOGIKONLINE INC., CHANDLER, AZ:
3,176,733, PUB. 9-12-2006. INT. CL. 9.
3,176,734, PUB. 9-12-2006. INT. CL. 9.

LOGILITY, INC., ATLANTA, GA:
1,382,889. REN. 10-25-06. INT. CL. 35.

LOGISTICS UNLIMITED, COSTA MESA, CA:
3,176,757, PUB. 9-12-2006. INT. CL. 39.

LOGOTEL LLC, SAN FRANCISCO, CA:
3,177,576, INT. CL. 25.

LOLLY TOGS, LTD., NEW YORK, NY:
2,309,557, CANC. INT. CL. 25.

LONG & FOSTER COMPANIES, INC., THE, FAIRFAX, VA:
2,309,225, CANC. INT. CL. 36.

LONG FENCE COMPANY, INC., RIVERDALE, MD:
3,176,311, PUB. 9-12-2006. INT. CL. 37.

- LONG HUEI HELMET CO., YUNG KANG CITY, TAINAN, TAIWAN:
3,177,472, INT. CL. 9.
- LONG SHADOWS VINTNERS LLC, SEATTLE, WA:
3,176,931, PUB. 9-12-2006. INT. CL. 35.
- LOPEZ, ERIBERTO CANDELARIO, ZAPOPAN JALISCO, MEXICO:
3,177,414, INT. CL. 30.
- LORIA, STEVE, V., LOS ANGELES, CA:
3,178,760, INT. CL. 25.
- LORIVA SUPREME FOODS, INC., HAPPAUGUE, NY:
2,309,560, CANC. INT. CL. 29.
- LOUGHLIN, BRIAN P., EAST NORTHPORT, NY:
3,177,968, INT. CL. 37.
- LOUIE BERNARD, INC., LOS ANGELES, CA:
1,378,221, CANC. INT. CL. 25.
- LOVE & PRIDE, LLC, PHILADELPHIA, PA:
3,178,319, INT. CL. 35.
3,178,326, INT. CL. 14.
- LOVE CONTROLS CORPORATION, WHEELING, IL:
1,377,945, CANC. INT. CL. 9.
- LOVELAND INDUSTRIES, INC., GREELEY, CO:
1,947,908, CANC. MULTIPLE CLASS, INT. CLS. 1 AND 31.
- LOWRANCE ELECTRONICS, INC., TULSA, OK:
3,177,504, INT. CL. 9.
- LRC NORTH AMERICA, INC., SARASOTA, FL:
2,309,207, CANC. INT. CL. 10.
- LU, XI, ARLINGTON, VA:
3,176,085, PUB. 9-12-2006. INT. CL. 35.
- LUCAS INDUSTRIES PUBLIC LIMITED COMPANY, BIRMINGHAM, ENGLAND:
1,377,891, CANC. INT. CL. 7.
- LUCESCO LIGHTING, INC., PALO ALTO, CA:
3,178,077, INT. CL. 11.
- LUCITE INTERNATIONAL, INC., CORDOVA, TN, E. I. DU PONT DE NEMOURS AND COMPANY, WILMINGTON, DE:
1,047,685, REN. 10-20-06. INT. CL. 17.
- LUCZYK, PAUL A., MUKILTEO, WA:
3,177,640, INT. CL. 16.
- LUMPASUGAR, LLC, MEMPHIS, TN:
2,309,071, CANC. INT. CL. 25.
- LUND INTERNATIONAL, INC., ANOKA, MN:
3,177,659, INT. CL. 12.
- LURIE COMPANY, THE, SAN FRANCISCO, CA:
2,309,556, CANC. MULTIPLE CLASS, INT. CLS. 21 AND 25.
- LUXCO, INC., ST. LOUIS, MO:
828,315, REN. 10-23-06. U.S. CL. 49 (INT. CL. 33).
829,219, REN. 10-23-06. U.S. CL. 47 (INT. CL. 33).
- LUXOTTICA S.R.L., AGORDO (BELLUNO) 32021, ITALY, COOPERVISION, INC., MENLO PARK, CA:
1,406,608, REN. 10-23-06. INT. CL. 9.
- LUXOTTICA S.R.L., AGORDO (BELLUNO) 32021, ITALY, BAUSCH & LOMB INCORPORATED, ROCHESTER, NY:
1,996,106, REN. 10-23-06. INT. CL. 9.
- LWIN FAMILY CO., CHARLOTTE, NC, DBA HISSHO SUSHI:
3,177,009, PUB. 9-12-2006. INT. CL. 43.
- LY, HUNG QUANG, PALMDALE, CA:
3,177,679, INT. CL. 3.
- LYNDEN INCORPORATED, SEATTLE, WA:
3,175,973, PUB. 9-12-2006. MULTIPLE CLASS, INT. CLS. 35, 36 AND 39.
- LYNX ENTERPRISES, INC., NASHUA, NH:
1,949,742, CANC. INT. CL. 17.
- LYONS GROUP, LTD., BOSTON, MA:
3,178,144, INT. CL. 43.
- M & C TOY CENTRE LTD., TSIMSHATSUI EAST, KOWLOON, HONG KONG:
2,309,941, CANC. INT. CL. 28.
- M GROUP, INC., MANITOWOC, WI:
3,178,450, INT. CL. 16.
- M. ARTHUR GENSLER JR. & ASSOCIATES, INC., SAN FRANCISCO, CA:
2,066,221, REN. 10-25-06. INT. CL. 9.
- M.D. INTENSIVE, COSTA MESA, CA:
3,178,477, INT. CL. 3.
- M.G.A., INC., DOTHAN, AL TO M.G.A., INC., DOTHAN, AL:
1,949,194, CANC. MULTIPLE CLASS, INT. CLS. 41 AND 42.
- M&FC HOLDING, LLC, WILMINGTON, DE:
2,308,548, CANC. INT. CL. 9.
- M-C INDUSTRIES, INC., TOPEKA, KS TO PRECISION DYNAMICS CORPORATION, SAN FERNANDO, CA:
1,948,249, CANC. INT. CL. 20.
- M-I L.L.C., HOUSTON, TX:
3,176,164, PUB. 9-12-2006. INT. CL. 6.
- MAAX CANADA INC., MONTREAL, CANADA:
3,177,185, PUB. 9-12-2006. INT. CL. 11.
- MAC BAREN FINANCIAL, LLC, ST. PETERSBURG, FL:
3,178,509, INT. CL. 36.
- MACCONOCHIE, KATHARINE, BROOMFIELD, CO, DBA KATBOX PRODUCTIONS:
3,177,470, INT. CL. 42.
- MACHO PRODUCTS, INC., SEBASTIAN, FL:
2,397,008, CANC. INT. CL. 20.
- MACK TRUCKS, INC., ALLENTOWN, PA:
1,046,406, REN. 10-25-06. MULTIPLE CLASS, INT. CLS. 24 AND 25.
- MACKAY, DALE V., VICTORIA, AUSTRALIA:
3,177,340, INT. CL. 10.
- MACKWOODS LIMITED, COLOMBO 8, SRI LANKA:
3,175,955, PUB. 1-10-2006. MULTIPLE CLASS, INT. CLS. 5, 30, 35 AND 42.
- MACLAUGHLAN, TODD, GRAYSLAKE, IL:
2,309,206, CANC. INT. CL. 16.
- MADDEN, MARSHALL, SPRINGFIELD, MO:
3,176,566, PUB. 9-12-2006. INT. CL. 28.
- MADISON FINANCIAL PARTNERS, LLC, DENVER, CO:
3,176,293, PUB. 9-12-2006. INT. CL. 36.
- MAGGIORE, JOSEPH P, CARLSBAD, CA:
3,178,024, INT. CL. 43.
- MAGICOM DISTRIBUTING CORP., NANAIMO, BRITISH COLUMBIA, CANADA:
2,308,372, CANC. INT. CL. 9.
- MAGIQ TECHNOLOGIES, INC., NEW YORK, NY:
3,177,733, INT. CL. 9.
- MAGNANI & MCCORMICK, INC., ENFIELD, CT:
2,308,549, CANC. INT. CL. 42.
- MAGUIRE, JERROD J., PHOENIX, AZ:
3,178,623, INT. CL. 41.
- MAHAR MANUFACTURING CORP., VERNON, CA, DBA FIESTA CONCESSION CORP.:
2,002,973, REN. 10-26-06. INT. CL. 28.
- MAHARISHI AYUR-VED PRODUCTS INTERNATIONAL, INC., COLORADO SPRINGS, CO:
3,176,515, PUB. 9-12-2006. INT. CL. 5.
3,176,596, PUB. 9-12-2006. INT. CL. 5.
- MAHÉ FREIGHT A/S, KASTRUP, DENMARK:
3,178,037, INT. CL. 39.
- MAIDCOR LLC, GREEN BAY, WI:
3,178,560, INT. CL. 37.
- MAINEHEALTH, PORTLAND, ME:
3,176,271, PUB. 9-12-2006. INT. CL. 44.
- MAINSTREAM ADVERTISING, INC., WOODLAND HILLS, CA:
3,176,946, PUB. 9-12-2006. INT. CL. 42.
3,177,152, PUB. 9-12-2006. MULTIPLE CLASS, INT. CLS. 38 AND 42.
- MAJOR MOTION SPORTSWEAR, NORTH HOLLYWOOD, CA:
2,308,147, CANC. INT. CL. 25.
- MAJORMAGIC HOLDINGS, LP, COMMERCE, CA:
3,178,673, INT. CL. 25.
- MAJZLER, GIANNA, FOUNTAIN VALLEY, CA:
2,309,954, CANC. INT. CL. 3.
- MAKERS USA, INC., LOS ANGELES, CA:
3,176,037, PUB. 9-12-2006. INT. CL. 25.
- MAKING MEMORIES WHOLESALE, INC., CENTERVILLE, UT:
3,175,962, PUB. 9-12-2006. MULTIPLE CLASS, INT. CLS. 8 AND 16.

MALDONADO, JOSE A, MIAMI, FL:
3,176,069, PUB. 9-12-2006. INT. CL. 12.

MALEK, S. SHANE, LAS VEGAS, NV:
3,176,722, PUB. 9-12-2006. INT. CL. 5.

MALLINCKRODT BAKER, INC., ST. LOUIS, MO:
1,045,185. REN. 10-25-06. INT. CL. 1.

MALOUF, ROBERT, NORTH MIAMI, FL:
3,176,586, PUB. 9-12-2006. INT. CL. 28.

MALT-O-MEAL COMPANY, MINNEAPOLIS, MN:
2,046,550. REN. 10-26-06. INT. CL. 30.

MANA PRODUCTS, INC., LONG ISLAND CITY, NY:
2,309,309, CANC. INT. CL. 3.
2,309,310, CANC. INT. CL. 3.
2,309,311, CANC. INT. CL. 3.
2,309,313, CANC. INT. CL. 3.

MANAGEMENT COMPUTER CONTROLS, INC., MEMPHIS, TN:
1,365,278. REN. 10-23-06. MULTIPLE CLASS, INT. CLS. 9 AND 16.
1,365,278, CANC. MULTIPLE CLASS, INT. CLS. 35 AND 42.

MANAN MEDICAL PRODUCTS, INC., WHEELING, IL:
3,176,575, PUB. 9-12-2006. INT. CL. 10.

MANDF FOODS LLC, STONE MOUNTAIN, GA:
3,176,219, PUB. 9-12-2006. MULTIPLE CLASS, INT. CLS. 29 AND 30.

MANHATTAN SKYLINE MANAGEMENT CORP., NEW YORK, NY:
2,807,001, COR. MULTIPLE CLASS, INT. CLS. 35 AND 36.

MANHEIM AUCTIONS, INC., ATLANTA, GA:
3,178,535, INT. CL. 35.
3,178,569, INT. CL. 35.

MANNING & NAPIER ADVISORS, INC., ROCHESTER, NY:
2,309,473, CANC. INT. CL. 16.

MANSFIELD, JOHN, PLACENTIA, CA:
3,178,202, INT. CL. 25.

MANTC HOLDINGS PTY LTD, DONVALE, AUSTRALIA:
3,176,401, PUB. 9-12-2006. INT. CL. 12.

MANUFACTURERS HANOVER TRUST COMPANY, NEW YORK, NY:
1,378,405, CANC. INT. CL. 36.
1,378,406, CANC. INT. CL. 36.

MAPLE DONUTS, INC., YORK, PA:
1,948,595, CANC. INT. CL. 30.

MAPLE LEAF SPORTS & ENTERTAINMENT, LTD., TORONTO, ONTARIO, CANADA:
3,177,650, INT. CL. 18.

MAPLES & COMPANY, INC., TUCSON, AZ:
3,176,820, PUB. 9-12-2006. INT. CL. 32.

MARAHON U.S.A., SOUTH JORDAN, UT:
3,177,971, INT. CL. 18.

MARCH ISLAND COMPANY, GREAT FALLS, VA:
3,176,227, PUB. 9-12-2006. INT. CL. 35.

MARCH, BARBARA, WESTLAKE VILLAGE, CA:
3,177,899, INT. CL. 25.

MARIA DUVAL, FRANCE:
3,177,271, PUB. 9-12-2006. MULTIPLE CLASS, INT. CLS. 35 AND 45.

MARICHEM MARIGASES HELLAS LTD., PIRAEUS, GREECE:
3,176,213, PUB. 9-12-2006. MULTIPLE CLASS, INT. CLS. 1, 2 AND 3.

MARIGNY CORPORATION, THE, WILMINGTON, DE:
3,175,765, PUB. 9-12-2006. INT. CL. 30.

MARK I ENTERPRISES, TOWSON, MD:
3,177,963, INT. CL. 35.

MARK LEMP FOOTWEAR, ST. LOUIS, MO:
3,177,422, INT. CL. 25.
3,178,410, INT. CL. 25.
3,178,411, INT. CL. 25.

MARK R. JUNG D. D. S., P. C., FARGO, ND:
3,177,000, PUB. 9-12-2006. INT. CL. 44.

MARK ROBERT BEESON, MANHATTAN BEACH, CA:
3,178,196, INT. CL. 42.

MARKET TRADERS INSTITUTE, INC., WINTER PARK, FL:
3,178,811, INT. CL. 41.

MARKETING SYSTEMS OF AMERICA, INC., WEST PALM BEACH, FL:
1,949,337, CANC. INT. CL. 35.

MARKETVISION DIRECT, INC., BOSTON, MA:
2,309,897, CANC. INT. CL. 9.

MARKET2CUSTOMER LLC, CAMBRIDGE, MA:
3,176,864, PUB. 9-12-2006. INT. CL. 35.

MARKON COOPERATIVE, INC., SALINAS, CA:
1,410,925. REN. 10-25-06. INT. CL. 42.

MARKWINS BEAUTY PRODUCTS, INC., CITY OF INDUSTRY, CA:
1,403,699, REN. 10-20-06. INT. CL. 3.
3,178,065, INT. CL. 3.
3,178,442, INT. CL. 3.

MARLIN FIRE ARMS COMPANY, THE, NORTH HAVEN, CT:
55,158. REN. 10-24-06. U.S. CL. 9 (INT. CL. 13).

MARMCO PROPERTIES, LLC, SCOTTSDALE, AZ:
3,178,099, INT. CL. 35.

MARS, INCORPORATED, MCLEAN, VA:
2,005,935. REN. 10-26-06. INT. CL. 30.
2,011,826. REN. 10-26-06. INT. CL. 30.
3,177,432, INT. CL. 30.
3,177,483, INT. CL. 25.
3,178,617, INT. CL. 30.

MARS, INCORPORATED, NEW YORK, NY:
3,178,667, INT. CL. 11.

MARSH USA INC, NEW YORK, NY:
2,309,633, CANC. INT. CL. 36.

MARSH USA INC., NEW YORK, NY:
3,178,679, INT. CL. 36.

MARSHALL, ROGER, NASHVILLE, TN:
3,176,941, PUB. 9-12-2006. INT. CL. 41.

MARSIN MEDICAL INTERNATIONAL, INC., PHILADELPHIA, PA:
2,309,502, CANC. INT. CL. 21.

MARTINEZ, DAVID, DURHAM, NC:
3,176,025, PUB. 9-12-2006. INT. CL. 41.

MARTINEZ, KAREN, BELTON, TX:
3,176,087, PUB. 9-12-2006. INT. CL. 43.

MARTINI & ROSSI S.P.A., 10123 TORINO, ITALY TO BACARDI & COMPANY LIMITED, NASSAU, NEW PROVIDENCE, BAHAMAS:
1,948,200, CANC. INT. CL. 33.

MARWITZ, HANS-JOACHIM, BERLIN, FED REP GERMANY:
3,176,863, PUB. 9-12-2006. INT. CL. 9.

MARX, ROSEMARIE, ATLANTA, GA:
2,024,388. REN. 10-26-06. INT. CL. 9.

MAS LA CHEVALIERE, FRANCE:
3,177,219, PUB. 9-12-2006. INT. CL. 33.

MASCO CORPORATION OF INDIANA, INDIANAPOLIS, IN:
3,178,171, INT. CL. 11.

MASHELL TELECOM, INC., EATONVILLE, WA:
3,176,898, PUB. 9-12-2006. INT. CL. 38.
3,177,128, PUB. 9-12-2006. INT. CL. 38.

MASKED MARVEL GOALIE HELMETS, LLC, NOVI, MI:
3,177,817, INT. CL. 9.

MASQUE PUBLISHING, INC., ENGLEWOOD, CO:
2,308,375, CANC. INT. CL. 9.

MAST - PETERS, LLC, DALLAS, TX:
3,176,781, PUB. 9-12-2006. INT. CL. 4.

MAST-JÄGERMEISTER AG, FED REP GERMANY:
3,177,281, PUB. 9-12-2006. MULTIPLE CLASS, INT. CLS. 32 AND 33.

MASTER CUTLERY, INC, SECAUCUS, NJ:
3,176,606, PUB. 9-12-2006. INT. CL. 8.

MASTER FINANCIAL, INC., ORANGE, CA:
2,308,401, CANC. INT. CL. 36.

MASTER MFG. CO., INC., CLEVELAND, OH, DBA MASTER CASTER COMPANY:
2,310,094, CANC. INT. CL. 20.

MASTER TEACHER, INC., THE, MANHATTAN, KS:
2,385,617, AM. INT. CL. 16.

MASTER-BREW BEVERAGES, INC., NORTHBROOK, IL:
1,445,712. REN. 10-25-06. INT. CL. 42.

- MASTERBRAND CABINETS, INC., JASPER, IN:
3,178,193, INT. CL. 20.
- MASTERCARD INTERNATIONAL INCORPORATED, PURCHASE, NY:
2,309,919, CANC. MULTIPLE CLASS, INT. CLS. 35 AND 36.
- MASTERCHEM INDUSTRIES LLC, IMPERIAL, MO:
3,177,760, MULTIPLE CLASS, INT. CLS. 1, 2 AND 3.
3,177,761, MULTIPLE CLASS, INT. CLS. 1, 2 AND 3.
- MASTERMARK COMPANIES, LLC, SANTA BARBARA, CA:
3,176,408, PUB. 9-12-2006. MULTIPLE CLASS, INT. CLS. 35 AND 38.
- MASTERS OF POKER LLC, SANTA MONICA, CA:
3,177,856, INT. CL. 41.
- MATCH.COM, L.P., DALLAS, TX, ELECTRIC CLASSIFIERS, INC., SAN FRANCISCO, CA:
2,088,545. REN. 10-26-06. INT. CL. 42.
- MATHEMATICAL TECHNOLOGIES INC., PROVIDENCE, RI:
2,309,839, CANC. INT. CL. 9.
- MATHENY, RICHARD K., HUNTINGTON BEACH, CA:
3,176,275, PUB. 9-12-2006. INT. CL. 38.
- MATHIS, STEPHEN M., ATLANTA, GA:
1,991,992. REN. 10-26-06. INT. CL. 42.
- MATIERE MARCEL, FRANCE:
3,177,221, PUB. 9-12-2006. INT. CL. 19.
- MATILDA BAY BREWING CO. LIMITED, WESTERN AUSTRALIA 6159, AUSTRALIA:
2,308,777, CANC. INT. CL. 32.
- MATTEL, INC., EL SEGUNDO, CA, MATTEL, INC., HAWTHORNE, CA:
810,106. REN. 10-24-06. U.S. CL. 22 (INT. CL. 28).
- MATTEL, INC., HAWTHORNE, CA TO MATTEL, INC., EL SEGUNDO, CA:
814,995, CANC. U.S. CL. 37.
- MATTEL, INC., EL SEGUNDO, CA:
2,309,697, CANC. INT. CL. 28.
2,310,070, CANC. INT. CL. 28.
3,176,331, PUB. 9-12-2006. INT. CL. 28.
3,176,344, PUB. 9-12-2006. INT. CL. 28.
3,176,361, PUB. 9-12-2006. INT. CL. 28.
3,176,405, PUB. 9-12-2006. INT. CL. 28.
3,176,406, PUB. 9-12-2006. INT. CL. 28.
3,176,407, PUB. 9-12-2006. INT. CL. 28.
3,176,420, PUB. 9-12-2006. INT. CL. 28.
3,176,435, PUB. 9-12-2006. INT. CL. 28.
3,176,441, PUB. 9-12-2006. INT. CL. 28.
3,176,444, PUB. 9-12-2006. INT. CL. 28.
3,177,720, INT. CL. 28.
3,177,764, INT. CL. 28.
3,177,765, INT. CL. 35.
3,178,056, INT. CL. 28.
3,178,059, INT. CL. 28.
- MATTHEWS, RAYMOND, G., SANDY, UT:
3,177,020, PUB. 9-12-2006. INT. CL. 42.
- MATTLE, INC., EL SEGUNDO, CA:
2,308,667, CANC. INT. CL. 28.
- MATTRESS DISCOUNTERS CORPORATION, UPPER MARLBORO, MD:
2,309,922, CANC. INT. CL. 20.
2,309,965, CANC. INT. CL. 20.
- MATTRESS WAREHOUSE, INC., FREDERICK, MD:
3,177,792, INT. CL. 35.
- MAUI TOYS, INC., YOUNGSTOWN, OH:
3,178,340, INT. CL. 28.
- MAVERICK CO PTY LTD, PORT MELBOURNE, AUSTRALIA:
3,176,043, PUB. 9-12-2006. INT. CL. 25.
- MAVERICK INTERNATIONAL IMPORT/EXPORT GROUP, INC., BOHEMIA, NY:
3,176,100, PUB. 9-12-2006. MULTIPLE CLASS, INT. CLS. 35 AND 37.
- MAX ROHR, INC., WILMINGTON, DE:
3,177,431, INT. CL. 34.
- MAXFIELD CANDY COMPANY, SALT LAKE CITY, UT:
3,176,674, PUB. 9-12-2006. INT. CL. 30.
- MAXI-AIDS, INC., FARMINGDALE, NY:
3,176,681, PUB. 9-12-2006. INT. CL. 35.
3,176,704, PUB. 9-12-2006. INT. CL. 35.
- MAXILAND TECHNOLOGY INC., WALNUT, CA:
2,309,250, CANC. INT. CL. 9.
- MAXXIS GROUP, INC., TUCKER, GA:
2,309,441, CANC. INT. CL. 3.
2,309,442, CANC. INT. CL. 3.
2,309,443, CANC. INT. CL. 3.
- MAYTAG CORPORATION, NEWTON, IA:
2,308,909, CANC. MULTIPLE CLASS, INT. CLS. 7 AND 11.
- MAYVILLE PRODUCTS CORPORATION, MAYVILLE, WI:
3,177,757, INT. CL. 9.
- MAZZA, JOHN G., MALIBU, CA:
3,176,339, PUB. 9-12-2006. INT. CL. 25.
- MC PERSON S.P.A., 33084 CORDENONS, PN, ITALY:
3,177,402, INT. CL. 9.
- MCANDREWS-KING PONTIAC-BUICK-GMC TRUCK, INC., ADAMS, MA:
2,309,107, CANC. MULTIPLE CLASS, INT. CLS. 35 AND 37.
- MCAULIFFE PAPER, INC., LIVERPOOL, NY:
3,177,947, INT. CL. 16.
- MCBRIDE, KEVIN, FULLERTON, CA:
3,177,489, INT. CL. 35.
- MCC MAGAZINES, LLC, AUGUSTA, GA:
3,176,007, PUB. 9-12-2006. INT. CL. 16.
3,177,189, PUB. 9-12-2006. INT. CL. 41.
- MCCAIN FOODS USA, INC., LISLE, IL:
2,324,368, CANC. INT. CL. 29.
- MCCALL, MARY, CHICAGO, IL, DBA MARY MCCALL EVENTS:
1,947,911, CANC. INT. CL. 36.
- MCCARTHY, FRANK J., PONTE VEDRA BEACH, FL:
2,309,279, CANC. INT. CL. 9.
- MCCLATCHY MANAGEMENT SERVICES, INC., SACRAMENTO, CA:
3,175,886, PUB. 9-12-2006. INT. CL. 16.
- MCCORMICK & COMPANY, INCORPORATED, SPARKS, MD TO MCCORMICK DELAWARE, INC., WILMINGTON, DE:
1,949,443, CANC. MULTIPLE CLASS, INT. CLS. 29 AND 30.
- MCCORMICK AUSTIN HOLT, BURLINGTON, NC, DBA THE AUSTIN HOLT COMPANY:
2,308,499, CANC. INT. CL. 35.
- MCCUE CORPORATION, SALEM, MA:
3,177,699, MULTIPLE CLASS, INT. CLS. 6, 12 AND 20.
- MCDERMOTT INCORPORATED, HOUSTON, TX:
2,005,280. REN. 10-26-06. INT. CL. 35.
2,011,082. REN. 10-26-06. INT. CL. 37.
- MCDONALD'S CORPORATION, OAK BROOK, IL:
1,378,430, CANC. INT. CL. 36.
1,378,496, CANC. INT. CL. 41.
1,378,521, CANC. INT. CL. 42.
1,418,655. REN. 10-20-06. INT. CL. 39.
- MCDONNELL DOUGLAS HELICOPTER COMPANY, MESA, AZ:
2,309,553, CANC. INT. CL. 12.
- MCDONNELL, ANNA, SANTA MONICA, CA:
2,309,996, CANC. INT. CL. 16.
- MCELROY, WILLIAM D., WATERFORD, MI:
2,308,524, CANC. INT. CL. 25.
- MCGRAW-HILL COMPANIES, INC., THE, NEW YORK, NY:
2,308,496, CANC. INT. CL. 9.
- MCGUIRE BEARING COMPANY, PORTLAND, OR:
3,177,662, INT. CL. 7.
- MCKESSON CORPORATION, SAN FRANCISCO, CA:
3,176,639, PUB. 9-12-2006. INT. CL. 35.
- MCLAUGHLIN, ROBERT H., PHILADELPHIA, PA:
3,178,821, INT. CL. 41.
- MCLEARN, SHARON, ORLANDO, FL:
3,178,362, INT. CL. 36.
3,178,363, INT. CL. 36.
- MCLEODUSA HOLDINGS, INC., CEDAR RAPIDS, IA:
3,177,880, INT. CL. 42.

MCMURRY PUBLISHING, PHOENIX, AZ:
2,309,420, CANC. INT. CL. 16.

ME, L.L.C., MANHATTAN BEACH, CA, DBA MEG:
3,177,415, INT. CL. 28.

MEAD CORPORATION, THE, DAYTON, OH:
1,378,663, CANC. INT. CL. 16.
2,309,343, CANC. INT. CL. 16.

MEADE, MILLICENT, STINSON BEACH, CA:
3,176,667, PUB. 9-12-2006. INT. CL. 35.

MEADWESTVACO PACKAGING SYSTEMS, LLC, STAMFORD, CT:
3,176,231, PUB. 9-12-2006. INT. CL. 9.

MEALS AND MENU MAGIC, INC., SHORELINE, WA:
3,176,128, PUB. 9-12-2006. INT. CL. 44.

MEARTHANE PRODUCTS CORPORATION, CRANSTON, RI:
3,176,779, PUB. 9-12-2006. INT. CL. 41.

MECO CORPORATION, GREENEVILLE, TN:
3,177,510, INT. CL. 11.
3,177,530, INT. CL. 11.

MED-INTERLINK, L.L.C., ST. LOUIS, MO:
2,308,191, CANC. INT. CL. 42.

MEDALIA, JIM, KINGSTON, NJ, FORMERLY JUSTBALLS, INC.:
2,309,087, CANC. INT. CL. 35.

MEDASSIS, INC, CHICAGO, IL:
3,176,691, PUB. 9-12-2006. INT. CL. 42.

MEDIA DUPLICATION SERVICES, INC., RICHARDSON, TX TO 4D TECHNOLOGIES, INC., PLANO, TX:
1,949,205, CANC. INT. CL. 40.

MEDIA RESOURCES, LTD., CANTON, OH:
3,176,329, PUB. 9-12-2006. INT. CL. 35.

MEDIA SPEEDWAY, SAN DIEGO, CA:
3,176,699, PUB. 9-12-2006. INT. CL. 38.

MEDIA/PROFESSIONAL INSURANCE, A DIVISION OF FINANCIAL & PROFESSIONAL RISK SOLUTIONS, INC., KANSAS CITY, MO, AON DIRECT GROUP, INC., TREVISO, PA:
1,951,143, REN. 10-25-06. INT. CL. 36.

MEDIAMARK RESEARCH INC., NEW YORK, NY:
1,996,689, REN. 10-20-06. INT. CL. 9.
1,999,621, REN. 10-20-06. INT. CL. 9.

MEDICAL ARTS PRESS, INC., BROOKLYN PARK, MN:
1,377,793, CANC. INT. CL. 3.

MEDICAL FOODS, INC., CAMBRIDGE, MA:
2,309,995, CANC. INT. CL. 5.

MEDICAL POSITIONING, INC., KANSAS CITY, MO:
3,176,162, PUB. 9-12-2006. INT. CL. 10.

MEDICAL STERILE PRODUCTS, INC., RINCON, PUERTO RICO TO SURGICAL SPECIALITIES PUERTO RICO, RINCON, PUERTO RICO:
1,949,158, CANC. INT. CL. 10.

MEDICIS PHARMACEUTICAL CORPORATION, SCOTTS-DALE, AZ:
3,178,331, INT. CL. 5.

MEDNIK WIPING MATERIALS CO., ST. LOUIS, MO:
2,044,703, REN. 10-26-06. INT. CL. 21.

MEDTRONIC, INC., MINNEAPOLIS, MN:
3,177,801, INT. CL. 10.
3,178,005, INT. CL. 10.
3,178,203, INT. CL. 10.
3,178,406, MULTIPLE CLASS, INT. CLS. 42 AND 44.

MEGADYNE MEDICAL PRODUCTS, INC., DRAPER, UT:
3,176,287, PUB. 9-12-2006. INT. CL. 10.
3,178,158, INT. CL. 10.

MEIERS, JAMES F., HOBOKEN, NJ:
3,176,557, PUB. 9-12-2006. INT. CL. 43.

MEIJER, INC., GRAND RAPIDS, MI:
1,453,157, CANC. INT. CL. 14.

MEILIN COSMETICS CO., LTD., TAINAN, TAIWAN:
1,377,814, CANC. INT. CL. 3.

MELART JEWELERS, INC., THE, SILVER SPRING, MD:
1,563,957, CANC. INT. CL. 42.

MELCO WIRE PRODUCTS COMPANY, GLENDALE, CA:
2,309,237, CANC. INT. CL. 20.

MELISSA DATA CORP., SANTA RANCHO MARGARITA, CA:
2,459,640, AM. INT. CL. 9.

MELYX, INC., CORDOVA, IL, DBA XYLEM, LTD.:
2,309,330, CANC. INT. CL. 16.

MEME DELRAY BEACH, LLC., DELRAY BEACH, FL:
3,176,169, PUB. 9-12-2006. INT. CL. 44.

MEMON, JAVED I., YARDLEY, PA:
3,176,353, PUB. 9-12-2006. INT. CL. 25.

MEMORIAL CITY MALL, L.P, HOUSTON, TX:
3,176,042, PUB. 9-12-2006. INT. CL. 36.

MEMORY JUNCTION ~ SCRAPBOOK HEADQUARTERS, LLC, WAUKESHA, WI:
3,175,976, PUB. 9-12-2006. INT. CL. 35.

MEMPHIS CONTRACT PACKAGING, INC., SOMERVILLE, TN:
3,178,162, INT. CL. 3.

MENCOBONI FOODS, INC., FRAMINGHAM, MA:
3,178,536, INT. CL. 30.

MENDIVE, SUSIE, NEW YORK, NY:
3,178,064, INT. CL. 42.

MENDOCINO WINE GROUP, UKIAH, CA:
3,178,341, INT. CL. 33.

MENG, YAP TAT, JOHOR, MALAYSIA:
3,177,115, PUB. 9-12-2006. INT. CL. 25.

MENPER DISTRIBUTORS INC., MIAMI, FL:
3,176,176, PUB. 9-12-2006. INT. CL. 5.

MERCANTILE BANKSHARES CORPORATION, BALTIMORE, MD:
3,177,441, INT. CL. 36.
3,177,442, INT. CL. 36.
3,177,443, INT. CL. 36.

MERCK & CO., INC., WHITEHOUSE STATION, NJ:
2,063,701, REN. 10-25-06. INT. CL. 5.

MERCURY AIRCRAFT, INC., HAMMONDSPORT, NY:
1,404,367, REN. 10-23-06. INT. CL. 37.

MERCURY HOCKEY INCORPORATED, MCKEES ROCKS, PA:
3,177,323, INT. CL. 28.

MERCURY INTERNATIONAL TRADING CORPORATION, NORTH ATTLEBORO, MA:
1,947,858, CANC. INT. CL. 25.

MEREDITH CORPORATION, DES MOINES, IA:
1,987,360, REN. 10-26-06. INT. CL. 6.
1,987,361, REN. 10-26-06. INT. CL. 6.
2,310,102, CANC. INT. CL. 16.
2,310,103, CANC. INT. CL. 16.

MERITAGE PORTFOLIO MANAGEMENT, INC., OVERLAND PARK, KS:
3,176,668, PUB. 9-12-2006. INT. CL. 36.

MERO, JIM, GOODRICH, MI AND SEWELL, LUKE, LINDEN, MI:
2,309,875, CANC. INT. CL. 25.

MERRICK TACKLE CENTER, INC., SHANDAKEN, NY:
3,175,822, PUB. 9-12-2006. INT. CL. 28.

MERRILL LYNCH & CO., INC., NEW YORK, NY:
1,378,401, CANC. INT. CL. 36.
3,175,851, PUB. 9-12-2006. INT. CL. 36.

MERRY CHANCE INDUSTRIES LTD., KOWLOON BAY, HONG KONG:
3,177,016, PUB. 9-12-2006. MULTIPLE CLASS, INT. CLS. 8 AND 21.

MERRYVALE VENTURE, ST. HELENA, CA, DBA MERRYVALE VINEYARDS:
1,949,737, CANC. INT. CL. 33.

MESIROW ADVANCED STRATEGIES, INC., CHICAGO, IL:
3,176,181, PUB. 9-12-2006. INT. CL. 36.

MESSER GROUP GMBH, SULZBACH, FED REP GERMANY:
3,175,966, PUB. 9-12-2006. INT. CL. 6.

MESTAS, LOUIS R., CLOVIS, NM:
2,309,855, CANC. INT. CL. 41.

METADOT CORPORATION, AUSTIN, TX:
3,176,371, PUB. 9-12-2006. INT. CL. 9.

METAGENICS, INC., SAN CLEMENTE, CA:
2,309,026, CANC. INT. CL. 5.
2,309,095, CANC. INT. CL. 5.
2,309,142, CANC. INT. CL. 5.

METAL ALLOY RECLAIMERS, INC. II, CLEVELAND, OH:
2,007,626, REN. 10-23-06. INT. CL. 36.

- METAL BUILDING COMPONENTS, L.P., HOUSTON, TX:
1,424,579. REN. 10-25-06. INT. CL. 6.
- METHODA COMPUTERS LTD., RAMAT GAN, ISRAEL:
3,175,943. PUB. 9-12-2006. INT. CL. 9.
- METRO INFECTIOUS DISEASE CONSULTANTS, L.L.C., HINSDALE, IL:
3,177,721. INT. CL. 44.
- METROHM LTD., 9100 HERISAU, SWITZERLAND:
2,308,400. CANC. INT. CL. 9.
- METROMEDIA STEAKHOUSES, INC., DAYTON, OH:
1,378,629. CANC. INT. CL. 42.
- METROPOLITAN ENTERTAINMENT CO., INC., THE, NEW YORK, NY:
2,308,591. CANC. INT. CL. 41.
- METROPOLITAN HOMES INC., DENVER, CO:
2,083,621. REN. 10-25-06. INT. CL. 37.
- METRUS GROUP, INC., SOMERVILLE, NJ:
3,177,499. INT. CL. 35.
- METSCH REFRACTORIES INC., CHESTER, WV:
1,369,008. REN. 10-26-06. INT. CL. 19.
1,369,009. REN. 10-23-06. INT. CL. 19.
- METSO PANELBOARD OY, FIN-15560 NASTOLA, FINLAND, SUNDS DEFIBRATOR PANELHANDLING OY, 15560 NASTOLA, FINLAND:
1,994,624. REN. 10-21-06. INT. CL. 7.
- MEUSSDORFER, JACK CHARLES, CLATSKAMIE, OR:
2,020,948. REN. 10-25-06. INT. CL. 15.
- MEZZA GLOBAL INC., NEW YORK, NY:
3,176,845. PUB. 9-12-2006. INT. CL. 25.
- MGA ENTERTAINMENT, INC., VAN NUYS, CA:
3,177,145. PUB. 9-12-2006. INT. CL. 28.
- MHC TT LEASING COMPANY, INC., CHICAGO, IL:
3,178,698. MULTIPLE CLASS, INT. CLS. 41 AND 43.
- MI WINDOWS AND DOORS, INC., GRATZ, PA:
3,177,494. MULTIPLE CLASS, INT. CLS. 35, 36 AND 37.
3,177,498. MULTIPLE CLASS, INT. CLS. 6 AND 19.
- MIAMI RUG COMPANY, MIAMI, FL:
1,378,530. CANC. INT. CL. 42.
- MIBRO PARTNERS, SCARBOROUGH, ONTARIO, CANADA:
3,177,802. INT. CL. 7.
- MICHAEL DEAN, SWITZERLAND:
3,177,290. PUB. 9-12-2006. MULTIPLE CLASS, INT. CLS. 6, 9 AND 20.
- MICHAEL M. HALPRIN, GRAND RAPIDS, MI:
1,408,242. REN. 10-23-06. INT. CL. 9.
- MICHAEL STARS, INC., HAWTHORNE, CA:
3,178,735. INT. CL. 3.
- MICHAELS OF OREGON CO., OVERLAND PARK, KS:
2,308,801. CANC. MULTIPLE CLASS, INT. CLS. 6, 9, 13 AND 21.
- MICHAUD, ALBERT O., SHERBORN, MA:
3,176,849. PUB. 9-12-2006. INT. CL. 31.
- MICHELIN NORTH AMERICA, INC, GREENVILLE, SC:
2,309,306. CANC. INT. CL. 12.
- MICHELIN NORTH AMERICA, INC., GREENVILLE, SC:
3,177,187. PUB. 9-12-2006. INT. CL. 37.
- MICHELIN RECHERCHE ET TECHNIQUE S.A., CH-1763 GRANGES-PACCOT, SWITZERLAND:
1,376,883. REN. 10-24-06. MULTIPLE CLASS, INT. CLS. 6, 8, 9, 11, 14, 16, 18, 20, 21, 24, 25, 26, 28 AND 34.
- MICHELLE L. COLLINS, INC., DALLAS, TX:
3,176,504. PUB. 9-12-2006. MULTIPLE CLASS, INT. CLS. 16 AND 35.
- MICHIGAN ECONOMIC DEVELOPMENT CORPORATION, LANSING, MI:
3,177,437. INT. CL. 35.
- MICROGENICS CORPORATION, FREEMONT, CA, DIAGNOSTIC REAGENTS, INC., SUNNYVALE, CA:
1,986,416. REN. 10-26-06. INT. CL. 5.
- MICROSEMI CORPORATION, SANTA ANA, CA:
3,177,332. INT. CL. 9.
- MICROSOFT CORPORATION, REDMOND, WA:
2,308,171. CANC. INT. CL. 9.
2,309,981. CANC. INT. CL. 9.
3,178,489. INT. CL. 36.
- MICROSTRATEGY INCORPORATED, MCLEAN, VA:
3,177,337. INT. CL. 38.
- MID-STATE SUBSTANCE ABUSE COMMISSION, CLARE, MI, DBA FACE TRUTH AND CLARITY ON ALCOHOL:
2,309,159. CANC. MULTIPLE CLASS, INT. CLS. 9 AND 16.
- MID-WEST METAL PRODUCTS COMPANY, INC., MUNCIE, IN:
1,406,456. REN. 10-25-06. INT. CL. 6.
- MIDAS PHARMA GMBH, FED REP GERMANY:
3,177,214. PUB. 9-12-2006. MULTIPLE CLASS, INT. CLS. 1, 3, 5, 35, 36, 40 AND 42.
- MIDORI CO., LTD., TOKYO 130, JAPAN:
1,378,795. REN. 10-24-06. INT. CL. 16.
1,378,795. CANC. MULTIPLE CLASS, INT. CLS. 6, 14, 18, 20, 21, 24, 25, 28 AND 34.
- MIDWAY AMUSEMENT GAMES, LLC, CHICAGO, IL, MIDWAY MANUFACTURING COMPANY, CHICAGO, IL:
1,977,925. REN. 10-24-06. MULTIPLE CLASS, INT. CLS. 16 AND 28.
- MIDWAY HOME ENTERTAINMENT INC., CHICAGO, IL:
3,178,263. INT. CL. 9.
- MIDWEST BANCORPORATION, INC., HOPKINS, MN:
2,309,797. CANC. INT. CL. 36.
- MIDWEST FRANCHISE-IOWA, LLC, OMAHA, NE:
3,177,071. PUB. 9-12-2006. INT. CL. 43.
- MIDWEST ORTHOPAEDICS, CHICAGO, IL:
1,948,793. CANC. INT. CL. 42.
- MIDWEST TOOL AND CUTLERY COMPANY, STURGIS, MI:
3,178,810. INT. CL. 8.
- MIDWEST TRUCK AND AUTO PARTS, INC., CHICAGO, IL:
1,404,815. REN. 10-25-06. INT. CL. 12.
- MIDWEST TURKEY HATCHERY, INC., DIKE, IA:
1,948,629. CANC. INT. CL. 29.
- MIELE, ROBERT C., DENVILLE, NJ:
3,177,375. INT. CL. 16.
- MIER COMUNICACIONES S.A., SPAIN:
3,177,262. PUB. 9-12-2006. INT. CL. 9.
- MIGUEL ANGEL IGLESIAS BALLESTER, SPAIN:
3,177,283. PUB. 9-12-2006. MULTIPLE CLASS, INT. CLS. 9 AND 19.
- MIKROS SYSTEMS CORPORATION, PRINCETON, NJ:
3,178,441. INT. CL. 9.
- MIKUNI GINKO, LTD., SACRAMENTO, CA:
3,176,475. PUB. 9-12-2006. INT. CL. 35.
- MILACRON INC., CINCINNATI, OH:
2,308,942. CANC. INT. CL. 7.
- MILES INC., ELKHART, IN TO BAYER CORPORATION, ELKHART, IN:
1,948,326. CANC. INT. CL. 9.
1,948,944. CANC. INT. CL. 35.
- MILLENNIUM GROUP, INC., PROVO, UT:
2,309,469. CANC. INT. CL. 29.
- MILLER, ANDREW, DAVID, BROOMFIELD, CO:
3,176,706. PUB. 9-12-2006. INT. CL. 36.
- MILLER, CHRISTOPHER W., LANCASTER, PA:
1,948,853. CANC. MULTIPLE CLASS, INT. CLS. 35, 41 AND 42.
- MILLER, DAVID, SAN FRANCISCO, CA:
3,176,093. PUB. 9-12-2006. MULTIPLE CLASS, INT. CLS. 35 AND 44.
- MILLER, JAMES PAUL, SAUSALITO, CA:
2,032,584. REN. 10-20-06. INT. CL. 3.
- MILLICAN, DEWITT T., TAMPA, FL:
3,175,931. PUB. 9-12-2006. INT. CL. 11.
- MILLIKEN & COMPANY, SPARTANBURG, SC:
3,177,874. INT. CL. 1.
- MILLIMAN USA, INC., SEATTLE, WA:
2,957,802. COR. INT. CL. 36.
- MILLIONAIRE UNIVERSITY, L.L.C., JACKSONVILLE, FL:
3,178,132. INT. CL. 41.
- MILLPOND MANAGEMENT CORPORATION, PANAMA 5, PANAMA:
1,948,019. CANC. INT. CL. 5.
- MILLS, JOHN W., COLUMBUS, KS, DBA CREATIVE ENGINEERING COMPANY:
1,377,892. CANC. INT. CL. 7.

MINDER, INC., DALLAS, TX:
3,177,779, INT. CL. 20.

MINELLI RENATO, ITALY:
3,177,301, PUB. 9-12-2006. INT. CL. 18.

MINKA LIGHTING, INC., CORONA, CA:
3,177,515, INT. CL. 11.

MINNESOTA BEST MAID COOKIE COMPANY, INC., RIVER FALLS, WI:
2,308,417, CANC. INT. CL. 35.

MINNESOTA BUILDING TRADES FEDERAL CREDIT UNION, MAPLE GROVE, MN:
3,176,692, PUB. 9-12-2006. INT. CL. 36.

MINNESOTA MINING AND MANUFACTURING COMPANY, ST. PAUL, MN:
1,377,970, CANC. INT. CL. 9.

MINTIE CORPORATION, LOS ANGELES, CA:
3,177,977, INT. CL. 37.

MINTZ, MARILYN D., LOS GATOS, CA:
1,992,948, REN. 10-21-06. MULTIPLE CLASS, INT. CLS. 9, 14, 16, 21, 24, 25 AND 28.

MIRAGE MARKETING, INC., SEATTLE, WA:
2,309,162, CANC. INT. CL. 41.

MIROMAR DEVELOPMENT CORPORATION, ESTERO, FL:
3,177,600, INT. CL. 35.

MIROTONE PTY LIMITED, NEW SOUTH WALES, AUSTRALIA:
3,175,942, PUB. 5-10-2005. INT. CL. 2.

MISSION SIX DISTRIBUTION, LLC, BEND, OR:
3,177,097, PUB. 9-12-2006. INT. CL. 25.

MISTRAL S.P.A., MONCALIERI (TURIN), ITALY:
3,038,688, COR. MULTIPLE CLASS, INT. CLS. 3, 18 AND 25.

MISYS INTERNATIONAL BANKING SYSTEMS INC., NEW YORK, NY, LOR/GESKE BOCK ASSOCIATES, INC., LOS ANGELES, CA:
1,908,224, REN. 10-25-06. INT. CL. 9.

MISYS PLC, LONDON, UNITED KINGDOM:
3,177,341, MULTIPLE CLASS, INT. CLS. 9, 35, 36, 38 AND 42.

MITCHELL, DESHAWN, SAN MATEO, CA:
3,175,948, PUB. 9-12-2006. INT. CL. 41.

MITCHELL, DONNELL L., CLEVELAND, OH:
3,176,400, PUB. 7-4-2006. INT. CL. 41.

MITEL CORPORATION:
1,377,915, CANC. INT. CL. 9.

MITSUBISHI CHEMICAL INDUSTRIES LIMITED, CHIYODA-KU, TOKYO, JAPAN:
1,411,051, REN. 10-24-06. INT. CL. 6.

MITSUI & CO (U.S.A.), INC., NEW YORK, NY:
2,309,790, CANC. INT. CL. 42.

MIXX ENTERTAINMENT, INC., LOS ANGELES, CA:
2,309,728, CANC. INT. CL. 41.

MIZUNO USA, INC., NORCROSS, GA:
2,308,724, CANC. INT. CL. 28.

MJB DISTRIBUTING COMPANY, LLC, VAN NUYS, CA:
3,178,407, INT. CL. 12.

MJDESIGNS, L.P., GRAPEVINE, TX:
2,601,880, CANC. INT. CL. 35.

MKS INSTRUMENTS, INC., ANDOVER, MA:
2,308,327, CANC. INT. CL. 9.

MNC ENTERPRISES, LOS ANGELES, CA:
2,309,593, CANC. INT. CL. 14.

MNP CORPORATION, UTICA, MI:
2,308,459, CANC. INT. CL. 6.

MOBILE MATCH, LLC, NORTH MIAMI BEACH, FL:
3,176,399, PUB. 9-12-2006. MULTIPLE CLASS, INT. CLS. 35 AND 45.

MOBILETEL, INC., LAROSE, LA:
1,949,236, CANC. INT. CL. 38.

MODELLO DESIGN GROUP, LLC, NATIONAL CITY, CA:
3,175,876, PUB. 9-12-2006. MULTIPLE CLASS, INT. CLS. 16 AND 40.

MODULAR MINING SYSTEMS, INC., TUCSON, AZ:
1,426,319, REN. 10-23-06. INT. CL. 9.

MODULAR PRODUCTS, INC, DES MOINES, IA:
2,308,473, CANC. INT. CL. 19.

MODUS OPERANDI, INC., INDIALANTIC, FL:
2,309,119, CANC. INT. CL. 42.

MOHAWK CARPET CORPORATION, ATLANTA, GA:
2,309,713, CANC. INT. CL. 27.

MOHR ACCESS LLC, RIDGEWOOD, NJ:
3,176,758, PUB. 9-12-2006. INT. CL. 41.
3,176,857, PUB. 9-12-2006. INT. CL. 41.

MONDRIAN INVESTMENT PARTNERS LIMITED, LONDON, UNITED KINGDOM:
3,176,083, PUB. 9-12-2006. INT. CL. 36.

MONEY MANAGEMENT INTERNATIONAL, INC., HOUSTON, TX:
3,175,977, PUB. 9-12-2006. MULTIPLE CLASS, INT. CLS. 36 AND 41.

MONIERLIFETILE LLC, IRVINE, CA:
3,177,405, INT. CL. 19.

MONITOR MANAGEMENT, INC., HARTFORD, CT:
1,378,411, CANC. INT. CL. 36.

MONKEY WORLD LIMITED, WAREHAM, DORSET, ENGLAND:
3,175,949, PUB. 1-24-2006. INT. CL. 30.

MONROVIA NURSERY COMPANY, AZUSA, CA:
3,177,157, PUB. 9-12-2006. INT. CL. 31.

MONSANTO COMPANY, ST. LOUIS, MO:
2,309,074, CANC. INT. CL. 42.

MONTCLAIR CONSULTING GROUP, LLC, MONTCLAIR, NJ:
3,177,782, INT. CL. 42.

MONTGOMERY KONE INC., MOLINE, IL:
2,308,938, CANC. INT. CL. 9.

MONTGOMERY, MCCracken, WALKER & RHOADS, LLP, PHILADELPHIA, PA:
3,176,593, PUB. 9-12-2006. INT. CL. 42.

MONTLICK, TERRY F., PAWTUCKET, RI:
3,176,250, PUB. 9-12-2006. INT. CL. 42.

MONTREXPORT S.P.A., 37012 BUSSOLENGO (VR), ITALY:
3,176,195, PUB. 9-12-2006. INT. CL. 25.

MONUMENTAL LIFE INSURANCE COMPANY, BALTIMORE, MD:
3,177,008, PUB. 9-12-2006. INT. CL. 36.

MOOG MUSIC, INC., ASHEVILLE, NC:
3,178,139, INT. CL. 15.

MOONBERRIES, INC., KANEOHE, HI:
3,176,334, PUB. 9-12-2006. INT. CL. 25.

MOONEY, JAMES ROBERT, CARSON, CA:
2,308,326, CANC. INT. CL. 25.

MOORE & ASSOCIATES, INC., BELLEVUE, WA:
2,308,550, CANC. INT. CL. 35.

MOORING SYSTEMS LIMITED, CHRISTCHURCH, NEW ZEALAND:
3,175,831, PUB. 7-4-2006. MULTIPLE CLASS, INT. CLS. 7, 9 AND 37.

MORAMARCO, GREGG, WESTBURY, NY:
2,310,087, CANC. INT. CL. 35.

MORAVIA IT, A.S., BRNO, CZECH REPUBLIC:
3,178,745, MULTIPLE CLASS, INT. CLS. 9, 35, 40, 41 AND 42.

MORGAN, STACIE, L.L., NORTHFIELD, VT:
2,308,765, CANC. INT. CL. 16.

MORI SEIKI CO., LTD., NARA 639-1160, JAPAN:
3,175,853, PUB. 9-12-2006. INT. CL. 7.

MORINAGA & CO., LTD., TOKYO, JAPAN:
3,177,781, MULTIPLE CLASS, INT. CLS. 29 AND 30.

MORRIS & DICKSON CO., LTD., SHREVEPORT, LA:
3,178,285, MULTIPLE CLASS, INT. CLS. 9 AND 42.

MORRIS INTERNATIONAL CORPORATION, LAKE CITY, SC:
2,309,860, CANC. INT. CL. 9.

MORRIS, JOHN C., BELTON, MO, DBA YOW-ZAH! PRODUCTIONS:
3,177,450, INT. CL. 41.

MORTGAGE RESOURCE CENTER, INC., EAGAN, MN:
3,178,210, INT. CL. 36.

MOSDEUX, ROSEVILLE, CA:
3,176,145, PUB. 9-12-2006. INT. CL. 41.

MOSER-GLASER & CO. AG, MUTTENZ, SWITZERLAND:
1,377,936, CANC. MULTIPLE CLASS, INT. CLS. 9 AND 17.

MOSES, JESSE D. III, CULVER CITY, CA:
2,308,929, CANC. INT. CL. 9.

- MOSLEY, BRENT, M., FAYETTEVILLE, NC:
3,175,938, PUB. 9-12-2006. INT. CL. 41.
- MOTHERLODE ENTERPRISES, LLC, NORTHPORT, NY:
3,178,278, MULTIPLE CLASS, INT. CLS. 16 AND 41.
- MOTION RESEARCH CORPORATION, SEATTLE, WA:
3,178,089, INT. CL. 9.
- MOTOR VEHICLE PROTECTION SYSTEMS, INC., WAYLAND, MA:
2,308,250, CANC. INT. CL. 12.
- MOTORQUEST GROUP L.L.C., TROY, MI:
2,308,203, CANC. MULTIPLE CLASS, INT. CLS. 35 AND 37.
- MOTTAHEDEH & COMPANY, INC., CRANBURY, NJ:
3,177,986, INT. CL. 21.
- MOTUL, AUBERVILLIERS, FRANCE:
3,175,996, PUB. 9-12-2006. INT. CL. 4.
- MOUNT OLIVE PICKLE COMPANY, INC., MOUNT OLIVE, NC:
2,072,297. REN. 10-22-06. INT. CL. 29.
- MOUNTZ, INC., SAN JOSE, CA:
2,309,670, CANC. INT. CL. 9.
- MOVEFORFREE.COM, SAN ANTONIO, TX:
3,176,017, PUB. 9-12-2006. INT. CL. 35.
- MOVING TARGETS, INCORPORATED, NORTH BRANCH, MN:
3,178,145, INT. CL. 28.
- MPM MEDICAL, INC., IRVING, TX:
3,176,299, PUB. 9-12-2006. INT. CL. 5.
- MPOWER AUTO, INC., SOUTH ELGIN, IL:
3,177,797, INT. CL. 9.
- MR. CHRISTMAS, INCORPORATION, NEW YORK, NY,
FLOWERIZED PRESENTATIONS, INC., NEW YORK, NY:
804,025. REN. 10-21-06. U.S. CL. 50 (INT. CL. 28).
- MR. DANIELS INC., SACRAMENTO, CA:
2,309,283, CANC. INT. CL. 9.
- MR. GOODCENTS FRANCHISE SYSTEMS, INC., DESOTO, KS:
3,177,043, PUB. 9-12-2006. INT. CL. 30.
- MRS. GROSSMAN'S PAPER COMPANY, PETALUMA, CA:
2,309,531, CANC. INT. CL. 16.
- MSC.SOFTWARE CORPORATION, LOS ANGELES, CA:
2,467,564, AM. INT. CL. 9.
- MTD PRODUCTS INC, VALLEY CITY, OH:
3,176,159, PUB. 9-12-2006. INT. CL. 12.
3,176,160, PUB. 9-12-2006. INT. CL. 12.
- MUL-TI ENTERPRISES, INC., GAINESVILLE, GA:
3,178,635, INT. CL. 9.
- MULTI SERVICE CORPORATION, OVERLAND PARK, KS:
1,948,425, CANC. INT. CL. 42.
- MULTILOGIC, INC., ST. PAUL, MN:
2,309,675, CANC. INT. CL. 9.
- MULTNOMAH PUBLISHERS, INC., SISTERS, OR:
3,177,667, INT. CL. 16.
- MUNOZ, RAFAEL, WHITTIER, CA:
3,178,822, INT. CL. 35.
- MUNSTER SIMMS ENGINEERING LIMITED, UNITED KINGDOM:
3,177,192, PUB. 9-12-2006. INT. CL. 7.
- MUNYAN, DANIEL E., ELIZABETHTOWN, PA:
2,324,698, CANC. MULTIPLE CLASS, INT. CLS. 9 AND 42.
- MURZAN, INC., NORCROSS, GA:
1,404,633. REN. 10-23-06. INT. CL. 7.
- MUSCO CORPORATION, OSKALOOSA, IA:
3,178,722, MULTIPLE CLASS, INT. CLS. 9 AND 11.
- MVS UHF, S.A. DE C.V., MEXICO, D.F.C.P., MEXICO:
3,175,832, PUB. 9-12-2006. INT. CL. 41.
- MW CUSTOM PAPERS, LLC, STAMFORD, CT:
3,176,221, PUB. 9-12-2006. INT. CL. 16.
- MXENERGY INC., STAMFORD, CT:
3,178,334, INT. CL. 39.
- MYPROSELLER, LLC, SAN LUIS OBISPO, CA:
3,177,014, PUB. 9-12-2006. INT. CL. 35.
- MYSOFTWARE COMPANY, PALO ALTO, CA:
2,309,103, CANC. INT. CL. 9.
- MYSPIFF.COM LLC, DENVER, CO:
3,177,052, PUB. 9-12-2006. INT. CL. 35.
- M2 WORLDWIDE CORPORATION, ROCKVILLE, MD:
3,177,835, INT. CL. 9.
- N. JONAS & CO., INC., BENSALEM, PA:
1,438,824. REN. 10-25-06. INT. CL. 1.
- NABISCO BRANDS COMPANY, WILMINGTON, DE:
2,309,962, CANC. INT. CL. 30.
- NAKASO, LYNN SHIBATA, LAFAYETTE, CA:
1,999,090. REN. 10-26-06. INT. CL. 42.
- NAN YANG FABRIC CO., LTD., AMPHOR KHOA-YOI, PETCHABURI PROVINCE, THAILAND:
3,178,668, INT. CL. 25.
- NANTONG HUAYIN WOOLEN BLANKET CO., LTD., HAIAN, CHINA:
3,176,649, PUB. 9-12-2006. INT. CL. 24.
- NARTER, BART, GARDNERVILLE, NV:
2,309,223, CANC. INT. CL. 9.
- NASP III/V GMBH, FED REP GERMANY:
3,177,297, PUB. 9-12-2006. MULTIPLE CLASS, INT. CLS. 9, 41 AND 42.
- NASSIRI, NICK, EL SEGUNDO, CA:
3,177,910, INT. CL. 45.
- NATERE USA INC, SANFORD, FL:
3,176,912, PUB. 9-12-2006. INT. CL. 35.
- NATIONAL ACADEMY OF PUBLIC ADMINISTRATION FOUNDATION, WASHINGTON, DC:
1,949,792, CANC. INT. CL. 16.
- NATIONAL ASSOCIATION FOR STOCK CAR AUTO RACING, INC., DAYTONA BEACH, FL:
2,309,982, CANC. MULTIPLE CLASS, INT. CLS. 1, 4, 9 AND 12.
3,178,387, INT. CL. 41.
- NATIONAL ASSOCIATION FOR THE SPECIALITY FOOD TRADE, INC., NEW YORK, NY:
1,447,856. REN. 10-25-06. INT. CL. 35.
- NATIONAL ASSOCIATION OF MUSIC MERCHANTS, INC., CARLSBAD, CA:
3,178,556, INT. CL. 25.
- NATIONAL AUDUBON SOCIETY, INC., NEW YORK, NY:
1,948,770, CANC. INT. CL. 39.
- NATIONAL COMPUTER SYSTEMS, INC., EDEN PRAIRIE, MN:
1,377,986, CANC. INT. CL. 9.
- NATIONAL DANCE COUNCIL OF AMERICA, INC., PORT ST. LUCIE, FL:
3,178,699, INT. CL. 41.
- NATIONAL FOOTBALL LEAGUE, NEW YORK, NY:
3,176,066, PUB. 9-12-2006. MULTIPLE CLASS, INT. CLS. 25, 35, 36, 41 AND 44.
- NATIONAL GYPSUM PROPERTIES, LLC, CHARLOTTE, NC:
2,490,837, AM. INT. CL. 19.
- NATIONAL HOME IMPROVEMENT, INC., LAS VEGAS, NV:
3,176,156, PUB. 9-12-2006. INT. CL. 37.
- NATIONAL HOT ROD ASSOCIATION, GLENDORA, CA:
3,178,266, INT. CL. 9.
- NATIONAL INSTITUTE FOR HEALTH CARE MANAGEMENT RESEARCH AND EDUCATIONAL FOUNDATION, WASHINGTON, DC:
3,176,094, PUB. 9-12-2006. INT. CL. 41.
- NATIONAL LABS, INC., WINTER HAVEN, FL TO GLOBAL MEDICAL GROUP, INC., MEMPHIS, TN:
1,949,583, CANC. INT. CL. 10.
- NATIONAL MOLD DETECTION, LLC, CANTON, MA:
3,176,762, PUB. 9-12-2006. INT. CL. 42.
- NATIONAL OCEANIC AND ATMOSPHERIC ADMINISTRATION, U.S. DEPARTMENT OF COMMERCE, WASHINGTON, DC:
3,176,780, PUB. 9-12-2006. INT. CL. 9.
- NATIONAL PAINTBALL SUPPLY, INC., SEWELL, NJ:
3,177,887, INT. CL. 28.
- NATIONAL PAYMENT CORPORATION, TAMPA, FL:
3,177,092, PUB. 9-12-2006. INT. CL. 36.
3,177,131, PUB. 9-12-2006. INT. CL. 36.
- NATIONAL PET SUPPLY, INC., ATLANTA, GA:
3,178,575, INT. CL. 5.

NATIONAL RESEARCH COUNCIL OF CANADA, OTTAWA, ONTARIO, CANADA:
2,309,674, CANC. INT. CL. 38.

NATIONAL SANITATION FOUNDATION, ANN ARBOR, MI:
1,378,632, CANC. U.S. CL. A.

NATIONAL SENIOR CITIZENS PAGEANT, INC., , THE, JOLIET, IL:
1,378,490, CANC. INT. CL. 41.

NATIONAL SHOOTING SPORTS FOUNDATION, INC., NEWTOWN, CT:
3,176,800, PUB. 9-12-2006. INT. CL. 35.

NATIONAL SPEAKERS BUREAU, INC., LIBERTYVILLE, IL:
2,069,143. REN. 10-24-06. INT. CL. 35.

NATROL, INC., CHATSWORTH, CA, KELLY DISTRIBUTORS, INC., ROCKEY HILL, CT:
1,996,583. REN. 10-26-06. INT. CL. 5.

NATURAL ORGANICS, INC., FARMINGDALE, NY:
1,378,649, CANC. INT. CL. 5.

NATURE BOY, INC., LAUDERDALE BY THE SEA, FL:
3,177,012, PUB. 9-12-2006. INT. CL. 43.

NATURE'S PANTRY, INC., BELLEVUE, WA:
1,998,457. REN. 10-25-06. INT. CL. 42.

NATURE'S PATH FOODS, INC., RICHMOND, BRITISH COLUMBIA, CANADA:
3,177,333, INT. CL. 30.

NATURE'S SUNSHINE PRODUCTS, INC., PROVO, UT:
1,437,687. REN. 10-24-06. INT. CL. 5.
2,050,003. REN. 10-24-06. INT. CL. 5.
2,061,444. REN. 10-25-06. INT. CL. 16.

NAVAHO NETWORKS INC., TORONTO, ONTARIO, CANADA:
3,178,506, MULTIPLE CLASS, INT. CLS. 35 AND 36.

NAVION HOLDINGS, INC., PERRYSBURG, OH:
2,308,583, CANC. MULTIPLE CLASS, INT. CLS. 12 AND 35.

NAVITAS CANCER REHABILITATION CENTERS OF AMERICA, INC., WESTMINSTER, CO:
3,177,860, INT. CL. 44.

NBA DEVELOPMENT LEAGUE, LLC, SECAUCS, NJ:
3,178,546, INT. CL. 25.

NCI BUILDING SYSTEMS, L.P., HOUSTON, TX:
2,040,247. REN. 10-20-06. INT. CL. 42.

NCP COATINGS, INC., NILES, MI:
3,178,046, INT. CL. 2.

NDI MEDICAL, LLC, CLEVELAND, OH:
3,178,728, INT. CL. 10.

NEDBOY, ROBIN L, NEW YORK, NY:
3,088,986, CANC. INT. CL. 3.

NEIGHBORHOOD DRY CLEANING COMPANY, INC., THE, DELRAY BEACH, FL:
2,308,669, CANC. INT. CL. 37.

NELLCOR PURITAN BENNETT INCORPORATED, PLEASANTON, CA:
2,309,513, CANC. INT. CL. 10.

NELSON DESIGN GROUP, LLC, JONESBORO, AR:
3,177,116, PUB. 9-12-2006. INT. CL. 9.

NELSON, SCOTT, BEAUMONT, TX:
3,176,123, PUB. 9-12-2006. MULTIPLE CLASS, INT. CLS. 9 AND 25.

NELSON, WAYNE D., DULUTH, MN, DBA BUSINESS NORTH:
1,993,162. REN. 10-21-06. INT. CL. 16.

NEMESIS AIR RACING, MOJAVE, CA:
3,176,273, PUB. 9-12-2006. INT. CL. 12.

NETACCESS, INC., ABINGDON, VA:
2,309,398, CANC. INT. CL. 38.
2,309,400, CANC. INT. CL. 38.

NETRIGHT TECHNOLOGIES, INC., SUNNYVALE, CA:
2,308,932, CANC. INT. CL. 9.

NETSECURITY CORPORATION, STERLING, VA:
3,176,755, PUB. 9-12-2006. INT. CL. 41.

NETSOLV, INC., GAITHERSBURG, MD:
2,309,600, CANC. INT. CL. 35.

NETWORK DIVERSITY, LLC, HARPER WOODS, MI:
3,176,732, PUB. 9-12-2006. INT. CL. 35.

NETWORK ENTERPRISES, INC., NASHVILLE, TN:
2,309,985, CANC. INT. CL. 41.

NEUMAN, BILL D., OMAHA, NE:
3,176,131, PUB. 9-12-2006. INT. CL. 36.

NEVERCASHED, IMPERIAL, CA:
3,178,449, INT. CL. 25.

NEW ALBERTSON'S, INC., BOISE, ID, GREAT PACIFIC INDUSTRIES, LTD., LANGLEY, BC V6B 4E4, CANADA:
1,997,783. REN. 10-26-06. INT. CL. 42.

NEW BRUNSWICK SCIENTIFIC COMPANY, INC., EDISON, NJ:
3,178,304, INT. CL. 9.

NEW CONCEPTS MANAGEMENT CORPORATION, ABERDEEN, NJ:
2,309,308, CANC. INT. CL. 42.

NEW CREATIVE ENTERPRISES, INC., CINCINNATI, OH:
1,949,685, CANC. INT. CL. 1.

NEW ERA CANNING COMPANY, NEW ERA, MI:
1,993,948. REN. 10-22-06. INT. CL. 29.

NEW FRONTIER MEDIA, INC., BOULDER, CO:
3,178,339, INT. CL. 41.

NEW HOPE COMMUNICATIONS, LLC, NEW YORK, NY:
2,309,931, CANC. INT. CL. 16.

NEW JERSEY SPORTS & EXPOSITION AUTHORITY, EAST RUTHERFORD, NJ:
3,176,490, PUB. 9-12-2006. INT. CL. 41.

NEW JERSEY SPORTS AND EXPOSITION AUTHORITY, EAST RUTHERFORD, NJ:
1,378,353, CANC. MULTIPLE CLASS, INT. CLS. 35, 39, 41 AND 42.

NEW NICHE, LLC, STEAMBOAT SPRINGS, CO:
3,177,851, MULTIPLE CLASS, INT. CLS. 21, 28 AND 35.

NEW VENTURE GEAR, INC., TROY, MI:
2,308,572, CANC. INT. CL. 12.

NEW VISION, JEFFERSON, OR:
3,176,678, PUB. 9-12-2006. INT. CL. 18.

NEW WEST MARKETING LLC, CENTENNIAL, CO:
3,177,560, INT. CL. 35.

NEW YORK - NEW YORK HOTEL & CASINO, LLC, LAS VEGAS, NV:
2,308,443, CANC. INT. CL. 25.

NEW YORK CASUAL LLC, GRAND BLANC, MI:
3,178,793, INT. CL. 25.

NEW YORK MAGAZINE HOLDINGS LLC, NEW YORK, NY:
3,178,767, INT. CL. 16.

NEW YORK MERCANTILE EXCHANGE, INC., NEW YORK, NY:
3,176,104, PUB. 9-12-2006. MULTIPLE CLASS, INT. CLS. 36 AND 42.

NEWBAY MEDIA LLC, NEW YORK, NY:
3,178,784, INT. CL. 16.

NEWBOLD CORPORATION, ROCKY MOUNT, VA:
3,178,430, INT. CL. 9.

NEWELL OPERATING COMPANY, ATLANTA, GA, THOMAS INDUSTRIES INC., LOUISVILLE, KY:
1,402,102. REN. 10-20-06. INT. CL. 16.

NEWMAN, LAWRENCE C., KATONAH, NY:
3,175,930, PUB. 9-12-2006. INT. CL. 44.

NEWS HOLDINGS LIMITED, SYDNEY, NEW SOUTH WALES, AUSTRALIA:
2,308,853, CANC. INT. CL. 35.

NEWSMAX.COM, WEST PALM BEACH, FL:
3,177,090, PUB. 9-12-2006. INT. CL. 16.

NEWSOFT TECHNOLOGY CORP., TAIPEI, TAIWAN:
3,177,839, INT. CL. 9.

NEWTEK, INC., SAN ANTONIO, TX:
1,948,456, CANC. INT. CL. 9.

NEXANS, FRANCE:
3,177,226, PUB. 9-12-2006. INT. CL. 9.

NEXSTAR, INC., WHITE BEAR LAKE, MN:
3,178,359, INT. CL. 41.

NEXTEP, RENO, NV:
3,177,843, INT. CL. 18.

NEXUS BIOSYSTEMS, INC., POWAY, CA:
3,176,259, PUB. 9-12-2006. INT. CL. 9.

NEXUS ENERGY SOFTWARE, INC., NEWTON, MA:
2,309,053, CANC. INT. CL. 9.

- NEXUS ENTERTAINMENT, HUNTINGTON BEACH, CA:
3,176,132, PUB. 9-12-2006. INT. CL. 42.
- NFO RESEARCH, INC., TOLEDO, OH:
1,378,387, CANC. INT. CL. 35.
- NGK SPARK PLUG CO., LTD., NAGOYA CITY, JAPAN:
3,178,116, INT. CL. 9.
- NGO, RICHARD B., FRANKLIN, TN:
3,177,493, INT. CL. 41.
- NICK MILLER, INC., PALM BEACH GARDENS, FL:
3,177,774, INT. CL. 42.
- NICKERSON, MARCY, WHATELY, MA AND NICKERSON,
GLYNDA, WHATELY, MA:
2,308,298, CANC. INT. CL. 42.
- NIELSEN, H. KRISTIAN, SEATTLE, WA:
1,994,043, REN. 10-21-06. MULTIPLE CLASS, INT. CLS.
22 AND 28.
- NIJAL, 56150 BAUD, FRANCE:
3,176,308, PUB. 9-12-2006. INT. CL. 7.
- NIMBIT, INC., FRAMINGHAM, MA:
3,176,660, PUB. 9-12-2006. MULTIPLE CLASS, INT. CLS.
35, 38 AND 42.
- NINE WEST DEVELOPMENT CORPORATION, WILMINGTON,
DE:
2,407,374, CANC. INT. CL. 18.
- NIOXIN RESEARCH LABORATORIES, INC., LITHIA
SPRINGS, GA:
2,309,000, CANC. INT. CL. 3.
- NIRO AS, DK-2860 SOBORG, DENMARK:
3,175,820, PUB. 7-4-2006. MULTIPLE CLASS, INT. CLS. 6,
7 AND 11.
- NIRVANA OF NEW YORK, NEW YORK CITY, NY:
3,175,798, PUB. 9-12-2006. INT. CL. 3.
- NIRVE SPORTS, LTD., FOUNTAIN VALLEY, CA:
3,178,107, INT. CL. 12.
- NITROMED, INC., LEXINGTON, MA:
3,177,849, INT. CL. 42.
- NLP IP COMPANY, WILMINGTON, DE:
2,308,827, CANC. INT. CL. 42.
- NMB TECHNOLOGIES INC., CHATSWORTH, CA:
1,949,350, CANC. INT. CL. 9.
- NMCK PRODUCTIONS, INC., ASPEN, CO:
2,308,446, CANC. INT. CL. 41.
- NO FEAR, INC., CARLSBAD, CA:
2,309,562, CANC. INT. CL. 25.
- NOBLE GROUP LIMITED, HAMILTON, BERMUDA:
3,178,433, INT. CL. 2.
- NOKIAN RENKAAT OYJ (IN ENGLISH NOKIAN TIRES
PLC), 37101 NOKIA, FINLAND:
2,309,196, CANC. INT. CL. 12.
- NOLL MANUFACTURING COMPANY, STOCKTON, CA:
3,176,210, PUB. 9-12-2006. MULTIPLE CLASS, INT. CLS.
6, 12, 19 AND 21.
- NONNO SODA WORKS, LLC, CORVALLIS, OR, DBA
ROMANO'S ITALIAN SODA COMPANY:
3,176,518, PUB. 9-12-2006. INT. CL. 32.
- NORFOLK SCIENTIFIC, INC., NORWOOD, MA, DBA
STATSPIN TECHNOLOGIES:
1,948,113, CANC. INT. CL. 10.
- NORKAR TECHNOLOGIES, INC., NAPERVILLE, IL:
2,308,200, CANC. INT. CL. 9.
- NORTH AMERICAN LATINO BEER INDUSTRIES, INC.,
WHITTIER, CA:
3,177,338, INT. CL. 35.
- NORTH AMERICAN SALT COMPANY, OVERLAND PARK,
KS TO IMC SALT INC., OVERLAND PARK, KS:
1,949,650, CANC. INT. CL. 1.
- NORTH AMERICAN TEXTILE CO., LLC, GLENDALE, CA:
3,176,630, PUB. 9-12-2006. MULTIPLE CLASS, INT. CLS.
16, 24 AND 26.
- 3,176,631, PUB. 9-12-2006. MULTIPLE CLASS, INT. CLS.
16, 24 AND 26.
- NORTH AMERICAN VAN LINES, INC., FORT WAYNE, IN:
2,308,175, CANC. INT. CL. 9.
- NORTH COUNTRY INVESTMENT ADVISORS, INC.,
GLENS FALLS, NY:
3,176,376, PUB. 9-12-2006. INT. CL. 36.
- NORTH SHORE COMMUNITY BANCORP, INC., WILM-
ETTE, IL:
1,949,773, CANC. INT. CL. 36.
- NORTH SHORE DISTILLERY, LLC, LAKE BLUFF, IL:
3,176,853, PUB. 9-12-2006. INT. CL. 33.
- NORTHERN ELASTOMERIC, INC., BRENTWOOD, NH:
3,177,675, INT. CL. 19.
- NORTHERN ELECTRONICS AUTOMATION, INC., LON-
DONDERRY, NH:
3,177,946, INT. CL. 35.
- NORTHLAND ALUMINUM PRODUCTS, INC., MINNEA-
POLIS, MN:
3,175,882, PUB. 9-12-2006. INT. CL. 30.
- NORTHLIGHT ATELIER, LLC, SANTA BARBARA, CA:
3,176,144, PUB. 9-12-2006. MULTIPLE CLASS, INT. CLS.
16 AND 41.
- NORTHWEST FLORIDA BUSINESS DEVELOPMENT
COUNCIL, INC., MARIANNA, FL, DBA OPPORTUNITY
FLORIDA:
3,176,577, PUB. 9-12-2006. INT. CL. 35.
- NORTON AMERICA, LLC, WESTON, MA:
3,177,599, INT. CL. 12.
- NOT SO PLAIN JANE, INC., KINGWOOD, TX:
2,308,558, CANC. INT. CL. 14.
- NOVARTIS AG, BASEL, SWITZERLAND:
3,176,551, PUB. 9-12-2006. INT. CL. 5.
3,178,358, INT. CL. 5.
- NOVARTIS CORPORATION, SUMMIT, NJ:
1,056,413, REN. 10-20-06. INT. CL. 5.
- NOVATOY, PALO ALTO, CA:
3,178,523, INT. CL. 28.
- NOVUS, INC., GUAYNABO, PUERTO RICO:
3,176,118, PUB. 9-12-2006. INT. CL. 35.
- NOWTRADE, ST. PETERSBURG, FL:
2,308,661, CANC. INT. CL. 35.
- NRX GLOBAL CORP., TORONTO, ONTARIO, CANADA:
3,175,761, PUB. 9-12-2006. MULTIPLE CLASS, INT. CLS.
35, 37, 39 AND 42.
- NT TOOL KABUSHIKIKAISHA, JAPAN:
3,177,205, PUB. 9-12-2006. INT. CL. 42.
3,177,206, PUB. 9-12-2006. INT. CL. 42.
- NTI GROUP, INC., THE, SHERMAN OAKS, CA:
3,177,138, PUB. 9-12-2006. INT. CL. 38.
- NU-OLD RESTAURANT GROUP, INC., FLUSHING, NY:
2,309,299, CANC. INT. CL. 42.
- NUMEREX INVESTMENT CORPORATION, ATLANTA,
GA, VERSUS TECHNOLOGY, INC., TRENTON, NJ:
1,941,980, REN. 10-24-06. INT. CL. 37.
- NUTOPICALS, L.L.C., NEWCASTLE, OK:
3,178,792, INT. CL. 5.
- NUTRACEUTIX, INC., REDMOND, WA:
3,178,766, INT. CL. 5.
- NUTRASURGE, INC., DAVISBURG, MI:
2,309,403, CANC. INT. CL. 1.
- NUTREND HEALTH INSTITUTE, INC., ARCADIA, CA:
3,176,990, PUB. 9-12-2006. INT. CL. 5.
3,176,991, PUB. 9-12-2006. INT. CL. 5.
- NUTRISYSTEM IPHC, INC., WILMINGTON, DE:
3,178,578, INT. CL. 32.
- NUVO ACCESSORIES, LTD., NEW YORK, NY:
2,308,828, CANC. INT. CL. 20.
- O'CANNA, M. BRIDGET, COLORADO SPRINGS, CO AND
DEVERS, KATIE RENEE, DENVER, CO:
3,175,893, PUB. 9-12-2006. INT. CL. 28.
- O'NEAL, WILLIAM E, MELBOURNE, FL:
3,175,812, PUB. 9-12-2006. INT. CL. 11.
- OAKLEAF WASTE MANAGEMENT, INC., EAST HART-
FORD, CT:
3,175,895, PUB. 9-12-2006. MULTIPLE CLASS, INT. CLS.
37 AND 39.
- OAKLEY, INC., FOOTHILL RANCH, CA:
1,980,039, REN. 10-25-06. MULTIPLE CLASS, INT. CLS. 9
AND 25.
- 1,984,501, REN. 10-25-06. MULTIPLE CLASS, INT. CLS. 9
AND 25.
- OBIM FRESH-CUT FRUIT CO., FORT WORTH, TX:
2,309,371, CANC. INT. CL. 29.

OBLON, SPIVAK, MCCLELLAND, MAIER & NEUSTADT, P.C., ALEXANDRIA, VA:
3,178,112, INT. CL. 42.

OCCUNOMIX INTERNATIONAL INC., PORT JEFFERSON STATION, NY, OCCUNOMIX INTERNATIONAL INC., PORT JEFFERSON STATION, NY:
1,991,643, REN. 10-25-06. INT. CL. 9.

OCCUPATIONAL HEALTH MANAGEMENT, INC., DULUTH, GA:
1,949,434, CANC. INT. CL. 9.

OCEAN RIDGE PLANTATION GOLF, INC., OCEAN ISLE BCH., NC:
2,083,502, REN. 10-24-06. INT. CL. 41.

OCEANIC, SAN LEANDRO, CA:
3,176,967, PUB. 9-12-2006. INT. CL. 9.

OCTAPharma AG, SWITZERLAND:
3,177,197, PUB. 9-12-2006. INT. CL. 5.

OCTOPUS NEW YORK, NEW YORK, NY:
3,178,405, MULTIPLE CLASS, INT. CLS. 9 AND 18.

ODABASH, MELISSA, TENAFLY, NJ:
2,308,873, CANC. INT. CL. 25.

ODC OPHTHALMIC DEVELOPMENT COMPANY AG, CH-8005 ZURICH, SWITZERLAND:
2,310,069, CANC. MULTIPLE CLASS, INT. CLS. 9 AND 10.

ODDZON, INC., PAWTUCKET, RI:
2,309,367, CANC. INT. CL. 28.

OFFICE OF STRATEGIC INNOVATION, INC., HOUSTON, TX:
1,992,781, REN. 10-25-06. INT. CL. 41.

OFFICE OF THE ASSISTANT SECRETARY FOR ADMINISTRATION AND MANAGEMENT, WASHINGTON, DC:
3,178,691, INT. CL. 36.
3,178,692, INT. CL. 36.

OFFICEMAX, INC, SHAKER HEIGHTS, OH TO OMX, INC., LAS VEGAS, NV:
1,948,932, CANC. MULTIPLE CLASS, INT. CLS. 16 AND 42.

OFFICERS ONLY INCORPORATED, OGDEN, UT:
3,178,701, INT. CL. 6.
3,178,702, INT. CL. 6.
3,178,703, INT. CL. 6.
3,178,704, INT. CL. 6.

OIL COMPANY, THE, BEVERLY HILLS, CA:
1,377,789, CANC. INT. CL. 3.

OIL EXPRESS NATIONAL, INC., HINSDALE, IL:
2,001,160, REN. 10-20-06. INT. CL. 37.

OKI ELECTRIC INDUSTRY CO., LTD., TOKYO 105, JAPAN:
1,377,988, CANC. INT. CL. 9.

OKUMA AMERICA CORPORATION, CHARLOTTE, NC:
3,177,853, INT. CL. 9.

OLD EUROPEAN BREWERY COMPANY, SAN DIEGO, CA:
2,030,795, REN. 10-26-06. INT. CL. 32.
3,178,148, INT. CL. 32.
3,178,696, INT. CL. 32.

OLD FORGE PIZZA VENTURES LLC, OLD FORGE, PA:
3,178,747, MULTIPLE CLASS, INT. CLS. 30 AND 35.

OLD LINE LIFE INSURANCE COMPANY OF AMERICA, THE, MILWAUKEE, WI:
2,308,815, CANC. INT. CL. 36.

OLE HENRIKSEN OF DENMARK, INC., LOS ANGELES, CA:
3,177,150, PUB. 9-12-2006. INT. CL. 3.

OLIVE BRANCH, LTD., THE, COLORADO SPRINGS, CO:
1,378,627, CANC. INT. CL. 42.

OLIVIA'S PIECES, CORP., STATEN ISLAND, NY:
3,176,200, PUB. 9-12-2006. MULTIPLE CLASS, INT. CLS. 35 AND 40.

OLSEN MANUFACTURING CO., INC., ROYAL OAK, MI:
3,175,842, PUB. 9-12-2006. INT. CL. 9.

OMEGA FINANCIAL INC., COLUMBUS, GA:
2,308,744, CANC. INT. CL. 35.
2,308,745, CANC. INT. CL. 35.

OMEGALEAN, GREENVILLE, SC:
3,176,938, PUB. 9-12-2006. INT. CL. 5.

OMNI LINGUAL SERVICES, INC., WESTLAKE VILLAGE, CA:
2,018,698, REN. 10-25-06. INT. CL. 42.

OMNI USA, INC., HOUSTON, TX:
2,308,887, CANC. INT. CL. 7.

OMNOVA SOLUTIONS INC., FAIRLAWN, OH:
3,176,513, PUB. 9-12-2006. INT. CL. 1.

OMRON HEALTHCARE CO., LTD, KYOTO, JAPAN, COLIN CORPORATION, AICHI-KEN, JAPAN:
1,995,814, REN. 10-23-06. INT. CL. 10.

OMS INVESTMENTS, INC., LOS ANGELES, CA:
3,176,060, PUB. 9-12-2006. INT. CL. 31.

ON OVERSEAS, LLC, NEW YORK, NY:
3,176,357, PUB. 9-12-2006. INT. CL. 25.

ONDA, HIDEKI FRANCIS, TOKYO, JAPAN:
3,178,599, INT. CL. 9.

ONE CALL CONCEPTS, INC., HANOVER, MD:
3,178,799, MULTIPLE CLASS, INT. CLS. 35 AND 42.

ONEIDA INDIAN NATION OF NEW YORK, VERNON, NY, AKA THE ONEIDA INDIAN NATION OF NEW YORK, THE ONEIDA INDIAN NATION, ONEIDA INDIAN NATION, THE ONEIDA NATION, OR ONEIDA NATION:
3,114,525, COR. INT. CL. 9.

ONEIDA INDIAN NATION OF NEW YORK, ONEIDA, NY, AKA THE ONEIDA INDIAN NATION OF NEW YORK, AKA THE ONEIDA INDIAN NATION, AKA ONEIDA INDIAN NATION, AKA THE ONEIDA NATION, OR AKA ONEIDA NATION:
3,176,375, PUB. 9-12-2006. INT. CL. 30.

ONEIL, PATRICK SEAN, CARLSBAD, CA:
2,308,804, CANC. INT. CL. 5.

ONMETA, INC., SANTA MONICA, CA:
3,176,962, PUB. 9-12-2006. INT. CL. 35.

OPA! SOUVLAKI FRANCHISE GROUP INC., CALGARY, ALBERTA:
3,177,604, MULTIPLE CLASS, INT. CLS. 25, 30 AND 42.

OPAL EXPORT A.Y. 2002 LTD, MOSHAV BAZRA, ISRAEL:
3,176,058, PUB. 9-12-2006. MULTIPLE CLASS, INT. CLS. 29 AND 30.

OPEN BANK GRUPO SANTANDER, S.A., 28020 MADRID, SPAIN:
2,308,839, CANC. INT. CL. 36.

OPEN PANTRY FOOD MARTS OF WISCONSIN, INC., RACINE, WI:
2,308,786, CANC. INT. CL. 35.

OPENTEACH SOFTWARE, INC., WILMINGTON, DE:
2,308,616, CANC. INT. CL. 9.

OPERATION BASS, INC, BENTON, KY:
3,178,419, INT. CL. 25.

OPS SALES, INC., HANOVER, MA:
3,139,851, CANC. IIRN. RESTORED TO S.N. 78-364,795.

OPTELLENT INCORPORATED, SAN JOSE, CA:
3,178,093, INT. CL. 9.

OPTICAL LASER, HUNTINGTON BEACH, CA:
2,309,605, CANC. INT. CL. 16.

OPTION1 RESTORATION, INC., POMPANO BEACH, FL:
3,178,498, INT. CL. 37.

OPTOMA TECHNOLOGY, INC., MILPITAS, CA:
3,178,605, INT. CL. 9.

ORABI, SAADI, KENNESAW, GA:
3,176,150, PUB. 9-12-2006. INT. CL. 35.

ORALGIENE USA, INC., CULVER CITY, CA:
2,309,793, CANC. INT. CL. 21.

ORATECH, LC, SOUTH JORDAN, UT:
3,177,638, INT. CL. 3.

ORBCOMM GLOBAL, L.P., HERNDON, VA:
2,308,700, CANC. INT. CL. 39.
2,308,707, CANC. INT. CL. 38.
2,309,249, CANC. INT. CL. 38.

ORBTEK, INC., SALT LAKE CITY, UT:
2,309,187, CANC. INT. CL. 9.

ORCA BAY BASKETBALL LIMITED PARTNERSHIP, VANCOUVER BRITISH COLUMBIA, CANADA:
2,308,139, CANC. INT. CL. 25.

ORCHARD SOFTWARE CORPORATION, CARMEL, IN:
3,175,847, PUB. 9-12-2006. MULTIPLE CLASS, INT. CLS. 9 AND 42.

ORCHARD YARN AND THREAD COMPANY, INC., NEW YORK, NY, DBA LION BRAND YARN COMPANY:
3,175,807, PUB. 9-12-2006. MULTIPLE CLASS, INT. CLS. 18 AND 26.

- ORCHID TECHNOLOGY, FREMONT, CA:
1,377,966, CANC. INT. CL. 9.
- ORFEVRERIE CHRISTOFLE, FRANCE:
3,177,237, PUB. 9-12-2006. INT. CL. 21.
- ORGANON TEKNIKA B.V., 5281 RM BOXTEL, NETHERLANDS:
1,377,996, CANC. INT. CL. 10.
- ORION LEARNING INTERNATIONAL, INC., GAMBRILLS, MD:
3,176,089, PUB. 9-12-2006. INT. CL. 3.
- ORLANDI, INC., FARMINGDALE, NY:
3,175,924, PUB. 9-12-2006. INT. CL. 3.
- ORLANDO REGIONAL REALTOR ASSOCIATION, INC., ORLANDO, FL:
3,177,929, INT. CL. 35.
- ORLANDO/ORANGE COUNTY CONVENTION & VISITORS BUREAU, INC., ORLANDO, FL:
1,947,972, CANC. INT. CL. 35.
- ORLY INTERNATIONAL, INC., VAN NUYS, CA:
3,177,837, INT. CL. 3.
- ORNELLAIA SOCIETA AGRICOLA S.R.L., CASTAGNETO CARDUCCI, (LI) 57022, ITALY:
1,994,674, REN. 10-26-06. INT. CL. 33.
- ORONTES B.V., AMSTERDAM AIRPORT, NETHERLANDS:
3,177,772, MULTIPLE CLASS, INT. CLS. 9, 16 AND 36.
- ORR SAFETY CORPORATION, LOUISVILLE, KY:
2,308,580, CANC. INT. CL. 9.
- ORSINI CYCLE CENTER, WATERBURY, CT:
3,177,462, MULTIPLE CLASS, INT. CLS. 25 AND 40.
- ORTHO DEVELOPMENT CORPORATION, DRAPER, UT:
3,178,327, INT. CL. 10.
- ORTRONICS, INC., NEW LONDON, CT:
3,178,282, INT. CL. 9.
- OSG CORPORATION, AICHI, 442-0005, JAPAN:
3,177,234, PUB. 9-12-2006. MULTIPLE CLASS, INT. CLS. 6 AND 20.
- OSI INDUSTRIES, LLC, AURORA, IL:
3,176,430, PUB. 4-11-2006. INT. CL. 41.
- OSRAM G.M.B.H., D-81543 MUENCHEN, FED REP GERMANY:
1,948,445, CANC. INT. CL. 11.
- OTTLEY, DAVID H., WEST CHESTER, PA:
1,949,493, CANC. INT. CL. 28.
- OTTO BOCK HEALTHCARE GMBH, 37115 DUDERSTADT, FED REP GERMANY:
2,969,168, COR. MULTIPLE CLASS, INT. CLS. 1, 3, 5, 9, 10, 12, 17, 24, 25, 28, 37 AND 42.
- OULUN MUSHIKKIVIDEOFESTIVAALIT RY, OULU, FINLAND:
3,177,656, INT. CL. 41.
- OUTBACK ADVENTURES, INC., MARION, NC:
2,308,800, CANC. INT. CL. 28.
- OUTDOOR CAP CO., INC., BENTONVILLE, AZ:
2,013,871, REN. 10-25-06. INT. CL. 25.
- OUTSOURCE PARTNERS INTERNATIONAL, INC., LOS ANGELES, CA:
3,177,905, INT. CL. 35.
- OVATIONS INTERNATIONAL, INC., YORKTOWN HEIGHTS, NY:
2,309,395, CANC. INT. CL. 41.
- OVD KINEGRAM AG, SWITZERLAND:
3,177,199, PUB. 9-12-2006. MULTIPLE CLASS, INT. CLS. 9, 16 AND 17.
- OVERSTOCK.COM, INC., SALT LAKE CITY, UT:
3,178,177, INT. CL. 43.
- OVERSTOCK.COM, INC., SALT LAKE CITY, UT:
3,178,176, INT. CL. 43.
- OWENS-CORNING FIBERGLAS TECHNOLOGY INC., SUMMIT, IL:
3,177,618, INT. CL. 9.
3,177,791, INT. CL. 17.
- OWENS, STEPHEN M., SR., WILMINGTON, NC:
3,178,500, INT. CL. 30.
- OXLEY ENTERPRISES, INC., STAFFORD, VA:
3,176,050, PUB. 9-12-2006. INT. CL. 35.
- OY NORD WATER LTD., 00240 HELSINKI, FINLAND:
3,177,972, INT. CL. 32.
- OZDILEK ALISVERIS MERKEZLERI; VE TEKSTIL SANAYI ANONIM SIRKETI, TURKEY:
3,177,313, PUB. 9-12-2006. MULTIPLE CLASS, INT. CLS. 24 AND 25.
- OZWEST IMPORTS, INC., BANKS, OR:
2,309,533, CANC. INT. CL. 28.
- O2 HOLDINGS, LLC, NEW YORK, NY:
3,175,933, PUB. 9-12-2006. INT. CL. 25.
- P. Q. LICENSING, S.A., 11 AT B-1000 BRUSSELS, BELGIUM:
3,178,146, INT. CL. 30.
- P.H.I INVESTIGATIVE CONSULTANTS, INC., GARNERVILLE, NY:
2,002,086, REN. 10-26-06. INT. CL. 41.
- PABST BREWING COMPANY, SAN ANTONIO, TX:
3,175,802, PUB. 9-12-2006. INT. CL. 32.
- PAC FUNG FEATHER CO., LTD., KWUN TONG, HONG KONG:
3,178,612, INT. CL. 24.
- PACER SYSTEMS, INC., BURLINGTON, MA:
1,378,607, CANC. INT. CL. 42.
- PACIFIC CAPITAL GROUP, IRVINE, CA:
3,177,678, INT. CL. 36.
- PACIFIC CORPORATE GROUP HOLDINGS, LLC, LA JOLLA, CA:
3,176,292, PUB. 9-12-2006. INT. CL. 36.
- PACIFIC LANGUAGE ASSOCIATES, INC., PORTLAND, OR:
2,308,966, CANC. INT. CL. 41.
- PACIFIC LINK TRADE USA, INC., DALTON, GA:
3,177,739, INT. CL. 9.
- PADCO ADVISORS, INC., ROCKVILLE, MD:
3,177,994, MULTIPLE CLASS, INT. CLS. 16 AND 36.
- PADOW'S DELI, INC., RICHMOND, VA:
1,948,430, CANC. MULTIPLE CLASS, INT. CLS. 29 AND 30.
- PAGET GROUP, INC., THE, MADISON, WI:
3,178,079, INT. CL. 42.
- PAICH, MILO RAND, TAMPA, FL:
2,309,402, CANC. INT. CL. 16.
- PAIGE, ISAIAH, NEW YORK, NY:
3,177,567, INT. CL. 25.
- PAIS, JOSH, NEW YORK, NY:
3,178,525, INT. CL. 41.
- PAISLEY CONSULTING CANADA INC., MISSISSAUGA, ONTARIO, CANADA:
2,309,559, CANC. MULTIPLE CLASS, INT. CLS. 9 AND 16.
- PALL CORPORATION, EAST HILLS, NY:
1,996,587, REN. 10-22-06. INT. CL. 1.
- PALOMA SYSTEMS, INC., FAIRFAX, VA:
3,175,805, PUB. 9-12-2006. INT. CL. 9.
- PANACEA SOLUTIONS, INC., BERNARDSVILLE, NJ:
3,178,275, INT. CL. 9.
3,178,276, INT. CL. 9.
- PANEK, ERNEST JOHN, MONROEVILLE, PA:
1,999,829, REN. 10-26-06. INT. CL. 9.
- PANOR CORPORATION, HAUPPAUGE, NY:
3,177,413, MULTIPLE CLASS, INT. CLS. 9 AND 11.
- PANTERA INTERNATIONAL CORP., PLAINVIEW, NY:
1,947,821, CANC. INT. CL. 18.
- PANTHEON INC., FAIRFAX, VA:
3,176,054, PUB. 9-12-2006. INT. CL. 9.
- PANTONE, INC., MOONACHIE, NJ:
1,407,674, REN. 10-26-06. INT. CL. 16.
- PANZERI DIFFUSION S.R.L., ITALY:
3,177,251, PUB. 9-12-2006. MULTIPLE CLASS, INT. CLS. 3, 8 AND 21.
3,177,252, PUB. 9-12-2006. MULTIPLE CLASS, INT. CLS. 3, 8 AND 21.
- PAPER MAGIC GROUP, INC., THE, WILMINGTON, DE:
3,177,358, MULTIPLE CLASS, INT. CLS. 9 AND 11.
- PAPERCHASE PRODUCTS LIMITED, LONDON, UNITED KINGDOM:
3,176,229, PUB. 9-12-2006. INT. CL. 28.
- PAPP, NICHOLAS GEORGE, JASPER, GA:
3,177,593, INT. CL. 11.
- PARABEN CORPORATION, PLEASANT GROVE, UT:
3,178,081, INT. CL. 22.

PARACELSIAN, INC., ITHACA, NY:
2,308,726, CANC. INT. CL. 42.

PARADIGM ELECTRONICS INCORPORATED, MISSISSAUGA, ONTARIO, CANADA:
1,403,877. REN. 10-24-06. INT. CL. 9.

PARADISE GALLERIES, INC., SAN DIEGO, CA:
3,177,945, INT. CL. 28.

PARADYSZ MATERA & CO., INC., NEW YORK, NY:
2,310,066, CANC. INT. CL. 35.

PARADYSZ MATERA CO., INC., NEW YORK, NY:
3,176,587, PUB. 9-12-2006. INT. CL. 35.

PARAMOUNT PICTURES CORPORATION, LOS ANGELES, CA:
1,949,625, CANC. INT. CL. 21.

PARASOFT CORPORATION, MONROVIA, CA:
3,177,700, INT. CL. 9.

PAREDES, KYLE T., PEARL CITY, HI:
3,176,001, PUB. 5-16-2006. INT. CL. 25.

PAREXLAHABRA, INC., ANAHEIM, CA:
1,914,956. REN. 10-26-06. INT. CL. 19.

PARFUMS CHRISTIAN DIOR, 75008 PARIS, FRANCE:
3,176,192, PUB. 9-12-2006. INT. CL. 3.
3,176,194, PUB. 9-12-2006. INT. CL. 3.

PARFUMS TED LAPIDUS S.A., 75008 PARIS, FRANCE:
2,309,584, CANC. INT. CL. 3.

PARIS GOURMET OF NEW YORK INC., CARLSTADT, NJ:
3,177,426, INT. CL. 30.

PARKEON, FRANCE:
3,177,191, PUB. 9-12-2006. MULTIPLE CLASS, INT. CLS. 9, 35, 37, 38, 39 AND 42.

PARKER MEDICAL ASSOCIATES, CHARLOTTE, NC:
2,309,263, CANC. INT. CL. 10.

PARMY INC, CITY OF INDUSTRY, CA:
3,176,152, PUB. 9-12-2006. MULTIPLE CLASS, INT. CLS. 20 AND 21.

PARNASSUS SYSTEMS, INC., AUSTIN, TX, DBA STORM-WATER RESEARCH GROUP:
2,308,737, CANC. INT. CL. 42.

PARSES, INC., TAMPA, FL:
3,176,965, PUB. 9-12-2006. INT. CL. 35.

PARTACZ, RONALD W., WEST SENECA, NY AND PARTACZ, MARCIA H., WEST SENECA, NY AND EWEN, JONATHAN R., WEST SENECA, NY AND STOVER, KRISTEN A., WEST SENECA, NY AND CRISTINA, JOSEPH R., DEPEW, NY:
3,178,147, INT. CL. 35.

PARTNERS IN TRAINING, INC., DENVER, CO, DBA FASTPLANET TECHNOLOGIES:
2,309,122, CANC. INT. CL. 42.

PASADENA REFINING SYSTEM, INC., PASADENA, TX:
3,176,340, PUB. 9-12-2006. INT. CL. 40.

PASTIFICIO F.LLI PAGANI S.P.A., 10-12 ROVATO, BRESCIA, ITALY:
1,992,756. REN. 10-21-06. INT. CL. 30.

PASTIFICIO LUCIO GAROFALO S.P.A., GRAGNANO (NAPOLI), ITALY:
3,177,383, INT. CL. 30.

PASTOR CHUCK ORCHARDS, LLC, PORTLAND, ME:
3,176,843, PUB. 9-12-2006. INT. CL. 29.

PATAGONIA, INC., VENTURA, CA:
1,378,224, CANC. INT. CL. 25.

PATEL, EVA, VISTA, CA:
3,175,852, PUB. 9-12-2006. INT. CL. 35.
3,175,854, PUB. 9-12-2006. INT. CL. 3.

PATELCO CREDIT UNION, SAN FRANCISCO, CA:
3,177,475, INT. CL. 36.
3,177,478, INT. CL. 36.

PATONS & BALDWIN LIMITED, DARLINGTON, COUNTY DURHAM, ENGLAND:
1,404,100. REN. 10-20-06. INT. CL. 23.

PATRIOT COMMUNICATIONS LLC, CULVER CITY, CA:
3,175,927, PUB. 9-12-2006. INT. CL. 35.

PATTERN EXPRESSIONS, LLC, LAWSON, MO:
3,178,510, INT. CL. 16.

PAULLIN INDUSTRIES, INC., ASHLAND, OH:
1,378,094, CANC. INT. CL. 17.

PAXEN GROUP, INC., THE, MELBOURNE, FL:
3,176,476, PUB. 9-12-2006. INT. CL. 41.

PAYCHEX OF NEW YORK, LLC, ROCHESTER, NY, JASON DATA SYSTEMS, INC., ALTAMONTE SPRINGS, FL:
1,991,199. REN. 10-25-06. INT. CL. 9.

PAYLESS SHOESOURCE WORLDWIDE, INC, TOPEKA, KS:
3,177,327, INT. CL. 25.

PAYLESS SHOESOURCE WORLDWIDE, INC., TOPEKA, KS:
2,308,243, CANC. INT. CL. 25.

PBQ DESIGNS, INC., UNDERWOOD, WA:
1,948,584, CANC. INT. CL. 21.

PCE ENGINEERING OY AB, 37801 TOIJALA, FINLAND:
2,308,311, CANC. MULTIPLE CLASS, INT. CLS. 7 AND 19.

PEACHTREE DOORS AND WINDOWS, INC., GAINESVILLE, GA:
3,177,096, PUB. 9-12-2006. INT. CL. 6.

PEAKE, INC., STERLING, VA:
3,177,070, PUB. 9-12-2006. INT. CL. 25.

PEARSON EDUCATION, INC., UPPER SADDLE RIVER, NJ:
3,177,869, INT. CL. 16.

PEDERSEN, LISA M., HERMOSA BEACH, CA:
3,178,160, MULTIPLE CLASS, INT. CLS. 41 AND 44.

PEI LICENSING, INC., MIAMI, FL:
2,309,754, CANC. INT. CL. 25.

PELICAN INTERNATIONAL INC., QUEBEC, CANADA:
3,176,064, PUB. 9-12-2006. INT. CL. 17.

PELLEGRINI BROTHERS WINES, INC., SOUTH SAN FRANCISCO, CA, DBA PELLEGRINI FAMILY VINEYARDS:
2,309,370, CANC. INT. CL. 33.

PELLICANO, ANTHONY, LOS ANGELES, CA:
2,308,245, CANC. INT. CL. 9.

PELLOUCHOUD, WILLIAM C., BOULDER, CO:
2,309,448, CANC. INT. CL. 16.

PEMBERTON, INC., LONGWOOD, FL:
2,309,788, CANC. INT. CL. 7.

PENDLETON ACADEMIES, PENDLETON, OR:
3,176,987, PUB. 9-12-2006. INT. CL. 41.
3,176,988, PUB. 9-12-2006. INT. CL. 44.

PENNWELL PUBLISHING COMPANY, TULSA, OK:
2,310,100, CANC. INT. CL. 16.

PENTA GROUP LTD., NEW YORK, NY:
3,178,476, INT. CL. 25.

PENTAIR FILTRATION, INC., SHEBOYGAN, WI:
3,176,799, PUB. 9-12-2006. INT. CL. 11.

PENTON OVERSEAS, INC., CARLSBAD, CA:
3,177,528, INT. CL. 9.

PEOPLE'S CHOICE TV CORP., SHELTON, CT:
2,308,220, CANC. INT. CL. 38.

PEOPLES BANK, PARIS, TX:
3,178,022, INT. CL. 41.

PEOPLEWEB COMMUNICATIONS, INC., SAN JOSE, CA:
2,308,445, CANC. INT. CL. 9.

PERDUE HOLDINGS, INC., WILMINGTON, DE:
1,992,128. REN. 10-25-06. INT. CL. 29.
3,176,469, PUB. 9-12-2006. INT. CL. 29.

PEREZ, LEO J., SAN CLEMENTE, CA:
3,178,598, INT. CL. 14.

PERFECT FIT INDUSTRIES, INC., MATTHEWS, NC, PRF CORPORATION, NEW YORK, NY:
1,046,409. REN. 10-25-06. INT. CL. 24.

PERFECT FIT INDUSTRIES, INC., MATTHEWS, NC, PRF CORPORATION, NEW YORK, NY, DBA PERFECT FIT INDUSTRIES, INC.:
1,046,416. REN. 10-25-06. INT. CL. 24.

PERLUCID CORPORATION, NESCONSET, NY:
2,308,696, CANC. INT. CL. 11.

PERNOD RICARD USA, WHITE PLAINS, NY:
3,177,634, INT. CL. 33.

PERRY, JASPER, ELLENWOOD, GA:
3,178,700, INT. CL. 16.

PERRY, STEPHEN, BURIEN, WA, DBA GRAPHIC RE-UNION:
1,948,897, CANC. INT. CL. 25.

PERSHING INVESTMENTS LLC, NEWARK, DE:
2,309,576, CANC. INT. CL. 36.

PESKIN, STEPHEN, PEARLAND, TX:
3,176,887, PUB. 9-12-2006. INT. CL. 5.

- PET INCORPORATED, MINNEAPOLIS, MN:
3,178,438, INT. CL. 29.
- PET ORAL CARE INTERNATIONAL, LLC, SCOTTSDALE, AZ:
3,177,904, INT. CL. 18.
- PETCARE PLUS, INC., AURORA, IL, DBA PETCARE SUPERSTORE TO PETCO ANIMAL SUPPLIES, INC., SAN DIEGO, CA:
1,949,610, CANC. INT. CL. 28.
- PETCO ANIMAL SUPPLIES, INC., SAN DIEGO, CA:
1,362,667, CANC. INT. CL. 42.
- PETER PAN INDUSTRIES, NEWARK, NJ:
2,309,255, CANC. INT. CL. 9.
- PETER STOKKEBYE TOBAKSFABRIK A/S, GELSTED, DENMARK:
1,378,348, CANC. INT. CL. 34.
- PETERS, BRUCE W., PITTSFORD, NY:
3,176,689, PUB. 9-12-2006. INT. CL. 41.
- PETROQUIMICA ESPANOLA, S.A., 28020 MADRID, SPAIN:
1,377,767, CANC. INT. CL. 1.
- PETSMART STORE SUPPORT GROUP, INC., PHOENIX, AZ:
3,177,178, PUB. 9-12-2006. INT. CL. 43.
- PFIZER INC., NEW YORK, NY:
2,309,680, CANC. INT. CL. 16.
3,177,701, INT. CL. 16.
- PFLANZ INTEGRATED SYSTEMS, SIOUX CITY, IA:
3,178,759, INT. CL. 9.
- PFLAUMER BROTHERS, INC., NORRISTOWN, PA:
2,309,090, CANC. INT. CL. 1.
2,309,091, CANC. INT. CL. 1.
2,309,092, CANC. INT. CL. 1.
- PFRIMMER-VIGGO GMBH & CO KG, ERLANGEN, FED REP GERMANY:
1,377,885, CANC. INT. CL. 7.
- PHARMAVITE, LLC, MISSION HILLS, CA:
3,176,136, PUB. 9-12-2006. INT. CL. 5.
- PHE, INC., HILLSBOROUGH, NC:
2,462,066, COR. INT. CL. 35.
- PHILADELPHIA FILM SOCIETY, PHILADELPHIA, PA:
3,176,712, PUB. 9-12-2006. INT. CL. 41.
3,176,713, PUB. 9-12-2006. INT. CL. 41.
- PHILADELPHIA GAS WORKS, PHILADELPHIA, PA:
2,308,843, CANC. MULTIPLE CLASS, INT. CLS. 35, 37 AND 39.
3,176,837, PUB. 9-12-2006. INT. CL. 39.
- PHILIP B. PAYNE AND NANCY C. PAYNE, BOTH U.S. CITIZENS AS TRUSTEES OF THE TRUSTEE OF THE PAYNE LOVING TRUST, EDMONDS, WA:
2,309,481, CANC. INT. CL. 9.
- PHILLIPS PLASTICS CORPORATION, PHILLIPS, WI:
3,176,288, PUB. 9-12-2006. INT. CL. 11.
- PHILLIPS SYRUP LLC, CLEVELAND, OH:
1,374,918, REN. 10-20-06. MULTIPLE CLASS, INT. CLS. 29, 30 AND 32.
- PHILLIPS, ROBERT NIGEL, BURBANK, CA:
3,178,388, INT. CL. 41.
3,178,389, INT. CL. 25.
3,178,400, INT. CL. 25.
- PHISH, INC., BURLINGTON, VT:
2,309,873, CANC. INT. CL. 30.
- PHNS INC., DALLAS, TX:
3,177,955, INT. CL. 9.
3,177,957, INT. CL. 9.
3,177,958, INT. CL. 35.
3,177,959, INT. CL. 39.
- PHOENIX BRANDS LLC, STAMFORD, CT:
3,177,848, INT. CL. 3.
- PHOENIX INTEGRATION, INC., BLACKSBURG, VA:
3,177,060, PUB. 9-12-2006. INT. CL. 9.
- PHOTOFLEX, INC., WATSONVILLE, CA:
3,176,068, PUB. 9-12-2006. INT. CL. 9.
- PI BETA PHI FRATERNITY, TOWN & COUNTRY, MO:
3,176,470, PUB. 9-12-2006. INT. CL. 41.
- PICOSTAR, LLC, PALO ALTO, CA:
2,309,787, CANC. INT. CL. 9.
- PIER FIVE SERVICES, INC., BOSTON, MA:
1,949,099, CANC. INT. CL. 42.
- PIERCE SALES CO., INC., ORLANDO, FL:
2,389,913, CANC. INT. CL. 35.
- PIERCY, TRACY, VICTORIA, BRITISH COLUMBIA, CANADA:
3,176,203, PUB. 9-12-2006. INT. CL. 16.
- PIFER, GARY L., OCEANSIDE, CA:
3,176,285, PUB. 9-12-2006. INT. CL. 25.
- PILL-PAC, INC., LAS VEGAS, NV:
3,176,553, PUB. 9-12-2006. INT. CL. 20.
- PINEWOOD SHEPPERTON PLC, BUCKINGHAMSHIRE SLO ONH, UNITED KINGDOM:
1,947,832, CANC. MULTIPLE CLASS, INT. CLS. 9 AND 41.
- PINK DOT, INC., CAMARILLO, CA:
1,378,601, CANC. INT. CL. 42.
- PINKERTON, SCOTT L., PHOENIX, AZ:
3,176,352, PUB. 9-12-2006. INT. CL. 35.
- PINNACLE BANC GROUP, INC., OAK PARK, IL:
2,309,164, CANC. INT. CL. 36.
- PINNACLE COMMUNICATIONS INC., BELLEVUE, WA, DBA CAPITAL COMMUNICATIONS, INC.:
2,308,816, CANC. INT. CL. 16.
- PINNACLE TECHNOLOGY, INC., KIRKLIN, IN:
2,308,348, CANC. INT. CL. 9.
- PIONEER LICENSING SERVICES, INC., LAS VEGAS, NV:
3,178,480, INT. CL. 36.
3,178,481, INT. CL. 36.
3,178,482, INT. CL. 36.
- PIRELLI PNEUMATICI S.P.A., 20126 MILAN, ITALY:
3,175,772, PUB. 9-12-2006. MULTIPLE CLASS, INT. CLS. 12 AND 35.
- PITA PRODUCTS, L.L.C., FARMINGTON HILLS, MI:
2,309,254, CANC. INT. CL. 30.
- PITNEY BOWES INC., STAMFORD, CT:
2,309,868, CANC. INT. CL. 9.
- PIZZERIA UNO CORPORATION, WILMINGTON, DE:
3,178,788, INT. CL. 43.
- PLANET GROUP, INC., LONG BEACH, NY:
3,175,815, PUB. 9-12-2006. MULTIPLE CLASS, INT. CLS. 9 AND 36.
- PLANTRONICS, INC., SANTA CRUZ, CA:
3,178,488, INT. CL. 9.
- PLASTIC WELDING TECHNOLOGIES INTERNATIONAL, INC., DIAMOND SPRINGS, CA:
3,178,695, INT. CL. 16.
- PLASTRON PRODUCTS, HAMPTON, VA:
3,176,989, PUB. 9-12-2006. INT. CL. 20.
- PLATINUM TECHNOLOGY, INC., OAKBROOK TERRACE, IL:
2,308,137, CANC. INT. CL. 9.
- PLAYBOY ENTERPRISES INTERNATIONAL, INC., CHICAGO, IL:
3,176,641, PUB. 9-12-2006. INT. CL. 26.
- PLAYBOY ENTERPRISES, INC., CHICAGO, IL:
2,309,194, CANC. INT. CL. 9.
- PLAYSOUP, LLC, PARKER, CO:
3,177,956, INT. CL. 9.
- PLAYWORLD SYSTEMS, INC., LEWISBURG, PA, Q-E MANUFACTURING, INC., NEW BERLIN, PA, DBA PLAYWORLD SYSTEMS, INC.:
1,405,977, REN. 10-23-06. INT. CL. 28.
- PLEASE ASK, LLC, FORT LAUDERDALE, FL:
3,177,635, INT. CL. 20.
- PLUMBERS' SUCCESS INTERNATIONAL, LLC, ST. LOUIS, MO:
3,176,232, PUB. 9-12-2006. INT. CL. 11.
- PLUMMER TRUCKING, INC., LATTY, OH:
2,308,672, CANC. INT. CL. 39.
- PN II, INC., BLOOMFIELD HILLS, MI:
2,308,643, CANC. INT. CL. 37.
- POLAR TECH INDUSTRIES, INC., GENOA, IL:
2,069,764, REN. 10-24-06. INT. CL. 1.
- POLARIS INDUSTRIES INC., MEDINA, MN:
3,177,153, PUB. 9-12-2006. INT. CL. 12.
3,177,165, PUB. 9-12-2006. INT. CL. 12.
- POLICE ORDANCE COMPANY INC., MARKHAM, ONTARIO, CANADA:
1,404,833, REN. 10-26-06. INT. CL. 13.

POLO FASHIONS INC., NEW YORK, NY:
 1,378,247, CANC. INT. CL. 25.
 POLVI, S JACOB, BEND, OR:
 3,178,461, INT. CL. 35.
 POLY-TUFF SYSTEMS INTERNATIONAL CORPORATION,
 LAS VEGAS, NV:
 3,175,827, PUB. 9-12-2006. INT. CL. 1.
 POLYGRAM INTERNATIONAL MUSIC B.V., BAARN,
 NETHERLANDS:
 2,308,352, CANC. INT. CL. 9.
 POLYTITE MANUFACTURING CORPORATION, CAM-
 BRIDGE, MA:
 2,308,755, CANC. INT. CL. 17.
 POLZIN, LYLE D., MEMPHIS, TN:
 2,309,387, CANC. INT. CL. 28.
 POMOGO CORPORATION, RIDGEWOOD, NY:
 3,176,642, PUB. 9-12-2006. INT. CL. 9.
 POMPADOUR MODE GMBH, GOMARINGEN, FED REP
 GERMANY:
 1,378,154, CANC. INT. CL. 25.
 POOF-SLINKY, INC., PLYMOUTH, MI:
 427,951. REN. 10-20-06. U.S. CL. 22 (INT. CL. 28).
 POP-CULTURE ENTERTAINMENT, INC., WESTON, FL:
 2,308,538, CANC. INT. CL. 41.
 POPE ASSOCIATES INC., ST. PAUL, MN:
 3,129,834, COR. INT. CL. 42.
 3,129,835, COR. INT. CL. 42.
 3,129,839, COR. INT. CL. 42.
 POPMED, INC., BEVERLY, MA:
 3,178,814, INT. CL. 44.
 POPPIN AND COMPANY, UNITY, ME:
 2,308,471, CANC. INT. CL. 16.
 PORTAUTHORITY TECHNOLOGIES, INC., PALO ALTO,
 CA:
 3,178,443, INT. CL. 35.
 PORTEC RAIL PRODUCTS, INC., PITTSBURGH, PA, POR-
 TEC, INC., LAKE FOREST, IL:
 1,988,128. REN. 10-22-06. INT. CL. 7.
 PORTER, JESSICA L., NEW YORK CITY, NY:
 3,178,552, INT. CL. 35.
 PORTICUS TECHNOLOGY, INC., NEEDHAM, MA:
 3,177,547, INT. CL. 9.
 PORTLAND PIRATES, LLC, PORTLAND, ME:
 3,175,753, PUB. 6-6-1995. INT. CL. 25.
 PORTLAND TEACHERS CREDIT UNION, PORTLAND, OR:
 3,177,558, INT. CL. 36.
 3,177,583, INT. CL. 36.
 3,177,584, INT. CL. 36.
 PORTRAITS NOW INC., OMAHA, NE:
 2,308,645, CANC. INT. CL. 42.
 POSALSKI, IRVING, BEVERLY HILLS, CA, DBA 21ST
 SENTRY HEALTH SYSTEMS INTERNATIONAL:
 2,310,018, CANC. INT. CL. 5.
 POST APARTMENT HOMES, L.P., ATLANTA, GA:
 2,308,648, CANC. INT. CL. 36.
 POST APARTMENT HOMES, L.P., ATLANTA, GA:
 2,308,647, CANC. INT. CL. 36.
 POTLAND PIRATES, LLC, PORTLAND, ME:
 3,175,754, PUB. 6-13-1995. INT. CL. 41.
 POTLATCH CORPORATION, SPOKANE, WA:
 3,178,564, INT. CL. 16.
 POTTER, TODD, MUKWONAGO, WI:
 2,308,902, CANC. INT. CL. 35.
 POWAY CHAMBER OF COMMERCE, POWAY, CA:
 2,308,365, CANC. MULTIPLE CLASS, INT. CLS. 35 AND
 41.
 POWELL, JOHN, BURLINGAME, CA AND POWELL, DE-
 BORAH, BURLINGAME, CA:
 2,309,030, CANC. INT. CL. 41.
 POWER WELL SERVICES, INC., HOUSTON, TX:
 3,178,013, INT. CL. 7.
 3,178,014, INT. CL. 42.
 POWER-BIKE GMBH, SWITZERLAND:
 3,177,278, PUB. 9-12-2006. MULTIPLE CLASS, INT. CLS. 9
 AND 25.
 POWERLIGHT CORPORATION, BERKELEY, CA:
 3,176,393, PUB. 9-12-2006. MULTIPLE CLASS, INT. CLS. 9
 AND 19.
 PPC MARKETING, LTD., PITTSBURGH, TX:
 3,178,467, INT. CL. 29.
 3,178,495, INT. CL. 29.
 PRAIRIEWEB INTERNET MARKETING, AURORA, IL:
 2,308,971, CANC. INT. CL. 35.
 PRATT, RANDOLPH, PLANDOME MANOR, NY:
 2,308,441, CANC. INT. CL. 9.
 PRECIOUS BABY DOLL COMPANY, LLC, ROCHESTER,
 MI:
 3,177,524, INT. CL. 28.
 PRECIPIA SYSTEMS, INC., ARLINGTON, VA:
 3,176,685, PUB. 9-12-2006. INT. CL. 42.
 PRECISION REPORTS, INC., BAINBRIDGE ISLAND, WA
 AND HONICK, CRAIG A., BAINBRIDGE ISLAND, WA:
 3,176,777, PUB. 9-12-2006. INT. CL. 35.
 PRECISION SOLUTIONS, INC., PEARLAND, TX:
 2,308,428, CANC. INT. CL. 9.
 PREFERRED MEAL SYSTEMS, INC., BERKELEY, IL:
 3,178,516, INT. CL. 30.
 PREFERRED NETWORK, INC., LONG BEACH, CA:
 1,378,397, CANC. INT. CL. 36.
 PREMA PRODUCTS, INC., NORTHVALE, NJ:
 3,177,673, INT. CL. 1.
 PREMARK FEG L.L.C., WILMINGTON, DE, HOBART
 MANUFACTURING COMPANY, THE, TROY, OH:
 637,082. REN. 10-25-06. U.S. CL. 21 (INT. CL. 9).
 PREMIER COMMUNICATIONS, INC., ATLANTA, GA:
 2,308,152, CANC. INT. CL. 42.
 PREMIER HEALTH CARE SERVICES, INC., DAYTON, OH:
 3,178,233, INT. CL. 44.
 PREMIER PET PRODUCTS, LLC, MIDLOTHIAN, VA:
 3,177,121, PUB. 9-12-2006. INT. CL. 28.
 PREPAID WIRELESS HOLDINGS, L.P., HOUSTON, TX:
 2,308,169, CANC. INT. CL. 36.
 PRESENTATION GRAPHICS, INC., PHILADELPHIA, PA:
 1,378,379, CANC. INT. CL. 35.
 PRESIDENTS OF THE UNITED STATES OF AMERICA,
 THE, BELLEVUE, WA:
 1,995,593, REN. 10-26-06. INT. CL. 41.
 PRESNAL, JENNIFER, PEORIA, AZ:
 3,177,003, PUB. 9-12-2006. INT. CL. 41.
 PREVO'S FAMILY MARKETS, INC., GRAND RAPIDS, MI:
 3,177,820, INT. CL. 35.
 PRICE ADVANCED INNOVATIONS, INC., RENO, NV:
 2,309,446, CANC. INT. CL. 28.
 PRICE INDUSTRIES, INC., DUTTON, MI:
 2,308,687, CANC. INT. CL. 7.
 PRIMADONNA COMPANY, LLC, PRIMM, NV:
 3,177,732, INT. CL. 41.
 PRIME LABEL CONSULTANTS, INC, WASHINGTON, DC:
 2,308,614, CANC. INT. CL. 9.
 2,309,001, CANC. INT. CL. 9.
 PRIME SITES, INC., LOS ANGELES, CA:
 3,178,797, INT. CL. 35.
 3,178,798, INT. CL. 41.
 PRIME-LINE PRODUCTS COMPANY, SAN BERNARDINO,
 CA:
 3,175,878, PUB. 9-12-2006. MULTIPLE CLASS, INT. CLS. 6
 AND 20.
 PRIMEDIA INTERTEC CORPORATION, OVERLAND
 PARK, KS:
 2,309,771, CANC. INT. CL. 16.
 PRIMO INCENSE DISTRIBUTING COMPANY OF ORE-
 GON, INC., BEAVERTON, OR:
 1,046,622. REN. 10-26-06. INT. CL. 3.
 PRINCE CORPORATION, HOLLAND, MI:
 2,309,534, CANC. INT. CL. 12.
 2,309,681, CANC. INT. CL. 9.
 PRINCE LIONHEART, INC., SANTA MARIA, CA:
 3,177,928, INT. CL. 28.
 PRINTABLE TECHNOLOGIES INC., SOLANA BEACH, CA:
 3,178,271, INT. CL. 9.
 3,178,272, INT. CL. 9.
 PRISM BUSINESS MEDIA INC., NEW YORK, NY, INTER-
 TEC PUBLISHING CORPORATION, OVERLAND PARK,
 KS:
 1,996,456. REN. 10-26-06. INT. CL. 16.

- PRISM BUSINESS MEDIA INC., NEW YORK, NY:
2,309,445, CANC. INT. CL. 16.
2,309,648, CANC. INT. CL. 16.
- PRISM INTERNATIONAL LTD., GLENVIEW, IL TO FAR &
WIDE TRAVEL CORPORATION, MIAMI, FL:
1,948,541, CANC. INT. CL. 39.
- PRISM SOFTWARE SOLUTIONS, INC., ST. PAUL, MN:
2,309,673, CANC. INT. CL. 9.
- PRIVACY STRIPS, LLC, WINTER PARK, FL:
3,176,846, PUB. 9-12-2006. INT. CL. 26.
- PRIVATE FORMULATIONS, INC., EDISON, NJ TO LEINER
HEALTH SERVICES CORP., CARSON, CA:
1,948,508, CANC. INT. CL. 5.
- PRIVITY VENTURES, INC., CARSON CITY, NV:
3,177,605, INT. CL. 9.
- PRN CORPORATION, SAN FRANCISCO, CA:
3,178,021, INT. CL. 35.
- PRO PERFORMANCE, LLC, MORGANTOWN, WV:
3,176,969, PUB. 9-12-2006. INT. CL. 28.
- PRO-KENNEX, INC., SAN DIEGO, CA:
2,309,844, CANC. INT. CL. 28.
- PRO-KIDS, NASHVILLE, TN:
1,378,504, CANC. INT. CL. 41.
- PROBITA, INC., BOULDER, CO:
2,308,369, CANC. INT. CL. 9.
- PROCHAPS EQUESTRIAN EQUIPMENT INC., MONTREAL,
CANADA:
3,176,365, PUB. 9-12-2006. INT. CL. 25.
- PROCOAT PRODUCTS, INC., HOLBROOK, MA:
1,992,963, REN. 10-20-06. INT. CL. 1.
- PROCOM TECHNOLOGY, IRVINE, CA:
2,308,404, CANC. INT. CL. 9.
- PROCTER & GAMBLE COMPANY, THE, CINCINNATI, OH:
1,958,499, REN. 10-25-06. INT. CL. 5.
2,309,525, CANC. INT. CL. 16.
3,176,627, PUB. 9-12-2006. INT. CL. 16.
- PROCYTE CORPORATION, REDMOND, WA:
2,415,772, CANC. INT. CL. 5.
- PRODIS INTERNATIONAL, INC., NEW YORK, NY TO
MCLANE/AMERICA, INC., TEMPLE, TX:
1,378,306, CANC. MULTIPLE CLASS, INT. CLS. 29, 30
AND 32.
- PRODUCERS CHOICE, INC., STERLING HEIGHTS, MI:
3,176,107, PUB. 6-6-2006. INT. CL. 36.
- PRODUCT RISK REDUCTION, INC., ROCKY RIVER, OH:
3,176,738, PUB. 9-12-2006. INT. CL. 35.
- PRODUCTION FINANCE INTERNATIONAL L.L.C., SPO-
KANE, WA, EFFE SPORTSWEAR (USA) INC., CARLS-
BAD, CA:
1,981,840, REN. 10-23-06. INT. CL. 25.
- PRODUCTION FINANCE INTERNATIONAL L.L.C., SPO-
KANE, WA, EFFE SPORTSWEAR (U.S.A.) INC., CARLS-
BAD, CA:
1,994,102, REN. 10-23-06. INT. CL. 25.
- PROFESSIONAL CHECK SYSTEMS, INC., CLAYTON, MO:
2,308,341, CANC. INT. CL. 9.
- PROFESSIONAL COATING TECHNOLOGIES INC., CEDAR
HILL, TX:
3,177,398, INT. CL. 19.
- PROFESSIONAL DEVELOPMENT GROUP, INC., PITTS-
FORD, NY:
3,177,697, INT. CL. 35.
- PROFESSIONAL EDUCATION INTERNATIONAL, INC.,
CHICAGO, IL:
3,178,511, INT. CL. 41.
- PROFESSIONAL LIABILITY MANAGEMENT OF AMERI-
CA, INC., AKRON, OH:
3,176,623, PUB. 9-12-2006. INT. CL. 36.
- PROFESSIONAL RODEO COWBOYS ASSOCIATION, INC.,
COLORADO SPRINGS, CO:
2,309,506, CANC. INT. CL. 25.
- PROFESSIONAL TRAINING SEMINAR SERVICES, LLC,
HELENA, MT:
2,308,844, CANC. INT. CL. 41.
- PROGRAM PLANNING PROFESSIONALS, INC., ANN AR-
BOR, MI:
3,178,716, INT. CL. 35.
- PROGRESS LIGHTING PROPERTIES, INC., TROY, MI,
PROGRESS LIGHTING INC., SPARTANBURG, SC:
2,002,728, REN. 10-25-06. INT. CL. 11.
- PROMARK INTERNATIONAL, INC., BOISE, ID:
2,309,815, CANC. INT. CL. 31.
- PROMEDICA HEALTH SYSTEM, TOLEDO, OH:
3,178,723, INT. CL. 35.
- PROMEGA CORPORATION, MADISON, WI:
2,043,645, REN. 10-26-06. INT. CL. 1.
- PROMOITALIA COSMETIC LINE S.R.L., NAPLES, ITALY:
3,177,229, PUB. 9-12-2006. MULTIPLE CLASS, INT. CLS. 3
AND 5.
- PROPANE RESOURCES, L.L.C., MISSION, KS:
2,308,582, CANC. INT. CL. 35.
- PROPER MOLD & ENGINEERING, INC., CENTERLINE,
MI:
2,308,746, CANC. INT. CL. 40.
- PROPESY TRANSPORTATION SOLUTIONS, INC.,
BLOOMFIELD, CT, INFORMATION SOFTWARE, INC.,
BLOOMFIELD, CT:
2,002,960, REN. 10-23-06. INT. CL. 9.
- PROPESY TRANSPORTATION SOLUTIONS, INC.,
BLOOMFIELD, CT:
2,002,996, REN. 10-23-06. INT. CL. 9.
- PROPHET FINANCIAL SYSTEMS, INC., PALO ALTO, CA:
3,176,819, PUB. 9-12-2006. INT. CL. 36.
- PROQUEST INFORMATION AND LEARNING COMPANY,
ANN ARBOR, MI, UMI COMPANY, ANN ARBOR, MI:
2,002,505, REN. 10-25-06. INT. CL. 40.
- PROSANOS CORPORATION, LA JOLLA, CA:
3,175,793, PUB. 9-12-2006. MULTIPLE CLASS, INT. CLS.
39 AND 42.
- PROTEK DEVICES, LP, TEMPE, AZ:
3,178,175, INT. CL. 9.
3,178,178, INT. CL. 9.
- PROVIDENT BANCORP, INC., SUFFERN (VILLAGE OF
MONTEBELLO), NY, DBA PROVIDENT BANK:
3,175,830, PUB. 9-12-2006. INT. CL. 36.
- PRYM CONSUMER USA INC., SPARTANBURG, SC, PRYM-
DRITZ CORPORATION, SPARTANBURG, SC:
2,053,861, REN. 10-22-06. MULTIPLE CLASS, INT. CLS.
23 AND 26.
- PRZEDSIĘBIORSTWO HANDLU ZAGRANICZNEGO
"AGROS", WARSAW, POLAND:
825,043, CANC. U.S. CL. 49.
- PRZEDSIĘBIORSTWO USŁUGOWE "ZNAKI WSPOLNE"
SPÓŁKA Z OGRANICZONA ODPOWIEDZIALNOSCIA,
03-908 WARSAW, POLAND:
1,387,007, REN. 10-23-06. INT. CL. 33.
- PSICHOMETRICS INTERNATIONAL, LLC, ROSWELL, GA:
3,175,909, PUB. 9-12-2006. INT. CL. 42.
3,175,912, PUB. 9-12-2006. INT. CL. 42.
- PUBLIC CLOTHING COMPANY, NEW YORK, NY:
2,308,318, CANC. INT. CL. 25.
- PUBLIC SERVICE COMPANY OF COLORADO, DENVER,
CO:
1,378,469, CANC. INT. CL. 39.
- PUBLICATIONS INK PRINTING CENTERS, INC., BERKE-
LEY, CA TO SIRIUS INFORMATION, INC., EMERY-
VILLE, CA:
1,948,102, CANC. INT. CL. 16.
- PULLBRITE, INC., FREMONT, CA:
1,993,594, REN. 10-24-06. INT. CL. 40.
- PUREOLOGY RESEARCH, LLC, IRVINE, CA:
3,178,561, INT. CL. 3.
- PURPLECOMM, INC., SANTA CLARA, CA:
3,178,565, INT. CL. 38.
- PURSUIT MARKETING, INC., DES PLAINES, IL:
3,177,626, INT. CL. 28.
- PUTNAM SOURCING GROUP, INC., VERNON, CA:
3,177,549, INT. CL. 25.
- PV POWERED, LLC, BEND, OR:
3,176,243, PUB. 9-12-2006. INT. CL. 9.
- PYLE, EDWIN T., MCPHERSON, KS, DBA RED COACH
INN:
1,378,523, CANC. INT. CL. 42.
- PYXIS MOBILE, INC., WALTHAM, MA:
3,176,715, PUB. 9-12-2006. INT. CL. 9.

Q INDUSTRIES, INC., DENVER, CO, DBA DV INNOVATIONS:
3,177,033, PUB. 9-12-2006. INT. CL. 7.
3,177,035, PUB. 9-12-2006. INT. CL. 7.

QARMOUT, ELIAS, DALY CITY, CA:
3,176,516, PUB. 9-12-2006. INT. CL. 16.

QIOSK.COM, INC., GRAND CAYMAN, CAYMAN ISLANDS:
3,177,330, MULTIPLE CLASS, INT. CLS. 9 AND 41.

QLOGIC CORPORATION, ALISO VIEJO, CA:
3,177,941, INT. CL. 9.

QORTEK, INC., WILLIAMSPORT, PA:
3,177,410, INT. CL. 9.

QT, INC., ELK GROVE VILLAGE, IL:
3,177,615, INT. CL. 14.

QUADAMI, INC., CARLE PLACE, NY:
1,987,807, REN. 10-22-06. INT. CL. 30.

QUADRALAY CORPORATION, AUSTIN, TX:
2,033,315, REN. 10-25-06. INT. CL. 9.

QUADRAMED CORPORATION, RESTON, VA:
2,308,563, CANC. INT. CL. 9.

QUAKING HILLS WINERY, INC., CLOVERDALE, CA:
3,177,407, INT. CL. 33.

QUALITY REP SERVICES, INC., KNOXVILLE, TN:
2,308,317, CANC. INT. CL. 9.

QUANTUM LEAP SALES & MARKETING, INC., DENVER, CO:
2,309,117, CANC. INT. CL. 35.

QUANTUM OPTICS, INC., SMITHFIELD, RI:
2,309,729, CANC. INT. CL. 9.

QUANTUM3D, INC., SAN JOSE, CA:
3,175,826, PUB. 9-12-2006. INT. CL. 9.

QUENCH CO., LLC, SEATTLE, WA:
1,047,788, REN. 10-21-06. INT. CL. 30.

QUEPASA CORPORATION, PHOENIX, AZ:
3,176,519, PUB. 9-12-2006. INT. CL. 45.

QUEST PRODUCTS, INC., EARTH CITY, MO:
1,949,506, CANC. INT. CL. 20.

QUIN, MARY P., ANCHORAGE, AK:
3,177,999, INT. CL. 35.

QUOMATION INSURANCE SERVICES, INC., OREM, UT:
3,176,972, PUB. 9-12-2006. INT. CL. 36.

QVP FAMILY PRODUCTS, INC., AMHERST, NY:
2,309,360, CANC. INT. CL. 3.

QWEST COMMUNICATIONS INTERNATIONAL INC., DENVER, CO:
3,177,184, PUB. 9-12-2006. INT. CL. 38.
3,177,692, INT. CL. 41.
3,177,854, INT. CL. 43.
3,177,926, INT. CL. 43.

QWICK KURB, INC., RUSKIN, FL, CLOVERLEAF CORPORATION, LAKELAND, FL:
2,037,719, REN. 10-25-06. INT. CL. 9.

R. E. WRIGHT ASSOCIATES, INC., MIDDLETOWN, PA TO SCIENCE APPLICATIONS INTERNATIONAL CORPORATION, SAN DIEGO, CA:
1,948,194, CANC. INT. CL. 11.

R. L. POLK & CO., SOUTHFIELD, MI:
1,966,424, REN. 10-26-06. INT. CL. 9.
1,970,988, REN. 10-26-06. INT. CL. 9.

R. SOLOM CO. LIMITED, BRAMPTON, ONTARIO L6T 4X3, CANADA:
1,378,132, CANC. INT. CL. 21.

R. T. VANDERBILT COMPANY, INC., NORWALK, CT, ROBERT J. KING COMPANY, INC., THE NORWALK, CT:
816,464, REN. 10-20-06. U.S. CL. 6 (INT. CL. 1).

R.A. INTERNATIONAL, INC., BURLINGTON, VT:
3,177,819, INT. CL. 35.

R.A. RASMUSSEN & SONS, INC., UNION GAP, WA:
1,948,880, CANC. INT. CL. 41.

R.D. SIMPSON, INC., NEW YORK, NY:
3,178,758, INT. CL. 25.

R.T. VANDERBILT COMPANY, INC., NORWALK, CT:
221,908, REN. 10-20-06. U.S. CL. 6 (INT. CL. 1).

RA BRANDS LLC, MADISON, NC, REMINGTON ARMS COMPANY, INC., WILMINGTON, DE:
2,035,984, REN. 10-26-06. INT. CL. 3.

RACINE FEDERATED, INC., RACINE, WI, PRESO METERS CORPORATION, PLATTSBURGH, NY:
1,990,969, REN. 10-24-06. INT. CL. 9.

RAD DATA COMMUNICATIONS, TEL AVIV, ISRAEL:
3,178,803, INT. CL. 9.

RADIAN GUARANTY INC., PHILADELPHIA, PA:
3,177,563, INT. CL. 36.

RADIO FLYER INC., CHICAGO, IL:
3,178,038, INT. CL. 28.

RADIO FORMULA, S.A., MIGUEL HIDALGO D.F., MEXICO:
3,177,862, MULTIPLE CLASS, INT. CLS. 38 AND 41.

RADO UHREN AG (RADO WATCH CO. LTD.) (MONTRES RADO S.A.), LENGNAU, SWITZERLAND:
3,177,607, INT. CL. 9.

RAFAEL'S FOODS, LLC, LOS LUNAS, NM:
3,176,330, PUB. 9-12-2006. INT. CL. 32.

RAFFLES INTERNATIONAL LIMITED, SINGAPORE, SINGAPORE:
3,178,226, INT. CL. 25.

RAHIM, ELEANOR, LONDON, UNITED KINGDOM:
3,176,211, PUB. 9-12-2006. INT. CL. 42.

RAIMONDI, GEORGIA, STAMFORD, CT:
3,177,352, INT. CL. 41.

RAINTREE ESSIX INC., WILMINGTON, DE:
3,178,291, INT. CL. 10.

RAISING CANE'S U.S.A., LLC, BATON ROUGE, LA:
3,177,932, INT. CL. 43.

RAKE'S PROGRESS, INC., THE, NEW YORK, NY:
1,949,256, CANC. INT. CL. 16.

RALEIGH DESIGNER'S SHOWROOM, INC., CHARLOTTE, NC, DBA RALEIGH DESIGNER'S RESOURCE:
2,310,098, CANC. INT. CL. 42.

RALEY'S TM, INC., WEST SACRAMENTO, CA:
3,178,507, INT. CL. 9.
3,178,508, INT. CL. 30.

RALSTON PURINA COMPANY, ST. LOUIS, MO:
1,949,300, CANC. INT. CL. 31.

RANDALL PRODUCTIONS COMPANY, CLEVELAND, OH:
3,177,501, MULTIPLE CLASS, INT. CLS. 34 AND 35.

RANDOM HOUSE, INC., NEW YORK, NY, DELL PUBLISHING CO., INC., NEW YORK, NY:
823,663, REN. 10-26-06. U.S. CL. 38 (INT. CL. 16).

RANDOM HOUSE, INC., NEW YORK, NY:
1,424,781, REN. 10-26-06. INT. CL. 16.

RANDY MARION CHEVROLET PONTIAC BUICK, MOORESVILLE, NC:
3,176,103, PUB. 9-12-2006. INT. CL. 35.

RANIR, LLC, GRAND RAPIDS, MI:
3,177,180, PUB. 9-12-2006. INT. CL. 21.

RANNOCH CORPORATION, ALEXANDRIA, VA:
2,308,517, CANC. INT. CL. 42.

RAPPORT SHAFT TECHNOLOGIES, LLC, WESTFIELD, IN:
3,177,879, INT. CL. 28.

RAYCO MANUFACTURING, INC., WOOSTER, OH:
3,178,261, INT. CL. 7.

RBMARK, INC., WILMINGTON, DE:
1,403,855, REN. 10-20-06. INT. CL. 9.

RDL DESIGNS, LLC, NORTH HOLLYWOOD, CA:
3,178,730, INT. CL. 3.

RDSP I, L.P., HOUSTON, TX:
3,176,974, PUB. 9-12-2006. INT. CL. 35.

READER'S DIGEST ASSOCIATION, INC., THE, PLEASANTVILLE, NY:
2,310,013, CANC. INT. CL. 16.

READING COMPREHENSION MINISTRY, MISSOULA, MT:
3,178,789, INT. CL. 16.

REAL ESTATE COLLABORATIVE, ORLANDO, FL:
3,175,817, PUB. 9-12-2006. INT. CL. 35.

REAL ESTATE ONE, INC., SOUTHFIELD, MI:
3,175,768, PUB. 9-12-2006. INT. CL. 36.

REAL INDIGO, LLC, CHARLOTTE, NC:
3,178,594, INT. CL. 25.
3,178,595, INT. CL. 25.

REAL 3D, INC., ORLANDO, FL:
2,308,641, CANC. INT. CL. 9.

- REAL-E STUDIOS, LLC, ARVADA, CO:
3,177,708, INT. CL. 9.
- REALITY S.R.L., SARONNO, ITALY:
3,081,783, COR. MULTIPLE CLASS, INT. CLS. 3 AND 9.
- REALPAGE, INC., CARROLLTON, TX:
3,176,528, PUB. 9-12-2006. MULTIPLE CLASS, INT. CLS.
35 AND 42.
- REALSYNC U.S.A., INDUSTRY, CA:
3,175,760, PUB. 11-11-2003. INT. CL. 9.
- REBERLAND EQUIPMENT, INC., APPLE CREEK, OH:
3,176,922, PUB. 9-12-2006. INT. CL. 12.
- REBOUND, LLC, NEWBURG, NY, HAGELIN & COMPANY,
INC., BRANCHBURG, NJ:
1,992,043. REN. 10-26-06. INT. CL. 32.
- RECKITT BENCKISER INC., PARSIPPANY, NJ:
3,177,793, INT. CL. 3.
3,178,551, INT. CL. 3.
- RECLAIM SERVICE TECHNOLOGIES, INC., CHICAGO, IL:
2,308,920, CANC. INT. CL. 37.
- RECOGNIX, INC., SANTA CLARA, CA:
2,308,314, CANC. INT. CL. 9.
- RECORDING INDUSTRY ASSOCIATION OF AMERICA,
INC., WASHINGTON, DC:
3,178,693, INT. CL. 41.
- RED CANYON COMPANY, MINNEAPOLIS, MN:
3,176,581, PUB. 9-12-2006. INT. CL. 37.
- RED CHIP COMPANY LTD., CAY ROAD TOWN, TORTO-
LA, BR. VIRGIN ISLANDS:
3,177,763, INT. CL. 9.
- RED HEAD, INC., NOVATO, CA, DBA CABO WABO
ENTERPRISES:
3,177,356, INT. CL. 33.
- REDCATS USA, L.P., INDIANAPOLIS, IN:
3,178,286, INT. CL. 25.
- REDMOND, CYNTHIA, SHOREWOOD, MN:
3,178,456, INT. CL. 41.
- REDMOND, SCOTT, SAN FRANCISCO, CA, DBA IMAGI-
NEOS:
2,308,258, CANC. INT. CL. 35.
- REED ELECTRIC CO., WASHINGTON, DC:
2,308,307, CANC. INT. CL. 37.
- REED ELSEVIER INC., NEWTON, MA:
2,309,198, CANC. INT. CL. 9.
- REED ELSEVIER PROPERTIES INC., WILMINGTON, DE:
2,308,655, CANC. INT. CL. 42.
- REED PUBLISHING (NEDERLAND) BV, AMSTERDAM,
NETHERLANDS:
3,176,904, PUB. 9-12-2006. INT. CL. 16.
- REED, MARY HUTCHINGS, CHICAGO, IL AND POWELL,
CURT, CHICAGO, IL:
3,178,213, INT. CL. 35.
- REED, MINDY, PALMDALE, CA:
3,176,999, PUB. 9-12-2006. INT. CL. 35.
- REED, THOMAS, AURORA, CO:
3,177,988, INT. CL. 37.
- REEDER, JOHNNA MATTHEWS, WASHINGTON, DC:
2,308,846, CANC. INT. CL. 35.
- REEVES, PAULA M., STONE MOUNTAIN, GA:
3,176,111, PUB. 9-12-2006. INT. CL. 41.
- REFERENTIA SYSTEMS INCORPORATED, HONOLULU,
HI:
2,309,785, CANC. INT. CL. 9.
- REGAL CINEMEDIA CORPORATION, CENTENNIAL, CO:
3,175,779, PUB. 8-24-2004. MULTIPLE CLASS, INT. CLS.
35 AND 41.
- REGAL LAGER, INC., KENNESAY, GA:
3,177,445, MULTIPLE CLASS, INT. CLS. 10, 11, 21 AND
25.
- REGIONS ASSET COMPANY, WILMINGTON, DE:
1,957,997. REN. 10-26-06. INT. CL. 36.
- REGULAR RICHES LLC, ATLANTA, GA:
3,178,473, INT. CL. 41.
- REHAB SERVICES, INC., BLOOMINGTON, MN:
1,378,590, CANC. INT. CL. 42.
- REHCO, LLC, CHICAGO, IL:
3,177,878, INT. CL. 21.
- REIKO WIRELESS INC., COLLEGE POINT, NY:
3,177,021, PUB. 9-12-2006. INT. CL. 9.
- REILLEY'S OF HILTON HEAD, LTD., HILTON HEAD
ISLAND, SC:
1,948,988, CANC. INT. CL. 42.
- REL-TEK CORPORATION, MONROEVILLE, PA:
2,309,125, CANC. INT. CL. 9.
2,309,126, CANC. INT. CL. 9.
2,309,127, CANC. INT. CL. 9.
2,309,129, CANC. INT. CL. 9.
- RELAX... WE DRIVE, LLC, CHICAGO, IL:
3,177,108, PUB. 9-12-2006. INT. CL. 39.
- RELCO CORPORATION, OVERLAND PARK, KS:
1,948,028, CANC. INT. CL. 42.
- RELOCATION CENTRAL CORPORATION, SANTA CLARA,
CA:
2,308,228, CANC. INT. CL. 35.
- RELOCATION RESOURCES INTERNATIONAL, INC., NOR-
WELL, MA:
2,308,919, CANC. INT. CL. 35.
- REM ENTERPRISES INC., HUNTINGTON BEACH, CA:
2,308,996, CANC. INT. CL. 20.
- REMY COINTREAU USA, INC., NEW YORK, NY:
1,378,344, CANC. INT. CL. 33.
- RENAISSANCE LEARNING, INC., WISCONSIN RAPIDS,
WI, PLAZA, JILL A., PALATINE, IL, DBA READING AND
EDUCATIONAL CONSULTANTS:
1,426,917. REN. 10-22-06. INT. CL. 41.
- RENBOW INTERNATIONAL U.S.A., LTD., READING, PA:
2,309,012, CANC. INT. CL. 3.
- RENFRO CORPORATION, MOUNT AIRY, NC:
2,309,762, CANC. INT. CL. 25.
- RENTZ, KRISTEN C., SANTA MONICA, CA:
3,178,236, MULTIPLE CLASS, INT. CLS. 16 AND 41.
- REPUBLICAN NATIONAL COMMITTEE, WASHINGTON,
DC:
1,994,455. REN. 10-25-06. MULTIPLE CLASS, INT. CLS.
16, 38 AND 41.
- RESEARCH THINK TANK, INC., ALPHARETTA, GA:
3,177,876, INT. CL. 42.
- RESIN RESEARCH, INC., INDIAN HARBOUR BEACH, FL:
3,178,763, INT. CL. 1.
- RESISTA-TEMPS INC., INDIANAPOLIS, IN:
3,175,965, PUB. 10-25-2005. INT. CL. 10.
- RESOLUTION HEALTH, INC., SAN JOSE, CA:
3,178,773, INT. CL. 44.
- RESOLVE, INC., TUCSON, AZ:
1,990,727. REN. 10-20-06. MULTIPLE CLASS, INT. CLS.
35 AND 36.
- RESOURCES FOR SENIOR LIVING, L.L.C., CHARLOTTE,
NC:
2,308,974, CANC. INT. CL. 42.
- RESTAURANT ASSOCIATION METROPOLITAN WA-
SHINGTON, INC., WASHINGTON, DC:
2,919,151, CANC. IIRN. RESTORED TO S.N. 78-358,801.
- RESTORE 4, INC., NORTHRIDGE, CA:
2,309,946, CANC. INT. CL. 3.
- RETAIL MANAGEMENT PRODUCTS LTD., DELAWARE,
OH:
3,178,726, INT. CL. 9.
- RETALIGENT SOLUTIONS, INC., ATLANTA, GA:
3,178,123, INT. CL. 9.
- RETIRE-IT, LLC, COLUMBUS, OH:
3,176,764, PUB. 9-12-2006. INT. CL. 35.
- RETIREMENT CAPITAL ADVISORS, INC., CINCINNATI,
OH:
3,178,444, INT. CL. 36.
- REVCO D.S., INC., TWINSBURG, OH:
1,378,497, CANC. INT. CL. 41.
- REVERE MILLS INTERNATIONAL GROUP, INC., DES
PLAINES, IL:
3,176,992, PUB. 9-12-2006. INT. CL. 24.
- REVLON CONSUMER PRODUCTS CORPORATION, NEW
YORK, NY:
2,309,974, CANC. INT. CL. 3.
3,178,446, INT. CL. 3.
- REVNET SYSTEMS, INC., HUNTSVILLE, AL:
2,309,088, CANC. INT. CL. 9.
- REXAIR LLC, TROY, MI:
1,897,430. REN. 10-26-06. INT. CL. 9.

REXAM BEAUTY AND CLOSURES INC., THOMASTON, CT:
3,178,378, INT. CL. 21.

REXER-PARKES COLLEGE SHOP, INC., HUNTINGTON, NY:
2,308,728, CANC. INT. CL. 35.

REYNOLDS, CATHERINE M., ROCHESTER, VT:
3,176,927, PUB. 9-12-2006. INT. CL. 41.

REYNOSO, ENRIQUETA GONZALEZ, ROWLAND HEIGHTS, CA:
3,175,840, PUB. 9-12-2006. MULTIPLE CLASS, INT. CLS. 29 AND 30.

RGH ENTERPRISES, INC., TWINSBURG, OH:
3,176,139, PUB. 9-12-2006. INT. CL. 5.

RGO ENTERPRISES, MEMPHIS, TN:
3,178,422, INT. CL. 20.

RHODES ACQUISITION LLC, ATLANTA, GA:
2,309,064, CANC. INT. CL. 35.

RHODES, VIRGINIA A., FAIRFIELD, AL:
3,178,120, INT. CL. 25.

RHONE POULENC AGROCHIMIE, 69009 LYON, FRANCE TO AVENTIS CROPS SCIENCE SA, 69009 LYON, FRANCE:
1,949,447, CANC. INT. CL. 31.

RHONE-POULENC RORER PHARMACEUTICALS INC., COLLEGEVILLE, PA TO AVENTIS PHARMACEUTICALS PRODUCTS INC, BRIDGEWATER, NJ:
1,949,046, CANC. INT. CL. 5.

RHOTON, ALBERT L., JR., GAINESVILLE, FL:
3,176,882, PUB. 9-12-2006. INT. CL. 10.

RICH DEVELOPMENT, LLC, SCOTTSDALE, AZ:
3,176,669, PUB. 9-12-2006. INT. CL. 35.

RICH MEDIA TECHNOLOGIES INC., ENGLEWOOD, CO:
2,309,884, CANC. INT. CL. 9.

RICHARD C. ERATH, DUNDEE, OR:
3,176,785, PUB. 9-12-2006. INT. CL. 33.

RICHARD, DONNA, NEW YORK, NY:
1,378,243, CANC. INT. CL. 25.

RICHARDSON COMPANY, PHILADELPHIA, PA:
3,178,813, INT. CL. 16.
3,178,828, INT. CL. 16.

RICHARDSON SEEDS, LTD, VEGA, TX:
1,447,819, REN. 10-26-06. INT. CL. 31.

RICHEMONT INTERNATIONAL SA, SWITZERLAND:
3,177,232, PUB. 9-12-2006. INT. CL. 14.

RICHPower INDUSTRIES INC., ENGLEWOOD CLIFFS, NJ:
3,176,607, PUB. 9-12-2006. INT. CL. 7.

RICO, JOEY, HESPERIA, CA:
3,177,094, PUB. 9-12-2006. INT. CL. 41.

RIEMANN, MATHEW W., RALEIGH, NC:
2,026,077, REN. 10-25-06. INT. CL. 10.

RIGGS, RANDALL S., SEATTLE, WA:
3,176,326, PUB. 9-12-2006. INT. CL. 42.

RIGHTIME CLOCK COMPANY, INC., THE, MIAMI, FL:
2,308,388, CANC. INT. CL. 9.

RILEY ELECTRIC LOG, INC., OKLAHOMA CITY, OK:
2,023,711, REN. 10-26-06. INT. CL. 16.

RILEY POWER INC., WORCESTER, MA, RILEY STOKER CORPORATION, WORCESTER, MA:
813,451, REN. 10-25-06. U.S. CL. 34 (INT. CL. 11).

RIMES TECHNOLOGIES CORPORATION, NEW YORK, NY:
3,178,820, INT. CL. 36.

RINALDO GAVELLO S.R.L., 20121 MILAN, ITALY:
2,308,238, CANC. INT. CL. 14.

RIO SPORTSWEAR, INC., EL MONTE, CA:
1,378,206, CANC. INT. CL. 25.

RIO TRADING LTD., UPPER DARBY, PA:
2,308,305, CANC. INT. CL. 9.

RISER CORP., INC., DALLAS, TX:
2,309,909, CANC. INT. CL. 38.

RITAI SHOES CO., LTD, CHINA:
3,177,247, PUB. 9-12-2006. INT. CL. 25.

RITEK CORPORATION, HSIN CHU INDUSTRIAL PARK, TAIWAN:
3,177,484, INT. CL. 9.

RIVER CEMENT COMPANY, ST. LOUIS, MO, STEWART CONCRETE AND MATERIAL COMPANY, ST. LOUIS, MO, DBA RIVER CEMENT COMPANY:
813,792, REN. 10-24-06. U.S. CL. 12 (INT. CL. 19).

RIVER WEST BRANDS LLC, CHICAGO, IL:
3,177,652, INT. CL. 3.

RIVERS END ENTERPRISES, INC., WILMINGTON, NC:
3,120,237, COR. INT. CL. 43.

RIVERSIDE PAPER CORPORATION, APPLETON, WI, CBC COATING INCORPORATED, APPLETON, WI:
1,404,912, REN. 10-26-06. MULTIPLE CLASS, INT. CLS. 16 AND 40.

RIVIANA FOODS INC., HOUSTON, TX:
2,071,545, REN. 10-20-06. INT. CL. 30.

RJV CONSULTANTS, INC., ALEXANDRIA, MN:
2,308,464, CANC. MULTIPLE CLASS, INT. CLS. 9 AND 35.

ROADWAY PACKAGE SYSTEM, INC., PITTSBURGH, PA TO FEDEX GROUND PACKAGE SYSTEM, INC., MOON TOWNSHIP, PA:
1,948,995, CANC. INT. CL. 16.

ROADWING, INC., REDMOND, OR:
2,309,848, CANC. INT. CL. 12.

ROBBINS INDUSTRIES, INC., FLORENCE, AL:
1,948,619, CANC. INT. CL. 21.

ROBERN, INC., BRISTOL, PA:
1,948,544, CANC. INT. CL. 20.

ROBERT L. STARK ENTERPRISES, INC., WOODMERE, OH:
3,176,390, PUB. 9-12-2006. INT. CL. 41.

ROBERT'S OF CHARLESTON, INC., CHARLESTON, SC:
1,411,797, REN. 10-26-06. INT. CL. 42.

ROBIDEAUX, ANN CATHERINE, NEW YORK, NY:
3,177,007, PUB. 9-12-2006. MULTIPLE CLASS, INT. CLS. 16, 25 AND 41.

ROBUTEC AB, S-311 31 FALKENBERG, SWEDEN:
2,308,356, CANC. INT. CL. 12.

ROCHESTER GAS & ELECTRIC CORPORATION, ROCHESTER, NY:
3,176,485, PUB. 9-12-2006. MULTIPLE CLASS, INT. CLS. 35 AND 39.

ROCHFORD THOMPSON EQUIPMENT LIMITED, NEWBURY, BERKSHIRE RG145TN, UNITED KINGDOM:
2,309,275, CANC. INT. CL. 9.

ROCKETS BALL, LTD., HOUSTON, TX:
2,309,009, CANC. INT. CL. 9.

ROCKY MOUNTAIN REMEDIATION SERVICES, L.L.C., GOLDEN, CO:
2,308,432, CANC. MULTIPLE CLASS, INT. CLS. 35, 37, 40 AND 42.

ROCKY MOUNTAIN SPAS, INC., FAIRFIELD, IA:
3,177,548, INT. CL. 11.

ROCKY MOUNTAIN TECHNOLOGY GROUP, INC., BILLINGS, MT:
3,176,556, PUB. 9-12-2006. INT. CL. 42.

RODACCIAI S.P.A., ITALY:
3,177,264, PUB. 9-12-2006. INT. CL. 6.

RODENSTOCK GMBH, D-80469 MUNCHEN, GERMAN DEM REP:
1,403,870, REN. 10-23-06. INT. CL. 9.

RODRIGUEZ, MANUEL M., SAN ANTONIO, TX:
3,176,363, PUB. 9-12-2006. INT. CL. 43.

RODRIGUEZ, RAUL P., DALLAS, TX:
3,178,060, INT. CL. 44.

ROGER DUNN GOLF SHOPS, INC., SANTA ANA, CA:
1,378,179, CANC. INT. CL. 25.

ROHM AND HAAS COMPANY, PHILADELPHIA, PA:
1,949,432, CANC. INT. CL. 1.

ROKU, L.L.C., PALO ALTO, CA:
3,177,666, INT. CL. 9.

ROLAMECH INC., SCOTTSDALE, AZ:
1,948,027, CANC. INT. CL. 16.

ROLAND INDUSTRIES, INC., ST. LOUIS, MO:
1,378,331, CANC. INT. CL. 30.

ROLCO BIANIL S.A., ATHENS, GREECE:
3,178,661, INT. CL. 3.

ROLF'S LLC, TEMPE, AZ:
3,176,423, PUB. 4-4-2006. INT. CL. 44.

- ROMA FOODS ENTERPRISES, INC., PISCATAWAY, NJ:
3,178,644, INT. CL. 30.
- ROMAN MEAL COMPANY, TACOMA, WA:
3,178,246, INT. CL. 30.
- ROOFING SUPPLY LIMITED, HOUSTON, TX:
3,177,585, INT. CL. 1.
- ROOSTER PRODUCTS INTERNATIONAL, INC., SAN ANTONIO, TX:
3,176,599, PUB. 9-12-2006. MULTIPLE CLASS, INT. CLS. 8 AND 18.
- ROPER HOLDINGS, INC., WILMINGTON, DE:
1,981,381, REN. 10-24-06. INT. CL. 9.
1,981,381, CANC. INT. CL. 42.
- ROSENHAUS, STEVEN S., NEW YORK, NY:
3,177,394, INT. CL. 3.
- ROSENTHAL, LEAH, ARLINGTON HEIGHTS, IL:
3,176,852, PUB. 9-12-2006. INT. CL. 16.
- ROTARY INTERNATIONAL, EVANSTON, IL:
2,308,945, CANC. INT. CL. 18.
- ROTH I.G.A. FOODLINER, INCORPORATED, SALEM, OR:
3,178,426, INT. CL. 41.
- ROTOSTUD LLC, ROSLYN HEIGHTS, NY:
3,176,883, PUB. 9-12-2006. INT. CL. 41.
- ROTUBA EXTRUDERS, INC., LINDEN, NJ:
3,176,629, PUB. 9-12-2006. INT. CL. 1.
- ROUGH BROTHERS, INC., CINCINNATI, OH:
2,308,562, CANC. INT. CL. 19.
- ROUND TABLE FRANCHISE CORPORATION, THE, WALNUT CREEK, CA:
2,309,435, CANC. INT. CL. 30.
- ROUNABOUT LOGIC, INC., WINTER SPRINGS, FL:
2,309,114, CANC. INT. CL. 9.
- ROUX LABORATORIES, INC., JACKSONVILLE, FL,
SHARK PRODUCTS INC., BROOKLYN, NY:
1,955,430, REN. 10-20-06. INT. CL. 3.
- ROVVAL, INC., FRESNO, CA:
2,309,925, CANC. INT. CL. 11.
- ROWA GMBH ROHSTOFF WASCH- UND AUFBEREITUNGSWERK, FED REP GERMANY:
3,177,305, PUB. 9-12-2006. MULTIPLE CLASS, INT. CLS. 1, 2, 17 AND 42.
- ROWF, LLC, BROOKLYN, NY:
3,176,030, PUB. 9-12-2006. INT. CL. 16.
- ROY HARRISON YELTON, CAPTAIN COOK, HI:
3,177,051, PUB. 9-12-2006. INT. CL. 30.
- ROYAL CONSUMER PRODUCTS LLC, NORWALK, CT:
3,178,688, INT. CL. 16.
- ROYAL WINE CORPORATION, BAYONNE, NJ:
3,176,179, PUB. 9-12-2006. INT. CL. 33.
- ROYAL WINE CORPORATION, BAYONNE, NJ, DBA KEDEM FOOD PRODUCTS:
3,178,555, INT. CL. 29.
- RPH GROUP, INC., OVIEDO, FL:
2,309,955, CANC. INT. CL. 30.
- RPM WOOD FINISHES GROUP, INC., HICKORY, NC:
3,176,823, PUB. 9-12-2006. INT. CL. 2.
- RRI FINANCIAL, INC., LAS VEGAS, NV:
3,177,183, PUB. 9-12-2006. INT. CL. 43.
- RSA MICROTECH, LLC., MARYSVILLE, WA:
3,178,198, INT. CL. 1.
- RTR GROUP, INC., FAYETTEVILLE, TN:
3,176,482, PUB. 9-12-2006. INT. CL. 35.
- RUBIN, ALAN, WESTON, FL:
3,178,708, INT. CL. 34.
- RUBINGER, NICOLE, GOLDEN VALLEY, MN:
3,177,529, INT. CL. 41.
- RUBY JEWEL TREATS, INC., PORTLAND, OR:
3,178,373, INT. CL. 30.
- RUDD, DAVID DALTON, SYRACUSE, NY AND RUDD, DEBBIE GOLDWEIN, SYRACUSE, NY, DBA DALTON'S AMERICAN DECORATIVE ARTS:
2,309,043, CANC. INT. CL. 21.
- RUG DOCTOR, L.P., FRESNO, CA:
2,308,692, CANC. INT. CL. 3.
- RUNAWAY PLANET, LLC, LITTLE ROCK, AR:
3,176,008, PUB. 9-12-2006. INT. CL. 41.
- RUNHOF, ADRIAN, 80 469 MUNICH, FED REP GERMANY AND TALBOT, JOHNNY, 80 469 MUNICH, FED REP GERMANY:
3,175,762, PUB. 9-12-2006. MULTIPLE CLASS, INT. CLS. 3, 9, 14, 16, 20, 21, 23, 24, 25, 26, 27, 28, 35, 36, 42 AND 45.
- RUNNER-LESS KNITS, INC., SANTA FE SPRINGS, CA:
3,176,708, PUB. 9-12-2006. INT. CL. 17.
- RUSSELL & MILLER, INC., SANTA FE SPRINGS, CA:
3,176,756, PUB. 9-12-2006. INT. CL. 40.
- RUSSELL SPECIALITIES CORPORATION, CARY, IL:
2,019,836, REN. 10-24-06. INT. CL. 25.
- RUSSELL'S BARBECUE, INC., ELMWOOD PARK, IL:
1,378,574, CANC. INT. CL. 42.
- RUTH GORDON HOWARD COMPANY LLC, THE, CHARLOTTE, NC:
3,178,128, INT. CL. 41.
- RWI RESOURCES, LLC, MARIETTA, GA:
3,177,913, INT. CL. 32.
- RWL CORPORATION, HICKORY, NC:
2,309,695, CANC. INT. CL. 20.
- RYDBERG LEVY GROUP, INC., THE, VANCOUVER, BRITISH COLUMBIA V6B 5C6, CANADA TO RLG INTERNATIONAL INC., VANCOUVER, BC, CANADA:
1,948,322, CANC. INT. CL. 35.
- S. A. ARMSTRONG LIMITED, SCARBOROUGH, ONTARIO, CANADA:
1,947,979, CANC. MULTIPLE CLASS, INT. CLS. 7, 9 AND 11.
- S. C. JOHNSON & SON, INC., RACINE, WI:
1,381,990, REN. 10-23-06. INT. CL. 3.
3,177,639, MULTIPLE CLASS, INT. CLS. 5, 8 AND 21.
- S.A.N CORPORATION, OXNARD, CA:
3,176,046, PUB. 9-12-2006. INT. CL. 5.
- S&C ELECTRIC CO., CHICAGO, IL:
3,178,401, INT. CL. 9.
- S&H RESTAURANT COMPANY, MCLEAN, VA:
3,176,437, PUB. 9-12-2006. INT. CL. 43.
- SABRIENT SYSTEMS LLC, SANTA BARBARA, CA:
3,176,589, PUB. 9-12-2006. INT. CL. 36.
- SACHA COSMETICS LIMITED, COUVA, TRINIDAD/TOBAGO:
3,177,036, PUB. 9-12-2006. INT. CL. 3.
- SACHA LONDON, S.L., ELDA (ALCANTE), SPAIN:
2,890,144, CANC. INT. CL. 25.
- SACHS INDUSTRIES S.A., NANTERRE, FRANCE:
1,378,016, CANC. INT. CL. 12.
- SACKET, BROOKS C., SA JOSE, CA:
1,958,571, REN. 10-25-06. INT. CL. 28.
- SACRAMENTO STUCCO COMPANY, WEST SACRAMENTO, CA:
3,175,872, PUB. 9-12-2006. INT. CL. 19.
3,175,873, PUB. 9-12-2006. INT. CL. 19.
- SAFCO PRODUCTS COMPANY, MINNEAPOLIS, MN:
1,997,126, REN. 10-20-06. INT. CL. 9.
- SAFE FLIGHT INSTRUMENT CORP., WHITE PLAINS, NY:
630,866, REN. 10-23-06. U.S. CL. 26 (INT. CL. 7).
- SAFEHARBOR TECHNOLOGY CORPORATION, ELMA, WA:
2,374,779, AM. INT. CL. 42.
- SAFETY TECHNOLOGY INTERNATIONAL, INC., WATERFORD, MI:
1,981,769, REN. 10-24-06. INT. CL. 9.
- SAGE-PASSANT, PETER, MILTON KEYNES, MK11 3NF, UNITED KINGDOM:
2,002,467, REN. 10-25-06. INT. CL. 11.
- SAGEMETRICS CORPORATION, N. HOLLYWOOD, CA:
3,177,594, INT. CL. 42.
- SAGITTA INDUSTRIAL CORP., TAIPEI, TAIWAN:
3,177,416, INT. CL. 35.
- SAHLGREN, MYLES R., TALLAHASSEE, FL:
1,993,398, REN. 10-25-06. INT. CL. 35.
- SAIL CARIBBEAN VOYAGES, INC., NORTHPORT, NY:
2,009,577, REN. 10-25-06. MULTIPLE CLASS, INT. CLS. 25 AND 39.
- SAILRAIL AUTOMATED SYSTEMS INC., MARKHAM, ONTARIO, CANADA:
3,178,750, INT. CL. 7.

SAINT-GOBAIN ABRASIVES, INC., WORCESTER, MA:
3,178,296, INT. CL. 7.

SAINT-GOBAIN CALMAR INC., CITY OF INDUSTRY, CA:
3,094,692, COR. INT. CL. 8.

SAINT-GOBAIN PERFORMANCE PLASTICS CORPORATION, AURORA, OH, SANITARY COUPLERS, INC., DAYTON, OH:
1,996,908, REN. 10-24-06, INT. CL. 6.

SAIPAN HANDICRAFT, SAIPAN, HI AND CAPATI, RODRIGO M., SAIPAN, HI AND CAPATI, ADELA S., SAIPAN, HI:
3,141,980, CANC. IIRN. RESTORED TO S.N. 78-732,233.

SAKATA SEED CORPORATION, YOKOHAMA, JAPAN:
3,177,990, INT. CL. 31.

SAL R. GRASSADONIA AND LISA M. LOHREY PARTNERSHIP, THE, CAMPBELL, CA:
3,176,081, PUB. 9-12-2006, MULTIPLE CLASS, INT. CLS. 9 AND 25.

SALCHAIN (PTY) LTD., GERMISTON 1401, SOUTH AFRICA:
2,308,225, CANC. INT. CL. 7.

SALES RESULTS, INC., NORTHBROOK, IL:
3,123,145, CANC. IIRN. RESTORED TO S.N. 78-642,082.

SALISH TRUST, ANACORTES, WA:
3,177,807, INT. CL. 13.

SALLIE MAE, INC., RESTON, VA:
3,176,554, PUB. 9-12-2006, INT. CL. 36.
3,178,827, INT. CL. 36.

SALOMON, SALLY M., DEL MAR, CA:
3,178,390, INT. CL. 5.

SALVADOR CORPORATION IMPORT, MIAMI, FL:
3,176,342, PUB. 9-12-2006, INT. CL. 29.

SAMANTHA DESIGNS, LTD., NEW YORK, NY:
3,177,419, INT. CL. 14.

SAMCO SCIENTIFIC CORPORATION, SAN FERNANDO, CA, SAMCO SCIENTIFIC, INC., SAN FERNANDO, CA:
1,990,202, REN. 10-23-06, INT. CL. 10.
1,991,503, REN. 10-23-06, INT. CL. 10.

SAMSUNG CORPORATION, SEOUL, REPUBLIC OF KOREA:
3,176,728, PUB. 9-12-2006, INT. CL. 9.

SAMSUNG ELECTRONICS CO., LTD., SUWON-CITY, KYUNGKI-DO, REPUBLIC OF KOREA:
3,175,945, PUB. 9-12-2006, INT. CL. 9.

SAMSUNG ELECTRONICS CO., LTD., GYEONGGI-DO, REPUBLIC OF KOREA:
3,176,029, PUB. 9-12-2006, INT. CL. 9.

SAMSUNG TELECOMMUNICATIONS AMERICA, INC., RICHARDSON, TX:
2,308,670, CANC. INT. CL. 9.

SANDAL ENTERPRISES, INC., MIAMI, FL:
3,176,890, PUB. 9-12-2006, INT. CL. 16.

SANDISK CORPORATION, MILPITAS, CA:
3,178,105, INT. CL. 9.

SANDLER SYSTEMS, INC., STEVENSON, MD:
1,958,826, REN. 10-25-06, INT. CL. 41.

SANDLOT SPORTS INC, MOCKSVILLE, NC, FJB SPORTS COMPANY, WINSTON-SALEM, NC:
1,997,375, REN. 10-24-06, INT. CL. 28.

SANDOZ AG (SANDOZ LTD., SANDOZ S.A.), BOSLE, SWITZERLAND:
1,377,779, CANC. INT. CL. 1.

SANDOZ AG (SANDOZ LTD., SANDOZ S.A.), BASLE, SWITZERLAND:
1,377,863, CANC. INT. CL. 5.

SANFORD L.P., BELLWOOD, IL:
2,308,231, CANC. INT. CL. 16.

SANFORD, L.P., ATLANTA, GA, EAGLE PENCIL COMPANY, NEW YORK, NY:
52,807, REN. 10-26-06, U.S. CL. 37 (INT. CL. 16).

SANKYO PHARMA, INC., PARSIPPANY, NJ:
2,506,257, COR. INT. CL. 5.

SANRIO COMPANY, LTD., TOKYO 141, JAPAN:
3,177,420, INT. CL. 25.
3,177,421, INT. CL. 18.

SANS SOUCIE ART GLASS STUDIOS, INC., RANCHO MIRAGE, CA:
2,308,840, CANC. INT. CL. 35.

SANTA CLARA, INC., WHIPPANY, NJ:
3,176,633, PUB. 9-12-2006, INT. CL. 34.
3,178,746, INT. CL. 34.

SANTA ROSA TROPICALS, SANTA ROSA, CA:
2,309,437, CANC. INT. CL. 31.

SANTALUZ, LLC, IRVINE, CA:
3,176,429, PUB. 9-12-2006, INT. CL. 43.

SANTÉ FÉMININE LIMITED, SMYRNA, GA:
3,177,936, INT. CL. 10.
3,177,937, INT. CL. 16.

SARA LEE CORPORATION, WINSTON-SALEM, NC:
2,309,151, CANC. INT. CL. 41.
2,309,331, CANC. INT. CL. 16.

SARA LEE GLOBAL FINANCE L.L.C., WILMINGTON, DE:
3,175,758, PUB. 9-12-2006, INT. CL. 28.

SARACEN, INC., MALIBU, CA:
2,308,979, CANC. INT. CL. 20.

SARAMAR, L.L.C., CHICAGO, IL:
3,177,616, INT. CL. 3.

SARGENTO FOODS, INC., PLYMOUTH, WI:
3,175,936, PUB. 9-12-2006, INT. CL. 29.

SARTORIUS AG, GÖTTINGEN, FED REP GERMANY:
3,178,067, INT. CL. 11.

SAS INSTITUTE INC., CARY, NC:
2,309,530, CANC. MULTIPLE CLASS, INT. CLS. 9 AND 16.

SATELLITE HEALTHCARE, MOUNTAIN VIEW, CA:
3,178,325, MULTIPLE CLASS, INT. CLS. 42 AND 44.

SATOH, TETSUYA, SETAGAYA-KU, TOKYO, JAPAN TO SHIGERU SATOH, HYOGO, JAPAN:
1,947,985, CANC. INT. CL. 36.

SAUCEDO, MARK A., BEVERLY HILLS, CA:
3,177,047, PUB. 9-12-2006, INT. CL. 41.

SAUERMANN INDUSTRIE, FRANCE:
3,177,209, PUB. 9-12-2006, MULTIPLE CLASS, INT. CLS. 7, 11 AND 37.

SAUL, EWING, REMICK & SAUL LLP, PHILADELPHIA, PA:
2,309,145, CANC. INT. CL. 42.

SAVAREZ, 69300 CALUIRE ET CUIRE, FRANCE:
3,176,207, PUB. 9-12-2006, INT. CL. 15.

SAVIO ENGINEERING, INC., SANTA FE, NM:
3,178,682, INT. CL. 11.

SBARRO INC., MELVILLE, NY:
1,991,581, REN. 10-24-06, INT. CL. 30.
1,991,581, CANC. INT. CL. 29.

SC HOLDINGS, INC., BREA, CA:
3,178,329, INT. CL. 5.

SCA MOLNLYCKE AB, S-405 03 GOTEBORG, SWEDEN:
2,308,282, CANC. MULTIPLE CLASS, INT. CLS. 5, 10, 16, 24 AND 25.

SCANDINAVIAN AIRLINES OF NORTH AMERICA, JAMAICA, NY:
1,378,468, CANC. INT. CL. 39.

SCANDINAVIAN MICRO SYSTEMS A/S, N-1411 KOLBOTN, NORWAY:
2,308,196, CANC. MULTIPLE CLASS, INT. CLS. 9, 38 AND 42.

SCANNER APPLICATIONS, INC., MILFORD, OH:
3,176,576, PUB. 9-12-2006, INT. CL. 35.

SCANTECH-ID HOLDING BV, 3769 AN SOESTERBERG, NETHERLANDS:
1,895,944, REN. 10-23-06, MULTIPLE CLASS, INT. CLS. 9, 37 AND 42.

SCEA SOCIETE CIVILE JEAN DURUP PERE ET FILS, MALIGNY 89800 CHABLIS, FRANCE:
2,310,065, CANC. INT. CL. 33.

SCHEIN PHARMACEUTICAL, INC., FLORHAM PARK, NJ:
2,309,676, CANC. INT. CL. 42.

SCHILLING, CHERYL, KATY, TX:
3,176,244, PUB. 9-12-2006, INT. CL. 24.

SCHLAGE LOCK COMPANY, COLORADO SPRINGS, CO:
2,332,840, CANC. INT. CL. 6.

SCHLOTZSKY'S, LTD., AUSTIN, TX, SCHLOTZSKY'S, INC., AUSTIN, TX:
1,385,566, REN. 10-23-06, INT. CL. 42.

- SCHLUMBERGER INDUSTRIES, 92120 MONTRouGE, FRANCE:
2,308,738, CANC. MULTIPLE CLASS, INT. CLS. 38, 39 AND 42.
- SCHMALBACH-LUBECA AG, D-40832 RATINGEN, FED REP GERMANY:
2,309,427, CANC. INT. CL. 17.
- SCHMIDT + CLEMENS GMBH + CO., D-51789 LINDLAR, FED REP GERMANY:
2,308,309, CANC. INT. CL. 6.
- SCHMITZ, JOHN C., PORT ANGELES, WA:
3,176,869, PUB. 9-12-2006. MULTIPLE CLASS, INT. CLS. 16 AND 41.
- SCHNEIDER & KOCH & CO. DATENSYSTEME GMBH, 76275 ETTLINGEN, FED REP GERMANY:
2,308,248, CANC. INT. CL. 9.
- SCHOLASTIC INC., NEW YORK, NY:
3,178,465, INT. CL. 35.
3,178,619, INT. CL. 9.
- SCHOOL APPAREL, INC., SAN BRUNO, CA:
2,021,211, REN. 10-26-06. INT. CL. 24.
- SCHOOL OF AMERICAN BALLET, INC., NEW YORK, NY:
2,309,520, CANC. INT. CL. 25.
2,309,522, CANC. INT. CL. 25.
- SCHUR INTERNATIONAL A/S, DK-8700 HORSSENS, DENMARK:
2,315,041, CANC. INT. CL. 1.
- SCHURHAMMER MANUFACTURING, INC., WABASHA, MN:
3,177,339, INT. CL. 14.
- SCHUS, STEPHANIE, GLENDALE, CA AND NELSON, MARLA, GLENDALE, CA:
3,177,754, INT. CL. 28.
- SCHWAN'S IP, LLC, MARSHALL, MN:
3,178,631, INT. CL. 30.
- SCI MANAGEMENT L.P., HOUSTON, TX:
3,176,369, PUB. 9-12-2006. INT. CL. 45.
- SCIENCE APPLICATIONS INTERNATIONAL CORPORATION, SAN DIEGO, CA:
2,902,628, AM. MULTIPLE CLASS, INT. CLS. 35, 40, 41 AND 42.
- SCORETT FOOT WEAR AKTIEBOLAG, SWEDEN:
3,177,223, PUB. 9-12-2006. MULTIPLE CLASS, INT. CLS. 18 AND 25.
- SCOTT APPAREL, INC., PORTER RANCH, CA:
3,178,300, INT. CL. 25.
- SCOTT MACHINE DEVELOPMENT CORPORATION, WALTON, NY:
1,949,708, CANC. INT. CL. 17.
1,949,709, CANC. INT. CL. 17.
- SCOTT PAINT COMPANY, INC., SARASOTA, FL:
3,176,801, PUB. 9-12-2006. INT. CL. 2.
3,176,802, PUB. 9-12-2006. INT. CL. 2.
- SCOTT, JOHN, DALLAS, TX:
3,176,648, PUB. 9-12-2006. INT. CL. 10.
- SCOTTBAILEY & ASSOCIATES, INC., SAN CLEMENTE, CA:
3,178,369, INT. CL. 25.
- SCOTTCARE CORPORATION, THE, CLEVELAND, OH:
1,949,302, CANC. INT. CL. 10.
- SCOTTISH & NEWCASTLE PLC, EDINBURGH, EH8 8YS, UNITED KINGDOM:
3,175,756, PUB. 4-12-2005. INT. CL. 32.
- SCRAP THERAPY, LLC, GOODYEAR, AZ:
3,177,031, PUB. 9-12-2006. INT. CL. 35.
- SCREEN PLAY VIDEO, INC., WILMINGTON, NC:
2,309,219, CANC. INT. CL. 41.
- SCROLL FABRICS INC, SMYRNA, GA:
2,020,541, REN. 10-24-06. INT. CL. 24.
- SCROLL FABRICS, INC., SMYRNA, GA:
2,001,425, REN. 10-24-06. INT. CL. 40.
- SCUDDER TRUST COMPANY, SALEM, NH:
2,308,722, CANC. INT. CL. 9.
- SCULPT, INC., HOUSTON, TX:
3,176,240, PUB. 9-12-2006. INT. CL. 41.
- SCYLD COMPUTING CORPORATION, SAN FRANCISCO, CA:
3,176,565, PUB. 9-12-2006. INT. CL. 9.
- SEA ISLAND CLOTHIERS INC., BROOKLYN, NY:
1,996,010, REN. 10-20-06. INT. CL. 25.
- SEACHANGE INTERNATIONAL, INC., ACTON, MA:
3,178,423, INT. CL. 9.
- SEAN M WALDROP, OKLAHOMA CITY, OK:
3,176,663, PUB. 9-12-2006. INT. CL. 25.
- SEARS, BARRY D., DANVERS, MA:
3,176,214, PUB. 6-20-2006. INT. CL. 41.
- SEARS, ROEBUCK AND CO., HOFFMAN ESTATES, IL:
2,308,991, CANC. INT. CL. 24.
- SEATT CORPORATION, DOWNERS GROVE, IL TO MAPLE CHASE COMPANY, DOWNERS GROVE, IL:
1,948,956, CANC. INT. CL. 9.
- SECURED DIGITAL STORAGE, INC., DES MOINES, IA:
3,175,808, PUB. 9-12-2006. INT. CL. 42.
- SECURITAS SECURITY SYSTEMS USA, INC., PASADENA, CA, PACIFIC BANK TECHNOLOGY, INC., PASADENA, CA:
1,998,766, REN. 10-25-06. INT. CL. 9.
- SECURITY EQUIPMENT CORPORATION, FENTON, MO:
3,178,490, INT. CL. 13.
- SEDONA INVESTMENTS LTD., VANCOUVER, BRITISH COLUMBIA, CANADA:
3,178,267, INT. CL. 2.
- SEE IT SO L.L.C., AUSTIN, TX:
3,177,391, INT. CL. 9.
3,177,392, INT. CL. 9.
- SEGAL, BERNARD I., LOS ANGELES, CA:
3,177,689, INT. CL. 5.
- SEGAR, MICHELLE L., ANN ARBOR, MI:
2,309,730, CANC. INT. CL. 41.
- SEGURO CORPORATION, WARREN, MI:
1,378,442, CANC. INT. CL. 37.
- SEIKO INSTRUMENTS KABUSHIKI KAISHA, CHIBA 261-8507, JAPAN, TA SEIKO INSTRUMENTS INC.:
3,177,592, INT. CL. 9.
- SEKURCAP INTERNATIONAL INVESTMENTS INC., MONTREAL, QUEBEC, CANADA:
3,176,000, PUB. 9-12-2006. INT. CL. 36.
- SELBY, LESLIE G., SANTEE, CA:
2,308,867, CANC. INT. CL. 20.
- SELECT PRODUCTS, INC., OSCEOLA, IA:
3,178,170, INT. CL. 29.
- SELECTIVE INSURANCE GROUP, INC., BRANCHVILLE, NJ:
3,177,139, PUB. 9-12-2006. INT. CL. 42.
3,177,148, PUB. 9-12-2006. INT. CL. 42.
- SELECTOS VARADERO, INC., MIAMI, FL:
3,178,215, INT. CL. 34.
- SELIGSON, DOUGLAS S., NEW MARKET, MD:
3,178,777, MULTIPLE CLASS, INT. CLS. 16 AND 25.
- SELLERS & JOSEPHSON, INC., ENGLEWOOD, NJ:
2,309,920, CANC. INT. CL. 16.
- SELSI COMPANY, INC., MIDLAND PARK, NJ, SUSSFELD, LORSCH & SCHIMMEL, NEW YORK, NY:
216,307, REN. 10-20-06. U.S. CL. 26 (INT. CL. 9).
- SENCION, JACQUELINE, NEW YORK, NY:
3,177,861, INT. CL. 25.
- SENIZERGUES, PIERRE ANDRE, NEWPORT BEACH, CA:
3,177,893, INT. CL. 25.
- SERALY, MARK P., MCMURRAY, PA:
3,178,806, INT. CL. 44.
3,178,807, INT. CL. 44.
- SERENA SOFTWARE, INC., SAN MATEO, CA:
3,178,770, INT. CL. 35.
3,178,771, INT. CL. 42.
- SERGEANT'S PET CARE PRODUCTS, INC., OMAHA, NE:
3,176,140, PUB. 9-12-2006. INT. CL. 28.
- SERIALIO, LLC, GOLETA, CA:
3,176,301, PUB. 9-12-2006. INT. CL. 9.
- SERVICE LITHO-PRINT INC., OSHKOSH, WI:
1,949,817, CANC. INT. CL. 20.
- SERVICE STATION PRODUCTS COMPANY, CHRISTIANA, DE:
3,177,378, INT. CL. 9.
- SERVICEMASTER BRANDS L.L.C., BURLINGTON, VT:
3,176,174, PUB. 9-12-2006. INT. CL. 37.

SERVICIOS CONDUMEX S.A. DE C.V., QUERETARO, QRO., MEXICO:
3,177,367, INT. CL. 9.

SERVICIOS CONDUMEX S.A. DE C.V., QUERETARO, QRO., MEXICO:
3,177,368, INT. CL. 9.

SES AMERICOM, INC., PRINCETON, NJ:
3,177,449, INT. CL. 38.

SESAME WORKSHOP, NEW YORK, NY:
3,177,646, MULTIPLE CLASS, INT. CLS. 10, 18, 25 AND 28.

SEVAN SOFTWARE, INC., LA CRESCENTA, CA:
3,178,624, INT. CL. 41.

SEVEN FOR ALL MANKIND, LLC, VERNON, CA:
1,905,065, REN. 10-26-06, INT. CL. 25.

SEVEN SEAS SEAFOODS, INC, MONTEBELLO, CA:
3,176,653, PUB. 9-12-2006, INT. CL. 29.

SEVENTH AVE. FASHIONS, INC., EDISON, NJ:
2,081,060, REN. 10-26-06, INT. CL. 25.

SFX MOTOR SPORTS, INC., HOUSTON, TX, DBA CLEAR CHANNEL ENTERTAINMENT- MOTOR SPORTS:
3,176,130, PUB. 7-4-2006, MULTIPLE CLASS, INT. CLS. 25 AND 41.

SHAKLEE CORPORATION, PLEASANTON, CA, SHAKLEE CORPORATION, SAN FRANCISCO, CA:
1,993,654, REN. 10-20-06, INT. CL. 3.

SHAMROCK FOODS COMPANY, PHOENIX, AZ:
3,177,653, INT. CL. 29.

SHANDEX SALES GROUP, LIMITED, PICKERING, ONTARIO, CANADA:
3,175,836, PUB. 9-12-2006, INT. CL. 35.

SHANGHAI COOL-AIR TRANSPORT REFRIGERATION EQUIPMENT CO., LTD., SHANGHAI, CHINA:
3,176,402, PUB. 9-12-2006, INT. CL. 11.

SHANGHAI G-CROWN FOUNTAIN PEN CO., LTD., MINHANG DISTRICT, SHANGHAI, CHINA:
3,177,302, PUB. 9-12-2006, INT. CL. 16.

SHANTOU FUWEI FRUITS & NUTS MANUFACTURING CO., LTD, CHINA:
3,177,293, PUB. 9-12-2006, INT. CL. 30.

SHAPIRA DENTAL CARE, LTD., GURNEE, IL, DBA DELANY DENTAL CARE:
3,176,961, PUB. 9-12-2006, INT. CL. 44.

SHARMA, ADITYA, SIMI VALLEY, CA AND SHARMA, GEETA, SIMI VALLEY, CA:
3,176,926, PUB. 9-12-2006, INT. CL. 5.

SHARPER IMAGE CORPORATION, SAN FRANCISCO, CA:
3,178,658, MULTIPLE CLASS, INT. CLS. 7, 8, 9, 11, 14 AND 21.

SHARRARD, SCOTT P., NEW YORK, NY:
2,310,075, CANC. INT. CL. 41.

SHARTSIS FRIESE LLP, SAN FRANCISCO, CA:
3,176,903, PUB. 9-12-2006, INT. CL. 42.

SHAW, PHILIP, HERMOSA BEACH, CA:
3,178,705, MULTIPLE CLASS, INT. CLS. 9, 15 AND 25.

SHEAKLEY UNICOMP, INC., CINCINNATI, OH:
3,177,476, INT. CL. 41.

SHECHTER, YONATHAN, WOODSIDE, NY:
3,176,809, PUB. 9-12-2006, INT. CL. 9.

SHEEDY, MICHAEL DOUGLAS, BLANCO, TX:
2,309,106, CANC. INT. CL. 20.

SHELBY WILLIAMS INDUSTRIES, INC., MORRISTOWN, TN:
2,308,439, CANC. INT. CL. 20.

SHELBY, CARROLL, GARDENA, CA:
3,175,757, PUB. 11-13-2001, INT. CL. 12.

SHENZHEN WHOLE PERFECT FOODS CO., LTD., SHENZHEN, CHINA:
1,948,547, CANC. INT. CL. 29.

SHENZHEN XINGRISHENG INDUSTRIAL CO., LTD, LONGGANG, CHINA:
3,176,387, PUB. 9-12-2006, MULTIPLE CLASS, INT. CLS. 7, 11 AND 16.

SHEPHERD, JENNIFER L., STOCKTON, NJ:
3,177,661, MULTIPLE CLASS, INT. CLS. 16, 41 AND 45.

SHERIDAN, PATRICK R., MESA, AZ:
2,308,767, CANC. INT. CL. 9.

SHERWOOD MEDICAL COMPANY, ST. LOUIS, MO TO SHERWOOD SERVICES AG, 8200 SCHAFFHAUSEN, SWITZERLAND:
1,949,326, CANC. INT. CL. 5.

SHERWOOD SERVICES AG, SCHAFFHAUSEN, SWITZERLAND, BRUNSWICK CORPORATION, CHICAGO, IL:
801,968, REN. 10-24-06, U.S. CL. 44 (INT. CL. 10).

SHERWOOD SERVICES AG, SCHAFFHAUSEN, SWITZERLAND, SANDOZ, INC., EAST HANOVER, NJ:
1,038,108, REN. 10-26-06, INT. CL. 5.

SHERWOOD SERVICES AG, SCHAFFHAUSEN, SWITZERLAND:
1,403,009, REN. 10-22-06, INT. CL. 10.
3,177,628, INT. CL. 10.
3,178,114, INT. CL. 10.

SHEVACK, BRETT, NEW YORK, NY:
3,177,677, INT. CL. 25.

SHIFRA, LARRY J., DOTHAN, AL:
2,309,270, CANC. INT. CL. 20.

SHIM, MI OCG, BURKE, VA:
3,177,712, INT. CL. 44.

SHIMANO INC., JAPAN:
3,177,315, PUB. 9-12-2006, INT. CL. 12.

SHINTANI, TERRY, HONOLULU, HI, DBA SHINTANI HEALTH SYSTEMS:
1,993,731, REN. 10-26-06, INT. CL. 16.

SHIPPERT ENTERPRISES, LTD., CENTENNIAL, CO:
3,178,462, INT. CL. 5.

SHIPYARD BREWING COMPANY, LLC, PORTLAND, ME:
3,176,806, PUB. 9-12-2006, INT. CL. 32.
3,176,812, PUB. 9-12-2006, INT. CL. 32.

SHISEIDO COMPANY, LTD., TOKYO, JAPAN:
3,178,348, INT. CL. 3.

SHOCKED, MICHELLE, NEW ORLEANS, LA:
2,308,433, CANC. INT. CL. 9.

SHOEMAKER & LYNCH, INC., BELVIDERE, NJ, S & L USED AUTO PARTS:
1,378,437, CANC. MULTIPLE CLASS, INT. CLS. 37 AND 42.

SHORT-ELLIOTT-HENDRICKSON, INC., ST. PAUL, MN:
1,948,356, CANC. MULTIPLE CLASS, INT. CLS. 35 AND 41.

SHOSHAN, EYAL AVI, LAS VEGAS, NV:
3,176,488, PUB. 9-12-2006, INT. CL. 6.

SHUFFLE MASTER, INC., LAS VEGAS, NV:
3,178,778, INT. CL. 28.

SHURJOINT METALS INC., WAN TAN HSIANG, PING TUNG HSIEN 913, TAIWAN:
1,996,123, REN. 10-25-06, INT. CL. 6.

SICHUAN VIDEO ELECTRONIC CO., LTD., CHINA:
3,177,277, PUB. 9-12-2006, INT. CL. 9.

SIDEL, FRANCE:
3,177,308, PUB. 9-12-2006, MULTIPLE CLASS, INT. CLS. 6, 7, 9 AND 42.

SIDESTEP, INC. SANTA CLARA, CA:
3,178,122, MULTIPLE CLASS, INT. CLS. 39 AND 43.

SIDVIM, INC., CHICAGO, IL:
2,752,176, COR. INT. CL. 41.

SIELECKI, LEONARD E, VICTORIA, CANADA:
3,176,320, PUB. 9-12-2006, INT. CL. 5.

SIEMENS AKTIENGESELLSCHAFT, FED REP GERMANY:
2,308,515, CANC. MULTIPLE CLASS, INT. CLS. 9 AND 42.

SIERRA HEALTHSTYLES LLC, TUCSON, AZ:
3,178,027, INT. CL. 41.
3,178,366, INT. CL. 41.

SIERRA SUITES FRANCHISE, L.P., WICHITA, KS:
3,177,446, INT. CL. 41.

SIGMA COMMUNICATIONS, LLC, INDIANAPOLIS, IN:
3,176,824, PUB. 9-12-2006, INT. CL. 9.

SIGMA-ALDRICH BIOTECHNOLOGY L.P., ST. LOUIS, MO:
3,178,111, MULTIPLE CLASS, INT. CLS. 1, 40 AND 42.

SIGNATURE FLIGHT SUPPORT CORPORATION, ORLANDO, FL, SIGNATURE FLIGHT SUPPORT CORPORATION, ORLANDO, FL:
1,998,482, REN. 10-25-06, MULTIPLE CLASS, INT. CLS. 37, 39 AND 42.

- SIGNATURE FLIGHT SUPPORT CORPORATION, ORLANDO, FL TO SIGNATURE FLIGHT SUPPORT CORPORATION, ORLANDO, FL:
1,998,482, CANC. INT. CL. 35.
- SIGNATURE PLUS, LTD., FLUSHING, NY:
2,308,479, CANC. INT. CL. 18.
- SILVER BULLET TECHNOLOGY, INC., PENSACOLA, FL:
3,176,671, PUB. 9-12-2006. INT. CL. 9.
3,176,709, PUB. 9-12-2006. INT. CL. 9.
- SILVERADO MANAGEMENT GROUP, L.P., DALLAS, TX:
3,177,058, PUB. 9-12-2006. INT. CL. 35.
- SIMCHAT TORAH BEIT MIDRASH, INC., PARKER, CO:
3,176,071, PUB. 9-12-2006. MULTIPLE CLASS, INT. CLS. 9, 16 AND 41.
- SIMMONS PREPARED FOODS, INC., SILOAM SPRINGS, AR:
2,308,457, CANC. INT. CL. 29.
- SIMMONS, JOHNNIE F. II, GREAT LAKES, IL:
3,176,851, PUB. 9-12-2006. INT. CL. 28.
- SIMMS FISHING PRODUCTS CORPORATION, BOZEMAN, MT:
2,310,001, CANC. INT. CL. 25.
- SIMON & SIMON, LLC, WASHINGTON, DC:
3,177,833, MULTIPLE CLASS, INT. CLS. 9 AND 41.
- SIMPLESOLD LLC, FT. LAUDERDALE, FL:
3,176,076, PUB. 9-12-2006. INT. CL. 35.
3,176,080, PUB. 9-12-2006. INT. CL. 35.
- SIN SIN ACCESSORIES LTD., HUNGHOM, KOWLOON, HONG KONG:
2,308,574, CANC. INT. CL. 14.
2,308,575, CANC. INT. CL. 18.
- SINBALA CORPORATION, ARCADIA, CA:
3,176,808, PUB. 9-12-2006. MULTIPLE CLASS, INT. CLS. 29 AND 43.
- SINCLAIR PHARMACEUTICALS LTD., SURREY, UNITED KINGDOM:
3,177,597, INT. CL. 5.
- SINCLAIR, DANIEL J., JR., MANDEVILLE, LA:
3,177,919, INT. CL. 33.
- SINISTER BRAND CLOTHING, HOLLYWOOD, CA TO SOARES, EDWARD, REDONDO BEACH, CA:
1,948,911, CANC. INT. CL. 25.
- SION INC., KANAGAWA-KEN, JAPAN:
3,178,711, INT. CL. 15.
- SIPDISC, INC., NEW YORK, NY:
3,178,264, INT. CL. 20.
- SIRMANS, JAMES R. JR., GAINESVILLE, FL:
3,178,048, INT. CL. 36.
- SITRO, ROBERT E., HAVERHILL, MA:
2,308,896, CANC. INT. CL. 21.
- SIX CONTINENTS HOTELS, INC., ATLANTA, GA:
3,178,437, INT. CL. 43.
- SKC INC., EIGHTY FOUR, PA:
3,177,541, INT. CL. 9.
- SKY BANK, SALINEVILLE, OH:
2,308,708, CANC. INT. CL. 36.
- SKYLINE CORPORATION, ELKHART, IN:
3,176,932, PUB. 9-12-2006. INT. CL. 12.
3,176,933, PUB. 9-12-2006. INT. CL. 12.
3,176,934, PUB. 9-12-2006. INT. CL. 12.
- SKYPILOT NETWORKS, INC., SANTA CLARA, CA:
3,177,865, INT. CL. 9.
- SKYVISION, INC., FERGUS FALLS, MN:
3,176,459, PUB. 9-12-2006. INT. CL. 11.
- SLEEP-N-AIRE MATTRESS COMPANY, HAYWARD, CA:
1,069,587, REN. 10-21-06. U.S. CL. 32 (INT. CL. 20).
- SLIM FOR LIFE, INC., PLANTATION, FL:
3,176,950, PUB. 9-12-2006. INT. CL. 5.
- SMA TECHNOLOGIE AG, NIESTETAL, FED REP GERMANY:
3,178,368, INT. CL. 9.
- SMALLSHIER, SANTA CLARITA, CA:
813,206, REN. 10-20-06. U.S. CL. 2 (INT. CL. 21).
- SMART DESTINATIONS, INC., BOSTON, MA:
3,177,921, INT. CL. 16.
- SMARTWOOL CORP., STEAMBOAT SPRINGS, CO:
3,177,991, INT. CL. 35.
- SMG BRANDS, INC., MARYSVILLE, OH:
2,310,076, CANC. INT. CL. 42.
- SMI HOLDINGS, INC., ARDEN HILLS, MN:
3,177,064, PUB. 9-12-2006. INT. CL. 1.
- SMITH & JONES INC., SEATTLE, WA:
1,949,062, CANC. INT. CL. 25.
- SMITH DAIRY PRODUCTS COMPANY, ORRVILLE, OH:
1,980,947, REN. 10-26-06. INT. CL. 29.
- SMITH, J. C., SAN MARCOS, TX:
1,948,622, CANC. INT. CL. 42.
- SMITH, KEVIN L., PIQUA, OH:
3,175,915, PUB. 9-12-2006. INT. CL. 16.
- SMITH, PHILLIP H., PITTSBURGH, PA:
3,177,371, INT. CL. 41.
- SMITHEREENS, INC., HOUSTON, TX:
2,308,599, CANC. INT. CL. 21.
- SMITHFIELD HAM AND PRODUCTS COMPANY, INC., SMITHFIELD, VA:
2,308,631, CANC. INT. CL. 29.
- SMITHKLINE BEECHAM CORPORATION, PHILADELPHIA, PA:
2,309,192, CANC. MULTIPLE CLASS, INT. CLS. 41 AND 42.
2,309,667, CANC. INT. CL. 5.
- SMITHS MEDICAL ASD, INC., KEENE, NH:
3,177,906, INT. CL. 10.
- SNAP LOCK INDUSTRIES, INC., SALT LAKE CITY, UT, KOTLER, DAN, SALT LAKE CITY, UT:
1,967,521, REN. 10-26-06. INT. CL. 27.
- SNIDER, SEAN M., DENVER, CO:
3,178,034, INT. CL. 35.
- SNOW BRAND SEED CO., LTD., JAPAN:
3,177,231, PUB. 9-12-2006. INT. CL. 31.
- SNOW PHARMACEUTICALS, INC., OCEAN VIEW, DE:
2,309,156, CANC. INT. CL. 5.
- SNOWBEAR LIMITED, GUELPH, ONTARIO, CANADA:
3,177,908, INT. CL. 12.
- SNOZZLE LIMITED PARTNERSHIP, DALLAS, TX, TRUCK EQUIPMENT ENGINEERING COMPANY, INC., HUNTINGTON BEACH, CA:
1,377,964, REN. 10-26-06. INT. CL. 9.
- SNYDER, STEVEN, GREENWOOD VILLAGE, CO:
3,178,823, INT. CL. 36.
- SOBRIETY SERVICES, SAN JUAN CAPISTRANO, CA:
3,176,741, PUB. 9-12-2006. INT. CL. 44.
- SOCIEDADE VITIVINICOLA QUINTA DE SANTA EUFEMIA, LDA, PORTO, PORTUGAL:
3,177,643, INT. CL. 33.
- SOCIETE DES PRODUITS NESTLE S.A., 1800 VEVEY, SWITZERLAND:
1,048,676, REN. 10-24-06. INT. CL. 31.
- SOCIETE DES PRODUITS NESTLE S.A., VEVEY, SWITZERLAND:
3,178,625, INT. CL. 31.
- SOCIETE FRANCAISE D'ASSAINISSEMENT-SFA, FRANCE:
3,177,225, PUB. 9-12-2006. INT. CL. 9.
- SOCIETE GUY LAROCHE, FRANCE:
3,177,311, PUB. 9-12-2006. INT. CL. 25.
- SOCIETY OF NOVUS SPIRITUS, CAMPBELL, CA:
3,176,595, PUB. 9-12-2006. INT. CL. 41.
- SOCIETY TO CERTIFY THE AUTHENTICITY OF ARTS & ANTIQUES CO., ATLANTA, GA:
3,175,885, PUB. 9-12-2006. INT. CL. 42.
- SOFA MART, LLC, LAKEWOOD, CO:
2,310,057, CANC. INT. CL. 35.
- SOFTELEC GMBH, D-80995 MUNCHEN, FED REP GERMANY:
2,022,116, REN. 10-26-06. INT. CL. 9.
2,050,493, REN. 10-26-06. INT. CL. 9.
- SOFTELEC GMBH, 80995 MUENCHEN, FED REP GERMANY:
2,055,583, REN. 10-26-06. INT. CL. 9.
- SOFTMED SYSTEMS, INC., SILVER SPRING, MD:
3,177,885, INT. CL. 9.
- SOFTWARE PROFESSIONALS, INC., DAYTON, OH:
2,308,999, CANC. INT. CL. 9.

- SOJAR S.A., ROSARIO, SANTA FE, ARGENTINA:
3,178,214, INT. CL. 5.
- SOLAR SAILOR PTY LTD, SYDNEY, N.S.W, AUSTRALIA:
3,177,939, INT. CL. 7.
- SOLAR TECH ENTERPRISES, LLC, BOULDER, CO:
2,308,385, CANC. INT. CL. 9.
- SOLIDUS NETWORKS, INC, SAN FRANCISCO, CA:
3,177,796, INT. CL. 9.
- SOLUTIONS PLUS, SAN MARCOS, CA:
1,949,602, CANC. INT. CL. 9.
- SOM OCCHIALI S.R.L., CALALZO DI CADORE (BL), ITALY:
2,308,376, CANC. INT. CL. 9.
- SOMBRA INC., ATLANTA, GA:
2,309,047, CANC. INT. CL. 41.
- SOMFY SAS, FRANCE:
3,177,273, PUB. 9-12-2006. MULTIPLE CLASS, INT. CLS. 7 AND 9.
- SONA MEDSPA INTERNATIONAL, INC., FRANKLIN, TN:
3,175,867, PUB. 9-12-2006. INT. CL. 44.
- SONIC INNOVATIONS, INC., CULVER CITY, CA:
3,177,458, INT. CL. 7.
- SONNE, WARREN J, PORT ST. LUCIE, FL:
3,177,072, PUB. 9-12-2006. INT. CL. 45.
- SONNY SCAFFOLDS, INC., INDIANAPOLIS, IN:
3,176,418, PUB. 4-25-2006. MULTIPLE CLASS, INT. CLS. 6 AND 12.
- SONOCO PRODUCTS COMPANY, HARTSVILLE, SC:
1,378,137, CANC. INT. CL. 22.
- SONOSCAN, INC., ELK GROVE VILLAGE, IL:
2,021,996, REN. 10-26-06. MULTIPLE CLASS, INT. CLS. 41 AND 42.
2,041,776, REN. 10-26-06. INT. CL. 9.
2,043,085, REN. 10-26-06. INT. CL. 9.
- SONY COMPUTER ENTERTAINMENT AMERICA INC., FOSTER CITY, CA:
2,309,615, CANC. INT. CL. 9.
- SONY KABUSHIKI KAISHA, TOKYO, JAPAN, TA SONY CORPORATION:
2,309,205, CANC. INT. CL. 9.
- SONY KABUSHIKI KAISHA, TOKYO, JAPAN, TA SONY CORPORATION:
2,309,978, CANC. INT. CL. 9.
- SONY KABUSHIKI KAISHA, SHINAGAWA-KU, TOKYO, JAPAN, TA SONY CORPORATION:
3,177,424, INT. CL. 9.
- SONY KABUSHIKI KAISHA, TOKYO, JAPAN, TA SONY CORPORATION:
3,178,431, INT. CL. 41.
- SONY ONLINE ENTERTAINMENT INC., CULVER CITY, CA:
2,309,570, CANC. INT. CL. 41.
- SOUND RELATED TECHNOLOGIES, INC., VIRGINIA BEACH, VA:
2,309,208, CANC. INT. CL. 9.
- SOURCE GLOBAL ENTERPRISES, INC., BRONX, NY:
1,994,555, REN. 10-26-06. MULTIPLE CLASS, INT. CLS. 6 AND 20.
- SOURCE PRO US, LLC, FT. LAUDERDALE, FL:
3,176,126, PUB. 9-12-2006. INT. CL. 11.
- SOURCE SERVICES CORPORATION, IRVING, TX TO KFORCE.COM, INC., TAMPA, FL:
1,948,568, CANC. INT. CL. 35.
- SOUTER, JOHN, WAYZATA, MN:
3,177,800, INT. CL. 40.
- SOUTH COAST PLAZA, COSTA MESA, CA:
2,862,021, CANC. MULTIPLE CLASS, INT. CLS. 35 AND 36.
- SOUTH COAST WINERY, INC., SANTA ANA, CA:
3,177,412, INT. CL. 44.
- SOUTH WEST DISTILLERS PTY LTD., DURBAN NORTH, SOUTH AFRICA:
3,178,277, INT. CL. 33.
- SOUTH WEST LIQUORS (PTY) LTD., DURBAN NORTH, KWA ZULU NATAL, SOUTH AFRICA:
3,178,505, INT. CL. 33.
- SOUTHCORP WINES PTY LTD., ADELAIDE SA 5000, AUSTRALIA:
2,309,742, CANC. INT. CL. 33.
- SOUTHEASTERN MILLS, INC., ROME, GA:
3,175,800, PUB. 9-12-2006. INT. CL. 30.
- SOUTHERN LIVING, INC., BIRMINGHAM, AL:
2,309,975, CANC. INT. CL. 16.
- SOUTHERN METHODIST UNIVERSITY, DALLAS, TX:
3,178,669, MULTIPLE CLASS, INT. CLS. 21, 25 AND 41.
- SOUTHERN STATES COOPERATIVE, INCORPORATED, RICHMOND, VA:
813,726, REN. 10-22-06. U.S. CL. 1 (INT. CLS. 1, 3, 4, 17, 18, 19, 22 AND 31).
- SOUTHERN TRADING IMPORT & EXPORT CO. LTD., KOWLOON, HONG KONG:
3,176,526, PUB. 9-12-2006. INT. CL. 25.
- SOUTHWATER, INC., DONGOLA, IL:
1,994,196, REN. 10-23-06. INT. CL. 39.
- SOUTHWESTERN BELL MOBILE SYSTEMS, INC., DALLAS, TX:
2,309,953, CANC. INT. CL. 38.
- SOUTHWESTERN INFORMATION PUBLISHING, IRVING, TX:
2,309,136, CANC. INT. CL. 16.
- SOY CLOTHING, SEATTLE, WA:
2,309,555, CANC. INT. CL. 25.
- SOY PRODUCTS INTERNATIONAL INC., COLUMBIA, SC:
3,177,111, PUB. 9-12-2006. INT. CL. 4.
- SOYA FOODS CO., INC., BOSTON, MA:
3,177,088, PUB. 9-12-2006. INT. CL. 29.
- SPA PHOENIX HOLDINGS, LLC, VIRGINIA BEACH, VA:
3,176,163, PUB. 9-12-2006. INT. CL. 44.
- SPACE SAVER CORPORATION, FORT ATKINSON, WI:
3,177,390, MULTIPLE CLASS, INT. CLS. 35 AND 37.
- SPAN-AMERICA MEDICAL SYSTEMS, INC., GREENVILLE, SC:
3,175,855, PUB. 9-12-2006. INT. CL. 20.
- SPANEK, INC., SAN MATEO, CA:
1,387,566, REN. 10-20-06. INT. CL. 21.
- SPAS2ORDER.COM, SANTA ANA, CA:
3,176,905, PUB. 9-12-2006. INT. CL. 35.
3,176,906, PUB. 9-12-2006. INT. CL. 35.
- SPECIALTY BLADES, INC., STAUNTON, VA:
3,176,385, PUB. 9-12-2006. MULTIPLE CLASS, INT. CLS. 7 AND 8.
- SPECIALTY GRAPHIC IMAGING ASSOCIATION, FAIRFAX, VA, SCREEN PRINTING ASSOCIATION INTERNATIONAL, FAIRFAX, VA:
1,994,074, REN. 10-25-06. INT. CL. 42.
- SPECIALTY LABORATORIES, INC., SANTA MONICA, CA:
2,310,021, CANC. INT. CL. 42.
- SPECTORSOFT CORPORATION, VERO BEACH, FL:
3,176,524, PUB. 9-12-2006. INT. CL. 9.
- SPECTRONICS CORPORATION, WESTBURY, NY, WIDGER CHEMICAL CORPORATION, WARREN, MI:
1,402,717, REN. 10-22-06. INT. CL. 2.
- SPEECHLAW, INC., MISSION VIEJO, CA:
2,308,797, CANC. INT. CL. 9.
- SPEED BRITE, INC., SALISBURY, NC:
3,176,935, PUB. 9-12-2006. INT. CL. 3.
- SPEED CHANNEL, INC., LOS ANGELES, CA:
3,177,161, PUB. 9-12-2006. INT. CL. 41.
- SPEED FRANCE (SOCIÉTÉ ANONYME), FRANCE:
3,177,255, PUB. 9-12-2006. MULTIPLE CLASS, INT. CLS. 7, 17 AND 28.
- SPEIRS, GREG, BRONXVILLE, NY:
2,309,685, CANC. MULTIPLE CLASS, INT. CLS. 9 AND 28.
- SPENCER DIAMONDS CO., LTD., HUNGHOM, KOWLOON, HONG KONG:
3,177,562, INT. CL. 14.
- SPERBER, JOSHUA D., BERKELEY, CA AND MANDEL, LEV L., BERKELEY, CA:
3,178,638, INT. CL. 25.
- SPERON, SAM, PARK RIDGE, IL:
3,178,494, MULTIPLE CLASS, INT. CLS. 3 AND 5.
- SPG SOLUTIONS, LLC, PLEASANTON, CA:
3,176,108, PUB. 9-12-2006. INT. CL. 42.

- SPICE HUNTER, INC., THE, SAN LUIS OBISPO, CA:
2,309,463, CANC. INT. CL. 30.
- SPICON INDUSTRIES PTY LTD, AUSTRALIA:
3,177,257, PUB. 9-12-2006. INT. CL. 9.
- SPIN MASTER LTD., TORONTO, ONTARIO, CANADA:
3,176,074, PUB. 9-12-2006. INT. CL. 28.
- SPINCYCLE, INC., SCOTTSDALE, AZ:
2,309,316, CANC. INT. CL. 37.
- SPIRICLE, INC., PITTSBURGH, PA:
3,176,542, PUB. 9-12-2006. INT. CL. 42.
- SPIRIT SQUARE CENTER FOR ARTS AND EDUCATION,
INC., CHARLOTTE, NC:
2,310,056, CANC. MULTIPLE CLASS, INT. CLS. 41 AND
42.
- SPIRITED ACTION RELEASE AND KINDNESS, INC., NEW
YORK, NY:
3,176,737, PUB. 9-12-2006. MULTIPLE CLASS, INT. CLS.
16, 41 AND 44.
- SPLISH SPLASH CLEANERS, INC., ARLINGTON HEIGHTS,
IL:
3,175,891, PUB. 9-12-2006. INT. CL. 3.
- SPONGETECH, INC., LOS ANGELES, CA:
3,177,767, MULTIPLE CLASS, INT. CLS. 3 AND 21.
- SPORT HELMETS, INC., LIVERPOOL, NY:
3,177,076, PUB. 9-12-2006. INT. CL. 28.
- SPORTS IMAGES, INC., WOBURN, MA:
3,178,222, MULTIPLE CLASS, INT. CLS. 16 AND 20.
- SPORTS SPECIALISTS LIMITED, FAIRPORT, NY:
1,948,710, CANC. INT. CL. 25.
- SPORTVISION SYSTEMS LLC, NEW YORK, NY:
2,308,438, CANC. MULTIPLE CLASS, INT. CLS. 9 AND
41.
- SPOTFIRE, INC., CAMBRIDGE, MA:
2,309,957, CANC. INT. CL. 9.
- SPROVIERI, JOSEPH J., CHICAGO, IL:
3,176,351, PUB. 9-12-2006. INT. CL. 35.
- SPUNKA, INC., LOS ANGELES, CA:
3,176,133, PUB. 9-12-2006. INT. CL. 35.
- SQM NORTH AMERICA CORPORATION, A NEW YORK
CORPORATION, UNITED STATES:
3,177,275, PUB. 8-15-2006. INT. CL. 1.
- SQUARE D COMPANY, PALATINE, IL, SORGEL ELEC-
TRIC COMPANY, MILWAUKEE, WI:
811,280. REN. 10-26-06. U.S. CL. 21 (INT. CL. 9).
- SRA INTERNATIONAL, INC., FAIRFAX, VA:
1,949,356, CANC. INT. CL. 21.
- SRAM CORPORATION, CHICAGO, IL:
3,178,429, INT. CL. 12.
- SRZ PROPERTIES, INC., MEQUON, WI:
3,177,703, INT. CL. 5.
- SSGI, CHICO, CA:
2,308,933, CANC. INT. CL. 9.
- SSM CORPORATION, MEMPHIS, TN:
3,178,273, INT. CL. 36.
- SSS PTY LTD, KINGS PARK, NEW SOUTH WALES,
AUSTRALIA:
3,177,702, INT. CL. 41.
- ST. GEORGE TECHNOLOGY, INC., WILMINGTON, NC:
3,177,533, INT. CL. 10.
- ST. HELENA WINE COMPANY, INC., ST. HELENA, CA:
2,308,695, CANC. INT. CL. 33.
- ST. JOHN, STEWART BLAKE, VALENCIA, CA:
3,176,745, PUB. 9-12-2006. INT. CL. 41.
- ST. JOHNS COUNTY CHAMBER OF COMMERCE, INC., ST.
AUGUSTINE, FL:
3,176,676, PUB. 9-12-2006. INT. CL. 35.
- ST. MAARTEN SPIRITS, LTD., LAS VEGAS, NV, DBA SMS,
LTD.:
1,948,031, CANC. INT. CL. 33.
- STAFFORD, JAMES E, NAPLES, NY, DBA THE SUTTON
COMPANY:
3,176,628, PUB. 9-12-2006. INT. CL. 28.
- STAFFORD, MICHELLE, NEWTON, PA:
3,176,212, PUB. 9-12-2006. INT. CL. 16.
- STAGE AMERICA, INC., ORLANDO, FL:
2,308,431, CANC. INT. CL. 9.
- STAMPIN' UP! INC., RIVERTON, UT:
3,176,487, PUB. 9-12-2006. INT. CL. 6.
- STAN-MIKE CORPORATION, YOUNGSTOWN, OH:
2,309,625, CANC. INT. CL. 39.
- STANCORP FINANCIAL GROUP, INC., PORTLAND, OR:
3,177,810, INT. CL. 36.
- STANGEL, JOHN V., SAN ANTONIO, TX:
3,178,706, INT. CL. 30.
- STANLEY, MARK ANTHONY, PLANO, TX:
3,176,362, PUB. 9-12-2006. INT. CL. 35.
- STANWORTH DEVELOPMENT LIMITED, TORTOLA,
BR.VIRGIN ISLANDS:
3,176,036, PUB. 9-12-2006. INT. CL. 41.
- STAPLES THE OFFICE SUPERSTORE, INC., FRAMING-
HAM, MA:
3,177,624, INT. CL. 35.
- STARBUCKS U.S. BRANDS, LLC, MINDEN, NV:
3,175,941, PUB. 9-12-2006. MULTIPLE CLASS, INT. CLS.
30 AND 43.
- STARLIGHT INTERNATIONAL, LTD. LP, LOS ANGELES,
CA:
2,308,532, CANC. INT. CL. 35.
- STARPLEX SCIENTIFIC INC., ETOBICOKE, ONTARIO,
CANADA:
2,283,077, COR. INT. CL. 9.
- STATE STREET CORPORATION, BOSTON, MA:
3,177,084, PUB. 9-12-2006. INT. CL. 35.
3,177,085, PUB. 9-12-2006. INT. CL. 35.
3,177,087, PUB. 9-12-2006. INT. CL. 35.
- STATION CASINOS, INC., LAS VEGAS, NV:
2,309,634, CANC. INT. CL. 39.
- STATISTICAL ANALYSIS INC., RIVERSIDE, CA:
3,178,053, INT. CL. 42.
- STAVO INDUSTRIES, INC., KINGSTON, NY, STAVO IN-
DUSTRIES OF CONNECTICUT, INCORPORATED, MILL-
DALE, CT, AKA ALSOP ENGINEERING COMPANY:
1,437,731, REN. 10-21-06. INT. CL. 7.
- STEADY, CARL, RANCHO PALOS VERDES, CA:
3,177,942, INT. CL. 19.
3,177,943, INT. CL. 19.
- STEARNS, ASHLEY, FALLON, AURORA, CO:
3,176,859, PUB. 9-12-2006. INT. CL. 25.
- STEARNS, GLENN, SANTA ANA, CA:
3,178,045, MULTIPLE CLASS, INT. CLS. 35, 36 AND 42.
- STEDMAN-TRACY ULTRA SPORTS, INC., JACKSON, MS:
1,378,269, CANC. INT. CL. 28.
- STEETLEY MAGNESIA PRODUCTS LIMITED, RUGBY,
WARWICKSHIRE CV21 2UT, ENGLAND:
1,377,769, CANC. INT. CL. 1.
- STEIMATZKY (2005) LTD., TEL-AVIV, ISRAEL:
1,421,001, REN. 10-22-06. INT. CL. 16.
1,421,002, REN. 10-22-06. INT. CL. 16.
- STEINGRUBER, ARMIN KARL, D - 83233 BERNAU AM
CHIEMSEE, FED REP GERMANY:
2,309,503, CANC. INT. CL. 32.
- STEINWURTZEL COMPANY., INC., THE, SADDLE
BROOK, NJ:
1,378,229, CANC. INT. CL. 25.
- STEP WITH HOPE, EDWARDS, CO:
3,177,063, PUB. 9-12-2006. INT. CL. 36.
- STERLING CHEMICALS, INC., HOUSTON, TX:
1,948,662, CANC. INT. CL. 42.
- STERLING M. ENTERPRISES, INC., SAN FRANCISCO, CA:
3,176,792, PUB. 9-12-2006. INT. CL. 43.
- STERLING PUBLISHING CO., INC., NEW YORK, NY:
3,177,948, INT. CL. 16.
3,178,352, INT. CL. 16.
- STERLING SOFTWARE, INC., DALLAS, TX:
2,309,646, CANC. INT. CL. 9.
- STERN, BRETT, PORTLAND, OR:
3,178,174, INT. CL. 29.
- STERN, CRAIG, LOS ANGELES, CA:
2,310,077, CANC. INT. CL. 35.
- STERNHEIMER BROS., INC., SANDSTON, VA:
1,948,241, CANC. INT. CL. 25.
- STEVE COUSINS AND AMMAAR KHAN, TORONTO,
CANADA:
3,177,894, INT. CL. 25.

STEVEN P. SOBOJINSKI, OSHKOSH, WI, DBA OSHKOSH HUMIKDOR CO.:
2,310,012, CANC. INT. CL. 34.

STEWART, ROBERT JOHN, BOULDER, CO:
3,176,217, PUB. 9-12-2006. INT. CL. 41.

STILO INTERNATIONAL PLC, TEMPLE BLACK, BRISTOL, GREAT BRITAIN, EXOTERICA CORPORATION, OTTAWA, ONTARIO, CANADA:
1,990,838. REN. 10-26-06. INT. CL. 9.

STING FREE COMPANY, BERWYN, PA:
3,177,527, INT. CL. 10.

STINGRAY LIGHTING, INC., TORRANCE, CA:
2,308,863, CANC. INT. CL. 11.

STMICROELECTRONICS S.R.L., I-20041 AGRATE BRIANZA (MILANO), ITALY:
3,177,286, PUB. 9-12-2006. INT. CL. 9.

STOCK MARKET PHOTO AGENCY OF NEW YORK, INC., THE, NEW YORK, NY:
2,309,608, CANC. INT. CL. 42.

STOCKO METALLWARENFABRIKEN HENKELS UND SOHN GMBH & CO., WUPPERTAL, FED REP GERMANY:
1,378,251, CANC. INT. CL. 26.

STOKELY-VAN CAMP, INC., CHICAGO, IL:
1,410,822, AM. INT. CL. 32.

STOKTON S.R.L., PIEVE A NIEVOLE, ITALY:
3,177,649, INT. CL. 25.

STONEVILLE PEDIGREED SEED COMPANY, ST. LOUIS, MO:
3,178,020, INT. CL. 31.

STORCASE TECHNOLOGY, INC., FOUNTAIN VALLEY, CA, CYBERDYNE, INC., MINNEAPOLIS, MN:
1,992,035. REN. 10-21-06. INT. CL. 9.

STORK SCREENS, BOXMEER, NETHERLANDS:
1,377,896, CANC. INT. CL. 7.

STORUS CORPORATION, SAN RAMON, CA:
3,176,065, PUB. 9-12-2006. INT. CL. 20.

STRATAGENE CALIFORNIA, LA JOLLA, CA:
1,995,584. REN. 10-25-06. INT. CL. 1.
1,995,587. REN. 10-25-06. INT. CL. 1.

STRATEGIC MATERIALS, INC., HOUSTON, TX:
1,989,146. REN. 10-24-06. INT. CL. 3.

STRATFORD COMPANIES, LLC, THE, ST. LOUIS, MO:
3,176,872, PUB. 9-12-2006. INT. CL. 43.

STREAMLIGHT, INC., EAGLEVILLE, PA:
3,178,427, INT. CL. 11.

STREAMSERVE, INC., BURLINGTON, MA:
3,177,048, PUB. 9-12-2006. INT. CL. 9.
3,177,049, PUB. 9-12-2006. INT. CL. 9.
3,177,053, PUB. 9-12-2006. INT. CL. 9.

STRETCH THE SKIES INC., ROCHESTER, NY:
3,176,051, PUB. 9-12-2006. MULTIPLE CLASS, INT. CLS. 35 AND 41.

STRETCHAIR PATIENT TRANSFER SYSTEMS, INC., LARGO, FL:
3,178,629, INT. CL. 12.

STRETCHLINE HOLDINGS LIMITED, KOWLOON, HONG KONG:
3,176,280, PUB. 9-12-2006. INT. CL. 26.

STRIKE KING LURE COMPANY, COLLIERVILLE, TN:
1,949,112, CANC. INT. CL. 28.

STROMDAHL, ANDREW W., MINOCQUA, WI AND ROWSE, EDWARD S, WILMINGTON, DE:
3,177,598, INT. CL. 17.

STRONG, CLINTON R., DALLAS, TX:
3,178,189, INT. CL. 9.

STUDENT LOAN XPRESS, INC., SAN DIEGO, CA:
3,176,379, PUB. 9-12-2006. MULTIPLE CLASS, INT. CLS. 16, 35 AND 36.

STUDIO RTA, PICO RIVERA, CA:
3,177,492, INT. CL. 20.

STULLER, INC., LAFAYETTE, LA:
3,177,566, INT. CL. 14.

STUTZ MOTOR CAR OF AMERICA, INC., WEST HILLS, CA:
1,067,631. REN. 10-20-06. INT. CL. 12.

STYLEMARK, INC., ORMOND BEACH, FL:
3,178,601, INT. CL. 9.

SU, RONG, NEW YORK, NY:
3,178,627, INT. CL. 25.

SUBURBAN PROPANE, L.P., WHIPPANY, NJ:
3,177,511, MULTIPLE CLASS, INT. CLS. 35, 37 AND 39.

SUCCES DE PARIS, 75015 PARIS, FRANCE:
1,947,980, CANC. INT. CL. 3.

SUED-CHEMIE AG, D-80333 MUNICH, FED REP GERMANY:
2,463,519, CANC. INT. CL. 1.

SUH, CHUNG SOO, LOS ANGELES, CA:
1,949,184, CANC. INT. CL. 24.

SUISSE NOVELTIES INC., NEW YORK, NY:
2,308,354, CANC. INT. CL. 9.

SULLIVAN, TIMOTHY, AUSTIN, TX:
3,176,380, PUB. 9-12-2006. INT. CL. 5.

SULTAN CHEMISTS, INC., ENGLEWOOD, NJ:
3,177,523, INT. CL. 5.

SUMERSET ACQUISITION, LLC, SOMERSET, KY:
2,270,325 NEW CERT. 11-28-2006. MULTIPLE CLASS, INT. CLS. 12, 35 AND 37.

SUMMAGRAPHICS CORPORATION, AUSTIN, TX TO SUMMA, INC., SEATTLE, WA:
1,948,814, CANC. INT. CL. 9.

SUMMER BAY PARTNERSHIP, CLERMONT, FL:
3,176,388, PUB. 9-12-2006. INT. CL. 36.

SUMMERHILL FARMING, INC., MADERA, CA:
1,948,181, CANC. INT. CL. 36.
1,948,182, CANC. INT. CL. 36.

SUMMITT GROUP HOLDINGS, LLC, TROY, MI, SMITH SECURITY CORPORATION, TROY, MI:
1,994,830. REN. 10-25-06. INT. CL. 42.

SUN LIFE ASSURANCE COMPANY OF CANADA(US), WELLESLEY HILLS, MA AND SUN LIFE ASSURANCE COMPANY, TORONTO, CANADA:
2,274,668, AM. INT. CL. 36.

SUN, DONALD JEEN CHANG, ARCADIA, CA:
1,948,903, CANC. INT. CL. 28.

SUNG, JONG HYUN MINUS, SEOUL, REPUBLIC OF KOREA:
3,177,873, INT. CL. 25.

SUNJEWELS INDIA PVT. LTD., SEEPZ, ANDHERI (E) BOMBAY 400 096, INDIA:
2,048,243. REN. 10-26-06. INT. CL. 14.

SUNNY DELIGHT BEVERAGES CO., CINCINNATI, OH:
3,178,133, INT. CL. 32.

SUNTRUST BANKS, INC., ORLANDO, FL:
3,178,127, INT. CL. 36.
3,178,360, INT. CL. 36.

SUPER BAKERY, INCORPORATED, PITTSBURGH, PA:
3,178,124, INT. CL. 41.

SUPER BRANDS, INC., HENDERSON, NV:
2,309,362, CANC. INT. CL. 3.

SUPER SOLUTIONS CORPORATION, EDEN PRAIRIE, MN:
2,309,794, CANC. INT. CL. 9.

SUPER TECHNOLOGIES, INC, PENSACOLA, FL:
3,176,316, PUB. 9-12-2006. INT. CL. 38.

SUPERIOR TRANSMISSION PARTS INC., TALLAHASSEE, FL:
1,992,184. REN. 10-26-06. INT. CL. 9.

SUPERIOR WASH, INC. OF U.S.A., PEMBROKE PINES, FL:
3,175,890, PUB. 9-12-2006. INT. CL. 37.

SUPERVALU INC., EDEN PRAIRIE, MN:
3,177,790, INT. CL. 32.

SUPPLEMENT TESTING INSTITUTE, INC., TUCSON, AZ:
3,176,397, PUB. 9-12-2006. INT. CL. 5.

SUPPLY MANAGEMENT SERVICES, INC., ATLANTA, GA:
3,176,215, PUB. 9-12-2006. INT. CL. 35.

SUPREME COUNCIL MYSTIC ORDER OF VEILED PROPHETS OF THE ENCHANTED REALM, REYNOLDSBURG, OH:
3,175,913, PUB. 9-12-2006. INT. CL. 44.

SURF LINE HAWAII, LTD., HONOLULU, HI:
3,176,242, PUB. 9-12-2006. INT. CL. 25.

SURLY GIRL STUDIOS INC., MARINA DEL REY, CA:
3,176,621, PUB. 9-12-2006. INT. CL. 18.

SUSAN C. BRIDGES, MEADOWS OF DAN, VA:
3,175,781, PUB. 8-31-2004. INT. CL. 29.

- SUSAN G. KOMEN BREAST CANCER FOUNDATION, THE, DALLAS, TX:
2,075,352. REN. 10-26-06. INT. CL. 41.
2,081,087. REN. 10-26-06. INT. CL. 41.
- SUSHI WITH GUSTO, INC., GREER, SC:
3,176,782, PUB. 9-12-2006. INT. CL. 30.
3,176,783, PUB. 9-12-2006. INT. CL. 30.
- SUTTER HOME WINERY, INC., ST. HELENA, CA:
2,018,047. REN. 10-25-06. INT. CL. 33.
- SUZY-Q ENTERPRISES, INC., SOUTHERN PINES, NC:
3,175,791, PUB. 9-12-2006. INT. CL. 35.
- SVEDALA-ARBRA AB, S-233 81 SVEDALA, SWEDEN:
2,308,734, CANC. INT. CL. 7.
- SWAGELOK COMPANY, SOLON, OH, CREATIVE PATHWAYS, INC., TORRANCE, CA:
1,407,362. REN. 10-25-06. INT. CL. 6.
- SWARTZ, JUDY B., WEST HOLLYWOOD, CA:
3,178,284, INT. CL. 25.
- SWEARINGEN SOFTWARE, INC., HOUSTON, TX:
3,178,248, INT. CL. 9.
- SWEDISH MATCH NORTH EUROPE AB, SWEDEN:
3,177,246, PUB. 9-12-2006. INT. CL. 34.
- SWEET CONCESSIONS, INC., NEW YORK, NY:
2,955,115, COR. INT. CL. 35.
- SWEET MANUFACTURING COMPANY, INC., SPRINGFIELD, OH:
2,009,089. REN. 10-26-06. INT. CL. 7.
- SWIERZEWSKI, STANLEY J. III, HOLYOKE, MA:
3,178,374, INT. CL. 33.
- SWIFT BRANDS COMPANY, GREELEY, CO:
3,178,596, INT. CL. 29.
- SWISS CORNER, INC., NOKOMIS, FL, DBA SALTWATER CAFE:
3,177,658, MULTIPLE CLASS, INT. CLS. 9, 30 AND 43.
- SWMG PRODUCTIONS, INC., PHOENIX, AZ:
2,310,085, CANC. INT. CL. 41.
- SYCAMORE S.C.S. LLC, LOUISVILLE, KY:
3,178,471, MULTIPLE CLASS, INT. CLS. 6 AND 12.
- SYMANTEC CORPORATION, CUPERTINO, CA:
2,308,444, CANC. INT. CL. 9.
- SYMON COMMUNICATIONS, INC., PLANO, TX:
3,177,824, INT. CL. 9.
- SYNECTICS TECHNOLOGY LLC, CAMBRIDGE, MA:
3,177,867, INT. CL. 9.
- SYNERGY/PLANNING, INC., FAIRFAX, VA:
1,949,804, CANC. INT. CL. 41.
1,949,805, CANC. INT. CL. 42.
- SYNNEX CORPORATION, FREMONT, CA:
1,378,373, CANC. INT. CL. 35.
- SYNTHELABO, PARIS, FRANCE:
1,377,867, CANC. INT. CL. 5.
- SYNTHETIC INDUSTRIES, INC., CHICKAMAUGA, GA:
2,308,811, CANC. INT. CL. 6.
- SYRATECH CORPORATION, EAST BOSTON, MA:
3,177,396, INT. CL. 21.
- SYRIAN BAKERY COMPANY, CICERO, IL AND ZB IMPORTING, INC., CICERO, IL:
3,178,570, INT. CL. 29.
- SYSDOME, INC., CALABASAS, CA:
2,309,150, CANC. INT. CL. 36.
- SYSMEX CORPORATION, KOBE, JAPAN:
2,882,225, COR. INT. CL. 5.
- SYSTECH, INC., DARIEN, IL:
3,176,748, PUB. 9-12-2006. INT. CL. 9.
- SYSTEM INTEGRATORS, INC., SACRAMENTO, CA:
2,308,420, CANC. INT. CL. 9.
- SYSTEMS SUPPORT PRODUCTS, LLC, FAIRFAX, VA:
3,178,756, MULTIPLE CLASS, INT. CLS. 9, 11 AND 20.
- T ROWE PRICE GROUP, INC., BALTIMORE, MD:
1,406,112. REN. 10-25-06. INT. CL. 36.
- T. H. CONSTRUCTION OF ANOKA, INC., ANOKA, MN:
3,176,584, PUB. 9-12-2006. INT. CL. 37.
- T. ROWE PRICE ASSOCIATES, INC., BALTIMORE, MD:
1,406,111. REN. 10-25-06. INT. CL. 36.
1,406,115. REN. 10-25-06. INT. CL. 36.
- T. ROWE PRICE GROUP, INC., BALTIMORE, MD:
1,406,108. REN. 10-25-06. INT. CL. 36.
1,406,109. REN. 10-25-06. INT. CL. 36.
1,406,110. REN. 10-25-06. INT. CL. 36.
1,406,114. REN. 10-25-06. INT. CL. 36.
1,406,116. REN. 10-25-06. INT. CL. 36.
- T. WALL PROPERTIES MANAGEMENT CORP., MADISON, WI:
3,176,341, PUB. 9-12-2006. MULTIPLE CLASS, INT. CLS. 36 AND 37.
- T-REX CAFE, INC., HOUSTON, TX:
3,177,508, INT. CL. 43.
- T-ZONE CORPORATE & RESEARCH, INC., HAYWARD, CA:
2,309,154, CANC. INT. CL. 9.
- TACONY CORPORATION, FENTON, MO:
2,308,487, CANC. INT. CL. 7.
2,308,976, CANC. INT. CL. 7.
2,308,984, CANC. INT. CL. 7.
- TACTICAL SHACK, INC., FORT WAYNE, IN:
3,177,539, INT. CL. 35.
- TADIRAN TELECOMMUNICATIONS, INC., CLEARWATER, FL:
2,309,599, CANC. INT. CL. 9.
- TAFF, JAMI B., POTOMAC, MD:
3,178,678, INT. CL. 16.
- TAGALONG ENTERPRISES, REDONDO BEACH, CA:
3,177,177, PUB. 9-12-2006. INT. CL. 22.
- TAGGIES, INC., SPENCER, MA:
3,178,659, MULTIPLE CLASS, INT. CLS. 16, 25 AND 28.
- TAIYO, INC., HONOLULU, HI:
1,056,206. REN. 10-20-06. INT. CL. 30.
- TAKAGI INDUSTRIAL CO., USA INC., IRVINE, CA:
2,309,295, CANC. INT. CL. 6.
- TAKARI INTERNATIONAL, INC., ANAHEIM, CA:
2,026,507. REN. 10-26-06. INT. CL. 29.
- TAKE-TWO INTERACTIVE SOFTWARE, INC., NEW YORK, NY:
3,177,795, INT. CL. 9.
- TAKEDA CHEMICAL INDUSTRIES, LTD., HIGASHI-KU, OSAKA, JAPAN:
1,377,774, CANC. INT. CL. 1.
- TAKENET, LLC, NEW YORK, NY:
3,177,859, INT. CL. 42.
- TALLAHASSEE TIGER SHARKS HOCKEY CLUB, INC., TALLAHASSEE, FL:
2,308,162, CANC. INT. CL. 25.
- TALX CORPORATION, ST. LOUIS, MO:
1,949,636, CANC. INT. CL. 35.
- TAN INDUSTRIES, INC., SAN FRANCISCO, CA:
2,308,600, CANC. INT. CL. 29.
- TANIMURA & ANTLE, INC., SALINAS, CA:
2,309,410, CANC. INT. CL. 31.
2,309,439, CANC. INT. CL. 29.
- TARA'S DREAM LTD., GRAND CAYMAN, CAYMAN ISLANDS:
3,178,087, INT. CL. 3.
- TARGET BRANDS, INC., MINNEAPOLIS, MN:
3,178,092, INT. CL. 35.
- TARKETT INC., FARNHAM, QC, CANADA:
1,949,441, CANC. INT. CL. 27.
- TARO PHARMACEUTICALS U.S.A., INC., HAWTHORNE, NY:
3,178,666, INT. CL. 5.
- TASMAN INDUSTRIES LIMITED, AUCKLAND, NEW ZEALAND:
2,309,536, CANC. INT. CL. 16.
- TATE & LYLE INGREDIENTS AMERICAS, INC., DECATUR, IL:
3,177,681, INT. CL. 30.
- TATE, JANE D., ALBION, CA:
3,177,916, INT. CL. 28.
- TATIL SEYAHAT TURIZM ANONIM SIRKETI, TURKEY:
3,177,241, PUB. 9-12-2006. MULTIPLE CLASS, INT. CLS. 39, 41 AND 43.
- TATMAR RESTAURANT, INC., NEW YORK, NY:
3,176,680, PUB. 9-12-2006. INT. CL. 43.

TAULELL, S.A., 12006 CASTELLON, SPAIN:
2,308,435, CANC. INT. CL. 19.

TAVDI, ALEX, LOS ANGELES, CA:
3,178,141, INT. CL. 25.

TAVISTOCK RESTAURANTS, LLC, EMERYVILLE, CA,
CALIFORNIA CAFE RESTAURANT CORPORATION,
CORTE MADERA, CA:
1,967,107, REN. 10-24-06. INT. CL. 42.

TAYLOR BRANDS, LLC, KINGSPORT, TN:
3,178,182, INT. CL. 18.
3,178,183, INT. CL. 11.
3,178,184, INT. CL. 28.
3,178,185, INT. CL. 9.

TAYLOR CORPORATION, NORTH MANKATO, MN:
2,308,662, CANC. INT. CL. 42.
2,310,042, CANC. INT. CL. 42.
2,310,043, CANC. INT. CL. 42.

TAYLOR MADE GOLF COMPANY, INC., CARLSBAD, CA:
1,411,498, REN. 10-23-06. INT. CL. 28.

TAYLOR-GOOD, KAREN, NASHVILLE, TN:
3,176,373, PUB. 9-12-2006. INT. CL. 41.

TAYLOR, VINCENT C., JACKSONVILLE, FL:
3,176,198, PUB. 9-12-2006. INT. CL. 16.

TC LICENSE, LTD, HUMMELSTOWN, PA:
2,308,304, CANC. INT. CL. 38.

TCF FINANCIAL CORPORATION, MINNEAPOLIS, MN:
2,308,706, CANC. INT. CL. 36.

TCG INTERNATIONAL INC., BRITISH COLOMBIA, CANA-
DA:
1,045,704, REN. 10-20-06. INT. CL. 3.

TCOM, L.P., COLUMBIA, MD:
1,977,116, REN. 10-24-06. INT. CL. 42.

TDDS, INC., DIAMOND, OH:
2,308,500, CANC. INT. CL. 41.

TDK CORPORATION, TOKYO, JAPAN:
3,175,819, PUB. 5-9-2006. INT. CL. 9.

TEAL LTD., ROWLAND HEIGHTS, CA:
2,224,173, CANC. INT. CL. 9.

TEAM CHEMISTRY LLC, RENO, NV:
3,177,531, INT. CL. 35.

TECHNICAL CONCEPTS L.P., MUNDELEIN, IL:
2,309,182, CANC. INT. CL. 35.

TECNO ALARM S.N.C. DI TRUCCHI LUCIANO E NEGRO
GIOVANNI, TURIN, ITALY:
3,113,752, COR. INT. CL. 9.

TECUMSEH PRODUCTS COMPANY, TECUMSEH, MI:
1,378,026, CANC. INT. CL. 12.

TEH YOR CO., LTD., SEC. 1, TAIPEI, TAIWAN:
3,175,834, PUB. 9-12-2006. MULTIPLE CLASS, INT. CLS.
6, 7 AND 20.

TEHEN, 07500 GUILHERAND GRANGES, FRANCE:
1,404,122, REN. 10-24-06. INT. CL. 25.

TEK-SEAL OF AMERICA, INC., WICHITA, KS:
1,948,580, CANC. INT. CL. 19.

TEKNOR, INC., BOISE, ID:
3,176,096, PUB. 9-12-2006. INT. CL. 36.

TEKO, LLC, BOULDER, CO:
3,177,912, INT. CL. 25.

TELCO PRODUCTIONS, INC., SANTA MONICA, CA:
2,308,240, CANC. INT. CL. 16.

TELECOMMUNICATIONS TECHNIQUES CORPORATION,
GERMANTOWN, MD:
2,308,194, CANC. INT. CL. 9.

TELEDYNE INDUSTRIES, INC., LOS ANGELES, CA:
1,377,876, CANC. INT. CL. 6.
1,377,877, CANC. INT. CL. 6.

TELEGUAM HOLDINGS, LLC, TAMUNING, GUAM:
3,178,651, INT. CL. 38.
3,178,652, INT. CL. 38.

TELENOR SATELLITE SERVICES, INC., ROCKVILLE, MD:
3,175,813, PUB. 9-12-2006. INT. CL. 38.

TELEREP, INC., NEW YORK, NY:
2,309,238, CANC. INT. CL. 35.

TELEVERSE MEDIA, LLC, MILFORD, CT:
3,177,641, INT. CL. 41.

TELEVISA, S.A. DE C.V., MEXICO, D.F., MEXICO:
3,178,590, INT. CL. 41.

TELEWAY, INC., WESTBURY, NY TO FRESH INTELLEC-
TUAL PROPERTIES INC., WILMINGTON, DE:
1,911,701, AM. INT. CL. 35.

TELLINGTON JONES, LINDA, SANTA FE, NM, THANE
MARKETING, LA QUINTA, CA:
2,016,230, REN. 10-20-06. MULTIPLE CLASS, INT. CLS. 9,
16, 18, 31 AND 41.

TELLURE MARKETING & DISTRIBUTION, INC., DUNEL-
LEN, NJ:
1,948,689, CANC. INT. CL. 19.

TELSTRA CORPORATION LIMITED, MELBOURNE, VIC-
TORIA 3000, AUSTRALIA:
2,308,192, CANC. MULTIPLE CLASS, INT. CLS. 38, 41
AND 42.

TEMPCO ELECTRIC HEATER CORPORATION, WOOD
DALE, IL:
1,429,146, REN. 10-23-06. INT. CL. 11.

TEMPTRON HEATING & COOLING INC., LAKE VILLA, IL:
3,176,703, PUB. 9-12-2006. INT. CL. 37.

TENAYA, INC., IRVING, TX:
2,309,563, CANC. INT. CL. 42.

TENDERLOIN TECHNOLOGIES, INC., TRESURE ISLAND,
CA:
3,177,602, INT. CL. 9.

TENDERLOIN TECHNOLOGIES, INC., TREASURE IS-
LAND, CA:
3,177,603, INT. CL. 41.

TENNESSEE GAS PIPELINE COMPANY, HOUSTON, TX:
1,377,833, CANC. MULTIPLE CLASS, INT. CLS. 4 AND
39.

TENNISON GROUP, DENVER, CO:
3,178,687, INT. CL. 35.

TEQUILA CUERVO LA ROJENA, S.A. DE C.V., ZAPOCAN
JALISCO, CODIGO 45070, MEXICO, GRUPO INDUS-
TRIAL B.G., S.A., ELVIRA MENDEZ, PANAMA:
1,404,313, REN. 10-24-06. INT. CL. 32.

TERAYON COMMUNICATION SYSTEMS INC., SANTA
CLARA, CA:
2,309,564, CANC. INT. CL. 9.

TERMINAL GRAVITY BREWING INC., ENTERPRISE, OR:
3,175,926, PUB. 9-12-2006. INT. CL. 32.

TERMINIX INTERNATIONAL COMPANY LP, MEMPHIS,
TN:
3,178,101, INT. CL. 37.

TERRALOG TECHNOLOGIES INC., CALGARY, AB T2N
3P4, CANADA:
2,310,064, CANC. INT. CL. 37.

TETLEY INC., SHELTON, CT TO TETLEY USA INC.,
SHELTON, CT:
1,948,668, CANC. INT. CL. 30.

TEXAS HEART INSTITUTE, HOUSTON, TX:
3,177,526, MULTIPLE CLASS, INT. CLS. 42 AND 44.

TEXTILE/CLOTHING TECHNOLOGY CORPORATION,
CARY, NC:
3,178,742, INT. CL. 42.

TEXTRON INNOVATIONS INC., PROVIDENCE, RI:
1,404,498, REN. 10-20-06. INT. CL. 9.

THANE MARKETING, LA QUINTA, CA TO TELLINGTON
JONES, LINDA, SANTA FE, NM:
2,016,230, CANC. INT. CL. 3.

THARP, JACK D., HOTCHKISS, CO:
2,309,826, CANC. INT. CL. 42.

THAT COMPUTER CHICK, LLC, MARIETTA, GA:
3,176,949, PUB. 9-12-2006. INT. CL. 42.

THAT GIRL TOO, INC., PLANO, TX:
2,309,397, CANC. INT. CL. 28.

THE ADIRONDACK TRUST COMPANY, SARATOGA
SPRINGS, NY:
3,176,742, PUB. 9-12-2006. INT. CL. 36.
3,176,743, PUB. 9-12-2006. INT. CL. 36.

THE BANCORP BANK, WILMINGTON, DE:
3,178,130, INT. CL. 36.

THE BARNYCZ GROUP, INC., BALTIMORE, MD:
3,176,514, PUB. 9-12-2006. MULTIPLE CLASS, INT. CLS.
35 AND 42.

THE BEAR STEARNS COMPANIES INC., NEW YORK, NY:
3,176,267, PUB. 9-12-2006. INT. CL. 36.

- THE BETHEL PERFORMING ARTS CENTER, LLC, LIBERTY, NY:
2,309,216, CANC. MULTIPLE CLASS, INT. CLS. 25 AND 41.
- THE BILLBOARD CLOTHING COMPANY, LLC., LOS ANGELES, CA:
3,177,397, INT. CL. 25.
- THE CARTOON NETWORK LP, LLLP, ATLANTA, GA:
3,177,006, PUB. 9-12-2006. INT. CL. 41.
- THE CHI PHI FRATERNITY, INC., LILBURN, GA:
3,176,659, PUB. 9-12-2006. U.S. CL. 200.
3,176,661, PUB. 9-12-2006. U.S. CL. 200.
- THE CHI PHI FRATERNITY, INC., LILBURN, GA:
3,176,666, PUB. 9-12-2006. MULTIPLE CLASS, INT. CLS. 14 AND 25.
- THE COAST DISTRIBUTION SYSTEM, INC., MORGAN HILL, CA:
3,178,780, INT. CL. 20.
- THE COCA-COLA COMPANY, ATLANTA, GA:
3,178,602, INT. CL. 32.
- THE COLEMAN COMPANY, INC., WICHITA, KS:
3,177,799, INT. CL. 20.
- THE COLLECTIBLE SOURCE, INC., CRANSTON, RI TO THE COLLECTIBLE SOURCE, INC., CRANSTON, RI:
1,948,847, CANC. INT. CL. 16.
- THE COMMONFUND FOR NONPROFIT ORGANIZATIONS, WILTON, CT:
3,176,605, PUB. 9-12-2006. INT. CL. 36.
- THE CONNORS GROUP, INC., SHERMAN OAKS, CA:
3,176,858, PUB. 9-12-2006. INT. CL. 36.
- THE CORNERSTONE GROUP, L.L.C., ANCHORAGE, AK:
3,176,309, PUB. 9-12-2006. INT. CL. 36.
- THE CORT COFFEE COMPANY, PLANTATION, FL:
3,178,314, INT. CL. 43.
- THE CULTURAL EDGE, LLC, TORRANCE, CA:
3,177,619, MULTIPLE CLASS, INT. CLS. 35 AND 36.
- THE DURHAM MANUFACTURING COMPANY, DURHAM, CT:
3,175,982, PUB. 9-12-2006. INT. CL. 20.
- THE EFFORT TRUST COMPANY, TORONTO, ONTARIO M4W 3V8, CANADA:
3,176,049, PUB. 9-12-2006. MULTIPLE CLASS, INT. CLS. 35 AND 36.
- THE EMPYREAN GROUP, LLC, SEWICKELY, PA:
3,177,004, PUB. 9-12-2006. MULTIPLE CLASS, INT. CLS. 35, 36, 41 AND 42.
- THE ENDURANCE INTERNATIONAL GROUP, INC., BURLINGTON, MA:
3,175,990, PUB. 9-12-2006. MULTIPLE CLASS, INT. CLS. 35, 37 AND 42.
- THE FABULOUS MAMMALS, WICHITA FALLS, TX, DBA THE MAMMALS:
3,176,410, PUB. 9-12-2006. INT. CL. 41.
- THE FAMILY INSTITUTE, EVANSTON, IL:
3,177,500, INT. CL. 16.
- THE FANFARE GROUP, INC., MOUNTAIN VIEW, CA:
3,178,009, MULTIPLE CLASS, INT. CLS. 9 AND 42.
3,178,010, INT. CL. 9.
3,178,011, MULTIPLE CLASS, INT. CLS. 9 AND 42.
- THE FUTURE OF IDEAS, BENSLEM, PA:
3,176,041, PUB. 9-12-2006. INT. CL. 35.
- THE GARMON CORPORATION, TEMECULA, CA, GREENTREE LABORATORIES, INC., TUSTIN, CA:
1,951,505, REN. 10-26-06. INT. CL. 3.
1,954,954, REN. 10-26-06. INT. CL. 3.
- THE GILLETTE COMPANY, BOSTON, MA:
3,178,070, INT. CL. 21.
- THE GLEASON WORKS, ROCHESTER, NY:
3,178,603, INT. CL. 7.
- THE GOODY BAG LLC, KINGWOOD, TX:
3,176,947, PUB. 9-12-2006. INT. CL. 35.
- THE HARTZ MOUNTAIN CORPORATION, SECAUCUS, NJ:
3,176,237, PUB. 9-12-2006. INT. CL. 21.
3,178,425, INT. CL. 1.
- THE HEALTH NETWORK OF CHESTER COUNTY HOSPITAL, WEST CHESTER, PA:
3,176,205, PUB. 9-12-2006. INT. CL. 44.
- THE HEMINGFORD CO-OPERATIVE TELEPHONE COMPANY, HEMINGFORD, NE:
3,178,453, MULTIPLE CLASS, INT. CLS. 37, 38, 42 AND 45.
- THE HERFF JONES COMPANY OF INDIANA, INC., INDIANAPOLIS, IN:
1,991,419, REN. 10-26-06. INT. CL. 14.
- THE HUMAN EDGE, LLC, GREENVILLE, SC:
3,176,161, PUB. 9-12-2006. INT. CL. 41.
- THE INSTITUTE OF CULTURAL AFFAIRS, CHICAGO, IL:
3,176,453, PUB. 9-12-2006. INT. CL. 16.
- THE JANE GOODALL INSTITUTE FOR WILDLIFE RESEARCH, EDUCATION AND CONSERVATION, ARLINGTON, VA:
3,177,188, PUB. 9-12-2006. INT. CL. 28.
- THE JERK PIT LLC., PRINCETON, NJ:
3,176,983, PUB. 9-12-2006. INT. CL. 43.
- THE JOHN T. PETERS FOUNDATION, MINNETONKA, MN:
3,176,784, PUB. 9-12-2006. INT. CL. 36.
- THE KROGER CO. OF MICHIGAN, LIVONIA, MI:
3,178,238, INT. CL. 32.
3,178,725, INT. CL. 31.
- THE LANDRAGINS & COMPANY, LLC, GAINESVILLE, VA:
3,177,875, MULTIPLE CLASS, INT. CLS. 33 AND 35.
- THE MCGRAW-HILL COMPANIES, INC., NEW YORK, NY:
3,178,159, INT. CL. 36.
- THE MEOW MIX COMPANY, SECAUCUS, NJ:
3,178,526, INT. CL. 31.
3,178,527, INT. CL. 31.
- THE MORTGAGE STORE FINANCIAL, INC., LOS ANGELES, CA:
3,176,945, PUB. 9-12-2006. INT. CL. 36.
- THE NUANCING GROUP, LLC, SAN DIEGO, CA:
3,177,393, INT. CL. 16.
- THE NUMERICAL ALGORITHMS GROUP LIMITED, OXFORD, GREAT BRITAIN:
3,176,434, PUB. 9-12-2006. MULTIPLE CLASS, INT. CLS. 9 AND 16.
- THE ONTARIO KNIFE COMPANY, FRANKLINVILLE, NY:
3,177,883, INT. CL. 8.
- THE ORIGINAL GINO'S, INC., TOLEDO, OH:
3,178,615, INT. CL. 43.
- THE ORR FELT COMPANY, PIQUA, OH:
3,175,897, PUB. 9-12-2006. INT. CL. 7.
- THE ORVIS COMPANY, INC., MANCHESTER, VT:
3,178,606, INT. CL. 24.
- THE PERFECT LETTER, INC., LINCOLNSHIRE, IL:
3,176,798, PUB. 9-12-2006. INT. CL. 35.
- THE PERSONAL MARKETING COMPANY, INC., LENEXA, KS:
3,176,721, PUB. 9-12-2006. INT. CL. 16.
- THE PNC FINANCIAL SERVICES GROUP, INC., PITTSBURGH, PA:
3,178,472, INT. CL. 36.
- THE PORTER DUVAL GROUP, LLC, BRENTWOOD, TN:
3,177,182, PUB. 9-12-2006. MULTIPLE CLASS, INT. CLS. 16 AND 41.
- THE PROCTER & GAMBLE COMPANY, CINCINNATI, OH:
3,176,963, PUB. 9-12-2006. INT. CL. 44.
3,177,716, INT. CL. 3.
3,177,841, INT. CL. 16.
3,178,097, MULTIPLE CLASS, INT. CLS. 3, 5 AND 11.
3,178,098, MULTIPLE CLASS, INT. CLS. 3, 5 AND 11.
3,178,187, INT. CL. 3.
3,178,217, MULTIPLE CLASS, INT. CLS. 35 AND 41.
3,178,219, MULTIPLE CLASS, INT. CLS. 35 AND 41.
3,178,381, INT. CL. 16.
3,178,424, INT. CL. 3.
3,178,497, INT. CL. 16.
- THE RIVER INN, LP, BIG SUR, CA:
3,176,254, PUB. 9-12-2006. INT. CL. 43.
- THE ROASTED PEPPER, INC., ROSWELL, GA:
3,177,557, INT. CL. 43.
- THE ROUSSEAU COMPANY, INC., ALBANY, NY:
3,176,527, PUB. 9-12-2006. INT. CL. 36.

THE SCIENTIFIC INVESTOR LLC, CLARKESVILLE, GA:
3,177,117, PUB. 9-12-2006. INT. CL. 36.

THE SHERWIN-WILLIAMS COMPANY, CLEVELAND, OH:
3,178,057, INT. CL. 3.

THE STEP COMPANY, MARIETTA, GA:
3,178,287, INT. CL. 25.

THE SUNRIDER CORPORATION, TORRANCE, CA, DBA
SUNRIDER INTERNATIONAL:
3,092,280, COR. INT. CL. 5.

THE TAX STORE, INC., MCALLEN, TX:
3,175,918, PUB. 9-12-2006. INT. CL. 35.

THE TOPLINE CORPORATION, BELLEVUE, WA:
3,177,103, PUB. 9-12-2006. INT. CL. 25.
3,177,836, INT. CL. 25.

THE TOPPS COMPANY, INC., NEW YORK, NY:
3,176,343, PUB. 9-12-2006. INT. CL. 30.

THE TORO COMPANY, BLOOMINGTON, MN:
3,176,191, PUB. 9-12-2006. INT. CL. 2.

THE TRUSTEES OF THE AMERICAN FEDERATION OF
MUSICIANS' AND EMPLOYERS' PENSION WELFARE
FUND, TORONTO, ONTARIO, CANADA:
3,175,783, PUB. 9-12-2006. MULTIPLE CLASS, INT. CLS.
16, 24, 25, 28 AND 36.
3,175,784, PUB. 9-12-2006. MULTIPLE CLASS, INT. CLS.
16, 24, 25, 28 AND 36.

THE TRUSTEES OF THE PEF MEMBERSHIP PROGRAM,
ALBANY, NY:
3,175,845, PUB. 9-12-2006. INT. CL. 35.

THE W. W. HENRY COMPANY, L.P., ALIQUIPPA, PA:
3,178,785, INT. CL. 19.

THE WESTMINSTER KENNEL CLUB, NEW YORK, NY:
3,177,927, INT. CL. 44.

THE WORLD HYPERTENSION LEAGUE, TOLEDO, OH:
3,177,473, INT. CL. 41.

THEATRICAL DEALERS ASSOCIATION, NEW YORK, NY,
DBA ENTERTAINMENT SERVICES AND TECHNOLOGY
ASSOCIATION:
3,177,714, U.S. CL. B.

THERAFLAX USA, INC., NEW YORK, NY:
3,075,750, AM. INT. CL. 5.

THERMO ELECTRON CORPORATION, COON RAPIDS,
MN:
3,178,270, INT. CL. 9.

THERMO KING CORPORATION, MINNEAPOLIS, MN:
811,277. REN. 10-24-06. MULTIPLE CLASS, U.S. CLS. 19
(INT. CL. 12) AND 31 (INT. CL. 11).

THERMOMETRICS, INC., EDISON, NJ:
2,309,914, CANC. INT. CL. 9.

THERMOPRODUKTER AB, SWEDEN:
3,177,291, PUB. 9-12-2006. INT. CL. 11.

THERMOS L.L.C., ROLLING MEADOWS, IL:
3,178,247, INT. CL. 21.

THERMOVUE ACQUISITION CORPORATION, WA-
SHINGTON, DC:
3,177,606, INT. CL. 19.

THF EQUITIES, LP, WESTCHESTER, IL, W. B. RODDENB-
ERY COMPANY, INC., CAIRO, GA:
2,002,654. REN. 10-26-06. INT. CL. 30.

THF EQUITIES, LP, WESTCHESTER, IL, CURTICE-BURNS
FOODS, INC., ROCHESTER, NY:
2,042,766. REN. 10-26-06. INT. CL. 29.

THIBIERGE & COMAR, 75017 PARIS, FRANCE:
2,309,702, CANC. INT. CL. 16.

THINKING TECHNOLOGY INC., NASSAU, BAHAMAS:
3,178,058, MULTIPLE CLASS, INT. CLS. 9 AND 28.

THINKWELL CORPORATION, AUSTIN, TX:
3,122,926, COR. MULTIPLE CLASS, INT. CLS. 9 AND 41.

THIRSTY DOG BREWING COMPANY, INDEPENDENCE,
OH:
3,176,752, PUB. 9-12-2006. INT. CL. 32.
3,177,535, INT. CL. 32.

THOMAS LOWE VENTURES, INC., SOUTH BEND, IN:
2,309,401, CANC. INT. CL. 28.

THOMAS PUBLISHING COMPANY, NEW YORK, NY:
3,177,614, INT. CL. 35.

THOMAS, CHRISTINE L., STEVENS POINT, WI:
2,308,476, CANC. INT. CL. 41.

THOMPSON TECHNOLOGY INC., AVON, NY:
2,308,477, CANC. INT. CL. 9.

THOMPSON, VINCENT, BLUE BELL, PA:
3,118,632, COR. INT. CL. 28.

THOMSON CORPORATION, THE, TORONTO, ONTARIO
M5K 1A1, CANADA:
2,309,220, CANC. MULTIPLE CLASS, INT. CLS. 9 AND
16.

THOMSON, MARGARET I., DETROIT, MI:
2,308,283, CANC. INT. CL. 25.

THREE-D SPIRITS, INC., PETALUMA, CA:
3,178,152, INT. CL. 28.

THUNDER TIGER CORPORATION, TAICHUNG CITY 407,
TAIWAN:
3,176,457, PUB. 9-12-2006. INT. CL. 10.

THUNDERFOOT ENTERPRISES, INC., GLENDALE, CA:
2,309,292, CANC. INT. CL. 3.

TIANJIN GOUBULI STEAMED BUN AND FOOD AND
DRINK (GROUP) CO., TIANJIN, CHINA:
3,176,141, PUB. 5-23-2006. INT. CL. 43.

TILES 4 U HOLDINGS, INC., ORLANDO, FL:
3,176,197, PUB. 9-12-2006. INT. CL. 35.

TIM MCCARTHY ADVERTISING, INC., DALLAS, TX, DBA
THE MCCARTHY COMPANIES:
3,177,892, INT. CL. 35.

TIMBERTECH LIMITED, COLUMBUS, OH:
3,178,753, INT. CL. 19.

TIME BASE PTY LIMITED, SYDNEY, AUSTRALIA:
2,308,239, CANC. MULTIPLE CLASS, INT. CLS. 9 AND
42.

TIMEPIECES DIRECT INC., TEMECULA, CA:
3,176,831, PUB. 9-12-2006. INT. CL. 35.

TIMES MIRROR COMPANY, THE, LOS ANGELES, CA:
2,308,285, CANC. INT. CL. 41.

TIN INC., AUSTIN, TX:
3,176,495, PUB. 9-12-2006. INT. CL. 19.

TIRONE, MARIO L., JR., MIDDLETOWN, CT:
1,949,503, CANC. INT. CL. 28.

TISHMAN HOTEL CORPORATION, LAKE BUENA VISTA,
FL:
2,309,020, CANC. MULTIPLE CLASS, INT. CLS. 9 AND
35.

TITLES UNLIMITED, INC., TARRANT, AL:
2,308,577, CANC. INT. CL. 42.

TLC HEALTHCARE QUALITY IMPROVEMENT ORGANI-
ZATION, INC., TUCSON, AZ:
3,176,238, PUB. 9-12-2006. INT. CL. 44.

TNA ENTERTAINMENT, LLC, DALLAS, TX:
3,177,123, PUB. 9-12-2006. INT. CL. 41.
3,177,124, PUB. 9-12-2006. INT. CL. 41.
3,177,159, PUB. 9-12-2006. INT. CL. 41.
3,177,163, PUB. 9-12-2006. INT. CL. 41.

TNE INVESTMENT SERVICES, L.P., BOSTON, MA TO IXIS
ASSET MANAGEMENT DISTRIBUTORS, L.P., BOSTON,
MA:
1,949,511, CANC. INT. CL. 36.

TO BE GOOD, INC., DALLAS, TX:
2,309,743, CANC. INT. CL. 9.

TODD ERHARD, JACKSON, MI, ERHARD, DANIEL R.,
JACKSON, MI:
2,016,896. REN. 10-26-06. INT. CL. 37.

TOGGLE ENTERTAINMENT, INC., NEW YORK, NY:
2,308,263, CANC. INT. CL. 9.

TOLEDO TACKLE USA, INC., MANY, IA, LA:
2,309,423, CANC. INT. CL. 28.

TONDEO-WERK GMBH, FED REP GERMANY:
3,177,254, PUB. 9-12-2006. MULTIPLE CLASS, INT. CLS.
8, 9 AND 11.

TONERHEAD, INC., MCHENRY, IL:
3,177,028, PUB. 9-12-2006. INT. CL. 7.

TONERTIGER, INC., ABILENE, TX:
3,175,814, PUB. 11-8-2005. INT. CL. 37.

TOOLS FOR EDUCATION, INC., AMBLER, PA:
2,309,881, CANC. INT. CL. 9.

TOOTSIE ROLL INDUSTRIES, INC., CHICAGO, IL:
1,378,199, CANC. INT. CL. 25.

TOP OIL PRODUCTS COMPANY, BURLINGAME, CA:
1,995,127. REN. 10-24-06. INT. CL. 4.

- TOP TIER CONSULTING, WOODLAND HILLS, CA:
3,176,135, PUB. 9-12-2006. INT. CL. 35.
- TOP TO BOTTOM HOME INSPECTION, INC., TAMPA, FL:
3,176,345, PUB. 9-12-2006. INT. CL. 42.
- TOPS BRANDS, INC., WILMINGTON, DE, NIAGARA
FRONTIER SERVICES, INC., BUFFALO, NY:
1,433,101, REN. 10-25-06. INT. CL. 29.
- TOPS MFG. CO., INC., DARIEN, CT, TOPS MANUFACTUR-
ING CO., INC., MOUNT VERNON, NY:
813,819, REN. 10-25-06. U.S. CL. 13 (INT. CL. 6).
- TOPSONIC, INC., VERNON, CA:
3,176,776, PUB. 9-12-2006. INT. CL. 9.
- TOPWAY DEVELOPMENTS PTY LTD, SOUTH AUSTRA-
LIA, AUSTRALIA:
3,176,317, PUB. 9-12-2006. INT. CL. 33.
- TORAYA CONFECTIONERY LTD., TOKYO 107, JAPAN:
1,994,283, REN. 10-24-06. INT. CL. 30.
- TORONTO MEDICAL CORP., SCARBOROUGH, ONTARIO,
CANADA:
1,377,993, CANC. INT. CL. 10.
- TOSHIBA AMERICA CONSUMER PRODUCTS, L.L.C.,
WAYNE, NJ:
1,949,663, CANC. INT. CL. 9.
- TOSHIBA AMERICA INFORMATION SYSTEMS, INC., IR-
VINE, CA:
3,176,199, PUB. 9-12-2006. INT. CL. 9.
- TOTALLY COACHED, INC., SCOTTSDALE, AZ:
3,176,003, PUB. 9-20-2005. INT. CL. 41.
- TOURAINÉ PAINTS, INC., EVERETT, MA:
1,377,784, CANC. INT. CL. 2.
- TOVEKO AB, SANDVIKEN, SWEDEN:
2,308,481, CANC. INT. CL. 11.
2,308,482, CANC. INT. CL. 11.
- TOWER PRODUCTS INCORPORATED, SAUGERTIES, NY:
3,175,894, PUB. 9-12-2006. INT. CL. 9.
- TOWNSEND PRODUCTS, INC., RICHFIELD, OH:
3,176,313, PUB. 9-12-2006. INT. CL. 35.
- TOX PRESSOTECHNIK GMBH & CO. KG, FED REP
GERMANY:
3,177,230, PUB. 9-12-2006. MULTIPLE CLASS, INT. CLS. 7
AND 8.
- TOY MAN, INC., THE, EDISON, NJ:
2,309,339, CANC. INT. CL. 28.
- TOY STATE INDUSTRIAL LTD., KOWLOON, HONG
KONG:
3,178,545, INT. CL. 28.
- TOYOTA JIDOSHA KABUSHIKI KAISHA, TOYOTA-SHI,
AICHI-KEN, JAPAN, TA TOYOTA MOTOR CORPORA-
TION:
3,178,055, INT. CL. 12.
- TOYTRACKERZ LLC, FORT SCOTT, KS:
3,178,499, INT. CL. 28.
- TRACEY TECHNOLOGIES LLC, HOUSTON, TX:
3,177,374, INT. CL. 44.
- TRACIE MARTYN, INC., NEW YORK, NY:
3,178,683, INT. CL. 3.
- TRADEMARK INTERNATIONAL S.R.L., LUCCA, ITALY:
3,177,863, MULTIPLE CLASS, INT. CLS. 9 AND 25.
- TRADEMARK MANAGEMENT COMPANY, MERIDIAN,
ID:
3,177,132, PUB. 9-12-2006. INT. CL. 29.
- TRADING BLOX, LLC, HARVARD, MA:
3,176,585, PUB. 9-12-2006. INT. CL. 9.
- TRAFFIX DEVICES, SAN CLEMENTE, CA:
2,037,696, REN. 10-25-06. INT. CL. 9.
- TRAILER CORPORATION OF AMERICA, INC., EASLEY,
SC:
3,175,818, PUB. 9-12-2006. INT. CL. 12.
- TRANSAMERICAN NATURAL GAS CORPORATION,
HOUSTON, TX TO TRANSTEXAS GAS CORPORATION,
HOUSTON, TX:
1,949,407, CANC. INT. CL. 4.
- TRANSCIENCE CORPORATION, BRYANS ROAD, MD:
1,377,903, CANC. INT. CL. 8.
1,377,904, CANC. INT. CL. 8.
- TRANSDERMAL PRODUCTS, INC., BRISTOL, PA TO
TRANSDERMAL PRODUCTS INTERNATIONAL MAR-
KETING CORP., BRISTOL, PA:
1,948,033, CANC. INT. CL. 5.
- TRANSFUTURE WEB DESIGN & MULTIMEDIA, LLC,
DOBBS FERRY, NY:
3,178,491, INT. CL. 42.
- TRANSISTOR DEVICES, INC., CEDAR KNOLLS, NJ:
2,308,241, CANC. INT. CL. 9.
- TRANSURETY, LLC, MINNEAPOLIS, MN:
3,177,595, INT. CL. 36.
- TRAPEZE NETWORKS, INC., PLEASANTON, CA:
3,178,732, INT. CL. 9.
- TRAUMA ENTERTAINMENT, INC., SHERMAN OAKS, CA:
1,949,398, CANC. INT. CL. 9.
- TRAVEL PLANNERS, INC., NEW YORK, NY:
3,177,382, INT. CL. 43.
- TRAVEL TRADE PRODUCTIONS, INC., NEW YORK, NY:
2,308,924, CANC. INT. CL. 35.
2,309,545, CANC. MULTIPLE CLASS, INT. CLS. 16 AND
35.
- TRAVELSUPPLIES.COM, LLC, LAS VEGAS, NV:
2,310,046, CANC. INT. CL. 35.
- TREAT ENTERTAINMENT, INC., FLORENCE, AL:
1,949,221, CANC. INT. CL. 16.
- TREK AND TRAIL, INC., BAYFIELD, WI:
2,009,718, REN. 10-26-06. MULTIPLE CLASS, INT. CLS.
39, 41 AND 42.
- TREW AUDIO NASHVILLE, INC., NASHVILLE, TN:
3,176,491, PUB. 9-12-2006. MULTIPLE CLASS, INT. CLS. 9
AND 16.
- TRI-STATE BANK OF MEMPHIS, MEMPHIS, TN:
1,995,577, REN. 10-25-06. INT. CL. 36.
- TRIBCO, INCORPORATED, CLEVELAND, OH:
1,421,742, REN. 10-23-06. INT. CL. 7.
- TRIDONICATCO GMBH & CO. KG, DORNBIRN, AUSTRIA:
3,176,433, PUB. 9-12-2006. MULTIPLE CLASS, INT. CLS. 9
AND 11.
- TRIFUS N.A. LLC, CHICAGO, IL:
2,805,725, AM. MULTIPLE CLASS, INT. CLS. 41 AND 42.
- TRIGRAM CAPITAL MANAGEMENT LP, GREENWICH,
CT:
3,178,563, INT. CL. 36.
- TRILEGIANT CORPORATION, NORWALK, CT:
2,000,996, REN. 10-25-06. INT. CL. 42.
- TRIMERIS, INC., MORRISVILLE, NC:
3,178,447, INT. CL. 44.
- TRINITY WORKPLACE LEARNING CORPORATION, CAR-
ROLLTON, TX:
2,308,601, CANC. INT. CL. 41.
- TRINOVA DESIGN LLC, APPLETON, WI:
3,176,346, PUB. 9-12-2006. INT. CL. 16.
- TRION, INC., SANFORD, NC:
1,046,283, REN. 10-20-06. INT. CL. 9.
- TRIPLE G CORPORATION, MARKHAM, ONTARIO, CA-
NADA:
2,308,397, CANC. INT. CL. 9.
- TRIPLE H FOOD PROCESSORS, INC., RIVERSIDE, CA:
2,009,883, REN. 10-25-06. INT. CL. 30.
- TRIPLE PLAY FUN ZONE, LLC, SHEBOYGAN, WI:
3,178,121, INT. CL. 41.
- TRIVITA, INC., SCOTTSDALE, AZ:
3,176,187, PUB. 9-12-2006. INT. CL. 35.
- TRIZETTO GROUP, INC., THE, NEWPORT BEACH, CA:
3,175,985, PUB. 9-12-2006. INT. CL. 35.
- TROPICAL BREEZE SMOOTHIES FRANCHISE COMPANY,
BOCA RATON, FL:
3,178,157, INT. CL. 43.
- TROPICAL CHEESE INDUSTRIES, INC., PERTH AMBOY,
NJ:
3,177,324, MULTIPLE CLASS, INT. CLS. 29, 30 AND 32.
- TROPICAL EXPRESSIONS, INC., STERLING, VA:
1,948,824, CANC. INT. CL. 42.
- TROPICANA PRODUCTS, INC., BRADENTON, FL:
3,178,824, INT. CL. 32.
- TROWBRIDGE-KITCHENS, NANCY, BOCA RATON, FL:
3,178,416, INT. CL. 16.

TRU VUE, INC., MCCOOK, IL:
 3,177,950, INT. CL. 17.
 TRUE NORTH CUSTOM PUBLISHING, LLC, CHATTA-
 NOOGA, TN:
 3,176,996, PUB. 9-12-2006. INT. CL. 41.
 TRUE TEMPER SPORTS, INC., MEMPHIS, TN:
 3,177,664, INT. CL. 28.
 TRUFOODS SYSTEMS, INC., LAKE SUCCESS, NY:
 3,177,993, INT. CL. 30.
 TRUITT BROS., INC., SALEM, OR:
 1,378,308, CANC. INT. CL. 29.
 TRUSTEES OF THE UNIVERSITY OF PENNSYLVANIA,
 THE, PHILADELPHIA, PA:
 1,958,183, REN. 10-24-06. INT. CL. 28.
 2,369,074, CANC. INT. CL. 16.
 TRUTH FOR LIFE, CLEVELAND, OH:
 3,176,377, PUB. 9-12-2006. INT. CL. 9.
 TRY NOW, INC., LOS ANGELES, CA:
 3,177,042, PUB. 9-12-2006. INT. CL. 26.
 TSG CONSUMER PARTNERS, LLC, SAN FRANCISCO, CA:
 3,176,389, PUB. 9-12-2006. INT. CL. 36.
 TSI HOLDINGS (IP), LLC, NEW YORK, NY:
 3,176,466, PUB. 9-12-2006. INT. CL. 41.
 TSI INCORPORATED, ST. PAUL, MN:
 2,309,251, CANC. INT. CL. 9.
 TSITSUASHVILI, ZURAB, FOREST HILLS, NY:
 3,178,593, INT. CL. 32.
 TSN LABS, INC., MURRAY, UT:
 3,176,796, PUB. 9-12-2006. INT. CL. 5.
 TSUBURAYA PRODUCTIONS CO., LTD., TOKYO, 157,
 JAPAN:
 3,177,897, INT. CL. 41.
 3,177,898, INT. CL. 41.
 TUBE CITY, LLC, GLASSPORT, PA:
 3,177,518, INT. CL. 9.
 TUCKER-ROCKY CORPORATION, INC., WILMINGTON,
 DE:
 2,309,059, CANC. INT. CL. 25.
 2,309,160, CANC. INT. CL. 25.
 TUCSON MEDICAL CENTER, TUCSON, AZ:
 3,176,256, PUB. 9-12-2006. INT. CL. 44.
 TUMBLEWEED, INC., LOUISVILLE, KY:
 3,177,135, PUB. 9-12-2006. INT. CL. 43.
 TUMTUM TREE FOUNDATION, BIRMINGHAM, AL:
 3,177,089, PUB. 9-12-2006. INT. CL. 36.
 TUNES ACQUISITION CORP., CHICAGO, IL:
 2,309,577, CANC. MULTIPLE CLASS, INT. CLS. 35 AND
 41.
 TURF MERCHANTS, INC., TANGENT, OR:
 3,177,632, INT. CL. 31.
 TURNER WHITE COMMUNICATIONS, INC., WAYNE, PA:
 3,176,315, PUB. 9-12-2006. INT. CL. 16.
 TURNER, SCOTT I., CHILLICOTHE, IL:
 2,010,708, REN. 10-22-06. INT. CL. 9.
 TXU CORP., DALLAS, TX:
 3,177,829, INT. CL. 39.
 TYCO HEALTHCARE GROUP LP, MANSFIELD, MA:
 3,175,997, PUB. 9-12-2006. MULTIPLE CLASS, INT. CLS. 5
 AND 10.
 TYCO HEALTHCARE GROUP LP, NORWALK, CT:
 3,177,969, INT. CL. 10.
 3,178,100, INT. CL. 10.
 TYPE A SNOWBOARDS, INC., SAN DIEGO, CA:
 2,308,501, CANC. INT. CL. 25.
 TYSON FOODS, INC., SPRINGDALE, AR:
 3,178,826, INT. CL. 30.
 U.S. ALUMINUM, INC., BROOKFIELD, WI:
 3,177,722, INT. CL. 6.
 U.S. APPRAISAL, INC., BUFFALO, NY:
 2,310,038, CANC. INT. CL. 36.
 U.S. FIRE ARMS MANUFACTURING CO. INC., HART-
 FORD, CT:
 3,176,929, PUB. 9-12-2006. INT. CL. 13.
 U.S. RETAIL FLOWERS INC, LEBANON, PA, FLOWER
 FRANCHISING, INC., LEBANON, PA:
 1,985,710, REN. 10-24-06. INT. CL. 35.
 UCB, SOCIETE ANONYME, BRUSSELS, BELGIUM:
 2,024,253, REN. 10-25-06. INT. CL. 5.
 UGLYMORTGAGES, INC., DAVIE, FL:
 3,176,725, PUB. 9-12-2006. INT. CL. 36.
 ULTIMA CORPORATION, HARDY, AR:
 2,057,269, REN. 10-26-06. INT. CL. 9.
 ULTIMATE NUT COMPANY, INC., THE, BURBANK, CA,
 DBA THE ULTIMATE NUT AND CANDY COMPANY,
 INC.:
 1,948,238, CANC. INT. CL. 30.
 ULTIMATUM MUSIC, LLC, BEVERLY HILLS, CA:
 2,309,679, CANC. INT. CL. 41.
 ULTRA PURE WATER WORKS, INC., IRON MOUNTAIN,
 MI:
 2,309,328, CANC. INT. CL. 32.
 ULTRAFILTER GMBH, HAAN, BUNDERSREPUBLIC
 DEUTSCHLAND, FED REP GERMANY:
 2,308,213, CANC. MULTIPLE CLASS, INT. CLS. 11, 37
 AND 42.
 ULTRASIELD, LLC, FORT MYERS, FL:
 3,177,335, INT. CL. 12.
 ULTRASOUND DEEJAYS, INC., GAITHERSBURG, MD:
 3,176,220, PUB. 9-12-2006. INT. CL. 41.
 UMG RECORDINGS, INC., SANTA MONICA, CA, FOR-
 MERLY POLYGRAM RECORDS, INC., POLYGRAM RE-
 CORDS, INC., NEW YORK, NY:
 1,984,028, REN. 10-26-06. INT. CL. 9.
 UNCLE JOSH BAIT COMPANY, FORT ATKINSON, WI:
 2,309,383, CANC. INT. CL. 28.
 UNDEFEATED, INC., LOS ANGELES, CA:
 3,178,161, INT. CL. 25.
 UNDER ARMOUR, INC., BALTIMORE, MD:
 3,178,547, INT. CL. 25.
 3,178,548, INT. CL. 25.
 3,178,549, INT. CL. 25.
 UNDER COVER MUSIC GROUP NEW YORK, INC., NEW
 YORK, NY:
 2,308,294, CANC. INT. CL. 9.
 UNDER DAWG APPAREL, INC., CARROLLTON, TX:
 3,176,650, PUB. 9-12-2006. INT. CL. 18.
 UNDERSTANDING UN LTD., CINCINNATI, OH:
 3,176,272, PUB. 9-12-2006. INT. CL. 35.
 UNI-GARD, INC., OAK PARK, MI:
 1,402,985, REN. 10-25-06. INT. CL. 9.
 UNICA INDUSTRIA DE MOVEIS S.A., BAIRRO SAO
 VENDELINO, BRAZIL:
 3,175,777, PUB. 9-12-2006. INT. CL. 20.
 UNICAPITAL CORPORATION, BAY HARBOR ISLAND, FL:
 2,309,876, CANC. INT. CL. 35.
 UNIFORMS TO YOU AND COMPANY, CHICAGO, IL TO
 CINTAS CORPORATION NO. 3, SPARKS, NV:
 1,949,029, CANC. INT. CL. 42.
 1,949,049, CANC. INT. CL. 42.
 UNIGROUP, INC., FENTON, MO:
 3,177,845, MULTIPLE CLASS, INT. CLS. 35, 36 AND 39.
 UNILENS CORP. U.S.A., LARGO, FL:
 3,176,188, PUB. 5-23-2006. INT. CL. 9.
 UNILEVER SUPPLY CHAIN, INC., CLINTON, CT:
 1,378,330, CANC. INT. CL. 30.
 2,309,611, CANC. INT. CL. 8.
 3,178,063, INT. CL. 30.
 UNION PRIVILEGE, INC., WASHINGTON, DC:
 3,178,584, INT. CL. 39.
 UNIQUE WIRELESS DEVELOPMENTS, L.L.C., IRVING, TX:
 2,309,523, CANC. INT. CL. 9.
 UNIQUIFY, INC., SANTA CLARA, CA:
 3,177,120, PUB. 9-12-2006. INT. CL. 42.
 UNISITE, INC., TAMPA, FL:
 2,309,823, CANC. MULTIPLE CLASS, INT. CLS. 36, 37
 AND 42.
 UNISON INDUSTRIES, LLC, JACKSONVILLE, FL, UNISON
 INDUSTRIES, INC., ROCKFORD, IL:
 1,408,227, REN. 10-26-06. INT. CL. 7.
 1,419,053, REN. 10-25-06. INT. CL. 9.
 UNISON INDUSTRIES, LLC, JACKSONVILLE, FL, UNISON
 INDUSTRIES LIMITED PARTNERSHIP, JACKSON-
 VILLE, FL:
 2,008,936, REN. 10-25-06. INT. CL. 7.

- UNISTAR, INC., PHOENIX, AZ, DBA METAGRAPHIX:
2,308,689, CANC. INT. CL. 42.
2,308,690, CANC. INT. CL. 35.
- UNITED AMERICAN INSURANCE COMPANY, MCKINNEY, TX:
2,002,116, REN. 10-20-06. INT. CL. 36.
- UNITED JEWISH COMMUNITIES, INC., NEW YORK, NY:
3,176,727, PUB. 9-12-2006. INT. CL. 35.
- UNITED NATIONS ASSOCIATION OF THE UNITED STATES OF AMERICA, INC., NEW YORK, NY:
3,176,350, PUB. 9-12-2006. INT. CL. 41.
3,178,062, MULTIPLE CLASS, INT. CLS. 35 AND 36.
- UNITED NEGRO COLLEGE FUND, INC., FAIRFAX, VA:
1,979,895, REN. 10-20-06. INT. CL. 36.
- UNITED PARCEL SERVICE OF AMERICA, INC., ATLANTA, GA:
3,177,877, MULTIPLE CLASS, INT. CLS. 9, 35 AND 39.
- UNITED SAN ANTONIO COMMUNITY FEDERAL CREDIT UNION, SAN ANTONIO, TX:
3,178,074, INT. CL. 36.
3,178,075, INT. CL. 36.
- UNITED STATES BAKERY, PORTLAND, OR:
1,874,794, CANC. INT. CL. 30.
- UNITED STATES BOMB DOGS, INC., ETLAN, VA:
3,175,991, PUB. 9-12-2006. INT. CL. 45.
- UNITED STATES FIRE ARMS MANUFACTURING COMPANY, INC., HARTFORD, CT:
3,177,783, INT. CL. 13.
- UNITED STATES GYPSUM COMPANY, CHICAGO, IL,
UNITED STATES GYPSUM COMPANY, CHICAGO, IL:
338,058, REN. 10-20-06. U.S. CL. 12 (INT. CL. 19).
- UNITED STATES LEASING CORPORATION, SAN FRANCISCO, CA:
1,378,363, CANC. MULTIPLE CLASS, INT. CLS. 35 AND 42.
- UNITED STATES POSTAL SERVICE, WASHINGTON, DC:
2,309,546, CANC. MULTIPLE CLASS, INT. CLS. 39 AND 42.
- UNITRIN, INC., CHICAGO, IL:
3,178,199, INT. CL. 36.
- UNITY AG DIRECT, INC., KENTLAND, IN:
3,176,590, PUB. 9-12-2006. INT. CL. 31.
- UNIVERSAL BIOLOGICS, INC., SAN FRANCISCO, CA:
3,176,603, PUB. 9-12-2006. INT. CL. 3.
- UNIVERSAL CITY STUDIOS, INC., UNIVERSAL CITY, CA:
2,309,039, CANC. INT. CL. 41.
- UNIVERSAL DE DESARROLLOS ELECTRONICOS, S.A. (UNIDESA), 08226 TERRASSA (BARCELONA), SPAIN:
2,308,512, CANC. INT. CL. 9.
- UNIVERSAL INTERACTIVE, INC., LOS ANGELES, CA:
3,177,771, INT. CL. 9.
- UNIVERSAL SEWING SUPPLY, INC., ST. LOUIS, MO:
3,177,621, INT. CL. 7.
- UNIVERSAL SYSTEMS OF AMERICA, INC., LOUISVILLE, KY:
1,378,686, CANC. INT. CL. 42.
- UNIVERSAL TRAILER CORPORATION HORSE/LIVESTOCK GROUP, GREENWICH, CT:
2,003,036, REN. 10-24-06. INT. CL. 12.
- UNIVERSITY HOSPITALS HEALTH SYSTEM, INC., CLEVELAND, OH:
3,175,790, PUB. 9-12-2006. INT. CL. 44.
- UNIVERSITY OF NOTRE DAME DU LAC, NOTRE DAME, IN:
2,308,568, CANC. MULTIPLE CLASS, INT. CLS. 25 AND 41.
- UNIVERSITY PRODUCTS, INC., HOLYOKE, MA:
3,176,384, PUB. 9-12-2006. INT. CL. 16.
- UNIVERSITY RESTAURANT GROUP, INC., COSTA MESA, CA:
3,176,522, PUB. 9-12-2006. INT. CL. 43.
- UNIWORLD RIVER CRUISES, INC., ENCINO, CA:
3,178,724, INT. CL. 39.
- UNLIMITED DEVELOPMENT, INC., GALESBURG, IL:
3,176,754, PUB. 9-12-2006. INT. CL. 44.
- UP WITH PAPER, LLC, MASON, OH:
3,177,575, INT. CL. 16.
- UPM RAFLATAC OY, FINLAND:
3,177,319, PUB. 9-12-2006. MULTIPLE CLASS, INT. CLS. 9 AND 16.
- UPN, HOLLYWOOD, CA:
3,176,300, PUB. 9-12-2006. INT. CL. 38.
- UPSHER-SMITH LABORATORIES, INC., MAPLE GROVE, MN:
3,178,335, INT. CL. 5.
- UPSTAR FINANCIAL, LLC., NORCROSS, GA:
3,178,544, INT. CL. 36.
- UR TECHNOLOGIES, INC., EAST SYRACUSE, NY:
3,178,333, MULTIPLE CLASS, INT. CLS. 9 AND 37.
- URBAN SUN, INC., SAN DIEGO, CA:
3,177,373, INT. CL. 24.
- URBAN, MARTA T., GREENSBURG, PA:
2,309,543, CANC. INT. CL. 16.
- URBANI TARTUFI S.N.C. DI P. E. B. URBANI, ITALY:
3,177,276, PUB. 9-12-2006. MULTIPLE CLASS, INT. CLS. 29, 30 AND 31.
- URC ENTERPRISES, LLC, EVANSTON, IL:
2,308,660, CANC. INT. CL. 19.
- US WEEKLY LLC, NEW YORK, NY:
3,176,865, PUB. 9-12-2006. INT. CL. 16.
- USA HOCKEY, INC., COLORADO SPRINGS, CO:
3,176,175, PUB. 9-12-2006. INT. CL. 25.
- USA RICE FEDERATION, ARLINGTON, VA:
2,305,706, AM. INT. CL. 42.
- USA UNIVERSITY, INC., MONTPELIER, VT:
2,310,068, CANC. INT. CL. 35.
- USA WEB SOLUTIONS, INC., WOODSIDE, NY:
3,176,252, PUB. 9-12-2006. INT. CL. 42.
- USA WIRELESS TECHNOLOGIES INC., PACOIMA, CA:
2,309,212, CANC. INT. CL. 9.
- USFILTER CORPORATION, WARRENDALE, PA:
3,178,245, INT. CL. 7.
- USG INTERIORS, INC., CHICAGO, IL, CONWED CORPORATION, SAINT PAUL, MN:
1,049,575, REN. 10-26-06. INT. CL. 19.
- USTAV FYZIKY PLAZMATU, 182 00 PRAHA 8, CZECH REPUBLIC:
2,308,237, CANC. MULTIPLE CLASS, INT. CLS. 2, 9, 17 AND 40.
- USX FEDERAL CREDIT UNION, CRANBERRY TOWNSHIP, PA:
3,176,414, PUB. 9-12-2006. MULTIPLE CLASS, INT. CLS. 35, 36 AND 42.
- V & V SUPREMO FOODS, INC., CHICAGO, IL, V & V FOOD PRODUCTS, INC., CHICAGO, IL:
2,066,886, REN. 10-24-06. INT. CL. 29.
- V & V SUPREMO FOODS, INC., CHICAGO, IL:
2,072,917, REN. 10-24-06. INT. CL. 29.
- V FINE HOMES LP, FORT WORTH, TX:
3,176,636, PUB. 9-12-2006. INT. CL. 37.
- V&S PLYMOUTH LIMITED, PLYMOUTH, DEVON, UNITED KINGDOM:
2,308,273, CANC. INT. CL. 33.
- VACATION RENTER SOLUTIONS, LLC, SAN RAMON, CA:
3,176,774, PUB. 9-12-2006. INT. CL. 43.
- VAIL TRADEMARKS, INC., VAIL, CO:
2,308,636, CANC. INT. CL. 16.
- VALEANT PHARMACEUTICALS INTERNATIONAL, COSTA MESA, CA:
3,177,756, INT. CL. 5.
- VALERIO, BENNY A., TOMBALL, TX:
3,177,680, INT. CL. 41.
- VALLEY RESEARCH, INC., SOUTH BEND, IN:
3,176,717, PUB. 9-12-2006. INT. CL. 1.
- VALLEY SCREEN PRINTING, INC., NORTH HOLLYWOOD, CA:
3,178,351, INT. CL. 16.
- VALPAK DIRECT MARKETING SYSTEMS, INC., LARGO, FL:
2,309,252, CANC. INT. CL. 35.
- VALROHONA S.A., TAIN L'HERMITAGE, FRANCE, ETABLISSEMENTS DE LOISY ET GELET S.A., 26600 TAIN L'HERMITAGE, FRANCE:
2,082,682, REN. 10-26-06. INT. CL. 30.

VAN LOON, MATTHEW, D, CEDAR KNOLLS, NJ:
3,177,872, INT. CL. 41.

VANCE PUBLISHING CORPORATION, LINCOLNSHIRE, IL:
3,178,479, MULTIPLE CLASS, INT. CLS. 16 AND 44.

VANDENBERG, INC., NEW YORK, NY:
3,175,857, PUB. 9-12-2006. INT. CL. 36.

VANGUARD GROUP, INC., THE, MALVERN, PA:
1,997,410, REN. 10-20-06. INT. CL. 36.
2,308,823, CANC. INT. CL. 16.

VANS PINE NURSERY, INC., WEST OLIVE, MI, VANS PINES, INC., WEST OLIVE, MI:
1,993,183, REN. 10-23-06. INT. CL. 31.

VANS PINES NURSERY, INC., WEST OLIVE, MI, VANS PINES, INC., WEST OLIVE, MI:
1,993,182, REN. 10-23-06. INT. CL. 31.

VAPORGENIE, LLC, ASHEVILLE, NC:
3,176,569, PUB. 9-12-2006. INT. CL. 34.

VAPPIE, JORDAN P., LOS ANGELES, CA:
3,177,966, INT. CL. 41.

VARAT ENTERPRISES, INC., GREENVILLE, SC:
1,378,223, CANC. INT. CL. 25.

VAS-CATH INCORPORATE, MISSISSAUGA, ONTARIO, CANADA:
1,406,623, REN. 10-21-06. INT. CL. 10.

VAS-CATH INCORPORATED, MISSISSAUGA, ONTARIO, CANADA, VAS-CATH OF CANADA LIMITED, MISSISSAUGA, ONTARIO, CANADA:
1,405,677, REN. 10-26-06. INT. CL. 10.

VASCUTEK LIMITED, AYR, SCOTLAND:
1,414,862, REN. 10-26-06. INT. CL. 10.

VASQUEZ, MIKE R., CORONA, CA:
2,308,246, CANC. INT. CL. 42.

VDF FUTURECEUTICALS, INC., MOMENCE, IL:
3,177,930, INT. CL. 5.
3,177,931, INT. CL. 29.
3,178,483, INT. CL. 29.

VEDALIFE, INC., LANCASTER, NY:
3,177,451, INT. CL. 5.

VEGA MARKETING LTD., LONDON W1R 7FB, UNITED KINGDOM TO ETICOR HOLDING S.A., LUGANO, SWITZERLAND:
1,949,287, CANC. INT. CL. 10.

VEGAS GAMES, INC., LAS VEGAS, NV:
3,176,850, PUB. 9-12-2006. INT. CL. 28.

VELOCITY MAGNETICS, INC., NEW CASTLE, PA:
3,178,109, INT. CL. 12.

VENDA LIMITED, LONDON, UNITED KINGDOM:
3,175,950, PUB. 9-12-2006. MULTIPLE CLASS, INT. CLS. 9, 35, 36, 38 AND 42.

VENISON WORLD, INC., THE, EDEN, TX:
1,949,396, CANC. MULTIPLE CLASS, INT. CLS. 18, 20, 25 AND 29.

VENISSIMO CHEESE, INC., SAN DIEGO, CA:
3,176,939, PUB. 9-12-2006. INT. CL. 35.

VENTROL AIR HANDLING SYSTEMS, INC., ANJOU, QUEBEC, CANADA:
3,176,977, PUB. 9-12-2006. INT. CL. 9.
3,176,978, PUB. 9-12-2006. INT. CL. 11.

VENTURA FOODS, LLC, BREA, CA, GLIDDEN COMPANY, THE, CLEVELAND 14, OH, DBA DURKEE FAMOUS FOODS:
622,415, REN. 10-25-06. U.S. CL. 46 (INT. CL. 29).

VENTURA FOODS, LLC, BREA, CA, GLIDDEN COMPANY, THE, CLEVELAND 14, OH:
622,416, REN. 10-26-06. U.S. CL. 46 (INT. CL. 29).

VENTURE ARCHITECTS, LLC, NEW YORK, NY:
3,177,461, INT. CL. 41.

VERAXSYS, INC., LYNCHBURG, VA:
3,178,714, MULTIPLE CLASS, INT. CLS. 9 AND 42.

VERBAND HANNOVERSCHER WARMBLUTZUCHTER E.V., VERDEN D-27283, FED REP GERMANY:
3,175,789, PUB. 9-12-2006. MULTIPLE CLASS, INT. CLS. 16, 35, 41, 42 AND 44.

VERIDICOM, INC., SANTA CLARA, CA:
2,309,895, CANC. INT. CL. 9.

VERIFONE, INC., SAN JOSE, CA:
1,997,215, REN. 10-20-06. INT. CL. 9.

VERISTEEL, INC., NORTH LAS VEGAS, NV:
3,178,192, INT. CL. 6.

VERITY, JULIE L., WAPPINGERS FALLS, NY:
2,308,763, CANC. INT. CL. 16.

VERMEHREN ENGINEERING CORP., PENSACOLA, FL:
1,972,939, REN. 10-24-06. INT. CL. 7.

VERMONT BIKE AND SKI DISTRIBUTION INC., BURLINGTON, VT:
2,309,809, CANC. INT. CL. 35.

VERTAFORE, INC., WINDSOR, CT, FORMERLY AMS SERVICES, INC.:
3,177,811, INT. CL. 42.

VERTASOURCE, LLC, BUFFALO, NY:
3,177,540, INT. CL. 35.

VERTEX PHARMACEUTICALS INCORPORATED, CAMBRIDGE, MA TO ALTUS PHARMACEUTICALS INC., CAMBRIDGE, MA:
1,951,643, CANC. MULTIPLE CLASS, INT. CLS. 1 AND 32.

VIACOM INTERNATIONAL INC., NEW YORK, NY:
3,176,751, PUB. 9-12-2006. INT. CL. 35.
3,176,753, PUB. 9-12-2006. INT. CL. 41.

VIASYS HOLDINGS INC., CONSHOHOCKEN, PA:
1,901,653, REN. 10-26-06. INT. CL. 10.

VICKERS, BILLY, L, PHOENIX, AZ:
3,178,568, INT. CL. 35.

VICRI - SOCIEDADE TÊXTIL, LDA., PORTUGAL:
3,177,304, PUB. 9-12-2006. MULTIPLE CLASS, INT. CLS. 18, 24 AND 25.

VICTOR EQUIPMENT COMPANY, ST. LOUIS, MO:
1,396,488, REN. 10-25-06. INT. CL. 8.

VICTORIA CLASSICS LTD., NEW YORK, NY:
3,177,328, INT. CL. 24.

VICTORIA'S SECRET DIRECT, LLC, COLUMBUS, OH:
3,176,153, PUB. 1-17-2006. INT. CL. 25.

VICTORIAN SWEET SHOPPE, INC., RIVERSIDE, CA:
3,177,001, PUB. 9-12-2006. INT. CL. 30.
3,177,002, PUB. 9-12-2006. INT. CL. 30.

VIDAL, FRANCE:
3,177,215, PUB. 9-12-2006. MULTIPLE CLASS, INT. CLS. 9, 16, 35, 38, 40, 41, 42 AND 44.

VIDENT, BREA, CA:
3,177,554, INT. CL. 10.

VIDEO GAMING TECHNOLOGIES, INC., ROEBUCK, TN:
3,176,056, PUB. 9-12-2006. INT. CL. 9.

VIDMAR, PETER, COLO DE CAZA, CA:
2,308,256, CANC. INT. CL. 41.

VIERA COMPANY, THE, VIERA, FL:
1,994,447, REN. 10-26-06. MULTIPLE CLASS, INT. CLS. 36, 37 AND 42.
1,994,448, REN. 10-26-06. MULTIPLE CLASS, INT. CLS. 36, 37 AND 42.

VILLA PARK ORCHARDS ASSOCIATION, THE, FILLMORE, CA:
343,168, REN. 10-24-06. U.S. CL. 46 (INT. CL. 31).

VILLAGE VOICE MEDIA HOLDINGS, LLC, PHOENIX, AZ:
3,176,378, PUB. 9-12-2006. INT. CL. 41.
3,176,467, PUB. 9-12-2006. INT. CL. 41.

VINA MANQUEHUE S.A., SANTIAGO, CHILE:
2,309,929, CANC. INT. CL. 33.

VINCI ENTERPRISE CORP., NEW YORK, NY:
3,176,332, PUB. 9-12-2006. INT. CL. 25.

VINTAGE WINE TRUST INC., SAN RAFAEL, CA:
3,178,580, INT. CL. 36.

VINYL VISIONS LLC, WILMINGTON, OH:
3,178,604, INT. CL. 19.

VIPS, INC., BALTIMORE, MD:
3,177,840, MULTIPLE CLASS, INT. CLS. 9 AND 42.

VIRBAC S.A., FRANCE:
3,177,292, PUB. 9-12-2006. MULTIPLE CLASS, INT. CLS. 9, 10, 18 AND 45.

VIRCO MFG. CORPORATION, TORRANCE, CA:
2,309,622, CANC. INT. CL. 20.

VIRGINIA BREAST CENTER, INC., MIDLOTHIAN, VA:
3,176,878, PUB. 9-12-2006. INT. CL. 44.

VIRO-MED LABORATORIES, INC., MINNEAPOLIS, MN:
1,966,343, REN. 10-26-06. INT. CL. 42.

- VIRTRAN, INC., IRVINE, CA:
2,384,570, CANC. INT. CL. 42.
- VIRTUAL WORLD ENTERTAINMENT, INC., LOS ANGELES, CA TO VIRTUAL WORLD ENTERTAINMENT, LLC, CHICAGO, IL:
1,949,726, CANC. INT. CL. 25.
- VIRTUS NUTRITION, LLC, FAIRLAWN, OH:
3,176,170, PUB. 9-12-2006. INT. CL. 5.
- VIRUTEX ILKO S.A., SANTIAGO, CHILE:
3,176,115, PUB. 7-4-2006. MULTIPLE CLASS, INT. CLS. 8 AND 21.
- VISCONTI PIO S.P.A., VALENZA (PROVINCE OF ALESSANDRIA), ITALY:
1,378,100, CANC. MULTIPLE CLASS, INT. CLS. 18 AND 25.
- VISCOUNT RESEARCH AND MANUFACTURING LTD., BURNABY, BRITISH COLUMBIA, CANADA:
3,175,787, PUB. 1-17-2006. INT. CL. 17.
- VISION METALS, INC., ANN ARBOR, MI:
2,309,934, CANC. MULTIPLE CLASS, INT. CLS. 6 AND 40.
- VISTAWEB.COM, MONMOUTH BEACH, NJ:
1,982,172, REN. 10-23-06. INT. CL. 42.
- VISTO CORPORATION, REDWOOD CITY, CA:
2,309,656, CANC. INT. CL. 42.
- VISUAL DATA CORPORATION,, POMPAN0 BEACH, FL:
2,308,454, CANC. INT. CL. 9.
- VISUAL SCIENCES, LLC, MCLEAN, VA:
3,121,580, COR. INT. CL. 9.
- VISUAL SERVICES, INC., BLOOMFIELD HILLS, MI:
2,309,549, CANC. MULTIPLE CLASS, INT. CLS. 9 AND 40.
- VITA LICENSING, INC., WILMINGTON, DE:
3,177,457, MULTIPLE CLASS, INT. CLS. 5 AND 10.
- VITA ZAHNFABRIK H. RAUTER GMBH & CO. KG, D-79713 BAD SACKINGEN, FED REP GERMANY:
1,948,263, CANC. MULTIPLE CLASS, INT. CLS. 5 AND 10.
- VITAL PHARMACEUTICALS, INC., DAVIE, FL:
3,178,028, INT. CL. 5.
- VITAL SIGNS, INC., TOTOWA, NJ:
2,310,091, CANC. INT. CL. 10.
- VITALFLOR, INC., SATELLITE BEACH, FL:
3,177,376, INT. CL. 10.
- VITALICIOUS INC., NEW YORKE, NY:
3,178,733, INT. CL. 30.
- VITAMARK INTERNATIONAL, INC., HOUSTON, TX:
3,177,847, INT. CL. 5.
- VITTS NETWORKS, INC., MANCHESTER, NH:
2,309,294, CANC. MULTIPLE CLASS, INT. CLS. 35, 38 AND 42.
- VIVID GROUP, THE, TORONTO, ONTARIO, CANADA:
2,308,615, CANC. INT. CL. 9.
- VIVIDEA, INC., MODESTO, CA:
3,176,918, PUB. 9-12-2006. INT. CL. 9.
3,176,920, PUB. 9-12-2006. INT. CL. 9.
3,177,130, PUB. 9-12-2006. INT. CL. 9.
- VODAVI COMMUNICATIONS SYSTEMS, INC., PHOENIX, AZ:
2,014,951, REN. 10-25-06. INT. CL. 9.
- VOICEWALK, INC., BEVERLY HILLS, CA:
3,175,881, PUB. 9-12-2006. INT. CL. 42.
- VOIP CORP, ORLANDO, FL:
3,176,019, PUB. 9-12-2006. INT. CL. 38.
- VOLICH, GREG, BRANSON, MO:
3,176,995, PUB. 9-12-2006. INT. CL. 25.
- VOLUNMETRICS MEDICAL IMAGING, INC., DURHAM, NC:
2,309,832, CANC. INT. CL. 10.
- VOONER FLOGARD CORPORATION, CHARLOTTE, NC:
3,177,997, INT. CL. 7.
- VOONER VACUUM PUMPS, INC.:
1,377,898, CANC. INT. CL. 7.
- VOTIVO, LTD., SEATTLE, WA:
2,846,978, COR. INT. CL. 3.
- VOYAGE TELECOM, INC., HAWTHORNE, NJ:
2,309,916, CANC. INT. CL. 16.
- VSS HOLDING, INC., SALT LAKE CITY, UT:
3,177,612, INT. CL. 35.
- VTECH COMMUNICATIONS, INC., BEAVERTON, OR:
2,309,568, CANC. INT. CL. 9.
- VTECH ELECTRONICS NORTH AMERICA, LLC, ARLINGTON HEIGHTS, IL:
3,177,778, INT. CL. 9.
- V4 HOLDINGS, LLC, ANN ARBOR, MI:
3,176,281, PUB. 9-12-2006. INT. CL. 25.
- W & T SEAFOOD CORP., BROOKLYN, NY:
3,176,411, PUB. 9-12-2006. INT. CL. 29.
- W. L. GORE & ASSOCIATES, INC., NEWARK, DE:
1,949,653, CANC. INT. CL. 25.
- W. P. TAX & ACCOUNTING SERVICES, OWING MILLS, MD AND WEBPAGE INCORPORATED, OWINGS MILLS, MD:
3,178,812, INT. CL. 35.
- W. R. GRACE & CO.-CONN., NEW YORK, NY TO GE BETZ, INC., TREVOSE, PA:
2,027,796, CANC. INT. CL. 1.
- W.C. BRADLEY/ZEBCO HOLDINGS, INC., TULSA, OK:
1,378,274, CANC. INT. CL. 28.
- W.C. BRANHAM, INC., RIVER FALLS, WI:
1,996,522, REN. 10-26-06. INT. CL. 7.
- W.Y. INTERNATIONAL INC., ALHAMBRA, CA:
1,932,465, CANC. INT. CL. 20.
- WACHOVIA CORPORATION, WINSTON-SALEM, NC:
1,948,234, CANC. INT. CL. 36.
- WACHTER MANAGEMENT COMPANY, LENEXA, KS:
3,176,930, PUB. 9-12-2006. INT. CL. 37.
- WAG-N-WASH, INC., COLORADO SPRINGS, CO:
3,176,022, PUB. 9-12-2006. MULTIPLE CLASS, INT. CLS. 35 AND 44.
- WAGREICH, JERRY, OSSINING, NY:
3,178,805, INT. CL. 41.
- WAHL CLIPPER CORPORATION, STERLING, IL:
2,309,037, CANC. INT. CL. 8.
- WAINWRIGHT INDUSTRIES, INC., ST. PETERS, MO:
2,309,202, CANC. MULTIPLE CLASS, INT. CLS. 9, 16 AND 41.
- WAKEFERN FOOD CORP., ELIZABETH, NJ:
2,078,705, REN. 10-25-06. INT. CL. 30.
- WAL-MART STORES, INC., BENTONVILLE, AR:
2,308,838, CANC. INT. CL. 9.
- WALBRO INC., AURORA, CO:
3,178,748, INT. CL. 12.
- WALCO INTERNATIONAL, INC., WESTLAKE, TX:
3,176,970, PUB. 9-12-2006. INT. CL. 5.
- WALDEMAR LINK GMBH & CO. KG, FED REP GERMANY:
3,177,210, PUB. 9-12-2006. INT. CL. 10.
- WALDREP, DONALD J., ROSEVILLE, CA:
3,177,868, INT. CL. 44.
- WALK THRU THE BIBLE MINISTRIES, INC., ATLANTA, GA, WILKINSON, BRUCE H., PORTLAND, OR, DBA WALK THRU THE BIBLE ASSOCIATES:
1,046,135, REN. 10-25-06. INT. CL. 41.
- WALK THRU THE BIBLE MINISTRIES, INC., ATLANTA, GA:
3,176,246, PUB. 9-12-2006. INT. CL. 16.
- WALL COLMONOY CORPORATION, DETROIT, MI:
1,378,022, CANC. INT. CL. 12.
- WALLEN, JEFF, ANTHEM, AZ AND WALLEN, JENNIFER, ANTHEM, AZ:
3,176,486, PUB. 9-12-2006. INT. CL. 36.
- WALSH, PHYLLIS J., SPRINGTOWN, PA:
1,949,469, CANC. INT. CL. 25.
- WANCHESE FISH CO, INC., HAMPTON:
1,371,543, REN. 10-26-06. INT. CL. 29.
- WARD, CHANEL EDWARDS, BATON ROUGE, LA:
3,177,777, INT. CL. 25.
- WARNACO U.S., INC., MILFORD, CT:
3,177,882, INT. CL. 25.
3,178,468, INT. CL. 25.
- WARNER BROS. ENTERTAINMENT INC., BURBANK, CA:
3,176,392, PUB. 9-12-2006. INT. CL. 9.
3,177,731, INT. CL. 25.

WARNER-LAMBERT COMPANY, PARSIPPANY, NJ:
1,949,571, CANC. INT. CL. 5.

WARREN, CAROLYN T., CHICAGO, IL:
3,177,345, INT. CL. 26.

WASEL, JOEL, VANCOUVER, BRITISH COLUMBIA, CANADA AND FONTAINE, BRUCE, VANCOUVER, BRITISH COLUMBIA, CANADA:
3,176,062, PUB. 1-31-2006. MULTIPLE CLASS, INT. CLS. 9, 25 AND 41.

WASHINGTON GAS LIGHT COMPANY, WASHINGTON, DC:
2,308,914, CANC. INT. CL. 36.

WASHINGTON MUTUAL, INC., SEATTLE, WA:
3,177,596, INT. CL. 16.

WASHINGTON STATE UNIVERSITY, PULLMAN, WA:
2,309,621, CANC. INT. CL. 36.

WASILEWSKI, DAVID, ATLANTA, GA:
3,178,520, INT. CL. 25.

WASSER, CHARLES HARLAN, DENVER, NJ:
2,308,576, CANC. INT. CL. 42.

WASTECORP INTERNATIONAL INVESTMENT INC., TORONTO, ONTARIO M8Z 2X3, CANADA:
1,947,943, CANC. INT. CL. 1.

WATCHGUARD TECHNOLOGIES, INC., SEATTLE, WA, PYROTEC N.V., CURACAO, NETHERLAND ANTILLES:
1,404,502, REN. 10-23-06. INT. CL. 9.

WATER MAGIC, INC., WESTPORT, CT:
1,995,768, REN. 10-24-06. INT. CL. 3.

WATER SOUNDS, BURLINGAME, CA:
2,310,010, CANC. INT. CL. 11.

WATERS INVESTMENTS LIMITED, NEW CASTLE, DE:
3,178,445, INT. CL. 9.

WATKINS MANUFACTURING CORPORATION, VISTA, CA:
3,177,353, INT. CL. 11.

WAUGH, WENDY ANN, NEW YORK, NY:
3,177,642, MULTIPLE CLASS, INT. CLS. 16, 35 AND 42.

WAVELIGHT LASER TECHNOLOGIE AG, FED REP GERMANY:
3,177,318, PUB. 9-12-2006. MULTIPLE CLASS, INT. CLS. 9, 10, 37 AND 41.

WAWONA FROZEN FOODS, CLOVIS, CA:
3,177,881, INT. CL. 29.

WAXMAN CONSUMER PRODUCTS GROUP INC., BEDFORD HEIGHTS, OH:
3,178,412, INT. CL. 20.

WEBFS, INC., SUNNYVALE, CA:
2,569,269, CANC. INT. CL. 39.
2,587,343, CANC. INT. CL. 39.

WEBRAISER TECHNOLOGIES, INC., SACRAMENTO, CA:
3,178,434, INT. CL. 9.

WEBSTAR MARKETING GROUP, INC., LOS ANGELES, CA:
3,176,409, PUB. 9-12-2006. INT. CL. 41.

WEE ONES, INC., ST. LOUIS, MO:
1,405,027, REN. 10-20-06. MULTIPLE CLASS, INT. CLS. 25 AND 26.

WEEKLY READER CORPORATION, STAMFORD, CT:
2,310,082, CANC. INT. CL. 16.

WEICHERT CO., MORRIS PLAINS, NJ:
3,178,620, MULTIPLE CLASS, INT. CLS. 35, 39 AND 43.

WEIHING, EWALD, KUSTERDINGEN, FED REP GERMANY AND WEIHING, JORG, TUBINGEN, FED REP GERMANY AND WEIHING, ROBERT, TUBINGEN, FED REP GERMANY:
3,177,622, INT. CL. 9.

WEIMAN PRODUCTS, LLC, GURNEE, IL:
3,177,434, MULTIPLE CLASS, INT. CLS. 3 AND 21.

WEINER, CELIA ROSE, NORTH HOLLYWOOD, CA:
3,176,225, PUB. 9-12-2006. INT. CL. 28.

WEISSMAN'S THEATRICAL SUPPLIES, INC., ST. LOUIS, MO:
3,177,992, INT. CL. 25.

WEISZ, STEPHEN B., SAN RAFAEL, CA:
3,176,829, PUB. 9-12-2006. MULTIPLE CLASS, INT. CLS. 35 AND 41.

WEITENG, DAI, FUJIAN PROVINCE, CHINA:
3,178,775, INT. CL. 25.

WELCH, LISA M., HILTON HEAD ISLAND, SC:
2,308,922, CANC. INT. CL. 35.

WELLNESS, INC., BROOKLINE, MA:
3,177,922, INT. CL. 16.

WELLPOINT HEALTH NETWORKS, INC., WOODLAND HILLS, CA, DBA WELLPOINT PHARMACY PLAN:
2,002,076, REN. 10-20-06. INT. CL. 35.

WELLS FARGO & COMPANY, SAN FRANCISCO, CA:
2,308,360, CANC. INT. CL. 35.
2,309,727, CANC. INT. CL. 36.

WELLS FARGO & COMPANY, MINNEAPOLIS, MN:
3,177,924, INT. CL. 36.

WELLS LAMONT CORPORATION, NILES, IL, MARMON GROUP, INC., THE, CHICAGO, IL:
1,405,025, REN. 10-26-06. INT. CL. 25.

WELLS' DAIRY, INC., LE MARS, IA:
3,176,005, PUB. 9-12-2006. INT. CL. 30.

WELOGA HOLDINGS INC., MONTREAL PROVINCE OF QUEBEC, CANADA:
2,310,035, CANC. INT. CL. 37.

WEMER, JOHN D., DESTIN, FL:
3,176,173, PUB. 4-11-2006. INT. CL. 41.

WERK THOROUGHbred CONSULTANTS, INC., FREMONT, CA:
1,948,117, CANC. INT. CL. 42.

WEST MICHIGAN BASEBALL LIMITED PARTNERSHIP, COMSTOCK PARK, MI:
1,948,280, CANC. INT. CL. 41.

WEST PUBLISHING CORPORATION, EAGAN, MN:
3,176,290, PUB. 9-12-2006. INT. CL. 42.

WEST, SCOTT MHK, ELK GROVE, CA:
2,308,607, CANC. INT. CL. 35.

WESTED, SAN FRANCISCO, CA:
3,177,359, MULTIPLE CLASS, INT. CLS. 9 AND 38.

WESTELL, INC., AURORA, IL, TELTREND INCORPORATED, ST. CHARLES, IL:
1,991,591, REN. 10-23-06. INT. CL. 9.

WESTERN PLAINS DEVELOPMENT CORP., PHOENIX, AZ:
2,331,982, CANC. INT. CL. 37.

WESTFALIASURGE, INC., NAPERVILLE, IL:
3,178,153, INT. CL. 5.

WESTFIELD, ELISA M., SOUTH ORANGE, NJ:
3,175,963, PUB. 9-12-2006. INT. CL. 41.

WESTON CONSUMER PRODUCTS, INC., WESTON, FL:
3,177,137, PUB. 9-12-2006. INT. CL. 20.

WESTPORT COMMUNICATIONS LP, BEVERLY, MA:
3,177,727, INT. CL. 38.

WHALEY FOODSERVICE REPAIRS, LEXINGTON, SC:
3,178,418, INT. CL. 37.

WHEAT, JARED R., NORCROSS, GA:
3,178,611, INT. CL. 5.

WHITE BREAD PRODUCTIONS, INC., BEVERLY HILLS, CA:
2,308,732, CANC. INT. CL. 41.

WHITE CLOUD MOUNTAIN COMPANY, INC., BOISE, ID:
2,309,388, CANC. INT. CL. 32.

WHITE RABBIT GROUP, LLC, WEST DES MOINES, IA:
3,177,113, PUB. 9-12-2006. INT. CL. 35.

WHITING, JENNIFER M., FLORENCE, MA:
3,178,585, INT. CL. 35.

WHITNEY, EVERETT, I / IPO, BUENA PARK, CA:
3,176,004, PUB. 9-12-2006. INT. CL. 28.

WHITSON, ANTHONY, SANTA ROSA, CA AND TYSON, RAYMOND, SANTA ROSA, CA:
2,308,769, CANC. INT. CL. 9.

WHOLE FOODS MARKET SERVICES, INC., AUSTIN, TX:
2,308,642, CANC. INT. CL. 5.

WHOLE OATS ENTERPRISES, SADDLE RIVER, NJ:
3,176,157, PUB. 9-12-2006. INT. CL. 9.

WIEGAND, MICHELLE M., EDMOND, OK, MASTENA, MICHELLE, EDMOND, OK, DBA MICHELLE'S DESIGNS:
1,354,241, REN. 10-25-06. INT. CL. 25.

WILBERT, INC., BROADVIEW, IL:
1,378,097, CANC. INT. CL. 17.

WILBUR-ELLIS COMPANY, SAN FRANCISCO, CA:
1,992,276, REN. 10-26-06. INT. CL. 5.

WILD ARTIST MUSIC, INC., NEW YORK, NY:
2,308,340, CANC. INT. CL. 9.

- WILD BILL'S FOODS, INC., LANCASTER, PA:
3,177,093, PUB. 9-12-2006. INT. CL. 29.
- WILDEN PUMP AND ENGINEERING LLC, GRAND TERRACE, CA:
3,177,989, INT. CL. 7.
- WILFER, HANS-PETER, D-08258 MARKNEUKIRCHEN, FED REP GERMANY:
3,175,759, PUB. 9-12-2006. MULTIPLE CLASS, INT. CLS. 9 AND 15.
- WILKEN, DONNA, HIGHLAND, IL:
3,176,151, PUB. 9-12-2006. INT. CL. 41.
- WILKINSON COMPANY, INC., STOW, OH:
2,308,681, CANC. INT. CL. 7.
- WILLIAM BEAUMONT HOSPITAL, ROYAL OAK, MI:
1,392,704, REN. 10-26-06. INT. CL. 42.
- WILLIAM GRANT & SONS, INC., EDISON, NJ TO DISTILLERDERIJEN ERVEN LUCAS BOLS B.V., 2723 RB ZOETERMEER, NETHERLANDS:
1,949,355, CANC. INT. CL. 33.
- WILLIAM LEVENE LIMITED, MIDDLESEX HA2 7JP, ENGLAND:
2,308,266, CANC. INT. CL. 8.
- WILLIAM RAVEIS REAL ESTATE, INC., SHELTON, CT:
2,308,702, CANC. INT. CL. 36.
2,308,705, CANC. INT. CL. 36.
- WILLIAM W. MEYER & SONS, INC., SKOKIE, IL:
3,176,940, PUB. 9-12-2006. INT. CL. 7.
- WILLIAMS ADVANCED MATERIALS, INC., BUFFALO, NY:
2,308,484, CANC. INT. CL. 6.
- WILLIAMS, DAN, C., MARATHON, FL:
3,177,805, INT. CL. 12.
- WILLIAMS, TIMOTHY L., TOLEDO, OH, DBA BIG APPLE DELI:
2,037,281, REN. 10-26-06. INT. CL. 42.
- WILLIAN BRINKS HOFER GILSON & LIONE, CHICAGO, IL:
1,949,013, CANC. INT. CL. 42.
- WILLVER SEVILLEY, LLC, NEW YORK, NY:
3,178,765, INT. CL. 25.
- WILTON INDUSTRIES, INC., WOODRIDGE, IL:
3,177,746, INT. CL. 11.
- WINCO FOODS, LLC, BOISE, ID:
1,058,789, REN. 10-25-06. INT. CL. 42.
- WING ON INTERNATIONAL HOLDINGS LIMITED, HAMILTON HM12, BERMUDA:
2,308,128, CANC. INT. CL. 36.
- WINGS ETC., INC., FT. WAYNE, IN:
3,176,501, PUB. 9-12-2006. INT. CL. 43.
- WINK INDUSTRIES LTD./LES INDUSTRIES WINK LTEE, ST. LEONARD, QUEBEC H1P 2X5, CANADA:
2,308,151, CANC. MULTIPLE CLASS, INT. CLS. 20 AND 24.
- WINMARK CORPORATION, MINNEAPOLIS, MN:
3,176,822, PUB. 9-12-2006. INT. CL. 35.
- WIPFLI, MARTIN, 8835 FEUSISBERG, SWITZERLAND:
2,308,262, CANC. MULTIPLE CLASS, INT. CLS. 35 AND 36.
- WIQUEST COMMUNICATIONS, INC., ALLEN, TX:
3,176,283, PUB. 9-12-2006. INT. CL. 9.
- WISCONSIN ALUMNI RESEARCH FOUNDATION, MADISON, WI:
2,308,357, CANC. INT. CL. 9.
- WISS., INC., PORTLAND, OR:
3,176,914, PUB. 9-12-2006. INT. CL. 25.
- WIT & CO., LTD., DECATUR, IL:
3,176,693, PUB. 9-12-2006. INT. CL. 35.
- WITTEMAN HOLDING B.V., 2180AA HILLEGOM, NETHERLANDS:
3,177,688, INT. CL. 31.
- WIZARDS OF THE COAST, INC., PAWTUCKET, RI:
3,177,577, INT. CL. 16.
- WIZZARD SOFTWARE CORPORATION, PITTSBURGH, PA:
3,177,061, PUB. 9-12-2006. INT. CL. 9.
- WKL, LLC, ARNOLD, MO:
3,178,118, MULTIPLE CLASS, INT. CLS. 37, 40 AND 42.
- WLADIS, JEREMY S, NEW YORK, NY:
3,175,767, PUB. 9-12-2006. INT. CL. 43.
- WM. BOLTHOUSE FARMS, INC., BAKERSFIELD, CA:
1,949,787, CANC. INT. CL. 29.
- WM. WRIGLEY JR. COMPANY, CHICAGO, IL:
1,378,149, CANC. INT. CL. 24.
- WMS GAMING INC., WAUKEGAN, IL:
3,177,846, INT. CL. 9.
- WOLVERINE OUTDOORS, INC., ROCKFORD, MI, KARHU U.S.A. INC., SOUTH BURLINGTON, VT:
1,987,331, REN. 10-25-06. INT. CL. 25.
- WOLVERINE REALTY, LLC, SANTA ANA, CA:
2,308,990, CANC. INT. CL. 36.
- WOODARD & GREENSTEIN ANTIQUES CORP., NEW YORK, NY:
2,023,979, REN. 10-25-06. INT. CL. 27.
- WOODARD, EMHARDT, MORIARTY, MCNETT, & HENRY LLP, INDIANAPOLIS, IN:
3,177,045, PUB. 9-12-2006. INT. CL. 42.
- WOODHEAD INDUSTRIES, INC., DEERFIELD, IL:
2,308,812, CANC. INT. CL. 20.
- WOODPECKERS, INC., NORTH ROYALTON, OH:
3,176,964, PUB. 9-12-2006. MULTIPLE CLASS, INT. CLS. 8 AND 35.
- WOODS, NANCY ELIZABETH SANDAU, PORT ANGELES, WA:
3,178,051, INT. CL. 25.
- WOODWARD GOVERNOR COMPANY, ROCKFORD, IL:
1,903,403, REN. 10-24-06. INT. CL. 9.
- WORELL, KENNETH, MEMPHIS, TN:
3,178,220, INT. CL. 16.
- WORK WITH KIDS, INC., SAINT PETERSBURG, FL:
3,178,717, INT. CL. 41.
- WORK, PETER, LOMPOC, CA:
3,177,011, PUB. 9-12-2006. INT. CL. 33.
- WORKSTREAM U.S.A., INC., MAITLAND, FL:
3,178,032, INT. CL. 35.
- WORLD FACTORY, INC., COPPELL, TX:
3,178,622, INT. CL. 7.
- WORLD FUTURE SOCIETY, BETHESDA, MD:
3,178,783, INT. CL. 16.
- WORLD LOGISTICS, INC., ROSLYN, NY:
2,309,411, CANC. INT. CL. 3.
- WORLD TEAMTENNIS, INC., CHICAGO, IL:
2,308,836, CANC. INT. CL. 41.
- WORLD WIDE IMPORTS ENTERPRISES, INC., FT. LAUDERDALE, FL:
3,177,520, INT. CL. 1.
- WORLD WRESTLING ENTERTAINMENT, INC., STAMFORD, CT:
3,177,775, INT. CL. 28.
3,177,776, INT. CL. 28.
- WORLDPASS TRAVEL GROUP, LLC, EL DORADO HILLS, CA:
3,176,998, PUB. 9-12-2006. INT. CL. 43.
3,178,457, INT. CL. 39.
- WORLDWIDE APPAREL RESOURCES INC., NEW YORK, NY, N.R.C. INC., NEW YORK, NY:
1,374,870, REN. 10-20-06. INT. CL. 25.
- WORLDWIDE FINANCIAL SERVICES, INC., BIRMINGHAM, MI:
2,310,019, CANC. INT. CL. 36.
- WORLDWIDE PRODUCTS, INC., GLENDORA, CA TO OMP, INC., LONG BEACH, CA:
1,947,836, CANC. INT. CL. 3.
- WORTZ, MARJORIE A., TACOMA, WA:
3,177,078, PUB. 9-12-2006. INT. CL. 16.
- WRAY, DIANA N., SALT LAKE CITY, UT, DBA DIDE-SIGNS:
2,309,902, CANC. INT. CL. 9.
- WRC, LLC, LOS ANGELES, CA:
3,178,251, INT. CL. 9.
- WRIGHT STATE UNIVERSITY, DAYTON, OH:
1,423,344, REN. 10-22-06. INT. CL. 41.
- WT ENERGIESYSTEME GMBH, FED REP GERMANY:
3,177,295, PUB. 9-12-2006. MULTIPLE CLASS, INT. CLS. 5, 7, 11, 32 AND 37.
- WU, JUNG-MING, CHIA YI, TAIWAN:
2,309,426, CANC. INT. CL. 28.

- WUYI SHENGQI MOTION APPARATUS CO., LTD., TONGQIN TOWN, WUYI.; ZHEJIANG 321201, CHINA:
3,177,236, PUB. 9-12-2006. INT. CL. 12.
- WWE LIBRARIES, INC., STAMFORD, CT, MINNEAPOLIS BOXING & WRESTLING CLUB, INC., MINNEAPOLIS, MN, DBA AMERICAN WRESTLING ASSOCIATION:
1,401,633. REN. 10-20-06. INT. CL. 41.
- WYETH, MADISON, NJ:
3,178,113, INT. CL. 5.
- W3 PARTNERS LLC, ROGERS, AR:
3,177,902, INT. CL. 29.
- W3 PARTNERS, LLC, ROGERS, AR:
3,178,559, INT. CL. 30.
- X-DOT, INC., DALLAS, TX:
2,025,368, CANC. INT. CL. 36.
- XACTWARE, INC., OREM, UT:
3,176,463, PUB. 9-12-2006. INT. CL. 42.
- XANTREX INTERNATIONAL, ST. MICHAEL, BARBADOS, HEART INTERFACE CORPORATION, KENT, WA:
1,989,079. REN. 10-22-06. INT. CL. 9.
- XEPTAR CORPORATION, ST. LOUIS, MO:
2,309,684, CANC. INT. CL. 9.
- XERION IMPORT EXPORT, INC., CHULA VISTA, CA:
1,948,209, CANC. INT. CL. 3.
- XEROX CORPORATION, STAMFORD, CT:
1,991,399. REN. 10-26-06. INT. CL. 9.
- XERVIUS NETWORKS LLC, FLUSHING, NY:
3,177,581, INT. CL. 41.
- XM SATELLITE RADIO INC., WASHINGTON, DC:
3,178,614, INT. CL. 41.
- XMP, INC., BATON ROUGE, LA:
2,888,987, CANC. INT. CL. 25.
- XOFT MICROTUBE, INC., FREMONT, CA:
3,177,488, INT. CL. 10.
- XPATRINET, INC., CARLSBAD, CA:
3,175,969, PUB. 9-12-2006. MULTIPLE CLASS, INT. CLS. 35, 38 AND 41.
- XTZ INDUSTRIES, INC., EDMONDS, WA:
2,309,927, CANC. INT. CL. 32.
- XZILLION GMBH & CO. KG, 65926 FRANKFURT AM MAIN, FED REP GERMANY:
3,175,766, PUB. 1-27-2004. INT. CL. 42.
- YAMAHA HATSUDOKI KABUSHIKI KAISHA, SHIZUOKAKEN, JAPAN:
2,010,566. REN. 10-25-06. INT. CL. 12.
- YANG, AARON, BREA, CA:
3,178,458, INT. CL. 20.
- YANGZHOU CHANGJIANG MOTOR CO. LTD., JIANGSU, CHINA:
2,309,580, CANC. INT. CL. 9.
- YANKEE CANDLE COMPANY, INC., THE, SOUTH DEERFIELD, MA:
3,177,980, INT. CL. 3.
- YEOMANS CHICAGO CORPORATION, AURORA, IL:
1,992,640. REN. 10-20-06. INT. CL. 7.
- YESHIVA UNIVERSITY, NEW YORK, NY:
3,178,466, INT. CL. 41.
- YESKE, MOLLY MCGAUGHY, DIAMONDHEAD, MS:
2,308,747, CANC. INT. CL. 36.
- YOKOGAWA ELECTRIC CORPORATION, MUSASHI-NOSHI, TOKYO, JAPAN:
3,176,186, PUB. 9-12-2006. INT. CL. 42.
- YORK PHARMA PLC, HITCHIN, HERTS, UNITED KINGDOM:
3,175,988, PUB. 9-12-2006. INT. CL. 5.
- YOU & ME, INC., SEATTLE, WA:
1,949,036, CANC. INT. CL. 14.
- YOUAKIM, FERIAI, FORT LAUDERDALE, FL:
3,177,114, PUB. 9-12-2006. INT. CL. 3.
- YOUNGER MFG. CO., LOS ANGELES, CA:
2,309,519, CANC. INT. CL. 9.
- YOURSTORE, LLC, LAS VEGAS, NV:
3,177,091, PUB. 9-12-2006. INT. CL. 35.
- YSLETA DEL SUR PUEBLO, EL PASO, TX:
3,175,905, PUB. 9-12-2006. INT. CL. 41.
- YUM YUM DONUT SHOPS, INC., CITY OF INDUSTRY, CA:
1,947,941, CANC. MULTIPLE CLASS, INT. CLS. 30 AND 42.
- YUSHIN MEDICAL, CO., LTD., BUCHEON-SHI, KYUNGGIDO, REPUBLIC OF KOREA:
3,175,841, PUB. 9-12-2006. INT. CL. 10.
- YV MEDIA LLC, NEW YORK, NY, SAMPLER PUBLICATIONS, INC., ST. CHARLES, IL:
2,005,194. REN. 10-26-06. INT. CL. 16.
- YVONNE'S PLASTER CRAFTS, INC., LAKE MARY, FL:
3,176,868, PUB. 9-12-2006. INT. CL. 35.
- YWCA NORTHERN RHODE ISLAND, WOONSOCKET, RI:
3,177,018, PUB. 9-12-2006. INT. CL. 16.
- Z-MAN FISHING PRODUCTS, INC., HANAHAN, SC:
3,178,209, INT. CL. 28.
- ZAMBEZI RESOURCES LTD., MILWAUKEE, WI:
1,378,095, CANC. INT. CL. 17.
1,378,096, CANC. INT. CL. 17.
- ZAP CREATE YOUR OWN CAP, INC., ENGLEWOOD, CO:
2,308,619, CANC. INT. CL. 40.
- ZEAVISION, LLC, ST. LOUIS, MO:
3,178,621, INT. CL. 10.
- ZEBRA CO., LTD, SHINJYUKUKU, TOKYO, JAPAN:
1,407,667. REN. 10-21-06. INT. CL. 16.
- ZED INDUSTRIES, INC., VANDALIA, OH:
1,378,088, CANC. INT. CL. 17.
- ZELIX PTY LTD, AUSTRALIA:
3,177,300, PUB. 9-12-2006. INT. CL. 9.
- ZENCHIKU LAND & LIVESTOCK, INC., DILLON, MT:
2,309,643, CANC. MULTIPLE CLASS, INT. CLS. 29 AND 31.
2,309,644, CANC. MULTIPLE CLASS, INT. CLS. 29 AND 31.
- ZENECA LIMITED, LONDON W1Y 6LN, ENGLAND:
2,308,232, CANC. MULTIPLE CLASS, INT. CLS. 40 AND 42.
- ZF SACHS AG, SCHWEINFURT, FED REP GERMANY:
3,175,940, PUB. 9-12-2006. MULTIPLE CLASS, INT. CLS. 7, 12 AND 17.
- ZHAO, WEI (EDDIE), MONTEREY PARK, CA:
3,176,682, PUB. 9-12-2006. INT. CL. 45.
- ZHEJIANG DONGYUAN JICHE BUJIAN CO., LTD., RUTAN SHI, ZHEJIANGSHENG, CHINA:
3,177,279, PUB. 9-12-2006. INT. CL. 7.
- ZHEJIANG ZHENBEI CO., LTD., CHINA:
3,177,260, PUB. 9-12-2006. INT. CL. 25.
- ZHI GANG SHA, LLC, PETALUMA, CA:
3,177,427, INT. CL. 41.
- ZHONGSHAN FOODSTUFFS & AQUATIC IMP. & EXP. GROUP CO. LTD. OF GUANGDONG, ZHONGSHAN CITY, GUANGDONG PROVINCE, CHINA:
3,176,306, PUB. 9-12-2006. INT. CL. 29.
- ZIEBS, INC., LAUREL, MD:
3,176,867, PUB. 9-12-2006. MULTIPLE CLASS, INT. CLS. 25 AND 35.
- ZILKER LABS, INC., AUSTIN, TX:
3,178,371, INT. CL. 9.
- ZING EAR ENTERPRISE CO., LTD., WU FONG SHIANG, TAICHUNG HSIEN, TAIWAN:
1,425,612. REN. 10-25-06. INT. CL. 9.
- ZIPPMARK, INC., WILMINGTON, DE:
1,047,351. REN. 10-25-06. INT. CL. 34.
- ZIZZLE (HONG KONG) LIMITED, KOWLOON, HONG KONG:
3,178,637, INT. CL. 28.
- ZJ CONCEPTS, INC., ATLANTA, GA:
2,309,610, CANC. INT. CL. 31.
- ZOCALO, SAN FRANCISCO, CA:
3,178,609, INT. CL. 20.
- ZOMBA LATIN RECORDINGS, INC., NEW YORK, NY:
2,308,219, CANC. INT. CL. 9.
- ZOO YORK THC LLC, SOUTH RIVER, NJ:
3,177,609, INT. CL. 25.
- ZOTOS INTERNATIONAL, INC., DARIEN, CT:
1,981,701. REN. 10-23-06. INT. CL. 3.
2,309,912, CANC. INT. CL. 3.
- ZUCKERBERG, JANE, PLAINVIEW, NY:
3,176,803, PUB. 9-12-2006. INT. CL. 25.
- 1A AUTO, INC., PEPPERELL, MA:
3,178,129, INT. CL. 12.

- 1110452 ONTARIO INC., TORONTO, ONTARIO, CANADA:
3,178,083, INT. CL. 25.
- 19 ENTERTAINMENT LIMITED, LONDON, UNITED KINGDOM:
3,175,964, PUB. 9-12-2006. MULTIPLE CLASS, INT. CLS. 3, 6, 9, 14, 16, 18, 20, 21, 24, 25, 28 AND 41.
- 2KNOW, INC., WOODSIDE, CA:
2,309,744, CANC. INT. CL. 35.
2,309,745, CANC. INT. CL. 9.
- 2001 WORLD POLICE AND FIRE GAMES, INC., INDIANAPOLIS, IN:
2,308,323, CANC. MULTIPLE CLASS, INT. CLS. 35 AND 41.
- 24/7 TECHNOLOGIES, MINEOLA, NY:
3,176,909, PUB. 9-12-2006. INT. CL. 42.
- 3B SCIENTIFIC GMBH, HAMBURG, FED REP GERMANY:
3,176,117, PUB. 9-12-2006. INT. CL. 35.
- 3M COMPANY, ST. PAUL, MN, MINNESOTA MINING AND MANUFACTURING COMPANY, SAINT PAUL, MN, AKA 3M:
1,997,394. REN. 10-25-06. INT. CL. 17.
- 3M COMPANY, ST. PAUL, MN:
3,176,638, PUB. 9-12-2006. INT. CL. 16.
- 320, INC., KANSAS CITY, MO:
1,988,572. REN. 10-22-06. INT. CL. 42.
- 3681441 CANADA INC., MONTREAL, QUEBEC H3L 1Z8, CANADA:
3,177,357, MULTIPLE CLASS, INT. CLS. 3, 14 AND 18.
- 4 YOU APPAREL, INC., VERNON, CA:
3,176,981, PUB. 9-12-2006. INT. CL. 25.
- 420820 ONTARIO LIMITED, VAUGHAN, ONTARIO, CANADA:
3,177,409, MULTIPLE CLASS, INT. CLS. 6 AND 19.
- 5.11, INC., MODESTO, CA:
3,177,448, INT. CL. 25.
- 5AM SOLUTIONS, INC., PHOENIX, AZ:
3,176,471, PUB. 9-12-2006. INT. CL. 9.
- 500 HOME RUN CLUB LLC, MARINA DEL RAY, CA:
3,178,740, INT. CL. 9.
- 615 MUSIC LIBRARY, INC., NASHVILLE, TN:
2,309,025, CANC. INT. CL. 9.
- 7-MILE INVESTMENT, INC., LAKE OZARK, MO:
3,178,630, INT. CL. 16.
- 911 NERDS, LLC, MT. PLEASANT, PA:
3,176,670, PUB. 9-12-2006. INT. CL. 42.
- 925 NEVER CORP, WOODLAND HILLS, CA:
3,176,327, PUB. 9-12-2006. INT. CL. 25.
- 99 VIDEO CLUB, INC., MINNEAPOLIS, MN:
1,378,685, CANC. INT. CL. 41.

* * * * *